





WASHING MACHINE SERVICE MANUAL

CAUTION

Before servicing the washer, Read the safety precautions in the manual.

**MODELS : WF-T10(~3)0(~2,6)1(~5)TP(H,E,F)(S,3)
WF-T802/T852(A)/T853A
WF-T(F/C)1091~3, 1191~3T(C/H/P)
WF-T(F/C)1022, 1122, 1001T(C/H/P)
WF-T1268TH, 2409KTb, 2602kTa
WF-T1491TP, T11292TP, T1292TP, T1291TP
WF-T1081TP, T1592TP, T1593TP
WF-T1241TP, T1133TH
WF-G15KTB, G13KTC, B15KTB, B13KTC
WF-T1400TH, T1022TPX**

SAFETY PRECAUTION!

- DISASSEMBLE POWER CORD BEFORE SERVING
- RECONNECT ALL GROUNDING DEVICES

IMPORTANT SAFETY NOTICE !

This service information is intended for individuals possessing adequate backgrounds of electrical, electronic and mechanical experience.

Any attempt to repair this appliance may result in personal injury or property damage.

The manufacturer or seller can not be responsible for the interpretation of this information, nor can it assume any liability in connection with its use.

CONTENTS

1. Specifications	3
2. Installation Instructions.....	4
3. Operating Instructions	
3-1. Identification of Parts.....	10
3-2. Before Starting to Wash	11
3-3. Function of Each Button.....	16
3-4. Washing Programs.....	18
3-5. Other Functions.....	20
3-6. Care and Maintenance.....	25
4. Service Information	
4-1. Schematic Diagram.....	26
4-2. Wiring Diagram	28
4-3. Program Time Chart.....	29
4-4. Adjustment	32
4-5. Disassembly Instruction	33
4-6. Test Running without water.....	36
4-7. Trouble Shooting against Common Washing Problems	37
4-8. Trouble Shooting Methods According to Error Message	38
4-9. How to Diagnose and Repair by Symptom.....	40
5. Exploded View	52
6. Replacement Part List.....	56

1. SPECIFICATIONS

Model	WF-T10(~3)0(~2,6)1(~5)TP(H,E,F)(S,3), WF-T802/T852(A)/T853A WF-T(F/C)1091~3/1191~3T(C/H/P), WF-T(F/C)1022/1122/1001T(C/H/P) WF-T1268TH/2409KTb/ 2602kTa/T1491TP/T1022THX/T1133TH WF-T1081TP/T1491TP/T11292TP/T1292TP/T1291TP/LA-1499ST/T1592TP/T1593TP/T1241TP WF-G15KTB/G13KTC/WF-B15KTB/B13KTC/WF-T1400TH/T1022TPX
Power Source	Refer to rating label on the back of Washer
Input	Refer to rating label on the back of Washer
Capacity	Refer to rating label on the back of Washer
Inner Tub	Stainless
Inlet Water Pressure	0.3kgf/cm ² ~ 8kgf/cm ²
Rating of Fuse	250V, 6A for 220~240V/50Hz 125V, 12A for 100~127V/60Hz
Spin Speed	50Hz : 700 ±50 / 60Hz : 740 ±50
Dim.	Refer to rating label on the back of Washer
Weight	Refer to rating label on the back of Washer
Program	Fuzzy, Economy, Jean, Wool
Water Level	7 Stages
Reservation	Available for 3 ~ 48 Hr
Unbalance Switch	B.P Sensor (S.F Switch)
Lid Interlock Switch	B.P Sensor (S.F Switch)
Child Lock	Applied
Lint Filter	Double
Softener Dispenser	Applied
Detergent Dispenser	Applied
Bleach Inlet	Applied
Auto Power Off	Applied

2. INSTALLATION INSTRUCTIONS

2-1. HOW TO ADJUST LEVEL

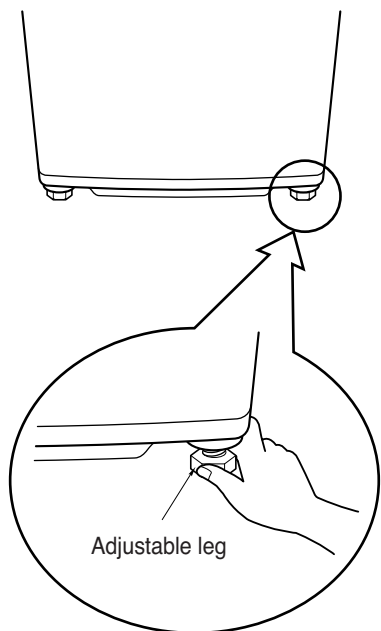

Turn the adjustable legs to set the washer horizontal (2 EA).

1 Installation area

- Install the washer on flat and firm surface.

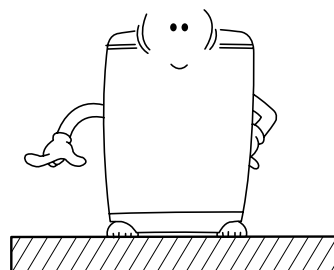

2 Checking level

- Open the lid, and check if the washer is correctly leveled by looking down from the top.

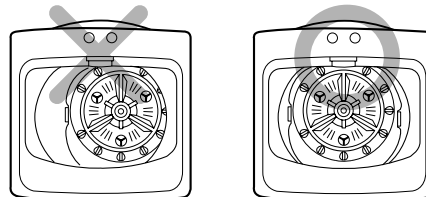

How to use the adjusting plates

- Use the adjusting plates to level the washer when the adjustable legs cannot cover the gap.

Improper installation of the washer may cause noise and malfunctioning.



1. The ventilating openings in the base area must not be obstructed by carpeting when the washing machine is installed on a carpeted floor.
2. Install the washing machine on a level and firm surface, any tilt should be less than 1°.

3 Checking slope

- If installation surface is tilted, the washer will be shaken.

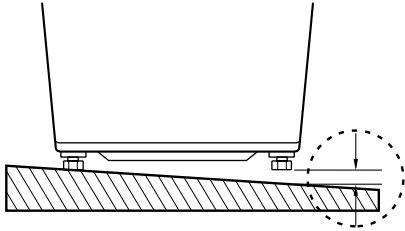

5 Confirming level

- Place the washer to original position and confirm the level.

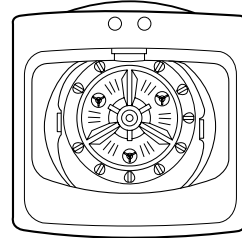

4 Horizontal setting

- Lift up the front of the washer and adjust level by turning the adjustable legs clockwise or using the adjusting plate.

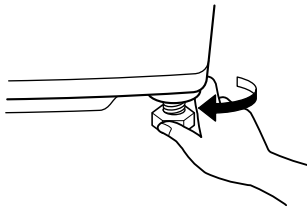

Distance between drain hose and the wall

- Distance between drain hose and the wall should be more than 10 cm, and the distance between the other part and the wall should be more than 2 cm.

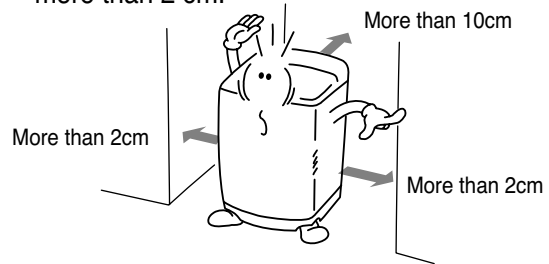

2-2. CONNECTING WATER SUPPLY HOSE

Before connecting Water Supply Hose to water tap, check your hose type and choose correct instruction. Water Supply Hose may vary according to the country.

Make sure connect blue inlet hose to cold water tap, and orange inlet hose to hot water tap.

Connecting Water Supply Hose to water tap

Normal Type (Normal tap without thread & screw type inlet hose.)

1 Untighten the screw

Untighten the screw of the connector so that the tap can be placed in the middle.

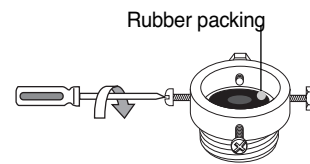

2 Fixing the connector to the tap

Push the upper connector up till the rubber packing is in tight contact with the tap. Then tighten the 4 screws.

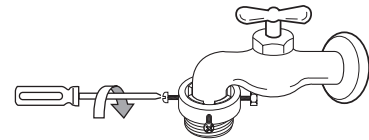

3 Attach the water supply hose to the connector

Push the water supply hose vertically upwards so that the rubber seal within the hose can adhere completely to the tap.

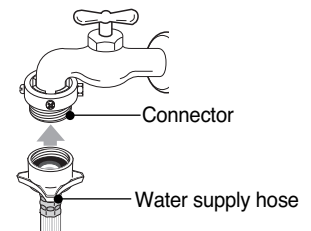

4 Fixing the connector of connector and water supply hose

Attach the water supply hose to the connector and then tighten it by screwing it to the right.

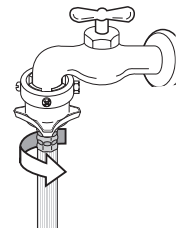

5 Check the connection of water supply hose and the connector

After connecting the hose, open the tap to check for any water leakage. In case of water leakage, close the tap and start again from step 1

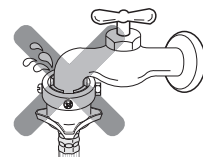

One Touch Type (NORMAL TAB WITHOUT THREAD & ONE TOUCH TYPE INLET HOSE.)

1 Separate Middle connector from Water Supply Hose

Separate Middle connector from the Water Supply Hose by pulling the Pressing Rod and the Pressing Handle that is attached to the Water Supply Hose while pressing them.

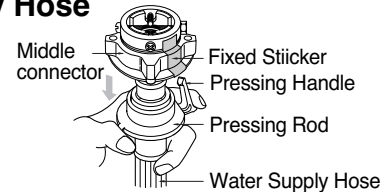

2 Loosen the fixed nuts to connect the connector to the tap

Untighten the screw of the connector so that the tap can be placed in the middle.

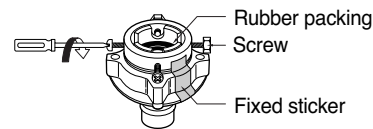

Note

In case the tap is large.

If the tap diameter is too large or is square, open the 4 screw and take out the guide plate and follow step 1.

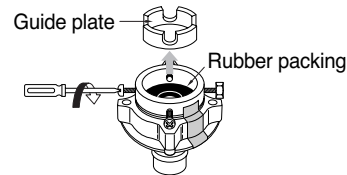

3 Fixing Connectors to the Tap

Push the upper connector up till the rubber packing is in tight contact with the tap. Then tighten the 4 screws.

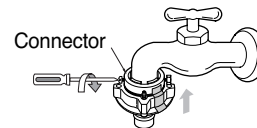

4 Fixing Upper Connector and Middle Connector

Remove the fixed sticker in between the Upper and Middle Connectors. Tighten the connectors by holding one connector and twist middle connector to the right.

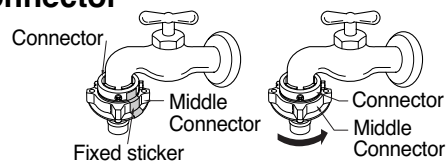

5 Connecting Middle Connector and Water Supply Hose

Press down the pressing rod of the Water Supply Hose which was separated from middle connector (refer to Step1) and then join it to the middle connector.

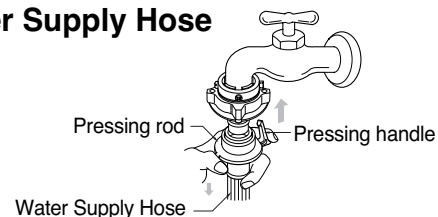

6 Checking the water leakage

After connecting the hose, open the tap to check for any water leakage.

In case of water leakage, close the tap and start again from step 1.

If you skip step1, it may cause water leakage.



Screw Type

1 Attach the water supply hose to the tap.

Push the water supply hose up so that the rubber packing within the hose can adhere completely to the tap.

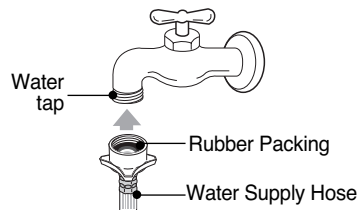

2 Connect the water supply hose to the tap.

Connect the water supply hose to the tap and then tighten it by screwing it to the right.

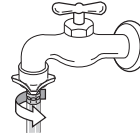

3 Check water leakage.

After connecting the hose, open the faucet to check for any water leakage.

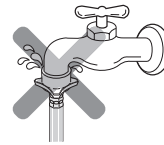

Connecting Water Supply Hose to the machine

Connect the water supply hose to inlet valve of the washing machine, and then lock it by turning the hose connecting part.

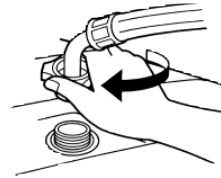

Check to see if there is a rubber seal inside the connector.

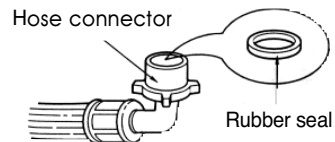

2-3. CONNECT THE DRAIN HOSE

■ For pump model

- Connect the drain hose to the outlet of the drain pump located at the rear of the washing machine.

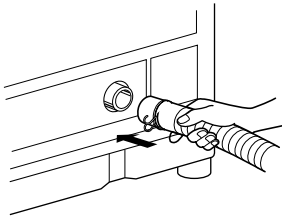

- Attach the clip to the drain hose. And then push it toward the body of the washing machine as indicated by the arrow.

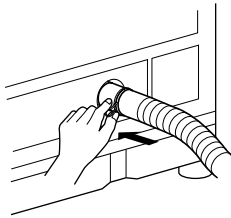

- Check that the drain hose is hung up over the edge of the laundry tub.
- Do not use an extension hose.

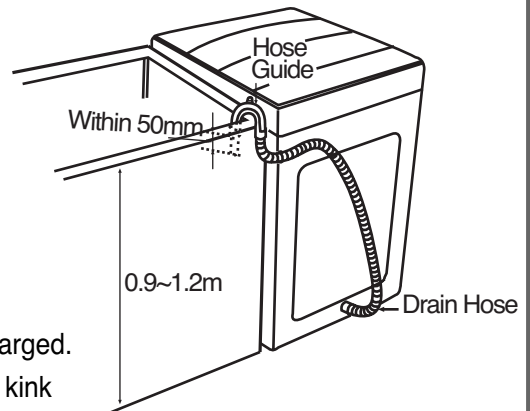

- **NOTE :**
 - Never lay down the drain hose, as water will be discharged.
 - Be sure the drain hose is properly routed so it will not kink or lift from the sink.
 - The discharge height should be approximately 0.9~1.2m from the floor.
 - Connect the drain hose adjusting the length of it not to be dropped. If drain hose is dropped the drainage could be poor because of blockage in the hose.

■ For non - pump model

- Connect the drain hose to the outlet of the drain located at the back side of the washing machine.

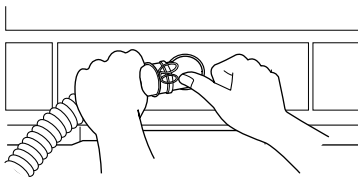

- Fix the drain hose with the clip. And then push it toward the body as in the figure.

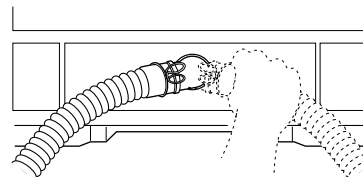

- Keep it downward while the washing machine is working.
- Ensure the hose is free from kinking.



- Do not install the washer where it is directly exposed to sunlight, wind, rain etc.
- Plug the power cord of this washer into a properly installed standard electrical outlet that is switched & earthed.

3. OPERATING INSTRUCTIONS

3-1. IDENTIFICATION OF PARTS

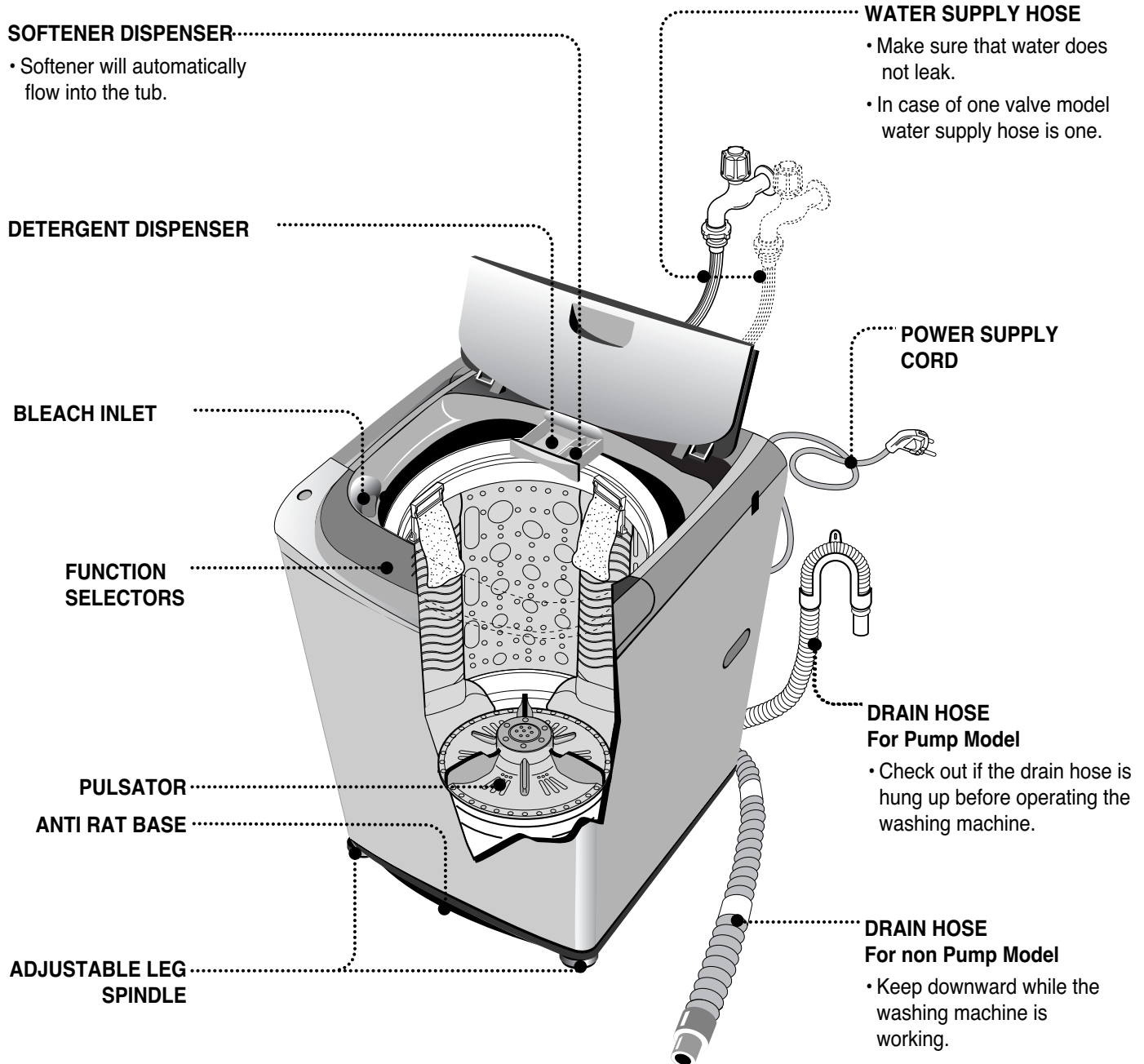

3-2. BEFORE STARTING TO WASH

Care Labels

- * Look for a care label on your clothes. This will tell you about the fabric content of your garment and how it should be washed.
Sort clothes into loads that can be washed with the same wash cycle, water temperature and spin speed.



Sorting

To get the best results, different fabrics need to be washed in different ways.

- **SOIL** (Heavy, Normal, Light) Separate clothes according to the type and amount of soil.
- **COLOR** (Whites, Lights, Darks) Separate white fabrics from colored fabrics.
- **LINT** (Lint producers, Collectors) Separate lint producers and lint collectors.

Lint Producers
Lint Collectors

Terry cloth, Chenille, Towels, Nappies, Diapers
Synthetics, Corduroy, Permanent Press, Socks



Check before Loading

- **Check all pockets to make sure that they are empty.** Things such as nails, hairclips, matches, pens, coins, and keys can damage both your washer and your clothes.
- **Mend any torn garments or loose buttons.** Tears or holes may become larger during washing.
- Remove belts, underwires, etc. to prevent damage to the machine or your clothes.
- **Pretreat any dirt and stains.**
- Make sure the clothes are washable in water.
- Check the washing instructions.
- Remove tissue in pockets.



Pretreatment on stains or heavy soil

- Pretreat shirt collars and cuffs with a pre-wash product or liquid detergent when placing them in the washer. Before washing treat special stains with bar soaps, liquid detergent or a paste of water and granular detergent.
- Use a pretreat soil and stain remover.
Treat stains AS SOON AS POSSIBLE. The longer they are left the harder they are to remove.

Loading

Do not wash fabrics containing flammable materials (waxes, cleaning fluids, etc.).

Load Size

The water level should just cover the clothes. Adjust the load size accordingly. Loosely load clothes no higher than the top row of holes in the washer tub. To add items after washer has started, press Start button and submerge additional items. Close the lid and press Start button again to restart.

Light and Large-sized clothing

Clothes like downs and woollens are light weight, large and float easily.

Use a nylon net and wash them in a small amount of water. If the laundry floats during the wash cycle, it may become damaged. Use dissolved detergent to prevent the detergent from clumping.

Long laundry items

Use nylon nets for long, delicate items. For laundry with long strings or long length, a net will prevent tangling during washing. **Fasten zippers, hook, and strings** to make sure that these items don't snag on other clothes.

※ Nylon net is not supplied by LG.

⚠ WARNING

Fire Hazard

Never place items in the washer that are dampened with gasoline or other flammable fluids.
No washer can completely remove oil. Do not dry anything that has ever had any type of oil on it (including cooking oils). Doing so can result in death, explosion, or fire.

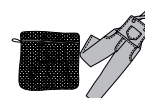

Using Water

Amount of Water Level

- This machine detects the quantity of laundry automatically, then sets the water level and proper amount of detergent.
- When you select a wash program, the water level and amount of detergent (to be used) will be shown on the control panel.
- The following table shows the amount of water.
- When the water level is automatically detected, it may differ depending on the quantity of laundry even though the same water level is indicated on the control panel.
- The amount of a cup in the diagram is about 40g for concentrated detergent.

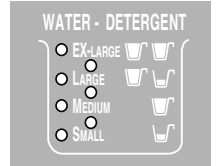

Water temperature

- The machine sets the appropriate temperature automatically according to the wash program .
 - You can change the water temperature by pressing the WATER TEMP button.
 - The temperature of the water impacts the effectiveness of all laundry additives and therefore, the cleaning results. We recommend temperatures of:
 - HOT 49~60°C...(120-140°F) White items, diapers, underclothing and heavily soiled, colorfast items.
 - WARM 29~40°C...(85-105°F) Most items
 - COLD* 18~24°C...(65-75°F) Only very bright colors with light soil.
 - When washing in cold water additional steps may be needed:
 - Adjust detergent amount and pre-dissolve detergent in warm water
 - Pretreat spots and stains
 - Soak heavily soiled items
 - Use appropriate bleach
- * Temperature below 18°C...(65°F) will not activate laundry additives and may cause lint, residue, poor cleaning, etc. In addition, detergent manufactures and care labels define cold water as 26~29°C...(80-85°F). If the temperature of the water in the tub is too cold for your hands, the detergent will not activate and clean effectively.

Attention

If iron is present in the water the clothes may become an all-over yellow or they may be stained with brown or orange spots or streaks. Iron is not always visible. Installation of water softener or an iron filter may be necessary for severe cases.

Using Detergent

Detergent

Follow the detergent package directions. Using too little detergent is a common cause of laundry problems. Use more detergent if you have hard water, large loads, greasy or oily soils or lower water temperature.

Choosing the right detergent

We recommend the use of domestic detergent, (powder, liquid or concentrated). Soap flakes or granulated soap powders should not be used in your washing machine. When washing woolens remember to use detergent suitable for washing woolens.

Using Detergent

How much detergent

When you select a wash program the water level and the amount of detergent (to be used) will be shown on the control panel. The amount of a cup in the diagram is about 40g for concentrated detergent. The correct amount of detergent will vary depending on the amount of soil in your clothes (Jeans and work clothes may need more detergent, while bath towels usually need less.).

For liquid and concentrated detergents, follow the recommendations of the detergent manufacturer.

Note: To check you are using the correct amount of detergent, lift the lid of your machine about half-way through the wash. There should be a thin layer of foam over the surface of the water. Lots of foam may look good, but it does not contribute to cleaning your clothes. No foam means not enough detergent has been used; soil and lint can settle back on the clothes or the washing machine.

If excess detergent is used, the rinse will not be as clean and efficient. Also, it could cause environmental pollution, so use it accordingly.

Adding the detergent

Open the detergent dispenser and deposit the appropriate amount of detergent.

Some detergents **MUST** be fully dissolved before adding to your machine to get the best wash results.

Check the instructions on the detergent packet.

If you use powdered detergent it is essential that the required amount be fully dissolved in very hot water before being added to warm or hot water for the actual wash.

Pre-dissolving detergent in warm water when washing in cold water can improve its performance.

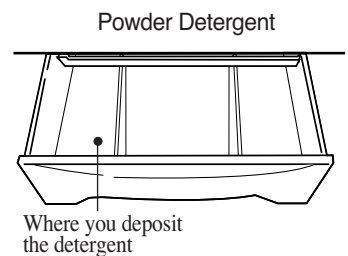

Using Liquid Bleach

- Check clothing care label for special instructions and separate the laundry to be bleached
- Dilute liquid chlorine bleach.
- Measure the recommended amount of liquid bleach carefully following instructions on the bottle.
- Before starting the washer, pour measured amount of bleach directly into bleach dispenser. Avoid splashing or overfilling. Powdered bleach should be mixed with water before pouring.

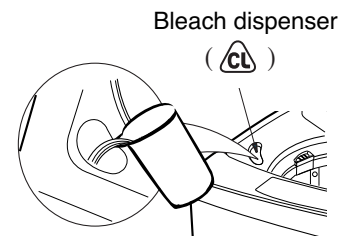

Attention

- Never pour undiluted liquid bleach directly onto clothes or into the wash basket. This may cause change of color or damage the laundry.
- Do not mix chlorine bleach with ammonia or acids such as vinegar and/or rust remover. Mixing can reduce a toxic gas which may cause death.
- Do not pour powdered bleach into bleach dispenser.

Using Fabric Softener

Available Fabric Softener Type

- Do not use concentrated fabric softener. This may cause some problems in automatic dispensing.
- For more details refer to the softener products instructions for use.

Depositing Fabric Softener



- Don't use softener with detergent. Use softener in last rinse water
- When using dispenser, dilute softener (30ml) with fresh water (30ml)
- When filling dispenser, do not splash or overfill. It may stain clothes.
- Never pour fabric softener directly on clothes. It may stain them
- If spotting occurs, wet and rub hand dishwashing liquid (or mild bar soap) and rewash.

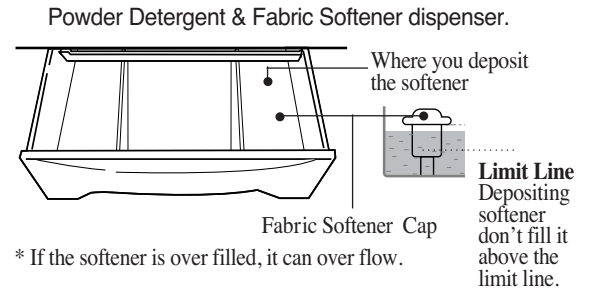

Note

Fabric Softener will be inserted automatically during the final rinse and the machine gives on alarm sound. When water pressure is low, the softener may have to be inserted manually.

Scrud(Waxy Build up)

Scrud is the name given to the waxy build-up that can occur within any washer when the fabric softener comes into contact with detergent. This build-up is not brought about by a fault in the machine.

If scrud is allowed to build-up in the machine it can result in stains on your clothes or an unpleasant smell in your washer.

If you wish to use fabric softener we recommend

- Using fabric softener sparingly.
- When filling the dispenser, do not splash or overfill.
- Clean dispenser as soon as the cycle is finished.
- Clean your machine regularly. (refer to page 25)
- Cold water washing increases the chance of this build-up occurring. We recommend a regular warm or hot wash e.g. every 5th wash should be at least a warm one.
- Fabric softener of thinner consistency is less likely to leave residue on the dispenser and contribute to a build-up.

☞ Special Guide for Stain Removal

⚠ WARNING

- Do not use or mix liquid chlorine bleach with other household chemicals such as toilet cleaners, rust removers, acid or products containing ammonia. These mixtures can produce dangerous fumes which can cause serious injury or death.
- To reduce the risk of fire or serious injury to persons or property, comply with the basic warnings listed below:
 - Read and comply with all instructions on stain removal products.
 - Keep stain removal products in their original labeled containers and out of children's reach.
 - Thoroughly wash any utensil used.
 - Do not combine stain removal products, especially ammonia and chlorine bleach. Dangerous fumes may result.
 - Never wash items which have been previously cleaned in, washed in, soaked in or spotted with gasoline, dry cleaning solvents or other flammable or explosive substances because they give off vapors that could ignite or explode.
 - Never use highly flammable solvents, such as gasoline, inside the home. Vapors can explode on contact with flames or sparks.

For successful stain removal:

- Remove stains promptly.
- Determine the kind of stain, then follow the recommended treatment in the stain removal chart below.
- To pretreat stains, use a prewash product, liquid detergent, or a paste made from granular detergent and water.
- Use cold water on unknown stains because hot water can set stains.
- Check care label instructions for treatments to avoid on specific fabrics.
- Check for colorfastness by testing stain remover on an inside seam.
- Rinse and wash items after stain removal.



Follow fabric care label instructions

Stain Removal	
STAIN	TREATMENT
Adhesive tape, chewing gum, rubber cement	Apply ice. Scrape off excess. Place stain face down on paper towels. Saturate with prewash stain remover or nonflammable dry cleaning fluid.
Baby formula, dairy products, egg	Use product containing enzymes to pretreat or soak stains.
Beverages (coffee, tea, soda, juice, alcoholic beverages)	Pretreat stain. Wash using cold water and bleach safe for fabric.
Blood	Rinse with cold water. Rub with bar soap. Or pretreat or soak with product containing enzymes. Wash using bleach safe for fabric.
Candle wax, crayon	Scrape off surface wax. Place stain face down between paper towels. Press with warm iron until wax is absorbed. Replace paper towels frequently. Treat remaining stain with prewash stain remover or nonflammable dry cleaning fluid. Hand wash to remove solvent. Wash using bleach safe for fabric.
Chocolate	Pretreat or soak in warm water using product containing enzymes. Wash using bleach safe for fabric.
Collar or cuff soil, cosmetics	Pretreat with prewash stain remover or rub with bar soap.
Dye transfer on white fabric	Use packaged color remover. Wash using bleach safe for fabric.
Grass	Pretreat or soak in warm water using product containing enzymes. Wash using bleach safe for fabric.
Grease, oil, tar (butter, fats, salad dressing, cooking oils, car grease, motor oils)	Scrape residue from fabric. Pretreat. Wash using hottest water safe for fabric. For heavy stains and tar, apply nonflammable dry cleaning fluid to back of stain. Replace towels under stain frequently. Rinse thoroughly. Wash using hottest water safe for fabric.
Ink	Some inks may be impossible to remove. Washing may set some inks. Use prewash stain remover, denatured alcohol or nonflammable dry cleaning fluid.
Mildew, scorch	Wash with chlorine bleach if safe for fabric. Or, soak in oxygen bleach and hot water before washing. Badly mildewed fabrics may be permanently damaged.
Mud	Brush off dry mud. Pretreat or soak with product containing enzymes.
Mustard, tomato	Pretreat with prewash stain remover. Wash using bleach safe for fabric.
Nail polish	May be impossible to remove. Place stain face down on paper towels. Apply nail polish remover to back of stain. Repeat, replacing paper towels frequently. Do not use on acetate fabrics.
Paint, varnish	WATER BASED : Rinse fabric in cool water while stain is wet. Wash. Once paint is dry, it cannot be removed, OIL BASED AND VARNISH : Use solvent recommended on can label. Rinse thoroughly before washing.
Rust, brown or yellow discoloration	For spots, use rust remover safe for fabric. For discoloration of an entire load, use phosphate detergent and nonchlorine bleach. Do not use chlorine bleach because it may intensify discoloration.
Shoe polish	LIQUID : Pretreat with a paste of granular detergent and water. PASTE : Scrape residue from fabric. Pretreat with prewash stain remover or nonflammable dry cleaning fluid. Rub detergent into dampened area, Wash using bleach safe for fabric.

3-3. FUNCTION OF EACH BUTTON

- ▶ Changing various functions is possible only in PAUSE state.

Selection button does not work when the washer is in operation (Except for water level, water temp, water power button).

How to use delayed washing

- Use this function for delayed washing.
- Use it to set the delay time.
- By pressing the button, it cycles [3→4→5→...→11→12→14→16→...→46→48→3] hours. (Up to 48 hours can be delayed).
- To cancel delay time, turn the power switch off.

Detergent deposit display

- Upon loading laundry, it displays the correct amount of detergent to be added according to the amount of laundry (based on concentrated detergent).

Wash Process display

- Indicates the current washing status.
- Next step is lit, current step blinks and finished step is turned off.

NOTE

The display panel uses the following abbreviation:
M(minutes), T(Times) and M(minutes).

How to select temp.

- Use it to select hot or cold water (When hot water only is selected, hot water is supplied for washing and cold water are supplied for rinsing).
- In WOOL, HOME DRY program, cold water is selected automatically (Hot water may damage the fabric).

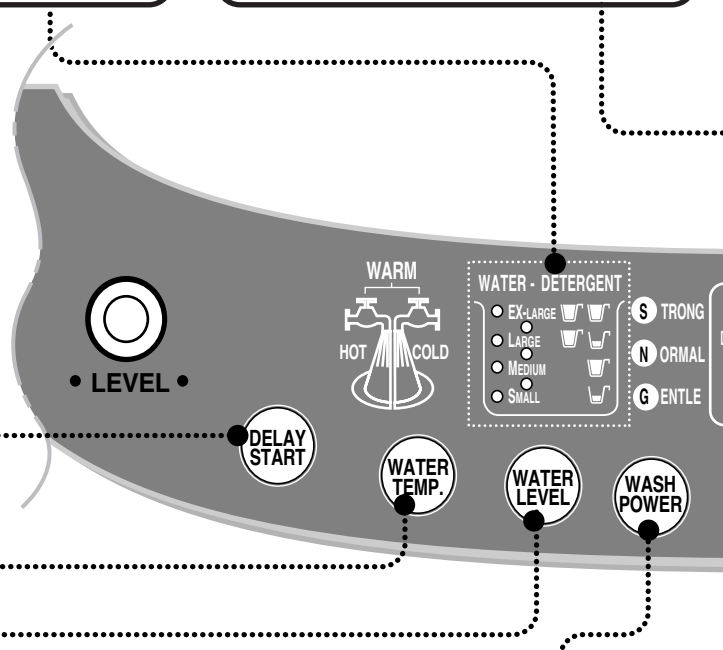

How to adjust the water level

- By pressing the button, it cycles [LARGE→LARGE • EX-LARGE→EX-LARGE →SMALL→SMALL • MEDIUM→MEDIUM →MEDIUM • LARGE→LARGE]
- At FUZZY and JEAN program, water level is selected automatically based on the amount of laundry.
- Water level is set to MEDIUM for SPEEDY program, LARGE for WOOL and DELICATE program, EX-LARGE for BLANKET program.
- Water level can be adjusted even when the washer is in operation.

Wash power

- Use it to adjust the strength of water current.
- By pressing the button, it cycles [S → G → N].
- Strength of the water current can be adjusted at any program. At the beginning, it starts with MED (S).

Displaying abnormal operation

- In case of abnormal operation, the following indications are displayed.

Abnormal water supply : INLET Er. lamp blinks.

Abnormal drainage : DRAIN Er. lamp blinks.

Abnormal spin : SPIN Er. lamp blinks.

Abnormal water level sensing : **PE** displayed.

Abnormal lid open : DOOR Er. lamp blinks.

Abnormal over flooding sensing : **OF** displayed.

For manual wash, rinse and spin

Wash :

Use it to change washing time.

By pressing the button [15min → 18min → 21min → 25min → 40min → 60min → 90min → OFF → 3min → 6min → 9min → 12min → 15min] SOAKING is used to remove old or hardened dirt more effectively.

Soaking time is about 40, 60, 90 minutes (You cannot choose in WOOL, HOME DRY, DELICATE program.).

Rinse :

Use it to change the frequency of rinses.

By pressing the button, [rinse 1 → rinse 2 → rinse 3 → rinse 4 → rinse 5 → off → rinse 1] or

[Spray rinse+Deep 1 → Deep 1 → Spray rinse+Deep 2 → Deep 2 → off → Spray rinse+Deep 1] are repeated.

When you select rinse only, the operation starts with water supply.

NOTE

When rinsing or spinning only, Fuzzy is set to [LARGE] and ECONOMY is set to [MEDIUM] and BLANKET is set to [EX-LARGE] automatically. Adjust the water level as needed.

Spin :

Use it to change the spinning time.

By pressing the button, [6min → 8min → OFF → 1min → 2min → 4min → 6min]

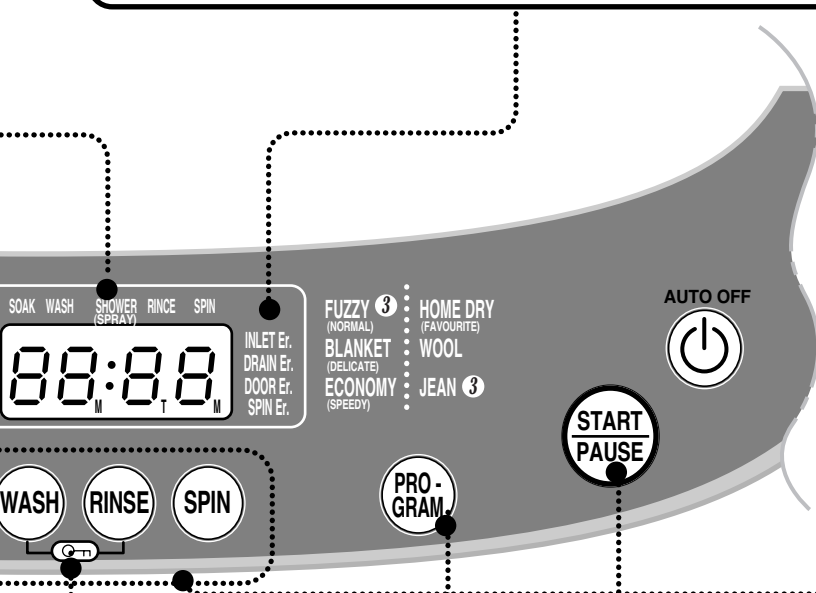

Child lock function

- Use to lock or unlock the control buttons to prevent all the setting being change by a child.
- For locking, push both buttons simultaneously and for unlocking, push them one more in washing process.































How to select a washing program























- Use it to select washing programs.
- By pressing the button, it cycles [FUZZY(NORMAL) → BLANKET(DELICATE) → ECONOMY(SPEEDY) → JEAN → WOOL → HOME DRY(FAVOURITE) → FUZZY(NORMAL)]

Start and temporary pause

- Use it to start or pause temporarily.
- Pressing the button repeats start and temporary pause.
- After 10 minutes in a temporary pause state, the power will automatically turn off.

3-4. WASHING PROGRAMS

Washing Programs		Add the laundry			Add the detergent
<p>Fuzzy Washing (Normal Wash) Used for normal loads, this mode automatically selects the most appropriate conditions and completes the sequence in one operation. The built-in sensor detects the size of the load and the ideal wash power and wash, rinse and spin times are set accordingly</p>					 <p>· Add the appropriate detergent as indicated by the water level next to the DETERGENT. Or follow the detergent manufacturer's instructions.</p>
<p>Blanket Wash Blankets of different size can be easily washed.</p>			 <p>· Select the BLANKET program on the Control panel.</p>		
<p>Delicate Wash Use this program for washing delicate laundry such as lingerie, blouses etc.</p>			 <p>· Select the DELICATE program on the Control panel.</p>		
<p>Economy Wash (Speedy Wash) Use this mode when washing lightly soiled clothes for a short time. The weight should be under 2.0kg.</p>			 <p>· Select the ECONOMY (SPEEDY) program on the Control panel.</p>		
<p>Jean Wash Use jeans program when washing heavy, thick, and extremely dirty laundry such as jeans and work outfits.</p>			 <p>· Select the JEAN program on the Control panel.</p>		
<p>Wool Wash Use this program for washing delicate fabrics such as lingerie and woolsens. (wash only "water washable" clothes) Before washing your woolsens check the care label for the washing instructions. (wash only water washable clothes)</p>			 <p>· Select the WOOL program on the Control panel.</p>		 <p>· Use neutral detergent appropriate for the wool. · When washing wool, use a mild detergent recommended for wool.</p>
<p>Homedry Wash Use this program for clothes that have [HOME WASH and DRY] or [WATER WASH and DRY] tags. For homedry, amount of laundry must be less than 1.2kg at a time.</p>			 <p>· Select the HOMEDRY program on the Control panel.</p>		

		Close the lid	Finish	Caution & Note									
quantity of by the ER- ons	 <ul style="list-style-type: none"> The pulsator rotates for 8 seconds to detect the laundry load. Then the water level and the amount of detergent to be used will be shown and water will be supplied. 	 <ul style="list-style-type: none"> Water will be supplied for 2 minutes after the start of the wash to supplement the water the laundry has absorbed. 	 <ul style="list-style-type: none"> When the wash program ends, the buzzer will ring for 10 seconds before the Power goes off automatically. 	<ul style="list-style-type: none"> If water is already in the tub, or putting wet laundry into the tub before starting will increase the water level. With lightweight bulky loads, water level can be set low. Changes to water temperature (hot/cold) and wash level are possible during operation. 									
				<ul style="list-style-type: none"> Before starting to wash, make sure that the laundry is washable. <table border="1" data-bbox="975 704 1560 953"> <tr> <td data-bbox="975 704 1082 783">Possible Laundry</td> <td data-bbox="1082 704 1251 783">100% chemical fiber with the hand-wash tag</td> <td data-bbox="1251 704 1560 783">Weight : the weight of sheet is under 5.0kg</td> </tr> <tr> <td data-bbox="975 783 1082 900"></td> <td data-bbox="1082 783 1251 900">100% Polyester with the hand-wash tag</td> <td data-bbox="1251 783 1560 900">Blanket Stuffing : Weight about 2kg (total weight of blanket 3.5kg) Size : under approx. 2m(width) × 2.5m(breadth)</td> </tr> <tr> <td data-bbox="975 900 1082 953">Impossible Laundry</td> <td data-bbox="1082 900 1251 953">• electrical blankets</td> <td data-bbox="1251 900 1560 953">• carpets</td> </tr> </table> <ul style="list-style-type: none"> Use a nylon net for washing cashmere blankets to prevent them floating out of the tub. Water may splash out when washing light laundry , such as a cashmere blanket or bed sheet with water set at high level. 	Possible Laundry	100% chemical fiber with the hand-wash tag	Weight : the weight of sheet is under 5.0kg		100% Polyester with the hand-wash tag	Blanket Stuffing : Weight about 2kg (total weight of blanket 3.5kg) Size : under approx. 2m(width) × 2.5m(breadth)	Impossible Laundry	• electrical blankets	• carpets
Possible Laundry	100% chemical fiber with the hand-wash tag	Weight : the weight of sheet is under 5.0kg											
	100% Polyester with the hand-wash tag	Blanket Stuffing : Weight about 2kg (total weight of blanket 3.5kg) Size : under approx. 2m(width) × 2.5m(breadth)											
Impossible Laundry	• electrical blankets	• carpets											
													
													
													
ndry. s use ning				<ul style="list-style-type: none"> When setting the water level manually, do not set to MEDIUM to prevent damage to laundry. Washing with hot water may damage the laundry (Water is set to cold automatically). Ensure that the load is under 2kg In order to avoid damage to laundry, the spin cycle may appear slow. This also avoids wrinkles and clothing may still contain some water. This is normal. Soak Wash cannot be selected for the Wool Wash program. 									
	 <ul style="list-style-type: none"> The water level and the amount of detergent to be used will be shown and water will be supplied. 												

3-5. OTHERS FUNCTIONS

1) Soak Wash

Use this mode for washing excessively dirty laundry by soaking in water for some time to remove proteins and fats. 'SOAK' mode can be used with all washing programs simultaneously except for WOOL and HOME DRY program.

- 1 Press the **AUTO OFF** (Power) button to turn power on.



- 2 Press the **PROGRAM** button to select the washing program.



- The SOAK will not work in WOOL and HOME DRY cleaning Program.

- 3 Press the **WASH** button, to select **SOAK** program.



- Keep pressing the WASH button until the light turns on 'Soak' and 'Wash' simultaneously as next image.
- SOAK program only works when soaking time is 40, 60 or 90 minutes.



- 4 Add the detergent.

- The appropriate quantity of detergent marked next to the water level of WATER-DETERGENT.

- 5 Add the laundry and press the **START/PAUSE** button.



- The water level and the amount of detergent to be used will be shown and water will be supplied.

- 6 Close the lid.

- Water will be supplied for 2 minutes after the start of the wash to supplement the absorbed water by the laundry.

Finish

When the wash program ends, the buzzer will ring for 10seconds before the Power goes off automatically.

Note

- Order of Soak-Wash timing



- Select soaking time 40minutes, 60minutes, or 90minutes (including washing time) by pressing the Wash button repeatedly.
- If necessary, select the times of Rinse and the time for Spinning by pressing the Rinse or Spin buttons till you reach the desired times.

2) Delay Start (Reservation) Wash

Delay start (Reservation) Wash is used to delay the finishing time of the operation. The hours to be delayed can be set by the user accordingly.

The time on the display is the finishing time , not the start time.

- 1 Press the **AUTO OFF** (Power) button to turn power on.



- 2 Press the **PROGRAM** button to select the washing program.



- Select the program for laundry on the Control panel. This method will not work in Wool Program.

- 3 Press the **DELAY START (RESERVATION)** button.



- The light will 'DELAY' turn on and 'TIME LEFT' **3:00** will be marked.
- Press the button repeatedly to set the desired finishing time. For example, To finish washing in 9 hours from now, by make the number 9:00 pressing the **DELAY START (RESERVATION)** button repeatedly.

(RES. = DELAY)



- 4 Add the detergent.

- The appropriate quantity of detergent marked next to the water level of WATER-DETERGENT.
- When the lid is open the machine will not operate, and an alarm signal will remind you to close the lid.

- 5 Add the laundry and press the **START/PAUSE** button.



- When you press the START/PAUSE button the light will blink and the time will be shown.

- 6 Close the lid.

- Water will be supplied for 2 minutes after the start of the wash to supplement the water the laundry has absorbed.

Finish

The washing will be finished according to the delayed time.

Note

- Finishing time can be delayed from 3~48 hours. Delaying from 3~12 hours can be done in 1 hour time intervals and from 12~48 hours in 2 hour time intervals.
- If the lid is open, the machine will not work, and an alarm signal will alarm to remind you to close the lid.
- To select washing time, rinsing times, spinning time, water level, hot/cold or wash power manually, press the DELAY START (RESERVATION) button and select the desired option. Then press the START/PAUSE button.
- When the laundry cannot be taken out immediately after the wash program ends, it is better to omit the spinning program. (The laundry will be wrinkled if left for a long time after spinning.)

3) Option Washing

When you only need the Wash, Wash/Rinse or Rinse cycles, these can be set manually.

- 1 Press the **AUTO OFF** (Power) button to turn power on.



2

Only Wash

Press the **WASH** button to select the desired timing.



Only Wash,Rinse

Press the **WASH** button to select the desired timing.



Press the **RINSE** button to select the desired times of rinse.



You can use this option for preventing wrinkles of laundry

3

Press the **WATER LEVEL** button, to control the water level according to the amount of laundry. If you do not choose anything, it is set the middle water level automatically.



4

Add the laundry into the washing tub.

5

Press the **START/PAUSE** button.







6

Add the detergent and close the lid.

3) Option Washing

- 1 Press the **AUTO OFF** (Power) button to turn power on.



<ol style="list-style-type: none"> 2 Only Rinse Press the RINSE button to select the desired times of rinse.  	<ol style="list-style-type: none"> 2 Only Rinse,Spin Press the RINSE button to select the desired times of rinse.  Press the SPIN button to select the desired times of rinse.  	<ol style="list-style-type: none"> 2 Only Spin/Only drain Press the SPIN button to select the desired times of rinse.  When you want to only drain, wait until the water in the washing tub drains completely.
<ol style="list-style-type: none"> 3 Press the WATER LEVEL button to control the water level according to the amount of laundry.  		

- 4 Add the laundry into the washing tub.

- 5 Press the **START/PAUSE** button.



- 6 Add the detergent and close the lid.

Note

- **When a Wash, Wash/Rinse or Rinse only option** is selected, after the wash is completed the water will not be drained off. If you wish to drain the water, press SPIN button and wait until the water in the tub has drained completely. Then press the **START/PAUSE** button.
- **If you do not specify the water level**, then Medium will be automatically selected.
- If only Rinse is selected, the process will start from Water Supply.

4) Child Lock Function

If you want to lock all the keys to prevent all the setting from being changed by a child, you can use the child lock option.

How to Lock

- 1 Press the **AUTO OFF**(Power) button.



• Turn Power on.

- 2 Press the **START/PAUSE** button to start washing.



• After all washing conditions are set according to the manual.

- 3 Press both the **WASH** button and the **RINSE** button simultaneously.

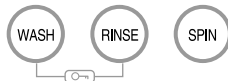

• During the wash program, all the buttons are locked until washing is completed or it is child- lock function is deactivated manually.

How to Unlock

If you want to unlock during wash, press both the **WASH** and the **RINSE** button simultaneously again.

Note

- “ **CL** ” & the remaining time are alternatively shown on the display while they are locked.

Mute Option

If you want to use the washing machine without alarm signal sounds, press both the **WASH** and **SPIN** buttons simultaneously.

To make buzzer work, press both the **WASH** and **SPIN** buttons simultaneously one more time.

Seeing Remaining Time

To see the remaining time for each process, press one of the **WASH**, **RINSE** and **SPIN** buttons. The remaining time for each process will appear for about 1 second.

3-6. CARE AND MAINTENANCE

When there is a fear of freezing

- Close the water taps and remove the Water Supply Hose.
- Remove the water which remains in the water supply.
- Lower the drain hose and drain the water in the bowl and the drain hose by spinning.

If frozen

- Remove the water supply hose, and immerse it in hot water at approx.. 40°C.
- Pour approx.. 2 liters of hot water at approx.. 40°C, into the bowl and let it stand for 10 minutes.
- Connect the water supply hose to the water tap and confirm that the washing machine performs the supply and drainage of water.

Wash Inner-tub	Leave the lid open after washing to allow moisture to evaporate. If you want to clean the inner-tub use a clean soft cloth dampened with liquid detergent, then rinse. (Do not use harsh or gritty cleaners.)
Inlet Hoses	Hoses connecting washer to faucet should be replaced every 5 years.
Exterior	Immediately wipe off any spills. Wipe with damp cloth. Try not to hit surface with sharp objects.
Long Vacations	Be sure water supply is shut off at faucets. Drain all water from hoses if weather will be below freezing.

Cleaning the Inside of your Washer

If you use fabric softener or do regular cold water washing, it is very important that you occasionally clean the inside of your washer.

- Fill your washer with hot water.
- Add about two cups of a powdered detergent that contains phosphate.
- Let it operate for several minutes.
- Stop the washer, open the lid and leave it to soak overnight.
- After soaking, drain the washer and run it through a normal cycle.

We do not recommend that you wash clothes during this procedure.

4. SERVICE INFORMATION

4-1. SCHEMATIC DIAGRAM

1) WF-T10(~3)0(~2,6)1(~5)TP(H,E,F)(S,3) / WF-T802/T852(A)

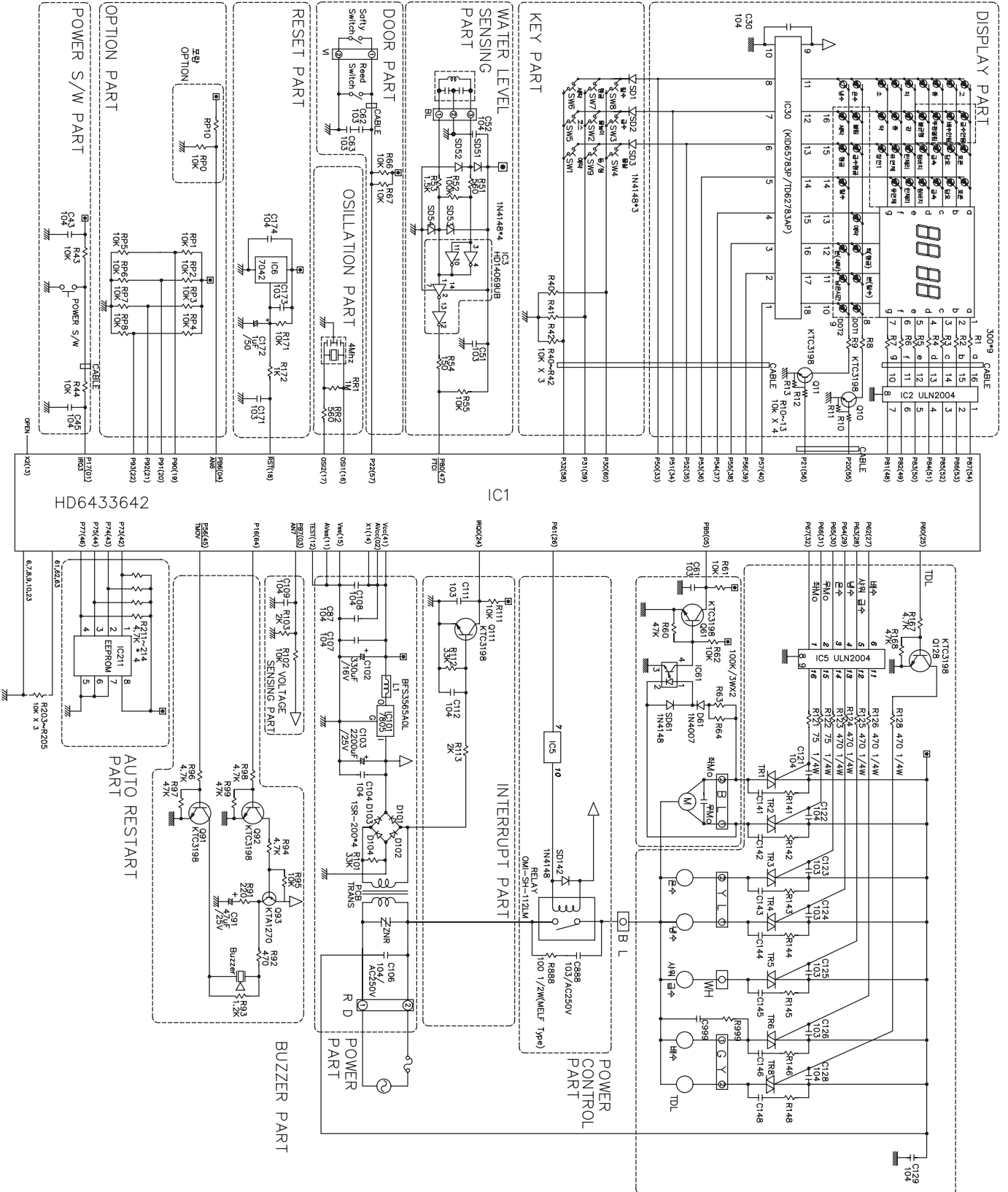

2) WF-T(F/C)1091~3, 1191~3T(C/H/P) / WF-T(F/C)1022,1122,1001T(C/H/P)
 WF-T1268TH, 2409KTb, 2602kTa, T1491TP, WF-T1491TP, T11292TP, T1292TP, T1291TP,
 LA-1499ST, WF-T1081TP, T1592TP, T1593TP, T1241TP, T1133TH
 WF-G15KTb, G13KTC, B15KTb, B13KTC / WF-T1400TH, T1022TPX

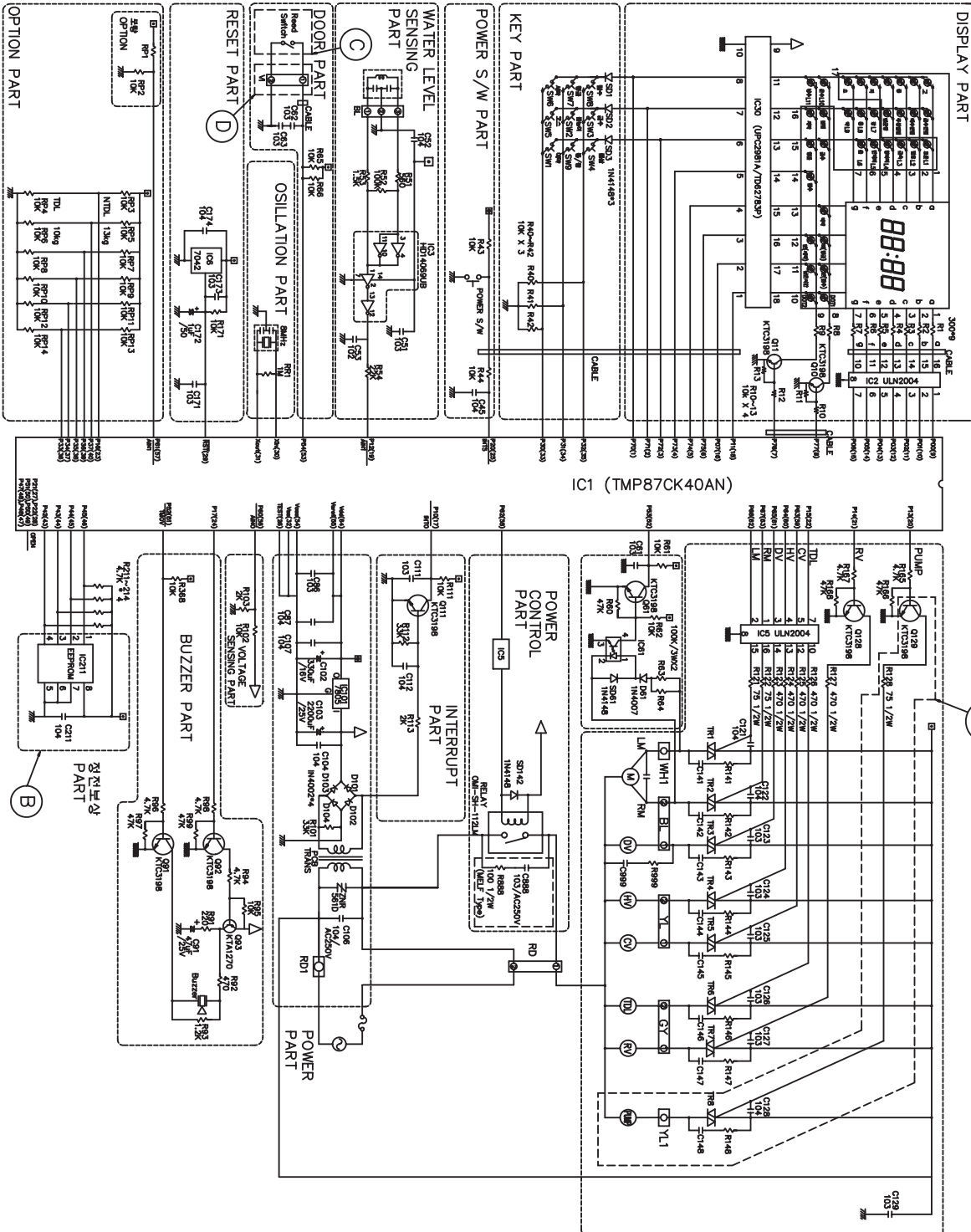

4-2. WIRING DIAGRAM

1) WF-T10(~3)0(~2,6)1(~5)TP(H,E,F)(S,3) / WF-T802/T852(A)/T853A

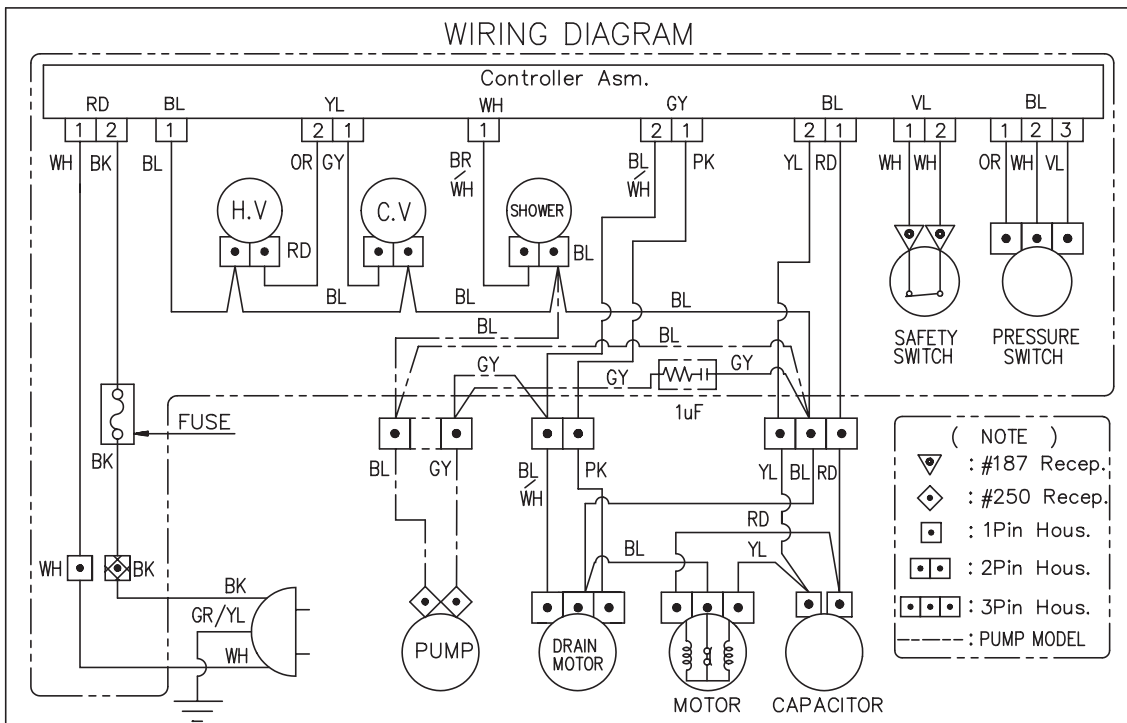

2) WF-T(F/C)1091~3, 1191~3T(C/H/P) / WF-T(F/C)1022,1122,1001T(C/H/P) WF-T1268TH, 2409KTb, 2602kTa, T1491TP, T1081TP, WF-T1491TP, T11292TP, T1292TP,T1291TP, LA1499ST, T1592TP, T1593TP, T1241TP, T1133TH WF-G15KTB, G13KTC, B15KTB, B13KTC / WF-T1400TH, T1022PX

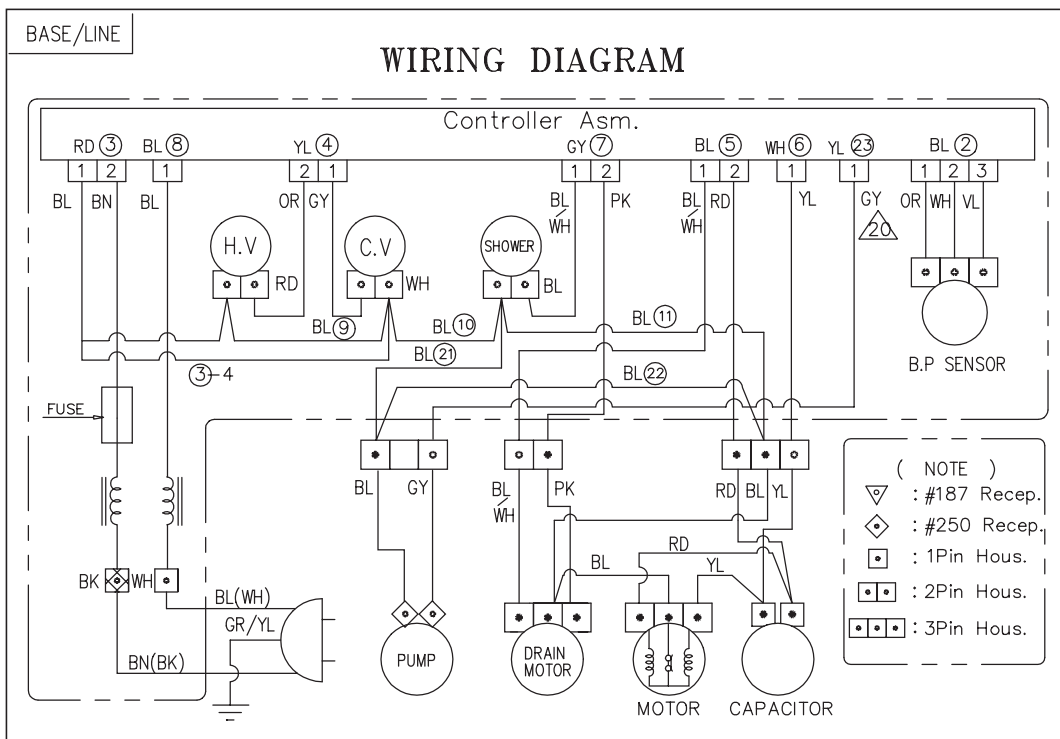

4-3. PROGRAM TIME CHART

1) WF-T10(~3)0(~2,6)1(~5) Series Program chart

		Wash		1st Deep Rinse					2nd Deep Rinse					Spin						
		Water Supply	Washing	Drain	Intermittent Spin	High Speed Spin	No Power Spin	Water Supply	Rinsing	Drain	Intermittent Spin	High Speed Spin	No Power Spin	Water Supply	Rinsing	Drain	Intermittent Spin	High Speed Spin	No Power Spin	Power Off
Fuzzy	Ex-large	7	15	4	130"	90"	165"	7	3	4	130"	90"	165"	7	3	4	130"	8	165"	10"
	ExL-L	6	15	4	130"	90"	140"	6	3	4	130"	90"	140"	6	3	4	130"	8	140"	10"
	Large	6	15	4	100"	90"	140"	6	3	4	100"	90"	140"	6	3	4	100"	6	140"	10"
	L-M	5	12	3	100"	90"	120"	5	3	3	100"	90"	120"	5	3	3	100"	6	120"	10"
	Medium	5	12	3	100"	90"	120"	5	3	3	100"	90"	120"	5	3	3	100"	6	120"	10"
	M-S	4	9	3	55"	90"	100"	4	3	3	55"	90"	100"	4	3	3	55"	4	100"	10"
	Small	3	9	3	55"	90"	100"	3	3	3	55"	90"	100"	3	3	3	55"	4	100"	10"
Economy	Ex-large	7	9	-	-	-	-	-	-	4	130"	90"	165"	7	3	4	130"	4	165"	10"
	ExL-L	6	9	-	-	-	-	-	-	4	130"	90"	140"	6	3	4	130"	4	140"	10"
	Large	6	9	-	-	-	-	-	-	4	100"	90"	140"	6	3	4	100"	4	140"	10"
	L-M	5	9	-	-	-	-	-	-	3	100"	90"	120"	5	3	3	100"	4	120"	10"
	Medium	5	9	-	-	-	-	-	-	3	100"	90"	120"	5	3	3	100"	4	120"	10"
	M-S	4	9	-	-	-	-	-	-	3	55"	90"	100"	4	3	3	55"	4	100"	10"
	Small	3	9	-	-	-	-	-	-	3	55"	90"	100"	3	3	3	55"	4	100"	10"
Blanket	Ex-large	7	18	4	130"	90"	165"	7	3	4	130"	90"	165"	7	3	4	130"	8	165"	10"
	ExL-L	6	18	4	130"	90"	140"	6	3	4	130"	90"	140"	6	3	4	130"	8	140"	10"
	Large	6	18	4	100"	90"	140"	6	3	4	100"	90"	140"	6	3	4	100"	8	140"	10"
	L-M	5	18	3	100"	90"	120"	5	3	3	100"	90"	120"	5	3	3	100"	8	120"	10"
	Medium	5	18	3	100"	90"	120"	5	3	3	100"	90"	120"	5	3	3	100"	8	120"	10"
	M-S	4	18	3	55"	90"	100"	4	3	3	55"	90"	100"	4	3	3	55"	8	100"	10"
	Small	3	18	3	55"	90"	100"	3	3	3	55"	90"	100"	3	3	3	55"	8	100"	10"
Jean	Ex-large	7	15	4	130"	90"	165"	7	3	4	130"	90"	165"	7	3	4	130"	8	165"	10"
	ExL-L	6	15	4	130"	90"	140"	6	3	4	130"	90"	140"	6	3	4	130"	8	140"	10"
	Large	6	15	4	100"	90"	140"	6	3	4	100"	90"	140"	6	3	4	100"	6	140"	10"
	L-M	5	15	3	100"	90"	120"	5	3	3	100"	90"	120"	5	3	3	100"	6	120"	10"
	Medium	5	15	3	100"	90"	120"	5	3	3	100"	90"	120"	5	3	3	100"	6	120"	10"
	M-S	4	15	3	55"	90"	100"	4	3	3	55"	90"	100"	4	3	3	55"	4	100"	10"
	Small	3	15	3	55"	90"	100"	3	3	3	55"	90"	100"	3	3	3	55"	4	100"	10"
Wool	Ex-large	7	3	4	130"	-	100"	7	3	4	130"	-	100"	7	3	4	130"	-	100"	10"
	ExL-L	6	3	4	130"	-	100"	6	3	4	130"	-	100"	6	3	4	130"	-	100"	10"
	Large	6	3	4	100"	-	100"	6	3	4	100"	-	100"	6	3	4	100"	-	100"	10"
	L-M	5	3	3	100"	-	100"	5	3	3	100"	-	100"	5	3	3	100"	-	100"	10"
	Medium	5	3	3	100"	-	100"	5	3	3	100"	-	100"	5	3	3	100"	-	100"	10"
	M-S	4	3	3	55"	-	100"	4	3	3	55"	-	100"	4	3	3	55"	-	100"	10"
	Small	3	3	3	55"	-	100"	3	3	3	55"	-	100"	3	3	3	55"	-	100"	10"
Home Dry	Ex-large	7	6	4	130"	-	100"	7	3	4	130"	-	100"	7	3	4	130"	-	100"	10"
	ExL-L	6	6	4	130"	-	100"	6	3	4	130"	-	100"	6	3	4	130"	-	100"	10"
	Large	6	6	4	100"	-	100"	6	3	4	100"	-	100"	6	3	4	100"	-	100"	10"
	L-M	5	6	3	100"	-	100"	5	3	3	100"	-	100"	5	3	3	100"	-	100"	10"
	Medium	5	6	3	100"	-	100"	5	3	3	100"	-	100"	5	3	3	100"	-	100"	10"
	M-S	4	6	3	55"	-	100"	4	3	3	55"	-	100"	4	3	3	55"	-	100"	10"
	Small	3	6	3	55"	-	100"	3	3	3	55"	-	100"	3	3	3	55"	-	100"	10"

WASH OPTION

Wash Time	3,6,9,12,15,18,21,25min
Rinse Times	1,2,3,4,5Times
Spin Time	1,2,4,6,8min

* No Power Spin : Spin by remained power

* Time Unit is minute in the chart (34" : 34 second)

* Total time for full process can be changeable depending on the water pressure.

2) WF-T852(A) Program chart

	Wash		1st Deep Rinse										2nd Deep Rinse						Spin				
	Water Supply	Washing	Drain	Intermittent Spin	No Power Spin	Rotate Shower	Drain	Intermittent Spin	High Speed Spin	No Power Spin	Water Supply	Rinsing	Drain	Intermittent Spin	High Speed Spin	No Power Spin	Water Supply	Rinsing	Drain	Intermittent Spin	High Speed Spin	No Power Spin	Power Off
Normal	7	21	4	128"	2	1.5	4	128"	20"	2	7	3	4	225"	2	2	7	3	4	225"	6	2.5	10"
	6	21	4	128"	2	1.5	4	128"	20"	2	6	3	4	225"	2	2	6	3	4	225"	6	2	10"
	6	15	4	128"	2	1	4	128"	20"	2	6	3	4	225"	2	2	6	3	4	225"	4	2	10"
	5	15	3	128"	1.5	1	3	128"	20"	1.5	5	3	3	225"	2	1.5	5	3	3	225"	4	2	10"
	5	15	3	128"	1.5	4.5	3	128"	20"	1.5	5	3	3	225"	2	1.5	5	3	3	225"	4	1.5	10"
	4	9	3	128"	1.5	4.5	3	128"	20"	1.5	4	3	3	225"	2	1.5	4	3	3	225"	2	1.5	10"
	3	9	3	128"	1.5	4.5	3	128"	20"	1.5	3	3	3	225"	2	1.5	3	3	3	225"	2	1.5	10"
Speedy	7	6	-	-	-	-	-	-	-	-	-	-	4	225"	20"	2	7	3	4	225"	2	2	10"
	6	6	-	-	-	-	-	-	-	-	-	-	4	225"	20"	2	6	3	4	225"	2	2	10"
	6	6	-	-	-	-	-	-	-	-	-	-	4	225"	20"	2	6	3	4	225"	2	2	10"
	5	6	-	-	-	-	-	-	-	-	-	-	3	225"	20"	2	5	3	3	225"	2	2	10"
	5	6	-	-	-	-	-	-	-	-	-	-	3	225"	20"	2	5	3	3	225"	2	2	10"
	4	6	-	-	-	-	-	-	-	-	-	-	3	225"	20"	2	4	3	3	225"	2	2	10"
	3	6	-	-	-	-	-	-	-	-	-	-	3	225"	20"	2	3	3	3	225"	2	2	10"
Jean	7	21	4	225"	-	-	-	-	2	2	7	3	4	225"	2	2	7	3	4	225"	6	2.5	10"
	6	21	4	225"	-	-	-	-	2	2	6	3	4	225"	2	2	6	3	4	225"	6	2	10"
	6	15	4	225"	-	-	-	-	2	2	6	3	4	225"	2	2	6	3	4	225"	4	2	10"
	5	15	3	225"	-	-	-	-	2	1.5	5	3	3	225"	2	1.5	5	3	3	225"	4	2	10"
	5	15	3	225"	-	-	-	-	2	1.5	5	3	3	225"	2	1.5	5	3	3	225"	4	1.5	10"
	4	9	3	225"	-	-	-	-	2	1.5	4	3	3	225"	2	1.5	4	3	3	225"	2	1.5	10"
	3	9	3	225"	-	-	-	-	2	1.5	3	3	3	225"	2	1.5	3	3	3	225"	2	1.5	10"
Wool	7	3	4	225"	-	-	-	-	-	2	7	3	4	225"	-	2	7	3	4	225"	-	2	10"
	6	3	4	225"	-	-	-	-	-	2	6	3	4	225"	-	2	6	3	4	225"	-	2	10"
	6	3	4	225"	-	-	-	-	-	2	6	3	4	225"	-	2	6	3	4	225"	-	2	10"
	5	3	3	225"	-	-	-	-	-	2	5	3	3	225"	-	2	5	3	3	225"	-	2	10"
	5	3	3	225"	-	-	-	-	-	2	5	3	3	225"	-	2	5	3	3	225"	-	2	10"
	4	3	3	225"	-	-	-	-	-	2	4	3	3	225"	-	2	4	3	3	225"	-	2	10"
	3	3	3	225"	-	-	-	-	-	2	3	3	3	225"	-	2	3	3	3	225"	-	2	10"
Delicate	7	6	4	225"	-	-	-	-	-	2	7	3	4	225"	-	2	7	3	4	225"	-	2	10"
	6	6	4	225"	-	-	-	-	-	2	6	3	4	225"	-	2	6	3	4	225"	-	2	10"
	6	6	4	225"	-	-	-	-	-	2	6	3	4	225"	-	2	6	3	4	225"	-	2	10"
	5	6	3	225"	-	-	-	-	-	2	5	3	3	225"	-	2	5	3	3	225"	-	2	10"
	5	6	3	225"	-	-	-	-	-	2	5	3	3	225"	-	2	5	3	3	225"	-	2	10"
	4	6	3	225"	-	-	-	-	-	2	4	3	3	225"	-	2	4	3	3	225"	-	2	10"
	3	6	3	225"	-	-	-	-	-	2	3	3	3	225"	-	2	3	3	3	225"	-	2	10"

WASH OPTION

Wash Time	3,6,9,12,15,18,21,25min
Spin Time	1,2,4,6,8min

- * No Power Spin : Spin by remained power
- * Time Unit is minute in the chart (34" : 34 second)
- * Total time for full process can be changeable depending on the water pressure.

**3) WF-T(F/C)1091~3, 1191~3T(C/H/P) / WF-T(F/C)1022,1122,1001T(C/H/P)
 WF-T1268TH, 2409KTb, 2602kTa, T1491TP, T1081TP, LA-1499ST
 WF-T1491TP, T11292TP, T1292TP, T1291TP, T853A, T1592TP, T1593TP, T1241TP, T1133TH
 WF-G15KTB, G13KTC, B15KTB, B13KTC / WF-T1400TH, T1022TPX**

	Wash		1st Deep Rinse							2nd Deep Rinse							Spin							
	Water Supply	Washing	Drain	Intermittent Spin	No Power Spin	Rotate Shower	Drain	Intermittent Spin	High Speed Spin	No Power Spin	Water Supply	Rinsing	Drain	Intermittent Spin	High Speed Spin	No Power Spin	Intermittent Spin	High Speed Spin	No Power Spin	Power Off				
Normal	Extreme-Large	7	15	4	135"	2	30"	4	128"	20"	2	7	3	4	194"	2	2	7	3	4	194"	5	2	10"
	Ex-large	7	18	4	135"	2	30"	4	128"	20"	2	7	3	4	194"	2	2	7	3	4	194"	5	2.5	10"
	Ex-L	6	18	4	135"	2	30"	4	128"	20"	2	6	3	4	194"	2	2	6	3	4	194"	5	2	10"
	Large	6	18	4	135"	2	30"	4	128"	20"	2	6	3	4	194"	2	2	6	3	4	194"	5	2	10"
	L-M	5	18	3	135"	1.5	30"	3	128"	20"	1.5	5	3	3	194"	2	1.5	5	3	3	194"	5	2	10"
	Medium	5	15	3	135"	1.5	30"	3	128"	20"	1.5	5	3	3	194"	2	1.5	5	3	3	194"	5	1.5	10"
	M-S	4	10	3	135"	1.5	30"	3	128"	20"	1.5	4	3	3	194"	2	1.5	4	3	3	194"	3	1.5	10"
Small	3	5	3	135"	1.5	30"	3	128"	20"	1.5	3	3	3	194"	2	1.5	3	3	3	194"	3	1.5	10"	
Speedy	Extreme-Large	7	6	-	-	-	-	-	-	-	-	-	-	4	194"	2	2	7	3	4	194"	5	2	10"
	Ex-large	7	6	-	-	-	-	-	-	-	-	-	-	4	194"	20"	2	7	3	4	194"	3	2	10"
	Ex-L	6	6	-	-	-	-	-	-	-	-	-	-	4	194"	20"	2	6	3	4	194"	3	2	10"
	Large	6	6	-	-	-	-	-	-	-	-	-	-	4	194"	20"	2	6	3	4	194"	3	2	10"
	L-M	5	6	-	-	-	-	-	-	-	-	-	-	3	194"	20"	2	5	3	3	194"	3	2	10"
	Medium	5	6	-	-	-	-	-	-	-	-	-	-	3	194"	20"	2	5	3	3	194"	3	2	10"
	M-S	4	6	-	-	-	-	-	-	-	-	-	-	3	194"	20"	2	4	3	3	194"	3	2	10"
Small	3	6	-	-	-	-	-	-	-	-	-	-	3	194"	20"	2	3	3	3	194"	3	2	10"	
Jean	Extreme-Large	7	15	4	135"	-	-	-	-	20"	2	7	3	4	194"	2	2	7	3	4	194"	5	2	10"
	Ex-large	7	18	4	194"	-	-	-	-	2	2	7	3	4	194"	2	2	7	3	4	194"	5	2.5	10"
	Ex-L	6	18	4	194"	-	-	-	-	2	2	6	3	4	194"	2	2	6	3	4	194"	5	2	10"
	Large	6	18	4	194"	-	-	-	-	2	2	6	3	4	194"	2	2	6	3	4	194"	5	2	10"
	L-M	5	18	3	194"	-	-	-	-	2	1.5	5	3	3	194"	2	1.5	5	3	3	194"	5	2	10"
	Medium	5	15	3	194"	-	-	-	-	2	1.5	5	3	3	194"	2	1.5	5	3	3	194"	5	1.5	10"
	M-S	4	10	3	194"	-	-	-	-	2	1.5	4	3	3	194"	2	1.5	4	3	3	194"	3	1.5	10"
Small	3	5	3	194"	-	-	-	-	2	1.5	3	3	3	194"	2	1.5	3	3	3	194"	3	1.5	10"	
Wool	Extreme-Large	7	5	4	135"	-	-	-	-	-	2	7	3	4	194"	2	2	7	3	4	194"	5	2	10"
	Ex-large	7	5	4	194"	-	-	-	-	-	2	7	3	4	194"	-	2	7	3	4	194"	-	2	10"
	Ex-L	6	5	4	194"	-	-	-	-	-	2	6	3	4	194"	-	2	6	3	4	194"	-	2	10"
	Large	6	5	4	194"	-	-	-	-	-	2	6	3	4	194"	-	2	6	3	4	194"	-	2	10"
	L-M	5	5	3	194"	-	-	-	-	-	2	5	3	3	194"	-	2	5	3	3	194"	-	2	10"
	Medium	5	5	3	194"	-	-	-	-	-	2	5	3	3	194"	-	2	5	3	3	194"	-	2	10"
	M-S	4	5	3	194"	-	-	-	-	-	2	4	3	3	194"	-	2	4	3	3	194"	-	2	10"
Small	3	5	3	194"	-	-	-	-	-	2	3	3	3	194"	-	2	3	3	3	194"	-	2	10"	
Delicate	Extreme-Large	7	10	4	135"	-	-	-	-	-	2	7	3	4	194"	2	2	7	3	4	194"	5	2	10"
	Ex-large	7	10	4	194"	-	-	-	-	-	2	7	3	4	194"	-	2	7	3	4	194"	-	2	10"
	Ex-L	6	10	4	194"	-	-	-	-	-	2	6	3	4	194"	-	2	6	3	4	194"	-	2	10"
	Large	6	10	4	194"	-	-	-	-	-	2	6	3	4	194"	-	2	6	3	4	194"	-	2	10"
	L-M	5	10	3	194"	-	-	-	-	-	2	5	3	3	194"	-	2	5	3	3	194"	-	2	10"
	Medium	5	10	3	194"	-	-	-	-	-	2	5	3	3	194"	-	2	5	3	3	194"	-	2	10"
	M-S	4	10	3	194"	-	-	-	-	-	2	4	3	3	194"	-	2	4	3	3	194"	-	2	10"
Small	3	10	3	194"	-	-	-	-	-	2	3	3	3	194"	-	2	3	3	3	194"	-	2	10"	

* No Power Spin : Spin by remained power

* Time Unit is minute in the chart (34" : 34 second)

* Total time for full process can be changeable depending on the water pressure.

4-4. ADJUSTMENT

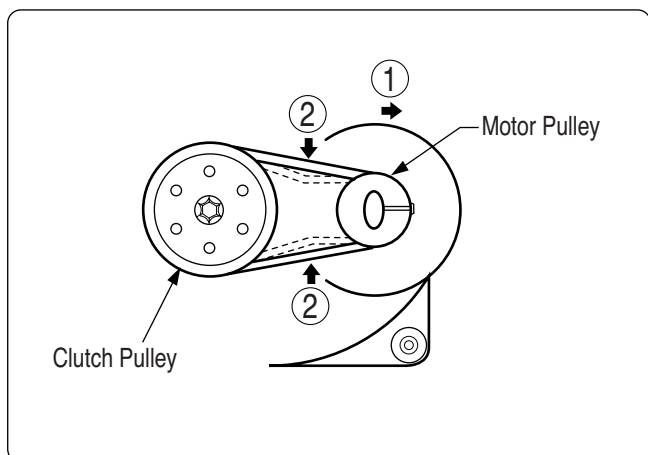
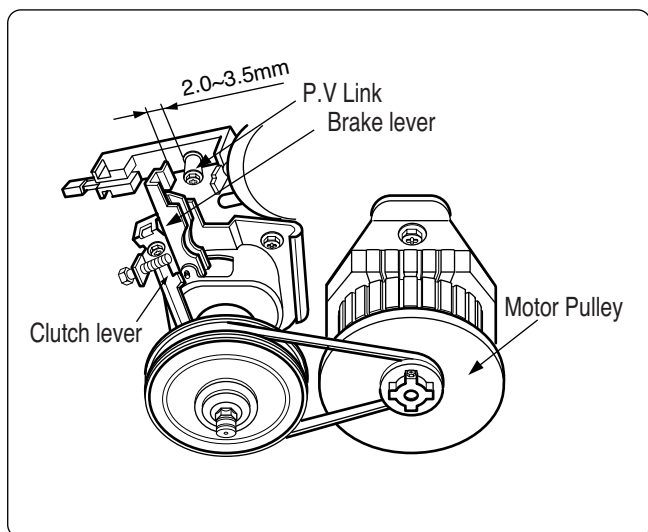
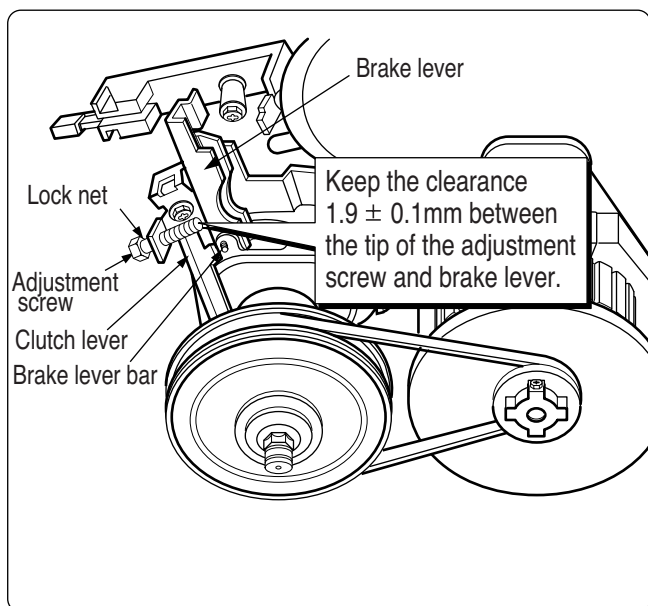

1) BRAKE LEVER ADJUSTMENT

- Shown as in the figure, untighten the adjustment screw to keep clearance less than 1.9 ± 0.1 mm between the tip and the brake lever. And turn on the lock nut then paint it red.

CAUTION

- Painting part is adjusted in factory, it does not need adjusting.
- Adjust the screw properly if the brake doesn't work during spin.

2) KEEPING CLEARANCE

- Keep the clearance about $2.0 \sim 3.5$ mm between brake lever and P.V link as shown in the figure.

CAUTION

- Clutch pulley must be turning to one side P.V Link is pulling the brake Lever.
- Clutch pulley must be turning to the left and the right when P.V Linke does not pull the brake Lever.

3) V-BELT ADJUSTMENT

- Adjust the motor pulley by pushing the motor like arrow ①, to make V-belt tension parallel when pushed at the point of arrow ②.

CAUTION

- When the V-belt is not properly adjusted, the motor will not be running or the belt will be slipping.

4-5. DISASSEMBLY INSTRUCTION

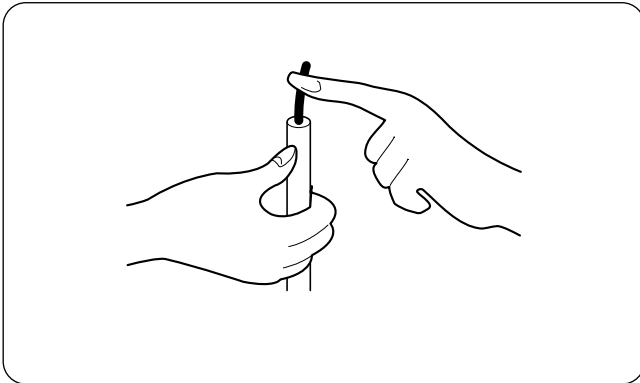

- Be sure to unplug the power to repair and replace electric parts.

CAUTION FOR ELECTROSTATICS

Be sure to make earth connection for trouble diagnosis and parts replacement. If impossible, touch earth wire on the body to remove electric deviation between the body and product before work.

1) Disassembly of Front Panel & PCB Assembly

- ① Remove two screw caps using a sharp tool and two special screws.
- ② Push the front panel to the left side then pull it out
- ③ Disconnect the leads from the controller
- ④ Remove 4 screw from the front panel
- ⑤ Remove the PCB Assembly.

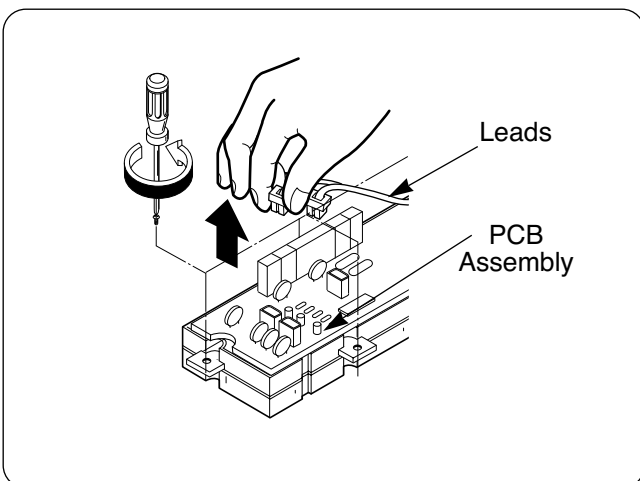
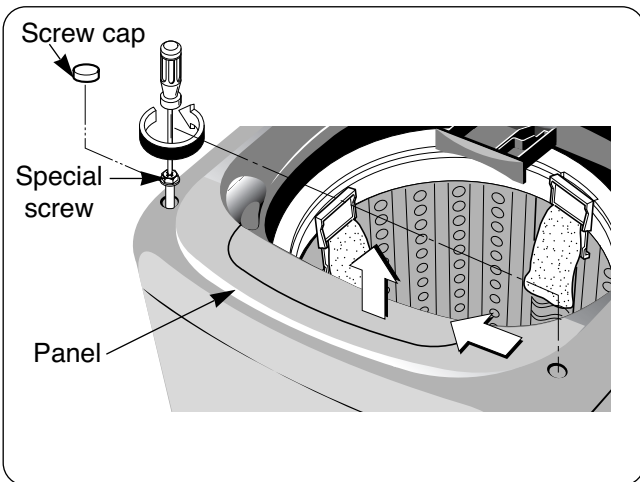

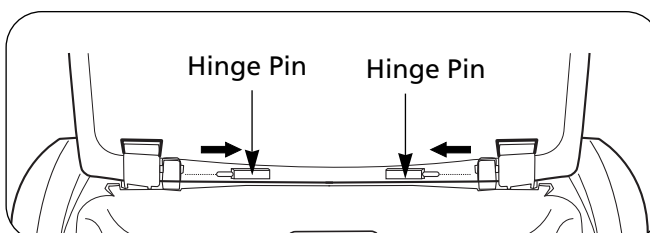
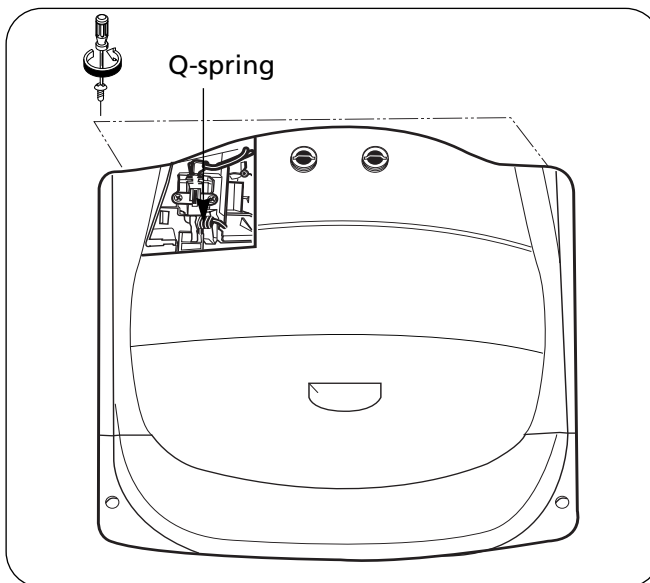
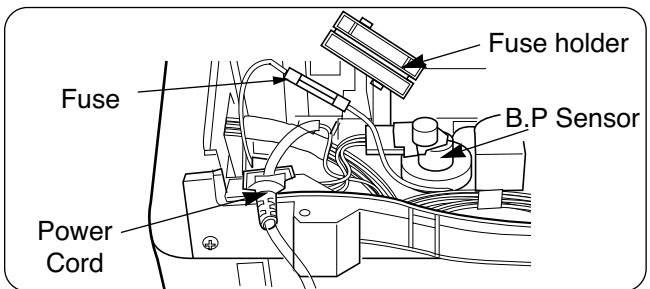
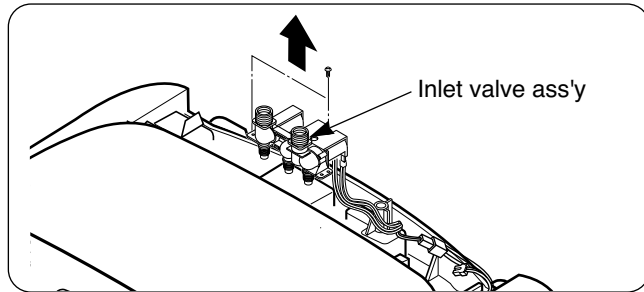
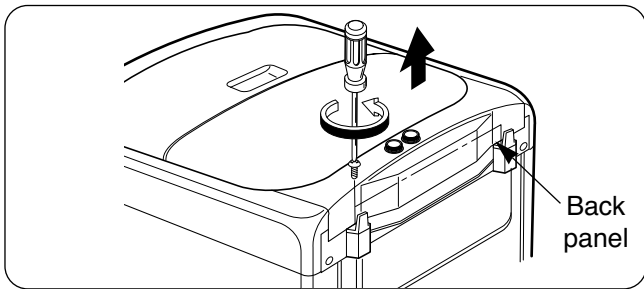

2) Disassembly of Back Panel, Power Cord, Inlet Valve & BP Sensor

- ① Remove two back panel fixing screws in the back side.
- ② Disassemble the back panel.
- ③ Disconnect two connectors and disassemble the power cord.
- ④ Remove a valve fixing screw & disconnect the leads from the inlet valve.
- ⑤ Remove the inlet valve.
- ⑥ Disconnect the leads & the pressure tube from the BP sensor.
- ⑦ Remove the BP sensor.
 - ▶ Fuse is located in the Fuse holder.
 - For fuse replacement use the following rated fuse
 - * Rating of fuse
 - 250V 6A fusing type for 220-240V product
 - 125V 12A fusing type for 100-127V product

3) Disassembly of Lid Assembly, Top Cover, Tub Cover, Pulsator & Inner Tub

- ① Remove Q-spring & two hinge pins then disassemble the lid assembly
- ② Remove two top cover fixing screws in the rear then disassemble the top cover.
- ③ Remove tub cover fixing screws then disassemble the tub cover.
- ④ Remove the pulsator fixing screw then disassemble the pulsator.
- ⑤ Remove the hub fixing nut by a special tool.
- ⑥ Disassemble the inner tub.

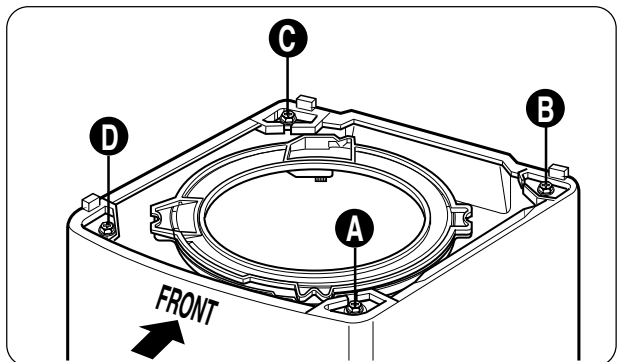
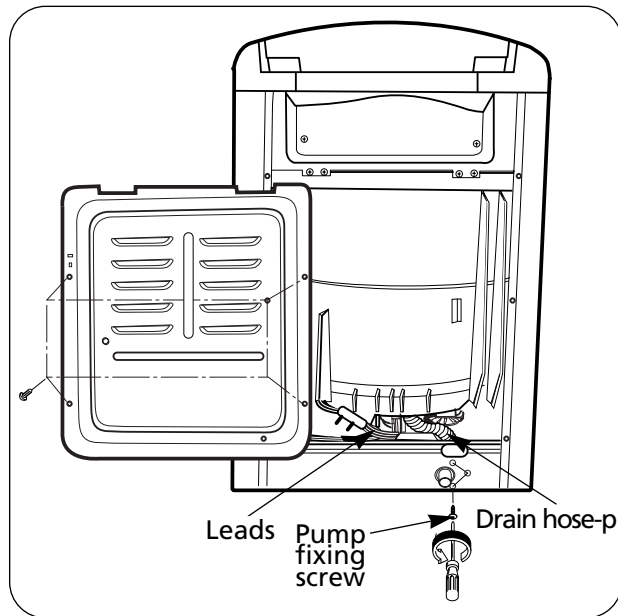
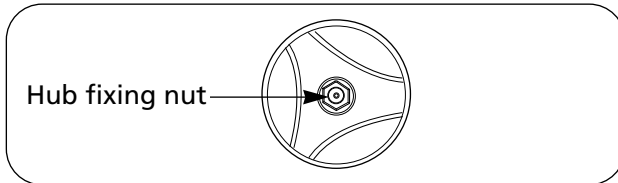
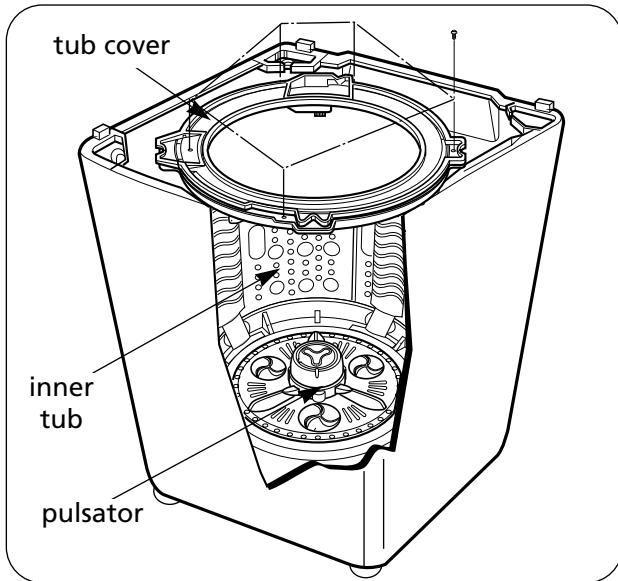

4) Disassembly of Back Cover, Drain Pump, Clutch(Transmission) & Motor

- ① Remove back cover fixing screws then disassemble the back cover.
- ② Disconnect the leads and the drain hose-p from the drain pump.
- ③ Remove the pump fixing screws then disassemble the drain pump.
- ④ Fall down the washer for clutch & motor removal.
- ⑤ Remove the belt.
- ⑥ Disassemble the clutch.
- ⑦ Remove two motor fixing screws then disassemble the motor.

5) Replacement of Damper asm



- ① Separate top cover from washing machine.
- ② As in the fig, lift snubber bar and take it out of out case with out tub.
- ③ Damper assembly shall not be disassembled. Replace damper as assembly.
- ④ For assembly, keep the following.(Location & color)

Location	P/No.	PIVOT(Color)
A , B	A051	MIDDLE BLUE
C , D	A052	WHITE

4-6. TEST RUNNING WITHOUT WATER

1) METHOD TO USE QC TEST MODE

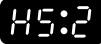
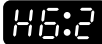
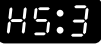
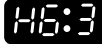
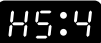
- ▶ To use check program (QC test mode), power ON with water temperature and water level.
Key pressed in non-load empty water.

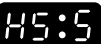
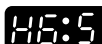
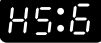
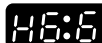
No.	Check points	Check method Start/Pause KEY PUSH Press	Normal condition		Errorr	Remedy	
			Load	Display			
1	LED and Pressure (check level)	Begining point	Buzz once	<ul style="list-style-type: none"> • LED on all • No.200 displayed 		-	<ul style="list-style-type: none"> • Check pressure S/W assembly. • Check connector. • Replace controller's IC3.
		Sensor	LEVEL sensor displayed. Frequency display	<ul style="list-style-type: none"> • No.264~270 is 			
2	Motor	Press once	<ul style="list-style-type: none"> • Pulsator rotates to left four times and right four times. 	<ul style="list-style-type: none"> • No.70~125 is displayed. 		-	<ul style="list-style-type: none"> • Check in unload condition. • Check connector. • Check driving part (Motor, Clutch, V-belt, Capacitor).
3	Cold water valve	Press twice	<ul style="list-style-type: none"> • Cold valve starts. 	50Hz	60Hz	-	
							
4	Hot water valve	Press three time	<ul style="list-style-type: none"> • Hot water valve starts 			-	<ul style="list-style-type: none"> • Top filter of supply valve is clogged with dregs. • Check connector. Check if TR3(hot) TR4(cool) and TR5(shower) are ON in load driving Part of connector asm.
5	Shower valve	Press four times	<ul style="list-style-type: none"> • Shower valve starts 			-	
6	Check drain valve	Press five times	<ul style="list-style-type: none"> • Drain valve ON(Turbo Drum). 			Door error (Buzz continued)	<ul style="list-style-type: none"> • Check door. • Check drain hose and drain motor. • Check connector. • Check TR6 in controller asm.
7	Check the drain Pump.	Press Six times	<ul style="list-style-type: none"> • Drain Pump ON • Drain Valve ON 				<ul style="list-style-type: none"> • Check drain pump • Check TR8 in controller asm. • Check connector.
8	Check the AUTO OFF switch.	Press Seven times	<ul style="list-style-type: none"> • Power off within 1 sec. 	<ul style="list-style-type: none"> • LED off 			

4-7. TROUBLE SHOOTING AGAINST COMMON WASHING PROBLEMS

Many washing problems involve poor soil & stain removal, residues of lint and scum, and fabric damage. For satisfactory washing results, follow these instructions.

WASH PROBLEM

Problems	Possible Causes	Solutions & Preventive Measures
Poor soil removal	<ul style="list-style-type: none"> • Not enough detergent • Wash water temperature too low. • Overloading the washer • Incorrect wash cycle • Incorrect sorting • Do not pretreat stain 	<ul style="list-style-type: none"> • Use correct amount of detergent for load size, amount of soil and water hardness. • Use warm or hot water for normal soil. Different water temperature may be required according to soil type. (refer to page 12) • Reduce load size. • Wash with Jean or Soak(Turbo) & Jean wash cycle for heavy soiled laundry. • Separate heavily soiled items from lightly soiled ones. • Pretreat stain and heavy soil according to directions shown on page 11.
Blue Stains	<ul style="list-style-type: none"> • Undiluted fabric softener dispensed directly onto fabric 	<ul style="list-style-type: none"> • Rub the stain with bar soap. Wash. • Do not overfill fabric softener dispenser and do not pour liquid fabric softener directly onto fabric. See page 14 for more instructions.
Black or gray marks on clothes	<ul style="list-style-type: none"> • A buildup caused by the interaction of fabric softener and detergent can flake off and mark clothes • Not enough detergent 	<ul style="list-style-type: none"> • Keep the recommendations against Scrud(waxy buildup). (refer to scrud page14.) • Use correct amount of detergent for load size, amount of soil and water hardness.
Yellow or brown rust stains	<ul style="list-style-type: none"> • Iron or manganese in water supply, water pipes, or water heater 	<ul style="list-style-type: none"> • To restore discolored load of whites, use rust remover safe for fabric. • Install nonprecipitating water softener or an iron filter in your water supply system for an ongoing problem. • Before washing, run water for a few minutes to clear lines.
Lint	<ul style="list-style-type: none"> • Incorrect sorting • Tissues left in pocket • Overloading the washer 	<ul style="list-style-type: none"> • Wash lint givers eg towels, flannelette sheets, separately from lint collectors eg synthetic fabrics and remove tissues in pockets before wash. See page 11 for sorting and caring before loading. • Do not overload the washer
Residue or detergent	<ul style="list-style-type: none"> • Overloading the washer • Undissolved detergent • Use too much detergent 	<ul style="list-style-type: none"> • Do not overload the washer. • Some detergents need to be pre-dissolved, check the detergent instructions. Try pre-dissolving the detergent. • Increase water temperature using hot water safe for fabric. • Use proper amount of detergent.
Holes, tears, or snags	<ul style="list-style-type: none"> • Incorrect use of chlorine bleach. • Unfastened zippers, hooks, buckles • Ribs, tears and broken threads • Overloading the washer • Degradation of fabric 	<ul style="list-style-type: none"> • Never pour chlorine bleach directly on fabric. See page 13 for adding liquid bleach. • Fasten zippers, hooks, and buckles. • Remove objects in pockets. See page 11 for caring before loading. • Do not overload the washer.

4-8. TROUBLE SHOOTING METHODS ACCORDING TO ERROR MESSAGE

► For more detailed information for trouble shooting refer to page 38 to 49.

Error	Determination	Expected cause	Remedy
INLET Er lamp blinks.	Water supply doesn't reach set level within 60 minutes.	1. Locked or frozen water tap.	• Open water tappet for water supply.
		2. Obstructed water supply.	• Wash at supply condition.
		3. Top filter of supply valve is clogged with dregs.	• Clean or change filter.
		4. Connector of supply valve is disassembled or wrongly contacted.	• Reconnect connector or adjust wrong contact.
		5. Yellow 2 pin connector of controller ASM is disassembled or wrongly contacted.	• Reconnect connector and adjust wrong contact.
		6. TR3 (hot), TR4 (cool), TR5 (shower) are not ON at load drive part of controller ASM.	• Check load drive parts of TR3, TR4 and TR5, and replace related parts.
		7. Drain hose is not hung up.(Pump Model)	• Hung up drain hose.
DRAIN Er lamp blinks.	When drain is not finished within 12 minutes at drain course.	1.Drain hose is not put down (Non Pump Model)	• Put down drain hose properly. (0.9~1.3m high)
		2. Drain hose is bent or clogged (Frozen or clogged with dregs).	• Clean clogged drain hose.
		3. Connector of drain motor or white 2 pin connector of controller ASM is disassembled or wrongly contacted.	• Reconnect connector and adjust wrong contact.
		4. Wrong drain motor (As AC 220V is applied to both ends of drain motor, the link opens the drain valve.)	• Replace drain motor.
		5. TR8 is not ON at load drive part of controller ASM.	• Check load drive part of TR8. Replace related parts.
		6. Wrong drain pump. (Pump Model)	• Check drain pump.
		7. Drain hose is hung up highly (over 1.3m)	• Hang up drain hose properly (0.9~1.3m high)

Error	Determination	Expected cause	Remedy
SPIN Er lamp blinks.	Unbalanced water for spin procedure.	1. Water is partially filled in inner tub asm.	• Fill water evenly into inner tub asm.(horizontally)
		2. Machine is slopped (Check drop position of leveller).	• Adjust machine height horizontally.
		3. Safety switch is too closer to inner tub asm or safety switch contacted wrongly.	• Check and replace safety switch.
		4. Is the CONNECTOR of Ball Pressure Sensor disconnected or badly touched?	• Check B.P SENSOR CONNECTOR or replace B.P sensor
DOOR Er lamp blinks and continuous buzz	Opened lid during washing procedure. (wash, rinse and spin)	1. Lid is opened during all washing procedure.	• Close lid.
		2. Lid is opened during reservation program.	• Close lid.
	Opened lid during delay finish program.	3. Connector of safety switch or violet (VI) 2 pin of controller asm is disassembled or left wrong contact.	• Connect connector again or adjust wrong contact.
		4. The safety switch is wrong. (It is ON in case of the lid closed.)	• Check and replace safety switch.
		5. Ball Pressure Sensor is bad or bad contact.	• Check and replace Ball Pressure Sensor.
PE displayed.	Frequency generated by recognizing water level at pressure switch is out of reference value (below 15kHz)	1. The connector of Ball Pressure Sensor (Pressure Switch) or the blue 3 pin connector of the controller ASM is disassembled or connected wrongly.	• Connect connector again and adjust wrong contact.
		2. Wrong Ball Pressure Sensor (Pressure Switch).	• Replace Ball Pressure Sensor (Pressure Switch).
		3. Wrong controller asm.	• Replace controller asm.
OF displayed.	Frequency generated by recognizing water level at pressure switch is out of reference value (below 22KHz)	1. Defect of inlet valve.	• Replace the inlet valve.
		2. Defect of PWB asm.	• Replace the PWB asm.

4-9. HOW TO DIAGNOSE AND REPAIR BY SYMPTOM

1) Washer is not energized.

Where, what & how to check?	Result of Check	Possible Cause	How to repair & settle
<u>Household Power supply</u>			
1. Check whether connection between the plug and the electrical is poor	Poor	Defect of the electrical	Change the electrical.
2. Measure voltage of the electrical.	Around rating	No defect	
	0V	Defect of household power supply	Call for power supply company
<u>Wiring of the Washer</u>			
1. Measure resistance between both ends of the power supply cord with both the plug pins short-circuited.	Less than 1 Ω $\infty \Omega$	No defect Open circuit of the power supply cord	Change the power supply cord.
2. Check whether every connector in the bundle of connectors has a good connection.	Male & female connectors separated	Poor connection.	Remove the cause to give strain and reconnect them.
3. Check resistance of every wire to find out a open wire.	$\infty \Omega$	Wire is opened.	Change the lead wire.
<u>Electrical component</u>			
1. Check resistance with power relay switch turned on	Less than 0.5 Ω More than 1.0 Ω	No defect Poor contact	Change the Auto Off Switch
2. Check the secondary voltage of the transformer.	10~14V 0V	No defect Coil is open	Change the transformer.
3. Measure resistance to check whether the T.P of the motor is blown out.	$\infty \Omega$ and motor is hot	T.P blown out	Remove cause to overload the motor
4. Check whether the fuse is open.	Open	Defect of the fuse	Change the fuse. CAUTION Check the fuse rating AC100~127V:125V 12A AC220~240V:250V 6A
<u>Controller</u>			
If there are no defects in the above, it should be defect of the controller. If supply voltage is 120% higher than rating the varistar in the controller may be broken. Check supply voltage.	Over 120% voltage than rating check		Change the controller if all the electrical parts have no defects.

2) Defects on displaying function

Where, what & how to check?	Result of Check	Possible Cause	How to repair & settle
<u>Main voltage</u>			
1. Measure mains voltage at the wall outlet	Less than 85% of the rating.	Low voltage.	To explain that it is caused by low voltage in electric supply and recommend using a transformer if voltage has been continuously low.
2. Measure voltage at the extended outlet that the washer is plugged in if the extended outlet is used and voltage at the electrical outlet is normal in the above.	Less than 85% of the rating	The dia of the lead wire is smaller or many loads are connected at the same outlet	To use a transformer having a enough capacity if using a transformer.
<u>Transformer</u>			
1. Measure the secondary voltage of the transformer.	Less than AC 10V	Defect of the transformer.	Change the controller.
<u>Controller</u>			
1. Defect of LED. 2. Defect of LED driving circuit. 3. Defect of micom.		Defect of controller.	Change the controller.

3) Reset During operation

Where, what & how to check?	Result of Check	Possible Cause	How to repair & settle
<u>Mains Voltage</u>			
1. Measure voltage of the outlet that the washer is plugged into during wash and spin.	Less than 80% of the rating.	Mains voltage is too low or size of a lead wire is too small.	Explain that it is caused by low voltage in electric mains and recommend using a suitable size of leads.
2. Reset symptom happens at specific time zone repeatedly.		External noise intruded.	Explain it is caused by using environment. (It happens when equipment with high frequency is used around)
3. Check whether a transformer power cut happens. (Fluorescent lamp is transformerly blinked.)			Explain it is a problem of electric supply environment.

3) Reset during operation

Where, what & how to check?	Result of Check	Possible Cause	How to repair & settle
<p><u>Drain Motor</u></p> <p>1. Operate washer setting spin only, then press the start/pause button when the wash motor starts to work and then press the start/pause button again in order for the drain motor to work intermittently.</p>	Reset happens after the drain motor works.	Defect of the drain motor (A noise generated when the internal relay works.)	Change the drain motor
<p><u>Controller</u></p> <p>1. If mains voltage and the drain motor have no defects a defect of the controller is highly possible.</p>			Change the controller.

4) Water doesn't come into the wash tub.

Where, what & how to check?	Result of Check	Possible Cause	How to repair & settle
<p><u>Inlet Valve</u></p> <p>1. If water doesn't come though the inlet valve works(electric sound occurs)</p>			
1) Check whether water mains is cut.	Water mains cut.	Mains cut.	Explain.
2) Check whether tabs are turned on.	Don't turned on.	Mistake of use.	Turn on the tap.
3) Hot & cold tab are opposite connected.	Connected opposite.	Wrong installation.	Correct their locations and turn on the tap.
4) Wrongly select water temperature option.	Selected opposite.	Mistake of use.	Explain how to use.
5) If there are no problems in the above, check the inlet valve filters after disconnecting the water supply hoses.	Filters blocked by foreign substance.	Don't clean.	Clean them by brush and explain cleaning regularly them.
6) If there are no problems in the above a diaphragm hole in the valve is blocked by foreign substance or the plunger in it is locked.		Defect of the inlet valve.	Change the inlet valve.
2. If the inlet valve doesn't work(there is no electric sound)during filling cycle.			
1) Check whether it's connectors are taken off or they have poor connection.	A connector is taken off.	Defect of contact.	Reconnect it or remove the causes to make poor connection.
2) Check resistance of the inlet valve.	$\infty \ \Omega$	Coil is open	Change the inlet valve.

4) Water doesn't come into the wash bowl.

Where, what & how to check?	Result of Check	Possible Cause	How to repair & settle
Ball Pressure Sensor (Pressure Switch) 1. Is there PE error on the display which means Ball Pressure Sensor (Pressure Switch) error	PE Error displayed.	Connector is taken off, or lead or coil is open.	Reconnect the connector or change leads. Change the Ball Pressure Sensor (Pressure Switch) if coil is open.
2. Check frequency of the Ball Pressure Sensor (Pressure Switch) without load if wash is proceeding without filling.	Less than 26.2kHz	Defect of the Ball Pressure Sensor (Pressure Switch)	Change the Ball Pressure Sensor (Pressure Switch).
Controller 1. Defect of controller is highly possible if inlet valve and Ball Pressure Sensor have no defects in the above.			Change the controller.

5) Water fills continuously or intermittently.

Where, what & how to check?	Result of Check	Possible Cause	How to repair & settle
Wrong Installation/Leakage 1. Check whether the drain hose is laying down on the floor. (For pump model)	Drain hose laying down.	Wrong installation.	The drain hose should be hung on the stand-pipe or the tub. Change the part.
2. Check where water leaks.	Water leaks from a part.	Defect of the part.	Repair it.
Ball Pressure Sensor (Pressure Switch) 1. Check the pulsator is rotating when water fills continuously.	It doesn't rotate.	Water pressure is not sensed.	Check the tube of the Ball Pressure Sensor (Pressure Switch), it is bent or blocked, repair that.
2. If there is no defect in the Ball Pressure Sensor (Pressure Switch), check whether the air hole of the outer tub is blocked.	Blocked.	Air hole blocked.	Repair the blocked hole.
Inlet Valve 1. Does water fill even though it is not energized (power is off)?	Water fills.	Defect of the inlet valve.	Change the inlet valve.
Controller 1. Does water fill immediately after the power switch turns on before pushing the start/pause button.		Short circuit of the triac of the controller.	Change the controller.

6) Pulsator doesn't rotate normally.

Where, what & how to check?	Result of Check	Possible Cause	How to repair & settle
<p><u>Pulsator rotates at one direction.</u></p> <p>1. The Pulsator rotates normally at the beginning of wash cycle, but is it not rotate at clockwise direction (locked) after some wash cycles though there is motor-working sound?</p>	Clockwise rotation locked.	Unusual operation.	Turn the power off and on again then that symptom disappears. Explain "Don't run wash only continuously".
<p>2. In the case the pulsator doesn't rotates either clockwise or counterclockwise from the beginning of wash cycle:</p> <p>1) Check resistance of the wash motor if there is no motor-working sound.</p>	Resistance is normal.	Defect of controller or poor contact of connectors of motor leads.	Change the controller if there are no contact defects in the leads of the motor.
<p>2) Check belt tension & whether the clutch rotates normally if there is motor-working sound.</p>	V-belt is loose.	Loose the belt.	Adjust belt tension by changing motor fixing location and change the belt if it is impossible to adjust belt tension.
	Clutch locked.	Defect of the clutch.	Change the clutch if the clutch pulley is locked when making it rotated clockwise and counterclockwise by hand.
<p>3. The pulsator doesn't rotate at both directions.</p> <p>1) Check whether motor rotates at both directions if there is motor-working sound when it's energized.</p>	Motor rotates at both directions.	Loose the belt.	Adjust belt tension or change the belt if it is impossible to adjust.
		The plusator locked.	Remove cause locking the pulsator
		Defect of the clutch.	Change the clutch.
	Motor doesn't rotates at both directions.	Defect of the capacitor.(check the capacitor's capacitance)	Change the motor if the motor is locked when having its shaft rotated by hand.
		Defect of the motor.	Change the capacitor if there is no contact defect in capacitor's lead
<p>2) Check resistance of the motor if there is no motor-working sound.</p>	$\infty \Omega$	Motor coil is open.	Change the motor.
	Normal resistance.	Contact defect of the leads.	Remove the causes.

6) Pulsator doesn't rotate normally.

Where, what & how to check?	Result of Check	Possible Cause	How to repair & settle
4. Pulsator weakly rotates. 1) Check voltage at the power outlet where the washer is plugged into.	Less than 85% of rating.	Lower voltage.	Explain the causes and a transformer should be used if necessary.
2) Check capacitance of the capacitor.	Indicating needle rises and immediately indicates ∞ .	Capacitor is normal.	
	The needle is stopped after it is raised.	Lack of capacitance of the capacitor.	Change the capacitor.
	The needle doesn't move.	Capacitor is fully discharged.	Change the capacitor.

7) Water does not drain.

Where, what & how to check?	Result of Check	Possible Cause	How to repair & settle
Drain Pump			
1. Check whether there is drain pump working sound.	There is pump working sound.	Drain pump is blocked by foreign objects.	Disassemble the drain pump cap and remove the foreign objects in the pump casing.
2. Check resistance between terminals if there is no working sound of the drain pump.	$\infty \Omega$	It's coil is open.	Change the drain pump.
3. Check connection parts of the leads if there is no working sound and its resistance is normal.	Defect in connection part.	Defect in connection part.	Repair defected connection.
	Connection part has no defects.	Defect of the controller.	Change the controller.
Drain Hose			
1. Check whether the drain hose is put in a narrow space and kinked.	Kinked.	Defect of installation.	Reinstall so that it should not be kinked.
2. Check whether the internal drain rubber asm is bent.(For Non-pump model)	Bent.	Defect of the drain rubber asm.	Change the drain rubber asm.
3. Check whether the end of the drain hose submerged into water or higher than required. (For non-pump model)	Submerged or higher than required.	Defect of installation.	Re-install so that it can't be submerged or not higher than required.

7) Water does not drain.

Where, what & how to check?	Result of Check	Possible Cause	How to repair & settle
4. Check whether the drain hose is blocked by foreign objects. It may happen in case of the hose is a little kinked.	Blocked.	Blocked hose.	Remove the objects and reinstall so that it can't be kinked.
<p><u>PV Case</u> <u>(for Non-Pump Model only)</u></p> <p>1. Check whether the PV asm is blocked by foreign objects.</p>	Blocked.		<p>Separate the drain motor from the PV link, disassemble PV cover and then remove the foreign objects within PV case.</p> <p>Check the washer works normally after repair and reassembling them. (PV link & drain motor lever should be assembled accurately.)</p>
<p><u>Drain Motor</u> <u>(For Non-Pump Model only)</u></p> <p>1. Check resistance of the drain motor if it can not pull the PV link.</p>	<p>$\infty \Omega$</p> <hr/> <p>Resistance is normal.</p>	<p>Drain motor coil is open.</p> <hr/> <p>Contact defect in connection parts or defect of the controller.</p>	<p>Change the drain motor →Check the washer works normally after reassembling. (PV link & drain motor lever should be assembled accurately.)</p> <hr/> <p>Change the controller if there is no defects in the connection parts.</p>

8) Water drains though it is not the time of drain.

Where, what & how to check?	Result of Check	Possible Cause	How to repair & settle
<p><u>Drain Motor</u> <u>(for Non-Pump Model only)</u></p> <p>1. Check whether the drain motor is normally returned after turning power off. (It is considered normal if the lever of the drain motor is fully pulled out by the PV spring)</p>	Blocked.	Defect of the drain motor.	Change the drain motor.
<p><u>PV Case</u></p> <p>1. If water drains though the drain motor is normally returned, check whether PV asm is blocked by foreign objects or the bellows in the PV asm is deformed.</p>	Blocked.		Remove the objects in the PV asm.
	Bellows deformed.	Defect of PV Bellows.	Change the PV bellows. (The bellows may swell up if it contact petroleum or petrochemical substance because it is made of rubber)
<p><u>Controller</u></p> <p>1. Check whether the drain motor or the drain pump works immediately after power is turned on.</p>	Works.	Defect of the controller(Triac defect)	Change the controller.

9) Drain error happens while water drains normally.

Where, what & how to check?	Result of Check	Possible Cause	How to repair & settle
<p><u>Ball Pressure Sensor</u> <u>(Pressure Switch)</u></p> <p>1. Check generation frequency of the Ball Pressure Sensor (Pressure Switch) without water.</p>	Less than 26.3 kHz	Defect of the Ball Pressure Sensor(Pressure Switch).	Change the Ball Pressure Sensor (Pressure Swtich)
	26.3~27.1 kHz	Defect of the controller.	Change the controller.

10) Spin extraction is not proceeded.

Where, what & how to check?	Result of Check	Possible Cause	How to repair & settle
Motor			
1. In the case that the wash motor does not spin during spin extraction; 1) Check there is motor working sound,or	There is motor working sound.	Defect of the capacitor or Mechanically locked.	Change the capacitor after checking defect of capacitor. check whether the washing clutch or the washing tub is blocked if the motor rotates after removing the V-belt. Check whether the motor is locked if the motor does not rotates even though the V-belt being removed.
2) If there is no motor-working sound; ① Check frequency of the Ball Pressure Sensor (Pressure Switch), under no load, or	Less than 26.3kHz	Defect of the Ball Pressure Sensor (Pressure Switch).	Change the Ball Pressure Sensor(Pressure Switch).
② Check contact defect of the safety switch, defect of connection parts and whether the lid is open if door error is displayed.	The lid is open	Mistake in use.	Explain "The lid is close during operation"
	Defect of connection part.		Reconnect the connctors.
③ Is placed the magnetic in Lid-B.	The lid is open.	Mistake in use.	Explain"The lid is close during operation"
	Defect of magnetic in LID-B		Change the Lid-B
④ Check resistance of the motor.	Contact defect of the Ball Pressure Sensor(Safety Switch)		Change the Ball Pressure Sensor(Safety Switch).
	$\infty \Omega$	Coil is open.	Change the motor.
Drain Motor/Clutch			
1. In the case the motor rotates but the inner tub does not rotates; 1) Check resistance of the drain motor if the drain motor doesn't work,or	$\infty \Omega$ Resistance is normal	Coil is open. Defect of connection part or defect of the controller.	Change the drain motor. Change the controller after checking connection parts.
2) Check gap between the PV link and the brake lever if the inner tub does not rotates while the drain motor works.	The clearance is less than 2.0mmor more then 3.5mm	Assembling defect of the drain motor or the clutch	Reassemble the drain motor or the clutch to keep the clearance.
	The gap is normal (2.0~3.5mm)	Defect of the clutch.	Change the clutch.

11) Spining is going on even though the lid is open.

Where, what & how to check?	Result of Check	Possible Cause	How to repair & settle
<u>Safety Switch</u> 1. Check resistance between both terminals of the safety switch with the lid open.	0~9Ω	Contact points of the safety switch are welded.	Change the Safety Switch
	∞Ω	Defect of the controller.	Change the controller
<u>Ball Pressure Sensor</u> 1. Is placed the magnetic on the wash?	Yes	Reed S/W is short by magnetic on the washer.	Keep magnet away from the washer.
	No	Reed Switch.	Change the controller.

12) Spin basket doesn't reach to full speed(normal rpm)

Where, what & how to check?	Result of Check	Possible Cause	How to repair & settle
<u>Main voltage</u> 1. Check voltage at the power outlet where the washer is plugged into.	Less than 85% of rating	Tool low voltage	Explain the cause and recommend using a transformer if necessary.
<u>Starting Capacitor</u> 1. Check the capacitance of the starting capacitor.	Lack of capacitance	Defect of capacitor	Change the capacitor
<u>Clutch Assembling</u> 1. Check the clearance between the PV link and the brake lever and clearance between the clutch lever and the adjustment bolt.	The clearance is less than 2.0mm or more than 3.5mm		Adjust PV lever bolt and paint it red. Reassemble the drain motor or the clutch.
	Bolt clearance is out of range 1.9±0.1mm	Defect of the clutch	Adjust the bolt clearance.
<u>Blocked by foreign objects</u> 1. Check whether the PV asm, the drain pump & the drain hose are blocked by foreign objects so that it makes water-splashing noise in the tub.			Remove the foreign objects.

13) Vibration, Noise or Unbalance Error happens during spin.

Where, what & how to check?	Result of Check	Possible Cause	How to repair & settle
<p><u>Using conditions such as installation etc.</u></p> <p>1. Check whether the washer is leveled. (Check clearance with out tub and out case the left gap is the same as the right and the rear gap is 1.5~2 time bigger than the front gap, between the cabinet and the wash bowl, when it is leveled.)</p>	Not leveled.	Defect of installation	Level the washer.
<p>2. Check whether laundry in the wash bowl is out of balance that can cause severe vibration & noise.</p>	Laundry is unbalanced.		Explain that it is not out of order and it may happen when big & long laundry is washed.
<p>3. Check whether the pulsator doesn't rotate during spin.(To check that, remove the front lid and than run the spin only cycle.)</p>	The pulsator rotates initially then the inner tub rotates.	Defect of the clutch	Change the clutch spring-B or the clutch asm.
<p><u>Safety Switch</u></p> <p>1. Check whether the lever of the safety switch touches the outer tub if touching noise happens.</p>	The lever is bented	Defect of the safety switch	Change the safety switch. Don't repair and reuse it because it creates another problem if it is wrongly repaired.
<p><u>Damper</u></p> <p>1. Check whether the outer tub cover hit the top cover without load during spin.</p>	Hit	Defect of the damper	Change four dampers simultaneously. (In assembling, check the position to damper asm)
<p>※ It is very important to find out what kinds of noise & where comes from to settle noise during spin and accumulately service experiance.</p>			

14) Power is automatically turned off during operation or immediately turning on the power switch.

Where, what & how to check?	Result of Check	Possible Cause	How to repair & settle
<p><u>Main voltage</u></p> <p>1. It is mostly caused by noise from mains or transformer power cut.</p>		Defect in main.	Explain the cause. (It happens specially when a high frequency equipment is used around the washer or in the case voltage fluctuation is big)
<p><u>Auto Off switch or Controller</u></p> <p>1. Check whether power is automatically turned off when turning on the auto off switch after unplugging the power cord from the outlet</p>	Automatically turned off	Mechanical defect of the auto off switch.	Change the auto off switch.
<p>2. It would be defect of the controller if power is automatically turned off immediately when turning on the power switch even though there is no defects in the auto off switch.</p>			Change the controller.

5. EXPLODED VIEW

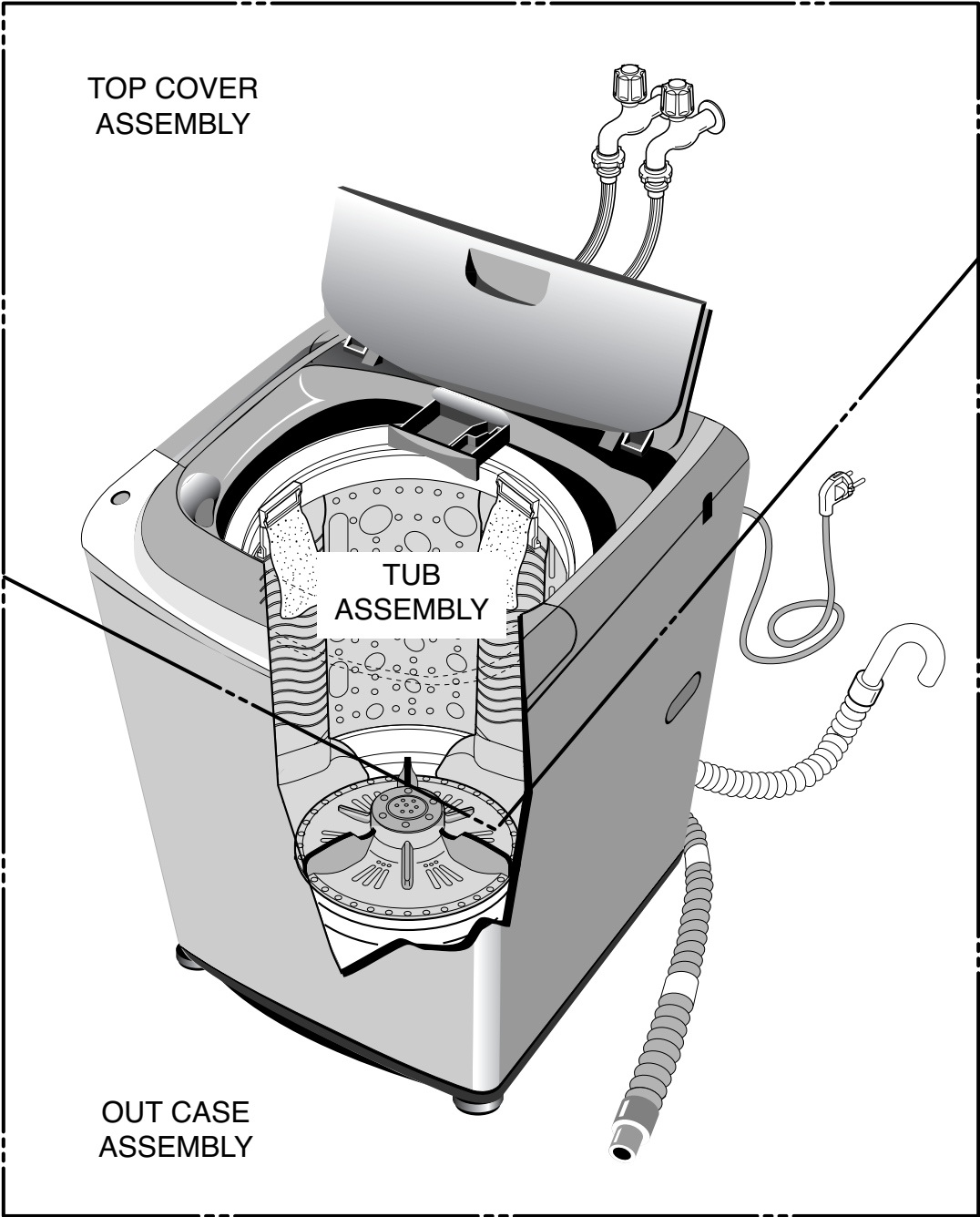

5-1. THE EXPLODED VIEW OF TOP COVER ASSEMBLY

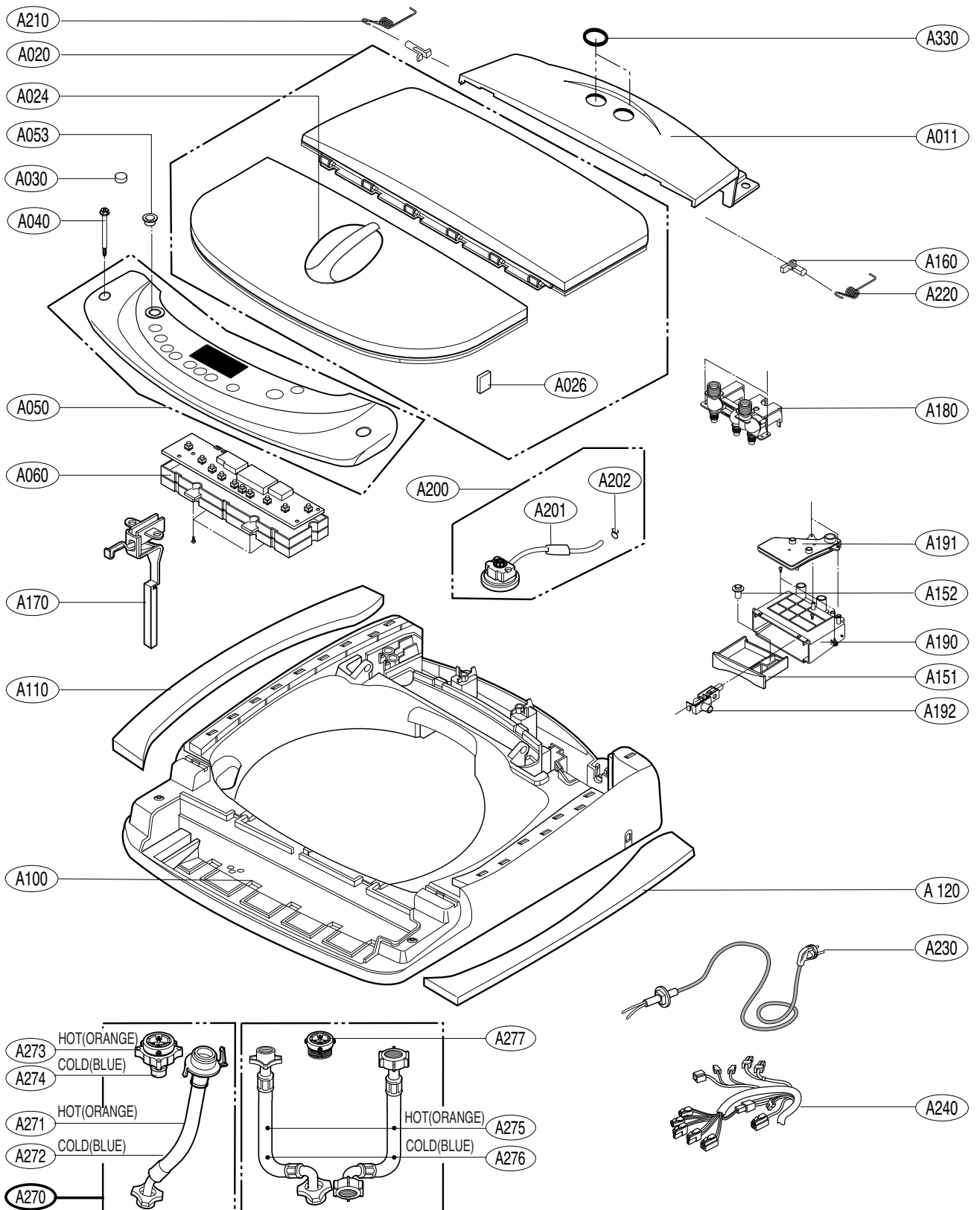

5-2. THE EXPLODED VIEW OF OUT CASE ASSEMBLY

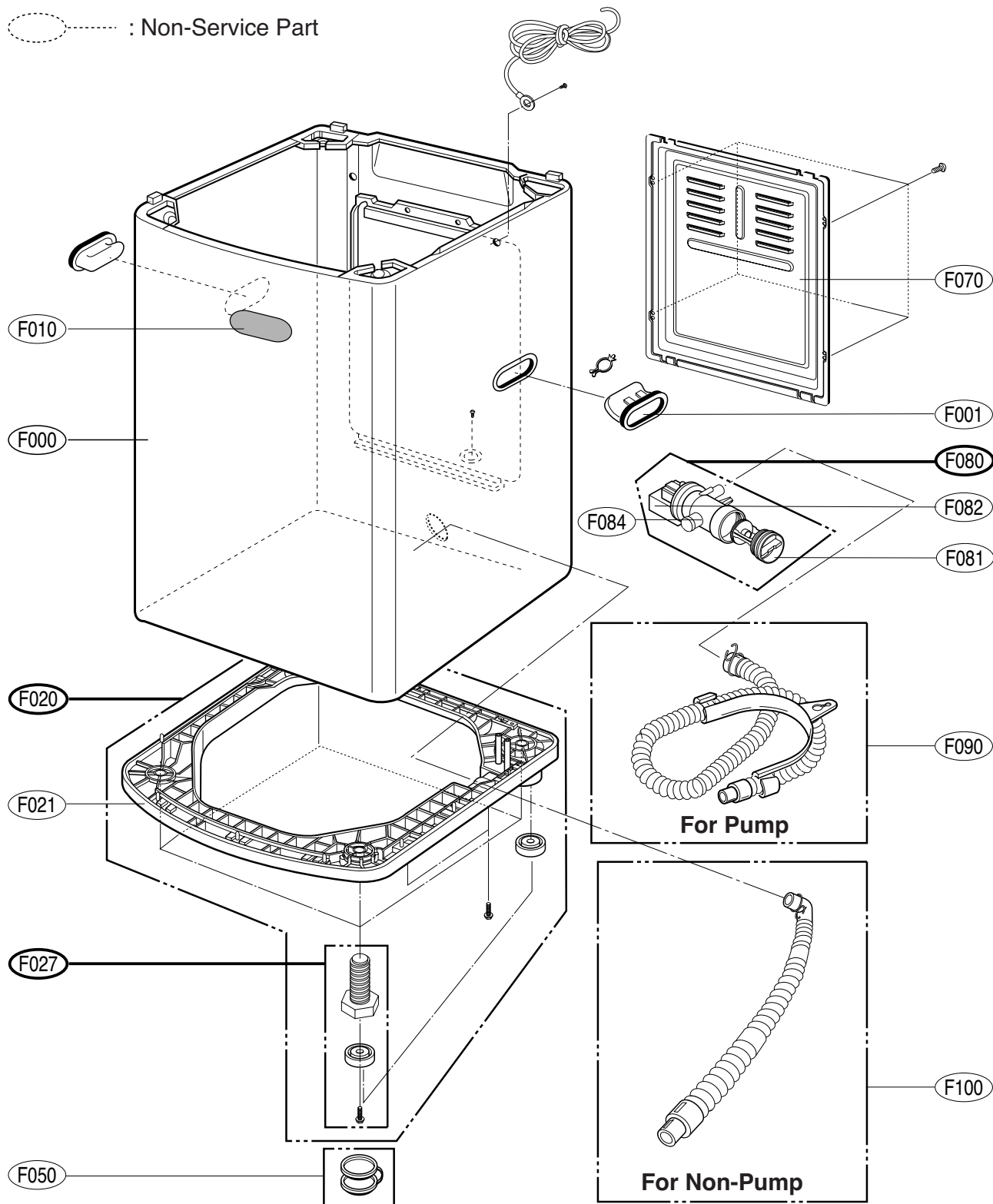

5-3. THE EXPLODED VIEW OF TUB ASSEMBLY

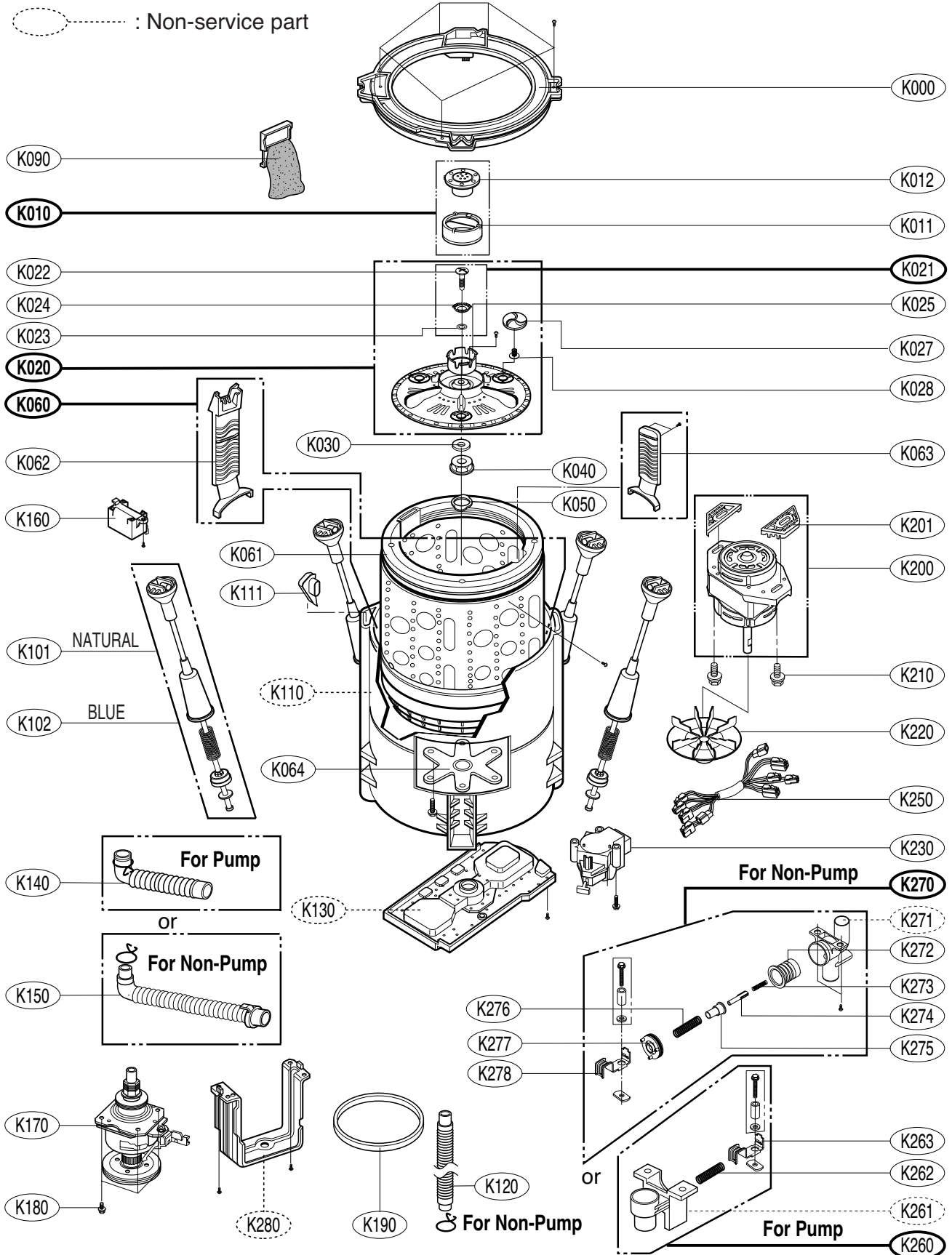

Free Manuals Download Website

<http://myh66.com>

<http://usermanuals.us>

<http://www.somanuals.com>

<http://www.4manuals.cc>

<http://www.manual-lib.com>

<http://www.404manual.com>

<http://www.luxmanual.com>

<http://aubethermostatmanual.com>

Golf course search by state

<http://golfingnear.com>

Email search by domain

<http://emailbydomain.com>

Auto manuals search

<http://auto.somanuals.com>

TV manuals search

<http://tv.somanuals.com>