



MOTOROLA

Motorola D1000 Series

For D1001, D1002, D1003 and D1004

Digital Cordless Phone

Warning

Use only rechargeable batteries.

Welcome...

to your new Motorola D1000 Digital Cordless Phone!

- All handsets fully cordless for locating anywhere within range.
- 100 Name and number phonebook.
- Copy phonebook entries between other handsets.
- Caller Display shows you who's calling and see details of the last 50 callers in a Calls list.¹
- Register up to 5 handsets to a single base and register each handset with up to 4 different bases.
- Make internal calls, transfer external calls, hold 3-way conversation between two internal callers and an external caller.

¹You must subscribe to your network provider's Caller Display or Call Waiting service for these features to work. A quarterly fee may be payable.

Please note that this equipment is not designed for making emergency telephone calls when the power fails. Alternative arrangements should be made for access to emergency.

This User Guide provides you with all the information you need to get the most from your phone.

Before you make your first call you will need to set up your phone.

Follow the simple instructions in 'Getting Started', on the next few pages.

IMPORTANT

Only use the telephone line cord supplied.

This equipment is not designed for making emergency telephone calls when the power fails. Alternative arrangements should be made for access to emergency services.

Got everything?

- D1000 handset
- D1000 base
- User guide
- 2 x AAA NiMH rechargeable batteries
- Mains power adapter for the base
- Telephone line cord

If you have purchased a D1000 multiple pack you will also have the following additional items:

- D1000 handset & charger
- 2 x AAA NiMH rechargeable batteries
- Mains power adaptor for the charger

Need help?

If you have any problems setting up or using your D1000, please contact Customer Services on **(65) 6841 2668**.

Email: **support@alcom.com.sg**

Alternatively, you may find the answer in the 'Help' section at the back of this guide.



1. Getting started	6		
2. Getting to know your phone	9		
3. Using the phone.....	14		
3.1 Calls.....	14		
3.1.1 Make a call	14		
3.1.2 Pre-dial	14		
3.1.3 Dial one touch numbers 1 to 9	14		
3.1.4 Call from the phonebook	14		
3.1.5 Call from the calls list	14		
3.1.6 Answer a call	14		
3.1.7 Adjust volume	15		
3.1.8 Mute	15		
3.1.9 End a call	15		
3.1.10 Switch handset on/off	15		
3.2 Intercom.....	15		
3.2.1 Call another handset	15		
3.2.2 Transfer an external call to another handset	16		
3.2.3 Three-party conference call	16		
4. Phonebook	16		
4.1 View and dial phonebook entries.....	16		
4.2 Store an entry	16		
4.3 Entering names	17		
4.4 Character map.....	17		
4.5 Enter a pause	18		
4.6 View an entry.....	18		
4.7 Edit an entry	18		
4.8 Delete an entry	18		
4.9 Delete all entries.....	19		
4.10 Copy phonebook to another handset	19		
4.11 One touch keys	19		
4.12 Dial a one touch number	19		
4.13 Store a phonebook entry as a one touch number	19		
4.14 Delete a one touch number	20		
5. Caller display and Calls list.....	20		
5.1 Calls list.....	20		
5.1.1 View the calls list	21		
5.1.2 Dial from the calls list	21		
5.1.3 Save a number from the calls list to the phonebook	21		
5.1.4 Delete a calls list entry	22		
5.1.5 Delete entire calls list	22		
5.2 Redial	22		
5.2.1 Redial the last number	22		
5.2.2 View and dial a number in the redial list	22		
5.2.3 Copy a redial number to the phonebook	22		
5.2.4 Delete a redial list entry	22		
5.2.5 Delete entire redial list	23		

6. Clock & Alarm	23	8.3 Call barring.....	28
6.1 Set date and time	23	8.3.1 Switch call barring on/off	28
6.2 Set alarm	24	8.3.2 Set a number to be barred	29
6.3 Set alarm melody	24	8.4 Easy call.....	29
7. Personal settings	24	8.4.1 Switch easy call on/off	29
7.1 Handset tones	24	8.4.2 Set the easy call number	29
7.1.1 Ring volume	24	8.4.3 Dial an easy number	30
7.1.2 Ring melody	24	8.5 Registration	30
7.1.3 Group melody	25	8.6 Register a handset.....	30
7.1.4 Key tones on/off	25	8.7 Select a base	31
7.1.5 First ring	25	8.8 Unregister a handset.....	31
7.2 Handset name	26	8.9 PIN	31
7.3 Auto pick up	26	8.10 Reset.....	31
7.4 Auto hang up	26	8.11 Default settings	32
7.5 Display language.....	26	8.12 Auto prefix	32
7.6 Room Monitor on/off.....	26	8.13 Country.....	32
7.7 Room Monitor.....	27	8.14 Intrusion	33
7.8 Backlight on/off.....	27	8.15 ECO mode	33
7.9 Keypad lock.....	27	9. Help	34
8. Advanced settings	28	10. General information	35
8.1 Recall time	28	11. Wall mounting	42
8.2 Dial mode	28		
8.2.1 Temporarily switch from Pulse to Tone dialling	28		

1. Getting started

WARNING

Do not place your D1000 in the bathroom or other humid areas.

Location



You need to place your D1000 base within 2 metres of the mains power socket and telephone socket so that the cables will reach.

Make sure it is at least 1 metre away from other electrical appliances to avoid interference. Your D1000 works by sending radio signals between the handset and base. The strength of the signal depends on where you place the base. Putting it as high as possible ensures the best signal.

HANDSET RANGE

The D1000 has a range of up to 300 metres outdoors when there is a clear line of sight between the base and handset. Any obstruction between the base and handset will reduce the range significantly. With the base indoors and handset either indoors or outdoors, the range will normally be up to 50 metres. Thick stone walls can severely affect the range.

SIGNAL STRENGTH

The  icon on your handset indicates when you are in range. When out of range of the base, the screen shows **SEARCHING** and the  flashes.

If you are on a call, the line will hang up if the handset moves out of range of the base. Move back within in range. The handset will automatically re-connect to the base.

Setting up

IMPORTANT

The base station must be plugged into the mains power at all times. Do not connect the telephone line cord into the wall socket until the handset is fully charged. Only use the power and telephone cables supplied with the product.

WHICH POWER ADAPTOR?

The power adaptor with a clear connector is for the base unit and the power adaptor with a red colour connector is for the charger unit.

Connecting up the base

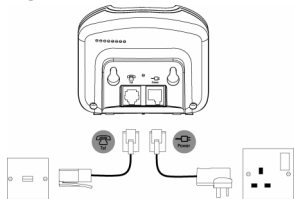

Plug the mains power cable with the clear connector into the socket marked  on the underside of the base and plug

the other end into the mains power wall socket and switch the power on.

Connecting the handset and charger (Multi-pack only)

If you have purchased a multiple pack, this process will need to be carried out for all handsets and chargers:

1. Plug the mains power cable with the red connector into the socket marked  on the underside of the charger.

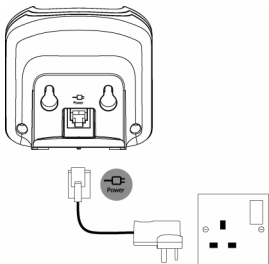

2. Insert the 2 x AAA NiMH batteries supplied into the handset. Then slide the compartment cover into place.

3. Place the handset on the charger to charge for at least 24 hours. When the handset is fully charged the  icon will indicate that it is fully charged.
4. When the handset is fully charged after 24 hours, plug the telephone line cord from the large base into the telephone wall socket.

IMPORTANT

Warning! Use only the approved rechargeable Ni-MH battery cells (2 x AAA Ni-MH 550mA rechargeable batteries) supplied with your D1000. Please do not use alkaline or non rechargeable batteries. It may cause permanent damage to the product and void the warranty.

BATTERY LOW WARNING

If the  icon flashes in the display, you will need to recharge the handset before you can use it again.

During charging, the  icon will scroll in the display.

Once fully charged scrolling will stop.

BATTERY PERFORMANCE

In ideal conditions, fully charged batteries should give up to 10 hours talk time or up to 150 hours standby time on a single charge.*

**All talk and standby times are approximate and depend on features selected and usage pattern.*



To keep your batteries in the best condition, leave the handset off the base for a few hours at a time.





Running the batteries right down at least once a week will help them last as long as possible.

The charge capacity of rechargeable batteries will reduce with time as they wear out, giving the handset less talk/standby time. Eventually they will need to be replaced.

After charging your handset for the first time, subsequent charging time is about 6–8 hours a day. Batteries and handset may become warm during charging. This is normal.

Setting up your D1000

Welcome screen

1. WELCOME is displayed and scrolls in different languages. Press . The country name is shown on the display.
2. Scroll  or  to your country and press . CONFIRM? is displayed.
3. Press OK to confirm.
The handset and base will reset to load the correct settings. The standby screen is then displayed and your phone is ready to use.







You can still make and receive calls without first selecting your country and network operator, however the Welcome screen will re-appear until you have configured your phone country settings.

Date and time

Providing you have subscribed to your network's Caller Display service, the date and time is set automatically for all handsets every time a call is received.

If you do not have a Caller Display service you can set the date and time manually.

Set date and time manually

1. Press  and scroll  to CLOCK/ALARM. Press . Display shows DATE & TIME, then press .
2. Enter the date using the format DD/MM e.g. 04/ 08 for 4th August.
3. Press  and enter the time using the 24 hour format HH:MM, e.g. 14:45 for 2:45pm.
4. Press  to confirm or  to return to standby.

YOUR D1000 IS NOW READY FOR USE.

2. Getting to know your phone

Overview of your handset

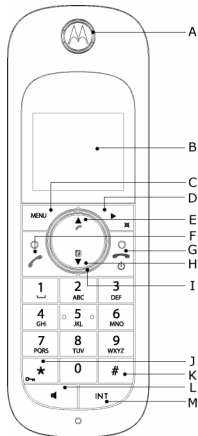

- A Earpiece**
- B Display**
See page 10 for an overview of the display icons.
- C Menu key**
Enter the main menu. Select the option displayed on screen. Confirm menu option – **OK** is displayed on screen.
- D Redial / Scroll right / Clear / Mute**
Open the redial list. Scroll to the right.
Delete characters on screen when entering names and numbers.
Mute / unmute the microphone during a call. Go back to previous menu level – **BACK** displayed on screen.
- E Call log / Scroll Up / Volume up**
Open the calls log.
Scroll up through lists and settings.
Increase the earpiece volume during a call.
- F Talk / Recall**
Make or answer a call.
Use recall (R) functions.
When on an external call, press this key once to get a fresh dial tone or to access a Call Waiting Line when you hear the call waiting prompt signal. Press this key again to toggle between the two calls. Also used with switchboard / PABX services and some network services.
- G End / Exit / Switch handset on/off**
End a call.
When in a menu, go back to standby mode. Press and hold to switch handset off (when in standby) or on.



H Phonebook / Scroll Down / Volume down

Open the phonebook.
Scroll down through lists and menus.
Decrease the earpiece volume.

I Navigator glow ring

Illuminates when the phone is in use. Flashes to indicate new Voicemail.

J * / Keypad lock

Press and hold to lock/unlock the keypad.
During a call, press and hold to switch from pulse dialling to tone dialling.
Dial a star.

K # / Ringer off / Pause

Press and hold to switch handset ringer on or off.
When dialling or storing a number, press and hold to enter a pause (P).
Dial a #.

L Loudspeaker key

Activate and deactivate the loudspeaker during a call.

WARNING

Handsfree activation can suddenly increase the volume in the earpiece to a very high level. Make sure the handset is not too close to your ear.

M Intercom (at least 2 handsets needed)

In standby mode, use to make an internal call.
During a call, use to transfer an external call to another handset.

Handset display

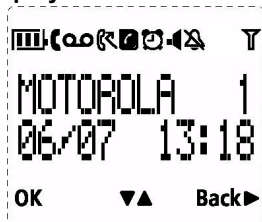

A Display icons



On when the line is in use.
Flashes when there is an incoming call.



Flashes when you have new voicemail messages.*
Off when you have no new voicemail messages.



Flashes when you have missed calls and new number(s) are in the Calls list.*



Phonebook is open.



The alarm clock has been set.



Handsfree mode.



Handset ringer is off.



Steady when the handset is registered and within range of the base. Flashes when the handset is out of range or searching for base.

The approximate power levels of your battery are indicated as below:



Battery is fully charged.



Battery is partially charged.



Battery is running low.





Battery is almost empty. The battery icon will flash and emit a warning beep every minute during call.

** For this feature to work, you must subscribe to Voicemail service or Caller ID from your network operator. A subscription fee may be payable.*

B OK displayed

Press the  key to select and validate a setting

C ▲▼ displayed

Press  or  to scroll through the options in a menu, to open the phonebook or call list when in standby.

D Back ► displayed

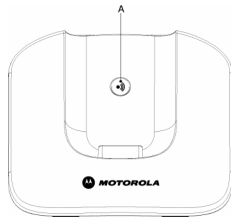

Press  to go back to the previous menu option, to cancel an action or to delete a character.

Overview of the base







A Paging key

Paging is a useful way of finding lost handsets.

1. Press  on the base.
 - All handsets ring.
2. Press  again to cancel the paging call or press any key on the handset to stop the paging call.

Navigating the menus

The basic steps of navigating through the menu and on-screen options.

1. From the standby screen, press  .
The main menu is opened.
2. Use the  or  keys to scroll through the menu.
3. Soft key options **OK** and **BACK** are displayed. Press  to select **OK** and open a sub-menu or validate an option.
Press **BACK** and go back to previous menu level, correct a character or cancel an action.
4. Press  to return to standby.

If you do not press any button on the handset for 15 seconds the display will automatically return to standby. It will also return to standby when the handset is placed on the base or charger.



Menu map

PHONEBOOK

NEW ENTRY
LIST ENTRY
<NAME>
EDIT ENTRY
DELETE ENTRY
DELETE ALL
DIRECT MEM
PB TRANSFER*

CLOCK/ALARM

DATE & TIME
SET ALARM
ALARM TONE

PERSONAL SET

HANDSET TONE
RING VOLUME
RING MELODY
GROUP MELODY
KEY TONE
FIRST RING
HANDSET NAME
AUTO PICK-UP
AUTO HANG-UP
LANGUAGE
ROOM MONITOR
BACKLIGHT

ADVANCED SET

RECALL TIME
DIAL MODE
CALL BARRING
EASY CALL
REGISTRATION
SELECT BASE
REGIST. BASE
UNREGISTER
PIN
RESET UNIT
PREFIX
SEL. COUNTRY
INTRUSION
ECO MODE

*This option is only available if more than one D1000 handset is registered to the base.





3. Using the phone

3.1 Calls



3.1.1 Make a call

1. Press .
2. Dial the telephone number.





3.1.2 Pre-dial

1. Enter the phone number (maximum 24 digits). If you make a mistake press .
2. Press  to dial the phone number entered.



3.1.3 Dial one touch numbers 1 to 9

1. Press and hold a key from  to  until the number is displayed and dialled.
 - If no number is stored, you hear a beep.

3.1.4 Call from the phonebook

1. Press . The first entry in the phonebook is displayed.
2. Scroll  or  to the entry you want.
3. Press  to dial the number.





TIP

Instead of scrolling to browse the phonebook entries, press the numeric key corresponding to the first letter of the entry you wish to locate. For example, pressing  will show the entries starting with A. Pressing  again will show the entries starting with B, etc...



3.1.5 Call from the calls list

NOTE

You need to subscribe to your network's Caller Line Identification service to be able to see the caller's number in the calls list. See "Calls list" on page 20 for more details.

1. Press  to enter CALL LOG menu. You have the options to access CALL LIST. Press  to enter CALL LIST. The first entry in the call list is displayed.
2. Scroll  or  to the entry you want.
3. Press  to dial the number.

3.1.6 Answer a call

1. When the phone rings and  flashes in the display, press  or press  to answer the call via the loudspeaker.

WARNING

When the phone is ringing, avoid holding the earpiece too close to your ear as it may damage your hearing. Handsfree activation can suddenly increase the volume in the earpiece to a very high level. Make sure the handset is not too close to your ear.

NOTE

If you have subscribed to your Network's Caller Identity service and assigned a VIP Group to the caller's number, the caller's details are displayed before the phone starts ringing (see "Store an entry" on page 16 and "Group melody" on page 25). You can set your phone to give the default

ringtone as soon as the call is received then once the caller's identity is displayed, the assigned ringtone will start. See "First ring" on page 25.



TIP

If Auto Pick up mode (see page 26) is on, simply lift up the handset from its base to answer the call. The default setting is On.

NOTE



An incoming call has priority over other events. Whenever there is an incoming call, other operations in progress such as phone settings, menu navigation, etc. will be ended.

3.1.7 Adjust volume

1. During a call, press  or  to adjust the earpiece or loudspeaker volume.
 - *The level is shown in the handset display.*

3.1.8 Mute

Mute the microphone so that you can talk to someone else in the room without your caller hearing you.

1. During a call, press 
 - *The microphone is muted.*
2. Press  again to turn the microphone back on.

3.1.9 End a call



1. Press .

After you hang up, the duration the phone is off-hook is displayed for 5 seconds.

NOTE

If auto hang-up is on (see page 26) simply replace the handset on the base to end the call. The default setting is ON.



3.1.10 Switch handset on/off

1. Press and hold  until the handset switches off.
2. Press and hold  again to switch the handset back on.

3.2 Intercom

This feature is only available when there are at least 2 registered handsets. It allows you to make internal calls, transfer external calls from one handset to another and use the conference option.

3.2.1 Call another handset

1. Press 
 - If you have two handsets, the other handset is called automatically.
 - If more than two handsets are registered to the base, their numbers are displayed, e.g. 2345*. Enter the number of the handset you want to call or press  to ring all handsets.
2. Press  to hang up.

NOTE

If the handset does not belong to D1000/1010 range, this function may not be available.



3.2.2 Transfer an external call to another handset

1. During an external call, press .
 - *Your caller is put on hold.*
2. Enter the number of the handset you want to call or press to ring all handsets.
 - *If there are only two handsets, the other handset is called automatically.*
3. When the other handset answers, announce the caller then press to transfer the call. If the other handset does not answer, press to talk to your caller again.

3.2.3 Three-party conference call

1. During an external call, press .
 - *Your caller is put on hold.*
2. Enter the number of the handset you want to call or press to ring all handsets.
 - *If there are only two handsets, the other handset is called automatically.*
3. When the other handset answers, announce the call then press and hold to connect both calls. If the other handset does not answer, press to talk to your caller again.
4. Press to hang up.

4. Phonebook

The D1000 handset phonebook can store up to 100 names and numbers.

NOTE





Numbers can be up to 24 digits long and names up to 12 characters long. Entries are stored in alphabetical order.

4.1 View and dial phonebook entries

1. Press . *Display shows the first entry.*
2. Scroll or to the entry you want.
Or
To search alphabetically, press then press the key with the first letter of the name, e.g. if the name begins with N, press twice.
 - *The display shows the first entry beginning with N. If required, press or to scroll to the exact entry.*
3. Press to dial the entry displayed.

4.2 Store an entry

1. Press . **PHONEBOOK** is displayed.
2. Press . **NEW ENTRY** is displayed.
3. Press . **ENTER NAME** is displayed.
4. Enter a name and press .

- Enter a number. Press  to save. Press  or  to select NO GROUP, GROUP A, B or C and press  to confirm.
- Press  to return to standby.

NOTE

You can assign individual contacts to specific groups of your choice. For example, Group A contains phone numbers of all your co-workers. You can also assign a specific ring melody to that group (see “Group melody” on page 25). You can benefit from this feature only if you have subscribed to Caller Line Identification service from your network provider. If it is the case, every time someone from that group calls you, you will hear the designated ringtone for that group.





NOTE

Cancel storing an entry by pressing  at any time during the process.



4.3 Entering names

Use the alphanumeric keypad to enter names in the phonebook.

For instance to enter the name Paul









- P Press  once
 A Press  once
 U Press  twice
 L Press  three times

To enter a space press 

Press  to delete a character or press and hold  to delete all characters.

4.4 Character map

Use the keypad to enter names and characters.

	Space	1	-	<	>	*
	A	B	C	2		
	D	E	F	3		
	G	H	I	4		
	J	K	L	5		
	M	N	O	6		
	P	Q	R	S	7	
	T	U	V	8	?	
	W	X	Y	Z	9	
	0	-	/	\	#	+









4.5 Enter a pause

If your D1000 is connected to a switchboard, you may need to enter a pause in a stored number. This gives the switchboard time to get an outside line. A Pause is normally stored after the switchboard access code (e.g. 9)





1. When storing a number, press and hold  until the display shows P. You can then continue storing the phone number.

4.6 View an entry



In standby:

1. Press .
2. Enter the first letter of the name to search alphabetically then scroll  or  to the exact entry. The name is displayed.
3. Press  to display the number. If there are more than 12 digits, press  again to see the rest of the number.
4. Press  to return to standby.













During a call:

1. Press  twice to open the phonebook menu.
2. Enter the first letter of the name you want then scroll  or  if necessary to the exact name. Press  to





display the number. If there are more than 12 digits, press  again to see the rest of the number.

3. Press  to cancel the phonebook display.
4. Press  again to end the call.

4.7 Edit an entry





1. Press .
2. Scroll  or  to the entry you want to edit and press . EDIT ENTRY is displayed. Press  again.
3. Edit the name and press  to confirm. Use  to delete characters.
4. Press  and edit the number.
5. Press  to confirm.
6. Scroll  or  to select NO GROUP, GROUP A, B or C and press  to confirm.
7. Press  to return to standby.

4.8 Delete an entry







1. Press .
2. Scroll to the entry you want to delete and press .
3. Scroll  to DELETE ENTRY and press .
4. Display shows CONFIRM?. Press .

5. Press  to return to standby.



4.9 Delete all entries

1. Press  twice.
2. Scroll  to **DELETE ALL** and press .
3. Display shows **CONFIRM?**. Press .
4. Press  to return to standby.

4.10 Copy phonebook to another handset

1. Press  twice.
2. Scroll  to **PB TRANSFER** and press .
3. Scroll  or  to the number of the handset you want the phonebook copied to. Press .



On the receiving handset:

1. **TRANS. FROM: HANDSET X** (where X is the handset number of the sending handset) is displayed.
Press  to start the copying process.
2. When **DONE!** is displayed on both handsets, press  to return to standby.



NOTE

If an entry with the same name and number is already stored in the receiving handset, it will not be copied across.













4.11 One touch keys

The keys  to  enable one touch dialling of entries stored in the phonebook.

4.12 Dial a one touch number













1. Press and hold a number key  to .
- *The number is displayed and dialled.*
2. Press  to cancel the dialling and return to standby.

4.13 Store a phonebook entry as a one touch number

1. Press  twice.
2. Scroll  to **DIRECT MEM** and press .
3. Press  or  to select **KEY 1-9** and press . The current entry, if any, is displayed.
4. Press  again to open the options menu.
5. Press  to **ADD** an entry from the phonebook.
6. Scroll  or  to the entry you want. Press  to confirm or  to return to standby.



4.14 Delete a one touch number

1. Press  twice then scroll  or  to **DIRECT MEM** and press .
2. Scroll  or  to select **KEY 1-9**.
3. Press  to display the current entry. Press  again to open the options menu.
4. Scroll  to **DELETE** and press .
5. Display shows **CONFIRM?**. Press .
6. Press  to return to standby.

5. Caller display and Calls list

If you have subscribed to Caller Line Identification (CLI), and provided the identity of the caller is not withheld, the number of the caller will be displayed together with the date and time of the call (if provided by the network).

NOTE

- If the caller's number is stored in your phonebook along with a name, the name will also be displayed.
- If the telephone number is not available for incoming calls, the handset will display **UNAVAILABLE**.
- Information about incoming calls will vary by country and network operator. Some operators may charge a subscription for their Caller Line Identification service.

5.1 Calls list

The calls list contains details of missed and received call. Details include the date and time of the call. Entries are displayed in chronological order with the most recent call at the top of the list.









NOTE

- When the calls list is full, a new call replaces the oldest in the list.
- The received and missed calls log holds details of up to 50 calls.
- If you receive more than one call from the same number, only the most recent call is kept in the calls list.

When you have missed calls (incoming calls that you haven't answered) the  icon will be displayed in the display on all handsets registered to the base.

If one handset is used to view the calls log, the icon on the other handsets continue to flash (Multipack user only).







5.1.1 View the calls list

1. Press  to enter CALL LOG option menu, then press  to enter CALL LIST.
 - *The most recent number or name if stored in the phonebook is displayed. New calls are marked with  icon flashing.*
2. Scroll  or  through the calls log.
At the end of the log, you will hear a beep.
Press  to see the number. If the number has more than 12 digits, press  to see the rest of the number.
3. Press  to return to standby.















NOTE

The  icon stops flashing once all new calls have been viewed.

5.1.2 Dial from the calls list

1. Press  to enter the CALL LOG option menu, then press  to enter CALL LIST. *The most recent call is displayed.*
2. Scroll  or  to the entry you want.
3. Press  or  to dial.

5.1.3 Save a number from the calls list to the phonebook

1. Press  then . *The most recent call is displayed.*
2. Scroll  or  to the number you want.
3. Press  then scroll  to SAVE NUMBER and press .
4. Press . ENTER NAME is displayed. Use the keypad to enter the name.
5. Press  then the number is displayed, the user can then edit the number if required and must press  to save the number (even if has not been edited).
6. Press  or  to select NO GROUP, GROUP A, B or C and press  to confirm.
7. Display shows CONFIRM?. Press  to confirm.
8. Press  to return to standby.



5.1.4 Delete a calls list entry

1. Press . *The most recent call is displayed.*
2. Scroll or to the number you want.
3. Press then scroll to **DELETE** and press .
4. Display shows **CONFIRM?**. Press to confirm.
5. Press to return to standby.

5.1.5 Delete entire calls list

1. Press . *The most recent call is displayed.*
2. Scroll or to the number you want.
3. Press then scroll to **DELETE ALL** and press .
4. Display shows **CONFIRM?**. Press to confirm.
5. Press to return to standby.

5.2 Redial

The D1000 lets you redial any of the last 10 numbers called. Numbers can be up to 24 digits long.

5.2.1 Redial the last number

1. Press . *The last number dialled is displayed.*
If the number has more than 12 digits, the display shows and the cursor blinks. Press to display the rest.
If the number is stored in the Phonebook, the name is displayed as well.

2. Press to dial.

5.2.2 View and dial a number in the redial list

1. Press . *The last number dialled is displayed.*
If required, scroll or to display the number you want.
2. Press to dial the number.







5.2.3 Copy a redial number to the phonebook

1. Press and scroll or to the entry you want.
2. Press .
3. Display shows **SAVE NUMBER**. Press .
4. Enter the name and press .
5. Edit the number if required and press .
6. Press or to select **NO GROUP**, **GROUP A**, **B** or **C** and press to confirm.
7. Press to return to standby.

5.2.4 Delete a redial list entry

1. Press . Scroll or to display the number you want.
2. Press and scroll to **DELETE** then press .
3. Display shows **CONFIRM?**. Press to confirm, then to return to standby.

5.2.5 Delete entire redial list







1. Press  then press .
2. Scroll  to **DELETE ALL** and press .
3. Display shows **CONFIRM?**. Press  to confirm. Press  to return to standby.

6. Clock & Alarm

If you subscribe to your network's Caller Identification service, the time on your D1000 may be set automatically each time you receive a call, depending on your network provider.

You can also set or adjust the time using the Clock & Alarm menu.

6.1 Set date and time











1. Press  and scroll  to **CLOCK/ALARM**. Press . Display shows **DATE & TIME**, then press .
2. Enter the date using the format **DD/MM** e.g. **04/08** for 4th August.
3. Press  and enter the time using the 24 hour format **HH:MM**, e.g. **14:45** for 2:45pm.
4. Press  to confirm.
5. Press  to return to standby.

NOTE

The date and time is retained during a power failure or when the batteries are discharged.



6.2 Set alarm

1. Press , scroll  to **CLOCK/ALARM** and press .
2. Scroll  to **SET ALARM** and press .
3. Scroll  or  to **OFF, ON ONCE** or **ON DAILY** and press .
4. If you select **ON ONCE** or **ON DAILY**, enter the time using the 24 hour format **HH - MM** e.g 14:45 for 2:45pm and press .
5. Press  to return to standby. When the alarm goes off, press any key to stop the ring.









NOTE

Once the alarm is set to on, the  icon is displayed.

The alarm will ring at the medium level. **ALARM ON** and the  will flash on the display.

6.3 Set alarm melody

There are three alarm ringtones.

1. Press  and scroll  to **CLOCK/ALARM**. Press .
2. Scroll  to **ALARM TONE** and press .
- *Melodies are played.*
3. Scroll  or  and press .

7. Personal settings

7.1 Handset tones

WARNING









When the phone is ringing, avoid holding the earpiece too close to your ear as it may damage your hearing.

7.1.1 Ring volume

Choose from: Ringer Off, Low, Medium, High, Boost and Progressive (increasing ring volume).







NOTE

The default setting is High.

1. Press , scroll  to **PERSONAL SET** and press .
2. **HANDSET TONE** is displayed. Press .
3. **RING VOLUME** is displayed. Press .
4. Scroll  or  to adjust the ringer volume level.
5. Press  to save the settings.
6. Press  to return to standby.

7.1.2 Ring melody

Choose from 10 ringer melodies.

1. Press , scroll  to **PERSONAL SET** and press .
2. **HANDSET TONE** is displayed. Press  and scroll  to **RING MELODY**. Press .



3. Press or to select the ringtone.
- *A sample of the ringtone is played.*
4. Press to confirm.
5. Press to return to standby.

7.1.3 Group melody

To benefit from this feature, you must subscribe to the Caller Line Identification service. This menu enables you to select and set the melodies to be played when there is an external incoming call from a contact whose name is stored in your phonebook and is part of a group. You can associate 1 ring melody to each group. There are three phonebook groups (Group A, B, C) available for you to organize your contacts. Each group can be assigned a unique melody.

1. Press , scroll to **PERSONAL SET** and press .
2. **HANDSET TONE** is displayed. Press and scroll to **GROUP MELODY**. Press .
3. Scroll or to select: **GROUP A, B or C**, then press .
4. Press or to select the ringtone you want for the group and press .
5. Press to return to standby.

7.1.4 Key tones on/off

When you press a key on the handset you hear a beep. You can switch these beeps on or off.

1. Press , scroll to **PERSONAL SET** and press .
2. **HANDSET TONE** is displayed. Press and scroll to **KEY TONE**. Press .
3. Scroll or to select **ON** or **OFF**.
4. Press to confirm.
5. Press to return to standby.

7.1.5 First ring









Your D1000 will automatically detect the Caller identification (Subscription dependent). If you do not wish to hear the ring before the caller identification is displayed you can manually set **FIRST RING** to **OFF**. The default setting is **ON**.

1. Press , scroll to **PERSONAL SET** and press .
2. **HANDSET TONE** is displayed. Press and scroll to **FIRST RING**. Press .
3. Scroll or to select **ON** or **OFF**.
4. Press to confirm.
5. Press to return to standby.













7.2 Handset name

Personalise your handset, with a name or location for example Peter or Bedroom. Maximum 10 characters.

1. Press , scroll  to **PERSONAL SET** and press .
2. Scroll  to **HANDSET NAME** and press . *The current name is displayed.*
3. Press  to delete the current name.
4. Enter the name you want – maximum 10 characters and press  to save.
5. Press  to return to standby.









7.3 Auto pick up

With Auto pick up switched on, you can answer a call just by lifting the handset off the base or charger. If switched off, you will have to press  to answer a call. The default setting is On.

1. Press , scroll  to **PERSONAL SET** and press .
2. Scroll  to **AUTO PICK UP**. Press .
3. Scroll  or  to select **ON** or **OFF**.
4. Press  to confirm.
5. Press  to return to standby.









7.4 Auto hang up

With Auto hang up switched on, you can end a call just by replacing the handset on the base or charger. If switched off, you have to press  to hang up. The default setting is On.

1. Press , scroll  to **PERSONAL SET** and press .
2. Scroll  to **AUTO HANG UP**. Press .
3. Scroll  or  to select **ON** or **OFF**.
4. Press  to confirm.
5. Press  to return to standby.









7.5 Display language

You can change the display language.

1. Press , scroll  to **PERSONAL SET** and press .
2. Scroll  to **LANGUAGE**. Press .
3. Scroll  or  to select the language you want.
4. Press  to confirm.
5. Press  to return to standby.

7.6 Room Monitor on/off

Leave one handset in a room and use another handset to hear sounds in that room.

1. Press , scroll  to **PERSONAL SET** and press .
2. Scroll  to **ROOM MONITOR**. Press .
3. Press  or  to select **ON** or **OFF**.
4. Press  to confirm.

When switched On, you can leave this handset in the room you wish to monitor. Only the microphone is on. Anyone in the room cannot hear you.

7.7 Room Monitor

1. Switch a handset's room monitor mode setting On and place that handset in the room.
2. At a second handset, press  and enter the number of the handset you are using as a room monitor. You can now hear sounds coming from the room.

TIP

To stop room monitoring at any time, press .









NOTE

If you have only registered 2 handsets with the base unit, in step 2 above Room Monitor will be automatically activated without entering the handset number.

WARNING



This product is not intended for use as a baby safety device and is not a substitute for adult supervision.

7.8 Backlight on/off

1. Press , scroll  to **PERSONAL SET** and press .
2. Scroll  to **BACKLIGHT**. Press .
3. Press  or  to select **ON** or **OFF**.
4. Press  to confirm.

7.9 Keypad lock

Prevent accidental dialling while carrying the handset by locking the keypad.

1. Press and hold .
 - *The display shows KEYS LOCKED.*
2. To unlock the handset, press and hold  again.

NOTE

While the keypad is locked, you can answer incoming calls as normal.











8. Advanced settings

This setting is useful to access certain network and PABX/switchboard services.

8.1 Recall time

The default D1000 recall time is suitable for your country and network operator. It is unlikely that you should need to change this setting unless advised to do so.

1. Press , scroll  to **ADVANCED SET** and press .
2. **RECALL TIME** is displayed. Press .
3. Press  or  to select the setting you want: **SHORT**, **MEDIUM**, **LONG**.
4. Press  to confirm.
5. Press  to return to standby.





NOTE

The use of your D1000 cannot be guaranteed on all PABX.

8.2 Dial mode

The default D1000 dialling mode is suitable for your country and network operator. It is unlikely that you should need to change this setting unless advised to do so.

1. Press , scroll  to **ADVANCED SET** and press .
2. Scroll  to **DIAL MODE**. Press .

3. Press  or  to select **TONE** or **PULSE**.
4. Press  to confirm.
5. Press  to return to standby.

8.2.1 Temporarily switch from Pulse to Tone dialling

1. Press and hold .

The dial mode will change from Pulse to Tone for the duration of the call.

8.3 Call barring







Prevent certain numbers from being dialled from your D1000. Store up to four specific numbers, each up to 4 digits – for example, international or local prefixes.





Bypass call barring by switching the setting Off or On.

NOTE













If you switch Call barring on, **BARR MODE ON** will be displayed on your screen in standby mode.

8.3.1 Switch call barring on/off

1. Press , scroll  to **ADVANCED SET** and press .
2. Scroll  to **CALL BARRING**. Press .
3. Enter the master PIN (default setting 0000) and press .
4. **MODE** is displayed. Press .

5. Press  or  to select ON or OFF. Press  to confirm.
6. Press  to return to standby. You can now set the number (See below).

8.3.2 Set a number to be barred







1. Press , scroll  to **ADVANCED SET** and press .
2. Scroll  to **CALL BARRING**. Press .
3. Enter the master PIN (default setting 0000) and press .
4. Scroll  to **NUMBER**. Press .
5. If necessary, scroll  or  to the next available slot.
6. Press  and enter the number or prefix you want to bar. Press  to confirm.
7. Press  to return to standby.

8.4 Easy call

When activated, this feature allows you to dial a number by pressing any key on your handset (except ). This feature is very useful for access to emergency services.

8.4.1 Switch easy call on/off



1. Press , scroll  to **ADVANCED SET** and press .
2. Scroll  to **EASY CALL**. Press .

3. Enter the master PIN (default setting 0000) and press .
4. **MODE** is displayed. Press  then press  or  to select ON or OFF. Press  to confirm.
5. Press  to return to standby.











NOTE

If you switch Easy call on, **EASY CALL ON** will be displayed on your screen in standby mode.

To switch Easy call off again:

1. Press .
2. **OFF?** is displayed. Press  to confirm.

8.4.2 Set the easy call number

1. Press , scroll  to **ADVANCED SET** and press .
2. Scroll  to **EASY CALL**. Press .
3. Enter the master PIN (Default setting 0000) and press .
4. Scroll  to **NUMBER**. Press .
5. Enter the number. Press  to confirm.
6. Press  to return to standby.



8.4.3 Dial an easy number

When an easy call number has been stored and the easy call setting switched on, press any key (apart from ) to dial a number.

NOTE

When easy call is switched on, you can still answer any incoming call as normal.

8.5 Registration

Up to 5 handsets can be registered to one base station. Additional handsets must be registered to the base before you can use them.











- The instructions described below apply specifically to your D1000 handset. If you wish to register another manufacturer's handset, the instructions may vary. In this case, please refer to the manufacturer of the additional handset.
- The Master PIN is required before you can register or unregister handsets. The default PIN is 0000.

8.6 Register a handset

At the base:

1. Press and hold the  button on the base station for at least 3 seconds. The base station emits a beep when it is ready to accept registration. You have 90 seconds in which to register a handset.







At the handset:

1. Press  and scroll  to **ADVANCED SET** and press .
2. Scroll  to **REGISTRATION** and press .
3. If necessary, scroll  or  to display **REGIST. BASE** and press . **BASE 1 2 3 4** is displayed and *the registered base number is flashing*. Enter the number of the base on which you wish to register your handset.
If you have only 1 base station, press . If you have 2 base stations, press  or , etc.
4. When the display shows **PIN----**, enter the base PIN.
 - *When the handset registers with the base, it is assigned a handset number.*











8.7 Select a base

You can register your D1000 handset with up to 4 bases. Once registered, you can switch between bases, for example, bases at home and at work.







1. Press  and scroll  to **ADVANCED SET** and press .
2. Scroll  to **REGISTRATION** and press .
3. **SELECT BASE** is displayed. Press 
 - *The available bases are displayed with the current base number flashing.*
4. Enter the number of the base you want – 1,2,3 or 4 and press 
 - *When the base is found you hear a beep. If not found, the display shows **UNREGISTERED**.*

8.8 Unregister a handset

1. Press  and scroll  to **ADVANCED SET** and press .
2. Scroll  to **UNREGISTER** and press .
3. Enter the 4 digit master PIN and press 
 - *Display shows the registered handset numbers.*
4. Scroll  or  to select the handset you want to delete and press 
 - **UNREGISTERED** is displayed on the handset screen.

8.9 PIN

The 4-digit master PIN is used when registering or unregistering a handset and when changing some settings on your D1000. The default setting is 0000. You can change this PIN for more security.





1. Press , scroll  to **ADVANCED SET** and press .
2. Scroll  to **PIN**. Press .
3. Enter the current 4 digit master PIN and press 
(Default setting 0000).
4. Enter the new PIN and press .

NOTE

Make a note of your PIN. If you forget your PIN you will need to reset your product.

8.10 Reset

This will reset your D1000 to its default settings.

1. Press , scroll  to **ADVANCED SET** and press .
2. Scroll  to **RESET UNIT**. Press .
3. **CONFIRM?** is displayed. Press .

NOTE

Entries stored in the phonebook are retained. After reset, depending on your country, the welcome mode setting may be shown on the handset display.













8.11 Default settings

Handset name	Handset
Key tone	On
First ring	On
Auto pick up	On
Auto hang up	On
Ringer melody	Melody 1
Ringer volume	High
Earpiece volume	3
Phonebook	Unchanged
Call log	Empty
Redial list	Empty
Master PIN	0000
Keypad lock	Off
Clock	00:00
Alarm	Off
Dial mode	Tone

8.12 Auto prefix

You can set the D1000 to detect a dialling number and replace it with another number. The number to be detected can be up to 5 digits long. It can be replaced with a number up to 10 digits.

1. Press , scroll  to **ADVANCED SET** and press .
2. Scroll  to **PREFIX**. Press .
3. **DETECT DIGIT** is displayed. Press .
4. Enter the number you want to be detected and press .
5. Scroll to **PREFIX NUM.** and press .
6. Enter the number you want it replaced with and press .
7. Press  to return to standby.

8.13 Country









If you move to another country you can set your phone to be compatible with the network settings of that country.

NOTE

If you make a mistake during welcome mode country selection, you can also reset your country.

*Depending on your country, this option may be displayed as **NOT AVAILABLE** or you country may not be displayed.*











1. Press , scroll  to **ADVANCED SET** and press .
2. Scroll  to **SEL. COUNTRY**. Press .
3. Enter the 4-digit master PIN and press .
4. Scroll  or  to display the required country.
5. Press  to confirm.

8.14 Intrusion

When an external call is taking place, another handset registered to the base can join in, making the call a 3-way conference, just by pressing .









To enable this, Intrusion must be switched On.

1. Press , scroll  to **ADVANCED SET** and press .
2. Scroll  to **INTRUSION**. Press .
3. Scroll  or  to **ON** or **OFF**.
4. Press  to confirm.
5. Press  to return to standby.

8.15 ECO mode

To reduce the level of power emissions, you can select low power or ECO mode. When the ECO mode is set to **ON**, the base transmission power will be reduced.

To turn ECO Mode to **ON** or **OFF**:

1. Press , scroll  to **ADVANCED SET** and press .
2. Scroll  to **ECO MODE** and press .
3. Press  or  to highlight **ON** or **OFF** then press  to confirm.
 - A confirmation beep is emitted and the handset display will switch between the handset's name and **ECO MODE**.

NOTE

When Eco Mode is set to **ON**, the handset range will be reduced.

9. Help

Charging

The  icon is not scrolling when the handset is placed on the base

- Bad battery contact – move the handset slightly
- Dirty contact – Clean the battery contact with a cloth moistened with alcohol
- Battery is full – no need to charge

Calls

No dialling tone

- No power – check the connections. Reset the phone: unplug and plug back in the mains
- Batteries are empty – charge the batteries for at least 24 hours
- You are too far from the base – move closer to the base
- Wrong line cable – use the line cable provided
- Line adaptor (when needed) is not connected to the line cord – connect the line adaptor (when needed) to the line cord

Poor audio quality

The base is too close to electrical appliances, reinforced concrete walls or metal doorframes – move the base at least one metre away from any electrical appliances

The icon is blinking

- Handset is not registered to the base – register the handset to the base
- You are too far from the base – move closer to the base
- Switch OFF the Eco mode.

No ring tone

- The ring tone is deactivated.
- Increase the volume.

Caller Line Identification (CLI) service does not work

Check your subscription with your network operator

Phonebook

A phonebook entry cannot be stored

The phonebook is full. Delete an entry to free memory

Display

No display

- Try recharging or replacing the batteries.
- Try disconnecting and connecting the base power supply.
- If LED is not lit up, then try disconnecting and connecting the base power supply.

Registration

Unable to register another handset

- Maximum number of 5 handsets has been reached.
- The display shows **SEARCHING**. You must unregister a handset in order to register a new one.

Handset display shows **NOT REG**

- Please refer to page 30 of the user guide to re-register your handset to the base.

Interference

Noise interference on your radio or television

Your base or charger may be too close. Move it as far away as possible.

10. General information

IMPORTANT

This equipment is not designed for making emergency telephone calls when the power fails. Alternative arrangements should be made for access to emergency services.

This product is intended for connection to analogue public switched telephone networks and private switchboards in Singapore.

Important safety instructions

Follow these safety precautions when using your phone to reduce the risk of fire, electric shock, and injury to persons or property:

1. Keep all slits and openings of the phone unblocked. Do not set the phone on a heating register or over a radiator. Ensure that proper ventilation is provided at the installation site.
2. Do not use while wet or while standing in water.
3. Do not use this product near water (for example, near a bath tub, kitchen sink, or swimming pool).
4. Do not allow anything to rest on the power cord. Place the power cord so that it will not be walked on.
5. Never insert objects of any kind into the product vents as that may result in fire or electric shock.



6. Unplug this product from the wall outlet before cleaning. Do not use liquid cleaners or aerosol cleaners. Use a damp cloth for cleaning.
7. Do not disassemble this product. If service or repair work is required, contact the customer service helpline found in this user's Guide.
8. Do not overload wall outlets and extension cords.
9. Avoid using during an electrical storm. Use a surge protector to protect the equipment.
10. Do not use this phone to report a gas leak, especially if you are in the vicinity of the gas line.

CAUTION

To reduce the risk of fire, use only the supplied power adaptor.

Unplug this cordless phone immediately from an outlet if:

- The power cord or plug is damaged or frayed.
- Liquid has been spilled on the product.
- The product has been exposed to rain or water. Do not retrieve the handset or base until after you have unplugged the power and phone from the wall. Then retrieve the unit by the unplugged cords.
- The product has been dropped or the cabinet has been damaged.
- The product exhibits a distinct change in performance.

Installation Guidelines

1. Read and understand all instructions and save them for future reference.
2. Follow all warnings and instructions marked on the product.
3. Do not install this product near a bath tub, sink, or shower.
4. Operate this phone using only the power source that is indicated on the marking label. If you are unsure of the power supply to your home, consult with your dealer or local power company.
5. Do not place this product on an unstable cart, stand, or table. This product may fall, causing serious damage to the product.
6. Adjust only those controls that are covered by the operating instructions. Improper adjustment of other controls may result in damage and will often require extensive work to restore the product to normal operation.
7. Clean this product with a soft, damp cloth. Do not use chemicals or cleaning agents to clean this phone.
8. Use only the power supply that came with this unit. Using other power supplies may damage the unit.
9. Because this phone operates on electricity, you should have at least one phone in your home that could operate without electricity in the case the power in your home goes out.

10. To avoid interference to nearby appliances, do not place the base of the phone on or near a TV, microwave oven, or VCR.

Battery Safety Instructions

- Do not burn, disassemble, mutilate, or puncture the battery. The battery contains toxic materials that could be released, resulting in injury.

CAUTION

- There is a risk of explosion if you replace the battery with an incorrect battery type. Use only the battery pack that came with your phone or an authorized replacement recommended by the manufacturer.
- Keep battery packs out of the reach of children.
- Remove battery packs if storing over 30 days.
- Do not dispose of battery packs in fire, which could result in explosion.
- The rechargeable battery packs that power this product must be disposed of properly and may need to be recycled. Refer to your battery's label for battery type. Contact your local recycling center for proper disposal methods.

SAVE THESE INSTRUCTIONS

Cleaning

- Clean the handset and base (or charger) with a damp (not wet) cloth, or an anti-static wipe.

- Never use household polish as this will damage the product. Never use a dry cloth as this may cause a static shock.

Environmental

- Do not expose to direct sunlight.
- The handset may become warm when the batteries are being charged or during prolonged periods of use. This is normal. However, we recommend that to avoid damage you do not place the product on antique/veneered wood.
- Do not stand your product on carpets or other surfaces which generate fibres, or place it in locations preventing the free flow of air over its surfaces.
- Do not submerge any part of your product in water and do not use it in damp or humid conditions, such as bathrooms.
- Do not expose your product to fire, explosive or other hazardous conditions.
- There is a slight chance your phone could be damaged by an electrical storm. We recommend that you unplug the power and telephone line cord during an electrical storm.

Product disposal instructions

- **European Union (EU) Waste of Electrical and Electronic Equipment (WEEE) directive**
The European Union's WEEE directive requires that products sold into EU countries must have the crossed



out trashbin label on the product (or the package in some cases). As defined by the WEEE directive, this crossed-out trashbin label means that customers and end-users in EU countries should not dispose of electronic and electrical equipment or accessories in household waste. Customers or end-users in EU countries should contact their local equipment supplier representative or service centre for information about the waste collection system in their country.

- The Waste of Electrical and Electronic Equipment (WEEE) Directive (2002/96/EC) has been put in place to recycle products using best available recovery and recycling techniques to minimize the impact on the environment, treat any hazardous substances and avoid the increasing landfill.

Product disposal instructions for residential users

When you have no further use for it, please remove any batteries and dispose of them and the product per your local authority's recycling processes. For more information please contact your local authority or the retailer where the product was purchased.

Product disposal instructions for business users

Business users should contact their suppliers and check the terms and conditions of the purchase contract and ensure that this product is not mixed with other commercial waste for disposal.

Consumer Products and Accessories Warranty

Thank you for purchasing this Motorola branded product manufactured under license by Suncorp Technologies Limited, 3001-3005 China Resources Building, 26 Harbour Road, Wan Chai, Hong Kong. ("Suncorp")

What Does this Warranty Cover?

Subject to the exclusions contained below, SUNCORP TECHNOLOGIES LTD. warrants that this Motorola branded product ("Product") or certified accessory ("Accessory") sold for use with this product that it manufactured to be free from defects in materials and workmanship under normal consumer usage for the period outlined below. This Limited Warranty is your exclusive warranty and is not transferable.

Who is covered?

This warranty extends only to the first consumer purchaser, and is not transferable.

What will SUNCORP TECHNOLOGIES LTD do?

SUNCORP TECHNOLOGIES LTD or its authorized distributor at its option and within a commercially reasonable time, will at no charge repair or replace any Products or Accessories that does not conform to this limited warranty. We may use functionally equivalent reconditioned/ refurbished/ pre-owned or new Products, Accessories or parts.

What Other Limitations Are There?

ANY IMPLIED WARRANTIES, INCLUDING WITHOUT LIMITATION THE IMPLIED WARRANTIES OF MERCHANTABILITY AND FITNESS FOR A PARTICULAR PURPOSE, SHALL BE LIMITED TO THE DURATION OF THIS LIMITED WARRANTY, OTHERWISE THE REPAIR OR REPLACEMENT PROVIDED UNDER THIS EXPRESS LIMITED WARRANTY IS THE EXCLUSIVE REMEDY OF THE CONSUMER, AND IS PROVIDED IN LIEU OF ALL OTHER WARRANTIES, EXPRESS OF IMPLIED. IN NO EVENT SHALL MOTOROLA OR SUNCORP TECHNOLOGIES LTD BE LIABLE, WHETHER IN CONTRACT OR TORT (INCLUDING NEGLIGENCE) FOR DAMAGES IN EXCESS OF THE PURCHASE PRICE OF THE PRODUCT OR ACCESSORY, OR FOR ANY INDIRECT, INCIDENTAL, SPECIAL OR CONSEQUENTIAL DAMAGES OF ANY KIND, OR LOSS OF REVENUE OR PROFITS, LOSS OF BUSINESS, LOSS OF INFORMATION OR OTHER FINANCIAL LOSS ARISING OUT OF OR IN CONNECTION WITH THE ABILITY OR INABILITY TO USE THE PRODUCTS OR ACCESSORIES TO THE FULL EXTENT THESE DAMAGES MAY BE DISCLAIMED BY LAW.

Some jurisdictions do not allow the limitation or exclusion of incidental or consequential damages, or limitation on the length of an implied warranty, so the above limitations or exclusions may not apply to you. This warranty gives you specific legal rights, and you may also have other rights that vary from one jurisdiction to another.

Products Covered	Length of Coverage
Consumer Products	One (1) year from the date of the products original purchase by the first consumer purchaser of the product.
Consumer Accessories (battery, power supply(s) and line cords)	Ninety (90) days from the date of the accessories original purchase by the first consumer purchaser of the product.
Consumer Products and Accessories that are Repaired or Replaced	The balance of the original warranty or for ninety (90) days from the date returned to the consumer, whichever is longer.

Exclusions

Normal Wear and Tear. Periodic maintenance, repair and replacement of parts due to normal wear and tear are excluded from coverage.



Batteries. Only batteries whose fully charged capacity falls below 80% of their rated capacity and batteries that leak are covered by this limited warranty.

Abuse & Misuse. Defects or damage that result from: (a) improper operation, storage, misuse or abuse, accident or neglect, such as physical damage (cracks, scratches, etc.) to the surface of the product resulting from misuse; (b) contact with liquid, water, rain, extreme humidity or heavy perspiration, sand, dirt or the like, extreme heat, or food; (c) use of the Products or Accessories for commercial purposes or subjecting the Product or Accessory to abnormal usage or conditions; or (d) other acts which are not the fault of Motorola or SUNCORP TECHNOLOGIES LTD., are excluded from coverage.

Use of Non-Motorola branded Products and Accessories. Defects or damage that result from the use of Non-Motorola branded or certified Products or Accessories or other peripheral equipment are excluded from coverage.

Unauthorized Service or Modification. Defects or damages resulting from service, testing, adjustment, installation, maintenance, alteration, or modification in any way by someone other than Motorola, SUNCORP TECHNOLOGIES LTD. or its authorized service centers, are excluded from coverage.

Altered Products. Products or Accessories with (a) serial numbers or date tags that have been removed, altered or

obliterated; (b) broken seals or that show evidence of tampering; (c) mismatched board serial numbers; or (d) nonconforming or non-Motorola branded housings, or parts, are excluded from coverage.

Communication Services. Defects, damages, or the failure of Products or Accessories due to any communication service or signal you may subscribe to or use with the Products or Accessories is excluded from coverage.

How to Obtain Warranty Service or Other Information?

To obtain service or information, please call: **(65) 6841 2668**
Email: **support@alcom.com.sg**

You will receive instructions on how to ship the Products or Accessories at your expense, to SUNCORP TECHNOLOGIES LTD. It is the responsibility of the purchaser to contact the nearest authorised service center/distributor and bring the product at the purchaser's risk to that authorised service center.

Authorized Repair Center

To obtain service, you must include: (a) the Product or Accessory; (b) the original proof of purchase (receipt) which includes the date, place and seller of the Product; (c) if a warranty card was included in your box, a completed warranty card showing the serial number of the Product; (d) a written description of the problem; and, most importantly; (e) your address and telephone number.

Technical Information

How many telephones can I have?

All items of telephone equipment have a Ringer Equivalence Number (REN), which is used to calculate the number of items which may be connected to any one telephone line. Your D1000 has a REN of 1. A total REN of 4 is allowed. If the total REN of 4 is exceeded, the telephones may not ring. With different telephone types there is no guarantee of ringing, even when the REN is less than 4.

Any additional handsets and chargers that you register have a REN of 0.

R&TTE

This product is intended for use within Singapore for connection to the public telephone network and compatible switchboards.

This equipment complies with the essential requirements for the Radio Equipment and Telecommunications Terminal Equipment Directive 1999/5/EC including compliance with ICNIRP standard for electromagnetic energy exposure.

Connecting to a switchboard

This product is intended for use within Singapore for connection to the public telephone network.

Inserting a pause

With some switchboards, after dialling the access code you may have to wait for a moment while the switchboard picks up an outside line so you will need to enter a pause in the dialing sequence.

Press and hold  to insert a pause (P) before entering the telephone number.

You may also need to enter a pause when storing international numbers or charge card numbers.

Recall

You may need to use the recall function if you are connected to a switchboard/PABX (Private Automatic Branch Exchange), contact your PABX supplier for further information.

12. Wall mounting

IMPORTANT

Before you wall-mount your D1000, check that you are not drilling into any hidden wiring or pipes.

Before you drill, make sure the power and telephone line cables will reach the sockets.

1. Use the following templates to mark the drilling locations.
 - To wall-mount the base, drill two holes in the wall 4.5cm apart horizontally using an 8mm drill bit.

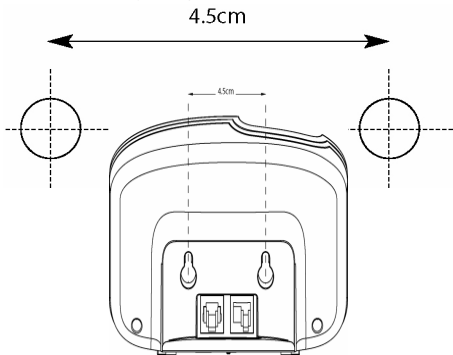

- To wall-mount the charger, drill two holes in the wall 3.2cm apart horizontally using an 8mm drill bit.

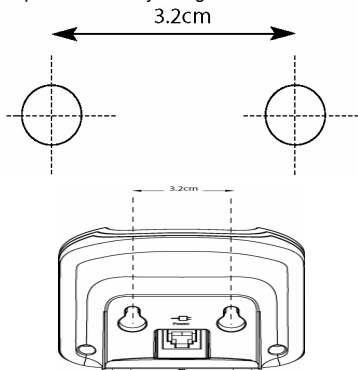



2. Insert the wall plugs if necessary, then insert the screws leaving about 5mm protruding from the wall on which to hang the phone.

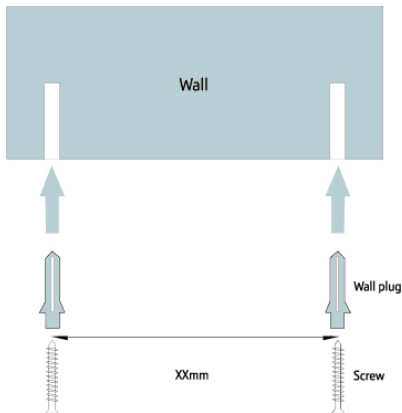

3. Pull the base/charger out of the stand and slot the holes on the back of the base over the screw heads and gently pull the base/charger down to make sure it is securely in place.

Declaration of Conformity (Doc)

Suncorp declares that the following products:

Brandname: Motorola
Type: D1001, D1002, D1003, D1004, D1011, D1012, D1013 and D1014
Descriptions: DECT phone with telephone answering machine (D100x) and without telephone answering machine (D101x), and their multi-handset versions.

to which this declaration related is in conformity with the essential requirements of the following directives of the Council of the European Communities:

- R&TTE Directive (1999/5/EC)
- Ecodesign Directive (2005/32/EC)

The products are compliant with the following standards:

Safety: EN60950-1:2006
EMC: EN301489-1 v1.6.1 and EN301489-6 v1.2.1
RF Spectrum: EN301406 v1.5.1
Ecodesign: EC No 278/2009, 6 April 2009

For and on behalf of Suncorp Global Limited,

CW
2010.05.03 19:49:52 +08'00'

Signature:



Printed name & Position: CW Cheung - Chief Technical Officer

Date: 3rd May 2010

Place: 3001-3005 China Resources Building, 26 Harbour Road,
Wan Chai, Hong Kong



Manufactured, distributed or sold by Suncorp Technologies Ltd. , official licensee for this product. MOTOROLA and the Stylized M Logo are trademarks or registered trademarks of Motorola Trademark Holdings, LLC. and are used under license. All other trademarks are the property of their respective owners.

© 2012 Motorola Mobility, Inc. All rights reserved.

Version 5 (SG)



Free Manuals Download Website

<http://myh66.com>

<http://usermanuals.us>

<http://www.somanuals.com>

<http://www.4manuals.cc>

<http://www.manual-lib.com>

<http://www.404manual.com>

<http://www.luxmanual.com>

<http://aubethermostatmanual.com>

Golf course search by state

<http://golfingnear.com>

Email search by domain

<http://emailbydomain.com>

Auto manuals search

<http://auto.somanuals.com>

TV manuals search

<http://tv.somanuals.com>