



MOTOROLA

Motorola D110 series

**Digital Cordless Phone with
Answer Machine**

Warning

*Use only rechargeable batteries.
Charge the handset for 24 hours before use.*

Welcome...

to your new Motorola D1111 Digital Cordless Phone!

- Wall mountable freedom base – all handsets fully cordless for locating anywhere within range.
- 1.6" colour display.
- 100 Name and number phonebook.
- Copy phonebook entries between other handsets.
- Screensaver clock display.
- Answer machine with 12 minutes digital recording time.
- Send and receive text messages.¹
- Caller Display shows you who's calling and see details of the last 30 callers in a Calls list.²
- Register up to 5 handsets to a single base and register each handset with up to 4 different bases.
- Make internal calls, transfer external calls, hold 3-way conversation between two internal callers and an external caller.

¹ You must subscribe to your network provider's Caller Display Service for text messaging to work and you must not withhold your telephone number. A quarterly fee may be payable. Some other network provider lines may not be compatible with this text messaging service.

² You must subscribe to your network provider's Caller Display or Call Waiting service for these features to work. A quarterly fee may be payable.

Please note that this equipment is not designed for making emergency telephone calls when the power fails. Alternative arrangements should be made for access to emergency.

This User Guide provides you with all the information you need to get the most from your phone.

***Before you make your first call you will need to set up your phone.
Follow the simple instructions in 'Getting Started', on the next few pages.***

IMPORTANT

Only use the telephone line cord supplied.

This equipment is not designed for making emergency telephone calls when the power fails. Alternative arrangements should be made for access to emergency services.

Got everything?

- D1111 handset
- D1111 base
- Quick start guide
- 2 x AAA NiMH rechargeable batteries
- Mains power adaptor for the base
- Telephone line cord
- Wall mounting screws and wall plugs

If you have purchased a D1111 multiple pack you will also have the following additional items:

- D1111 handset & charger
- 2 x AAA NiMH rechargeable batteries
- Mains power adaptor for the charger

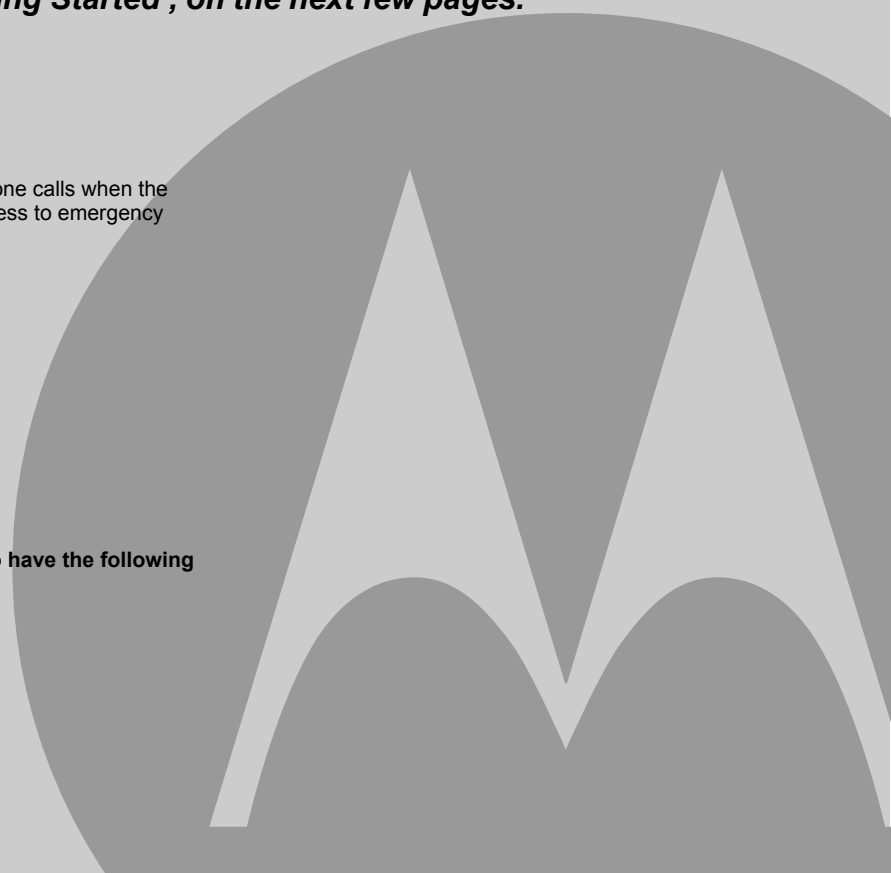

1. Getting started.....	6	Copy an entry to another handset.....	16
Location.....	6	Copy the entire phonebook to another handset.....	16
Setting up.....	6	Memory status.....	16
Connecting up the large base.....	6	4. Handset settings.....	17
Connecting the handset and charger (Multi-pack only).....	6	Handset ringtone.....	17
Set date and time manually.....	7	Handset ringer volume.....	17
2. Getting to know your phone.....	8	Receiver volume.....	17
Overview of your handset.....	8	Handset name.....	17
Handset Display.....	9	Wallpaper.....	17
Display icons.....	9	Menu colour.....	17
Overview of the base.....	9	Screensaver.....	18
Navigating the menus.....	10	Light timeout.....	18
Menu map.....	11	Display contrast.....	18
Character map.....	12	Auto talk.....	18
3. Using the phone.....	13	Key beep.....	18
Switch the handset on / off.....	13	PABX access code.....	18
Make a call.....	13	5. Base settings.....	19
Preparatory dialling.....	13	Base ringtone.....	19
End a call.....	13	Base ringer volume.....	19
Receive a call.....	13	Dialling mode.....	19
Adjust the earpiece/receiver volume.....	13	Ring priority.....	19
Secrecy.....	13	Recall mode.....	19
Call another handset.....	13	First ring.....	19
Transfer a call.....	13	System PIN.....	20
3-way conference call.....	13	Restore default settings.....	20
Make a handsfree call.....	14	Default settings.....	20
Answer a call in handsfree.....	14	ECO mode.....	21
Redial a number from the redial lists.....	14	6. Clock & alarm.....	21
Save a number from the redial list to the phonebook.....	14	Date & time.....	21
Delete a redial number/delete all redial.....	14	Set alarm.....	21
To lock the keypad.....	14	Alarm on /off.....	21
Paging/Find handset.....	14	Switch off alarm ring.....	22
Store a name and number.....	15	Time format.....	22
Open the phonebook during a call.....	15	7. Event Reminder.....	22
View an entry.....	15	Add a new event.....	22
Dial an entry.....	15	Switch off reminder ring.....	22
Edit a name and number.....	15	Show reminder details.....	23
Edit ringtone.....	16	Edit reminder.....	23
Delete an entry.....	16	Send reminder as a text message.....	23
Delete entire phonebook.....	16		

Delete reminder	23	13. Text messaging	31
Delete all reminders	23	Subscribe to the text messaging service	31
8. Calls lists	24	Send a text message	31
Caller Display	24	Standard text entry	32
Calls lists	24	Receiving and reading text messages	32
New calls alert	24	Read a new message	32
View new missed calls	24	Read, forward, delete, view and save numbers of texts	
View and dial from a Calls list	24	in the Inbox	33
Copy a Calls list number to the phonebook	24	Edit or send texts in the Drafts box	33
Send a text message to a Calls list number	25	Forward or delete texts in the Outbox	33
Delete an entry	25	Edit templates	33
Delete all entries	25	Deleting texts	34
9. Call Waiting	25	Add or change Service Centre numbers	34
10. Voicemail	25	Set send centre	34
11. Room Monitor	26	Message alert tone	34
To switch Room Monitor On	26	Set message size	34
To change the monitor level	26	Add a user mailbox	34
To set the dial out number	26	Open and read a mailbox text	35
12. Answer machine	27	Edit a user mailbox	35
Base control keys	27	Delete a user mailbox	35
Switch the answer machine on / off	27	Set common mailbox sub address	35
Answer delay	27	14. Using additional handsets	36
Switch message alert tone on / off	27	Registering an additional handset	36
On-screen alert	28	Select a base	36
Record your own outgoing message	28	De-register a handset	36
Voice prompts or outgoing message language	28	15. Help	37
Check or delete your outgoing message	28	16. General information	38
Select outgoing message mode	29	Safety and Electromagnetic Interference/Compatibility	
Record a memo	29	information	38
Call screening	29	Cleaning	39
Message playback	29	Environmental	39
Delete all old messages	29	Product disposal instructions	39
Switch remote access On or Off	30	Warranty Information	40
Change the remote access PIN	30	R&TTE	40
Switch your answer machine on remotely	30	Declaration of Conformance	40
Operating your answer machine from another phone	30	Connecting to a switchboard	40
		Inserting a pause	40
		Recall	41
		17. Wall mounting	41

1. Getting started

WARNING

Do not place your D1111 in the bathroom or other humid areas.

Location

You need to place your D1111 base within 2 metres of the mains power socket and telephone socket so that the cables will reach.



Make sure it is at least 1 metre away from other electrical appliances to avoid interference. Your D1111 works by sending radio signals between the handset and base. The strength of the signal depends on where you place the base. Putting it as high as possible ensures the best signal.

To wall mount your D1111 base, see "Wall mounting" on page 41.

HANDSET RANGE

The D1111 has a range of 300 metres outdoors when there is a clear line of sight between the base and handset. Any obstruction between the base and handset will reduce the range significantly. With the base indoors and handset either indoors or outdoors, the range will normally be up to 50 metres. Thick stone walls can severely affect the range.

SIGNAL STRENGTH

The  icon on your handset indicates when you are in range. When out of range of the base, the screen shows Searching... and the  flashes. During call, if the handset goes out of range the handset will emit out of range warning tone.

If you are on a call, the line will hang up if the handset moves out of range of the base. Move back within in range. The handset will automatically re-connect to the base.

Setting up

IMPORTANT

The base station must be plugged into the mains power at all times. Do not connect the telephone line cord into the wall socket until the handset is fully charged. Only use the power and telephone cables supplied with the product.

WHICH POWER ADAPTOR?

The power adaptor with a clear connector is for the base unit and the power adaptor with a red colour connector is for the charger unit.

Connecting up the large base

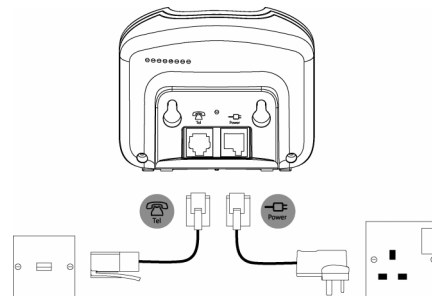



Plug the power adaptor with clear connector into the socket marked  on the underside of the base and plug the other end into the mains power wall socket and switch the power on.

Connecting the handset and charger (Multi-pack only)

If you have purchased a multiple pack, this process will need to be carried out for all handsets and chargers:

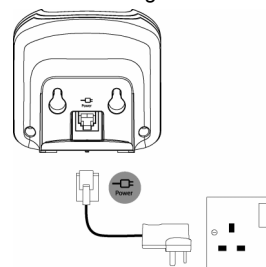
1. Plug the power adaptor with red connector into the socket marked  on the underside of the charger.



2. Insert the 2 x AAA NiMH batteries supplied into the handset. Then slide the compartment cover into place.
3. Place the handset on the charger to charge for at least 24 hours. When the handset is fully charged the  icon will indicate that it is fully charged.
4. When the handset is fully charged after 24 hours, plug the telephone line cord from the large base into the telephone wall socket.

IMPORTANT

*Warning! Use only rechargeable batteries. If non-rechargeable batteries are used **WRONG BATTERY** will be displayed and charging will be stopped. Please replace with rechargeable batteries.*

BATTERY LOW WARNING

If the  icon shows a red segment in the display, you will need to recharge the handset before you can use it again.

During charging, the  icon will scroll in the display.

BATTERY PERFORMANCE

In ideal conditions, fully charged batteries should give about 10 hours talk time or 100 hours standby time on a single charge.

Note that new batteries do not reach full capacity until they have been in normal use for several days.

To keep your batteries in the best condition, leave the handset off the base for a few hours at a time.

Running the batteries right down at least once a week will help them last as long as possible.

The charge capacity of rechargeable batteries will reduce with time as they wear out, giving the handset less talk/standby time. Eventually they will need to be replaced.

After charging your handset for the first time, subsequent charging time is about 6–8 hours a day. Batteries and handset may become warm during charging. This is normal.



Date and time

Providing you have subscribed to your network's Caller Display service, the date and time is set automatically for all handsets when you receive your first call.

The date and time is recorded with each answer machine message you receive.

If you do not have a Caller Display service you can set the date and time manually.

Set date and time manually

1. Press Menu and scroll  or  to Clock & Alarm then press Select.
2. Date & Time is highlighted. Press Select.
3. Enter the date using the format DD/MM/YY e.g. 01 09 08 for 1st September 2008. Enter the time in 12 or 24 hour time format. Press Save. To change the Time Format see page 22.
4. Press  or Back until you return to standby.

Your D1111 is now ready for use.

2. Getting to know your phone

Overview of your handset

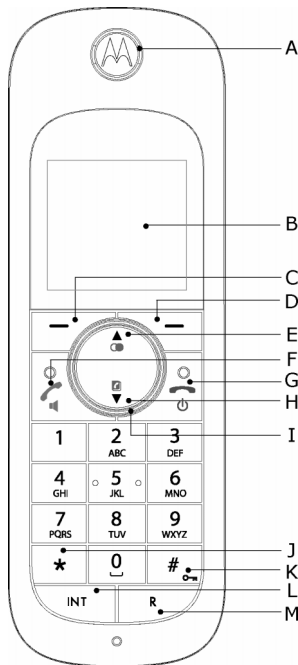

A Earpiece

B Display

See page 9 for an overview of the display icons.

C Option button (left)

Press to open the Menu.

Press to select options displayed on screen.

D Option button (right)

In standby, press to open the phonebook menu, page 14.

Press to select options displayed on screen.

E Redial/ Up

In standby, press to open and scroll through the Redial list, page 14.

In talk mode, press to adjust volume.

In menu mode, press to scroll through the options.

When storing an entry in the phonebook, press and hold to enter a Pause, page 40.

F Talk/ Handsfree

In standby mode, press to make and receive calls, page 13.

In talk mode, press to switch handsfree on and off, page 14.

G End call/ Power on/off

Press to end a call, page 13.

In menu mode, press to return to standby.

In standby, press and hold to switch the handset off. When off, press to switch the handset back on.

H Phonebook/ Down

In standby, press to open and scroll through the Names list, page 15.

In talk mode, press to adjust volume.

In menu mode, press to scroll through the options.

I Navigator glow ring

Illuminates when the phone is in use. Flashes to indicate new event, eg. missed call.

J *

Press and hold to switch between Tone and Pulse dialling, page 19

K #/ Lock

Press and hold to lock the keypad, page 14.

To unlock, select **Unlock** and follow the on screen instructions.

L Int (Intercom)

Used for internal calls, page 37.

M R (Recall)

For use with switchboard/PABX.

Handset Display



Display icons

- Displayed in standby mode to indicate handset is in range of the base. Flashes if you move out of range.
- Displayed if ECO Mode is switched on
- Handset ringer volume is Off.
- Displayed in handsfree talk mode.
- Answer machine is On.
- An alarm is set.
- The keypad is locked.
- You have answer machine messages.
- You have text messages.*
- You have voicemail messages.*
- You have missed calls.*

The approximate power levels of your battery are indicated as below:

- Battery is fully charged.
- Battery is partially charged.
- Battery is running low.
- Battery is almost fully discharged (Red).

* For this feature to work you must subscribe to your network provider's Caller Display service. A quarterly fee may be payable.

NOTE

When the memory for TAM, text or voicemail messages is full, a white line will appear below their corresponding reminder icon.

Overview of the base

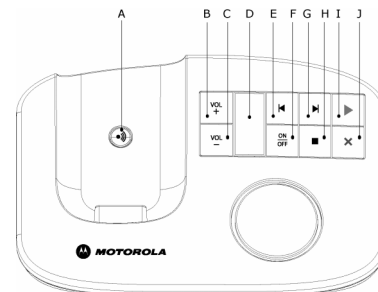

A Paging Key

In standby, press to ring the handset(s), page 14. Press and hold to enter registration mode when registering handsets, page 36.

B Volume Up

C Volume Down

D LED Indicator

Indicates when the answer machine is on or off, and how many messages you have.

When answer machine is ON	Displays the number of messages
When memory is full and answer machine is ON	Alternates between "F" and message number
During Remote Access of the answer machine	Displays "A"
When recording incoming/outgoing messages and memo	Displays "r"
During volume adjustment	Displays "0" - "9" or "H" for highest volume
When answer machine is OFF with no activity	Displays "."
On startup	Flash between "C" and message number if the time has not been set

E Skip Backwards/Replay

F Answer machine On/Off

G Skip Forward

H Stop

I Play/Pause

J Delete

For more information on these control keys, see page 27

Navigating the menus

Your D1111 has an easy to use menu system.

Each menu has a list of options, which you can see on the menu map on the following page.

When the handset is switched on and in standby:

1. Press **Menu** to open the main menu.
2. Then use **▲** or **▼** buttons to scroll through the available options.
3. Press the **Select** option button to select a menu option or the **Back** option button to go back to the previous screen.
To return to the previous menu level, press **Back**.
To exit the menu and return to standby, press **End Call**.

If no buttons are pressed for 30 seconds, the handset returns to standby automatically.

Menu map

Text Messaging	Answer Machine	Calls Lists	Reminder	Clock & Alarm	Settings	Registration	Extra	Names	Press Names during a call:
Write Message	Play	Missed Calls	If there is an Event, the following options will be displayed.	Date & Time	Set Handset	Register Handset	Room Monitor	From menu in standby:	Phonebook list is displayed.
Inbox	Play All	Received Calls		Alarm	Ringtone	Select Base		Search	Select OPTIONS:
Drafts	Answer On/Off	Dialled Calls	Add Event*	Time Format	Ringer Volume	De-register		Add Entry	<i>Add Entry</i>
Outbox	Record Memo	Delete Calls	Show Details		Receiver Volume			Copy Phonebook	<i>Show Details</i>
Templates	Outgoing Message		Edit Event		Handset Name			Dialling Codes	<i>Edit Entry</i>
Delete Messages	Delete Messages		Send as a Text		Language			Memory Status	<i>Delete Entry</i>
Text Settings	Answer Settings		Delete Event		Wallpaper			Delete Phonebook	
<i>Service Centres</i>	<i>Language</i>		Delete All Events		Menu Colour			Press  in standby:	
<i>Mailbox Number</i>	<i>Answer Mode</i>				Screensaver			Phonebook list is displayed	
<i>Message Size</i>	<i>Answer Delay</i>				Light Timeout			Select OPTIONS:	
<i>Message Alert</i>	<i>Message Alert</i>				Display Contrast			<i>Show Details</i>	
<i>Users</i>	<i>Remote Access</i>				Auto Talk			<i>Send Message</i>	
					Key Beep			<i>Edit Entry</i>	
					PABX Access Code			<i>Copy Entry</i>	
					Set Base			<i>Ringtone</i>	
					Ringtone			<i>Delete Entry</i>	
					Ringer Volume				
					Dialling Mode				
					Ring Priority				
					Recall Mode				
					First Ring				
					System PIN				
					Master Reset				
					ECO Mode				

*If there is already an event on the list, "Event" is displayed. Otherwise, "Add Event" is displayed.

Character map

Key Case Assigned characters and symbols

1	L/U*	. , - ? ! j ç ' @ : ; / 1
2	L	a b c 2 ä æ á à ç
	U	A B C 2 Ä Æ Á Ç
3	L	d e f 3 è é
	U	D E F 3 É
4	L	g h i 4 i
	U	G H I 4
5	L	j k l 5
	U	J K L 5
6	L	m n o 6 ö ø ò ñ
	U	M N O 6 Ö Ø Ñ
7	L	p q r s 7 ß
	U	P Q R S 7
8	L	t u v 8 ú ü
	U	T U V 8 Ü
9	L	w x y z 9
	U	W X Y Z 9
0	L/U	Space 0
*	L/U	bring up symbol table
#	L/U	short press to switch between Abc, abc, ABC and 123 mode

*L = Lower
U = Upper

When display language is Türkçe - the character mapping is as follow:

Key Case Assigned characters and symbols

1	L/U*	. , - ? ! ' @ : ; / 1
2	L	a b c 2 â ç
	U	A B C 2 Â Ç
3	L	d e f 3
	U	D E F 3
4	L	g h i 4 ğ ı
	U	G H I 4 Ğ İ
5	L	j k l 5
	U	J K L 5
6	L	m n o 6 ö
	U	M N O 6 Ö
7	L	p q r s 7 ş
	U	P Q R S 7 Ş
8	L	t u v 8 ü ú
	U	T U V 8 Ü Ü
9	L	w x y z 9
	U	W X Y Z 9
0	L/U	Space 0
*	L/U	bring up symbol table
#	L/U	short press to switch between upper and lower case letters



*L = Lower
U = Upper

3. Using the phone

CALL TIMER

Your handset will automatically time the duration of all external calls. The handset display shows the duration the phone is off-hook both during and for a few seconds after your call.

Switch the handset on / off

1. In standby, press and hold  to switch the handset off. When off, press  to switch back on.

Make a call

1. Press .
2. When you hear the dial tone, dial the number.

Preparatory dialling

1. Dial the number first. If you make a mistake press **Clear** to delete the last digit.
2. Press  to dial.

If the number dialled matches an entry in the phonebook, the name is displayed.

End a call



1. Press .

Receive a call

When you receive an external call, the phone rings. The display shows **External Call** and the caller's number or, if the number matches an entry stored in the phonebook, the name is displayed.

1. Press  to answer the call.

Adjust the earpiece/receiver volume

1. During a call, press  or  to increase or decrease the volume. The display shows the level.

Security

During a call, you can talk to someone nearby without your caller hearing.

1. During a call, press **Security**. The display shows **Security On** and your caller cannot hear you.
2. Press **Off** to return to your caller.

Internal calls

Call another handset

If you have more than one handset registered to the base, you can make internal calls between two handsets.



1. Press  then the number (1-5) of the handset you want to call.
2. Press **OK** to dial.

When an internal call is received, the display shows **Internal Call Handset X** (where X is the calling handset) and the handset number.

Transfer a call

You can transfer an external call to another handset registered to the base.

During your call:



1. Press  then the handset number (1-5) you want.
2. Press **OK** to dial or press **End** to cancel the calls request and return to the caller.
3. When the other handset answers you can announce the caller.
4. Press  to complete the transfer or  to switch back and forth between both callers.

If the other handset does not answer, press **End** to return to your original caller.

3-way conference call

You can hold a 3-way conference call between 2 internal callers and 1 external caller.





During a call to an external caller:

1. Press  then the handset number (1-5) you want.
2. Press OK to dial.
3. When the other handset answers you can announce the caller.
4. Press **Join** to begin the conference call. Display shows **Conference Call**.
5. Press  to hang up.

Handsfree

Handsfree lets you talk to your caller without holding the handset. It also enables other people in the room to listen to your conversation over the loudspeaker.

Make a handsfree call

1. Dial the number then press .
2. Press  again. The  icon is displayed and you hear your call over the handset loudspeaker.
3. Press  to switch the call between the earpiece and the loudspeaker.
4. Press  to end the call.

During a handsfree call, press  or  to change the volume.

Answer a call in handsfree





When the phone rings, press  twice to answer in handsfree talk mode.

Redial

The last 20 telephone numbers called are saved to a redial list. You can then select any of the numbers to redial, delete or copy to the phonebook.

Redial numbers can be up to 32 digits long.

Redial a number from the redial lists

1. Press  the last number you called is displayed.
2. Press  or  to scroll to the number you want.
3. Press  to dial.

Save a number from the redial list to the phonebook

Please see "Copy a Calls list number to the phonebook" on page 24 for instructions and select the **Dialled Calls** option.

Delete a redial number/delete all redial



Please see "Delete a redial number/delete all redial" on page 14 for instructions and select the **Dialled Calls** option.

To lock the keypad

You can lock the keypad so that it cannot be used accidentally while carrying it around.

IMPORTANT



When the keypad is locked you can still answer incoming calls and operate the handset as normal. When the call is ended, the keypad lock comes on again.

1. Press and hold .  is displayed. To unlock the keypad:
2. Press **Unlock**. Display shows **Press # to Unlock Keys**.
3. Press .

Paging/Find handset

You can alert a handset user that they are wanted or locate a missing handset.

Paging calls cannot be answered by a handset.

1. Press  on the base. All handsets registered to the base will ring and display **Paging Call**.
2. Press  on the base again to stop the ringing or, on any handset, press **Stop** or any button on the handset to stop all handsets ringing.

Phonebook

You can store up to 100 names and numbers in the phonebook. Names can be up to 12 characters long and numbers up to 24 digits. You can also select different ring tones for phonebook entries.

SEARCH ALPHABETICALLY

Press 

Or

Press Names.

Search is highlighted. Press Select.

The list of entries is displayed.

Enter the first letter of the name you want. The first name beginning with that letter is displayed.

Scroll  to view any other entries beginning with that letter.

Store a name and number

If you subscribe to a Caller Display Service and want the name of your caller displayed instead of the number, save the full telephone number including the dialling code to your phonebook.

You can store multiple entries with the same name but, to prevent unnecessary duplicates, you can only store one number once.



1. From standby, press Names. The phonebook menu is displayed.
2. Search is highlighted. Scroll  to Add Entry and press Select.
3. Enter the name and press OK.

When storing a name the first character is upper case and the rest lower case.

To change the case manually, Press .

To store a Pause in the number field, press and hold .

To store a Recall in the number field, press .

4. Enter the number and press Save.
5. Scroll  or  to the ringtone you want and press Select. The display shows <NAME> Saved and returns to the phonebook menu.
6. Press Back to return to the previous menu level or  to return to standby.

ENTERING NAMES

Use the keypad letters to enter names, e.g. to store TOM:



Press  once to enter T.

Press  three times to enter O.

Press  once to enter M.

WRITING TIPS

Press Clear to delete the last character or digit.

Press  or  to move backwards or forwards through character/digits.

Press  to switch between upper and lower case.

Press  to insert a space.



Use  for other punctuation characters.

You must enter a name to go with a number.





Open the phonebook during a call.

1. During your conversation, press Names.
2. Press Options to select Add Entry, Show Details, Edit Entry or Delete Entry.







View an entry

1. Press . The first entry is displayed.
2. Scroll  or  to the entry you want or search alphabetically.
3. Press Options. The display highlights Show Details.
4. Press Select to display the name, number and ringtone.
5. Press Dial to call the number or Back to return to the previous level.

Dial an entry

1. In standby, press . The first entry is displayed.
2. Scroll  or  to the entry you want or search alphabetically.
3. Press  to dial the displayed number.

Edit a name and number

1. Press .
2. Scroll  or  to the entry you want.
3. Press Options and scroll  to Edit Entry and press Select.
4. Press Clear to delete characters, use the keypad to enter new ones then press OK.
5. Press Clear to delete digits, use the keypad to enter new ones then press Save.
6. Scroll  or  to the ringtone you want and press Select to save the entry.
7. Press Back to return to the previous menu level.

Edit ringtone

1. Press **▼**.
2. Scroll **▲** or **▼** to the entry you want.
3. Press **Options** and scroll **▼** to **Ringtone** and press **Select**.
4. Scroll **▲** or **▼** to the ringtone you want or select **Default Melody** and select **Select**.
5. Press **Back** to return to the previous menu level.

Delete an entry

1. Press **▼**.
2. Scroll **▲** or **▼** to the entry you want.
3. Press **Options** and scroll **▼** to **Delete Entry** and press **Select**.
4. Press **Yes** to confirm or **No** to cancel.
5. Press **Back** to return to standby.

Delete entire phonebook

1. Press **Names**.
2. Scroll **▲** or **▼** to **Delete Phonebook** and press **Select**.
3. Press **Yes** to confirm or **No** to cancel.
4. Press **Back** to return to standby.

Copy an entry to another handset

When you have more than one handset registered to your D1111 base, you can copy entries between handsets.

1. Press **▼**.
2. Scroll **▲** or **▼** to the entry you want.
3. Press **Options** and scroll **▼** to **Copy Entry** and press **Select**.
4. **To Handset** is displayed. Press **Select**.
5. Available handsets are displayed. Scroll **▲** or **▼** to the handset you want and press **Select**. **Copy Phonebook?** is prompted on the receiving handset. Press **Yes** to accept or **No** to cancel. When completed the sending handset displays **<NAME> Copied**.
6. Press **Back** to return to the previous menu level.

Copy the entire phonebook to another handset

In just a few minutes, you can copy all your phonebook contacts to another handset.

At the handset you are copying from:

1. Press **Names**.
2. Scroll **▼** to **Copy Phonebook** and press **Select**.
3. **To Handset** is displayed. Press **Select**.
4. Available handsets are displayed. Scroll **▲** or **▼** to the handset you want and press **Select**. When completed the display shows the number of entries copied.
5. Press **Back** to return to the previous menu level.

At the receiving handset:

1. The display shows **Copy Phonebook?** Press **Yes** to begin copying or **No** to cancel.

Memory status

You can check how much of the phonebook memory is available.

1. Press **Names**.
2. Scroll **▼** to **Memory Status** and press **Select**.
3. Display shows the number of **Memory Used** and **Memory Free** entries.
4. Press **Back** to return to the previous menu level.







4. Handset settings

Handset ringtone

You can set different ringtones for external calls and internal calls.

Select from 10 handset ringtones.





You will hear a sample ring for each one you highlight.

1. Press **Menu**, scroll  to **Settings** and press **Select**.
2. **Set Handset** is highlighted. Press **Select**.
3. **Ringtone** is highlighted. Press **Select**.
4. Press  or  to highlight **External Call** or **Internal Call**. Press **Select** to confirm.
5. Scroll  or  to highlight the ringtone you want.
6. Press **Select** to confirm.
7. Press **Back** to return to the previous menu level or  to return to standby.

Handset ringer volume

The handset has 5 ringer volume settings plus Off.



If the volume is set to Off the  icon is displayed.

1. Press **Menu**, scroll  to **Settings** and press **Select**.
2. **Set Handset** is highlighted. Press **Select**.
3. Scroll  to **Ringer Volume** and press **Select**.
4. Press  or  to display the volume level you want. Press **Save** to confirm.
5. Press **Back** to return to the previous menu level or  to return to standby.

Receiver volume

This sets the standard volume level for the handset earpiece. There are 8 levels to choose from.



1. Press **Menu**, scroll  to **Settings** and press **Select**.
2. **Set Handset** is highlighted. Press **Select**.
3. Scroll  to **Receiver Volume** and press **Select**.

4. Press  or  to display the volume level you want. Press **Save** to confirm.
5. Press **Back** to return to the previous menu level or  to return to standby.







Handset name

If you are using more than one handset with your D1111 base, you can give each handset a personalised name to easily distinguish between the handsets.





A name can be up to 10 characters long.

1. Press **Menu**, scroll  to **Settings** and press **Select**.
2. **Set Handset** is highlighted. Press **Select**.
3. Scroll  to **Handset Name** and press **Select**.
4. Use the keypad to enter the name and press **Save**.
5. Press **Back** to return to the previous menu level or  to return to standby.

Wallpaper

1. Press **Menu**, scroll  to **Settings** and press **Select**.
2. **Set Handset** is highlighted. Press **Select**.
3. Scroll  to **Wallpaper** and press **Select**.
4. Scroll  or  to the wallpaper you want and press **View**.
5. On the preview screen, scroll  or  to see available wallpapers.
6. Press **Use** to confirm the wallpaper.
7. Press **Back** to return to the previous menu level or  to return to standby.





Menu colour

1. Press **Menu**, scroll  to **Settings** and press **Select**.
2. **Set Handset** is highlighted. Press **Select**.
3. Scroll  to **Menu Colour** and press **Select**.
4. Scroll  or  to select the colour you want: blue, orange or pink and press **Select**.
5. Press **Back** to return to the previous menu level or  to return to standby.

Screensaver





When the screensaver is set to Clock an analogue clock is displayed.

The screensaver comes on when the screen backlight switches off in standby mode. To change the backlight timeout setting, see Light timeout.





1. Press Menu, scroll  to Settings and press Select.
2. Set Handset is highlighted. Press Select.
3. Scroll  to Screensaver and press Select.
4. Scroll  or  to set the Screensaver to Clock or Off.
5. Press Select to select Clock.
6. Press Back to return to the previous menu level or  to return to standby.

Light timeout

Set how long the backlight stays on after the handset has returned to standby screen.

1. Press Menu, scroll  to Settings and press Select.
2. Set Handset is highlighted. Press Select.
3. Scroll  to Light Timeout and press Select.
4. Scroll  or  to set the timeout period you want then press Select.
5. Press Back to return to the previous menu level or  to return to standby.





Display contrast

1. Press Menu, scroll  to Settings and press Select.
2. Set Handset is highlighted. Press Select.
3. Scroll  to Display Contrast and press Select.
4. Scroll  or  to Low, Medium or High then press Select.
5. Press Back to return to the previous menu level or  to return to standby.

Auto talk





If you set Auto Talk to ON, when you receive an incoming call you can answer it just by lifting your handset from the charger. You do not need to press .

1. Press Menu, scroll  to Settings and press Select.
2. Set Handset is highlighted. Press Select.

3. Scroll  to Auto Talk and press Select.
4. Scroll  or  to On or Off then press Select.
5. Press Back to return to the previous menu level or  to return to standby.

Key beep

When you press a button on the D1111 handset you hear a beep. You can switch this on or off.





1. Press Menu, scroll  to Settings and press Select.
2. Set Handset is highlighted. Press Select.
3. Scroll  to Key Beep and press Select.
4. Scroll  or  to Off or On then press Select.
5. Press Back to return to the previous menu level or  to return to standby.

PABX access code

If your D1111 is connected to a switchboard, you may need to enter a one-digit access code in the dialling sequence to be able to connect to the outside line.

The access code will be displayed at the beginning of a number on the screen.

The access code will not be used when you dial the number yourself (rather than for example from the phonebook). This allows you to make calls to other switchboard extensions.





1. Press Menu, scroll  to Settings and press Select.
2. Set Handset is highlighted. Press Select.
3. Scroll  to PABX Access Code and press Select.
4. Scroll  or  to On, Off or Set Code then press Select.
If you select Set Code, enter the switchboard access code e.g. 9 then press Save.
5. Press Back to return to the previous menu level or  to return to standby.

5. Base settings

Base ringtone







Select from 5 base ringtones.

You will hear a sample ring for each one you highlight.

1. Press **Menu**, scroll  to **Settings** and press **Select**.
2. Scroll  to **Set Base** and press **Select**.
3. **Ringtone** is highlighted. Press **Select**.
4. Scroll  or  highlight the ringtone you want.
5. Press **Select** to confirm.
6. Press **Back** to return to the previous menu level or  to return to standby.







Base ringer volume

The base has 5 ringer volume settings plus Off.

1. Press **Menu**, scroll  to **Settings** and press **Select**.
2. Scroll  to **Set Base** and press **Select**.
3. Scroll  to **Ringer Volume** and press **Select**.
4. Press  or  to display the volume level you want. Press **Select** to confirm.
5. Press **Back** to return to the previous menu level or  to return to standby.

Dialling mode



Your D1111 is pre-set to Tone dialling. You should not normally need to change this setting. The dial mode options are Tone or Pulse.



1. Press **Menu**, scroll  to **Settings** and press **Select**.
2. Scroll  to **Set Base** and press **Select**.
3. Scroll  to **Dialling Mode** and press **Select**.
4. Press  or  to highlight **Pulse** or **Tone** then press **Select** to confirm.
5. Press **Back** to return to the previous menu level or  to return to standby.



Ring priority

When you have more than one handset registered to your base, you can set one handset to ring before the other handsets. This allows one handset user to answer all incoming first, like a receptionist.

Choose **All Handsets** if you want all handsets to ring at the same time or **Select Handset** to nominate a handset to ring two times before the others.







1. Press **Menu**, scroll  to **Settings** and press **Select**.
2. Scroll  to **Set Base** and press **Select**.
3. Scroll  to **Ring Priority** and press **Select**.
4. Press  or  to highlight **All Handsets** or **Select Handset** then press **Select**.

If you choose **Select Handset** all available handsets are displayed. Scroll  or  to highlight the handset you want then press **Select**.

Scroll  or  to the number of rings you want to set 2, 4 or 6 and press **Select**.

5. Press **Back** to return to the previous menu level or  to return to standby.



Recall mode



1. Press **Menu**, scroll  to **Settings** and press **Select**.
2. Scroll  to **Set Base** and press **Select**.
3. Scroll  to **Recall Mode** and press **Select**.
4. Press  or  to highlight **Recall 1** or **Recall 2** then press **Select** to confirm.
5. Press **Back** to return to the previous menu level or  to return to standby.

First ring

If you have subscribed to your network's Caller Display service, your D1111 does not ring until the caller information has been received and displayed.

However, if you want your handset to ring without waiting for the caller information to be displayed, set **First Ring to On**. Please note that this will mean the first ring you hear will be the default ringtone. This will change to any ringtone you have set once the caller information is displayed.





1. Press **Menu**, scroll  to **Settings** and press **Select**.
2. Scroll  to **Set Base** and press **Select**.
3. Scroll  to **First Ring** and press **Select**.

4. Press  or  to On or Off then press **Select** to confirm.
5. Press **Back** to return to the previous menu level or  to return to standby.

System PIN

The System PIN is used when changing certain settings and registration / de-registration. The default setting is 0000. You can change this to your own preferred number up to 8 digits.



When you enter a PIN the digits are shown as ****.

1. Press **Menu**, scroll  to **Settings** and press **Select**.
2. Scroll  to **Set Base** and press **Select**.
3. Scroll  to **System PIN** and press **Select**.
4. Enter the old PIN (original setting 0000) and press **OK**.
5. Enter the new PIN and press **OK**.
6. Re-enter the new PIN and press **OK**.
7. Press **Back** to return to the previous menu level or  to return to standby.

Restore default settings

You can restore your D1111 to its default (original) settings. It will not affect the phonebook, calls list or user's data, including personal/recorded outgoing messages and answer machine messages.

All handsets registered to the base will be retained. All text, answer machine, handset and base settings will be reset.

1. Press **Menu**, scroll  to **Settings** and press **Select**.
2. Scroll  to **Set Base** and press **Select**.
3. Scroll  to **Master Reset** and press **Select**.
4. Select **Yes** to confirm or **No** to cancel.
5. Enter the system PIN (original setting 0000) then press **OK**. The display will show **Reset Complete** and the unit will restart.

Default settings

Handset Name	Handset
Handset Ringtone	Melody 3
Handset Ring Volume	3
Receiver Volume	4
Key Beep	On
Auto Talk	On
Screensaver	Clock
Base Ringtone	Melody 1
Base Ring Volume	3
Dialling Mode	Tone
First Ring	Off
System PIN	0000
ECO Mode	Off
Room Monitor	Off
Answer Machine	On
Outgoing Message	Answer & Record
Ring Delay	6 rings

ECO mode

To reduce the level of power emissions, you can select low power or ECO mode. When the ECO mode is set to On, the base transmission power will be reduced.

To turn ECO Mode to On or Off:

1. Press **Menu**, scroll \downarrow to **Settings** and press **Select**.
2. Scroll \downarrow to **Set Base** and press **Select**.
3. Scroll \downarrow to **ECO Mode** and press **Select**.
4. Press \uparrow or \downarrow to highlight **On** or **Off** then press **Select** to confirm.

The display will show **Set to ON** or **Set to OFF** depending on the selection together with a confirmation tone.

Signal icon in
ECO mode



When set to ON,  icon is displayed in place of the standard signal icon.

NOTE

When ECO mode is set to ON, the handset range will be reduced.

6. Clock & alarm

Date & time

If you subscribe to your network's caller display service, the base sets the date and time for all handsets whenever a call is received. You can manually set the time on an individual handset.

1. Press **Menu**, scroll \downarrow to **Clock & Alarm** and press **Select**.
2. **Date & Time** is highlighted, press **Select**.
3. Enter the date using the format DD/MM/YY.
4. Enter the time and press **Save**.
5. Press **Back** to return to the previous menu level or  to return to standby.

Set alarm

When the alarm is set, the display shows the  icon.

Each handset can have a different alarm setting.

1. Press **Menu**, scroll \downarrow to **Clock & Alarm** and press **Select**.
2. Scroll \downarrow to **Alarm** and press **Select**.
3. Press \uparrow or \downarrow to select **On** and press **Select**.
4. Press \uparrow or \downarrow to select **Once**, **Monday-Friday** or **On Daily** and press **Select**.
5. Enter the time you want the alarm and press **Save**.
6. Press **Back** to return to the previous menu level or  to return to standby.

If the alarm was set to **Once**, the  will disappear from the screen.

If set to **On Daily** or **Monday-Friday**, the  will remain on the screen.

Alarm on /off

Once an alarm has been set, you can switch the setting On or Off.

1. Press **Menu**, scroll \downarrow to **Clock & Alarm** and press **Select**.
2. Scroll \downarrow to **Alarm** and press **Select**.
3. Press \uparrow or \downarrow to select **On** or **Off** and press **Select**.
4. Press **Back** to return to the previous menu level.





Switch off alarm ring

When the alarm goes off, press Stop.

If you are using the handset to make a call when the alarm ring is due, the  flashes and you hear a beep in the earpiece.

Time format

Set the time format to 12 or 24 hour setting.









1. Press **Menu**, scroll  to **Clock & Alarm** and press **Select**.
2. Scroll  to **Time Format** and press **Select**.
3. Press  or  to select **12 Hour** or **24 Hour** and press **Select**.
4. Press **Back** to return to the previous menu level.

7. Event Reminder

Add a new event

Use your D1111 to remind you of details of up to five events such as birthdays, anniversaries or appointments. The entry can be up to 24 characters long.

Up to 24 characters can be entered as the subject.

1. Press **Menu**, scroll  to **Reminder** and press **Select**.
2. If no previous event is stored, **Add Event** is highlighted. Press **Select**.
Or
If events are already stored, they are listed. Press **Options**. **Add Event** is highlighted. Press **Select**.
3. Enter the subject and press **Save**.
4. Enter the date (DD/MM) and press **Save**.
5. Enter the time (HH:MM) and press **Save**. If the current time format setting is 12 hour, select **am** or **pm**.
6. Press  or  to select **Silent** or **Alarm** and press **Select**.
If you press **Alarm**:
Scroll  or  to select **Once** or **Annually** and press **Select**.
If **Once** is selected, scroll  or  to select when you want to receive the reminder **At event time** or **30 min before**. Press **Select**. Display shows **Saved**.
If **Annually** is selected, then the alarm will sound at the event's time.
7. Press **Back** to return to the previous menu level or  to return to standby.





If you select a silent reminder, the event subject is displayed on screen but no alarm will sound.

*When the event memory is full, the display shows **Memory Full**. You must delete an event before you can add a new one.*





Switch off reminder ring

1. The event is displayed. Press **View** to stop the alarm and see the details of the event. Or press **Back** to stop the alarm and return to the standby screen. If no button is pressed, the alarm stops after one minute.

Show reminder details



1. Press **Menu**, scroll  to **Reminder** and press **Select**.
2. Stored events are displayed. If required, scroll  to the event you want and press **Options**.
3. Scroll  to **Show Details** and press **Select**. The description, date and time of the reminder are displayed.
4. Press **Back** to return to the previous menu level or  to return to standby.

Edit reminder

1. Press **Menu**, scroll  to **Reminder** and press **Select**.
2. Stored events are displayed. If required, scroll  to the event you want and press **Options**.
3. Scroll  to **Edit Event** and press **Select**.
4. Edit the subject and press **Save**.
5. Edit the date and time then press **Save**.
6. Press  or  to select **Silent** or **Alarm** and press **Select**.

If you press **Alarm**:



Scroll  or  to select **Once** or **Annually** and press **Select**.

If **Once** is selected, scroll  or  to select when you want to receive the reminder **At event time** or **30 min before**. Press **Select**. Display shows **Saved**.



If **Annually** is selected, then the alarm will sound at the event's time.



7. Press **Back** to return to the previous menu level or  to return to standby.

Send reminder as a text message



1. Press **Menu**, scroll  to **Reminder** and press **Select**.
2. Stored events are displayed. Scroll  to the event you want and press **Options**.
3. Scroll  to **Send as a Text** and press **Select**.
4. The event is displayed. Press **Options** to select **Send** option and enter a destination key.

Delete reminder

1. Press **Menu**, scroll  to **Reminder** and press **Select**.
2. Stored events are displayed. Scroll  to the event you want and press **Options**.

3. Scroll  to **Delete Event** and press **Select**.
4. Press **Yes** to confirm or **No** to cancel.
5. Press **Back** to return to the previous menu level or  to return to standby.

Delete all reminders

1. Press **Menu**, scroll  to **Reminder** and press **Select**.
2. Stored events are displayed. Press **Options**.
3. Scroll  to **Delete All Events** and press **Select**.
4. Press **Yes** to confirm or **No** to cancel.
5. Press **Back** to return to the previous menu level or  to return to standby.

8. Calls lists

IMPORTANT

To use *Caller Display* you must first subscribe to the service from your network provider. A quarterly fee may be payable.

To ensure the caller's name is displayed, make sure you have stored the full telephone number, including the dialling code in the phonebook.

If the caller's number is stored in the phonebook, the name assigned to it is displayed.

If the number is unavailable, *Unavailable* will be displayed.

If the call is from an international number, *International* will be displayed.

If the call is from the operator, *Operator* will be displayed.

If the call is from a payphone, *Payphone* will be displayed.

If the call is from a ringback request, *Ringback* will be displayed.

Caller Display

If you have subscribed to a Caller Display Service, you will be able to see your caller's number on your handset display (provided it is not withheld) prior to answering the call.

If your caller's name and number are stored in the phonebook and a name/number match is found, you will see the caller's name on the display instead.

Calls lists



Each handset can hold details of up to 30 answered or unanswered calls and 20 dialled calls.

The caller's details are stored in a Calls list whether you answered the call or not. When the list is full, and a new call is received, the oldest entry will be deleted automatically.







New calls alert

When you have missed calls, the display shows *You have X new missed calls*. If you press **Back**, the screen returns to standby and the  icon is displayed.









View new missed calls

1. When you see the new calls alert, press **View**. You can now scroll  or  through the Missed Calls list.
2. Press **Options**. *Show Details* is highlighted. Press **Select** to see the number, date and time of the call.
3. Press **Back** to return to the previous menu level or  to return to standby.

View and dial from a Calls list







1. Press **Menu**, scroll  to **Calls Lists** and press **Select**. *Missed Calls* is highlighted. Scroll  or  to choose *Missed Calls*, *Received Calls* or *Dialled Calls*.
2. Press **Select**. You can now scroll  or  through the list.
3. Press **Options**. *Show Details* is highlighted.
4. Press **Select** to see the caller's number, date and time of call.
5. Press **Dial** to call the number.
6. Press **Back** to return to the previous menu level or  to return to standby.

Copy a Calls list number to the phonebook

1. Press **Menu**, scroll  to **Calls Lists** then press **Select**. *Missed Calls* is highlighted.
If required, scroll  or  to *Received* or *Dialled Calls* then press **Select**.
2. Scroll  or  to the entry you want and press **Options**.
3. Scroll  to *Save Number*. Press **Select**.
4. Enter a name then press **OK**. The number is displayed, press **Save**.
*If you need to edit the number, use **Clear** to delete any unwanted digits, then enter new ones using the keypad.*
5. Scroll  or  to the ringtone you want and press **Select**.
6. Press **Back** to return to the previous menu level or  to return to standby.







See *"Entering names"* and *"Writing tips"* on page 15.

Send a text message to a Calls list number

1. Press **Menu**, scroll  to **Calls Lists** then press **Select**. **Missed Calls** is highlighted.
If required, scroll  or  to **Received** or **Dialled Calls** then press **Select**.
2. Scroll  or  to the entry you want and press **Options**.
3. Scroll  to **Send Message**. Press **Select**.
4. Write the message then press **Options**.
5. **Send** is highlighted. Then press **Select**. (You can save, insert a symbol, emoticon or template).
6. The number is pre-entered on the **Send** to screen, press **Send** to send the message.
7. Press **Back** to return to the previous menu level or  to return to standby.







See page 31 for more information on text messaging.

Delete an entry

1. Press **Menu**, scroll  to **Calls Lists** then press **Select**. **Missed Calls** is highlighted.
If required, scroll  or  to **Received** or **Dialled Calls** then press **Select**.
2. Scroll  or  to the entry you want and press **Options**.
3. Scroll  to **Delete Call**. Press **Select**.
4. Press **Back** to return to the previous menu level or  to return to standby.





Delete all entries

You can delete all entries in an individual Calls list or all entries from all Calls lists.

1. Press **Menu**, scroll  to **Calls List** then press **Select**. **Missed Calls** is highlighted.
If required, scroll  or  to **Delete Calls** press **Select**.
2. Scroll  or  to highlight **Missed Calls**, **Received Calls**, **Dialled Calls** or **All Calls**. Press **Select**.
3. Press **Yes** to confirm or **No** to cancel.
4. Press **Back** to return to the previous menu level or  to return to standby.

9. Call Waiting

You must subscribe to your network's Caller Display service for Call Waiting to work. A quarterly fee may be payable.

1. During a call, you hear a soft beep in the earpiece and the display shows the number of the caller or the name if it matches an entry in your phonebook. If these are not available, the display shows **Call Waiting**.
2. Press  to put your current caller on hold and speak to the new caller.
3. Press  again to switch between both callers (In some countries, it is required to dial R + 2).
4. Press  to finish the current call or  to end both calls.

10. Voicemail

If you have subscribed to your network operator's voicemail messaging service, your handset can inform you when you receive new voicemail.

If you have new voicemail, **You have new voicemail** is displayed.

- Press **Listen** to dial the voicemail number preset on the handset. If your voicemail number is different to the number stored in the handset, you can manually dial your preferred voicemail number.
- Or press **Back** to listen to your voicemail at a later time. A reminder icon  will be displayed.

11. Room Monitor

You can use your D1111 handset to monitor the sounds in another room. If the sounds reach a certain level the handset will automatically dial out to a preset external number or to another handset. When the Room Monitor is set to On, the handset will display Room Monitor On and only the microphone will be active to monitor the sound levels in the room. Both the speaker and receiver will be set to Off and the handset will not ring if there's any incoming call.

To switch Room Monitor On

1. Press Menu, scroll \downarrow to Extra then press Select. Room Monitor is highlighted. Press Select. Mode will be highlighted.
2. Press Select, scroll \downarrow to On then press Select. Set to ON is displayed for 2 seconds. The handset returns to idle screen and display as Room Monitor On.
To switch off Room Monitor press Off.

To change the monitor level

The monitor level can be set to High or Low, the default setting is Low.

To increase the sensitivity of the Room Monitor:

1. Press Menu, scroll \downarrow to Level, press Select and scroll \uparrow or \downarrow to select Low or High setting.

To set the dial out number

1. Press Menu, scroll \downarrow to Call to and press Select.
2. Use the \uparrow or \downarrow key to select External or Internal.

External

1. Press Select and Enter Number: prompt will be displayed.
2. Enter the number and press Save. Saved will be displayed.
When Room Monitor is switched on and the sound level reaches a certain level the number will be automatically dialed.

Internal

1. Press Select and the registered handset will be listed, for example Handset 2.
2. Scroll \uparrow or \downarrow to select the handset the Room Monitor will call if the noise levels reach a certain level.
3. Press Select and Set to handset 2 is displayed.

NOTE

If only one handset is registered the display prompts Not available and returns to the previous screen. You must register additional handsets before the handsets will be displayed and make Internal calls.

NOTE

If the Room Monitor is triggered to call a handset or number and the called handset is on a call, an alert tone of 3 beeps will be heard. If the Room Monitor is triggered continuously the alert beep will be emitted every 5 seconds.

WARNING

This product is not intended for use as a baby safety device and is not a substitute for adult supervision.

12. Answer machine







Your D1111 can digitally record up to 12 minutes of messages or up to 59 messages. Each message can last up to a maximum of 3 minutes. As well as recording incoming messages, you can record memos for other users.

You can operate your answer machine from:

- the base.
- the handset.
- remotely, from any other Touchtone™ telephone, see page 30.

You will need to set the date and time (if you have not already done so) so that you will know when each message was received, see page 21.

Base control keys





- | | |
|--|--|
|  | Press to turn the answer machine on/off
Press and hold to enter the outgoing message (OGM) selection mode |
|  | Press to play all stored messages
Press to pause or resume playback |
|  | Press to stop message playback |
|  | Skip to the next message during message playback
Select Answer Only OGM during OGM selection mode. |
|  | Replay current message
Press twice to skip back to previous message
Select Answer & Record OGM during OGM selection mode. |
|  | Delete current message during message playback
Press to delete personal OGM during OGM playback. The pre-recorded OGM is selected and played. |
|  | Increase speaker volume during message playback |



Decrease speaker volume

For more information on outgoing messages (OGM), see page 28.

Switch the answer machine on / off







1. Press Menu, scroll  to Answer Machine and press Select.
2. Scroll  to Answer On/Off and press Select.
3. Scroll  or  to highlight On or Off and press Select. When switched on, the handset display shows  in idle.

This can also be done via the base by pressing  on the base.

Answer delay

Answer delay sets the number of times your D1111 will ring before the answer machine picks up your call and starts playing the outgoing message.







You can change this setting to between 2–9 rings or Time Saver. The default setting is 6 rings.

1. Press Menu, scroll  to Answer Machine and press Select.
2. Scroll  to Answer Settings and press Select.
3. Scroll  or  to Answer Delay and press Select.
4. Scroll  or  to the setting you want and press Select.
5. Press Back to return to the previous menu level.

For more information on Time Saver, see “Switch your answer machine on remotely” on page 30.



Switch message alert tone on / off

When you have new messages, with the audible message alert switched on, you will hear an audible alert once at the handset and the TAM base will beep every 10 seconds. The default setting is Off.

1. Press Menu, scroll  to Answer Machine and press Select.
2. Scroll  to Answer Settings and press Select.
3. Scroll  or  to Message Alert and press Select.
4. Scroll  or  to highlight On or Off and press Select.
5. Press Back to return to previous menu or  key to return to standby.

On-screen alert

When you have new messages, the display shows *You have X new messages*. If you press **Back**, the screen returns to standby and the icon  is displayed.

1. Press **Play** and scroll  or  to the message you want to play. Press **Play** to hear the highlighted message.

Outgoing messages

The outgoing message is the message a caller first hears when the answer machine picks up their call. There are 2 prerecorded outgoing messages to choose from or you can record your own.

Record your own outgoing message

Your D1111 comes with two prerecorded outgoing messages, **Answer and Record** or **Answer Only**, but if you wish you can record your own.

ANSWER AND RECORD

The pre-set Answer and Record outgoing message, that allows your caller to leave a message, is "Hello, your call cannot be taken at the moment, so please leave your message after the tone".

Your Answer and Record outgoing message can be up to 3 minutes long and will replace the prerecorded message.

ANSWER ONLY





The pre-set Answer Only outgoing message, where callers hear an announcement but cannot leave a message, is "Hello, your call cannot be taken at the moment and you cannot leave a message, so please call later".

When recording your Answer Only message, remember to advise your caller that they will not be able to leave a message.

Your Answer Only message can be up to 3 minutes long (maximum recording length) and will replace the pre-recorded message.



However, you should try to keep your message short to allow time for recording memos, or incoming messages when using Answer and Record mode.

To record your outgoing message:

1. Press **Menu**, scroll  to **Answer Machine** and press **Select**.
2. Scroll  to **Outgoing Message** and press **Select**.
3. **Record** is highlighted, press **Select**.
4. Scroll  or  to **Answer & Record** or **Answer Only** and press **Select**.
5. The display shows **Please speak after the tone**.
6. After the tone, speak your message clearly into the handset then press **Save** or  to end recording.
7. Your outgoing message is played back. If you want to delete it, press **Delete** during playback. If you press **Save** or wait for the message to play back, it will be saved.

Voice prompts or outgoing message language







Only outgoing messages will be available if the following languages are selected: **Nederlands** and **Türkçe**. In other words, no voice prompts instructions will be available if **Nederlands** or **Türkçe** is selected.

1. Press **Menu**, display shows **Answer Machine** and press **Select**.
2. Scroll  to **Answer Settings** and press **Select**.
3. **Language** is displayed, press **Select**.
4. Scroll  or  to the language you want and press **Select** to confirm.

Check or delete your outgoing message

Deleting a personal outgoing message automatically reinstates the prerecorded outgoing message.

You cannot delete a pre-recorded message.

1. Press **Menu**, scroll  to **Answer Machine** and press **Select**.
2. Scroll  to **Outgoing Message** and press **Select**.
3. Scroll  to **Play** and press **Select**.
4. Scroll  or  to **Answer & Record** or **Answer Only** and press **Select**.
5. Press  to **Personal OGM** and press **Select**.
6. The message is played. Press **OK** to stop playback or press **Delete** to delete a personal OGM.
7. Press **Back** to return to the previous menu level.

Select outgoing message mode

Choose which outgoing message you want to be played to callers.

1. Press **Menu**, scroll \updownarrow to **Answer Machine** and press **Select**.
2. Scroll \updownarrow to **Answer Settings** and press **Select**.
3. **Answer Mode** is highlighted, press **Select**.
4. Scroll \updownarrow or \updownarrow to **Answer & Record** or **Answer Only** and press **Select**.
5. If there is a personal OGM saved, press \updownarrow or \updownarrow to **Default OGM** or **Personal OGM** and press **Select**. Your selection is confirmed. If there is no personal OGM saved the default OGM will be selected.
6. Press **Back** to return to the previous menu level.

Record a memo

Memos can only be recorded via the handset.

1. Press **Menu**, scroll \updownarrow to **Answer Machine** and press **Select**.
2. Scroll \updownarrow to **Record Memo** and press **Select**.
3. The display shows **Please speak after the tone**.
4. After you hear the tone, speak your memo then press **Save** or \square to end recording.
5. Your memo is played back. If you want to delete it, press **Delete** during playback. If you press **Save** or wait for the message to play back, it will be saved.
6. Press **Back** to return to the previous menu level.

Call screening

When the answer machine is on and takes a call, you can use the loudspeaker to listen to the caller leaving a message. You can then identify the caller and decide whether to take the call in person.

1. When your D1111 rings, wait for the answer machine to take the call. When the caller begins leaving a message, the display shows **Recording**. Press **Screen** to hear the caller.
2. To interrupt and speak to the caller directly, press \square . Or, after the caller has hung up, and the display shows **You have a new message**, press **Play** to play new messages.
3. Press **Back** to return to the previous menu level.

While screening, you can adjust the volume by pressing \updownarrow or \updownarrow .

Message playback

Each message is played back with day and time of the call announced. The caller's number is displayed (if stored in the phonebook).

When a memo is played back, **Memo** is displayed on the handset.

1. Press **Menu** and scroll \updownarrow to **Answer Machine**. Press **Select**.
2. **Play** is highlighted. Press **Select** to choose which messages you want to play or scroll \updownarrow to **Play All** and press **Select** to play all messages.
3. Press \square to switch between the earpiece and handset loudspeaker. During playback press **Options** then scroll \updownarrow or \updownarrow to: **Pause**, **Repeat Message**, **Skip Forward**, **Skip Backward**, **Delete**.
4. Press **Select** to choose the highlighted option. At the end of playback, press **Back** to return to the previous menu level.

KEYBOARD SHORTCUTS

During playback:

- \square 1 To pause
- \square 2 To resume
- \square 3 To repeat message
- \square 4 To play previous message
- \square 5 To delete current message
- \square 6 To play next message

Delete all old messages

Answer Machine messages that are not deleted are automatically saved.

New / unplayed messages cannot be deleted.

1. Press **Menu**, scroll \updownarrow to **Answer Machine** and press **Select**.
2. Scroll \updownarrow to **Delete Messages** and press **Select**.
3. Display shows **Delete all old messages?** Press **Yes** to confirm or **No** to cancel.
4. Press **Back** to return to the previous menu level.

MEMORY FULL







If the memory is within 10 seconds of becoming full while a caller is leaving a message, they will hear, "Please complete your message within 10 seconds". If they are still talking when the memory becomes full the caller hears, "Thank you for calling", and the machine will hang up.

The OGM will set to Answer Only. You must delete messages before your D1111 can record new messages.







Remote access

You can operate your answer machine from any Touchtone™ phone by calling your D1111 and entering a 4 digit security code. Depending on the language you have selected for your answer machine, for example, Türkçe - voice prompt instructions will not be available.

Switch remote access On or Off.

1. Press Menu, scroll  to Answer Machine and press Select.
2. Scroll  to Answer Settings and press Select.
3. Scroll  or  to Remote Access and press Select.
4. Scroll  or  to highlight On or Off and press Select.
5. Press Back to return to previous menu or  key to return to standby.

Change the remote access PIN

1. Press Menu, scroll  to Answer Machine and press Select.
2. Scroll  to Answer Settings and press Select.
3. Scroll  or  to Remote Access and press Select.
4. Scroll  or  to highlight Set Remote PIN and press Select.
5. Enter the Old 4-digit PIN and press Save. (Default setting = 0000)
6. Enter the new 4-digit Pin and press Save.
7. Enter the new PIN again and press Save.
8. Press Back to return to previous menu or  key to return to standby.

It is advisable to make a note of your new PIN code and keep it somewhere safe.

This PIN is different from the System PIN used when resetting the unit or when registering/de-registering handset.

Switch your answer machine on remotely

If you forget to switch your answer machine on, you can do it remotely from another phone.

1. Dial your telephone number and let it ring. After 14 rings you will hear your outgoing message.
2. Press *, then enter your security code.
(Default setting = 0000)
3. Press  and your answer machine will switch on ready to answer incoming calls.

Time saver

When you ring in to access your messages remotely, if your answer machine is set to time saver and you have new messages it will answer after 2 rings, if you do not have any new messages, it will answer after 6 rings. This means you can hang up after 3 rings knowing you have no new messages, saving you time and the cost of the call.

You cannot use this feature if you have certain network features active as the call will be intercepted before the 20 rings.

Operating your answer machine from another phone

1. Dial your phone number. When you hear your outgoing message, press .
2. Enter your 4 digit PIN. (Default setting = 0000)

3. Use the keypad to operate your answer machine:

DTMF code	Operations	
	with Voice Prompts	with Outgoing Messages
*	To enter remote access mode	To enter remote access mode
1	To hear main menu	No action
2	To play all messages	To play all messages
3	To play new messages	To play new messages
4	To skip back during messages	To skip back during messages
5	To delete during messages	To delete during messages
6	To skip forward during messages	To skip forward during messages
7	To set answer mode	No action
8	To record a new OGM	No action
9	To switch answer machine off	To switch answer machine off
0	To switch answer machine on	To switch answer machine on

If you have any new messages they will be played after you have entered your security PIN code.

If you enter an incorrect PIN code you will hear 'Incorrect security code or two beeps (error beeps). Please enter your security code'. You can try entering the code again. If it is still incorrect you will hear the voice prompt or two beeps (error beeps) and your D1111 will hang up.

13. Text messaging

Welcome to the text messaging Service on your D1111. Your D1111 can send and receive text messages from participating mobile networks and compatible landline telephones in the UK.

IMPORTANT

You must subscribe to your Network Provider's Caller Display service so that you can use text messaging and you must not withhold your telephone number.

A quarterly fee may be payable, please contact your network provider for more details.

Subscribe to the text messaging service

In some country when you send your first text message from your D1111 you will automatically be registered for the service.

If you have Set-Up problems, please check with your Network provider.

Send a text message



If you are writing a text and you receive a call, the text will be displayed again when Write Message is selected.

1. Press Menu, Text Messaging is displayed, press Select.
2. Write Message is highlighted. Press Select.
3. Use the keypad to enter your message.
4. Press Options.

Send is highlighted Press Select to send the message. Enter the phone number or press Search to open the phonebook then scroll to the number you want and press Select. Now press Send.

Or scroll  or  to:

Save Press Select to save the message in the Drafts folder.

Insert Symbol Press Select. The symbol table is displayed. Press  or  to highlight the symbol you want then press Insert.

Insert Emoticon

Press **Select**. The Emoticon table is displayed. Press **▲** or **▼** to highlight the Emoticon you want then press **Insert**.

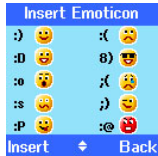

Insert Template

Press **Select**. The list of templates is displayed. Press **▲** or **▼** to highlight the Template you want then press **Insert**.

- When sending a message, the display shows **Sending Message** then **Message Sent**.

WRITING TIPS

Press **Clear** to delete incorrect characters.

Use **▲** or **▼** to move the cursor through the text, if you want to insert/delete text.

UPPER & LOWER CASE

Press **[#]** to switch between upper case and lower case letters.

Maximum number of characters in a text message is 160. The display shows a character countdown from 160 down to 0 (Unless message size is set to 612 characters).

If the text is unsuccessful, the message **Message Sending Failed!** will be displayed.

In order to send and receive text messages you must not withhold your number.

Standard text entry

With standard text entry you can enter a word by pressing each letter button a number of times to display the character you want on the screen. For example, to write the word "Hello", press **[4]** twice, **[3]** twice, **[5]** three times, **[5]** three times and **[6]** three times.

Receiving and reading text messages

Your D1111 can store up to a total of 50 short messages across all handset Outboxes, Drafts boxes and Inboxes.

When you receive a new text message, the  icon is displayed along with **You have X new messages**.

DO YOU HAVE TWO TEXT PHONE BASES CONNECTED TO THE SAME PHONE LINE?

If you have two text phone base stations plugged into one line, you are likely to experience problems receiving text messages. Normally, only one SMS enabled base unit (DECT or cordless) can be plugged into any line.

If you do want to use two base units and still receive written text you must delete receive service centre number from one of the base stations. To do this on your D1111, see page 34.

This will allow you to send text via either base station but texts will only be received on the product with the active receive centre number.

If the base unit with the active receive centre number is a DECT product then all handsets registered to will be able to receive text messages.

MEMORY FULL ALERT

If the text mailboxes are full when you attempt to write a new message the display shows **Memory Full Delete Messages**. You must delete messages before you can write and send a new one.

Read a new message

Received messages are stored in the Inbox.

- The Inbox is opened and the list of messages displayed. If you press **Back** the message is stored in the Inbox for reading later.
- In the Inbox scroll **▲** (to more recent messages) or **▼** (to earlier list of messages) through the list of messages.
- Highlight the message you want to read and press **Read** or press **Back** to return to Text messaging menu.
- Press **[Home]** to return to standby.

Read, forward, delete, view and save numbers of texts in the Inbox

When you see the new message alert, if you press **Back** the message is stored in your **Inbox** so you can read it later.

1. To open the **Inbox**, press **Menu**, **Text Messaging** is displayed. Press **Select**.
2. Scroll \updownarrow to **Inbox** and press **Select**.
If you have new messages (indicated by a green dot), you will go straight to the **Inbox**, if not scroll \updownarrow to **Inbox** and press **Select**.
3. Scroll \updownarrow or \updownarrow to the message you want and press **Read**. Scroll \updownarrow or \updownarrow through the message.
4. Press **Options** and scroll \updownarrow or \updownarrow to:

Reply Press **Select**. Write your reply then press **Options** and select **Send**.

Forward Press **Select**. The message is displayed. Press **Options**. Display highlights **Send**. Press **Select** and enter a number or search for the number then press **Send**.

Message Details You can see who sent the message and then call them. Press **Select** the sender's number is displayed. Press **Dial** if you want to call the number.

Use Number To call the sender, press **Select**. The display shows **Call**. Press **Select** to call the sender OR to save the number, scroll \updownarrow to **Save** and press **Select**. Enter a name and press **OK**, edit the number if required then press **Save**. Scroll \updownarrow or \updownarrow to the ringtone and press **Select**. The number is saved in the phonebook.

Delete Press **Select**. Press **Yes** to confirm or **No** to cancel.

Edit or send texts in the Drafts box

If you save a message to complete or send later it will be stored in the **Drafts** box. Only one message can be saved in each user's **Drafts** box.

1. To open the **Drafts** box, press **Menu**, **Text Messaging** is displayed. Press **Select**.
2. Scroll \updownarrow to **Drafts** and press **Select**.

3. Press **Edit** to edit your message content.
4. Press **Options** and scroll \updownarrow or \updownarrow to **Send**, **Save**, **Insert Symbol**, **Insert Emoticon** and **Insert Template**.
5. When sending a message, the display shows **Sending Message** then **Message Sent**.

Forward or delete texts in the Outbox

Your D1111's outbox is like a redial list. It holds a copies of up to 5 sent messages. When the **Outbox** is full, a new message replaces the oldest.

1. To open the **Outbox** box, press **Menu**, **Text Messaging** is displayed. Press **Select**. Scroll \updownarrow to **Outbox** and press **Select**.
2. Scroll \updownarrow or \updownarrow to the message you want and press **Read**. Scroll \updownarrow or \updownarrow through the message.
3. Press **Options** and scroll \updownarrow or \updownarrow to:

Forward Press **Select**. The message is displayed. Press **Options**. Display highlights **Send**. Press **Select** and enter the number or press **Search** to search the phonebook. When the number is entered, press **Send**.

Delete Press **Select** then press **Yes** to confirm or **No** to cancel.

4. Press \leftarrow to return to standby.

Edit templates

You can set the templates to your preferred message, up to a maximum of 32 characters. You can store up to 3 templates

1. Press **Menu**, **Text Messaging** is displayed. Press **Select** scroll \updownarrow to **Templates** and press **Select**.
2. Scroll \updownarrow or \updownarrow to the template you want and press **Options**.



Edit Press **Select**. Press **Clear** to delete characters. Enter your template text and press **Save**.

Delete Press **Select**. Press **Yes** to confirm or **No** to cancel.

3. Press \leftarrow to return to standby.

*If you delete a template without replacing the text it is marked as **Empty**.*

Deleting texts

1. Press **Menu**, **Text Messaging** is displayed. Press **Select** scroll  to **Delete Messages** and press **Select**.
2. Scroll  or  to **Inbox, Drafts, Outbox or All Messages** and press **Select**.
3. Press **Yes** to confirm or **No** to cancel.
4. Press **Back** to return to standby.







Selecting All messages will delete all messages stored in your Inbox, Outbox and Drafts box.

Service Centre numbers





To send and receive text messages you need the telephone number of your Network's text Centre. If you accidentally delete the Outgoing or Incoming Service Centre numbers you will need to re-enter them in order for your text Service to work. You can enter up to 4 Service Centre numbers – two incoming and two outgoing.

If you have more than one 'Server Centre' stored on your D1111 you will need to select which one you want to use for sending (see next section).

Add or change Service Centre numbers





1. Press **Menu**, **Text Messaging** is displayed. Press **Select**, scroll  or  to **Text Settings** and press **Select**.
2. **Service Centres** is highlighted press **Select**.
3. Scroll  or  to **Receive Centres** or **Send Centre** and press **Select**.
4. Scroll  or  to **Receive Centre 1** or **Receive Centre 2**, or **Send Centre 1** or **Send Centre 2** and press **Select**.
5. Enter the number for the centre and press **Save**.
6. Press **Back** to return to the previous menu level. To return to standby, close the cover or press .

Set send centre

1. Press **Menu**, **Text Messaging** is displayed. Press **Select**. Scroll  or  to **Text Settings** and press **Select**.
2. **Service Centres** is highlighted press **Select**.
3. Press **Select** again to choose **Set Send Centre**.
4. Scroll  or  to **Receive Centre 1** or **Receive Centre 2** or **Send Centre 1** or **Send Centre 2** and press **Select**.
5. Press **Back** to return to the previous menu level.





Message alert tone

When you receive a text message, the message alert tone will sound. These beeps can be switched on or off.

1. Press **Menu**, **Text Messaging** is displayed. Press **Select**. Scroll  to **Text Settings** and press **Select**.
2. Scroll  to **Message Alert** and press **Select**.
3. Scroll  or  to **On or Off** and press **Select**.
4. Press **Back** to return to the previous menu level.

Set message size

A standard text message is 160 characters long. You can set a message to be up to 612 characters and the message will be sent as up to 4 linked messages each up to 160 characters long.

1. Press **Menu**, **Text Messaging** is displayed. Press **Select**. Scroll  to **Text Settings** and press **Select**.
2. Scroll  to **Message Size** and press **Select**.
3. Scroll  or  to highlight 160 or 612 characters, then press **Select**.
4. Press **Back** to return to the previous menu level.

User areas

Your D1111 is pre-set to make all text messages available to every user, with all messages sent from and received at a 'Common Box'.





To keep your messages private, you can set up to 4 PIN protected personal user areas (sub-addresses). Each personal user area has its own Inbox and Outbox which are only accessible when the correct PIN is entered.

You can also keep a common box sub address for incoming messages that do not need to be kept private.

Add a user mailbox



If you set-up personal user boxes you must tell people your user area number. They must put the relevant user area number at the end of your telephone number when they send you a text message. If they do not include the user area number, the messages will be stored in the common box and will be accessible to all users of your D1111.





The mailbox number can only be any number from 0-9 but must not be the same as another user's mailbox number or the common or public box number.

1. Press **Menu**, **Text Messaging** is displayed. Press **Select**. Scroll  to **Text Settings** and press **Select**.
2. Scroll  to **Users** and press **Select**.
3. **User 1** is highlighted. Scroll  or  to select another **User**.
4. Press **Options**. **Edit** is highlighted. Press **Select**.
5. Enter the user name (up to 8 characters) and press **Save**.
6. Use the single digit mailbox number displayed or enter your own single digit mailbox number then press **Save**.
7. Enter a 4-digit mailbox PIN and press **Save**.
8. Enter the password again and press **Save**.
9. Press **Back** to return to the previous menu level.









Open and read a mailbox text

Once mailboxes have been set, when you open the **Text Messaging** menu, the mailboxes in use will be displayed. You can open the **General User Mailbox** without any password but each user area requires you to enter the 4-digit password PIN.









1. The display shows **You have X new messages**.
 2. Press **Read**. The mailboxes are displayed. Mailboxes with new messages are marked with green dots.
 3. Scroll  to the mailbox you want and press **Select**.
 4. Enter the mailbox 4-digit PIN and press **OK**.
 5. Scroll  or  to the message you want and press **Read**.
- Or

1. If you have previously pressed **Back**, the display shows .
2. Press **Menu**, the text icon is displayed. Press **Select**. Mailboxes with new messages are marked with green dots.
3. Scroll  to the mailbox you want and press **Select**.
4. Enter the mailbox 4-digit PIN and press **OK**.
5. Scroll  to **Inbox** and press **Select**.
6. Scroll  or  to the message you want and press **Read**.





Edit a user mailbox

1. Press **Menu**, **Text Messaging** is displayed. Press **Select**. Scroll  to the mailbox you want to edit and press **Select**.
2. Enter the 4 digit mailbox password PIN and press **OK**.
3. Scroll  or  to **Text Settings** and press **Select**.
4. Scroll  or  to **Users** and press **Select**.
5. Scroll  or  to the user mailbox you want to edit and press **Options**.
6. **Edit** is highlighted, press **Select**.
7. Enter the current mailbox PIN and press **OK**.
8. Enter the new name and press **Save**.
9. Enter the new one-digit mailbox number and press **Save**.
10. Enter the new 4-digit mailbox password and press **Save**.
11. Re-enter new 4-digit the password and press **Save**.
12. Press **Back** to return to the previous menu level or  to return to standby.

Delete a user mailbox

1. Press **Menu**, **Text Messaging** is displayed. Press **Select**. Scroll  to the mailbox you want to edit and press **Select**.
2. Enter the 4 digit mailbox password PIN and press **OK**.
3. Scroll  or  to **Text Settings** and press **Select**.
4. Scroll  or  to **Users** and press **Select**.
5. Scroll  or  to the user mailbox you want to delete and press **Options**.
6. Scroll  to **Delete** and press **Select**.
7. Press **Yes** to confirm or **No** to cancel.
8. Enter the current mailbox PIN and press **OK**.
9. Press **Back** to return to the previous menu level or  to return to standby.

Set common mailbox sub address

1. Press **Menu**, **Text Messaging** is displayed. Press **Select**.
2. Scroll  or  to **Text Settings** and press **Select**.
3. Scroll  to **Mailbox Number** and press **Select**.
4. Enter the single digit mailbox number you want and press **Save**. If you enter a number already in use, you hear an error beep. Enter a different number.
5. Press **Back** to return to the previous menu level or  to return to standby.

13. Using additional handsets

You can use up to five D1111 additional handsets with your D1111 base to extend your phone system without needing to install extension sockets for each new phone.

Your D1111 handset can also be registered to up to 3 other bases. You can then select the base you would prefer to use.

If you have purchased a D1111 multiple pack any additional handsets come pre-registered to the base.





If you have purchased an additional handset separately you must register it to your D1111 base before it can be used.

Registering an additional handset

At the base:

1. Press and hold  for 2 seconds until the base Power starts flashing. The base will remain in registration mode for 90 seconds.

At the handset:





1. If the handset is new and the display shows **Please Register**. Press **Menu**. Scroll  to **Registration**. Press **Select**.
Or
If the handset has already been registered to another base the standby display is shown. Press **Menu**, scroll  or  to **Registration** and press **Select**.
2. **Register Handset** is highlighted. Press **Select**.
3. Bases are displayed. If necessary, scroll  or  to a new base you wish to register your D1111 handset to and press **Select**.
4. Enter the system PIN and press **OK**. (Default setting = 0000)
5. The display shows **Searching Base X** (where X is the chosen base number) then **Handset Registered**.
The handset is automatically assigned the next available handset number.

If registration is not successful first time, please repeat the process again in case the base registration period ran out of time.

If there are already 5 handsets registered to the base, the registration will fail. You must de-register another handset before you can register the new one.







Select a base

If your D1111 handset is registered to more than one base, you can select which base to use.

1. Press **Menu**, scroll  or  to **Registration** and press **Select**.
2. Scroll  to **Select Base** and press **Select**.
3. All base numbers are displayed. (In use) is added to bases where the handset was previously registered to. Scroll  or  to the base you want and press **Select**.
4. Display shows **Searching Base....** then the standby display for that base.

De-register a handset

Use one handset to de-register another. You cannot de-register the handset you are using.

1. Press **Menu**, scroll  or  to **Registration** and press **Select**.
2. Scroll  to **De-register** and press **Select**.
3. Enter the system PIN and press **OK**. (Default setting = 0000)
4. Scroll  or  to the handset you want to de-register and press **Select**.
5. Press **Yes** to confirm or **No** to cancel.
6. Press **Back** to return to the previous menu level or  to return to standby.

15. Help

Phone does not work

- Have you installed the batteries correctly?
- Check that the mains power is correctly connected.

No dial tone

- Is the telephone cord of the base plugged into the phone socket?
- Check that the mains power is correctly connected to the base and to the handset charger(s).
- Only use the telephone cord supplied with the phone.

Cannot dial out or receive calls

- Check that the mains power is correctly connected.
- The batteries may need recharging.
- Has there been a power cut? If so, place the handset back on the base for 10 seconds and try again. If it still does not work disconnect the batteries and mains power for 10 minutes, then reconnect and try again.

You have a dial tone, but the phone will not dial out

- You may need to change the dial mode from tone to pulse, see page 19.
- If you are connected to a switchboard, check whether you need to dial an access code.

Handset does not ring

- The ringer volume may be switched off, see page 17.
- Check that the mains power is correctly connected.
- Check that the line cord is connected.
- Make sure the handset is registered to the base, see page 36.

No display

- The batteries may be flat, dead or incorrectly inserted. Recharge or replace the batteries.

icon flashes

- Is the handset registered correctly to the base, see page 36.
- Check that the mains power is correctly connected.
- Check that the handset is within range of the base.
- The batteries are low, place the handset on the base/charger to recharge.

icon not scrolling

- Try cleaning the charging contacts.
- Check that the mains power is correctly connected.

You hear the busy tone when you press

- Make sure the handset is in range of the base.
- Another handset registered to your D1111 base may be on the line.

Answer machine does not record any messages

- The memory may be full. Play and delete old messages, see page 29.

Answer machine messages have the wrong date and time

- Have you set the date and time? See page 21.

No Caller Display number/name displayed

- Have you subscribed to a Caller Display service from your network provider? See page 24.
- The caller may have withheld their number.
- An exact name/number match was not found in your directory. Check that you have stored the full STD dialling code.

Cannot register a handset to a base

- You can register a total of 5 handsets to your D1111 base and you can register your D1111 handset to up to 4 bases. Check that you have not exceeded the limits.
- Check that you have entered the correct PIN number (default PIN 0000).
- Check that you are at least one metre away from other electrical equipment to avoid interference when registering.

Base unit does not ring

- Have you connected the telephone line correctly?
- Is the base ringer set to off?
- You may have a faulty line or socket. Try using another socket or line.

Buzzing noise on my phone or on other electrical equipment nearby

- Sometimes your D1111 can interfere with other electrical equipment if it is placed too close. It is recommended that you place your D1111 at least one metre away from electrical appliances or metal obstructions to avoid any risk of interference.

Possible problems with text messaging

Text messages cannot be sent and screen displays Message Sending Failed

- The base station power supply or telephone line cord might not be properly connected. Check that the base station power supply is plugged into the mains socket and switched on and that the telephone is plugged into the telephone wall socket.
- There might be a fault on the line. Check your telephone line is working properly.
- You might have deleted the server number in error. See page 34 for instructions on how to enter the number.

Cannot send text

- The send and receive service center numbers are pre-programmed. If you need to change them, please refer to "Add or change Service Centre numbers" on page 34 or contact your service provider.

Cannot receive text

- For some network operator, you will not be able to receive text messages until you have first sent a message. The first message sent registers you with the text service.
- More than one text messaging product is plugged into the line. Remove other products.
- Check service centre number is correct.
- Ensure you have subscribed to a Caller Display service and that it is active. You can check this by noting if your phone displays your caller's number when you receive an incoming call.
- If you are using personal user areas please ensure you have given people your user area number and that they are entering it to the end of your telephone number when sending you a text message.

You keep hearing an error beep

- You have pressed the wrong button in a sequence. Check the prompts in the display or refer to instructions in this user guide.

16. General information

IMPORTANT

This equipment is not designed for making emergency telephone call when the power fails. Alternative arrangements should be made for access to emergency services.

This product is intended for connection to analogue public switched telephone networks and private switchboards in United Kingdom.

Safety and Electromagnetic Interference/Compatibility information

- Only use the power supply suitable for this product range. Using an unauthorised power supply will invalidate your guarantee and may damage the telephone.
- Use only the approved rechargeable batteries supplied.
- Do not open the handset (except to replace the handset batteries) or the base. This could expose you to high voltages or other risks.
- Radio signal transmitted between the handset and base may cause interference to hearing aids.
- Your product may interfere with other electrical equipment, e.g. TV and radio sets, clock/alarms and computers if placed too close. It is recommended that you place your product at least one metre away from such appliances to minimise any risk of interference.
- All batteries can cause property damage and/or bodily injury such as burns if a conductive material such as jewellery, keys, or beaded chains touch exposed terminals. The conductive material may complete an electrical circuit (short circuit) and become quite hot. Exercise care in handling any charged battery, particularly when placing it inside a pocket, purse, or other container with metal objects.
- Never dispose of batteries in a fire. There is a serious risk of explosion and/or the release of highly toxic chemicals.
- It is recommended that advice from a qualified expert be sought before using this product in the vicinity of emergency/intensive care medical equipment.

- Medical Devices

- **Pacemakers:** The Advanced Medical Technology Association (AdvaMed) recommends that a minimum separation of 15 cms (6 inches) be maintained between a handheld wireless device and a pacemaker. These recommendations are consistent with those of the U.S. Food and Drug Administration.

- **Persons with pacemakers should:**

- ALWAYS keep the handheld wireless device more than 15 cms from their pacemaker when the handheld wireless device is turned ON.
- Not carry the handheld wireless device in the breast pocket.
- Use the ear opposite the pacemaker to minimize the potential for interference.
- Turn the handheld wireless device OFF immediately if you have any reason to suspect that interference is taking place.

- **Hearing Aids**

Some digital wireless radios may interfere with some hearing aids. In the event of such interference, you may want to consult your hearing aid manufacturer to discuss alternatives.

- **Other Medical Devices**

If you use any other personal medical device, consult the manufacturer of your device to determine if it is adequately shielded from RF energy. Your physician may be able to assist you in obtaining this information.

Cleaning

- Clean the handset and base (or charger) with a damp (not wet) cloth, or an anti-static wipe.
- Never use household polish as this will damage the product. Never use a dry cloth as this may cause a static shock.

Environmental

- Do not expose to direct sunlight.
- The handset may become warm when the batteries are being charged or during prolonged periods of use. This is normal. However, we recommend that to avoid damage you do not place the product on antique/veneered wood.

- Do not stand your product on carpets or other surfaces which generate fibres, or place it in locations preventing the free flow of air over its surfaces.
- Do not submerge any part of your product in water and do not use it in damp or humid conditions, such as bathrooms.
- Do not expose your product to fire, explosive or other hazardous conditions.
- There is a slight chance your phone could be damaged by an electrical storm. We recommend that you unplug the power and telephone line cord during an electrical storm.

Product disposal instructions

- **European Union (EU) Waste of Electrical and Electronic Equipment (WEEE) directive**

The European Union's WEEE directive requires that products sold into EU countries must have the crossed out trashbin label on the product (or the package in some cases). As defined by the WEEE directive, this crossed-out trashbin label means that customers and end-users in EU countries should not dispose of electronic and electrical equipment or accessories in household waste. Customers or end-users in EU countries should contact their local equipment supplier representative or service centre for information about the waste collection system in their country.

- The Waste of Electrical and Electronic Equipment (WEEE) Directive (2002/96/EC) has been put in place to recycle products using best available recovery and recycling techniques to minimize the impact on the environment, treat any hazardous substances and avoid the increasing landfill.

Product disposal instructions for residential users

When you have no further use for it, please remove any batteries and dispose of them and the product per your local authority's recycling processes. For more information please contact your local authority or the retailer where the product was purchased.

Product disposal instructions for business users

Business users should contact their suppliers and check the terms and conditions of the purchase contract and ensure that this product is not mixed with other commercial waste for disposal.

Warranty Information

The authorized Motorola dealer or retailer where you purchased your Motorola product will honour a warranty claim and/or provide warranty service.

Please return your cordless telephone to your dealer or retailer to claim your warranty service. Do not return your telephone to Motorola. In order to be eligible to receive warranty service, you must present your receipt of purchase or a comparable substitute proof of purchase bearing the date of purchase. The telephone should also clearly display the serial number. The warranty will not apply if the type or serial numbers on the product have been altered, deleted, removed, or made illegible.

What Is Not Covered By The Warranty

- Defects or damage resulting from use of the Product in other than its normal and customary manner or by not following the instructions in this user manual.
- Defects or damage from misuse, accident or neglect.
- Defects of damage from improper testing, operation, maintenance, adjustment, or any alteration or modification of any kind.
- Breakage or damage to aerials unless caused directly by defects in material or workmanship.
- Products disassembled or repaired in such a manner as to adversely affect performance or prevent adequate inspection and testing to verify any warranty claim.
- Defects or damage due to range.
- Defects or damage due to moisture, liquid or spills.
- All plastic surfaces and all other externally exposed parts that are scratched or damaged due to normal use.
- Products rented on a temporary basis.
- Periodic maintenance and repair or replacement of parts due to normal usage, wear and tear.

Technical Information

How many telephones can I have?

All items of telephone equipment have a Ringer Equivalence Number (REN), which is used to calculate the number of items which may be connected to any one telephone line. Your D1111 has a REN of 1. A total REN of 4 is allowed. If the total REN of 4 is exceeded, the telephones may not ring. With different telephone types there is no guarantee of ringing, even when the REN is less than 4.

Any additional handsets and chargers that you register have a REN of 0.

R&TTE

This product is intended for use within United Kingdom for connection to the public telephone network and compatible switchboards.

This equipment complies with the essential requirements for the Radio Equipment and Telecommunications Terminal Equipment Directive 1999/5/EC, including compliance with ICNIRP standard for electromagnetic energy exposure.

Declaration of Conformance

Motorola hereby declares that this product is in compliance with the essential requirements and other relevant provisions of Directive 1999/5/EC.

The Declaration of Conformance for this product range is published on the website:

<http://www.motorola.com/eu/radios/technicaldocumentation>

Connecting to a switchboard

This product is intended for use within United Kingdom for connection to the public telephone network.

Inserting a pause

With some switchboards, after dialling the access code you may have to wait for a moment while the switchboard picks up an outside line so you will need to enter a pause in the dialing sequence.

Press and hold  to insert a pause (P) before entering the telephone number.

You may also need to enter a pause when storing international numbers or charge card numbers.

Recall

You may need to use the recall function if you are connected to a switchboard/PABX (Private Automatic Branch Exchange), contact your PABX supplier for further information.

17. Wall mounting

IMPORTANT

Before you wall-mount your D1111, check that you are not drilling into any hidden wiring or pipes.

Before you drill, make sure the power and telephone line cables will reach the sockets.

1. Use the following templates to mark the drilling locations.
- To wall-mount the base, drill two holes in the wall 4.5cm apart horizontally using an 8mm drill bit.

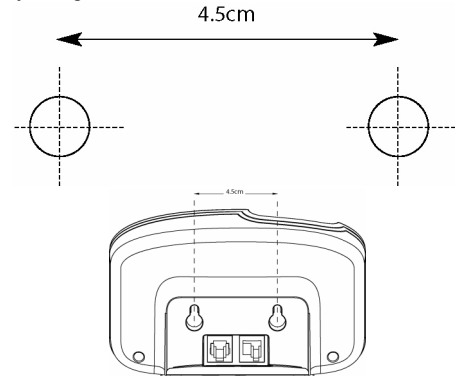

- To wall-mount the charger, drill two holes in the wall 3.2cm apart horizontally using an 8mm drill bit.

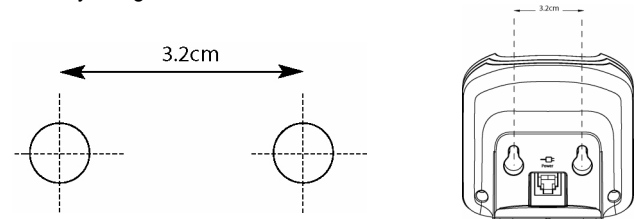

2. Insert the wall plugs if necessary, then insert the screws leaving about 5mm protruding from the wall on which to hang the phone.

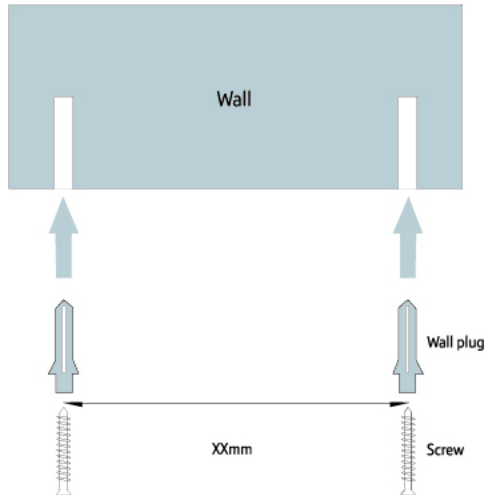

3. Pull the base/charger out of the stand and slot the holes on the back of the base over the screw heads and gently pull the base/charger down to make sure it is securely in place.



MOTOROLA, the Stylized M Logo and all other trademarks indicated as such herein are trademarks of Motorola, Inc. © Reg. U.S. Pat. & Tm. Off.

© Motorola, Inc. 2008



Printed in P.R.C
Version 3 (06112008-UK)



Free Manuals Download Website

<http://myh66.com>

<http://usermanuals.us>

<http://www.somanuals.com>

<http://www.4manuals.cc>

<http://www.manual-lib.com>

<http://www.404manual.com>

<http://www.luxmanual.com>

<http://aubethermostatmanual.com>

Golf course search by state

<http://golfingnear.com>

Email search by domain

<http://emailbydomain.com>

Auto manuals search

<http://auto.somanuals.com>

TV manuals search

<http://tv.somanuals.com>