

User Guide

DCT3400 Series
High Definition
DVR Cable Terminal



MOTOROLA
intelligence everywhere™



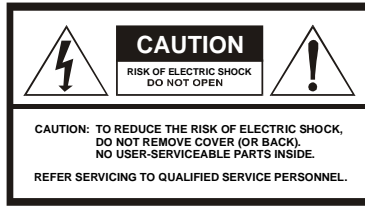

Graphical symbols and supplemental warning marking locations on bottom of terminal.

WARNING

TO REDUCE THE RISK OF FIRE OR SHOCK, DO NOT EXPOSE THIS APPLIANCE TO RAIN OR MOISTURE.

CAUTION

TO PREVENT ELECTRICAL SHOCK, DO NOT USE THIS (POLARIZED) PLUG WITH AN EXTENSION CORD, RECEPTACLE, OR OTHER OUTLET UNLESS THE BLADES CAN BE FULLY INSERTED TO PREVENT BLADE EXPOSURE.



The lightning flash with arrowhead symbol, within an equilateral triangle, is intended to alert the user to the presence of "uninsulated "dangerous voltage" within the product's enclosure that may be of sufficient magnitude to constitute a risk of electric shock to persons.



The exclamation point, within an equilateral triangle, is intended to alert the user to the presence of important operating and maintenance (servicing) instructions in the literature accompanying the appliance.

REPAIRS

If you find the unit in need of repair, call Motorola Support at **1-866-668-2271** or **1-866-MOT-BCS1**.

NOTE TO CATV SYSTEM INSTALLER

This reminder is provided to call the CATV system installer's attention to Article 820-40 of the NEC that provides guidelines for proper grounding and, in particular, specifies that the cable ground shall be connected to the grounding system of the building, as close as possible to the point of cable entry as practical.

EXAMPLE OF ANTENNA GROUNDING

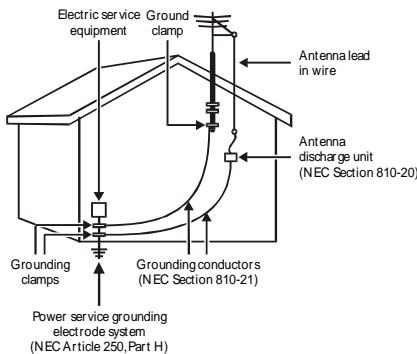

NEC=NATIONAL ELECTRICAL CODE

IMPORTANT SAFETY INSTRUCTIONS

- 1** Read these instructions.
- 2** Keep these instructions.
- 3** Heed all warnings.
- 4** Follow all instructions.
- 5** Do not use this apparatus near water.
- 6** Clean only with dry cloth.
- 7** Do not block any ventilation openings. Install in accordance with the manufacturers instructions.
- 8** Do not install near any heat sources such as radiators, heat registers, stoves, or other apparatus (including amplifiers) that produce heat.
- 9** Do not defeat the safety purpose of the polarized or grounding-type plug. A polarized plug has two blades with one wider than the other. A grounding type plug has two blades and a third grounding prong. The wide blade or the third prong are provided for your safety. If the provided plug does not fit into your outlet, consult an electrician for replacement of the obsolete outlet.
- 10** Protect the power cord from being walked on or pinched particularly at plugs, convenience receptacles, and the point where they exit from the apparatus.
- 11** Only use attachments/accessories specified by the manufacturer.
- 12** Unplug this apparatus during lightning storms or when unused for long periods of time.
- 13** Refer all servicing to qualified service personnel. Servicing is required when the apparatus has been damaged in any way, such as the power-supply cord or plug is damaged, liquid has been spilled or objects have fallen into the apparatus, the apparatus has been exposed to rain or moisture, does not operate normally, or has been dropped.

Regulatory Information

Federal Communications Commission Radio and Television Interface Statement for a Class 'B' Device

This equipment has been tested and found to comply with the limits for a Class B digital device, pursuant to part 15 of the FCC Rules. These limits are designed to provide reasonable protection against harmful interference in the residential installation. This equipment generates, uses and can radiate radio frequency energy and, if not installed and used in accordance with the instructions, may cause harmful interference to radio communications. However, there is no guarantee that interference will not occur in a particular installation.

If the equipment does cause harmful interference to radio or television reception, which can be determined by turning the equipment off and on, the user is encouraged to try to correct the interference by one of the following measures:

- Increase the separation between the equipment and the affected receiver
- Connect the equipment on a circuit different from the one the receiver is on
- Ensure that the cover plate for the security card is secured and tight

Changes or modification not expressly approved by the party responsible for compliance could void the user's authority to operate the equipment.

Declaration of Conformity

According to 47 CFR, Parts 2 and 15 for Class B Personal Computers and Peripherals; and/or CPU Boards and Power Supplies used with Class B Personal Computers, Motorola, Inc., 6450 Sequence Drive, San Diego, CA 92121, 1-800-225-9446, declares under sole responsibility that the product identifies with 47 CFR Part 2 and 15 of the FCC Rules as a Class B digital device. Each product marketed is identical to the representative unit tested and found to be compliant with the standards. Records maintained continue to reflect the equipment being produced can be expected to be within the variation accepted, due to quantity production and testing on a statistical basis as required by 47 CFR 2.909. Operation is subject to the following condition: This device must accept any interference received, including interference that may cause undesired operation. The above named party is responsible for ensuring that the equipment complies with the standards of 47 CFR, Paragraphs 15.101 to 15.109. The Class B digital apparatus meets all requirements of the Canadian Interface Causing Equipment Regulations.

Canadian Compliance

This Class B digital device complies with Canadian ICES-003. Cet appareil numérique de la classe B est conforme à la norme NMB-003 du Canada.

Caring for the Environment by Recycling

When you see this symbol on a Motorola product, do not dispose of the product with residential or commercial waste.



Recycling your Motorola Equipment

Please do not dispose of this product with your residential or commercial waste. Some countries or regions, such as the European Union, have set up systems to collect and recycle electrical and electronic waste items. Contact your local authorities for information about practices established for your region. If collection systems are not available, call Motorola Customer Service for assistance.

Software License

IMPORTANT: PLEASE READ THIS SOFTWARE LICENSE ("LICENSE") CAREFULLY BEFORE YOU USE ANY SOFTWARE, FIRMWARE AND RELATED DOCUMENTATION ("SOFTWARE") PROVIDED WITH MOTOROLA'S DIGITAL CABLE RECEIVER OR HOME THEATER SYSTEM (EACH SHALL BE REFERRED TO IN THIS LICENSE AS A "RECEIVER"). BY USING THE RECEIVER AND/OR USING ANY OF THE SOFTWARE, YOU INDICATE YOUR ACCEPTANCE OF EACH OF THE TERMS OF THIS LICENSE. UPON ACCEPTANCE, THIS LICENSE WILL BE A LEGALLY BINDING AGREEMENT BETWEEN YOU AND MOTOROLA. THE TERMS OF THIS LICENSE APPLY TO YOU AND TO ANY SUBSEQUENT USER OF THIS SOFTWARE.

IF YOU DO NOT AGREE TO ALL OF THE TERMS OF THIS LICENSE (I) DO NOT USE THE SOFTWARE AND (II) RETURN THE RECEIVER AND THE SOFTWARE (COLLECTIVELY, "PRODUCT"), INCLUDING ALL COMPONENTS, DOCUMENTATION AND ANY OTHER MATERIALS PROVIDED WITH THE PRODUCT, TO YOUR POINT OF PURCHASE OR SERVICE PROVIDER, AS THE CASE MAY BE, FOR A FULL REFUND.

The Software includes associated media, any printed materials, and any "on-line" or electronic documentation. Software provided by third parties may be subject to separate end-user license agreements from the manufacturers of such Software. The Software is never sold. Motorola licenses the Software to the original customer and to any subsequent licensee for personal use only on the terms of this License. Motorola and its third party licensors retain the ownership of the Software.

You may:

USE the Software only in connection with the operation of the Product.

TRANSFER the Software (including all component parts and printed materials) permanently to another person, but only if the person agrees to accept all of the terms of this License. If you transfer the Software, you must at the same time transfer the Product and all copies of the Software (if applicable) to the same person or destroy any copies not transferred.

TERMINATE this License by destroying the original and all copies of the Software (if applicable) in whatever form.

You may not:

(1) Loan, distribute, rent, lease, give, sublicense or otherwise transfer the Software, in whole or in part, to any other person, except as permitted under the TRANSFER paragraph above. (2) Copy or translate the User Guide included with the Software, other than for personal use. (3) Copy, alter, translate, decompile, disassemble or reverse engineer the Software, including but not limited to, modifying the Software to make it operate on non-compatible hardware. (4) Remove, alter or cause not to be displayed, any copyright notices or startup message contained in the Software programs or documentation. (5) Export the Software or the Product components in violation of any United States export laws.

The Product is not designed or intended for use in on-line control of aircraft, air traffic, aircraft navigation or aircraft communications; or in design, construction, operation or maintenance of any nuclear facility. MOTOROLA AND ITS THIRD PARTY LICENSORS DISCLAIM ANY EXPRESS OR IMPLIED WARRANTY OF FITNESS FOR SUCH USES. YOU REPRESENT AND WARRANT THAT YOU SHALL NOT USE THE PRODUCT FOR SUCH PURPOSES.

Title to this Software, including the ownership of all copyrights, mask work rights, patents, trademarks and all other intellectual property rights subsisting in the foregoing, and all adaptations to and modifications of the foregoing shall at all times remain with Motorola and its third party licensors. Motorola retains all rights not expressly licensed under this License. The Software, including any images, graphics, photographs, animation, video, audio, music and text incorporated therein is owned by Motorola or its third party licensors and is protected by United States copyright laws and international treaty provisions. Except as otherwise expressly provided in this License, the copying, reproduction, distribution or preparation of derivative works of the Software, any portion of the Product or the documentation is strictly prohibited by such laws and treaty provisions. Nothing in this License constitutes a waiver of Motorola's rights under United States copyright law.

This License and your rights regarding any matter it addresses are governed by the laws of the Commonwealth of Pennsylvania, without reference to conflict of laws principles. THIS LICENSE SHALL TERMINATE AUTOMATICALLY if you fail to comply with the terms of this License.

Motorola is not responsible for any third party software that is provided as a bundled application, or otherwise, with the Software or that is downloaded to, or otherwise installed on, the Product.

U.S. GOVERNMENT RESTRICTED RIGHTS

The Product and documentation is provided with RESTRICTED RIGHTS. The use, duplication or disclosure by the Government is subject to restrictions as set forth in subdivision (c)(1)(ii) of The Rights in Technical Data and Computer Software clause at 52.227-7013. The contractor/manufacturer is Motorola, Inc., Broadband Communications Sector, 101 Tournament Drive, Horsham, PA 19044.

Contact Us

For technical support for your cable terminal, call Motorola Support at **1-866-668-2271** or **1-866-MOT-BCS1**.

For questions about your cable TV service, call your cable provider.

For Motorola consumer cable products, education, and support:
<http://www.motorola.com/broadband>

For an overview of high definition television (HDTV):
<http://broadband.motorola.com/consumers/hdtv/default.asp>

Copyright © 2005 Motorola, Inc.

All rights reserved. No part of this publication may be reproduced in any form or by any means or used to make any derivative work (such as translation, transformation or adaptation) without written permission from Motorola, Inc.

Motorola reserves the right to revise this publication and to make changes in content from time to time without obligation on the part of Motorola to provide notification of such revision or change. Motorola provides this guide without warranty of any kind, either implied or expressed, including but not limited to, the implied warranties of merchantability and fitness for a particular purpose. Motorola may make improvements or changes in the product(s) described in this manual at any time.

MOTOROLA and the Stylized M Logo are registered in the US Patent & Trademark Office. Dolby Digital manufactured under license from Dolby Laboratories Licensing Corporation. Dolby, Dolby Digital, ProLogic and the double-D symbol are registered trademarks of Dolby Laboratories. HDMI, the HDMI logo and High-Definition Multimedia Interface are trademarks or registered trademarks of HDMI Licensing LLC. All other product or service names are the property of their respective owners.

© Motorola, Inc. 2005

CONTENTS

Introduction	3
Operation	6
Turning Power On and Off	6
Changing Channels	6
Adjusting the Volume	6
Interactive Program Guide	6
Digital Video Recorder (DVR)	7
Optimizing Your Cable Terminal For High Definition TV	8
On-Screen Graphics	12
Connecting Your Cable Terminal	13
Video Connection Options	14
Important Safety Considerations	15
Connecting To an HDTV – Video Only	16
Connecting HDTV – Video Only	17
Connecting To an HDTV – Audio Only	18
Connecting HDTV – Audio Only	19
Connecting To an A/V Receiver – Audio Only	20
Connecting an A/V Receiver – Audio Only	21
Connecting To a Stereo TV	22
Connecting a Stereo TV	23
Connecting to a Stereo TV and Stereo VCR	24
Connecting a Stereo TV and Stereo VCR	25
Connecting to an A/V Receiver, TV, and VCR	26
Connecting an A/V Receiver, TV, and VCR	27



MOTOROLA

Recording Your Connections	28
Data Devices	29
Troubleshooting	30

INTRODUCTION

Congratulations on receiving a Motorola DCT3400 Series High Definition Advanced DVR Cable Terminal. Motorola has merged the extraordinary features of digital cable – the seemingly endless programming options, interactive program guides, video on demand (VoD), and commercial free, CD quality music – with the flexibility of a dual tuner digital video recorder (DVR) and the incredible picture quality and sound of high definition TV (HDTV). HDTV provides up to twice the color resolution and up to six times the sharpness of standard definition TV.

The DCT3400 enables a direct digital connection to consumer audio and video devices through IEEE-1394 DTV and HDMI[®] interfaces. It contains a hard drive for hours of DVR functionality, including recording high definition (HD) programs and watch and record functionality.

This User Guide introduces the basic features, outlines important safeguards, and provides options for integrating your cable terminal into your entertainment system. Please take a few moments to read through this User Guide. The configuration diagrams, on-screen menu description, and troubleshooting section will help you make the most of your home entertainment experience.

To determine which digital cable features are provided in your area, please check with your cable operator. They will be happy to provide instructions for these optional services.

In this guide, “DCT3400” refers to all DCT3400 Series cable terminals, including the DCT3412 and DCT3416.



MOTOROLA

FRONT PANEL

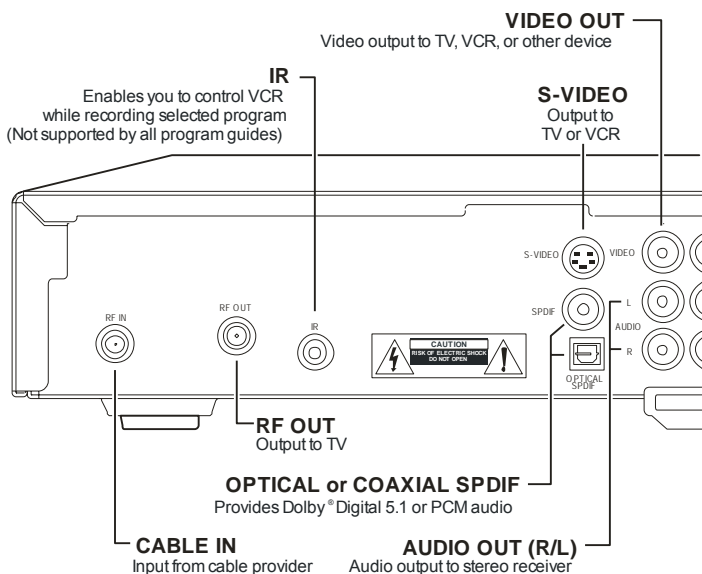
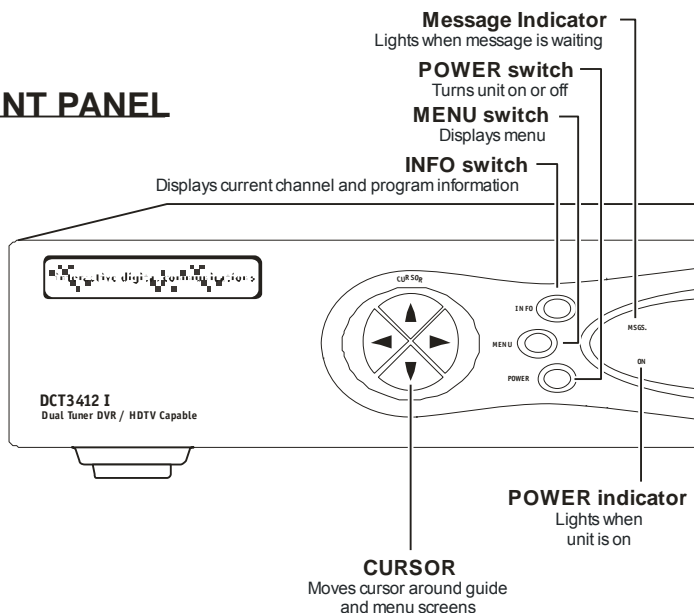

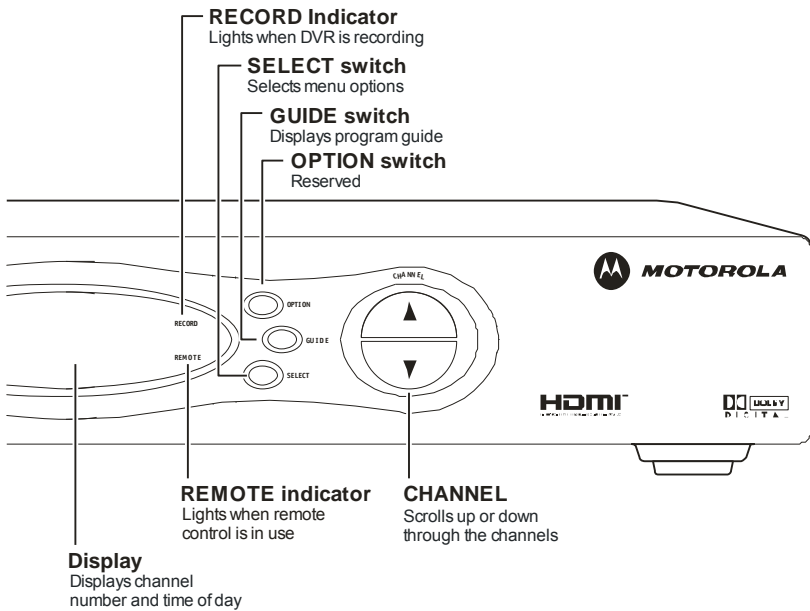

BACK PANEL

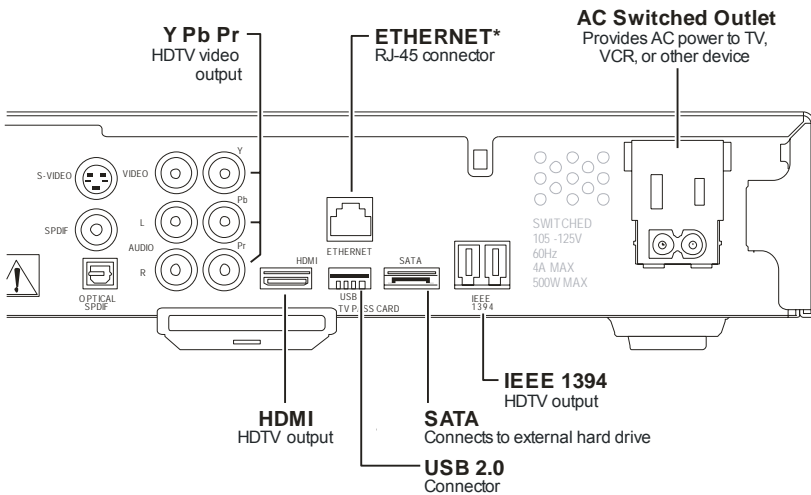

* Your DCT3400 may not support all of the inputs and outputs shown.



OPERATION

Turning Power On and Off

Press **POWER** on the front panel to turn the cable terminal on or off. When using the remote control, be sure it is in cable mode by pressing **CABLE** before pressing **POWER**.

Changing Channels

You can change channels in two ways:

- Press **CHANNEL ▲** or **▼** on the cable terminal front panel, or press **CHANNEL +** or **-** on the remote control to step through the channel selection.
- Enter the number of the channel you wish to view using the number keys on the remote control.

Adjusting the Volume

Press **VOLUME +** or **-** on the remote control to adjust the volume. When you adjust the volume, the volume scale is displayed on the screen. Press **MUTE** on the remote control to turn the sound off and on again.

For best audio quality, use the remote control to set the cable terminal to approximately $\frac{3}{4}$ of the maximum volume level and then adjust the audio levels on external devices such as your TV or A/V Receiver.

Interactive Program Guide

The interactive program guide (IPG) displays information about TV programs and enables you to access features such as Parental Control or Pay-Per-View. IPGs can vary with each cable provider. Refer to your IPG manual for detailed instructions.

DIGITAL VIDEO RECORDER (DVR)

The DCT3400 contains a hard drive for the digital video recorder (DVR) to record standard- and high-definition TV (HDTV) programs.

A standard VCR records and plays analog video. DVR records and plays digital video. Unlike an analog tape, the hard drive allows simultaneous recording and playback.

A DVR offers the ability to control your viewing experience by pausing (time shifting) live TV and providing trick playback modes (pause, fast forward, slow forward, fast rewind, slow rewind). You may experience a slight delay between time shifted and live TV.

With the DCT3400, you can:

Record Programming

Record hours of TV programming. The total hours of recorded content depends on your hard drive capacity and content type (digital, analog, or HD) that you record.

Maintain a Personal Program Library

Maintain a personal library of recorded programming, accessed using the interactive program guide (IPG).

Control Live TV

Pause, rewind, or fast-forward live TV.

Simultaneously Watch Two Programs

Watch two programs and easily switch between them using the **SWAP** key on your remote control. (Dependent upon program guide support.)

Simultaneous Watch and Record

Record one program in the background while viewing another live broadcast at the same time.

Simultaneously Record Two Shows

Record two programs from two different channels at the same time.

Simultaneously Record Two Shows and Watch a Recorded Program

Watch a recorded program while recording up to two other programs at the same time. You can also easily switch viewing the pre-recorded program and either of the programs you're recording.



OPTIMIZING YOUR CABLE TERMINAL FOR HIGH DEFINITION TV

The DCT3400 outputs HD video through its Y Pb Pr (component), HDMI, or IEEE 1394 connectors. This section describes how to optimize standard and HD video based on your HDTV and personal preferences.

If you use the IEEE 1394 output, no adjustments to the settings are required.

For a TV with an HDMI connection, be sure the TV is on and connected to the HDMI OUT connector before adjusting the settings. Motorola recommends using HDMI cables less than 20 meters long.

You can configure the TV type, HDMI and/or Y Pb Pr video output, and closed captioning.

To optimize the output settings:

- 1 Be sure your cable terminal is plugged into a power outlet and connected to your TV.
- 2 Power off the cable terminal and then immediately press the **MENU** key on the front panel. If your TV is on, the on-screen menu lists the settings you can configure:

USER SETTINGS	
> TV TYPE	16:9
HDMI/YpbPr OUTPUT	1080i
4:3 OVERRIDE	480i
CLOSED CAPTION	DISABLED
SERVICE SELECTION	
ANALOG	CC1
DIGITAL	PRIMARY LANGUAGE
FONT SIZE	AUTO
FONT COLOR	AUTO
FONT OPACITY	AUTO
FONT EDGE TYPE	AUTO
FONT EDGE COLOR	AUTO
BACKGROUND COLOR	AUTO
BACKGROUND OPACITY	AUTO
SETTINGS	AUTO
RESTORE ALL DEFAULTS	

Use your remote control or the cursor keys on the front panel to navigate the on-screen display:

- Press the ▲ and ▼ keys to highlight the setting you wish to change.
- Press the ► key to select an option.
- To exit the setting and move to another setting, use the ▲ and ▼ keys.

If the User Settings menu does not display on the HDTV screen, the TV may not support the default video output setting. Use the front panel LED to adjust the settings as described in “There is no video on the TV screen” in “Troubleshooting.”

For a TV with an HDMI connection, be sure the TV is on and connected to the DCT3400 HDMI OUT connector before adjusting the settings.

The User Settings menu options are:

Setting	Description
TV Type	<p>Sets the aspect ratio. The front panel display indicates the type you select. Defaults to 16:9. Options are 16:9 for wide screen TVs or 4:3 LETTERBOX or 4:3 PAN/SCAN for standard TVs:</p> <ul style="list-style-type: none">• 4:3 LETTERBOX fits widescreen programming on the screen by placing black bars at the top and bottom.• 4:3 PAN/SCAN fills the screen by cropping the left and right edges of widescreen programming.
HDMI/YPbPr Output	<p>Sets the video display format for the HDMI or component video outputs. The front panel display indicates the format you select. Defaults to 1080i. Options are 1080i, 720p, 480p, or 480i. For HDMI <i>only</i>, additional options you can use to display video on a computer monitor are PC1-VGA (640x480) and PC2-XVGA (800x600).</p> <p>Some TVs only support certain display formats. Check your TV user manual for more information.</p> <p>If you are not using the HDMI connection, the HDMI/YPbPr OUTPUT setting displays as YPbPr OUTPUT.</p>



Setting	Description
4:3 Override	<p>Sets the display format for 4:3 standard-definition programming. If the YPbPr Output is set to 1080i, 720p, or 480p, this setting defaults to 480i. If the YPbPr Output is set to 480i, this setting defaults to OFF and cannot be changed. Options are:</p> <ul style="list-style-type: none">• OFF displays non-high-definition programs having a 4:3 aspect ratio in wide screen format. On an HDTV, black bars display on the left and right of the picture. Selecting OFF for a 4:3 TV may result in a small picture with black bars around it.• 480i displays non-high-definition programs in their original 480i format. Some TVs cannot display 480i format on their component video inputs (YPbPr). Check the TV user manual for more information.• 480p converts non-high-definition TV programs to a higher-quality 480p format. Some TVs cannot display 480p format on their component video inputs (YPbPr). Check the TV user manual for more information.• Stretch automatically stretches all standard definition programming to fill your widescreen display. Stretch can only be selected if you have TV Type set to 16:9.
Closed Caption	<p>Turns closed captions off or on. The front panel display indicates the status of the closed captions. Defaults to DISABLED. Options are ENABLED or DISABLED.</p>
Closed Caption	<p>Turns closed captions off or on. The LED panel displays the status of the closed captions. Defaults to DISABLED. Options are ENABLED or DISABLED.</p>
Service Selection	<p>Sets the service used for closed captions:</p> <ul style="list-style-type: none">• Analog: CC1, CC2, CC3, CC4, T1, T2, T3, or T4. The default is CC1.• Digital: PRIMARY LANGUAGE, SECONDARY LANGUAGE, 3, 4, 5, or 6. The default is PRIMARY LANGUAGE.
Font Size	<p>Sets the font size for closed captions. Defaults to AUTO. Options are AUTO, STANDARD, LARGE, or SMALL.</p>
Font Style	<p>Sets the font style. Defaults to AUTO. Options are AUTO, MONO SERIF, PROPORTION SERIF, MONO NO SERIF, PROPORTION NO SERIF, CASUAL, CURSIVE, or SMALL.</p>

Setting	Description
Font Color	Sets the font color. Defaults to AUTO. Options are AUTO, WHITE, BLACK, RED, GREEN, BLUE, YELLOW, MAGENTA, or CYAN.
Font Opacity	Sets the opacity. Defaults to AUTO. Options are AUTO, TRANSPARENT, TRANSLUCENT, SOLID, or FLASHING.
Font Edge Type	Sets the edge appearance — AUTO, NONE, RAISED, DEPRESSED, UNIFORM, LEFT SHADOWED, or RIGHT SHADOWED. The default is AUTO.
Font Edge Color	Sets the edge color — AUTO, WHITE, BLACK, RED, GREEN, BLUE, YELLOW, MAGENTA, or CYAN. The default is AUTO.
Background Color	Sets the background color for closed captions. Defaults to AUTO. Options are AUTO, WHITE, BLACK, RED, GREEN, BLUE, YELLOW, MAGENTA, or CYAN.
Background Opacity	Sets the background opacity for closed captions. Defaults to AUTO. Options are AUTO, TRANSPARENT, TRANSLUCENT, SOLID, or FLASHING.
Settings	Sets the default settings for closed captions (AUTO) or the settings you have configured (USER). Defaults to AUTO. Options are AUTO or USER.
Restore All Defaults	<p>To reset all User Settings to their defaults, select this option and press the ► key.</p> <p>For HDMI only, when you first connect a TV to the DCT3400 using the HDMI connection, the TV and the DCT3400 exchange information to automatically determine the best possible TV TYPE and HDMI/YPbPr OUTPUT settings. You can change these settings at any time:</p> <ul style="list-style-type: none">• To cause the HDMI TV and DCT3400 to re-exchange information to restore the automatic settings, select Restore All Defaults with the HDMI connection in place and the TV powered on.• If you connect another HDMI TV to the DCT3400, select Restore All Defaults. This causes the TV and DCT3400 to exchange information, enabling settings suited to your new TV.

To exit the menu and save your settings, press the **POWER** or **MENU** key.



MOTOROLA

ON-SCREEN GRAPHICS

The DCT3400 can generate on-screen graphics that overlay the video programming or fill the entire television screen. Common examples include on-screen menus (such as the User Setting menu), closed captions, and interactive program guides. The cable terminal overlays these graphics whenever you display a menu, enable closed captions, or scroll through a program grid.

On-screen graphics are available for all DCT3400 video outputs except IEEE 1394.

CONNECTING YOUR CABLE TERMINAL

This section describes connecting the cable terminal to your home entertainment system.

Instructions and diagrams are included for connections to:

- High definition television (HDTV)
- A/V Receiver – Audio
- Stereo TV
- Stereo TV and Stereo VCR
- A/V Receiver, TV, and VCR

Before you move or change components on your entertainment system, review the following:

- For basic cable connections, use 75-ohm coaxial cables equipped with F-type connectors.
- Disconnect power from the cable terminal before connecting or changing cable connections.

For information on connecting for HDTV, see “Video Options” on the next page.

CAUTION!



Do not place anything on top of the cable terminal, especially other home entertainment components. Be sure to provide adequate ventilation to prevent overheating.



Video Connection Options

The DCT3400 offers the following video outputs:

HDTV Component video, HDMI, or IEEE 1394

Standard Composite video, S-Video, or RF coaxial

To determine the available inputs on your TV, check the manual supplied with the TV or the TV itself.

Use the following guidelines to determine the best video connection for your home entertainment system:

- **Component video (Y Pb Pr) – HDTV and standard**

The Y, Pb, and Pr outputs provide component video, which is the most widely supported HDTV connection.

- **HDMI or IEEE 1394 – HDTV and standard**

HDMI and IEEE 1394 offer higher video quality than component video. If your TV has an HDMI input, use the HDMI output instead of IEEE 1394. *Motorola recommends using HDMI cables less than 20 meters long.*

HDMI and IEEE 1394 are video *and* audio connections. If you use HDMI or IEEE 1394, no separate audio connection to your TV is required.

HDMI is compatible with DVI. *If your TV has a DVI input, you can use an HDMI-to-DVI converter cable to connect to the DCT3400 HDMI connector.*

If you use IEEE 1394, on-screen graphics do not display.

- **S-Video – standard only**

If your TV has an S-Video input, use S-Video. S-Video is the highest quality standard-definition video output on the DCT3400.

- **Composite video – standard only**

If your TV does not have an S-Video input, use the composite video (VIDEO) output.

- **RF coaxial – standard only**

If your TV only has a coaxial RF input, connect it to the DCT3400 RF OUT connector.

Important Safety Considerations

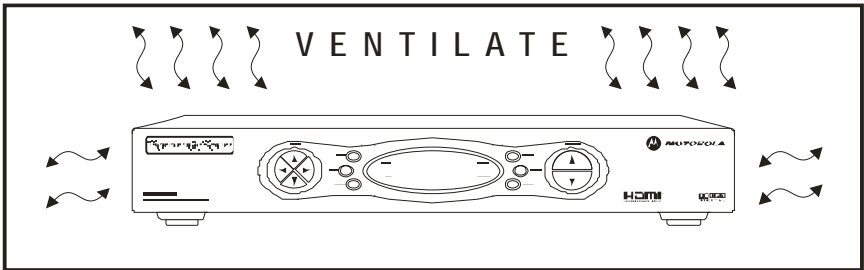

Follow these important safety guidelines when positioning and connecting your cable terminal:

- Position the cable terminal with at least 2 inches of space above and on all sides
- Do not block the slots and openings
- Do not place anything on top of the cable terminal
- Do not position the cable terminal in an enclosed space that would restrict airflow around the unit
- Do not position the cable terminal near any external heat source that could raise the temperature around the unit. Do not place the terminal on top of another heat-producing electronic device.
- Allow for adequate ventilation around the cable terminal to maintain normal operating temperature. Do not place it in a sealed enclosure without providing for adequate airflow.
- Do not plug the AC power cord into a switched power outlet.

CONNECTING TO AN HDTV – VIDEO ONLY



HDMI connection



Component video connection



IEEE 1394 connection

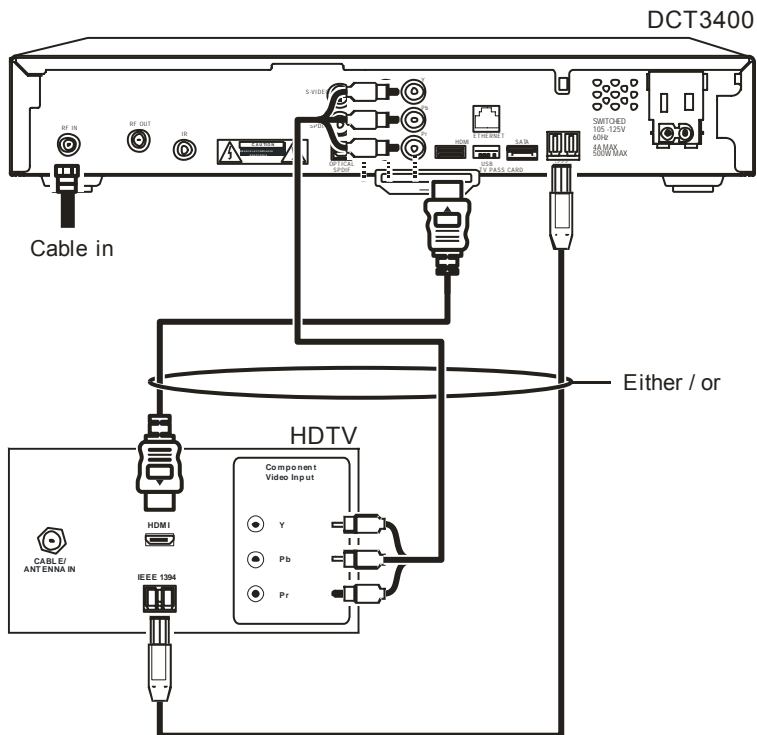

Connecting HDTV – Video Only

- 1 Connect an RF coaxial cable to the cable wall outlet and the **CABLE IN** connector on the cable terminal.
- 2 Connect the HDTV using component video, HDMI, or IEEE 1394.

Component video (Y Pb Pr)

Connect the component video cables to the **Y**, **Pb**, and **Pr** connectors on your cable terminal and the HDTV.

This connection carries video only. To connect the audio connections for your HDTV, refer to the following page. To connect your audio connections for a home theater receiver, refer to “Connecting To an A/V Receiver – Audio Only.”

HDMI

If your HDTV has a HDMI input, connect an HDMI cable less than 20 meters long to the **HDMI OUT** connector on your HDTV and the DCT3400.

If you use the TV as the primary audio source or your home theater receiver has an HDMI input and output, the HDMI connection carries video and audio.

If your TV has a DVI input, you can use an HDMI-to-DVI converter cable to connect to the DCT3400 HDMI connector.

For information on configuring your DCT3400 settings, see “Optimizing Your Cable Terminal for High Definition TV.”

IEEE 1394

If your HDTV has an IEEE 1394 connector, you can connect an IEEE 1394 cable to the **IEEE 1394** connector on your HDTV and the cable terminal.

If you use the TV as the primary audio source, the IEEE 1394 connection carries video and audio.

If you use the IEEE 1394 connection, on-screen graphics cannot display.

CONNECTING TO AN HDTV – AUDIO ONLY

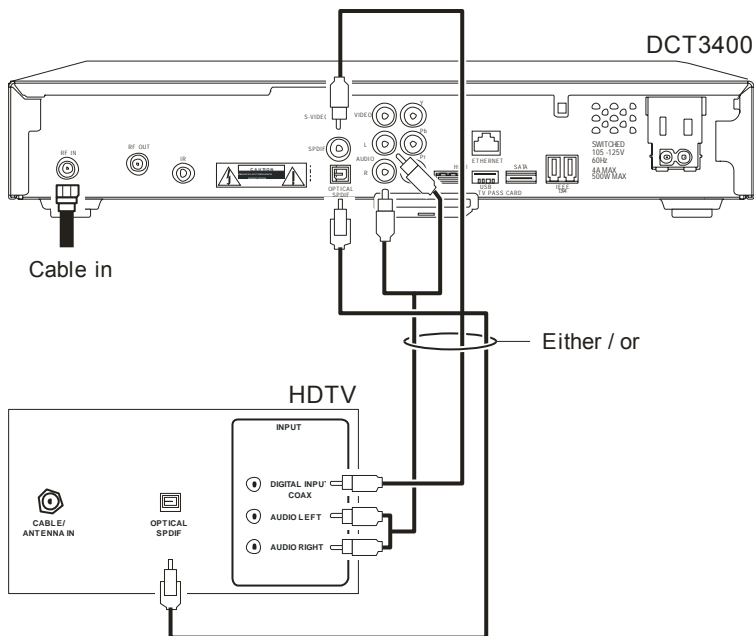
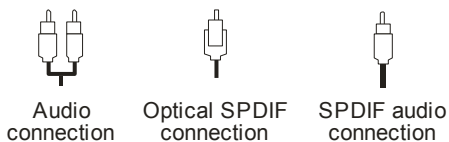

Connecting HDTV – Audio Only

Connect the stereo audio cable to the **AUDIO R** and **L** connectors on the cable terminal and the corresponding connectors on the HDTV.

If your equipment supports it, use the **OPTICAL SPDIF** or coaxial digital **SPDIF** outputs instead of the **AUDIO R** and **L** outputs. In most cases, S/PDIF offers better audio quality, including support for Dolby 5.1 Surround Sound.

HDMI and IEEE1394 carry video and audio. If you connect the DCT3400 to your HDTV using HDMI or IEEE1394, no additional audio connections to the TV are necessary.

For information on configuring your DCT3400 settings, see “Optimizing Your Cable Terminal for High Definition TV.”

CONNECTING TO AN A/V RECEIVER – AUDIO ONLY



Audio connection



SPDIF audio connection



Optical SPDIF connection

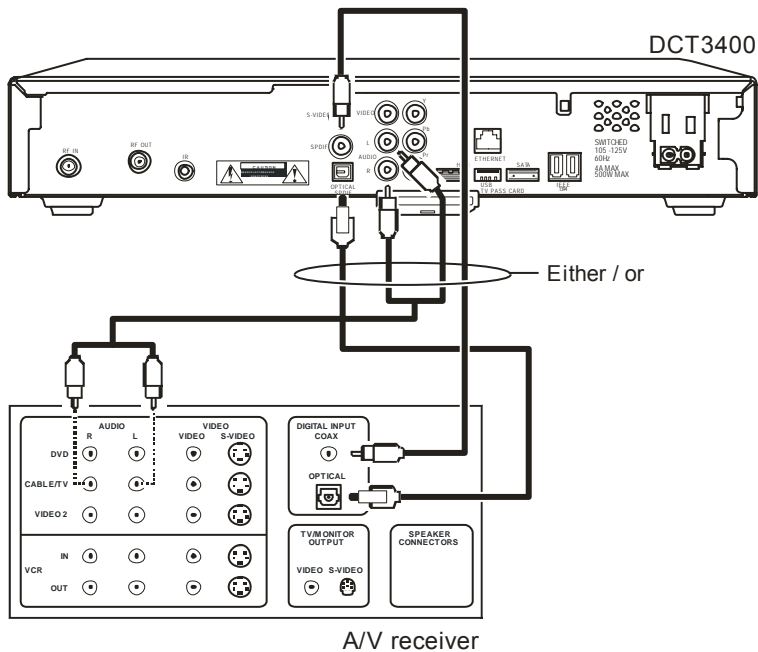

Connecting an A/V Receiver – Audio Only

The audio connections options to your A/V receiver or home theater receiver are:

- **Optical SPDIF:** Connect the optical SPDIF cable to the **OPTICAL SPDIF** connector on the cable terminal and the corresponding connector on the A/V receiver.
- **Coaxial SPDIF:** Connect the digital audio cable to the SPDIF connector on the cable terminal and the corresponding connector on the A/V receiver.
- **Stereo audio R and L:** Connect the stereo audio cable to the **AUDIO R** and **L** connectors on the cable terminal and the corresponding connectors on the A/V receiver.

If your A/V receiver supports it, use the OPTICAL SPDIF or coaxial SPDIF outputs on the cable terminal instead of its stereo AUDIO R and L outputs. In most cases, S/PDIF offers better audio quality, including support for Dolby 5.1 Surround Sound.

For information on configuring your cable terminal settings, see “Optimizing Your Cable Terminal for High Definition TV.”

CONNECTING TO A STEREO TV

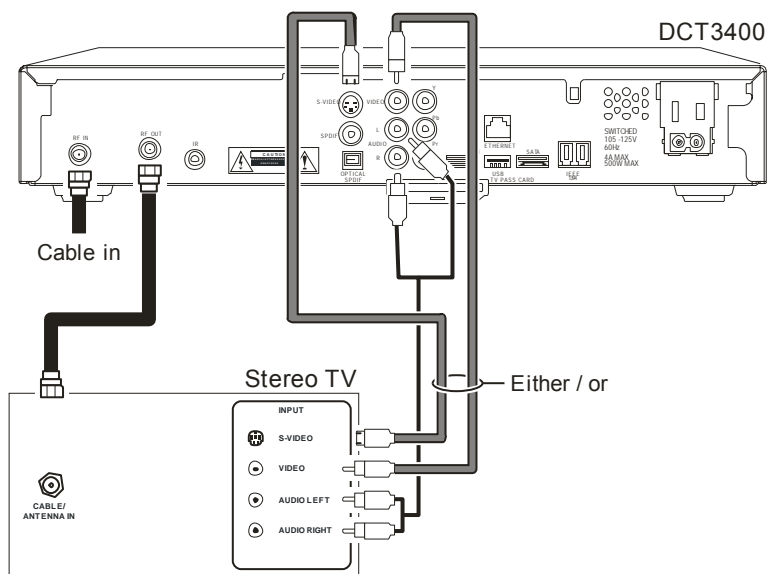
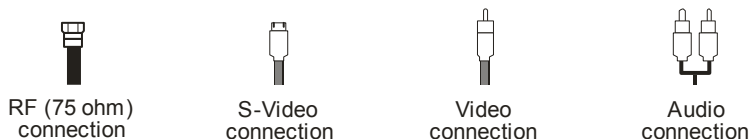

Depending on the TV's inputs:

- 1 If possible, use the S-VIDEO and AUDIO connectors on the DCT3400.
- 2 If the TV has no S-Video input, use the composite VIDEO and AUDIO connectors on the DCT3400.
- 3 If the TV has an RF input *only*, use the RF OUT connector on the cable terminal. The RF connection carries video and audio.

Connecting a Stereo TV

- 1 Connect an RF coaxial cable to the cable wall outlet and the **CABLE IN** connector on the cable terminal.
- 2 Connect the stereo audio cable to the **AUDIO R** and **L** connectors on the cable terminal and the corresponding connectors on the stereo TV.
- 3 Connect an S-video cable to the **S-VIDEO** connectors on the cable terminal and the TV.
or
Connect a video cable to the **VIDEO OUT** connector on the cable terminal and the **VIDEO IN** connector on the TV.

OR

- 1 Connect an RF coaxial cable to the cable wall outlet and the **CABLE IN** connector on the cable terminal.
- 2 Connect an RF coaxial cable to the **RF OUT** connector on the cable terminal and the RF connector on the TV.

This video connection method does not support HD video. For more information, see “Connecting an HDTV – Video Only.”

CONNECTING TO A STEREO TV AND STEREO VCR



RF (75 ohm)
connection



Video
connection



Audio
connection

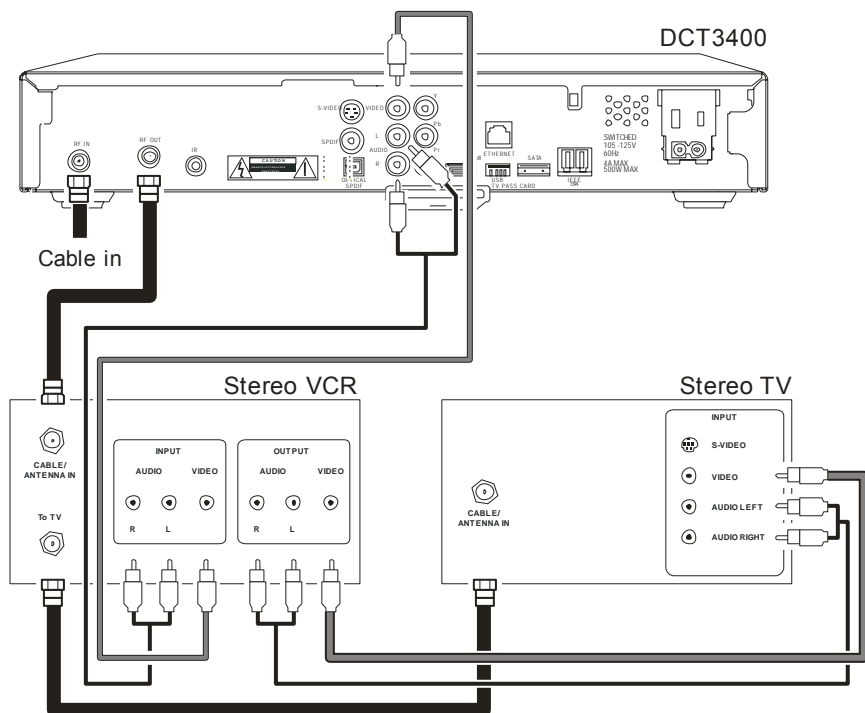

Connecting a Stereo TV and Stereo VCR

- 1 Connect an RF coaxial cable to the cable wall outlet and the **CABLE IN** connector on the cable terminal.
- 2 Connect a stereo audio cable to the **AUDIO OUT R** and **L** connectors on the cable terminal and the **INPUT AUDIO R** and **L** connectors on the stereo VCR.
- 3 Connect a video cable to the **VIDEO OUT** connector on the cable terminal and the **INPUT VIDEO** connector on the stereo VCR.
- 4 Connect a stereo audio cable to the **OUTPUT AUDIO R** and **L** connectors on the stereo VCR and the **INPUT AUDIO RIGHT** and **LEFT** connectors on the stereo TV.
- 5 Connect a video cable to the **OUTPUT VIDEO** connector on the stereo VCR and the **INPUT VIDEO** connector on the stereo TV.

This video connection method does not support HD video. For more information, see “Connecting to an HDTV – Video Only.”

Connecting an A/V Receiver, TV, and VCR

- 1 Connect an RF coaxial cable to the cable wall outlet and the **CABLE IN** connector on the cable terminal.
- 2 Connect a stereo audio cable to the **AUDIO OUT R** and **L** connectors on the cable terminal and the **INPUT R** and **L** connectors on the A/V receiver.
- 3 Connect a video cable to the **VIDEO OUT** connector on the cable terminal and the **CABLE/TV VIDEO** connector on the A/V receiver.
- 4 Connect a stereo audio cable to the **VCR AUDIO OUT R** and **L** connectors on the A/V receiver and the **INPUT AUDIO R** and **L** connectors on the stereo VCR.
- 5 Connect a stereo audio cable to the **OUTPUT AUDIO OUT R** and **L** connectors on the stereo VCR and the **VCR AUDIO IN R** and **L** connectors on the A/V receiver.
- 6 Connect a video cable to the **INPUT VIDEO** connector on the stereo VCR and the **VIDEO VCR OUT** connector on the A/V receiver.
- 7 Connect a video cable to the **OUTPUT VIDEO** connector on the stereo VCR and the **VIDEO VCR IN** connector on the A/V receiver.
- 8 Connect a video cable to the **INPUT VIDEO** connector on the stereo TV and the **TV/MONITOR OUTPUT** video connector on the A/V receiver.

If you can:

- Use the **OPTICAL SPDIF** or **coaxial SPDIF** outputs instead of the **stereo AUDIO R** and **L** outputs. In most cases, **S/PDIF** offers better audio quality, including support for **Dolby 5.1 Surround Sound**.
- Use the **S-video** connections instead of the standard **RCA video** connections. In most cases, **S-video** offers better video quality.

This video connection method does not support HD video. For more information, see “Connecting to an HDTV – Video Only.”

RECORDING YOUR CONNECTIONS

Use this diagram to record connections between your home entertainment components. You can use this diagram to reconnect your system if you move the equipment or add new equipment.

Disconnect the power from the cable terminal before connecting or changing cable connections. Do not place another component or object on top of the cable terminal.

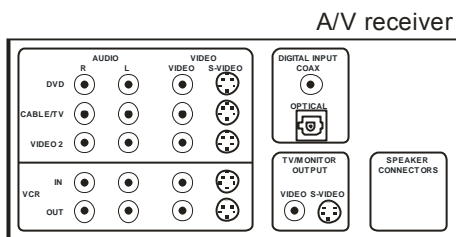
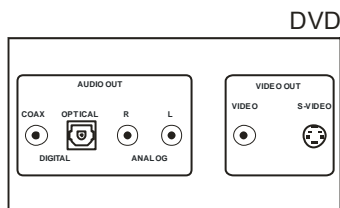
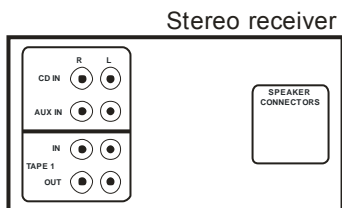
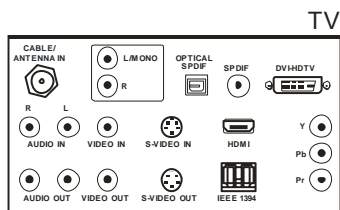
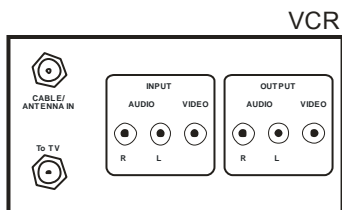
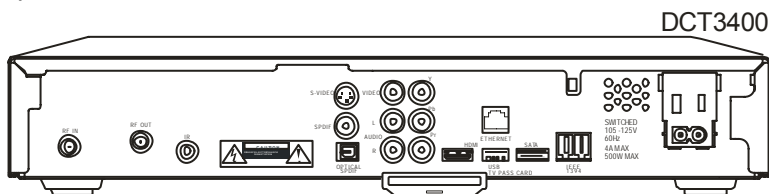

DATA DEVICES

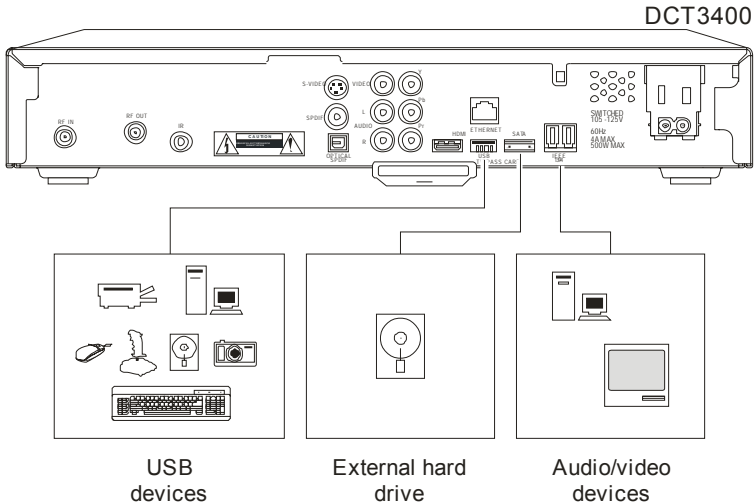

Do not attempt to connect data devices without contacting your service provider. Advanced data features require the proper application and network infrastructure to operate.

In addition to high quality audio and video, the DCT3400 can deliver high-speed data services such as Internet access, e-mail, IP Telephony, E-Commerce, and home banking.

The functionality of the illustrated interfaces depends on the services offered by your service provider.



TROUBLESHOOTING

Before calling your service provider, review this troubleshooting guide. This information is to help you quickly solve a problem. If your problem still exists, contact your service provider.

Problem	Possible Solution
The cable terminal will not power on	<p>The cable terminal may have received a software update and may not power on while the new software is being installed. Try again in a few minutes.</p> <p>Verify that the AC power cord is connected to the cable terminal and an AC outlet. Unplug the cable terminal from the AC outlet, plug it back in, and then press the POWER button.</p> <p>If the cable terminal is connected to a switched outlet on another unit, verify that that unit is powered on.</p> <p>Press the POWER button on the cable terminal front panel instead of the remote control. The batteries in the remote control may be depleted.</p>
The remote control does not work	<p>Verify that the remote control is in “Cable” mode.</p> <p>Verify that there are no obstructions between the remote control and the cable terminal. Aim the remote control directly at the cable terminal front panel, not the TV or VCR.</p> <p>The angle between the remote control and the cable terminal may be too large. Stand in front of the cable terminal and not too far to either side.</p> <p>Press and release operation keys one at a time, firmly and deliberately.</p> <p>Try changing channels using the buttons on the cable terminal front panel.</p> <p>Check the batteries in the remote control. Install new batteries if needed.</p>

Problem	Possible Solution
There is no audio when viewing cable channels	<p>Verify that the MUTE button on the cable terminal or the remote control was not pressed. Press MUTE on the remote control to restore sound.</p> <p>If the cable terminal audio output is connected to the TV, verify that the MUTE button on the TV was not pressed.</p> <p>If the cable terminal audio output is connected to a home theater receiver, verify that the receiver is set to the appropriate input source and the mute button on the receiver was not pressed.</p> <p>Verify that you used the correct audio cables for the ports.</p> <p>Verify that the audio cables are firmly connected between the cable terminal and the audio playback device (TV, receiver, DVD player, etc.).</p>
There is no audio from the center and/or surround speakers of a home theater receiver connected to the cable terminal	<p>Not all Dolby Digital programs feature full 5.1 surround sound. In some cases, the programs may only contain left and right stereo audio.</p> <p>Verify that the coaxial or optical SPDIF cable is firmly connected to the cable terminal and the home theater receiver.</p> <p>Verify that the home theater receiver is set to a surround sound audio mode (Dolby Digital, Dolby Pro Logic® II, or Dolby Pro Logic).</p> <p>Verify that the receiver is properly configured to work with all connected speakers.</p>

**Problem****Possible Solution**

There is no video on the TV screen

Verify that the TV is powered on and set to the appropriate input source for the cable terminal.

Verify that the cable terminal is powered on and tuned to an authorized cable channel.

Verify that all video cables between the cable terminal and the TV are firmly connected.

Verify that the coaxial cable feed is firmly connected to the cable terminal and the wall jack.

If the cable terminal is connected to a home theater unit, verify that the home theater unit is powered on and set to the appropriate input source.

If the cable terminal is connected to a TV through its HDMI connection, power off the TV and then power off the cable terminal. Wait one second and then power on the devices.

Not all HDTVs can display every output format (1080i, 720p, 480p, or 480i) available on the cable terminal. To select a different format:

- 1 Ensure that your cable terminal is plugged into a power outlet and is turned off.
- 2 Press the **MENU** key on the front panel. Your settings are displayed on the cable terminal front panel display.
- 3 Press the **▲** and **▼** keys to display the **HDMI/YPbPr OUTPUT** setting.
- 4 Press the **▶** key to cycle through the available output formats until a picture displays on the TV.

No graphics or program guides appear on the TV screen

If you use the IEEE 1394 connection, on-screen graphics, including closed captions and program guides, are not displayed. If possible, use HDMI or component video instead.

No closed captions display

Verify on the User Settings menu that closed captions are enabled on the cable terminal.

Verify that closed captions are enabled on the TV.

Problem

Possible Solution

There are black bars to the right and left of the picture

Wide screen TVs display 4:3 programs in this format unless set to Stretch. Turn on the 4:3 OVERRIDE feature in the User Settings menu. This enables most wide screen TVs to stretch the video to fill the screen (see your TV manual for information about stretching 4:3 video).

If the cable terminal is connected to a wide screen TV, verify that the TV TYPE is set to 16:9 in the User Settings menu.

Many HD programs are broadcast in pillar-box format with black bars to the left and right of the picture. These programs are broadcast in 16:9 HD formats even though the video is not 16:9.

There are black bars above and below the picture

All 4:3 HDTVs display HD programs in letterbox format (black bars above and below the picture) because of the shape of the display screen.

Turn on the 4:3 OVERRIDE feature in the User Settings menu. This enables most standard screen TVs to display a full screen picture when the cable terminal is tuned to a 4:3 program.

Set the TV TYPE to 4:3 Pan-Scan. This enables the cable terminal to remove the black bars above and below the picture when possible.

Some SD programs are broadcast in the letterbox format with black bars above and below the picture. Some wide screens TVs offer a zoom feature that may be able to remove the black bars (see your TV manual for information about zooming 4:3 video).

**Problem****Possible Solution**

There are black bars on all four sides of the picture

This may occur on a 4:3 TV if the 4:3 OVERRIDE setting is OFF. To set 4:3 SD programming to fill the screen, depending on the capabilities of the TV, set 4:3 OVERRIDE to 480i or 480p.

This may occur on a 16:9 TV if the active video for an SD broadcast is in letterbox format. To confirm, wait for a commercial or look for a graphic, such as a network logo. If the commercial fills the screen from top to bottom, or the graphic appears below the active video, the program is being letterboxed by the broadcaster. You can minimize this by activating the zoom feature on the TV.

A broadcaster may include black bars on either side of a wide screen broadcast. This is called a "hybrid" aspect ratio and results in a black border surrounding the video on a 4:3 TV. Because this is part of the broadcast, the cable terminal cannot correct the video. You may be able to minimize the border using the zoom feature on the TV.

The cable terminal is making a humming noise.

The DCT3400 includes an integrated hard drive and a fan for cooling. During normal operation, the DCT3400 emits a low humming noise, similar to a personal computer. The noise varies in volume occasionally when the speed of the internal fan adjusts to changes in the temperature around the DCT3400. Please note the hard drive will stay on even when the DCT3400 is turned off.

Free Manuals Download Website

<http://myh66.com>

<http://usermanuals.us>

<http://www.somanuals.com>

<http://www.4manuals.cc>

<http://www.manual-lib.com>

<http://www.404manual.com>

<http://www.luxmanual.com>

<http://aubethermostatmanual.com>

Golf course search by state

<http://golfingnear.com>

Email search by domain

<http://emailbydomain.com>

Auto manuals search

<http://auto.somanuals.com>

TV manuals search

<http://tv.somanuals.com>