



MOTOROLA

intelligence everywhere™

MICOM-2ES/2RS/2TS ALE HF-SSB TRANSCEIVERS

Support for MIL-STD-188-141B

Supplement to Owner's Guide



micom
best radio for worst events

IMRMB008

COMMERCIAL WARRANTY (STANDARD)

Motorola radio communications products are warranted to be free from defects in material and workmanship for a period of ONE (1) YEAR, (except for crystals and channel elements which are warranted for a period of ten (10) years) from the date of shipment. Parts, including crystals and channel elements, will be replaced free of charge for the full warranty period but the labor to replace defective parts will only be provided for One Hundred-Twenty (120) days from the date of shipment. Thereafter purchaser must pay for the labor involved in repairing the product or replacing the parts at the prevailing rates together with any transportation charges to or from the place where warranty service is provided. This express warranty is extended by Motorola Communications and Electronics Inc., 1301 E. Algonquin Road, Schaumburg, Illinois 60196, to the original purchaser only, and only to those purchasing for purpose of leasing or solely for commercial, industrial, or governmental use.

THIS WARRANTY IS GIVEN IN LIEU OF ALL OTHER WARRANTIES EXPRESS OR IMPLIED WHICH ARE SPECIFICALLY EXCLUDED, INCLUDING WARRANTIES OF MERCHANTABILITY OR FITNESS FOR A PARTICULAR PURPOSE. IN NO EVENT SHALL MOTOROLA BE LIABLE FOR INCIDENTAL OR CONSEQUENTIAL DAMAGES TO THE FULL EXTENT SUCH MAY BE DISCLAIMED BY LAW.

In the event of a defect, malfunction or failure to conform to specifications established by Seller, or if appropriate, to specifications accepted by Seller in writing, during the period shown. Motorola, at its option, will either repair or replace the product or refund the purchase price thereof, and such action on the part of Motorola shall be the full extent of Motorola's liability hereunder.

This warranty is void if:

- a. The product is used in other than its normal and customary manner.
- b. The product has been subject to misuse, accident, neglect or damage.
- c. Unauthorized alterations or repairs have been made, or unapproved parts used in the equipment.

This warranty extends only to individual products, batteries are excluded, but carry their own separate limited warranty. Because each radio system is unique, Motorola disclaims liability for range, coverage, or operation of the system as a whole under this warranty except by a separate written agreement signed by an officer of Motorola.

Non-Motorola manufactured products are excluded from this warranty, but subject to the warranty provided by their manufacturers, a copy of which will be supplied to you on specific written request.

To obtain performance of this warranty, purchaser must contact:

Phone: (850)580-7816

Fax: (850)576-8421

This warranty applies only within the United States.

COMPUTER SOFTWARE COPYRIGHTS

The Motorola products described in this instruction manual may include copyrighted Motorola computer programs stored in semiconductor memories or other media. Laws in the United States and other countries preserve for Motorola certain exclusive rights for copyrighted computer programs, including the exclusive right to copy or reproduce in any form the copyrighted computer program. Accordingly, any copyrighted Motorola computer programs contained in the Motorola products described in this instruction manual may not be copied or reproduced in any manner without the express written permission of Motorola. Furthermore, the purchase of Motorola products shall not be deemed to grant either directly or by implication, estoppel, or otherwise, any license under the copyrights, patents or patent applications of Motorola, except for the normal non-exclusive, royalty free license to use that arises by operation of law in the sale of a product.



MICOM-2ES/2RS/2TS ALE HF-SSB TRANSCEIVER

ALE Support for MIL-STD-188-141B

**Motorola
1720 West Paul Dirac Drive,
Tallahassee 32310 FL, USA**

**Supplement to
Owner's Guide**

Cat. No. IMRMB008

Warnings, Cautions and Notes

The following notations are used to place special emphasis on procedures, or to call attention to precautionary measures.



Warning

An operating procedure, practice and so forth, which if not followed correctly, could result in personal injury, or loss of life.



Important

An operating procedure, practice and so forth, which if not followed correctly, could result in damage to, or destruction of equipment.



Note

An operating procedure, condition and so forth, to which special attention should be paid.

General Safety Precautions

The following are general safety precautions that are not related to any specific procedures and therefore do not appear elsewhere in this publication. These are recommended precautions that personnel must understand and apply, in addition to the precautions listed in the Information for Safe, Efficient Operation section.



**Warning
High
Voltage**

Do not touch the antenna and the RF connectors when the transceiver operates.

During transmission, high RF voltages appear at the RF connectors, the antenna cables, and on the antenna itself. These voltages may cause severe injury or even death on contact.

Operating and maintenance personnel must be familiar with the applicable safety requirements before attempting to install or operate the transceiver. Severe injury or death could result from failure to comply with the safety practices.

Information for Safe, Efficient Operation



MOTOROLA

Product Safety and RF Exposure for Mobile Two-Way Radios Installed in Vehicles or as Fixed Site Control Stations



Caution

BEFORE USING THIS RADIO, READ THIS BOOKLET WHICH CONTAINS IMPORTANT OPERATING INSTRUCTIONS FOR SAFE USAGE AND RF ENERGY AWARENESS AND CONTROL INFORMATION FOR COMPLIANCE WITH RF ENERGY EXPOSURE LIMITS IN APPLICABLE NATIONAL AND INTERNATIONAL STANDARDS.

The information provided in this document supersedes the general safety information contained in user guides published prior to February 2002.

Compliance with RF Energy Exposure Standards

NOTICE This radio is intended for use in occupational/controlled applications where users have been made aware of the potential for exposure and can exercise control over their exposure. This radio device is **NOT** authorized for general population, consumer or similar use.

Motorola, Inc. 2003
8000 W. Sunrise Blvd., Ft. Lauderdale, FL 33322
Printed in USA. 7/03

Federal Communication Commission Regulations

The FCC has established limits for safe exposure to radio frequency (RF) emissions from mobile two-way radios. The FCC requires manufacturers to demonstrate compliance with RF exposure limits before mobile two-way radios can be marketed in the U.S. When two-way radios are approved for occupational/controlled environment exposure limits, the FCC requires users to be fully aware of, and exercise control over, their exposure. Awareness and control of RF exposure can be accomplished by education or training through appropriate means such as information and instructions in user manuals or safety booklets, or other appropriate means. This user safety booklet includes useful information about RF exposure and helpful instructions on how to control your RF exposure.

Your Motorola two-way radio is designed and tested to comply with a number of national and international standards and guidelines (listed below) regarding human exposure to radio frequency electromagnetic energy. **This radio complies with the IEEE (FCC) and ICNIRP exposure limits for occupational/controlled RF exposure environments at usage factors of up to 50% talk-50% listen.** In terms of measuring RF energy for compliance with FCC exposure guidelines, **your radio radiates measurable RF energy only while it is transmitting (during talking), not when it is receiving (listening) or in standby mode.**

Your Motorola two-way radio complies with the following RF energy exposure standards and guidelines:

- United States Federal Communications Commission, Code of Federal Regulations; 47CFR part 2 sub-part J
- American National Standards Institute (ANSI) / Institute of Electrical and Electronic Engineers (IEEE) C95.1-1992
- Institute of Electrical and Electronic Engineers (IEEE) C95.1-1999 Edition
- International Commission on Non-Ionizing Radiation Protection (ICNIRP) 1998
- Ministry of Health (Canada) Safety Code 6: Limits of Human Exposure to Radiofrequency Electromagnetic Fields in the Frequency Range from 3 kHz to 300 GHz, 1999
- Australian Communications Authority Radiocommunications (Electromagnetic Radiation – Human Exposure) Standard, 2001
- ANATEL, Brasil Regulatory Authority, Resolution 256 (April 11, 2001). Additional Requirements for SMR, Cellular and PCS Product Certification.

Compliance and Control Guidelines and Operating Instructions for Mobile Two-Way Radios Installed in Vehicles

To control your exposure and ensure compliance with the occupational/controlled environment exposure limits, always adhere to the following procedures:

- To transmit (talk), push the Push-To-Talk (PTT) button; to receive, release the PTT button. Transmit only when people outside the vehicle are at least 7 feet from a properly installed, externally-mounted antenna.
- Install mobile antennas at the center of the roof or the center of the trunk deck per specific guidelines and instructions in the Radio Installation Manual. These mobile antenna installation guidelines are limited to metal body vehicles.

Use only the Motorola-approved, supplied antenna or a Motorola-approved replacement antenna. Use of non-Motorola-approved antennas, modifications, or attachments could damage the radio and may violate FCC regulations.

Compliance and Control Guidelines and Operating Instructions for Mobile Two-Way Radios Installed as Fixed Site Control Stations

If mobile radio equipment is installed at a fixed location and operated as a control station or as a fixed unit, the antenna installation must comply with the following requirements in order to ensure optimal performance and compliance with the RF energy exposure limits in the standards and guidelines listed in the Federal Communication Commission Regulations section.

- The antenna should be mounted outside the building on the roof or a tower if at all possible.
- As with all fixed site antenna installations, it is the responsibility of the licensee to manage the site in accordance with applicable regulatory requirements and may require additional compliance actions such as site survey measurements, signage, and site access restrictions in order to ensure that exposure limits are not exceeded.

Electromagnetic Interference/Compatibility



Note

Nearly every electronic device is susceptible to electromagnetic interference (EMI) if inadequately shielded, designed, or otherwise configured for electromagnetic compatibility. It may be necessary to conduct compatibility testing to determine if any electronic equipment used in or around vehicles or near fixed site antenna is sensitive to external RF energy or if any procedures need to be followed to eliminate or mitigate the potential for interaction between the radio transmitter and the equipment or device.

Facilities

To avoid electromagnetic interference and/or compatibility conflicts, **turn off your radio in any facility where posted notices instruct you to do so.** Hospitals or health care facilities may be using equipment that is sensitive to external RF energy.

Vehicles

To avoid possible interaction between the radio transmitter and any vehicle electronic control modules, for example, ABS, engine, or transmission controls, the radio should be installed only by an experienced installer and that the following precautions be used when installing the radio:

1. Refer to the manufacturer's instructions or other technical bulletins for recommendations on radio installation.
2. Before installing the radio, determine the location of the electronic control modules and their harnesses in the vehicle.
3. Route all radio wiring, including the antenna transmission line, as far away as possible from the electronic control units and associated wiring.

Driver Safety

Check the laws and regulations on the use of radios in the area where you drive. Always obey them.

When using your radio while driving, please:

- Give full attention to driving and to the road.
- Pull off the road and park before making or answering a call if driving conditions so require.

Operational Warnings



For Vehicles with an Air Bag

Do not mount or place a mobile radio in the area over an air bag deployment area. Air bags inflate with great force. If a radio is placed in the air bag deployment area and the air bag inflates, the radio may be propelled with great force and cause serious injury to occupants of the vehicle.

Potentially Explosive Atmospheres

Turn off your radio prior to entering any area with a potentially explosive atmosphere. Sparks in a potentially explosive atmosphere can cause an explosion or fire resulting in bodily injury or even death.

The areas with potentially explosive atmospheres include fueling areas such as below decks on boats, fuel or chemical transfer or storage facilities, and areas where the air contains chemicals or particles such as grain, dust or metal powders. Areas with potentially explosive atmospheres are often, but not always, posted.



Blasting Caps and Blasting Areas

To avoid possible interference with blasting operations, turn off warning your radio when you are near electrical blasting caps, in a blasting area, or in areas posted: "Turn off two-way radio". Obey all signs and instructions.

For radios installed in vehicles fueled by liquefied petroleum gas, refer to the (U.S.) National Fire Protection Association standard, NFPA 58, for storage, handling, and/or container information. For a copy of the LP-gas standard, NFPA 58, contact the National Fire Protection Association, One Battery Park, Quincy, MA.

Table of Contents

	Page
Introduction	1
Menu Updates	1
New ALE Features	6
Selective Calling	6
ALE Addressing Method	6
Address and Call Types	7
Using ALE Functions in the Channel Mode	13
Entering the ALE Mode	14
Receiving and Transmitting Calls in ALE Mode	16
ALE Programming	53
Programming Nets	54
Setting the Net Options	57
Directory Parameters	58
AMD Message Configuration	58
ALE Options Configuration	59
Auto Dial Parameters	61
Storing ALE Parameters	61
Using the New Station Address Filter	62

Introduction

This Supplement to the “MICOM-2E/2R ALE HF-SSB Transceivers Owner’s Guide”, Publication 68P02952C60-A, provides you with information on the full support for ALE in accordance with the MIL-STD-188-141B (previous versions supported only MIL-STD-188-141A).

This new feature is available only on new versions (Version CK) of the MICOM-2E/2RS/2TS ALE HF-SSB transceivers (which are described in the “Supplement to Owner’s Guide”, Publication 6886872J01).

The information appearing in this Supplement is intended for use with the “Owner’s Guide, MICOM-2E/2RS/2TS ALE HF-SSB Transceivers”, Publication 68P02952C60-A, together with the “Supplement to Owner’s Guide”, Publication 6886872J01.

Menu Updates

Figure 1 through Figure 5 present the new MICOM-2 menus.

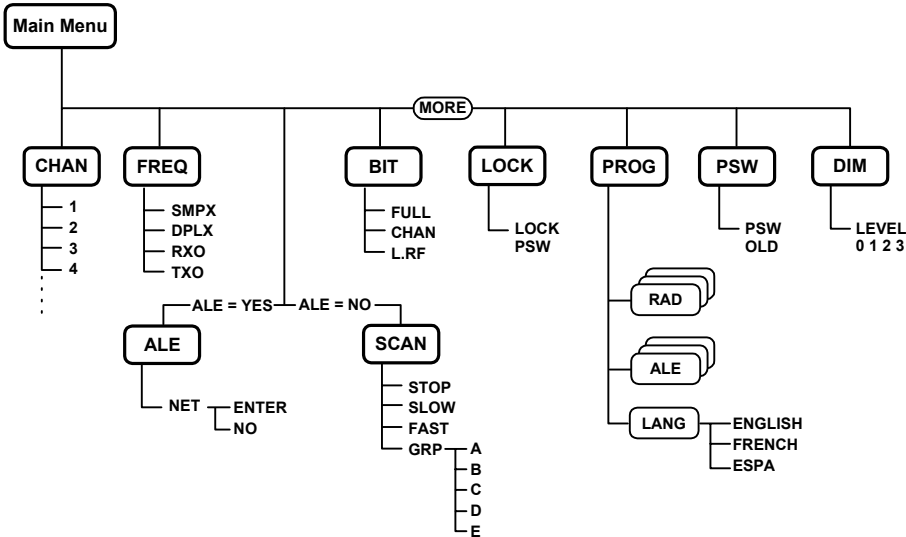
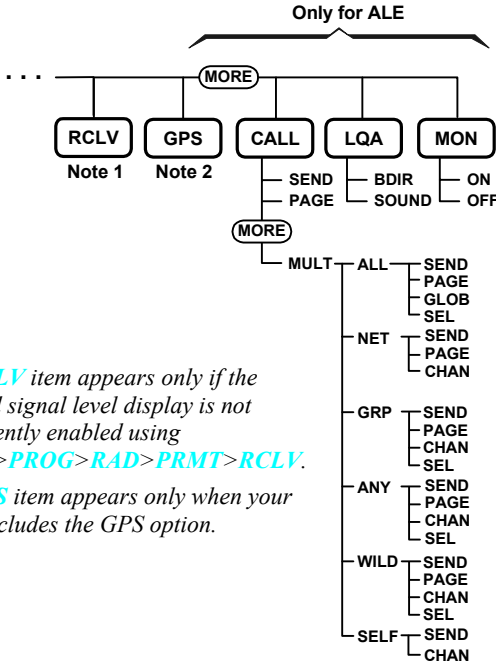
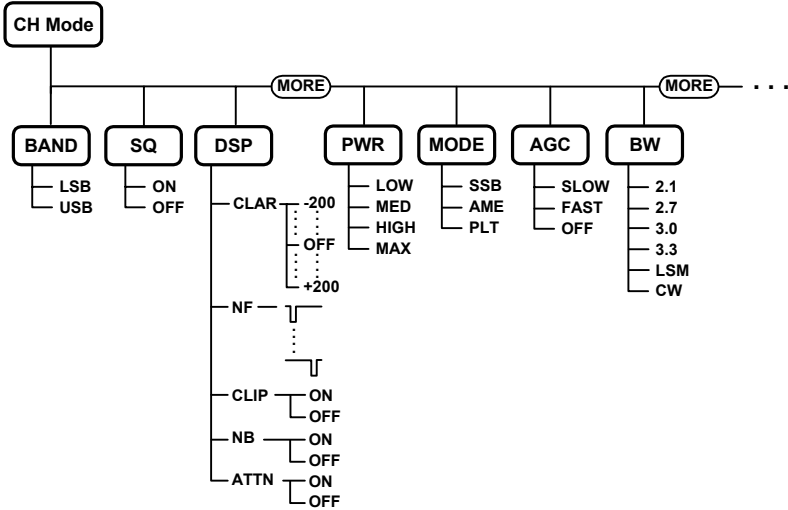

Figure 1. Main Menu



Notes

1. The **RCLV** item appears only if the received signal level display is not permanently enabled using **MENU>PROG>RAD>PRMT>RCLV**.
2. The **GPS** item appears only when your radio includes the GPS option.

Figure 2. Channel (CH) Menu

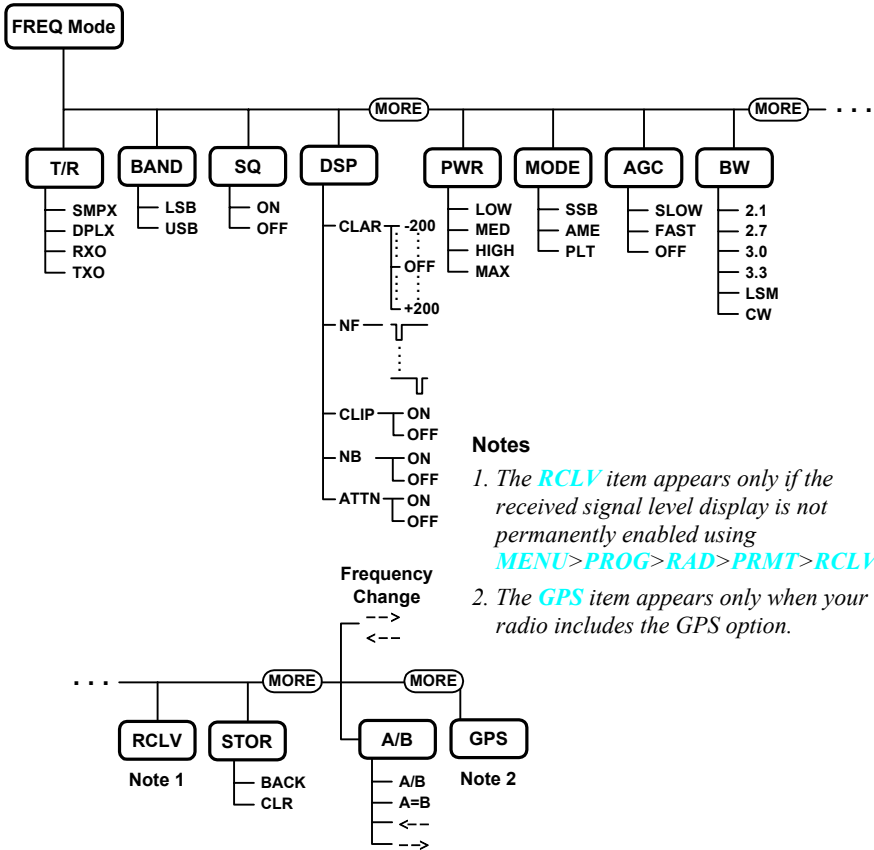

- Notes**
1. The *RCLV* item appears only if the received signal level display is not permanently enabled using *MENU>PROG>RAD>PRMT>RCLV*.
 2. The *GPS* item appears only when your radio includes the GPS option.

Figure 3. Frequency (FREQ) Menu

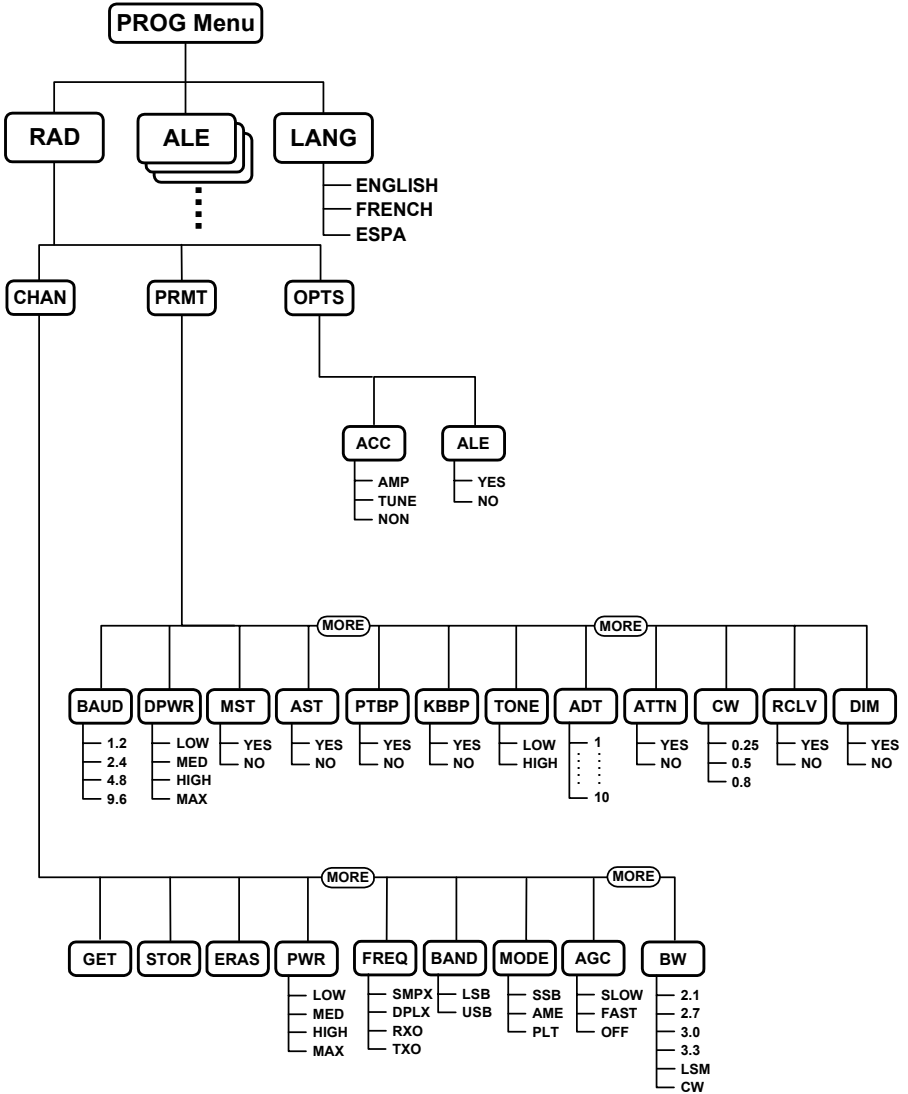

Figure 4. PROG Menu – Radio Parameters Programming

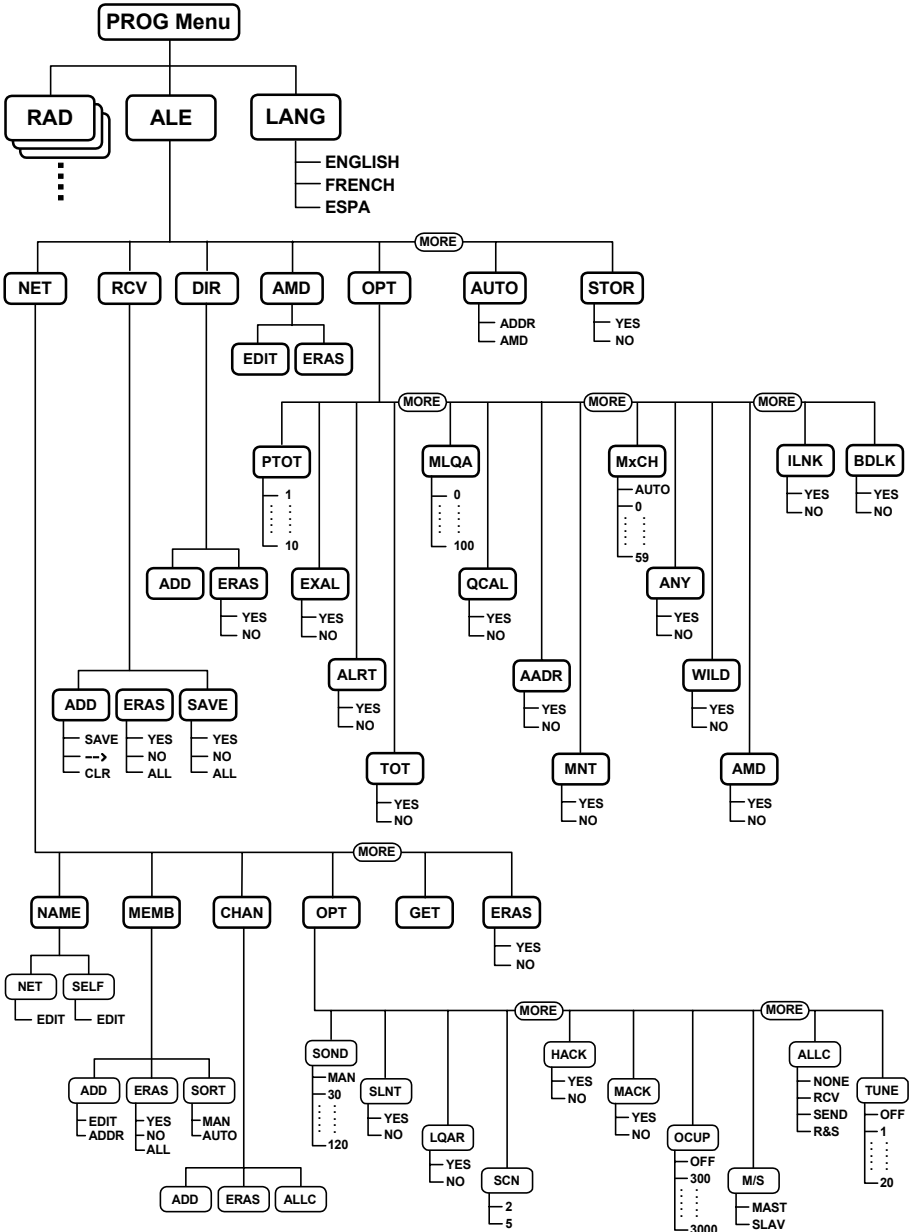

Figure 5. PROG Menu – ALE Parameters Programming

New ALE Features

This section covers the new ALE features that meet the requirements of MIL-STD-188-141B. This includes a description of selective calling features, and operating instructions for the various types of ALE calls. This includes new call types, as well as call types already supported under MIL-STD-188-141A but have been expanded under new version.

Selective Calling

MICOM 2 supports selective calling as standardized in MIL-STD-181-141B and FED-1075, and therefore has the capability and flexibility to link with one or many prearranged or as-needed single or multiple stations.

ALE Addressing Method

ALE uses digital addresses to identify stations. The fundamental address element in the ALE system is the single word: one ALE address word must always contain three characters (one triplet).

A single ALE word is needed for the basic individual station address (this is called a **basic address**). To increase the available range of addresses, basic addresses can be expanded up to a maximum of 5 words (15 characters): such addresses are called *extended addresses*.

The characters that can be used in addresses are a subset of the standard Basic 38 ASCII character set. This subset includes:

- All the capital (upper case) letters (**A** to **Z**)
- All the digits (**0** to **9**)
- Two utility characters:
 - The stuffing symbol **@**. It can be used to add characters at the end of an address, so that the resulting length is a whole number of words (triplets). A receiving station then interprets only the non-stuffing characters. For example, if the address has 8 characters, add one **@** at the end of the address, whereas for an address with 7 characters, two **@** symbols must be added. In special addressing modes, this symbol is interpreted as an *ignore* instruction: see additional utilization guidelines in Table 1.
 - The wildcard symbol **?**. It is used to indicate that any character (except **@**) is acceptable (this is the equivalent of a *don't mind* instruction). See Table 2 for utilization guidelines in the special addressing modes.



In the following sections, “A,” “B,” “C” or “D” indicates any alphanumeric character other than “@” or “?”.

Note

MICOM 2 has the capacity to store and use 100 addresses of up to 15 characters each. MICOM 2 will reject addresses longer than 15 characters, and will notify you with an UFA WRONG message.

Address and Call Types

ALE stations, including the MICOM 2, have the capability and flexibility to link with one or many prearranged or as-needed single or multiple stations. There are three general addressing methods:

- Individual station addressing
- Multiple stations addressing, for example, net and group
- Special addressing modes, for example, AllCall, AnyCall, etc.

The following sections explain the addressing modes and how they can be used for various purposes.

Individual Station Address

The individual station address may contain 1, 2, 3, 4, or 5 words. To enable using addresses that are not an integer multiple of 3 characters (for example, an address consisting of 1, 2, 7, 8, 10, ..., etc. characters), stuffing can be used: with stuffing, the last address word includes one or two stuffing symbols in the last position(s) (see the “stuff-1” and “stuff-2” patterns in Table 1).

The wildcard symbol cannot be included in an individual station address, nor in a call request to an individual station.

Table 1. Use of “@” Stuffing Symbol

Pattern	Interpretation
A B C	“Standard” 3-character address word, shown here for reference. Only the station with this address stops scanning and responds
A B @	“Stuff-1” reduced address field, used to add characters “A, B” at the end of the address
A @ @	“Stuff-2” reduced address field, used to add character “A” at the end of the address
@ ? @	“AllCall” global address (see also Table 2): all the stations stop and listen (unless this function is inhibited)

Table 1. Use of “@” Stuffing Symbol (Cont.)

Pattern	Interpretation
@ A @	“Selective AllCall” global address: each station with the same last character “A” stop scanning and listen (unless this function is inhibited)
@ @ ?	“AnyCall” global address (see also Table 2): all the stations stop scanning and respond in randomly selected timeslots (unless this function is inhibited)
@ @ A @ B@ (option)	“Selective AnyCall” address: each station with same last character(s) “A” (or “B”) stops scanning and responds in a randomly selected timeslot (unless this function is inhibited), using its own address
@ A B @ C D (option)	“Double selective AnyCall” address: each station with same last characters “AB” (or “CD”) stops scanning and responds in a randomly selected timeslot (unless this function is inhibited), using its own address
@ @ @	“Null” address; all the stations ignore this address. The null address intended for use in test and maintenance, or to create an extra “buffer” timeslot

Net Addresses

The purpose of a net call is to rapidly and efficiently establish contact with multiple prearranged (net) stations. This is achieved by the use of a single net address.

The net address is actually an additional address assigned in common to all the stations that are members of a specific net. Its address structure is identical to that used for individual station addresses (basic or extended, with or without stuffing, as necessary).

When defining a net, each member station is automatically assigned a timeslot: by having each station answer a call request in a different timeslot, collisions are avoided.

Group Addresses

The purpose of a group call is to rapidly and efficiently establish contact with multiple non-prearranged (group) stations.

To make a group call, a calling ALE station uses a sequence of the actual individual station addresses of the called stations.

Special Addressing Modes – Use of Wildcards

A “wildcard” is a special character, “?”, that a calling station can use to address multiple stations with a single call address. The following rules apply:

- The total length of a calling address that includes wildcard(s) must be equal to that of the called station addresses.

- A receiving station will accept a wildcard character as a substitute for the alphanumeric character in its own address that occupies the same position. This means that the wildcard character is a substitute for any of 36 characters and digits (A to Z, 0 to 9) in the Basic 38 character subset.
- Multiple wildcard characters can be used in different positions of the same address (basic or extended).

See Table 2 for examples of patterns using the “?” wildcard symbol.

Table 2. Use of “?” Wildcard Symbol

Pattern	Interpretation
A B C	“Standard” 3-character address, shown here for reference. All the characters in this word must be evaluated
A B ? A ? C ? B C	“Standard” “wild-1” address word. Indicates that only the positions occupied by other characters (“A” and “B”) need be evaluated: the position occupied by the “?” symbol can be ignored (<i>ignored</i> in this context means that any valid character is accepted)
A ? ? ? B ? ? ? C	“Standard” “wild-2” address word. Indicates that only the position occupied by an character (“A”, “B” or “C”) need be evaluated: the positions occupied by the “?” symbols can be ignored
? ? ?	“Standard” “wild-3” address word. Indicates that all of the three positions in this word can be ignored
A B @	“Stuff-1” reduced address field, shown here for reference. Only the first two characters in this word must be evaluated
A ? @ ? B @	“Wild-1” “stuff-1” address. Only the character “A” or “B” in this word must be evaluated
? ? @	“Wild-2” “stuff-2” address. Only the character “A” or “B” in this word must be evaluated
A @ @	“Stuff-2” reduced address field, shown here for reference. Only the first character in this word must be evaluated
? @ @	“Wild-1” “stuff-2” address. Only the first character in this word must be evaluated, and is ignored
@ A B	“Double selective AnyCall” address word, shown here for reference: only the last two characters in this word must be evaluated
@ A ?	“Double selective AnyCall” “wild-1” address word: only the middle character “A” in this word must be evaluated
@ ? B	Not permitted. Use “selective AnyCall”
@ ? ?	Not permitted. Use “global AnyCall”

Table 2. Use of “?” Wildcard Symbol (Cont.)

Pattern	Interpretation
@ @ A	“Selective AnyCall”: see Table 1
@ @ ?	“Global AnyCall”: see Table 1
@ A ?	“Selective AllCall”: see Table 1
@ ? @	“Global AllCall”: see Table 1
? @ ?	“Inlink address”: see page 11

AllCall Addresses

An AllCall is a general broadcast that does not request responses and does not designate any specific addressee: a call with this address is accepted by any station, which then stops scanning and listens to the call. The most common use of AllCalls is in cases of distress: when in distress, it is more likely to want to make any available connection in the minimum period of time than to issue a call to an individual or to a select group.

The global AllCall address is @?@. As a variation, the calling station can also use selective AllCall. Basically, the selective AllCall address is identical in function to the global AllCall, except that it specifies the last single character of the addresses of the desired subgroup of receiving stations (that is, it replaces the ? with an alphanumeric – see more details in Table 1). Any station whose address matches the pattern stops scanning and listens.

The operator can always initiate an outgoing (transmit) AllCall, but the MICOM 2 can be programmed to accept or ignore incoming (receive) AllCalls.

When a radio issues an AllCall, all the stations that are capable of receiving calls receive the AllCall.

In the scan mode, if the MICOM 2 station is set to receive AllCalls, it stops scanning when an AllCall is received. If an AllCall channel has been defined, then outgoing AllCalls are performed on that channel. If no AllCall channel has been defined, the call is performed on the first scanned channel of the net. In the Channel mode, outgoing AllCalls are performed on the currently active channel.



Note

You can transmit an AllCall by pressing the ESC button for a few seconds.

AnyCalls

An AnyCall is a general broadcast similar to AllCall with the difference that it requests responses, without designating any specific addressee(s). Therefore, an ALE station may use the AnyCall to generate responses from essentially unspecified stations, and thus it can identify new stations and connectivities.

The global AnyCall address is **@@?**. As a variation, the calling station can also use selective AnyCall, which is identical in function to the global AnyCall, except that it specifies the last single character of the addresses of the desired subset of receiving stations (that is, it replaces the **?** with an alphanumeric – see more details in Table 1). If even narrower acceptance and response criteria are required, double selective AnyCall may be used: this is identical to selective AnyCall, except that its special address (**@AB**) specifies the last two characters that the desired subset of receiving stations.

The operator can always initiate an outgoing (transmit) AnyCall, but the MICOM 2 can be programmed to accept or ignore incoming (receive) AnyCalls.

Any station accepting an AnyCall stops scanning, and then initiates a response in a randomly selected timeslot.

Self Addresses

Stations can also use their own self addresses when making calls. This may be useful for self-test and maintenance purposes, etc.

The self address may be used only in specifically-addressed calls including a group call, but not in an AllCall or AnyCall.

Null Address

The null address is a special type of address that is not directed to, accepted by, or responded to by any station.

This address is intended for test and maintenance purposes, and to provide buffer time: for example, if a null address appears in a group call, no station will respond in the associated timeslot.

Inlink Address

The inlink address, **?@?**, is used to instruct all the stations participating in an already established link to accept and act upon the information sent with the inlink address. For example, any station can use the inlink address to send an AMD message that all the linked stations would present to their user.

The inlink address is recognized only after a link is established between two or more stations.

Using the MultiNet Feature

Normally, a radio operating in the ALE mode receives and transmits only in its currently selected net. However, there are operational scenarios in which it is beneficial to enable radios to use the ALE functions while still being aware of what is going on in additional nets (for example, firefighters and paramedics must often respond to the same emergency), and be able of answering a call in another net. For this purpose, MICOM 2 radios offer the MultiNet feature.

When the MultiNet feature is enabled, a MICOM 2 radio can operate on multiple nets (up to 20). The operating characteristics then change as follows:

- Channels: each net has a group of assigned (receiving and associated transmitting) frequencies. The radio scans the channels in one net after the other, until all the nets have been scanned.
- Station addresses (the self-address and the net address used when responding to calls): the radio responds according to the self-address assigned to the station in its currently selected net (for a total of up to 20 self-addresses).
- Sounding: each radio sends soundings only within the currently selected net. Each radio scans all the channels in the currently selected net, one by one. Sounding is started 10 minutes after the unit is switched on. The sounding group interval is determined according to the programmed Sounding Auto Time.

During operation, the MICOM radio scans all the frequencies included in the defined nets:

- When the radio receives a call, it responds with the self-address that is programmed in the radio for that net.
- When initiating a call, you select the net you want to transmit to, and then select an address (a specific station, or any other type of address you wish to use). The radio then looks up the frequencies that are associated with the station you call and uses only those frequencies to call that station.
- LQA exchanges and sounding use only frequencies associated with the currently selected net.

Note that the time needed to scan multiple nets may be rather long, even when using the rather fast 5 channels/second scan rate. Moreover, the duration of a call set up request must also be long enough to ensure that your call reaches all the relevant nets. You can use the MaxScanCh parameter (an ALE programming option) to change the duration: the default, when AUTO is selected, is about 7 seconds; however you can select a different value, in the range of 1 to 59 seconds. Make sure to use the minimum value that ensures all the nets will hear your call set up request, because long durations are very disruptive.

Messages

The ALE enables you to create, send or receive alphanumeric messages (“paging” messages) in accordance with the AMD (Automatic Display Message) definition in Federal Standard FS-1045.

The messages are displayed on the receiving station LCD display, and can be up to 90 characters long. Messages can be added to any type of call, whether individual, group, net, AllCall, AnyCall, bidirectional handshake, etc. You can create up to 12 messages, and can edit or erase any of the messages at any time.

Using the Caller Stack

The *caller stack* is an internal memory that stores a list of unanswered calls. Each stack entry contains the self address of the calling station and a message (AMD) if any was sent. You can view the list, return a call and view any message sent with any call. The stack can contain up to 10 calls. The radio records an address in the stack only once even if the same caller makes repeated unanswered calls. However, if the same caller sent calls with different messages, all such calls will be saved in the stack. Each stack entry is referred to as a Page.

The appearance of the word STAK next to one of the function buttons of the LCD display indicates that there is at least one call in the stack. The STAK indicator is automatically turned off when all pages in the stack have been erased.

The stack is arranged in FIFO order, that is, the first address that enters the stack is also the first that you see on the display. If the stack is full and a new call is received, the oldest call in the stack is automatically erased.

For convenience, addresses appearing in the stack can be easily added to the ALE address directory.

Quick Call

During a call, the radio saves the latest destination information as the **quick call** information. When the user presses the PTT of the microphone or handset twice in rapid sequence, the radio automatically directs the call to that address.

In the ALE mode, channel information is also retained and used for quick calls.

Using ALE Functions in the Channel Mode

When the ALE mode is enabled, your radio can receive and transmit ALE calls even when you are using the Channel mode. For this purpose, the **CALL** (F1) key is displayed even in the Channel mode.

The only restriction is that in the Channel mode, MICOM 2 uses only the ALE parameters of net 1. Therefore, if net 1 is not programmed, no ALE functionality is available in the Channel mode, even when the ALE mode is enabled.

Entering the ALE Mode

To use the ALE mode, first it must be enabled as explained below.

Enabling the ALE Mode

► **To enter the ALE mode:**

1. Press **MENU** to display the Menu screen.



Note

*If you see **SCAN** next to F3, first enable the ALE functionality using **PROG>RAD>OPTS>ALE**.*



2. Press **ALE** (F3).

The last active net flashes in the display.

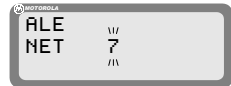

3. To use the displayed net, press **ENTER**.

To select another net:

- Press the **UP/DOWN** keys until you reach the required number.

OR

- Use the keypad to enter the desired net number.

The new net number blinks, indicating that the selection has not yet been confirmed.

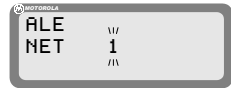

4. Press **ENTER** to confirm your choice. The radio then starts scanning the channels in the selected net (the changing channel number appears to the right of the net number).

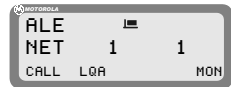

ALE and Rx Only or Tx Only Channels

The radio will prevent users from performing calls on Rx only or Tx only channels. This is true even when operating in the Channel mode: when selecting a Rx Only or Tx Only channel, the ALE option is disabled (the **CALL** (F1) key is not displayed when such a channel is selected).

ALE Programming

ALE supports many features, including:

- Various type of calls
- Up to 20 nets, each with its own set of members and associated frequencies (channels)

- Up to 100 ALE addresses in the directory
- Up to 100 scan channels
- Up to 12 AMD (paging) messages.

All the ALE features you can use on your radio can be programmed: to program or modify features, you can use the front panel of the radio, as described in the *ALE Programming* section.

Some of the ALE features can also be preprogrammed using the RSS, but the RSS does not support most of the new ALE features per MIL-STD-188-141B.

ALE Mode Options

Figure 6 shows the operator options available in the ALE mode.

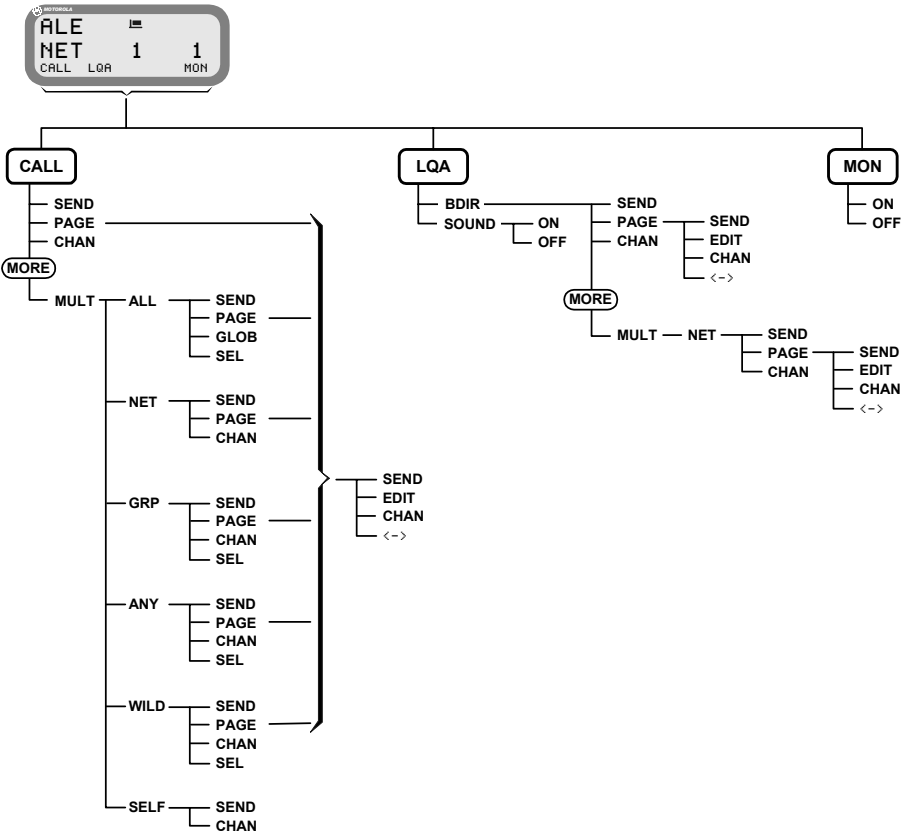

Figure 6. ALE Operator Menu

Receiving and Transmitting Calls in ALE Mode



Note

The information appearing in this section updates the ALE operating instructions presented in previous publications. Therefore, if your radio set supports MIL-STD-188-141B, use only the ALE operating instructions appearing in this Supplement.

The MICOM 2 supports the following types of ALE calls in accordance with MIL-STD-188-141B:

- *Individual call* – call directed to a specific station.
- *Net call* – call directed to a net (a net is a preprogrammed group of stations).
- *Group call* – call directed to a group of stations.
- *AllCall* – call directed to all other stations simultaneously (broadcast call); can also be used as a distress call.
- *AnyCall* – call directed to all other stations simultaneously, usually used to detect new stations.
- *Wildcard call* – call simultaneously addressed to a selected group of stations within a net, with wildcards used within the address to specify the desired stations. For efficient use of wildcards, an appropriate station naming plan must be in place.
- *Self call* – call using the station's own address, generally used for test purposes.
- *Bidirectional call* – request for updating the LQA score with another station or stations.
- *Sounding call* – used to build a link quality database. This database stores ongoing information on the current quality of the various channels programmed for use by your radio.

All types of calls, except for sounding calls, can also carry messages.



Note

MICOM 2 also supports the MultiNet feature. When this feature is enabled, it can receive and transmit ALE calls in several different nets (up to 20). See details on page 12.

During ALE calls, a link is established between the stations participating in the call. During the link state, the radio operators have various options, many of them similar to the options available in the channel mode. For a description of the link options, see pages 19 to 23.

Receiving Calls in ALE Mode

When your MICOM 2 receives a call, it displays its type and the source address.

You are also notified when a message is attached: if a message is received, the name of the calling station is preceded by an exclamation mark.

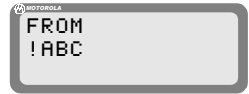

For any type of call, if the ALERT attribute is programmed to YES, you will hear the alert tone when a message is received.

► Receiving an individual call:

When an individual call (i.e., a call addressed only to your station) is received, the name of the calling station blinks in the display.



Note

If the calling station name is too long and does not fit in the display, <--> appears next to F1. Press <--> (F1) to enter the View mode.

► Receiving a net call:

When an individual call (i.e., a call addressed only to your station) is received, the name of the calling station blinks in the display.

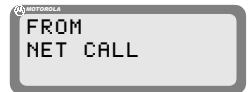

► Receiving an AllCall:



Note

You can program your radio to ignore incoming AllCalls. If the radio is set to ignore incoming AllCalls, it stops scanning when an AllCall is received but it does not display, nor lets you hear the call. At the end of the AllCall, the radio automatically returns to the scanning mode.

When an AllCall is received, the display flashes an AllCall alert that alternates ALLCALL with the calling station name.

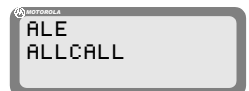

► **Receiving an AnyCall:**



Note

You can program your radio to ignore incoming AnyCalls. If the radio is set to ignore incoming AnyCalls, it stops scanning when an AnyCall is received but it does not display, nor lets you hear the call. At the end of the AnyCall, the radio automatically returns to the scanning mode.

When an AnyCall is received, the display flashes an AllCall alert that alternates ANYCALL with the calling station name.



► **Receiving a sounding call:**

When the radio is in the ALE mode and it receives a sounding call from another station, the calling station name appears in the display, preceded by the letter **S** to identify that the call is a sounding call.

Within a few seconds, the radio automatically returns to the mode used before the call was received.

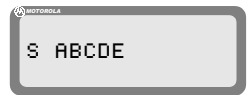

► **Receiving a bidirectional handshake call:**

When the radio receives a bidirectional handshake call from another station, your radio responds automatically, without your intervention. Within a few seconds, the radio automatically returns to the mode used before the call was received.

If the bidirectional handshake includes a message, the calling station name and the received message are stored in the stack, and the **STAK** (F3) function key appears.

► **To answer an incoming call:**

Press any key (including PTT, but not **ESC**) to accept the call. The calling station name stops blinking, and is displayed steadily. The alert tone is no longer heard. The radio is now in the link state with the calling station.

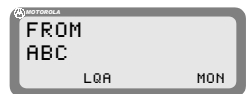

Note

When an AllCall is received, no link is actually established but you can hear the calling station.

If the received call includes a message, an exclamation mark precedes the station name, and the name is followed by a colon and the message.



If the calling station name and message are too long and do not fit in the display, press <=> (F3) to enter the View mode, where you can scroll right and left to display the whole message.



► **To display LQA for the received call:**

Press **LQA** (F2). You will see the channel in use, and its LQA score.

Link State

After the radio successfully receives or transmits a call, it is in the link state.

If the call was received from another radio, the display includes the word **FROM** in the first line, as well as the name of the station which initiated the call (if a message has been received, it is also displayed).

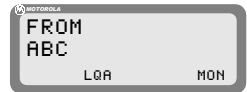

If the call was initiated by your radio, the display includes the word **LINK** in the first line, as well as the destination address.

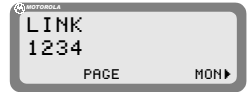

Link State Options

While in the link state, you can operate the functions described below using the function keys.

To scroll to the desired screen, press **MORE**.



The change of link options is temporary. When you exit the link state for the current call, all the changed parameters will be lost.

Note

<=> (F1) activates the View mode, where you can view the entire station address (when over 11 characters), as well as received messages, if any (when over 11 characters).

PAGE (F2) enables you to select a message to be sent to the station you are linked to. After a message is selected, you can edit it.



*The **PAGE** function is not available when receiving an AllCall.*

Note

LQA (F3) displays the channel on which the link was established, and the LQA score of the current link.



Notes

- *If the name of the station you are linked to is not in your directory, this function will not be available.*
- *The LQA (F3) key is displayed only if you established the link in the ALE mode (in the Channel mode, this function is not available, because the call is received/transmitted on the current channel).*

MON (F4) turns on and off monitoring by means of the speaker.

MORE

RPL (MORE, F1) replaces the currently-used channel with a channel with a better LQA score. The radio disconnects the link, replaces the channel being used, and initiates the call once again.



Notes

- *The RPL function is available only for individual calls, and only for the call initiator.*
- *The RPL (F1) key is displayed only if you established the link in the ALE mode (in the Channel mode this function is not available, because the call is received/transmitted on the current channel).*

BAND (MORE, F2) toggles between upper sideband (USB) and lower sideband (LSB). The sideband change takes place only after the current call is ended.

SQ (MORE, F3) toggles the squelch on/off.

DSP (MORE, F4) accesses the Digital Signal Processing menu, which includes the following options:

- **CLAR** (F1) – controls the clarifier (off/lower frequency/higher frequency).
- **NF** (F2) – controls the notch filter (off/lower frequency/higher frequency).
- **CLIP** (F3) – toggles the clipper on/off.
- **NB** (F4) – toggles the noise blanker on/off.

MORE

- **ATTN** (MORE, F2) – toggles the attenuator on/off.

MORE

- PWR** selects the transmit power level (LOW, MED, HIGH or (MORE, MORE, F1) MAX).
- MODE** selects the operation mode (SSB, AME or PLT). (MORE, MORE, F2)
- AGC** controls the automatic gain control function (fast/slow/off). (MORE, MORE, F3)
- BW** selects the filter bandwidth, (MORE, MORE, F4)

MORE

- RCLV** displays the receive level while F1 is pressed. (MORE, MORE, MORE, F1)
- FREQ** displays the current frequency while F2 is pressed. (MORE, MORE, MORE, F2)

Replacing the Current Channel While in the Link State

If during an individual call you find that the channel in use is not good enough, you can replace it with a better channel.

**Note**

- *Channel replacement is possible only during an individual call in the ALE mode.*
- *Only the initiator of a call can replace the channel in use.*

► To replace the channel:

1. Press **MORE** to scroll to the second link state menu.
2. Press **RPL** (F1) to replace the channel in use.
3. The radio disconnects the link, replaces the channel being used, and initiates the call once again.

**Note**

Even if a message was transmitted when the original link was initiated, the new link will be initiated without the message.

Using the Caller Stack

The caller stack stores information about unanswered calls. The stack entry contains the self-address of the calling station, and any message sent by the calling station when it sent the call set up request. The stack can contain up to 10 calls.

The radio records an address in the stack only once, even if the same caller made several unanswered calls. However, if the same caller sent calls with different messages, all such calls will be saved in the stack.

If you see the word **STAK** next to the F3 key, the stack includes at least one call you never viewed before.

The stack is arranged in FIFO order, that is, the first address that enters the stack is also the first that you see on the display.

► To view the calls in the stack:

1. Press **STAK** (F3).

The radio displays information on the total number of calls in the stack, and information on the first call. If the number of characters exceeds the available space, press **<->** (F4) to activate the view mode.

2. Use the **UP/DOWN** keys to view any additional calls in the stack.

► To return a call to a station registered in the stack:

1. Press **MENU** to display the Menu screen.
2. Press **STAK** (F3).
3. Use the **UP/DOWN** keys to scroll to the required call.
4. Press **CALL** (F1).
5. Press **PAGE** (F2) if you want to attach a message when you reply to the call.
6. Press **CHAN** (F3) if you want the call to be initiated on a specific channel in the currently used net.



Note

The **CHAN** (F3) key is displayed only if the radio is in the ALE mode.

7. Press **SEND** (F1) or **ENTER** to initiate the call.



Note

After initiating a call to a station, its page in the stack is automatically deleted, together with all other calls from the same address.

► **To remove an address from the stack:**

The radio automatically removes an address from the stack in the following cases:

- When the operator calls a station registered in the caller stack, all stack calls containing that address are erased from the stack, regardless of whether the call was returned from within the stack or during an individual call.
- The stack can contain up to ten addresses. When the stack is full and a new address comes in, the new address replaces the oldest address in the stack.

In addition, you can manually remove an address from the stack as follows:

1. Press **STAK** (F3).
2. Use the **UP/DOWN** keys to scroll to the required call.
3. Press **ERAS** (F2).
4. Press **YES** (F1) to confirm or, **NO** (F2) to cancel the deletion.

Disconnecting Calls

When you are in the link state, your radio can communicate with at least one other ALE station.

► **To disconnect an incoming call:**

Press the **ESC** key. This disconnects the link and returns the radio to the mode used before the link was established.

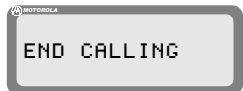

When you disconnect a link, you can instruct the other station(s) to return to the working mode they were in before they entered the link state. This feature is called Home Acknowledge, and can be programmed. If Home Acknowledge is enabled:

- In an individual link, each of the stations in the link can transmit the Home Acknowledgement to instruct the other stations to disconnect the link.
- In a net/AnyCall link, the Home Acknowledgement can only be transmitted by the radio which initiated the call.

Transmitting Calls in ALE Mode

To transmit an ALE call, you must specify the destination. In general, the destination consists of a net and one or more stations (members of the specified net):

- When the MultiNet function (page 12) is disabled, the destination net is always the currently selected net (its number is displayed on the LCD while the radio is scanning). Therefore, if you do not want to select a different net, you can skip directly to the selection of the destination station(s).
- When the MultiNet function is enabled, **first you must always select a net and then the destination station(s)**.

To expedite the transmission of an AllCall, you can send a global AllCall by pressing the **P/ESC** key for a few seconds.

MICOM-2 stores the last called address, so you can simply press the PTT twice in rapid sequence (**double pressing**) to call again that address. This also applies to AllCall, and therefore after sending AllCall for the first time, you can send it again by double pressing the PTT.



Note

*If you want to monitor the call set up process on the speaker and be alerted by a beep when the link is set up, turn the monitor on, using the **MON** (F4) key.*

Selecting the Desired Net

► To select a net:

1. Press **MENU** and select **ALE** (F3).
The radio displays current active net number, flashing.
2. To change the currently used net, press the **UP/DOWN** keys, or enter the net number on the keypad, and then press **ENTER**.

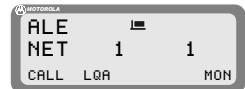
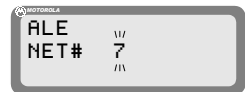

Calls to an Individual Station

► To transmit an individual call with MultiNet OFF:

1. Press **CALL** (F1).

The radio displays the last called address. This may be a station address, or any other type of address (for example, net, wildcard, etc.).



2. To select a different station:

Press the **UP/DOWN** keys to scroll between stations.

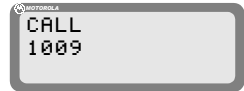

OR

Use the keypad to enter a station name and then press **SAVE** (F1) or **ENTER** when the required station name appears.



Note

When scrolling between stations with the **UP/DOWN** keys, every key pressing displays destination addresses in the following order:

- The last called address
- The AllCall address (GL ALLCALL, or SL ALLCALL, if you used it instead of GL ALLCALL)
- The current active net number
- The addresses of the members in the current net
- Other addresses in the directory.

3. Press **SEND** (F1) or **ENTER** to initiate the call.



4. The radio now starts the link set up process. During this process, you will see **TO** alternating with the number of the channel on which the set up request is being sent (the channel may change, if the called station does not answer on the first channel(s)).



Note

While the radio is initializing the link, you can press **STOP** (F1) or **ESC** to abort the entire process.

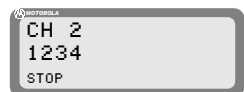

- After the link is established, you will see a LINK message. Now you may press the PTT and start talking.



If the link with the selected station cannot be set up, you will see for a few seconds a flashing NO LINK message.

Note

- To disconnect the link, press the **ESC** key.



If you want to call again the same station, double-press the PTT to use the quick-call feature (see page 28).

Note

► **To transmit an individual call with MultiNet ON:**

- Press **CALL** (F1).

The radio displays the current net number, flashing. If you wish to change the currently used net, press the **UP/DOWN** keys or enter the net number on the keypad.

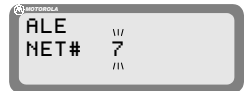

- Press **ENTER** to confirm the net number.

- The radio displays the last called station.

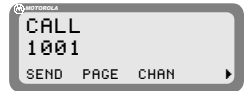

Press the **UP/DOWN** keys to scroll between stations, or use the keypad to enter a station name and then press **SAVE** (F1) or **ENTER** when the required station name appears.

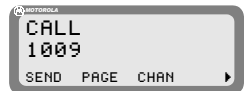

- Press **SEND** (F1) or **ENTER** to initiate the call
- The radio now starts the link set up process. During this process, you will see **TO** alternating with the number of the channel the set up request is being sent (the channel may change, if the called station does not answer on the first channel(s)).



*While the radio is initializing the link, you can press **STOP** (F1) or **ESC** to abort the entire process.*

Note

6. After the link is established, you will see a LINK message. Now you may press the PTT and start talking.
7. To disconnect the link, press the **ESC** key.

► **To transmit on a specific channel:**

1. Initiate a call as explained above (page 25 or 26) and select the desired station.

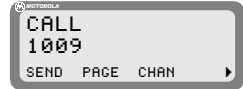

2. Press **CHAN** (F3) to select a specific channel.
The channel with the best LQA score is displayed.
The speaker is unmuted to enable you to check the channel quality by listening to it.

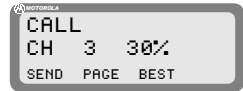

If the name of the called station has been edited and the new station name is not in the directory, no LQA score is displayed.

Note

3. Press **BEST** (F3) to select the channel with the best LQA score ...



*If the name of the called station has been edited and the new station name is not in the directory, the channel displayed after pressing **BEST** (F3) is the first scanned channel of the net.*

Note

... OR

Press the **UP/DOWN** keys to scroll to the channel of your choice.



You can use this option to transmit a call to a station operating in the Channel mode. If the other station is in the Channel mode, your radio switches to the Channel mode for the duration of the call, and then returns to the ALE mode after the link to that station is disconnected.

Note

4. Press **SEND** (F1) or **ENTER** to initiate the call.
5. The radio now starts the link set up process. During this process, you will see **TO** alternating with the number of the channel on which the set up request is being sent (the channel may change, if the called station does not answer on the first channel(s)).



*While the radio is initializing the link, you can press **STOP** (F1) or **ESC** to abort the entire process.*

Note

6. After the link is established, you will see a LINK message. Now you may press the PTT and start talking.
7. To disconnect the link, press the **ESC** key.

Quick Call

A quick call is a call to the last station you tried to call (regardless of whether the call was successful or not). In the ALE mode, the channel used for the original call is reused for the quick call.

The Quick Call feature can be enabled or disabled as part of ALE parameters programming.



Notes

- *Quick Call will not transmit a message, even if the last call contained a message.*
- *The first time the station is switched to the ALE or Channel mode, quick call is not possible as no "most recent" station data exists.*

► **To send a quick call:**

Double-press the PTT of your microphone or handset.

The radio automatically tries to contact the last called station.

During this process, you will see **TO** alternating with the number of the channel on which the set up request is being sent (the channel may change, if the called station does not answer on the first channel(s)).



Note

*While the radio is initializing the link, you can press **STOP** (F1) or **ESC** to abort the entire process.*

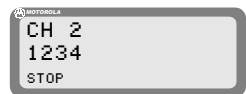

Using Autodial

The Autodial feature lets you use a single digit to call a preprogrammed address. There are ten programmable Autodial addresses, where each can include a message. See *Auto Dial Parameters* on page 61 for details on programming the Autodial list.

► To use Autodial to send a call:

1. Press # on the keypad.



If you do not select an auto-address within a few seconds, the display automatically reverts to the previous state.

Note

2. Press the desired preprogrammed Autodial number (0 to 9).

The programmed address is immediately displayed; if a message is preprogrammed, an exclamation sign will appear before the station name.

Press **PAGE** (F2) if you want to attach a message to the call or to replace/edit a preprogrammed attached message. See page 30.

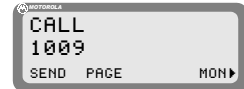

*If the Autodial number you enter is not programmed, the message **NOT PROG** will be displayed.*

Note

3. Press **CHAN** (F3) if you want the call to be initiated on a specific channel. See page 30.
4. Press **ENTER** or **SEND** (F1) to start the call.
5. The radio now starts the link set up process. During this process, you will see **TO** alternating with the number of the channel on which the set up request is being sent (the channel may change, if the called station does not answer on the first channel(s)).



*While the radio is initializing the link, you can press **STOP** (F1) or **ESC** to abort the entire process.*

Note

6. After the link is established, you will see a LINK message. Now you may press the PTT and start talking.
7. To disconnect the link, press the **ESC** key.

Sending Messages

You can send messages (*page*) together with the initial call (before the link is set up), and also whenever necessary while the link is already set up (that is, when your station is in a link with the destination station).

In the link state, if you are making an individual call, both the receiving and the calling station can send messages to the other station. This is also true for net calls and group calls.

► **To transmit an individual call with a message:**

1. Initiate a call as explained above (page 25 or 26) and select the desired station.

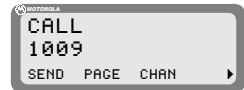

2. Press **PAGE** (F2) to add a message. The last sent message is displayed.

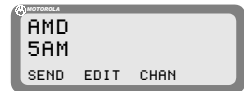

3. You may now select a different (stored) message or edit this message:

- Press the **UP/DOWN** keys to scroll to the required message.



or

- To edit the message, press **EDIT** (F2) and use the keypad to enter a new message.



4. Press **SAVE** (F1) when the message is ready.
5. Press **SEND** (F1) or **ENTER** to initiate the call.



6. Proceed with the call as explained above (page 25 or 26).

► **To send a message during a call (link state):**

1. Press **PAGE** (F2).



Note

If this function key is not displayed, you cannot send a message in the present mode.

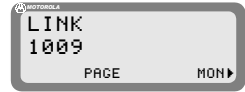

2. Select or edit the desired message as explained on page 29.

3. Press **SEND** (F1) or **ENTER** to send the message.



4. The radio now starts the link set up process for this message (this process is similar to the process used to set up the link for this call). During this process, you will see **TO** alternating with the number of the channel being used.

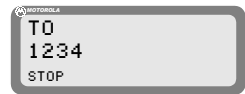

Note

- *While the radio is initializing the link, you can press **STOP** (F1) or **ESC** to abort the entire process.*
- *If the link needed to send the message to the selected station cannot be set up, you will see for a few seconds a flashing **NO LINK** message.*

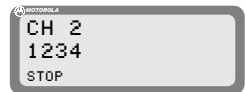

Other Types of Calls

In addition to calls to individual stations described on the pages 24 to 30, additional types of calls can be used to help you call multiple stations (see list on page 16).



A properly designed address assignment plan is needed to take advantage of the special ALE calling modes.

Note

The special call types are reached under a special submenu, designated MULT (see Figure 6 for its organization).

► To select a special call type:

1. Press **CALL** (F1).

The radio displays the last called address. This may be a station address, or any other type of address (for example, AllCall, net, wildcard, etc.).



2. Press **MORE** once.

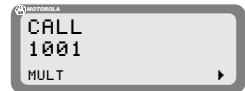

3. Press **MULT** (F1) to display the first page of special calls. If the desired call type is located on this page, press the corresponding function key to select it.

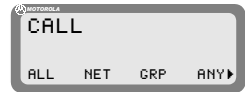

4. If necessary, press **MORE** again to display the next page.



*Pressing **MORE** again return you to the first page of special calls: do not use the **ESC** key, as it cancels the **MULT** option.*

Note

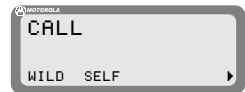

5. Go to the page listed below for detailed instructions.

Option	Capabilities	See Page ...
ALL	AllCall – call directed to all the other stations simultaneously; usually used as a distress call.	33
NET	Net call – call directed to a net (a net is a preprogrammed group of stations). Up to 20 nets can be defined.	37

Option	Capabilities	See Page ...
GRP	Group call – call directed to a group of individually selected stations. Groups can be preprogrammed, but you can also select the stations to be called and save the selection for reuse. Up to five groups can be defined.	38
ANY	AnyCall – call directed to all the other stations simultaneously, usually used to detect new stations.	41
WILD	Wildcard call – call simultaneously addressed to a selected group of stations within a net, with wildcards used within the address to specify the desired stations. Wildcard calls use the special ALE addressing modes. If you are not familiar with these modes, you should review pages 7 to 11.	44
SELF	Self call – call using the station’s own address, generally used for test purposes.	46

Transmitting AllCalls

An *AllCall* is a message which your radio uses to establish a connection with all the other stations simultaneously, and is typically used to broadcast a message or send a distress call. An AllCall can also include a message.

In addition to this type of AllCall (referred to as a *global (GL) AllCall*), it is also possible to use *selective (SL) AllCall*: this is a simultaneous call addressed only to all the stations whose names (addresses) end with a character you specify.



If so required, you can set your radio so that it cannot send AllCalls.

Note

You cannot select the channel on which an outgoing AllCall will be sent: outgoing AllCalls are sent on the AllCall channel defined for the currently selected net, or on the best scanned channel of the net.



When radios in other nets have their MultiNet feature enabled, AllCalls may also reach these radios. See details on page 11.

Note

There are two ways to send a global AllCall: using the **ESC** key or using the CALL function. A selective AllCall can be sent only using the CALL function.

► **To send global AllCall using the ESC key:**

1. Press **ESC** continuously for a few seconds. The radio starts sending the GL AllCall.

During this process, you will see **TO** alternating with the number of the channel on which the set up request is being sent.

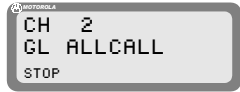
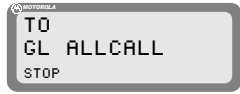

*While the radio is initializing the link, you can press **STOP** (F1) or **ESC** to abort the entire process.*

Note

2. After a delay, you will see LINK with a flashing GL ALLCALL.
3. Confirm the link set up by pressing **ENTER** or the PTT. The GL ALLCALL message stops flashing, and you can start talking.
4. Press **PAGE** (F2) if you want to send a message. See page 31 for details.
5. To end the call, press **ESC**.

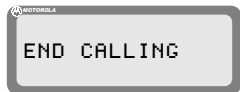
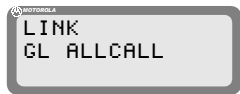

► **To send global AllCall using the CALL function:**

1. Press **CALL** (F1).
The radio displays the last called address.

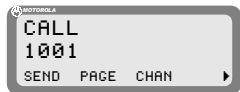

2. Press the **UP/DOWN** keys until you reach GL ALLCALL.



3. Press **PAGE** (F2) if you want to add a message to the call. See page 30 for details.
4. Press **SEND** (F1) or **ENTER** to start the call.
The call now proceeds as for call initiated by pressing the **ESC** key.

► **To send selective AllCall:**

1. Press **CALL** (F1).

The radio displays the last called address.



2. Press **MORE** once.

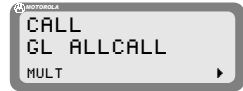

3. Press **MULT** (F1) to display the first page of special calls.



4. Press **ALL** (F1).



5. Press **SEL** (F4).



*If you decide to send a Global AllCall, press **GLOB** (F3).*

Note



6. Type the desired character (only one character is accepted).



*You can press **?** (F1) if you decide to send a global AllCall or “?”.*

Note

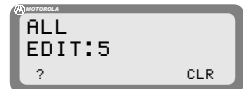

7. Confirm your selection by pressing **ENTER**.



*If you decide to send a global AllCall, press **GLOB** (F3) or “?”.*

Note



8. Press **SEND** (F1) or **ENTER** to start the call. The radio starts sending the selective AllCall.



*While the radio is initializing the link, you can press **STOP** (F1) or **ESC** to abort the entire process.*

Note

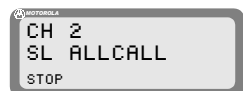
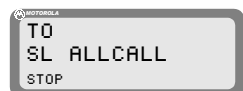

9. After a delay, you will see LINK, and you can start talking.



10. Press **PAGE** (F2) if you want to send a message.
See page 31 for details.

11. To end the call, press **ESC**.

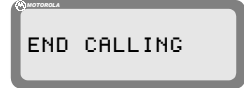

Transmitting Net Calls

Before starting, select the net you want to use as explained on page 24. However, when MultiNet is enabled, you will be prompted for a net number as soon as you start a call.



Note

- You can program nets using the front panel, or the RSS.
- The radio must be programmed as a **MASTER** radio in the net (an ALE Programming option) in order to be able to transmit net calls.

► To transmit a net call:

1. Press **CALL** (F1).

The radio displays the last called address.

If you see the net you want, skip directly to Step 5 below, otherwise continue as explained below.



2. Select the NET option as explained on page 32.

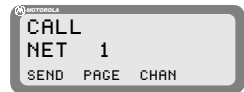

3. Press **PAGE** (F2) if you want to attach a message to the call.
4. Press **CHAN** (F3) if you want to initiate the call on a specific channel.
5. Press **SEND** (F1) or **ENTER** to initiate the call.

The radio now starts the link set up process. During this process, you will see **TO** alternating with the number of the channel on which the set up request is being sent.



Note

While the radio is initializing the link, you can press **STOP** (F1) or **ESC** to abort the entire process.

When a net call is transmitted, each member in the net responds to the call and the initiator of the call receives an indication of the response on the display.



6. After links have been established, you can start talking.
7. To end the call, press **ESC**.

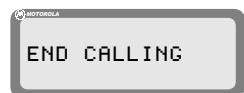

Transmitting Group Calls

Group calls let you call several individual stations in your net (at least 2) at once. Thus, you can use a group call to communicate with a few select stations, while other stations can still communicate at will, using other channels available to your net.

You can call up to 5 stations in a group call. The only restriction is that the total length of all the addresses cannot exceed 12 ALE words (36 characters). If the maximum allowed length is exceeded, you get a **BUFF FULL** error.



Note

- *If you need to check beforehand the length, remember that as explained on page 6, each ALE word must include 3 characters. Therefore, when an address is not an exact multiple of 3, stuffing symbols are automatically added in the last positions.*
- *ALE addresses are categorized in accordance with their leading ALE word (that is, their first three characters: if the address is short and has only one or two characters, stuffing symbols @ are added). When assembling a group you must also take into consideration that the maximum number of different address categories (as identified by their leading word) in one group is 5. If more are included, then when you try to send the call you will see **UFA WRONG**. In this case, remove addresses to make the group more homogenous.*

To make a group call, first you must specify the stations to be included in the group. The addresses of the stations you include in the group can be saved as a **group**; the radio can store up to 4 different groups. If a group including the desired stations is already programmed, you can directly initiate the call to the desired group.



Note

Before starting, you may want to select a different net to use: see instructions on page 24.

*When MultiNet is enabled, you will be prompted for a net number as soon as you press **CALL** (F1) to start a call.*

► **To transmit a group call:**

1. Press **CALL** (F1).

The radio displays the last called address.

If you see the group you want, skip directly to Step 6 below, otherwise continue as explained below.



2. Select the GRP option as explained on page 32.
3. The first group displayed is always group 1. If this is the group you want, skip directly to Step 6 below, otherwise press the UP or DOWN arrows until you see the desired group.
4. Press **PAGE** (F2) if you want to attach a message to the group call.
5. Press **CHAN** (F3) if you want to initiate the call on a specific channel.
6. Press **SEND** (F1) or **ENTER** to initiate the call.



Note

- *If the selected group does not include at least 2 stations, your request is rejected and you will see for a few seconds **AT LEAST 2**.*
- *If the addresses in the group have more than 5 different leading words, your request is rejected and you will see for a few seconds **UFA WRONG**.*

The radio now starts the link set up process. During this process, you will see **TO** alternating with the number of the channel on which the set up request is being sent.



Note

*While the radio is initializing the link, you can press **STOP** (F1) or **ESC** to abort the entire process.*

When a net call is transmitted, each member in the group responds to the call and the initiator of the call receives an indication of the response on the display.

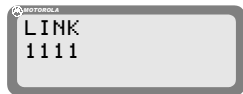

7. After links have been established, you can start talking.
8. To end the call, press **ESC**.

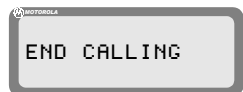

► **To define or change a group:**

1. Press CALL (F1) and select the GRP option, as you do to start a group call (page 38).
2. The first group displayed is always group 1. If this is the group you want, skip directly to Step 3 below, otherwise press the UP or DOWN arrows until you see the desired group.
3. To select the stations you want in this group, press **SEL** (F4).



The following example explains how to build a new group, but you can use the same procedures to change an existing group.

Note

4. After pressing **SEL** (F4), you will see the DIR screen. Therefore, you can select stations from the addresses already stored in the directory, or type new addresses using the keypad.

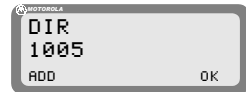

To select an address from these already in the directory:

- Use the UP and DOWN arrows to display the desired directory entry, and then press **ADD** (F1).

The label above the selected entry changes to ADDED, to indicate that it is now included in the group.



Now you can also have the option (**ERAS** (F1)) to delete the entry from the group.



Note

*If adding the station would cause the total length of the station addresses in the group to exceed 12 ALE words, then after pressing **ADD** (F1) you will see **BUFF FULL** and the process stops.*

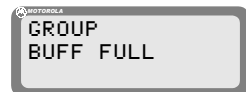

- Repeat the procedure described above until the group includes only the desired stations.

As you scroll through the directory, you will see DIR for stations that can be added, and ADDED for those already added. If the station you want to add to the group is not in the directory:

- o Enter the new station using the keypad. If you make a mistake, scroll to the desired position using <-- (F2) and/or --> (F3), or clear (CLR (F4)) the whole entry and start again.
- o When ready, press SAVE (F1) to store the new station in the directory.

Now you can add it to the group by pressing ADD (F1).



Transmitting AnyCalls

An AnyCall is a general broadcast which your radio uses to simultaneously establish links with other stations. An AnyCall can also include a message.



If so required, you can set your radio so that it cannot send AnyCalls.

Note

AnyCall is somewhat similar to AllCall, except that it requests responses from the other stations and therefore it can be used to detect new stations. Another difference is that you can also select the channel on which the AnyCall will be transmitted (alternatively, you can let the radio select automatically the channel).



When radios in other nets have their MultiNet feature enabled, AnyCalls may also reach these radios. See details on page 11.

Note

You can send three types of AnyCalls (see also description of addressing modes on pages 6 to 11):

- General: the address sent by your radio is @@?. This is a simultaneous call addressed to all the stations.
- Selective: you specify the last character of the address. This is a simultaneous call addressed only to the stations whose names (addresses) end with a character you specify.

- Double selective: similar to selective, except that you specify the last two characters of the address.

To make an AnyCall, first you must select the address to be used for the call.

MICOM-2 will wait for responses for a certain time before entering the link state with all the stations that responded within this interval (the maximum number of stations that are accepted in an AnyCall is 16).



Before starting, you may want to select a different net to use: see instructions on page 24.

Note

*When MultiNet is enabled, you will be prompted for a net number as soon as you press **CALL** (F1) to start a call.*

► **To transmit an AnyCall:**

1. Press **CALL** (F1).

The radio displays the last called address.

If you see the address you want (that is, you want to repeat the last AnyCall), skip directly to Step 10 below, otherwise continue as explained below.

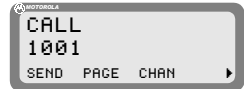

2. Press **MORE** once.

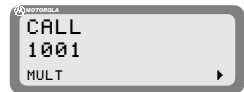

3. Press **MULT** (F1) to display the first page of special calls.

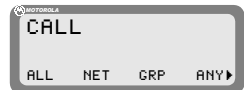

4. Press **ANY** (F4).

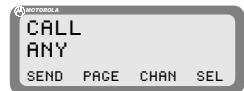

5. Press **SEL** (F4).

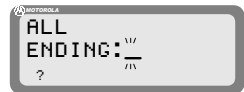

Note

*If you try to send (**SEND** (F1)) the call without first selecting an address, your attempt is rejected and you see for a few seconds **NOT PROG.***

6. Select the AnyCall address:

- To send a general AnyCall, press **?** (F1).
- To send a selective AnyCall, enter the desired character (any character except #, @ or ?).
- To send a double-selective AnyCall, enter two characters.

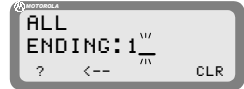

7. Confirm your selection by pressing ENTER (see below examples for the 3 types of addresses).



8. Press **PAGE** (F2) if you want to attach a message to the call.
9. Press **CHAN** (F3) if you want to initiate the call on a specific channel.
Press **SEND** (F1) or **ENTER** to initiate the call. The radio now starts the AnyCall process. During this process, you will see **TO** alternating with the number of the channel on which the request is being sent.



*You can press **STOP** (F1) or **ESC** to abort the entire process.*

Note

When an AnyCall is transmitted, the initiator of the call receives an indication of each station answering the call (its address flashes in the display, until replaced by the next answering station).

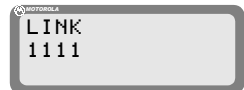

10. After a programmed interval (or after 16 stations answer, whichever comes first), the link is established. Now you can start talking.

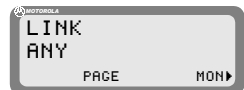

11. To end the call, press **ESC**.

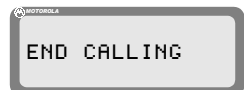

Transmitting Wildcard Calls

Wildcard calls, that is, calls in which the destination address includes the wildcard character ?, let you to simultaneously address multiple stations with a single address:

- Any station receiving an address with wildcards stops scanning and checks the address length: if the number of characters in the received address is different from the number of characters in its own self-address, the station ignores the call.
- If the received address matches the length, a receiving station checks the significant positions in the received address against its own. For example, the stations JOHN and JOIN will both accept a call with the address JO?N.
- Each station accepting the call answers the calling station in a pseudo-random slot.

MICOM-2 will wait for responses for a certain time before entering the link state with all the stations that responded within this interval (the maximum number of stations that are accepted in a wildcard call is 16). Therefore, with the wildcard option, the link set up process takes more time, because the radio waits longer to get responses (it cannot “guess” the number of stations that will answer).

Before continuing, you may wish to review pages 7 to 11, which present details on ALE addressing (including the use of wildcards in addresses).



Before starting, you may want to select a different net to use: see instructions on page 24.

Note

*When MultiNet is enabled, you will be prompted for a net number as soon as you press **CALL** (F1) to start a call.*

► **To transmit a wildcard call:**

1. Press **CALL** (F1).

The radio displays the last called address.

If you see the address you want (that is, you want to repeat the last wildcard call), skip directly to Step 11 below, otherwise continue as explained below.



2. Press **MORE** once.

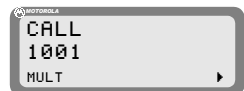

3. Press **MULT** (F1) to display the first page of special calls.

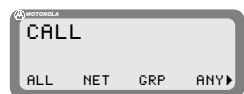

4. Press **MORE** again to display the next page.

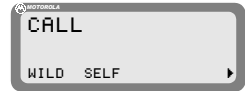

5. Press **WILD** (F1) to start.

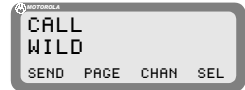

6. Press **SEL** (F4).

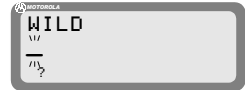

Note

*If you try to send (**SEND** (F1)) the call without first selecting an address, your attempt is rejected and you see for a few seconds **NOT PROG.***

7. Select the desired address:

- To insert a wildcard, press **?** (F1).
- Enter the desired characters using the keypad

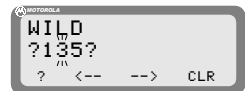

8. Confirm your selection by pressing ENTER.

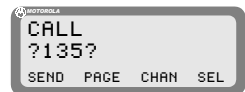

9. Press **PAGE** (F2) if you want to attach a message to the call.
 10. Press **CHAN** (F3) if you want to initiate the call on a specific channel.
 11. Press **SEND** (F1) or **ENTER** to initiate the call.



Note

*If the selected group does not include at least 2 stations, your request is rejected and you will see for a few seconds the message **AT LEAST 2.***

The radio now starts the process. During this process, you will see **TO** alternating with the number of the channel on which the request is being sent.



Note

*You can press **STOP** (F1) or **ESC** to abort the entire process.*

12. After a delay, you will see LINK with the wildcard address flashing.

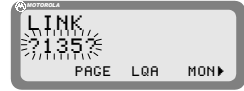

13. Confirm the link set up by pressing **ENTER** or the PTT. The address stops flashing, and you can start talking.

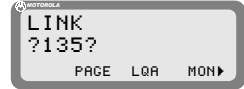

14. To end the call, press **ESC**.

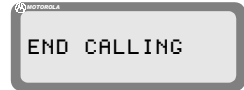

Transmitting a Self Call

The self-call is a test call addressed to your own address within the currently selected net. Its purpose is to check that your radio set is OK and can transmit calls (to check reception, you can simply listen to other radio sets).

When you send the self-call, the radio starts sending calls to its own address, successively, on each channel in the current net. After going through all the channels, the call process stops. No other response is expected.



You can also include the self address in a group call.

Note

► To send a self-call:

1. Press **CALL** (F1).

The radio displays the last called address.



2. Press **MORE** once.

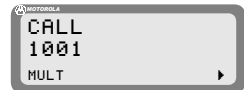

3. Press **MULT** (F1) to display the first page of special calls.



4. Press **MORE** again to display the next page.

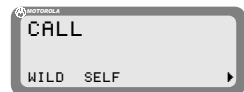

5. Press **SELF** (F2) to start the self-call.



6. You may select now a specific channel to perform the call, by pressing **CHAN** (F1). See details on page 27.

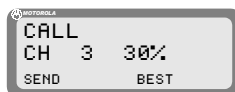

7. When ready, press **SEND** (F1) to start transmitting. The display alternates between your self-address and the channel used for the call is sent. If you did not select a specific channel, the channel number changes as the radio sends the call on each channel assigned to the selected net.

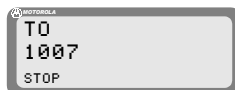

After all the channels have been used, the call automatically stops.

You can press **STOP** (F1) at any time to end the call sooner.

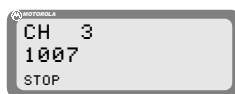

Bidirectional Handshake

The bidirectional handshake is used to exchange LQA scores with other stations without establishing a link.



Note

The MICOM-2 can also be programmed to automatically initiate the call to the station after finishing the bidirectional handshake (using the BDLK parameter reached under the ALE programming options).

A bidirectional handshake can be carried out with a single station or with all stations in the net. It can be carried out either on a single channel, or on all the net channels. When required, a message can also be added to the procedure.

After a bidirectional handshake with a single station, the LQA matrices of both radios are updated. The operator can then initiate a call to that station and obtain the best channel automatically.

When the bidirectional handshake procedure is performed with a net, all the stations in the net update their LQA tables.

MICOM-2 will wait for responses for a certain time before entering the link state with all the stations that responded within this interval (the maximum number of stations that are accepted in a bidirectional handshake is 16).



Note

Before starting, you may want to select a different net to use: see instructions on page 24.

*When MultiNet is enabled, you will be prompted for a net number as soon as you press **CALL** (F1) to start a call.*

► **To execute a bidirectional handshake with an individual station:**

1. Press **LQA** (F2) to enter the LQA menu.

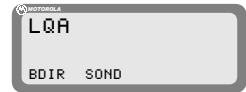

2. Press **BIDR** (F1).

The last called address is displayed. If this is the address you want, skip directly to Step 6 below.

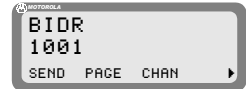

3. To select a different address, use the **UP/DOWN** keys to scroll to the required address in the directory, and then press **ENTER** to confirm your selection.

or

If the station you want to add to the group is not in the directory:

- Enter the new station using the keypad. If you make a mistake, scroll to the desired position using **<-** (F2) and/or **->** (F3), or clear (**CLR** (F4)) the whole entry and start again.
- When ready, press **SAVE** (F1) to store the new station in the directory.

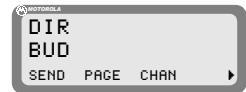
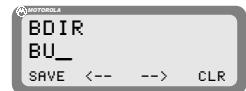

4. Press **PAGE** (F2) if you wish to attach a message to the bidirectional handshake process. After confirming the message, exclamation mark precedes the name of the called station, indicating that a message has been attached.
5. Press **CHAN** (F3) if you wish to execute a bidirectional handshake process on a specific channel.
6. Press **SEND** (F1) or **ENTER** in order to initiate the bidirectional handshake process. During this process, you will see **TO** alternating with the number of the channel on which the set up request is being sent.



*During the bidirectional handshake process, you can press **STOP** (F1) or **ESC** to abort the entire process.*

Note

► To execute a bidirectional handshake with a net:

1. Press **LQA** (F2) to enter the LQA menu.

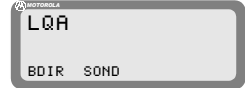

2. Press **BIDR** (F1).

The last called address is displayed. If this is the net you want, skip directly to Step 8 below.

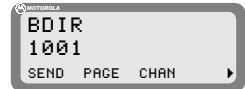

3. Press **MORE**.

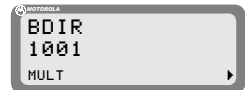

4. Press **MULT** (F1).

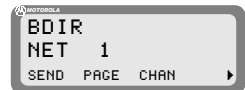

5. Press **NET** (F1).

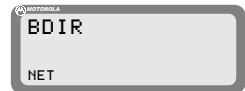

You cannot change the net number at this stage – the bidirectional handshake is always performed on the currently selected net. To change the net, see page 24.

Note

6. Press **PAGE** (F2) if you want to attach a message to the handshake.
7. Press **CHAN** (F3) if you want to initiate the handshake on a specific channel.
8. Press **SEND** (F1) or **ENTER** to initiate the handshake. During this process, you will see **TO** alternating with the number of the channel on which the handshake is being sent.



*While the radio is initializing the handshake, you can press **STOP** (F1) or **ESC** to abort the entire process.*

Note

Sounding

Sounding is used to test the quality of the channels and propagation paths of all channels in the net.

The sounding signal is normally repeated automatically, at regular intervals. A complete round of sounding messages, or "sounding cycle" can be programmed to 30, 60, 90, or 120 minutes, or can be set to OFF.

Sounding can also be initiated manually whenever necessary, even if automatic sounding is enabled.

► To manually initiate sounding:

1. Press **LQA** (F2) to enter the LQA menu.

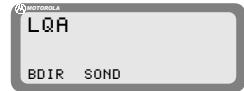

2. Press **SOND** (F2).

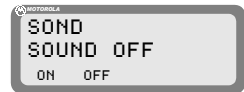

3. Press **ON** (F1) to start manual sounding, or **OFF** (F2) to stop an ongoing sounding process.



Notes

- *The radio automatically returns to ALE mode when sounding is stopped.*
- *When the radio transmits a sounding signal, the Tx indication is visible.*

Using the Inlink Function

When the inlink function is enabled (see instructions in the *ALE Options Configuration* section starting on page 59), the stations participating in a call are automatically notified by a DISC message whenever another participant leaves (disconnects from) the call.

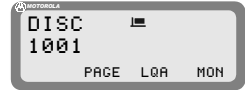

The link is then automatically disconnected when only one station is left (that is, after all the other participants disconnected).

The inlink function is available in any type of call that involves the setting up of a link using bidirectional handshaking. Therefore, you can use it in individual calls, group calls, net calls, etc., but not in AllCalls and self calls.



Note

For the inlink function to operate correctly, it must be enabled on all the stations.

Do not enable the inlink function when communicating with a radio that does not support the full ALE capabilities in accordance with MIL-STD-188-141B.

To avoid disconnecting the link too soon as a result of inactivity (that is, after the PTT time-out interval (PTOT) programmed under the *ALE Options Configuration* section), each participant can request other stations to wait beyond the PTOT interval (up to 10 minutes more) before automatic disconnection occurs.



This option (TOT – time-out interval) is displayed over the F4 key after the link is set up: to send a request for the other stations to wait more time, press the TOT (F4) key.

Transmitting ALE Calls in the Channel Mode

The ALE option is available in both the ALE and Channel modes and therefore, the radio can also answer ALE calls.

The transmission process is similar for both operating modes, with the following differences:

- In the Channel mode, every call is initiated on the currently selected channel.
- The LQA function is not available in the Channel mode: sounding and bidirectional calls can only be initiated in the ALE mode.
- When the radio is in the Channel mode, it uses the parameters programmed for net 1.



If net 1 is not programmed, there is no ALE functionality in the Channel mode, even if the ALE option is turned on.

Important

ALE Programming

This section provides concise instructions for using the ALE Programming mode. This mode, reached under the PROG menu (see Figure 4 and Figure 5) is used to configure the parameters needed by the ALE function. The ALE parameters are identified in Figure 5.



The Programming mode is accessible only if the radio is not locked.

Note

After locating the required ALE parameter in the Programming menu, you can change it by pressing the function key next to the parameter name, and then press the **UP/DOWN** keys to scroll or set parameters.

► To enter the ALE Programming mode:

1. Press **MENU** to display the Menu screen.
2. Press **MORE** to scroll to the second Menu screen.
3. Press **PROG** (F2).
4. Press **ALE** (F2) to enter the ALE Programming mode.
5. Press **MORE** as required to access additional ALE programming parameters.

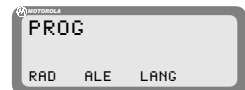
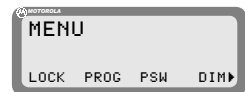
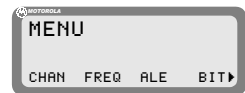

In the ALE Programming mode, you can program the following features (see also Figure 5).

	Description	See Page ...
• NET	Net parameters: station names, options, members and scanned channels.	54
• RCV	Edit the list of stations not appearing in the directory from which calls have been received. This item is displayed only after such calls have been received, and therefore will not appear when the MICOM-2 is just turned on.	58

	Description	See Page ...
• DIR	Directory: configuration of the ALE address list.	58
• AMD	Messages: preparation of AMD messages to be sent with ALE calls.	58



You can also edit, or prepare a new message, on-line.

Note

• OPT	Options: configuration of the various ALE options, such as PTT timeout, external alarm, and so on.	59
• AUTO	Autodial parameters: shortcuts for ALE calls to frequently called stations.	61
• STOR	Store the changes made in the ALE programming session.	61



Important

- The **ESC** key is used to cancel a change you have made, if not yet confirmed. If you have already saved changes, the ESC key will only return to a previous screen of the ALE Programming menu.
- When you end ALE programming, you must store the parameters you defined.

If you press the **MENU** key to exit the programming mode without first saving your changes, you will be prompted to store the ALE configuration changes. Press **YES** to store the configuration. If you press **NO**, the configuration will revert to the previous configuration, and any changes made in the current ALE programming session will be ignored.

Programming Nets

When programming a net, you can set the net names, define the net members, add channels, configure various options, copy parameters from a defined net or erase an entire net.

Net Programming Overview

The net programming mode enables you to view and edit the configuration of each net.

The configuration includes the following menus:

- **NAME** Edit the net name and the self-address:
 - **NET:** Define or edit the net names.
It is not allowed to use a name already used as a self-address, nor an address already appearing in the address directory.
 - **SELF:** Define or edit your self address (the identification of your station, to be used by other stations within the same net).
It is not allowed to use a name already used as a net address, nor an address already appearing in the address directory.

A net name or self address can contain up to 15 characters. Valid characters are the letters A to Z and the numerals 0 to 9.
- **MEMB** Add or erase members (station addresses) from the list of net members. This list defines which stations can participate in a net call (a net can have up to 16 addresses).

The MEMB menu also enables you to sort the list of members: this determines the order in which members respond to a net call. You can arrange the order of the list of members manually, or instruct the radio to arrange them in alphanumeric order.

A member name can contain up to 15 characters. Valid characters are the letters A to Z and the numerals 0 to 9. It is not allowed to define a name already used as a net address, nor an address already appearing in the address directory. New member names will automatically be added to the directory list (unless the directory is full).
- **CHAN** Add or remove channels to the list of scanned channels in a net, and to define the channel on which AllCalls are to be transmitted (the *AllCall channel* (ALLC)).

**Note**

- *Each net can contain up to 100 scanned channels.*
- *All nets combined can contain up to 100 scanned channels. If you exceed this number, the message **OVER 100 CH** is displayed for one second, and then the display returns to the previous menu.*
- *If you enter a channel which is not programmed, a **NOT PROG** message is displayed for a second, and the display returns to the previous menu.*

- **OPT** Configure net options, including: sounding, silent network, LQA request, scan rate, home acknowledgment, monitor acknowledgment, occupancy detection, master/slave definitions, AllCall options and tune time.
- **GET** Copy all parameters from one network to another. This function is useful if you are defining a new network and wish to base most of its parameters on an existing network, for instance if you need to use different frequencies/channels for day and night communication, but all other net information (such as stations and names) is identical.
- **ERAS** Erase an entire network from the ALE data base.

After preparing a set of parameters, your entries are checked and any errors are reported. If you do not correct the detected errors, MICOM-2 will offer to discard the new set of parameters.

Default Values

Unless you define different values, each net uses the following factory-defaults:

- | | |
|--------------------------|--------------------------|
| • Net Name | No default defined |
| • Self Address | No default defined |
| • AllCall | Send and receive enabled |
| • AllCall Channel | No default defined |
| • Tune Time | No tune time |
| • Silent | No |
| • Home Acknowledgment | Yes |
| • Monitor Acknowledgment | No |
| • Master/Slave | Master |
| • LQA Request | Yes |
| • Sounding | Manual |
| • Occupancy Check | No |
| • Scanned Channels | No default defined. |

When programming a new network or other ALE parameters, you do not need to define all parameters – change only those for which the default values are not suitable.

Setting the Net Options

Use this menu to configure net options. The following sections explain the purpose of the net options. For detailed instructions, refer to Part II of this manual.

- **SOND** **Sounding Parameters:** define the interval (in minutes) at which automatic sounding is performed (30, 60, 90 or 120 minutes), or define sounding as a manual function. See Sounding on page 50 for a detailed explanation on the sounding process.
- **SLNT** **Silent Mode:** select whether the net is in the silent mode, which means that members in the net can initiate calls but not allowed to respond to an ALE transmission.
- **LQAR** **LQA Reports:** select whether your radio will ask the called station for a report on the quality of the communication every time a call is initiated.
- **SCN** **Scan Rate:** select the number of channels scanned each second when the radio is in ALE mode: can be set to 2 or 5 channels per second.
- **HACK** **Home Acknowledgment:** enable/disable home acknowledgment. When enabled, the radio transmits an end-of-call indication to the remote station.
- **MACK** **Monitor Acknowledgment:** enable/disable monitor acknowledgment. When enabled, the radio transmits an *accept call* indication to the station that initiated the call.
- **OCUP** **Occupancy Check:** enable/disable the occupancy check. The occupancy check defines whether the radio uses the speech detect mechanism to determine whether a channel on which a call is about to be made is occupied. If this option is ON, a call cannot be initiated on a channel determined to be occupied. This option can be operated in addition to the ALE signal detection mechanism.
You can select the interval at which occupancy checks are made (300 to 3000 msec, in 300-msec increments).
- **M/S** **Master/Slave:** select whether your radio serves as a master or slave in the current ALE network. Only a master station can initiate a Net Call.
- **ALLC** **AIICall Settings:** this option determines whether the ALE is able to receive and/or send AIICalls.

An AIICall is an ALE broadcast transmission. All stations receiving an AIICall are linked to the sender, even if they do not recognize the sender's address. If no AIICall channel is defined, the call will be made on the best channel in the net.

- **TUNE** **Tune Time:** select the tuning time. Tuning time is the maximum time the current ALE waits for the called station to tune (this is the tune-in time of the slowest tuner in the net). The tune time is added to the calculated response time. Tune time can be 1 to 20 seconds, or OFF (zero).

Directory Parameters

This DIR option on the ALE Programming menu enables preparing the ALE address list. This list contains the names of stations to which the radio can address a private call using the ALE. You can add a new address, and edit an existing address.

A name can contain up to 15 characters. Valid characters are the letters A to Z and the numerals 0 to 9. You cannot add an address which is identical to the name of a programmed net, nor an address already used as a self address in a programmed net. The list can contain up to 100 addresses, and is automatically sorted in ascending alphanumeric order.

AMD Message Configuration

The AMD option of the ALE Programming menu is used to view, edit, add or erase messages intended for transmission. The characters you can enter in messages using the radio keypad are: A to Z, 0 to 9, space, * and #. See message preparation details on page 30.

Messages programmed using a remote PC with a standard keyboard can contain all the ASCII characters the range of 20 (hex) to 5F (hex).

The message list can contain up to 12 messages, numbered AMD 0 to AMD 11. Each message can contain up to 90 characters.



Notes

1. *If no messages are stored, **empty** will appear in the second display line.*
2. *Only the first 10 messages can be programmed using the RSS. The 2 additional messages can only be programmed from the front panel.*

ALE Options Configuration

This menu enables you to configure the following ALE options:

- **PTOT** PTT Timeout: the time (in minutes) which elapses between the moment you release the PTT button, until the ALE disconnects the link. The allowed range is 1 to 10 minutes.
- **EXAL** External Alarm: activate/deactivate the radio external alarm when a call is received.
- **ALRT** Alert tone: enable/disable the generation of an alert tone whenever a link is established.
- **TOT** Accept Link Time-out Time: the radio can be configured to disconnect the link automatically if neither the PTT, nor any other key is pressed within 30 seconds from the reception of a call. If Accept Link TOT is set to NO, the received call is accepted immediately and automatically.
- **MLQA** Minimum LQA Score: determines the minimum acceptable LQA (Link Quality Analysis) score allowed when trying to establish a link on a specific channel.

If the minimum score is not achieved when the radio attempts to establish a link in the ALE mode, the radio will try to establish a link on the scanned channel with the next best LQA score. At the end of this process, a link will be established on the scan channel with the best LQA score. If the call is made on a specific channel, the radio ignores the minimum LQA score check.

The allowed range of LQA scores is 0 to 100%. When selecting the minimum LQA score, remember that in accordance with the ALE standards, the maximum LQA score (assigned for receiving an optimum sounding is 70%), and the minimum score is 30%. The score given to a station that did not send any sounding or a station whose sounding has not been received is also 30%.

- **QCAL** Quick Call: enable/disable initiating a call to the last called address by pressing the MIC PTT button twice in rapid sequence (**double pressing**).
- **AADR** Automatic address: enable/disable automatically adding the source addresses of incoming calls to the ALE directory.



Note

If the directory is full, new addresses will not be added.

- **MNT** MultiNet: enable/disable the scanning of multiple ALE nets. When enabled, this feature lets the radio communicate with stations in nets other than the currently selected net.
- **MxCH** Maximum Scan Channels: when MultiNet is enabled, the time needed for scanning all the nets may be rather long. This parameter is used to adapt the duration of the calling signal to the number of scanned net, to ensure that communications are not disrupted.
You can use automatic selection, or select a specific value in the range of 0 to 59 seconds.
- **ANY** AnyCall: enable/disable the sending of AnyCalls.
- **WILD** Wildcard: enable/disable the sending wildcard calls.
- **AMD** Automatic Message Display: enable/disable the sending of AMD messages.
- **ILNK** Inlink: enable/disable the inlink facility, which enables notifying other call participants when each participant disconnects from the link. All participants must be programmed to use the same selection (either YES or NO).
Do not enable the inlink function when communicating with a radio that does not support the full ALE capabilities in accordance with MIL-STD-188-141B.
- **BDLK** Bidirectional link: enable/disable the automatic setting up of a link on the best channel after a bidirectional handshake with an individual station.

The ALE options have the following factory-default values:

- PTT Timeout No timeout
- Alert Yes
- External Alarm Yes
- Auto Address No
- Quick Call Yes
- Minimum LQA score 0
- Accept Link Timeout Yes
- MNT Yes
- MxCH Auto
- ANY Yes
- WILD Yes

- AMD Yes
- ILNK No
- BDLK No

When configuring ALE options, you do not need to define all parameters – change only those for which the factory-default values are not suitable.

Auto Dial Parameters

Auto Dial enables you to set shortcuts for calls to frequently called stations, with or without automatically attaching messages when a station is called:

- **AUTO** Used to configure up to 10 autodial codes, numbered AUTO 0 to AUTO 9.
- **AMD** Used to prepare AMD messages for sending when an autodial code is used. See message preparation details on page 30.



If a message is attached to the address, an exclamation mark precedes the address.

Note

Storing ALE Parameters

Before exiting the ALE programming menu, you must store the parameters you have programmed.



Important

*If you press the **MENU** or **ESC** key to exit the programming mode without first saving your changes, you will be prompted to store the ALE configuration changes. Press **YES** to store the configuration.*

*If you press **NO**, the configuration will revert to the previous configuration, and any changes made in the ALE programming session will be ignored.*

Using the New Station Address Filter

To help you add new station addresses to the ALE directory of your radio set in a controlled manner, MICOM-2 has a special ALE address filter. To enable this filter, enable the Auto Address function on the **PROG>ALE>OPT>AADR** menu (this function can also be enabled by means of the RSS).

When enabled, the address filter compares the source address of each call received by your radio set with the addresses stored in the ALE directory. When the first new unlisted address is found, it is stored in a special memory stack, and you are notified that at least one unlisted address has been detected by adding the option **RCV** (F2) under **PROG>ALE**, after the **NET** option. When you want to check the addresses stored in the stack, you select **RCV** (F2) and then decide whether to erase an address or add it to the ALE directory of your radio set.

Up to 20 new addresses can be stored in this stack, which is organized as a FIFO stack: this means that when a new address, different from all the previously detected addresses, is received while 20 addresses are already stored, it will replace the oldest address.

The information on the received addresses is automatically erased when the radio is turned off; only addresses added to the directory remain in the directory.

► To edit the received addresses and add addresses to the ALE directory:

1. Press **MENU** (F1) and select **ALE** (F2)
2. When addresses are stored in the new received addresses stack, you will see the **RCV** (F2) option. Press **RCV** (F2) to display the RCV screen.
3. You will see RCV screen. The screen displays the last detected unlisted address. Use the **UP/DOWN** arrows to display the desired address (the display is cyclical).
4. When the desired address is displayed, press the key corresponding to the action to be performed:
 - To delete the address from the stack, press **ERAS** (F2).
 - To add the address to the directory, press **ADD** (F1). The address is removed from the stack
5. To confirm, press **SAVE** (F4).
6. Repeat the actions until all the desired addresses are processed. When done, press **ESC** to end.

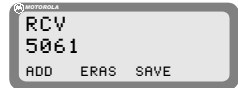

If the stack is now empty, the **RCV** (F2) option is no longer displayed on the ALE menu.

Free Manuals Download Website

<http://myh66.com>

<http://usermanuals.us>

<http://www.somanuals.com>

<http://www.4manuals.cc>

<http://www.manual-lib.com>

<http://www.404manual.com>

<http://www.luxmanual.com>

<http://aubethermostatmanual.com>

Golf course search by state

<http://golfingnear.com>

Email search by domain

<http://emailbydomain.com>

Auto manuals search

<http://auto.somanuals.com>

TV manuals search

<http://tv.somanuals.com>