

Programmable Display GT10/GT30 Technical Manual



Includes installation guide for GTWIN screen creation software.

Applicable Models

GT10 (Ver. 1/Ver. 2)
GT30

SAFETY PRECAUTIONS

[ALWAYS OBSERVE THESE PRECAUTIONS]

Before installing, operating, servicing or inspecting this product, please make sure you have read this manual and the explanations of how procedures are carried out, and make sure the product is used correctly.

This manual uses two safety standard levels: "WARNING" and "CAUTION".

WARNING

Erroneous handling of an item marked with this label can cause fatal or critical injury to the user.

- **If this product is used in applications where accidents involving bodily injury and/or significant damage may be conceivable, measures should be taken to ensure adequate safety, such as the use of duplicate safety mechanisms.**
- **The functions of the GT main unit should not be used to design systems which may pose a threat to human life or which may cause severe injury or damage. Designs should include safety mechanisms for use in the event that switch functions do not function correctly.**
- **Do not use this product in an environment where combustible gases are present. This can cause explosion.**
- **Do not dispose of it by incineration. This can cause it to explode.**

CAUTION

Erroneous handling of an item marked with this label can cause injury to the user, or physical damage to property.

- **This product should not be used outside of the stated specifications ranges for ratings, service life, configuration factors and other elements. This can cause abnormal generation of heat and smoke.**
- **The operational force of the touch panel should be kept to 0.98 N or lower. Operating the touch panel at a higher force could cause damage.**
- **Never touch terminals while the power supply is on. This can cause electric shock.**
- **Never disassemble or alter this product. This can cause electric shock and smoke generation.**

How This Manual Is Configured

GT10/GT30 Main Unit

Before Using the GT series

This section describes items that should be confirmed and precautions that should be observed before the GT series are used.

Chapter 1. Specifications

This chapter contains the names and specifications of the various parts of the GT series, as well as a table of functions, wiring diagrams, and dimensions.

Chapter 2. Installation and Wiring

This chapter explains how the GT series should be installed and how wiring should be connected.

Chapter 3. Setup

This chapter describes the setup procedures necessary when using the GT series for the first time.

Chapter 4. Connecting and Communicating with the PLC

This chapter explains how to connect the GT series to the PLC and the FP series by Matsushita, and how to set up communications between the units.

Chapter 5. GT10 Configuration Settings

This chapter describes the configuration settings for the GT10, and how they should be entered.

Chapter 6. GT30 Configuration Settings

This chapter describes the configuration settings for the GT30, and how they should be entered.

Chapter 7. How the Various Functions Are Used

Functions such as switching GT series screens, backlighting, and buzzer control are explained here.

Chapter 8. Servicing and Maintenance

This chapter describes servicing and maintenance procedures for the GT series, as well as how optional items are handled.

Chapter 9. Troubleshooting

This explains what to do if there appears to be something wrong with the GT series, or an error occurs.

Screen Creation Tool Terminal GTWIN

Before Using Terminal GTWIN

This section contains special precautions that should be read if you are using GTWIN.

Chapter 10. Preparing GTWIN

This section explains how to install GTWIN in the personal computer, how to boot it, and how to exit it.

Table of Contents

How This Manual Is Configured	ii
-------------------------------------	----

Part I GT10, GT30 Main Unit

Before Using the GT10/GT30	x
GT10/GT30 Usage Procedures	xi
Confirming the Package Contents	xiii
GT Series System Configuration	xvii
Products for the GT Series	xix
Safety Precautions	xx

Chapter 1 Specifications

1.1 GT10/GT30 Specifications	2
1.1.1 General Specifications	2
1.1.2 Display	2
1.1.3 Functions	2
1.1.4 Touch Key	3
1.1.5 Memory (1)	3
1.1.6 Memory (2)	3
1.1.7 Interface	4
1.2 GT10 Names and Functions of Parts	5
1.2.1 GT10 (front)	5
1.2.2 GT10 (rear)	5
1.2.3 Names and Functions of Parts	5
1.3 GT30 Names and Functions of Parts	7
1.3.1 GT30 (front)	7
1.3.2 GT30 (rear)	7
1.3.3 Names and Functions of Parts	7
1.4 Internal Wiring Connections for Ports	9
1.4.1 COM. Port	9
1.4.2 TOOL Port	9
1.4.3 Power Supply Terminals	10
1.5 Dimensions	11
1.5.1 GT10 Dimensions	11
1.5.2 GT10 Panel Cutout Dimensions	12
1.5.3 GT30 Dimensions	12
1.5.4 GT30 Panel Cutout Dimensions	13

Chapter 2 Installation and Wiring

2.1	Installation	16
2.1.1	Installation Environment	16
2.1.2	GT10 Installation Method	17
2.1.3	GT30 Installation Method	19
2.2	Wiring the Power Supply	21
2.3	Wiring the COM. Port	23
2.3.1	Wiring Method	24
2.3.2	Precautions Concerning Wiring	24

Chapter 3 Setup

3.1	Setup Procedure for the GT10	26
3.2	Setting the Basic Communication Area, GT10 and PLC	29
3.2.1	What is the Basic Communication Area?	29
3.2.2	GT10 Basic Communication Area Map	30
3.3	Setup Procedure for the GT30	34
3.4	Setting the Basic Communication Area, GT30 and PLC	37
3.4.1	What is the Basic Communication Area?	37
3.4.2	GT30 Basic Communication Area Map	38

Chapter 4 Connecting and Communicating with the PLC

4.1	Connecting the FP–Sigma	42
4.1.1	Connecting to the COM. Port	42
4.1.2	Connecting to the TOOL Port	43
4.2	Connecting the FP0	45
4.2.1	Connecting to the COM. Port	45
4.2.2	Connecting to the TOOL Port	46
4.3	Connecting the FP1	48
4.3.1	Connecting to the COM. Port	48
4.4	Connecting the FP2/FP2SH	49
4.4.1	Connecting to the COM. Port	49
4.4.2	Connecting to the TOOL Port	50
4.5	Connecting the FP2/FP2SH CCU	51
4.6	Connecting the FP10SH	52
4.6.1	Connecting to the COM. Port	52
4.6.2	Connecting to the TOOL Port	53
4.7	Connecting the FP10SH/FP3 CCU	55

4.8	Connecting the FP–M	56
4.8.1	Connecting to the COM. Port	56
4.8.2	Connecting to the TOOL Port	57
4.9	Automatic Communication Settings Function	58
4.10	Through Function	60
4.11	Connecting with a PLC by Mitsubishi Electric Corp.	62
4.11.1	FX Series	62
4.12	Connecting with a PLC by Omron Corp.	64
4.12.1	SYSMAC C Series, a Series, CV Series, and CS1 Series	64

Chapter 5 GT10 Configuration Settings

5.1	GT10 Configuration Settings	72
5.1.1	Two Types of GT10 Configuration Settings	72
5.2	Entering Configuration Settings with GTWIN	73
5.2.1	Opening the GT Configuration Settings	73
5.2.2	GT Configuration Settings: “Basic Setup”	73
5.2.3	GT Configuration Settings: “Communication Parameters”	75
5.2.4	GT Configuration Settings: “Auto–Paging”	77
5.2.5	GT Configuration Settings: “Startup Screen Settings”	79
5.2.6	GT Configuration Settings: “Setup”	80
5.2.7	GT Configuration Settings: “Hold PLC Device”	82
5.2.8	GT Configuration Settings: “GT Internal Device Hold”	83
5.3	Entering Configuration Settings from the GT10	85
5.3.1	What is the System Menu?	85
5.3.2	Bringing Up the System Menu	85
5.3.3	Setting Mode: “Communication Parameters” (COM. Port / TOOL Port)	86
5.3.4	Setting Mode: “Liquid Crystal Display Contrast Adjustment” (Contrast)	87
5.3.5	Setting Mode: “Clock Settings” (Clock)	88
5.3.6	Setting Mode: “Memory Initialization” (Clear Memory)	89
5.3.7	Test Mode: “Self–Diagnosis”	89
5.3.8	Inhibiting the System Menu Display	91

Chapter 6 GT30 Configuration Settings

6.1	GT30 Configuration Settings	94
6.1.1	Two Types of GT30 Configuration Settings	94
6.2	Entering Configuration Settings with GTWIN	95
6.2.1	Opening the GT Configuration Settings	95
6.2.2	GT Configuration Settings: “Basic Setup”	95

6.2.3	GT Configuration Settings: “Communication Parameters”	97
6.2.4	GT Configuration Settings: “Auto–Paging”	99
6.2.5	GT Configuration Settings: “Startup Screen Settings”	101
6.2.6	GT Configuration Settings: “Setup”	102
6.2.7	GT Configuration Settings: “Hold PLC Device”	104
6.2.8	GT Configuration Setting: “GT Internal Device Hold”	105
6.3	Entering Configuration Settings from the GT30	108
6.3.1	What is the System Menu?	108
6.3.2	Bringing Up the System Menu	108
6.3.3	Setting Mode: “Liquid Crystal Display Contrast Adjustment”	108
6.3.4	Setting Mode: “Clock Settings” (Clock)	109
6.3.5	Setting Mode: “Communication Parameters” (TOOL Port / COM. Port)	111
6.3.6	Setting Mode: “Memory Initialization” (Clear Memory)	112
6.3.7	Test Mode: “Self–Diagnosis”	113
6.3.8	Inhibiting the System Menu Display	114

Chapter 7 How the Various Functions Are Used

7.1	Switching Screens	116
7.1.1	Switching the Screen from the PLC	116
7.1.2	Switching the Screen with the GT Main Unit	117
7.2	GT10 Bit Device Functions	122
7.3	GT30 Bit Device Functions	124

Chapter 8 Servicing and Maintenance

8.1	The Internal Secondary Battery (GT10)	128
8.2	Battery (GT30)	130
8.3	Replacing the Front Panel Protective Sheet	131
8.4	Replacing the Waterproof Packing	132
8.5	Replacing the Backlight (GT30 Only)	133

Chapter 9 Troubleshooting

9.1	What to Do If Something Unusual Occurs (GT10)	136
9.2	What to Do If Something Unusual Occurs (GT30)	139
9.3	Error Codes and How to Handle Them	142
9.3.1	GT Series Error Codes	142
9.3.2	PLC Error Codes	144

9.4	GT10 Screen Messages	145
9.5	GT30 Screen Messages	146

Part II Screen Creation Tool Terminal GTWIN

Usage Environment and GT Main Unit Models that are Supported	149
Important Note About Saving Screen Data Files	150

Chapter 10 Preparing GTWIN

10.1	Installing GTWIN	152
10.2	Booting GTWIN	158
10.2.1	Selecting the Working Menu	158
10.2.2	Selecting the Model	158
10.2.3	Entering Settings for the Basic Communication Area to PLC	159
10.3	Exiting GTWIN	160
10.4	Procedures for Using GTWIN	161

Appendix A Code Tables

A.1	BIN/HEX/BCD Code Correspondence Table	166
A.2	ASCII Code Table	167

Index

Record of Changes

Part I

GT10, GT30 Main Unit

Before Using the GT10/GT30

This section describes items that should be confirmed and precautions that should be observed before the GT10/GT30 is used. Make sure you read this section before using the GT10/GT30.

GT10/GT30 Usage Procedures

If you are using the GT10/GT30 for the first time, please follow the procedure outlined below.

Procedure For Using the GT10/GT30

1. Confirm the items included with the product. ➡ page xiii

Please confirm that all of the items have been included with the product you have purchased. Products are carefully checked before being shipped, but if you do find anything missing, please contact your dealer.

2. Confirm the items listed under “Safety Precautions”. ➡ page xx

Before using your product, please make sure you read the items listed under “Safety Precautions”, in order to make sure your product is used safely. After reading the precautions, please make sure the product is used correctly.

3. Install and wire the main unit. ➡ page 16

Install the main unit, and connect the power supply, PLC connection cable and other wiring. When installing and wiring the product, carefully read the explanation on pages 16 to 19 concerning the installation environment, and make sure the product is installed correctly, in an appropriate environment. For information on connecting the product to the FP series PLC, and on entering communications settings, please see page 42 and subsequent pages.

4. Set up the main unit. ➡ page 26, 34

When the product is shipped from the factory, it is set up with specifications that enable connection to the FP series PLC. If you plan to use the product without changing these settings, no setup is required, but if you plan to change the settings, you will need to follow the setup procedure outlined on page 26, 34 and subsequent pages. Particularly with regard to the basic communication area to the PLC and other devices, please confirm the settings carefully and change only those that are necessary.

■ Main cases in which setup is necessary

- When the device being connected is a general-purpose serial device (such as a computer or microcomputer board)
- When the basic communication area for the device is different from that set when the product is shipped

5. Check communication with the external device (PLC, etc.). ➡ page 45

Check the connections and communication with the external device. Connections and communication with devices in the FP series PLC vary depending on the device, so check the information on page 45 and subsequent pages.

6. Enter the operating environment settings. ➡ page 72

In addition to the setup described at step 4, various detailed settings can be entered for the GT10/GT30 operating environment. Enter any necessary operating environment settings, referring to page 72 and subsequent pages.

7. Install the screen creation tool.**➡ page 149**

Install the Terminal GTWIN screen creation tool in the personal computer. Follow the instructions on page 149 and subsequent pages to install the software.

8. Create the screen contents.

Create the screen contents using the Terminal GTWIN screen creation tool, and send the screen to the GT main unit. For information on creating screens and on operating GTWIN, please refer to the Help function that comes with GTWIN.

9. Test the operation.

Connect the GT main unit containing the screen data to an external device (PLC or general-purpose serial device), and check the operation contents.

Confirming the Package Contents

Check to make sure the necessary items have been included with the product you have purchased.

Items Included with the GT10 (AIGT1000B)

Main unit



Set of attachment fittings

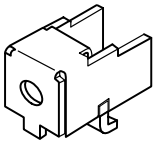

Attachment fittings x 4

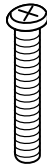

Attachment screws x 4

Communication connector

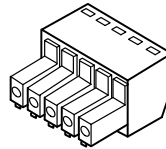

Front panel protective sheet

There is a front panel protective sheet, available as an optional product, attached to the front panel of the unit.

Waterproof packing

One piece of waterproof packing has been attached to unit.

Installation instructions

Please read these instructions carefully before using the product.



◆ CAUTION

- There is a film over the front panel protective sheet. Remove this film when using the unit. For instructions on removing the film, see page 131.
- Front panel protective sheets for replacement are available as a separate purchase (AIGT180). Please see page xix.
- Waterproof packings for replacement are available as a separate purchase (AIGT181). Please see page xix.

Items Included with the GT30 (AIGT3100B/AIGT3300B)

Main unit



STN monochrome liquid crystal display type: AIGT3100B

STN color liquid crystal display type: AIGT3300B

Set of attachment fittings

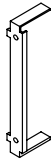

Fittings x 2

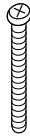

Screws x 4

Communication connector

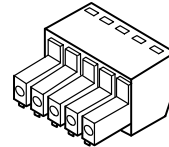

Front panel protective sheet

There is a front panel protective sheet, available as an optional product, attached to the front panel of the unit.

Waterproof packing

One piece of waterproof packing has been attached to unit.

Installation instructions

Please read these instructions carefully before using the product.



◆ CAUTION

- There is a film over the front panel protective sheet. Remove this film when using the unit. For instructions on removing the film, see page 131.
- Front panel protective sheets for replacement are available as a separate purchase (AIGT380). Please see page xix.
- Waterproof packings for replacement are available as a separate purchase (AIGT381). Please see page xix.
- A replacement backlight (AIGT382) is available, sold separately. Please see page xix for details.
- The commercially available CR2032 should be used for battery replacement.

Items Included with the Terminal GTWIN English–language version (AIGT8001V2)

Terminal GTWIN CD–ROM

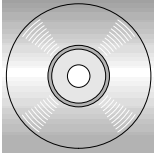

Software usage license agreement and user card

Read the “Software usage license agreement” carefully, and fill in the user card. Please return the user card to Matsushita.

GT10/GT30 Technical Manual

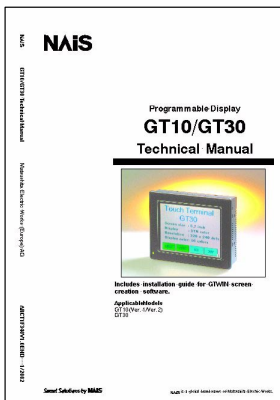

This is the manual you are currently reading. It contains instructions on installing and booting GTWIN. Please read it carefully before using your product.



◆ CAUTION

About the software usage license agreement and user card

- Before using GTWIN, read the “Software usage license agreement” carefully.
- The license agreement comes as a set with the user card. Fill in the user card, and return it to Matsushita. The user card is necessary in order to obtain support services such as future version upgrades and technical support. Don’t forget to return the card in order to be eligible for such services.
- The serial number needed in order to install GTWIN is found on the user card. Please make a copy of it before returning the card, and keep it in a safe place.

Items Included With the PLC Connection Cable (AIGT8192 / AIP81842D) Cable

One of the following two cables has been included with the product you have purchased.

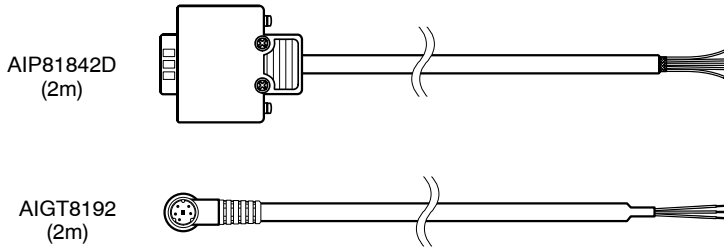

Wiring diagram

The package includes a diagram that shows the internal wiring of the cables pictured above.



◆ REFERENCE

For information on connecting and wiring the cables shown above and the PLC, please refer to page 41, Chapter 4, “Connecting and Communicating with the PLC”.

Items Included with the Front Panel Protective Sheet (AIGT180/AIGT380)

Front panel protective sheet

In order to protect the touch panel on the GT series and keep it clean, one front panel protective sheet is included when the unit is shipped. If this front panel protective sheet is dirty or has become worn, it should be replaced. Replacement sheets are sold separately, in packages of ten.

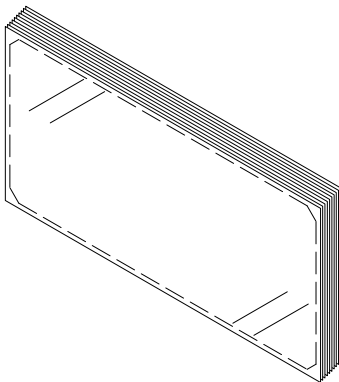

Installation instructions

Please read these instructions carefully before installing the product.



◆ REFERENCE

For information on replacing the front panel protective sheet, please refer to page 131.

GT Series System Configuration

The following devices are necessary in order to use the GT series.

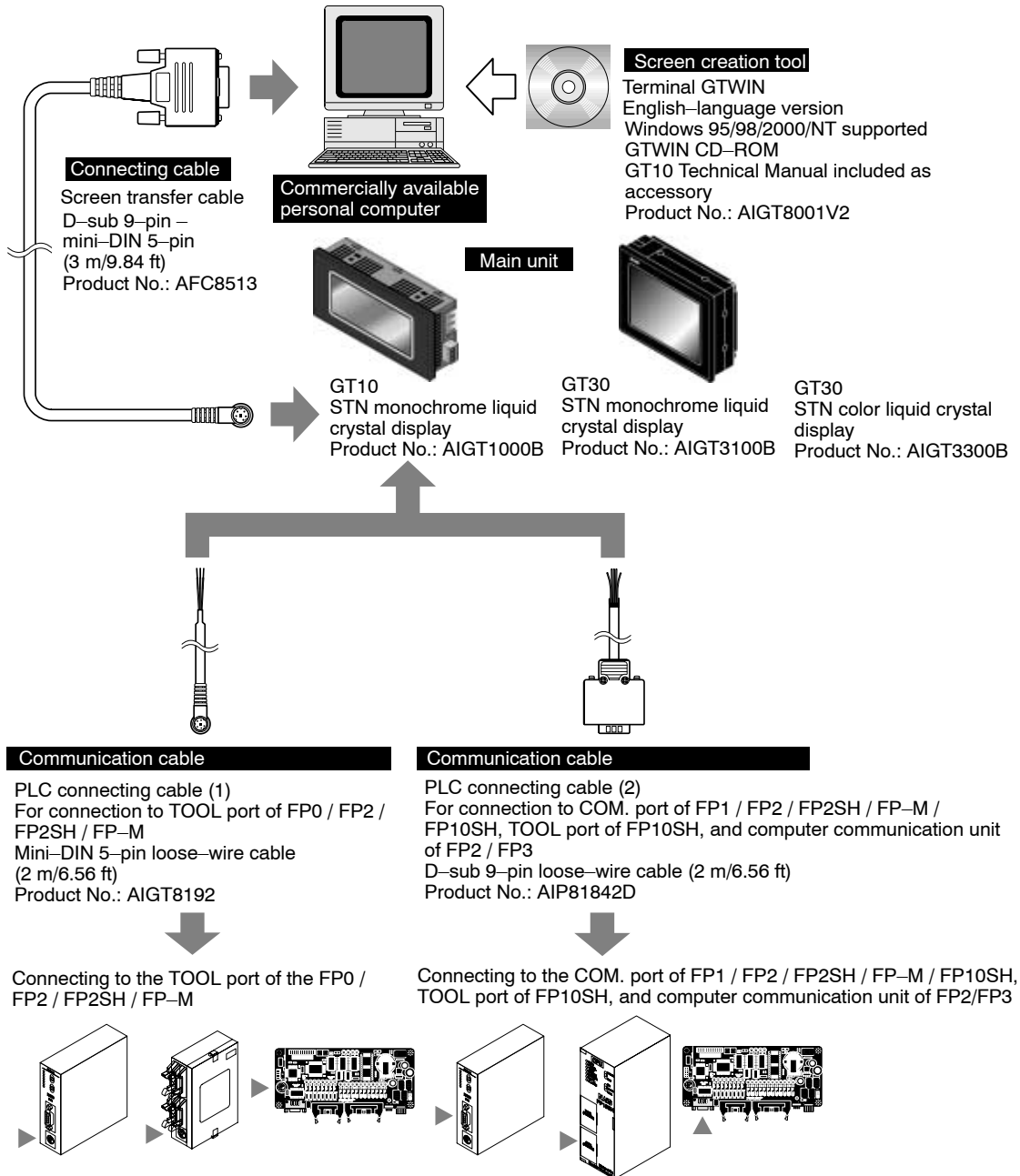



Connecting to the COM. port of the FP0

Because connecting the unit to the COM. port of the FP Σ /FP0 requires a loose-wire connection, this cable is not available. For more detailed information, please see “Connecting the FP Σ ” on page 42 or “Connecting the FP0” on page 45.

Products for the GT Series

Products types

Item Name	Contents	Product No.
GT10 main unit	Programmable display unit GT10 main unit	STN monochrome liquid crystal display AIGT1000B
GT30 main unit	Programmable display unit GT30 main unit	STN monochrome liquid crystal display AIGT3100B
		STN color liquid crystal display AIGT3300B
Terminal GTWIN English-language version	– “Terminal GTWIN” English-language screen creation tool (CD-ROM) – Set of GT10 Technical manuals (English)	AIGT8001V2
Screen transfer cable	Cable for transferring data between GTWIN and GT10 (3m/)	AFC8513
PLC connecting cable (1)	For connection to TOOL port of FP0 / FP2 / FP2SH / FP-M Mini-DIN 5-pin loose-wire cable (2m)	AIGT8192
PLC connecting cable (2)	For connection to COM. port of FP1 / FP2 / FP2SH / FP-M / FP10SH, TOOL port of FP10SH, and computer communication unit of FP2 / FP3 D-sub 9-pin loose-wire cable (2m)	AIP81842D
Front panel protective sheet	Front panel protective sheet for GT10 (for replacement). Ten in set. * 1 sheet included with GT10 when shipped.	AIGT180
	Front panel protective sheet for GT30 (for replacement). Ten in set. * 1 sheet included with GT30 when shipped.	AIGT380
Waterproof packing	Waterproof packing for GT10 (for replacement). Ten in set. * 1 piece included with GT10 when shipped.	AIGT181
	Waterproof packing for GT30 (for replacement). Ten in set. * 1 sheet included with GT30 when shipped.	AIGT381
Replacement backlight	This is the replacement backlight for the GT30 color/monochrome liquid crystal display.	AIGT382



◆ CAUTION

- Connecting to the COM. port of the FP0**
 Because connecting the unit to the COM. port of the FP Σ /FP0 requires a loose-wire connection, this cable is not available. For more detailed information, please see “Connecting the FP Σ ” on page 42 or “Connecting the FP0” on page 45.
- About the manual packed with the Terminal GTWIN English-language version**
 The manual you are currently reading is included as an accessory with the Terminal GTWIN English-language version. This manual contains information only on procedures such as installing GTWIN. For detailed information on operating GTWIN, please refer to the Help function in the software.

Safety Precautions

Before installing, operating, servicing or inspecting this product, please make sure you have read this manual and the installation instructions, and make sure the product is used correctly.

This manual uses two safety standard levels: "WARNING" and "CAUTION".

WARNING

Erroneous handling of an item marked with this label can cause fatal or critical injury to the user.

- If this product is used in applications where accidents involving bodily injury and/or significant damage may be conceivable, measures should be taken to ensure adequate safety, such as the use of duplicate safety mechanisms.
- The functions of the GT series should not be used to design systems which may pose a threat to human life or which may cause severe injury or damage. Designs should include safety mechanisms for use in the event that switch functions malfunction.
- Do not use this product in an environment where combustible gases are present. (This can cause explosion.)
- Do not dispose of it by incineration. (This can cause it to explode.)

CAUTION

Erroneous handling of an item marked with this label can cause injury to the user, or physical damage to property.

- This product should not be used outside of the stated specifications ranges for ratings, service life, configuration factors and other elements. (This can cause abnormal generation of heat and smoke.)
- The operational force of the touch panel should be kept to 0.98 N or lower. Operating the touch panel at a higher force could cause damage.
- Never touch terminals while the power supply is on. (This can cause electric shock.)
- Never disassemble or alter this product. (This can cause electric shock and smoke generation.)

Special Items

Maximum attention has been given to quality control of this product; however:

(1) In order to prevent, as much as possible, unexpected situations not covered by these specifications, please consult us regarding your product's specifications and demands, as well as this unit's operating conditions and installation details.

(2) To avoid the unlikely event of a situation attributed to inferior quality of the unit which has serious adverse affects on persons or property, the numeric values for guaranteed characteristics and performance noted in this specifications manual should be considered the minimum necessary values. As the manufacturer of this unit, we recommend incorporating additional safety measures such as duplicate circuits wherever possible.

(3) The quality of this product is guaranteed for one year after purchase, and this guarantee is limited to the range of items stated in these specifications. In the case of a defect in the product which is clearly Matsushita's responsibility, we will offer a replacement unit or replacement of the defective part(s) of the unit and we will repair the unit promptly at the place of purchase. The following are not included in the warranty:

1. Other damage resulting from damage to or defects in the supplied product.
2. Problems caused by conditions other than those noted in these specifications involving use, storage, or shipment (transport) after product delivery.
3. Developments which were unforeseeable given the technology in practical use prior to product delivery.
4. Earthquake, flood, fire, war, and damage due to other naturally occurring events or human disasters for which Matsushita bears no responsibility.

Chapter 1

Specifications

1.1 GT10/GT30 Specifications

1.1.1 General Specifications

Item	GT10 specifications	GT30 specifications
Rated voltage	24 V DC	
Operating voltage range	21.6 to 26.4 V DC	
Power consumption	5 W max.	10 W max.
Ambient temperature	0°C to 40°C/32°F to 104°F (25 V DC max. if installed horizontally)	0°C to 50°C/ 32°F to 122°F (25 V DC max. if installed horizontally)
Ambient humidity	20% RH to 85% RH (non condensing)	
Storage temperature	-20°C to 60°C/-4°F to 140°F	
Storage humidity	10% RH to 85% RH (non condensing)	
Vibration resistance	10Hz to 55 Hz (1-minute cycle) Amplitude: 0.75 mm, 10 min on 3 axes	
Shock resistance	98 m/s ² min., 4 times on 3 axes	
Noise immunity	1,000 V [p-p] min., pulse width 50 ns, 1 μs between power supply terminals (based on noise simulator)	
Static noise resistance	5,000 V min. (panel display)	
Protective construction	IP65 (in initial status) Dustproof and drip-proof from front panel only (packing used on panel contact surface) * When reattaching, replace waterproof packing.	
Mass	Approx. 260 g/9.171 oz	Approx. 440 g/15.519 oz

1.1.2 Display

Item	GT10 specifications	GT30 specifications	
		AIGT3100B	AIGT3300B
Display	STN monochrome LCD	STN monochrome LCD	STN color LCD
Resolution	160 (W) x 64 (H) dots	320 (W) x 240 (H) dots	
Display color	2 colors (black/white)	2 colors (blue/white)	16 colors
Displayable area	92.8 (W) x 37.1 (H) mm 3.65(W) inch x 1.46 (H) inch	118.18 (W) x 89.38 (H) mm 4.65 (W) inch x 3.52 (H) inch	
LCD life	Average: 50,000 hours (at normal temperature of 25°C)		
Backlight	3-color LED backlight (green, red, orange) * No replacement necessary	CFL * Average backlight service life: 50,000 hours (25°C)	

1.1.3 Functions

Item	GT10 specifications	GT30 specifications
Displayable fonts	Fixed fonts: 1/4 width (8 x 8), half width (16 x 8), full width (16 x 16) Half width and full width characters can be displayed at same width, doubled width, or quadrupled width True Type fonts	
Character types	Alphanumeric characters	

Item	GT10 specifications	GT30 specifications
Graphics	Straight lines, continuous straight lines, squares, circles, ovals, arcs, elliptic arcs, fan shapes, elliptic fan shapes, beveled squares, bitmaps	
Number of screens	Approx. 160 screens Screen numbers that can be set: Base screens No. 00 to FF (HEX)	Approx. 220 screens (monochrome LCD type) Approx. 160 screens (color LCD type) Screen numbers that can be set: Base screens No. 00 to 3FF
	Number of screens that can be registered varies depending on registered contents.	
Part functions	Messages, lamps, switches, data, bar graphs, clocks, keyboard	
Clock functions	Clock built into main unit (can also be displayed with reference to PLC clock)	
Contrast adjustment	Contrast can be adjusted using touch panel operation	
Automatic communication settings	Settings for communication between dedicated software and PLC set automatically by connecting cable	
Debugging functions	Through function (PLC can be debugged from personal computer by connecting computer to TOOL port and PLC to COM. port)	
Screen creation	Dedicated software Terminal GTWIN used. Applicable OS: Windows 95/98/2000/NT (Ver. 4.0 or later)	

1.1.4 Touch Key

Item	GT10 specifications	GT30 specifications
Touch key resolution	20 (W) x 8 (H)	16 (W) x 12 (H)
Touch key operation	0.98 N max.	
Touch key life	Min. 10 ⁶	

1.1.5 Memory (1)

Screen data and GTWIN Configuration Settings data

Item	GT10 specifications	GT30 specifications	
		AIGT3100B (monochrome LCD type)	AIGT 3300B (color LCD type)
Memory type	F-ROM	F-ROM	F-ROM
Memory capacity	384 kbytes	1.5 Mbytes	3.25 Mbytes

1.1.6 Memory (2)

Clock data and PLC device storage data (24 words max.)

Item	GT10 specifications	GT30 specifications
Memory	SRAM	
Memory backup	Backed up by internal secondary battery (charged when power is on) (Note) When using, set operation mode switch on back of main unit to "ON" position.	Lithium battery (replaceable type) CR2032 (commercially available)

1.1.7 Interface

Item		GT10 specifications	GT30 specifications
COM. Port	Communications ratings	Conforms to RS232C	
	Conditions for communications with external devices	Baud rate: 9600, 19200, 38400, 57600, 76800, 115200 bits/s	Baud rate: 9600, 19200, 38400, 57600, 115200 bits/s
		Data bits: 7 or 8 bits Parity: None, Odd, Even Stop bits: 1 bit	
	Protocol	FP series supported/general-purpose RS232C supported	
	Connector	Connector terminal base (5-pin)	
TOOL port	Communications ratings	Conforms to RS232C	
	Conditions for communications with external devices	Baud rate: 9600, 19200, 115200 bits/s	
		Data bits: 8 bits Parity: None, Odd, Even Stop bits: 1 bit	
	Protocol	Dedicated protocol	
Connector	Mini-DIN (5-pin)		

1.2 GT10 Names and Functions of Parts

1.2.1 GT10 (front)

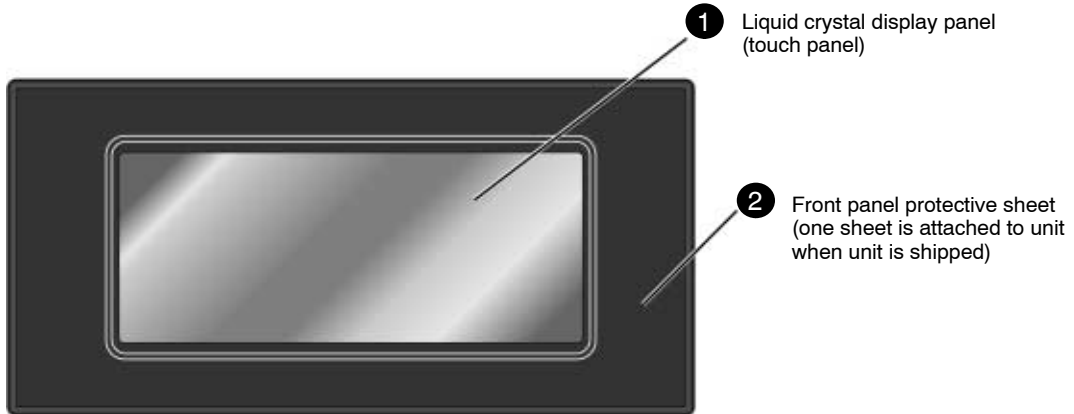

1.2.2 GT10 (rear)

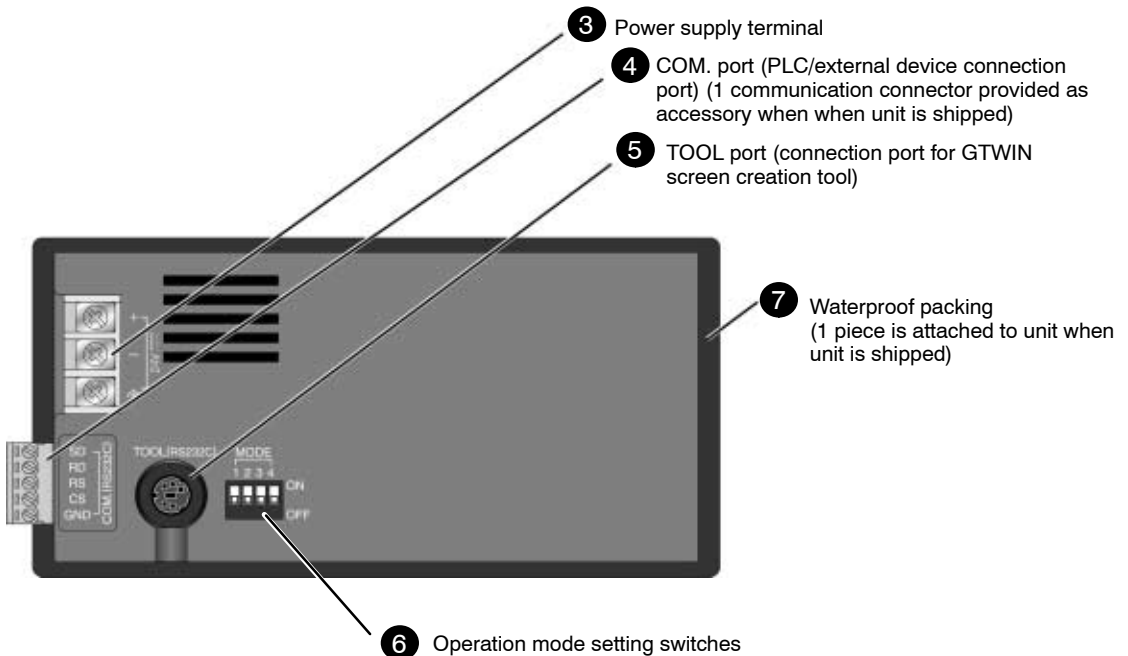

1.2.3 Names and Functions of Parts

(1) Liquid crystal display panel / touch panel

Various screens are displayed here. A touch panel is provided on the liquid crystal display panel, and switches can be operated and data entered simply by touching the panel.

(2) Front panel protective sheet

This protects the touch panel and keeps it clean. One sheet is attached to the panel when the unit is shipped.

(3) Power supply terminal

The operation power supply is connected here.

(4) COM. port (PLC/external device connection port)

A device such as a PLC, a higher-order computer, or a microcomputer board can be connected to this RS232C port. (One communication connector is provided as an accessory when the unit is shipped.)

(5) TOOL port (GTWIN connection port)

This port is used to connect a personal computer in which the screen creation tool GTWIN has been installed, using a dedicated cable (AFC8513).

(6) Operation mode setting switches

With the GT10, screen data and configuration settings data are stored in an internal F-ROM, so no battery backup is needed. However, data such as clock data and the Hold PLC Device Data is stored in the internal SRAM, and is backed up by the internal secondary battery, which is charged when the power supply is turned on.

The operation mode setting switches control the ON/OFF settings for the secondary battery backup function, the ability to shift to the system menu, and other functions.

Operation mode setting switches

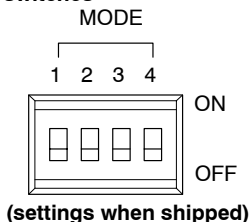

Switch no.	Function	OFF	ON
1	SRAM backup using secondary battery	No	Yes
2	Inhibits system menu shift	Shift possible	Shift inhibited
3	Usage inhibited	Should always be in the OFF position when unit is used	
4			

(7) Waterproof packing

This assures that the front panel is waterproof. One piece is provided as an accessory when the unit is shipped.



SRAM backup by the secondary battery

When the unit is shipped, the No. 1 operation mode setting switch is set to the “OFF” position, in order to prevent excessive discharging of the secondary battery. Before using the unit, turn on the No. 1 operation mode setting switch on the back of the main unit, to turn on the SRAM backup function of the secondary battery. For detailed information on the secondary battery, please see page 128, “What the Internal Secondary Battery Does”.

1.3 GT30 Names and Functions of Parts

1.3.1 GT30 (front)

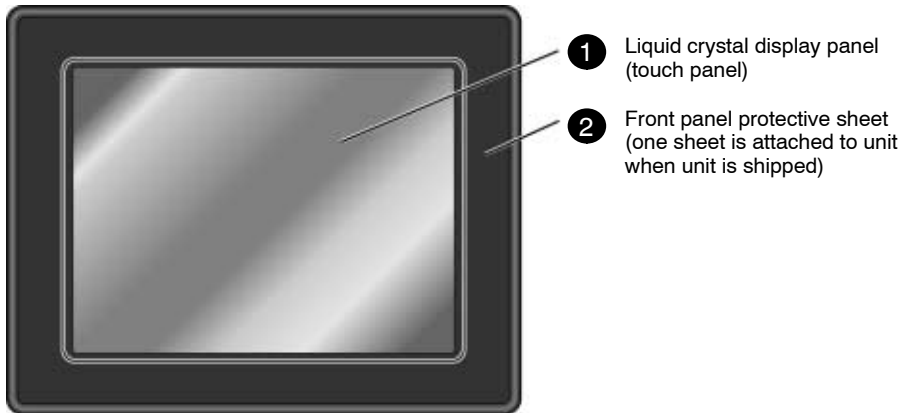

1.3.2 GT30 (rear)

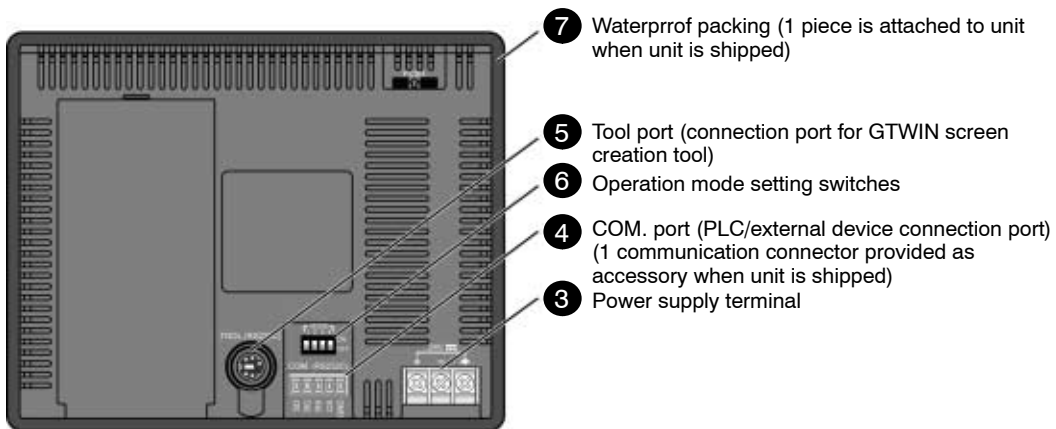

1.3.3 Names and Functions of Parts

(1) Liquid crystal display panel / touch panel

Various screens are displayed here. A touch panel is provided on the liquid crystal display panel, and switches can be operated and data entered simply by touching the panel.

(2) Front panel protective sheet

This protects the touch panel and keeps it clean. One sheet is attached to the panel when the unit is shipped.

(3) Power supply terminal

The operation power supply is connected here.

(4) COM. port (PLC/external device connection port)

A device such as a PLC, a higher-order computer, or a microcomputer board can be connected to this RS232C port. (One communication connector is provided as an accessory when the unit is shipped.)

(5) TOOL port (GTWIN connection port)

This port is used to connect a personal computer in which the screen creation tool GTWIN has been installed, using a dedicated cable (AFC8513).

(6) Operation mode setting switches

The operation mode setting switches control the ability to shift to the system menu, and other functions.

Operation mode setting switches

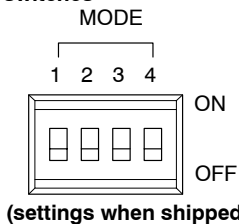

Switch no.	Function	OFF	ON
1	Usage inhibited	Should always be in the OFF position when unit is used	
2	Inhibits system menu shift	Shift possible	Shift inhibited
3	Usage inhibited	Should always be in the OFF position when unit is used	
4			

(7) Waterproof packing

This assures that the front panel is waterproof. One piece is provided as an accessory when the unit is shipped.



With the GT30, screen data and configuration settings are stored in the internal F-ROM. Clock data and PLC device hold data are stored in the internal SRAM, however, and can be backed up by the lithium battery (a replaceable battery). When replacing the lithium battery, be sure to insert the new battery within 20 seconds of removing the old one, to avoid losing the data.

1.4 Internal Wiring Connections for Ports

1.4.1 COM. Port

GT10



SD
RD
RS
CS
GND



When connecting the unit to the FP series, there is no need to wire both the RS and CS.



Wiring and cables should be laid out in such a way that cables are not affected by external noise. Also, shielded wiring should be used for cables.

GT30

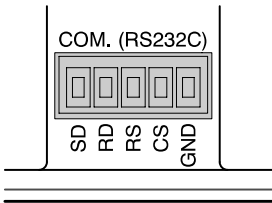

1.4.2 TOOL Port

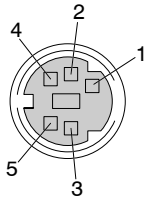

Pin No.	Contents
1	SG
2	SD
3	RD
4	N.C.
5	(+5 V)



The +5 V of Pin 5 is reserved for the FP Programmer II. It should not be used for any other application.

1.4.3 Power Supply Terminals

GT10

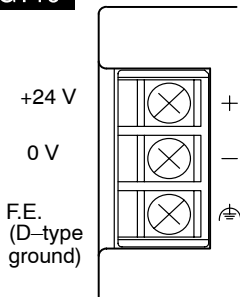

Applicable crimp terminals

– The terminal screws are M3 screws. We recommend using crimp terminals for wiring to terminals.

Open-tip terminals

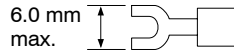

Round terminals

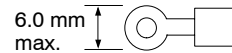

GT30

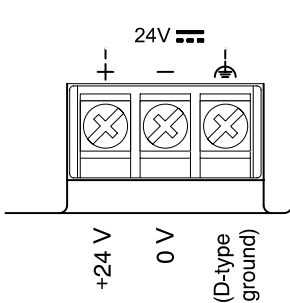

Maker	Shape	Model	Applicable wiring	Tightening torque
JST Mfg. Co., Ltd.	Round	1.25-MS3	0.25 mm ² to 1.65 mm ²	0.5 N m
	Front-opening	1.25-B3A		
	Round	2-MS3	1.04 mm ² to 2.63 mm ²	
	Front-opening	2-N3A		



The tightening torque for terminal base screws should be between 0.5 and 0.6 N·m, or less. Operating at a higher force could cause damage.



If crimp terminals are not being used, wire with a diameter of 0.5 mm² to 1.25 mm² should be used for power cables.



In keeping with the European EMC Directive (EMC Directive 89/336/EEC), the GT10 conforms to European Standards (EN50081-2:1993, EN50082-2:1995). As a condition of compatible, a ferrite core should be installed when wiring to the terminal base (Seiwa Electric Mfg. Co., Ltd. E04RC281613 or equivalent).

When installing make sure that the connection and power cables are not stressed, as this could result in broken connections.

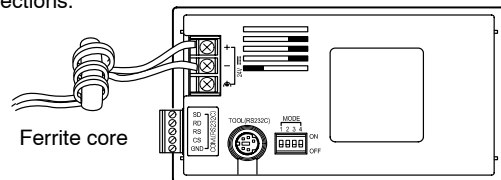

The GT30 conform to European EMC directives (EMC Directive 89/336/EEC) and meet European EMC standards (EN50081-2, EN6100-6-2). A ferrite core (E04SR211132 by Seiwa Electric Mfg. Co., Ltd. or an equivalent product) should be installed when wiring connections to the terminal base, as shown below, in order to meet these requirements. When installing make sure that the connection and power cables are not stressed, as this could result in broken connections.

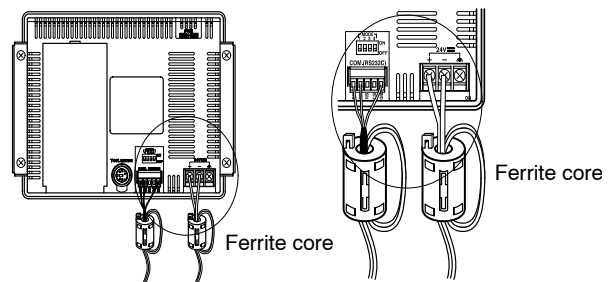

1.5 Dimensions

1.5.1 GT10 Dimensions

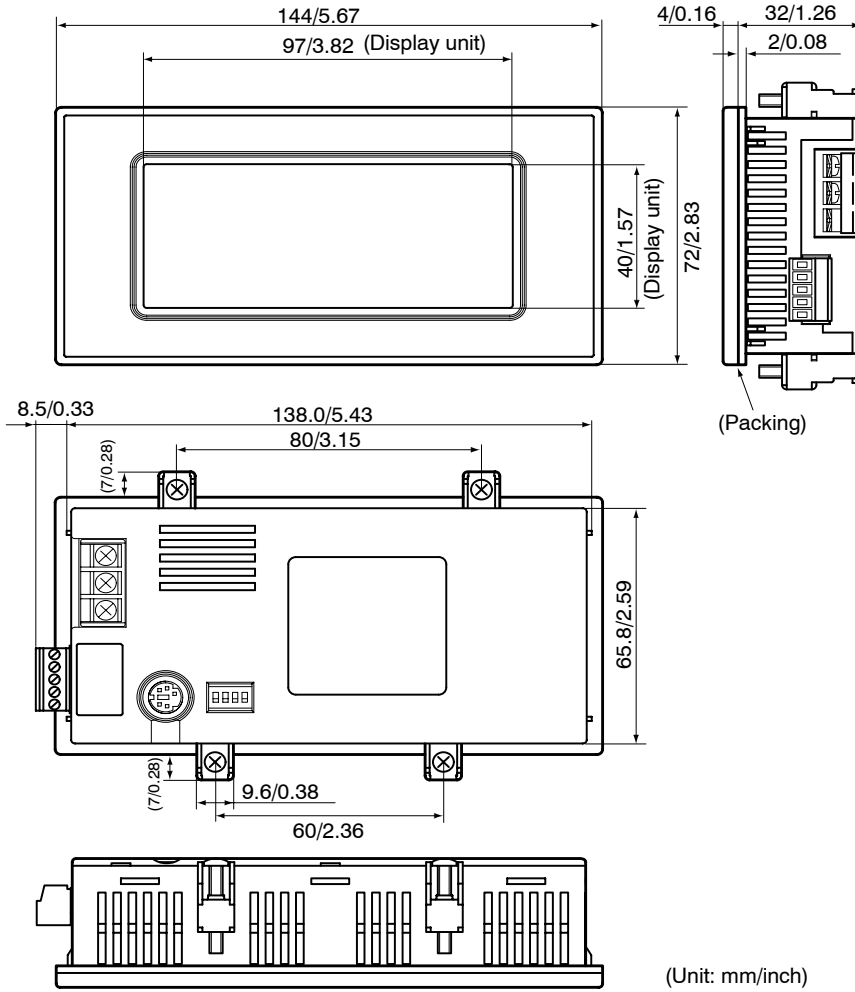

1.5.2 GT10 Panel Cutout Dimensions

The panel cutout dimensions of the GT10 are as shown below.

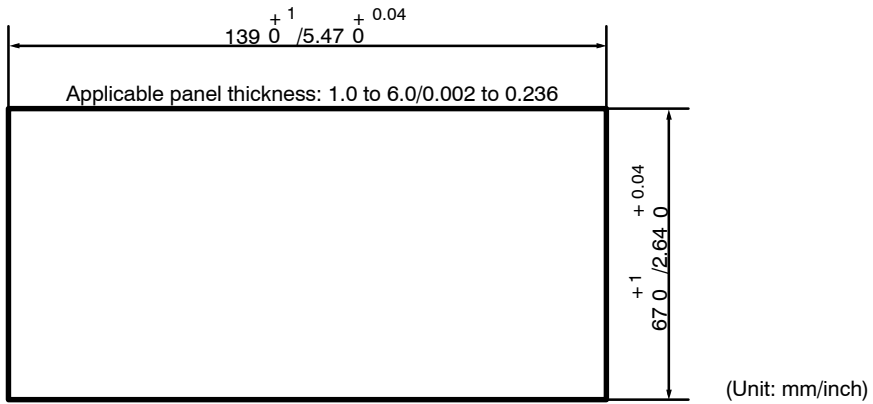

1.5.3 GT30 Dimensions

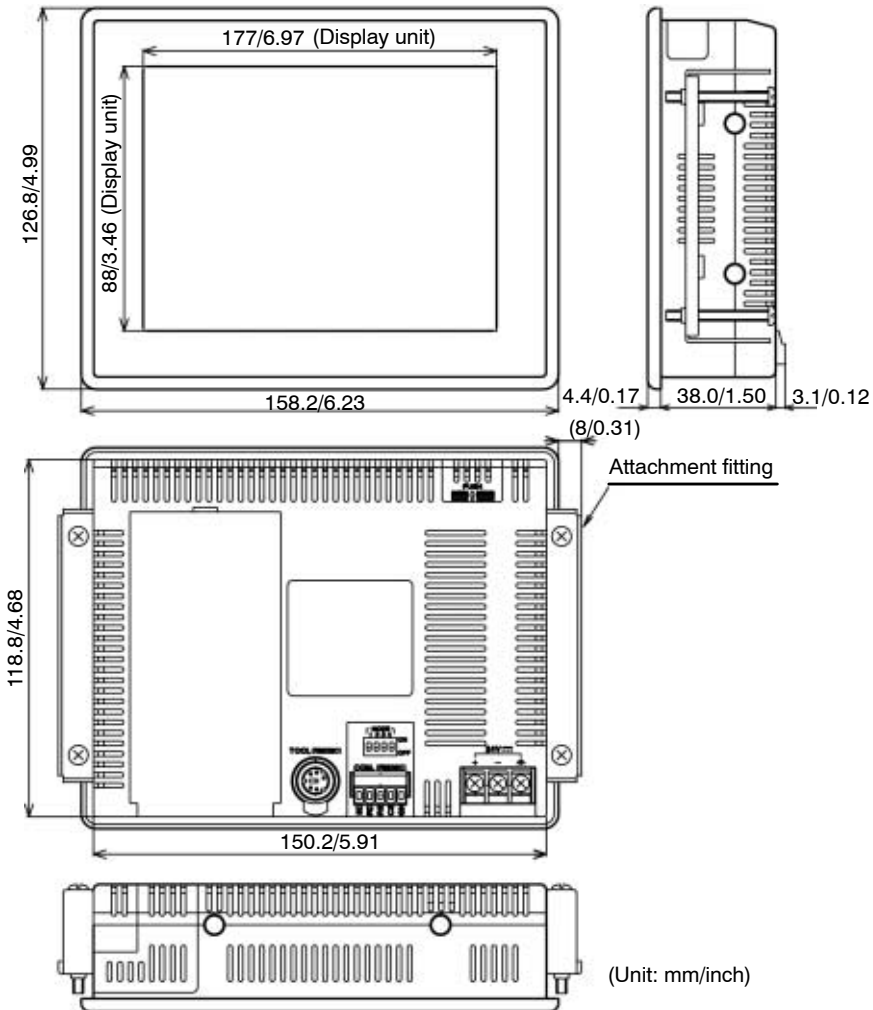

1.5.4 GT30 Panel Cutout Dimensions

The panel cutout dimensions of the GT30 are as shown below.

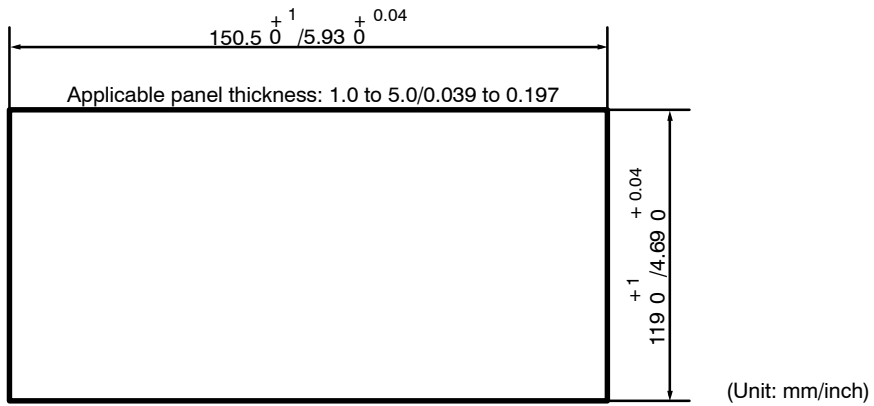

Chapter 2

Installation and Wiring

2.1 Installation

2.1.1 Installation Environment

When installing and using the GT series, always make sure the following conditions are observed.

Usage Conditions

When installing the product, make sure it is used within the range of the general specifications. Do not use in the following environments:

- Areas where the unit may come in contact with water (the unit is warranted by IP65 for the installed panel, but this applies to initial values and operation cannot be guaranteed in areas where the unit is constantly subjected to water or to extreme temperatures or humidity).
- Areas where the ambient temperature exceeds the range 0°C to 40°C/32°F to 104°F (0°C to 50°C/32°F to 122°F for the GT30).
- Areas where the ambient humidity exceeds 20% RH to 85% RH.
- If the control panel and other parts are installed in an environment where the air tends to be poorly ventilated, forced cooling should be used to keep the ambient temperature of the from going over 40°C/104°F (50°C/122°F for the GT30). This prevents the temperature of the GT display unit from rising.
- Locations where condensation may form because of sudden fluctuations in temperature.
- Locations where flammable or corrosive gases are present.
- Locations where there are high concentrations of dust or iron filings.
- Locations where substances such as organic solvents (thinner, benzene, etc.) or strong alkali substances (ammonia, caustic soda, etc.) might adhere to the product.
- Locations where the product is subject to extreme vibration and/or impact.
- Avoid installing the product near high-voltage lines, high-voltage devices, power lines, power devices, amateur radio sets and other transmitters, and devices that generate strong current surges.
- Avoid locations where the display unit is subject to direct sunlight.

Safety Precautions

- The switch functions of the programmable display unit should not be used to design systems which may pose a threat to human life or which may cause severe injury or damage. Designs should include safety mechanisms for use in the event that switch functions do not function correctly.

Power Supply Wiring

- For the power supply, use twisted wire (strand wire).
- There is sufficient noise resistance to offset power line noise, but we recommend reducing noise by measures such as installing an insulated transformer.

- Separate wiring systems should be used for the power supply unit and the operating unit.

Static Electricity/Noise

- Keep the GT10/GT30 main unit, PLC connecting cable, and other wiring as far away as possible from machines which are likely to produce noise (welding equipment, power lines, inverters, motors, etc.).
- For use in environments where the frequent occurrence of static electricity, radiation, or induced noise can be expected, the use of shielded cable on all wiring and grounding of shield (1–point ground) is recommended. When wiring the equipment, shielded wires should be electrically insulated to signal lines and signal grounds.
- If excessive static electricity is applied to the panel surface, the LCD display unit may be damaged.

Battery Service Life

- The service life of the internal battery will be radically shortened if used continually in ambient operating temperatures of more than 40°C/104°F (50°C/122°F for the GT30) or when the operating voltage exceeds 25V DC. Use caution when using the clock and device hold area functions.

Other Precautions

- Do not leave the GT10 connected to the TOOL port of the FP Programmer II.
- Always operate the touch panel with your fingers. Excessive load (about 98 N/cm²) or impact (operating with tools, etc.) will cause damage. Touch panel operation must be within the standard operating power range. Uniform pressure should be used to avoid abnormal wear of electrodes which may disable operation. Operate the unit only by touch.
- Never dismantle, re–assemble, or alter the unit. Performance cannot be warranted if this precaution is disregarded.

2.1.2 GT10 Installation Method

Secure the GT10 to the installation panel using the four fittings and four screws provided with the unit.

(1) Place the GT10 main unit in the installation panel.

(2) Insert the fittings into the grooves provided in the GT10 main unit, and tighten the screws to secure the GT10 main unit to the installation panel.

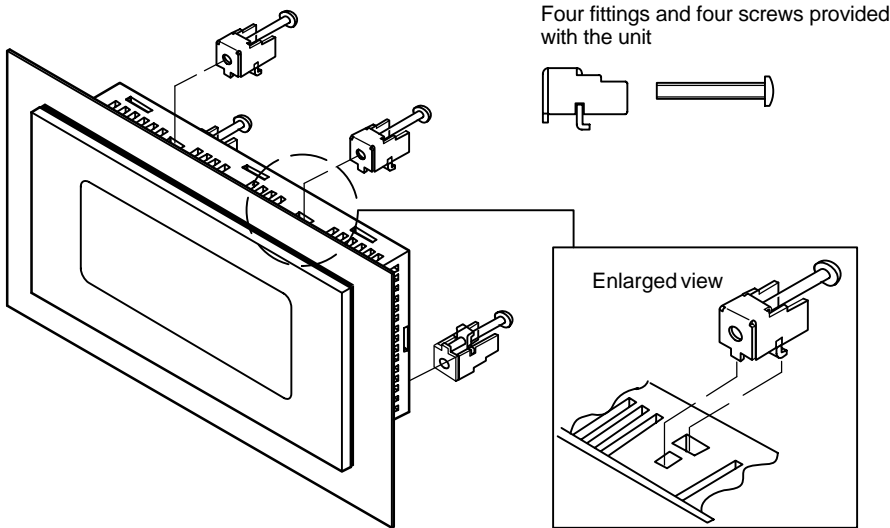

- **Screw tightening torque**
The screw tightening torque should be 0.1 N m to 0.25 N m.
- **Applicable panel thickness**
A panel with a thickness of 1.0 mm to 6.0 mm should be used.
- **Installation angle**
If the installation angle is between 60 degrees and 0 degrees (horizontal), the operating voltage should be set to 25V DC or lower.

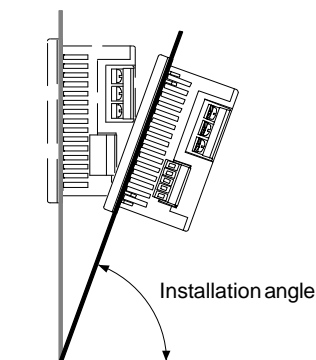

- **Clearance when the GT10 is installed**
When installing the GT10, if other parts are being installed to the panel or cables are being wired to it, we recommend providing a clearance of 30 mm to 50 mm/1.18 inch to 1.97 inch around the GT10. This prevents cables from being damaged, and facilitates the installation work. Also, make sure that the slits in the main unit are never obstructed.

2.1.3 GT30 Installation Method

Secure the GT30 to the installation panel using the two fittings and four screws provided with the unit.

(1) Place the GT30 main unit in the installation panel.

(2) Insert the fittings into the grooves provided in the GT30 main unit, and tighten the screws to secure the GT30 main unit to the installation panel.

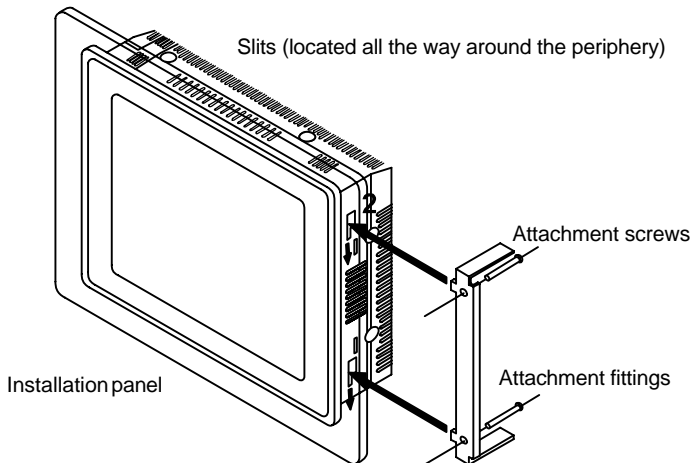

CAUTION

- Screw tightening torque**
 The screw tightening torque should be 0.1 N m to 0.25 N m. Tightening the screws too hard can cause deformation of the front panel, so that the switch will not function properly. Make sure screws are tightened to the appropriate degree.
- Applicable panel thickness**
 A panel with a thickness of 1.0 mm to 5.0 mm should be used.
- Installation angle and ambient temperature range for usage**
 If the unit is being installed in a horizontal orientation and the Matsushita Programmer II and C-NET adaptor are being connected to the Tool port, please be aware that the ambient usage temperature should not exceed 40°C/104°F.

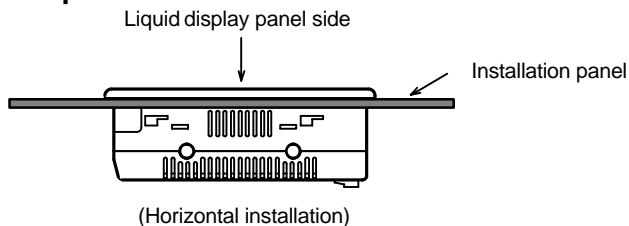

- Clearance when the GT30 is installed**
 When installing the GT30, if other parts are being installed to the panel or cables are being wired to it, we recommend providing a

clearance of 30 mm to 50 mm/1.18 inch to 1.97 inch around the GT30. This prevents cables from being damaged, and facilitates the installation work. Also, make sure that the slits in the main unit are never obstructed.

2.2 Wiring the Power Supply

The power supply should be wired by securely connecting the terminal on the rear of the main unit to the terminal. Always use crimp terminals for wiring.

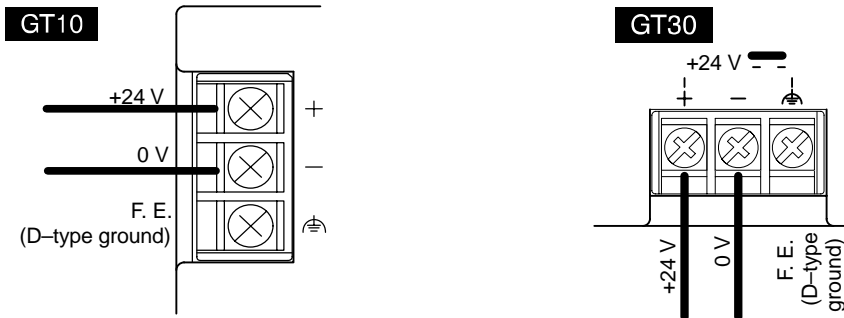

Use twisted wiring for the power supply

In order to minimize influence from noise, the wiring for the power supply should be twisted.

Insulate the power supply inside a protective circuit

- In order to protect the unit against abnormal voltage from the power supply line, the power supply should be an insulated type, and should be enclosed within a protective circuit.
- A non-insulated regulator is used with the GT series.
- If a power supply device without an internal protective circuit is being used, power should always be supplied to the GT series through a fuse or a similar protective device.

Keep the power supply voltage within the operating voltage range

Operating voltage range	21.6 to 26.4V DC
-------------------------	------------------

Use M3 crimp terminals

– The terminal screws are M3 screws. We recommend using crimp terminals for wiring to terminals.

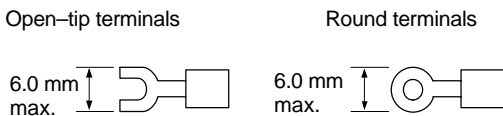

The tightening torque for terminal base screws should be between 0.5 and 0.6 N·m, or less. Operating at a higher force could cause damage.

Maker	Shape	Model	Applicable wiring	Tightening torque
JST Mfg. Co., Ltd.	Round	1.25-MS3	0.25 mm ² to 1.65 mm ²	0.5 N·m
	Front-opening	1.25-B3A		
	Round	2-MS3	1.04 mm ² to 2.63 mm ²	
	Front-opening	2-N3A		



If crimp terminals are not being used, wire with a diameter of 0.5 mm² to 1.25 mm² should be used for power cables.



For precautions concerning conformance to European EMC directives, please see "Power Supply Terminals" on page 10.

Keep the power supply wiring separate

– Wiring to the GT series, PLC, and other power equipment should have separate wiring systems.

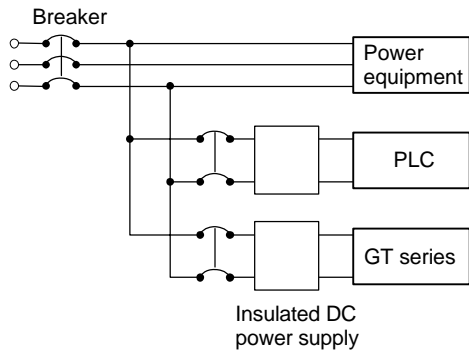

2.3 Wiring the COM. Port

Accessory communication connector/applicable wiring

The communication connector used for the COM. port (provided as an accessory with the main unit) has a screw-tightening type of terminal base. The wiring shown below should be used.

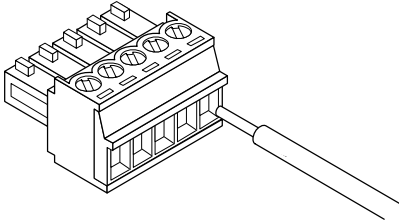

Accessory communication connector

The communication connector is made by Fenics Contact Co., Ltd.

No. of pins	Fenics Model No.	
	Model No.	Product No.
5-pin	MC1, 5/5-ST-3,5	1840396

Applicable wiring (twisted wiring)

Size	Conductor Cross-Section Surface Area
AGW#28 to 16	0.08 mm ² to 1.25 mm ²

Applicable stick-type terminals with insulated sleeves

If stick-type terminals are used, the models listed below are marketed by Fenics Contact Co., Ltd.

Maker	Cross-Section Surface	Size	Fenics Co. Model
Fenics Contact Co., Ltd.	0.25 mm ²	AGW#24	AI 0,25 to 6 YE
	0.50 mm ²	AGW#20	AI 0,50 to 6 WH
	0.75 mm ²	AGW#18	AI 0,75 to 6 GY
	1.00 mm ²	AGW#18	AI 1 to 6 RD

Crimp tools for stick-type terminals

Maker	Fenics Model No.	
	Model No.	Product No.
Fenics Contact Co., Ltd.	CRIMPFOX UD6	1204436

Use a special tool to tighten the terminal base of the communication connector

Tightening of terminals should be done using a screwdriver made by Fenics Contact Co., Ltd. (Fenics mfg. no. 1205037, blade width 0.4 x 2.5, model no. SZS 0.4 x 2.5), or a screwdriver made by Matsushita Electric Works Co., Ltd. (Product number AFP0806). The tightening torque should be 0.22 N·m to 0.25 N·m or less.

2.3.1 Wiring Method

(1) Remove the sheath from the wire.

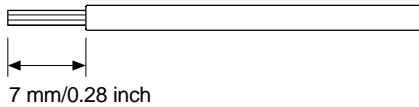

(2) Insert the wire all the way into the terminal base, and tighten the screw in the clockwise direction to secure it.

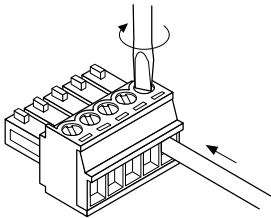

2.3.2 Precautions Concerning Wiring

The following precautions should be observed, to avoid broken or disconnected wires.

- When removing the sheath, be careful not to scratch the core wire.
- Wire the terminal without twisting the core wire.
- The core wire should be connected without soldering it. Vibration can sometimes cause soldered connections to break loose.
- After connecting the wiring, avoid subjecting the cable to stress.
- Because of the construction of the terminal, tightening the wire in the counterclockwise direction will cause a faulty connection. If this happens, disconnect the wire, check the terminal hole, and connect the wire again.

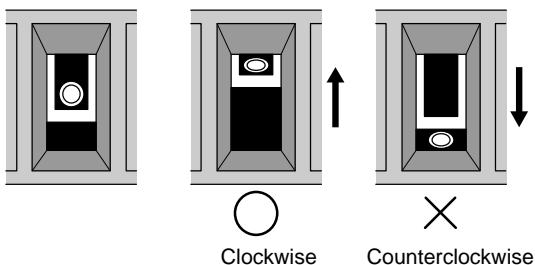

◆ REFERENCE

For information on connecting the COM. port of the GT series with various PLC units, please see Chapter 4, “Connecting and Communicating with the PLC”, on page 41.

Chapter 3

Setup

3.1 Setup Procedure for the GT10

The GT10 should be set up using the procedure outlined below.

(1) Setting the “Configuration File” with GTWIN

The GT10 has an internal file called the “Configuration file”, which is used to determine various operating environment parameters. When the GT10 is shipped from the factory, the settings listed below are set for the parameters in the configuration settings file. If changes are made to these settings, they are made from GTWIN screen creation tool. (For detailed information on changing settings, see page 73 and subsequent pages.) If the GT10 is being used without changing the factory settings, the following setup procedure is not necessary.

Contents of configuration settings for GT10 when shipped from the factory

Classification	Item	Setting contents
Basic Setup	Area for basic communication with PLC	Mode : GT10 mode Word area: DT0 to DT2 Bit area : WR0 to WR2
Communication parameter settings	COM. port	Communication speed: 19200 bits/s, data length: 8 bits, stop bit: 1 bit, parity: odd <Communication error temporary processing> Retries: 3, error code displayed (not held)
	TOOL port	Communication speed: 19200 bits/s, data length: 8 bits, stop bit: 1 bit, parity: odd <Through function local setting> None
Auto paging	Automatic paging	No
Startup screen settings	Startup screen	No. 00
	Rise delay time	0 seconds
Other settings	Clock	GT main unit clock / external transmission: No
	Backlight control	Not turned off automatically
	Touch operation sounds	Valid
Hold PLC Device	Holds a PLC device	Not held
GT internal device hold	GT internal device hold	Not held

Always confirm “Basic communication area to PLC” under “Basic Setup”

This is an internal device area that comes already provided in the GT10 for the purpose of communicating with a PLC. If the factory settings are to be changed, the setup procedure must be carried out. For detailed information, please see page 29.

(2) Connect the GT10 and the personal computer.

After the settings have been entered with GTWIN, connect the computer and the GT10, using the screen transfer cable.

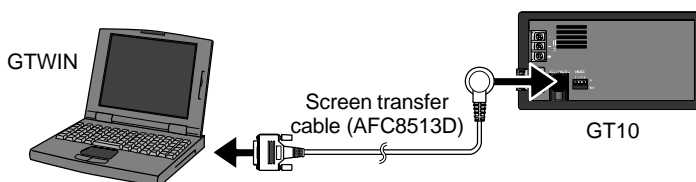

(3) Transfer the GT10 Configuration file from GTWIN.

After connections have been completed, use the following procedure to transfer the GT10 Configuration file from GTWIN.

Boot GTWIN, and select “Transfer” on the “File” menu.



When the transfer function is selected, a dialog box for file transfer is displayed. At this point, specify the type of data to be transferred, and the direction of transfer.

Transfer data: “GT10 Configuration”

Transfer direction: “GTWIN → GT main unit”

Enter the above conditions and click on the “OK” button. The system files are transferred to the GT10.

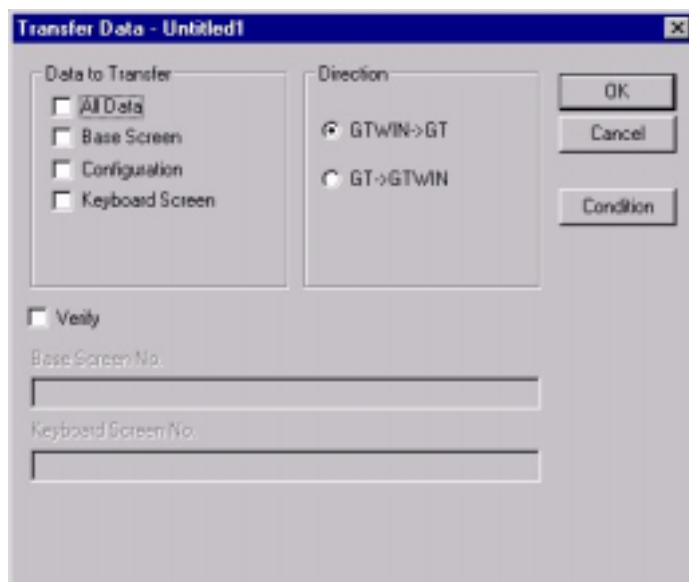

When the menu operation as shown at the left page is carried out, the configuration file is sent to the GT10. During the transfer, a screen like that shown below is displayed.

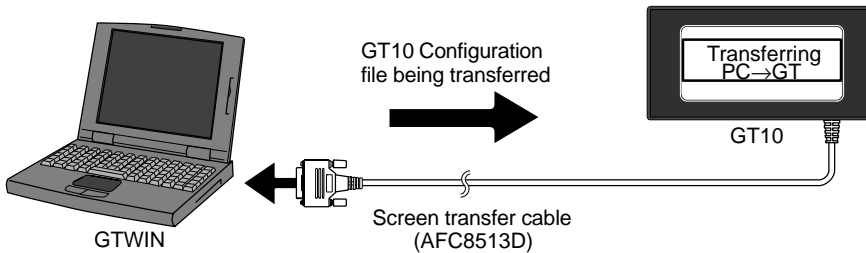

(4) Setup is completed.

If the transfer has been completed without any problems, the setup is completed.



Backup of the GT10 Configuration file

The GT10 Configuration file is stored in the user memory (F-ROM) of the GT10. This file is deleted if the memory is initialized using the command on the system menu of the GT10 main unit (see page 89), and will have to be transferred again.

3.2 Setting the Basic Communication Area, GT10 and PLC

3.2.1 What is the Basic Communication Area?

Communication between the GT10 and PLC is carried out as shown below.

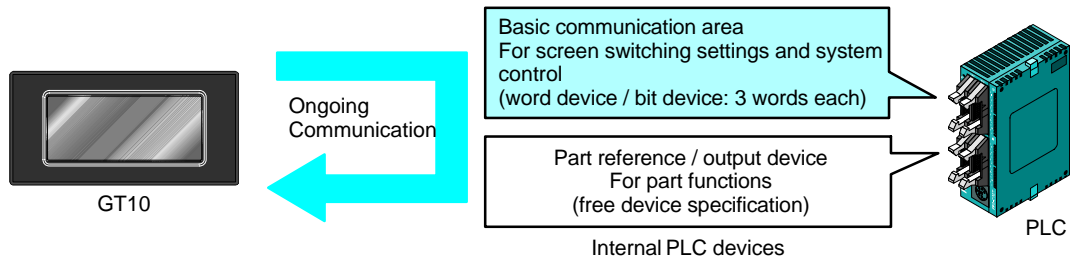

As shown in the illustration, communication is carried out on an ongoing basis between the GT10 and internal devices in the PLC. Internal PLC devices are divided into the following two devices:

Basic communication area

This area is for system control, such as screen switching settings. PLC devices belong to this area on a fixed basis, and communication is constantly being carried out.

Breakdown of the basic communication area

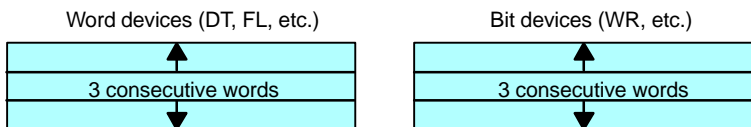

- Word devices — For reading devices handled in word units (3 consecutive words)
- Bit devices — For reading devices handled in bit units (3 consecutive words)

References and output devices for parts

These are devices that are used in parts functions, and can be freely specified by the user. Communication is carried out on an ongoing basis only for those that are currently displayed on the screen and pertain to devices currently in use.

With the GT10, before GTWIN screen creation tool is used to specify the devices for parts functions, the “basic communication area” must be determined.

DT0 to DT2 and WR0 to WR2 are set as the default values for the basic communication area, but the initial address can be changed using the following procedure.



CAUTION

The basic communication area should be used in the PLC ladder program to control the GT main unit.

Settings in GTWIN

Select “Configuration” under “File” on the menu bar, and then select the sub-menu called “GT Configuration”. This displays the dialog box for the GT10 Basic Setup, as

shown below.

Clicking on the  button in “Basic Communication Area to PLC” displays the device settings dialog box shown below, where the initial addresses for the word area and bit area can be changed.

GT10 Configuration Basic Setup dialog box

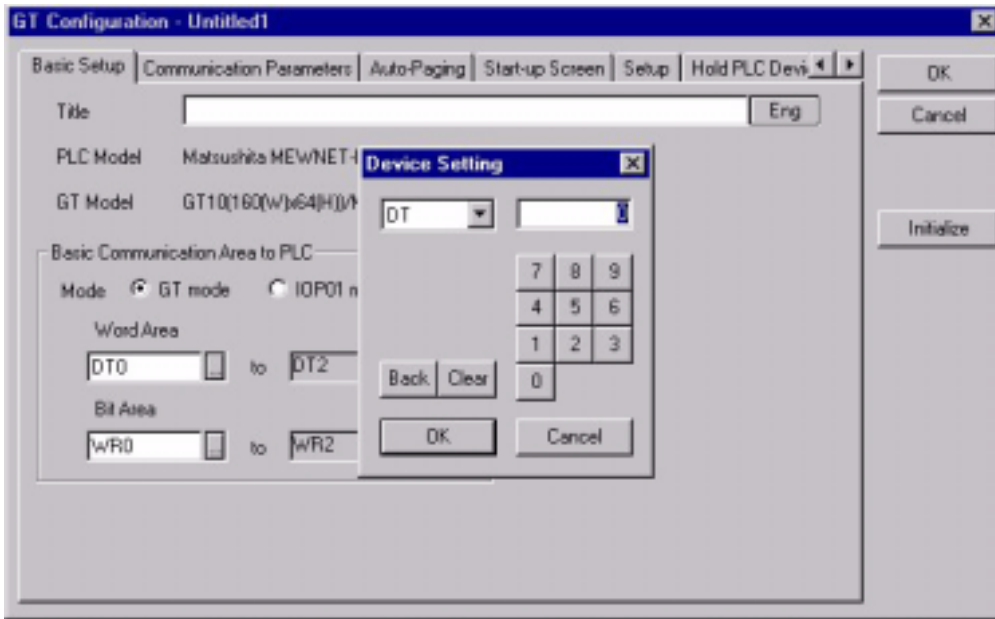

◆ EXPLANATION

Key operation in the Device Settings dialog box

Click on the  button to display a pull-down menu, and then select the device for which settings are to be entered. Use the ten-keys to enter the address.

The  button acts as a backspace key when entering an address, and the  button functions as a Clear key.

3.2.2 GT10 Basic Communication Area Map

In order for communication to be carried out between the GT10 and PLC, an internal device area like that shown below is provided in the PLC. This should be used to control the GT main unit through the PLC ladder program actually being run.

The starting address “N” of the field shown below is specified in the GT10 configuration settings of GTWIN screen creation tool, and is then sent to the GT main unit.

Word devices

Word position	F	E	D	C	B	A	9	8	7	6	5	4	3	2	1	0
N+0	Screen no. specified by PLC (area read by GT10 from PLC)															
N+1	Usage prohibited															
N+2	No. of currently displayed screen (area in which data is written from GT10 to PLC)															

Explanation of system area

Screen no. specified by PLC — The screen number displayed on the GT10 is specified from the PLC in hexadecimal format.

No. of currently displayed screen — The number of the screen currently displayed on the GT10 is written to the PLC in hexadecimal format.

Bit devices

Word position	F	E	D	C	B	A	9	8	7	6	5	4	3	2	1	0
N+0	BZ	Forced–display flag	Backlight Valid flag	Backlight Flashing	Backlight Color											
N+1	Usage prohibited															
N+2															BAT	Data Input In Progress flag

Explanation of system areas

BZ — This turns on the buzzer.

Forced–Display flag — At the rise when the bit is turned on, the screen specified by the PLC is forcibly displayed. (This is executed only when at the rise of the bit.)

Backlight Valid flag — When the bit is turned on, the backlight flashing/backlight color control becomes effective.

Backlight Flashing — 0: Lighted (normal), 1: Flashing

Backlight Color — 00: Off, 01: Green, 10: Red, 11: Orange

BAT — This goes on if clock data and Hold PLC Device data held in the SRAM are not being backed up normally. (This bit also goes on if the SRAM is not backed up by the internal secondary battery.)

Data Input In Progress flag — This is 1 while data is being input, and 0 when data input has been completed.



◆ EXPLANATION

- “IOP01” mode

The GT10 is equipped with an IOP01 mode for users with conventional models (I.O.P. B01C / M01L / D01TL series). Using this function enables compatibility with earlier models, so that communication is possible between the GT10 and PLC, except for one part of the basic communication area.

- Entering settings for the IOP01 mode

Click on the “File” menu in GTWIN, and then select “Configuration” from the displayed menu. Next, select “GT Configuration” from the

sub-menu. Turn on the radio button for “IOP01 Mode” in the displayed dialog box.

 For information on the displayed dialog box, please see “Basic Setup” under “GT10 Configuration Settings” on page 73.

- **Map of the basic communication area for conventional models (conventional name: system area)**
If the IOP01 mode is set, the basic communication area map for the GT10 is as follows.

Reference data area

Address	Bit configuration																		
	F	E	D	C	B	A	9	8	7	6	5	4	3	2	1	0			
n	BZ	PC							Screen no.										
n+1																			
n+2	Tag bit field * Note 1 (Used to turn tag display on/off, display status screen segments, and display settings)																		
n+3																			
•	Tag field * Note 1 (Used to switch tags, specify movements, and reference and set data)																		
•																			
•																			
•																			

System field (fixed at 2 words)
 Field for user use (fixed at 126 words maximum)

Output destination relay

Address	Bit configuration															
	F	E	D	C	B	A	9	8	7	6	5	4	3	2	1	0
n	System switch output destination				Function switch output destination				Displayed screen data (no. of screen currently displayed)							
n	Not supported * Note 2				Not supported * Note 2											
n+1					BAT	SET										
n+2	Output destination relay * Note 1 (Used for switch output destinations of tags, segments, and manual switches)															
n+3																
•																
•																

System field (fixed at 2 words)
 Field for user use (fixed at 30 words maximum)



◆ **NOTES**

- 1) The tag bit field and tag field under “Reference data area”, and the output destination relay field under “Output relay” can be switched just as they are, as device setting destinations for GT10 parts functions.
- 2) System switch output destinations and function switch output destinations provided in conventional models as the initial addresses under “Output relay” are not supported with the GT10.

System switches should be replaced with keyboard parts, and function switches with switch parts.

3.3 Setup Procedure for the GT30

The GT30 should be set up using the procedure outlined below.

(1) Setting the “Configuration File” with GTWIN

The GT30 has an internal file called the “Configuration file”, which is used to determine various operating environment parameters. When the GT30 is shipped from the factory, the settings listed below are set for the parameters in the configuration settings file. If changes are made to these settings, they are made from GTWIN screen creation tool. (For detailed information on changing settings, see page 109 and subsequent pages.) If the GT30 is being used without changing the factory settings, the following setup procedure is not necessary.

Contents of configuration settings for GT30 when shipped from the factory

Classification	Item	Setting contents
Basic Setup	Area for basic communication with PLC	Word area: DT0 to DT2 Bit area : WR0 to WR2
Communication parameter settings	COM. port	Communication speed: 19200 bits/s, data length: 8 bits, stop bit: 1 bit, parity: odd <Communication error temporary processing> Retries: 3, error code displayed (not held)
	TOOL port	Communication speed: 19200 bits/s, data length: 8 bits, stop bit: 1 bit, parity: odd <Through function local setting> None
Auto paging	Automatic paging	No
Startup screen settings	Startup screen	No. 00
	Rise delay time	0 seconds
Other settings	Clock	GT main unit clock / external transmission: No
	Backlight control	Not turned off automatically
	Touch operation sounds	Valid
Hold PLC Device	Holds a PLC device	Not held
GT internal device hold	GT internal device hold	Not held

Always confirm “Basic communication area to PLC” under “Basic Setup”

This is an internal device area that comes already provided in the GT30 for the purpose of communicating with a PLC. If the factory settings are to be changed, the setup procedure must be carried out. For detailed information, please see page 37.

(2) Connect the GT30 and the personal computer.

After the settings have been entered with GTWIN, connect the computer and the GT30, using the screen transfer cable.

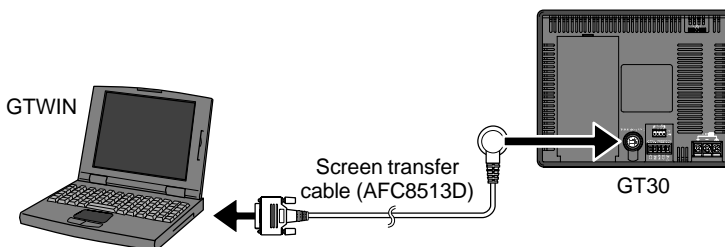

(3) Transfer the GT30 Configuration file from GTWIN.

After connections have been completed, use the following procedure to transfer the GT30 Configuration file from GTWIN.

Boot GTWIN, and select “Transfer” on the “File” menu.



When the transfer function is selected, a dialog box for file transfer is displayed. At this point, specify the type of data to be transferred, and the direction of transfer.

Transfer data: “GT30 Configuration”

Transfer direction: “GTWIN → GT main unit”

Enter the above conditions and click on the “OK” button. The system files are transferred to the GT30.

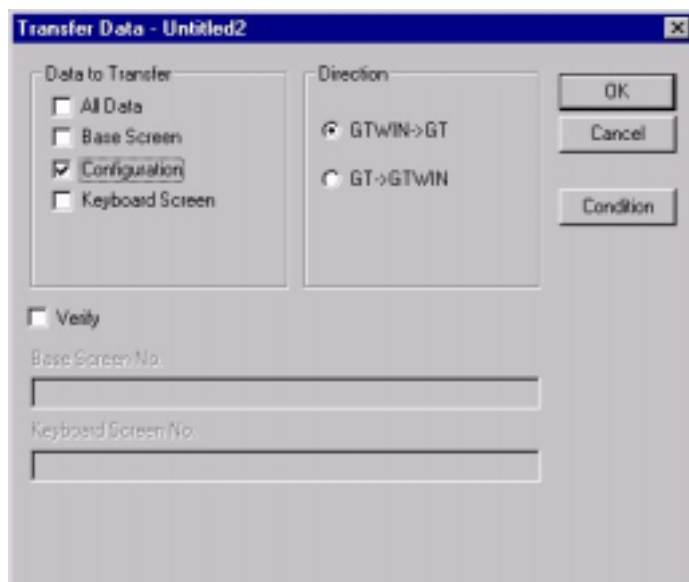

When the menu operation as shown at the left page is carried out, the configuration file is sent to the GT30. During the transfer, a screen like that shown below is displayed.

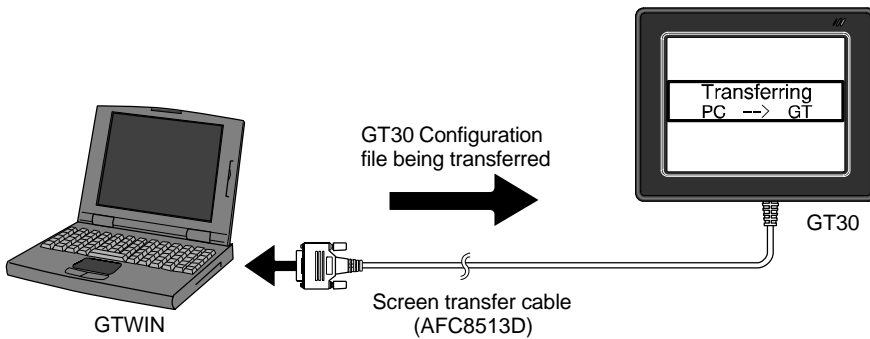

(4) Setup is completed.

If the transfer has been completed without any problems, the setup is completed.



Backup of the GT30 Configuration file

The GT30 Configuration file is stored in the user memory (F-ROM) of the GT30. This file is deleted if the memory is initialized using the command on the system menu of the GT30 main unit (see page 130), and will have to be transferred again.

3.4 Setting the Basic Communication Area, GT30 and PLC

3.4.1 What is the Basic Communication Area?

Communication between the GT30 and PLC is carried out as shown below.

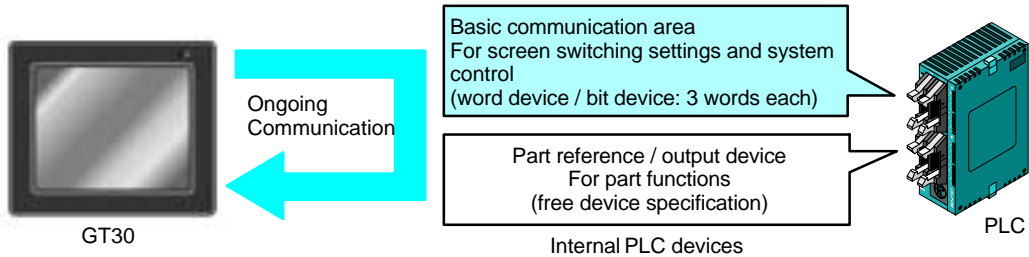

As shown in the illustration, communication is carried out on an ongoing basis between the GT30 and internal devices in the PLC. Internal PLC devices are divided into the following two devices:

Basic communication area

This area is for system control, such as screen switching settings. PLC devices belong to this area on a fixed basis, and communication is constantly being carried out.

Breakdown of the basic communication area

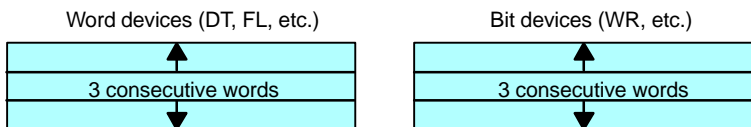

- Word devices — For reading devices handled in word units (3 consecutive words)
- Bit devices — For reading devices handled in bit units (3 consecutive words)

References and output devices for parts

These are devices that are used in parts functions, and can be freely specified by the user. Communication is carried out on an ongoing basis only for those that are currently displayed on the screen and pertain to devices currently in use.

With the GT30, before GTWIN screen creation tool is used to specify the devices for parts functions, the “basic communication area” must be determined.

DT0 to DT2 and WR0 to WR2 are set as the default values for the basic communication area, but the initial address can be changed using the following procedure.



CAUTION

The basic communication area should be used in the PLC ladder program to control the GT main unit.

Settings in GTWIN

Select “Configuration” under “File” on the menu bar, and then select the sub-menu called “GT Configuration”. This displays the dialog box for the GT30 Basic Setup, as

shown below.

Clicking on the  button in “Basic Communication Area to PLC” displays the device settings dialog box shown below, where the initial addresses for the word area and bit area can be changed.

GT30 Configuration Basic Setup dialog box

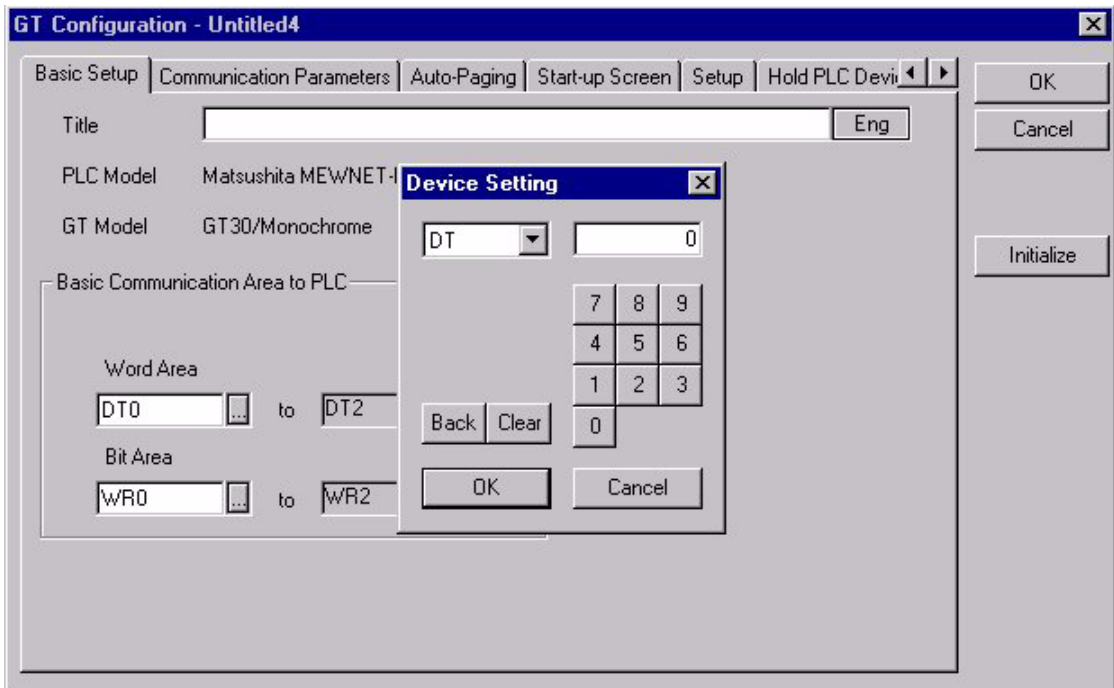

◆ EXPLANATION

Key operation in the Device Settings dialog box

Click on the  button to display a pull-down menu, and then select the device for which settings are to be entered. Use the ten-keys to enter the address.

The  button acts as a backspace key when entering an address, and the  button functions as a Clear key.

3.4.2 GT30 Basic Communication Area Map

In order for communication to be carried out between the GT30 and PLC, an internal device area like that shown below is provided in the PLC. This should be used to control the GT main unit through the PLC ladder program actually being run.

The starting address “N” of the field shown below is specified in the GT30 configuration settings of GTWIN screen creation tool, and is then sent to the GT main unit.

Word devices

Word position	F	E	D	C	B	A	9	8	7	6	5	4	3	2	1	0
N+0	Screen no. specified by PLC (area read by GT30 from PLC)															
N+1	Usage prohibited															
N+2	No. of currently displayed screen (area in which data is written from GT30 to PLC)															

Explanation of system area

Screen no. specified by PLC — The screen number displayed on the GT30 is specified from the PLC in hexadecimal format.

No. of currently displayed screen — The number of the screen currently displayed on the GT30 is written to the PLC in hexadecimal format.

Bit devices

Word position	F	E	D	C	B	A	9	8	7	6	5	4	3	2	1	0
N+0	BZ	Forced–display flag	Backlight Valid flag	Backlight Flashing	Backlight Color											
N+1	Usage prohibited															
N+2														BAT LOW flag	BAT	Data Input In Progress flag

Explanation of system areas

BZ — This turns on the buzzer.

Forced–Display flag — At the rise when the bit is turned on, the screen specified by the PLC is forcibly displayed. (This is executed only when at the rise of the bit.)

Backlight Valid flag — When the bit is turned on, the backlight flashing/backlight color control becomes effective.

Backlight Flashing — 0: Lighted (normal), 1: Flashing

Backlight Color — 00: Off, 01: Lighted, 10: Lighted, 11: Lighted

BAT — This goes on if clock data and Hold PLC Device data held in the SRAM are not being backed up normally. (This bit also goes on if the SRAM is not backed up by the battery.)

Data Input In Progress flag — This is 1 while data is being input, and 0 when data input has been completed.

BAT LOW flag — This bit goes on if the battery capacity drops too low. The battery should be replaced within one week after this bit goes on.

Chapter 4

Connecting and Communicating with the PLC

4.1 Connecting the FP-Sigma

4.1.1 Connecting to the COM. Port

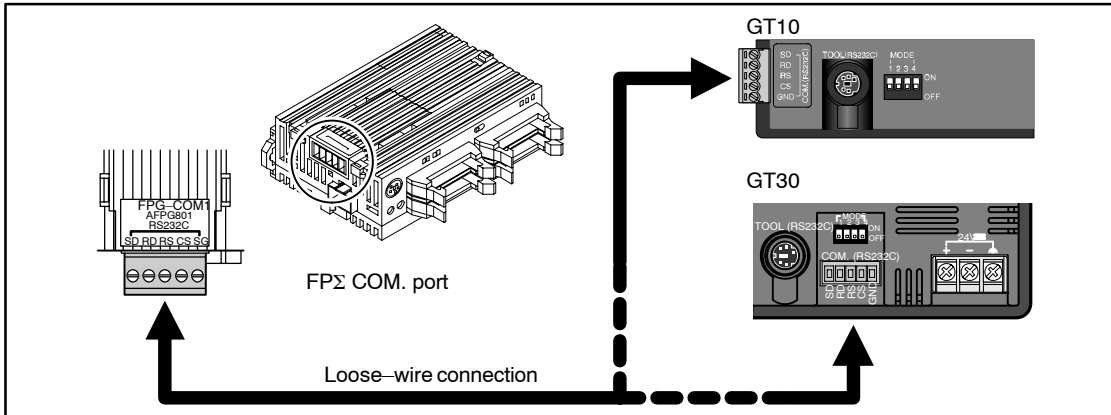

FPΣ communication format settings

When using COM. Port 1

System register no.	Item	Value Set
410	COM. Port 1 Unit number	1
412	COM. Port 1 Communication mode	Computer link No modem connection
413	Data length	8 bits
	Parity check	Yes, Odd
	Stop bits	1 bit
	Line return code	CR
	Start code	No STX
415	COM. Port 1 Communication speed setting	19200 bits/s

When using COM. Port 2

System register no.	Item	Value Set
411	COM. Port 2 Unit number	1
412	COM. Port 2 Communication mode	Computer link No modem connection
414	Data length	8 bits
	Parity check	Yes, Odd
	Stop bits	1 bit
	Line return code	CR
	Start code	No STX
415	COM. Port 2 Communication speed setting	19200 bits/s

Connecting to the FPΣ COM. port

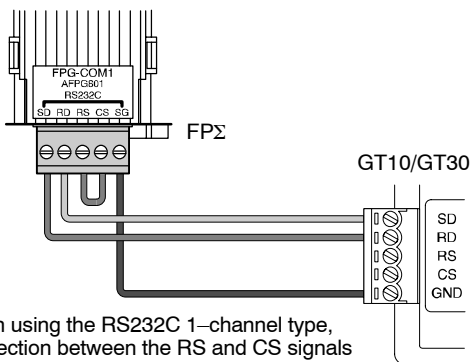

When using the RS232C 1-channel type, the section between the RS and CS signals on the PLC side should be shorted.

When using the RS232C 1-channel type
PLC side

Pin no.	Abbreviation
SD	SD
RD	RD
RS	RS
CS	CS
GND	GND

GT main unit side

Pin no.	Abbreviation
SD	SD
RD	RD
RS	RS
CS	CS
GND	GND

When using the RS232C 2-channel type
PLC side

Pin no.	Abbreviation
S1	SD
R1	RD
S2	RS
R2	CS
GND	GND

GT main unit side

Pin no.	Abbreviation
SD	SD
RD	RD
RS	RS
CS	CS
GND	GND



Because loose wiring is used for connection to the FPΣ COM. port, no dedicated cable is available. The cable should be provided by the customer. When purchasing a cable, the following precautions should be observed:

- Shielded wire with a size of AGW#28 to 16 (conductor cross-section surface area: 0.08 mm² to 1.25 mm²) should be used for connections.
- For wiring procedures, please refer to “Wiring the COM. Port” on page 23.

4.1.2 Connecting to the TOOL Port

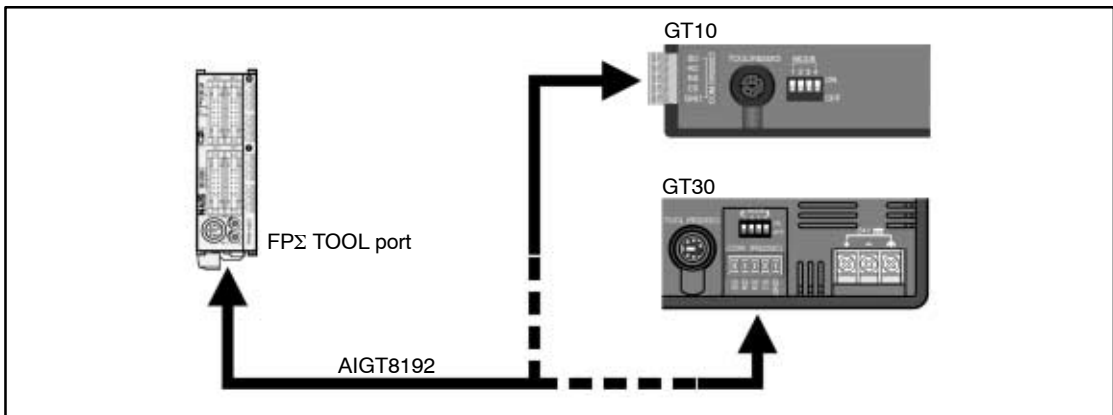

FPΣ communication format settings

System register no.	Item	Value Set
410	TOOL Port Unit number	1
412	Modem connection	No modem connection
413	Data length	8 bits
	Parity check	Yes, Odd
	Stop bits	1 bit
	Line return code	CR (Fixed)
	Start code	no STX (Fixed)
415	COM. Port 1 Communication speed setting	19200 bits/s

PLC communication cable: Mini-DIN 5-pin loose-wire cable (AIGT8192)

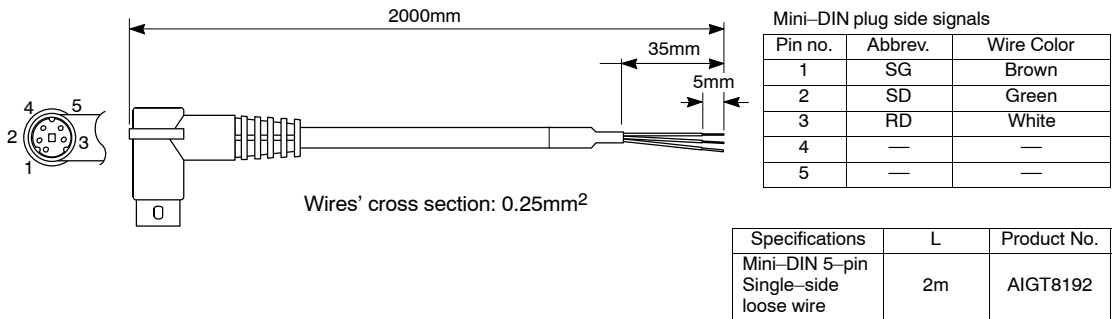

Connecting to the FPΣ TOOL port

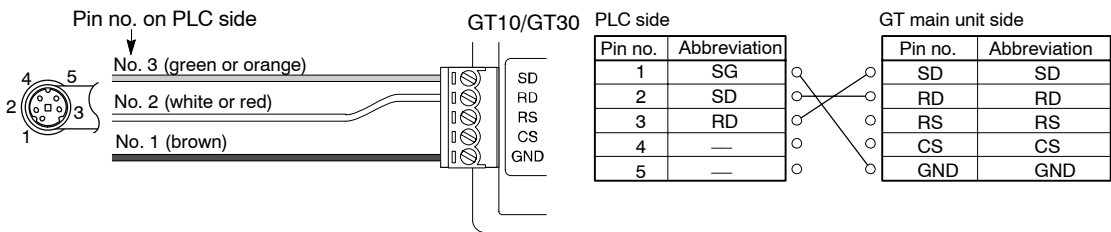

4.2 Connecting the FP0

4.2.1 Connecting to the COM. Port

FP0 communication format settings

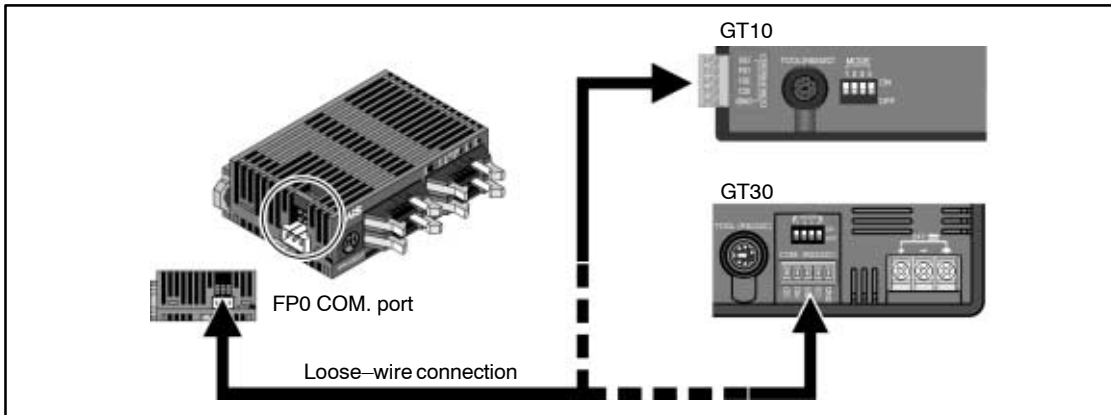

System register no.	Item	Value Set	System register value
412	Selection of target use of RS232C port	Computer link	K1
413	Data length	8 bits	K3
	Parity check	Yes	
	Parity setting	Odd	
	Stop bits	1 bit	
	Line return code	CR	
	Start code	No STX	
414	Baud rate setting	19200 bits/s	H0 * 00
415	Unit number	1	K1
416	Modem connection	No connection	H0

← To set 19200 bits/s for both the COM. port and the TOOL port, "H0100" should be set.

Connecting to the FP0 COM. port

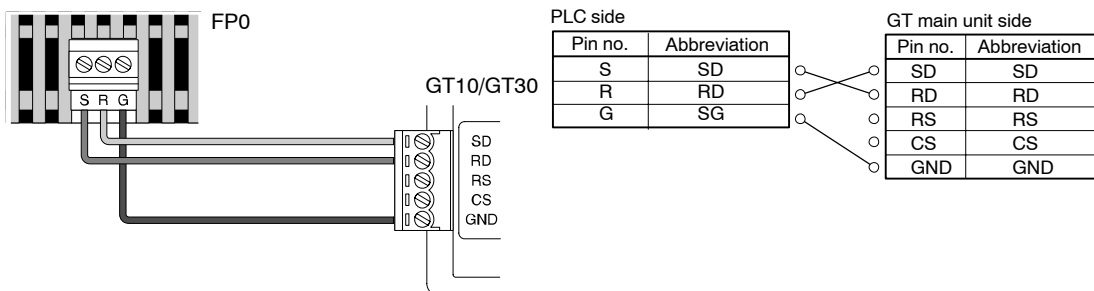

Because loose wiring is used for connection to the FP0 COM. port, no dedicated cable is available. The cable should be provided by the

customer. When purchasing a cable, the following precautions should be observed:

- **Shielded wire with a size of AGW#28 to 16 (conductor cross-section surface area: 0.08 mm² to 1.25 mm²) should be used for connections.**
- **For wiring procedures, please refer to “Wiring the COM. Port” on page 23.**

4.2.2 Connecting to the TOOL Port

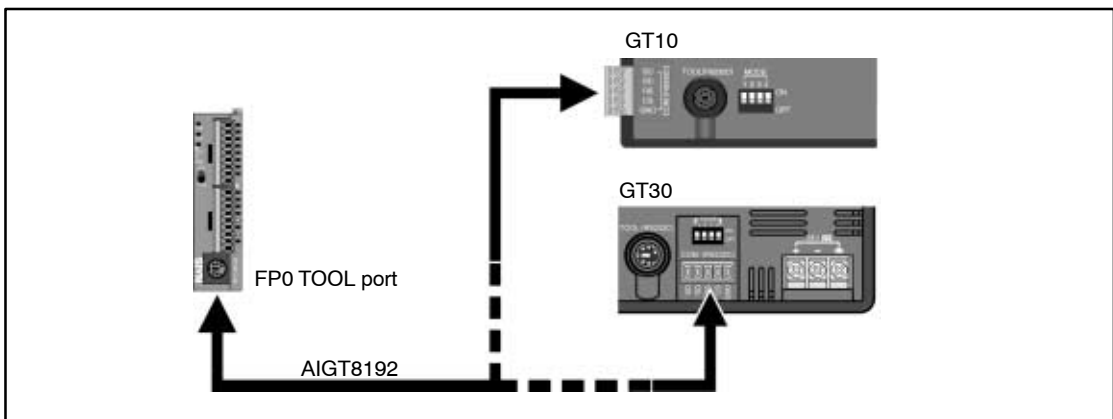

FP0 communication format settings

System register no.	Item	Value Set	System register value
410	Unit number	1	K1
411	Data length	8 bits	H0
	Modem connection	No connection	
414	Baud rate setting	19200 bits/s	H010X X is 0 to 6

←To set 19200 bits/s for both the COM. port and the TOOL port, “H0100” should be set.

PLC communication cable: Mini-DIN 5-pin loose-wire cable (AIGT8192)

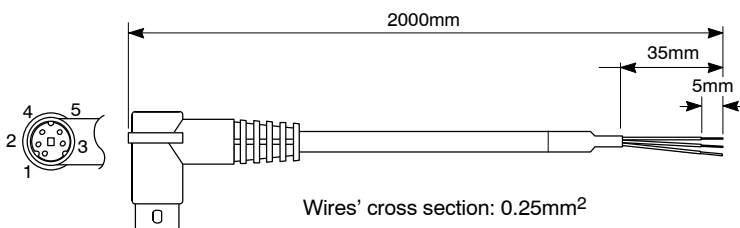

Mini-DIN plug side signals

Pin no.	Abbrev.	Wire Color
1	SG	Brown
2	SD	White or red
3	RD	Green or orange
4	—	—
5	—	—

Specifications	L	Product No.
Mini-DIN 5-pin Single-side loose wire	2m	AIGT8192

Connecting to the FP0 TOOL port

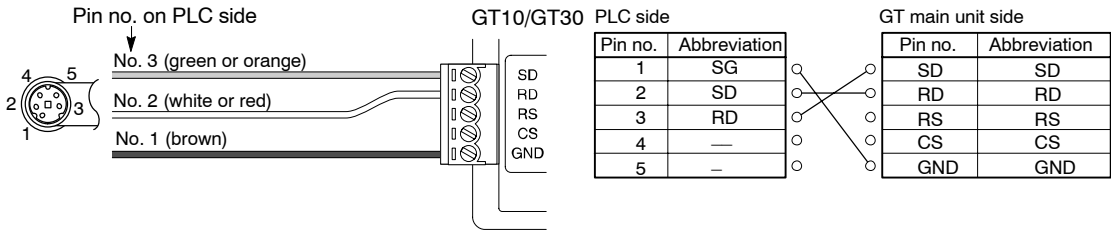

4.3 Connecting the FP1

4.3.1 Connecting to the COM. Port

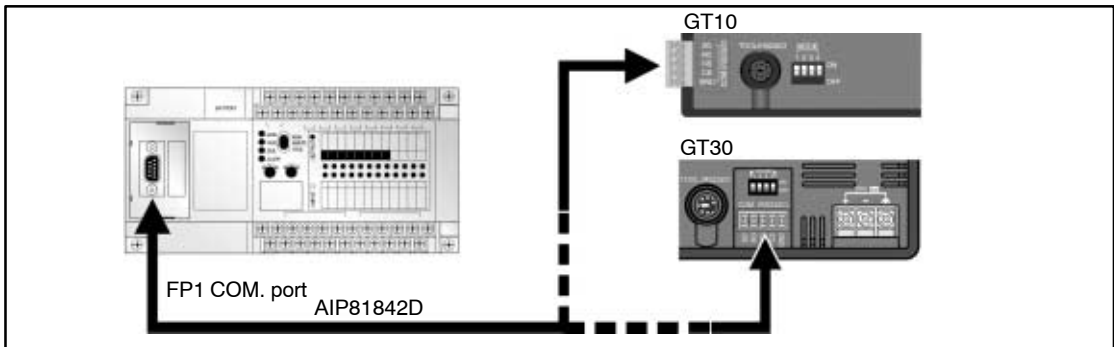

FP1 communication format settings

System register no.	Item	Value Set	System register value
412	Selection of target use of RS232C port	Computer link	K1
413	Data length	8 bits	K3
	Parity check	Yes	
	Parity setting	Odd	
	Stop bits	1 bit	
	Line return code	CR	
	Start code	No STX	
414	Baud rate setting	19200 bits/s	K0
415	Unit number	1	K1
416	Modem connection	No connection	H0

PLC communication cable: D-sub 9-pin loose-wire cable (AIP81842D)

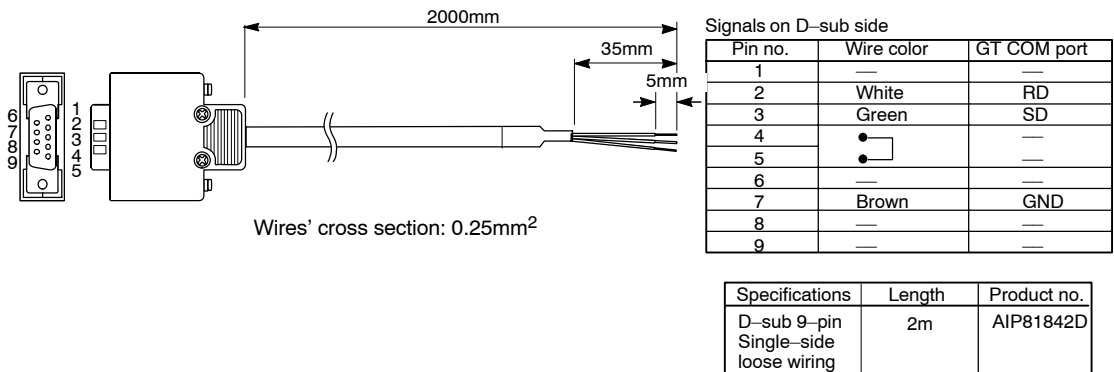

Connecting to the FP1 COM. port

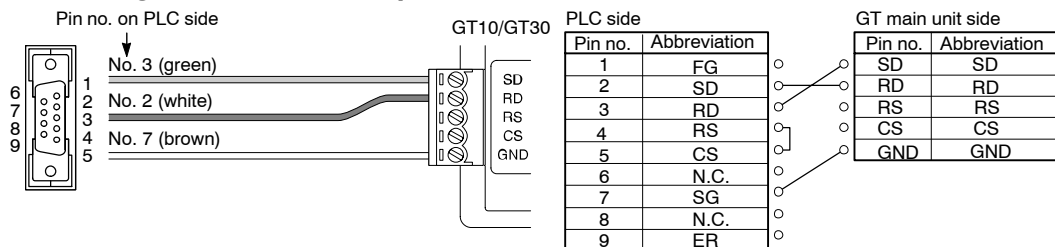

4.4 Connecting the FP2/FP2SH

4.4.1 Connecting to the COM. Port

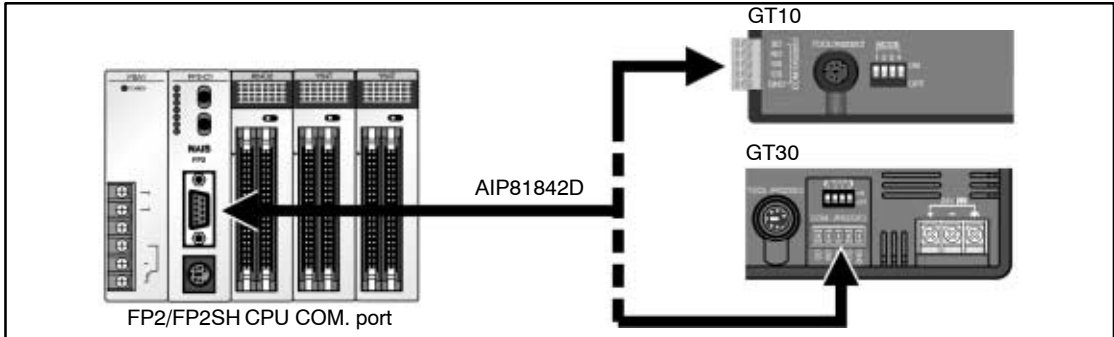

FP2/FP2SH communication format settings

System register no.	Item	Value Set
412	Selection of target use of RS232C port	Computer link
413	Data length	8 bits
	Parity check	Yes
	Parity setting	Odd
	Stop bits	1 bit
	Line return code	CR
	Start code	No STX
414	Baud rate setting	19200 bits/s
415	Unit number	1
416	Modem connection	No connection

PLC communication cable: D-sub 9-pin loose-wire cable (AIP81842D)

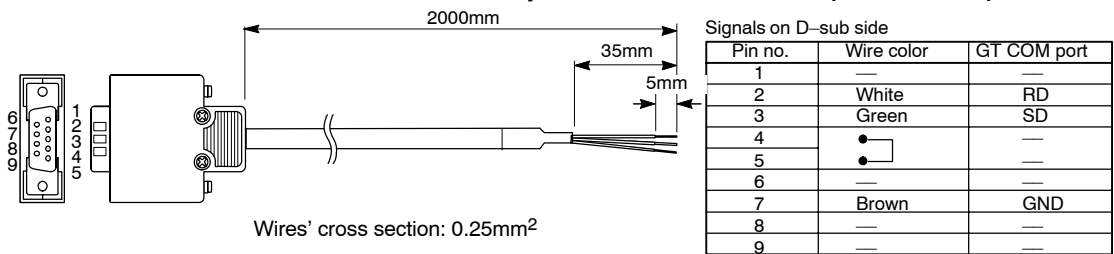

Wires' cross section: 0.25mm²

Specifications	Length	Product no.
D-sub 9-pin Single-side loose wiring	2m	AIP81842D

Connecting to the FP2/FP2SH COM. port

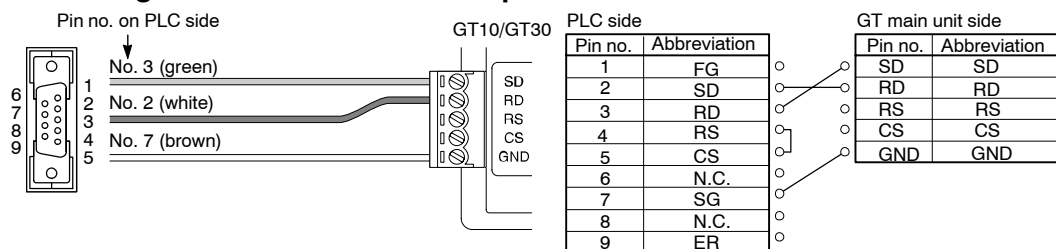

4.4.2 Connecting to the TOOL Port

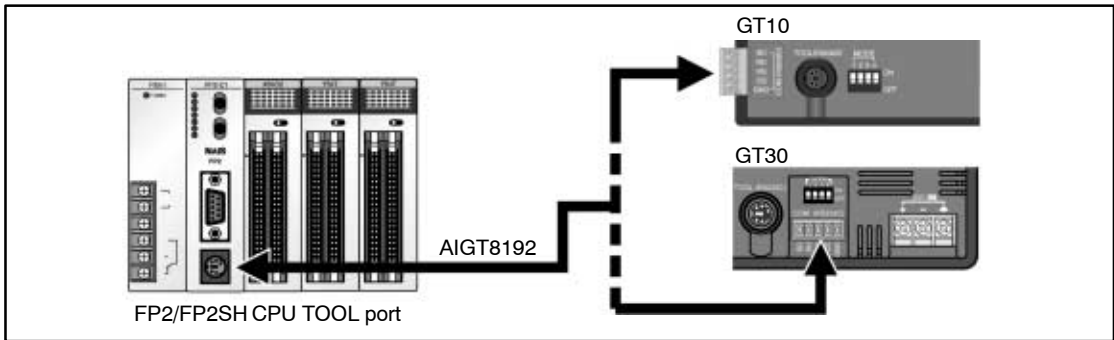

FP2/FP2SH communication format settings

System register no.	Item	Value Set
410	Unit number	1
411	Data length	8 bits
	Modem connection	No connection
414	Baud rate setting	19200 bits/s

PLC communication cable: Mini-DIN 5-pin loose-wire cable (AIGT8192)

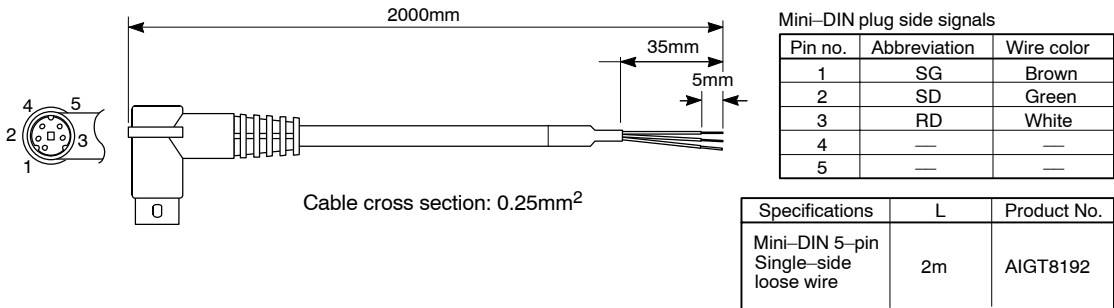

Connecting to the FP2/FP2SH TOOL port

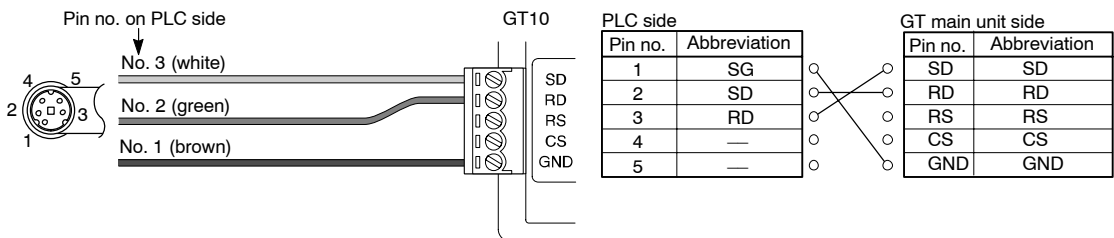

4.5 Connecting the FP2/FP2SH CCU

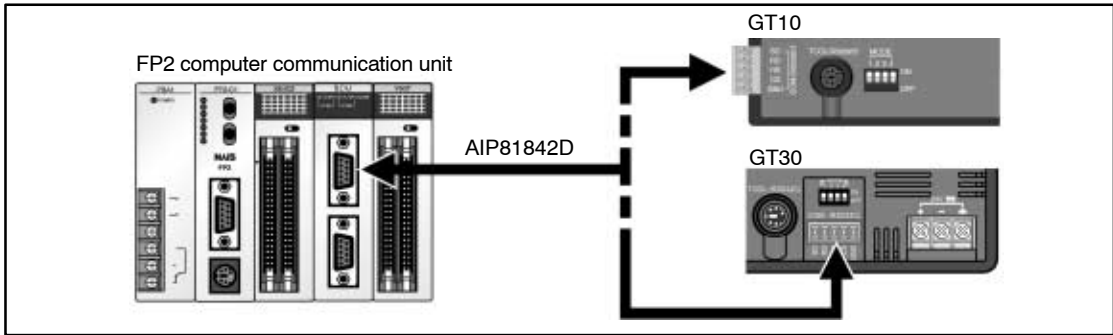

DIP switch settings on reverse side of FP2 computer communication unit

SW No.	Setting contents	Value Set	Switch status
1	Reserved for system		ON
2	COM.1 transfer speed	19200 bits/s	ON
3			OFF
4	COM.1 data length	8 bits	ON
5	Reserved for system		ON
6	COM.2 transfer speed	19200 bits/s	ON
7			OFF
8	COM.2 data length	8 bits	ON



If both serial ports of the FP2 computer communication unit are being used, each port should be set individually as shown at the left.

With the FP2 CCU, the parity check is fixed at “Odd”, and the number of stop bits is fixed at “1 bit”.

PLC communication cable: D-sub 9-pin loose-wire cable (AIP81842D)

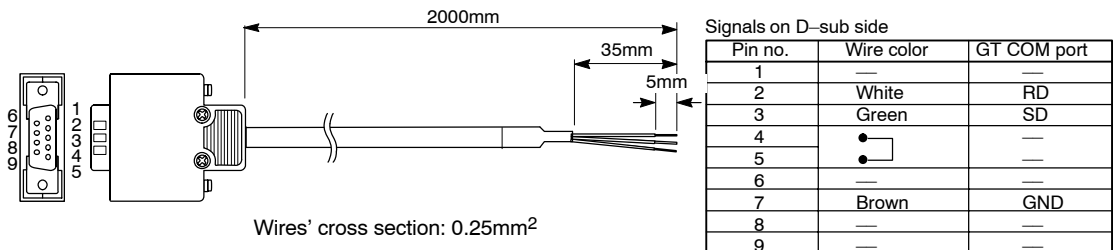

Specifications	Length	Product no.
D-sub 9-pin Single-side loose wiring	2m	AIP81842D

Connecting to the FP2 computer communication unit (CCU)

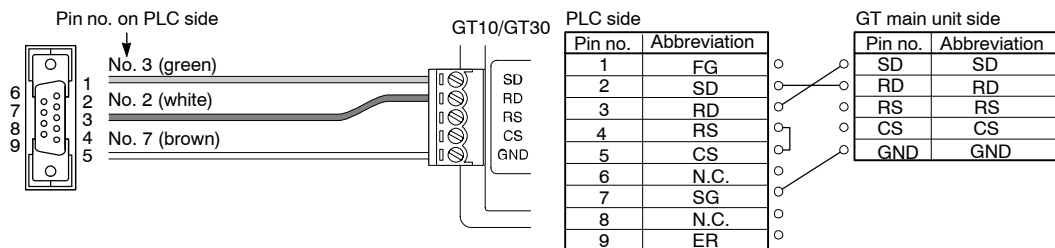

4.6 Connecting the FP10SH

4.6.1 Connecting to the COM. Port

■ FP10SH communication format settings

SW no.	1	2	3	4	5	6	7	8
Setting port	COM. setting port							
Setting contents	Modem control	Start code	End code	Stop bit length	Parity check	Data length		
Value Set	No	STX invalid	CR code	1 bit	Odd parity	8 bits		
Switch status	OFF	OFF	OFF	ON	ON	ON	ON	ON
	DIP SW 1							

SW no.	1	2	3	4	5	6	7	8
Setting port	TOOL port		Memory			COM. setting port		
Setting contents	Transfer speed	Data length	Modem control	Program memory protect	Program memory select	Transfer speed		
Value Set	Not related to GT10 communication					19200 bits/s		
Switch status	Not related to GT10 communication					ON	ON	OFF
	DIP SW 2							

DIP SW 1

DIP SW 2

Not related to GT10 communication

Unit number setting

0 1

FP10SH CPU COM. port

AIP81842

GT10

GT30

PLC communication cable: D-sub 9-pin loose-wire cable (AIP81842D)

Wires' cross section: 0.25mm²

Pin no.	Wire color	GT COM port
1	—	—
2	White	RD
3	Green	SD
4	•	—
5	•	—
6	—	—
7	Brown	GND
8	—	—
9	—	—

Specifications	Length	Product no.
D-sub 9-pin Single-side loose wiring	2m	AIP81842D

Connecting to the FP10SH COM. port

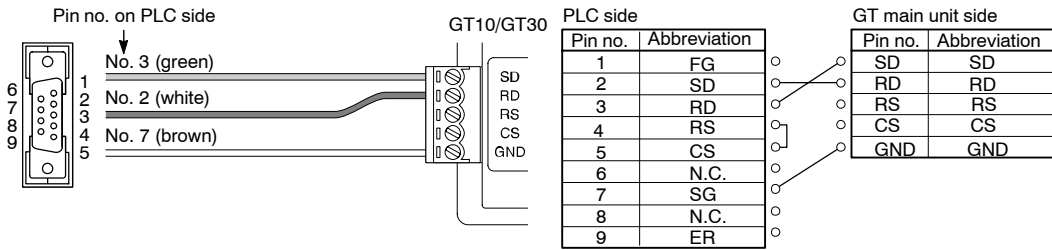

4.6.2 Connecting to the TOOL Port

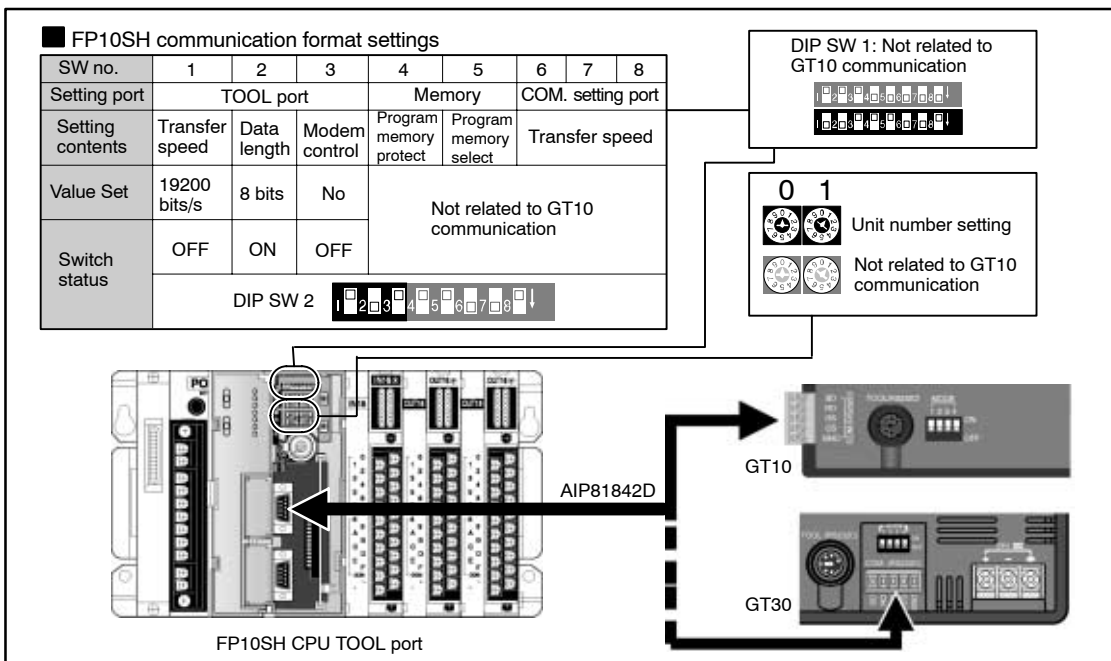

PLC communication cable: D-sub 9-pin loose-wire cable (AIP81842D)

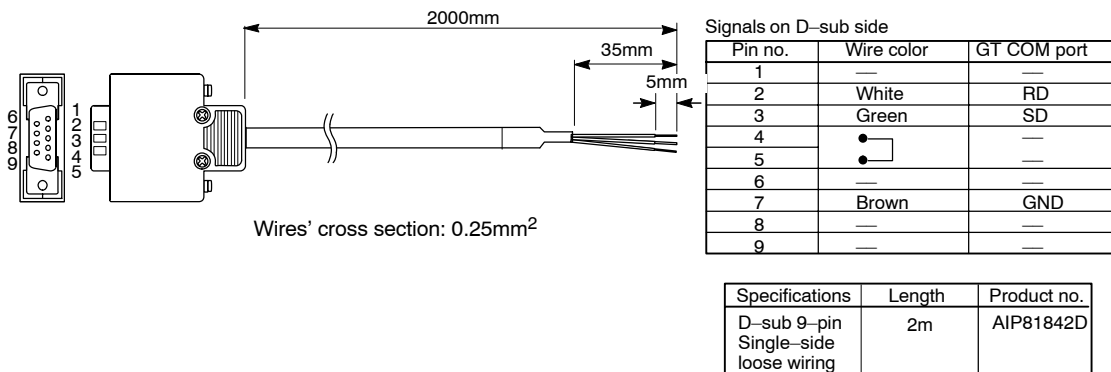

Connecting to the FP10SH TOOL port

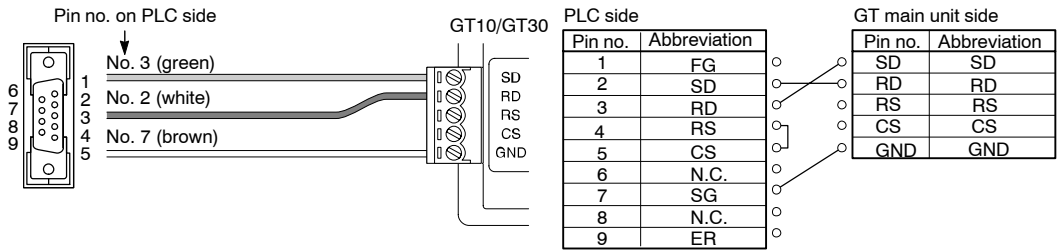

4.7 Connecting the FP10SH/FP3 CCU

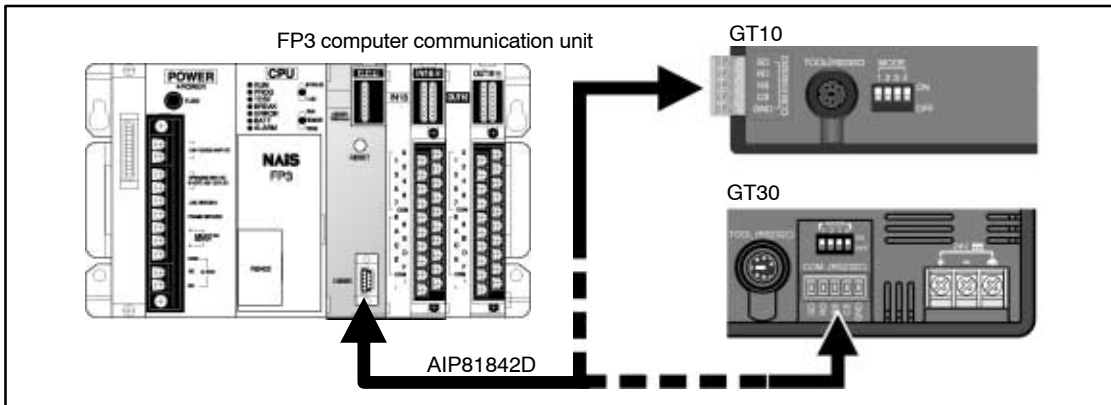

DIP switch settings on reverse side of FP3 computer communication unit

SW No.	Setting contents	Value Set	Switch status
1	Transfer speed	19200 bits/s	ON
2			OFF
3			OFF
4	Data length	8 bits	ON
5	Parity check	Odd parity	ON
6			OFF
7	Stop bit length	1 bit	OFF
8	Control signals	CS, RS invalid	OFF

PLC communication cable: D-sub 9-pin loose-wire cable (AIP81842D)

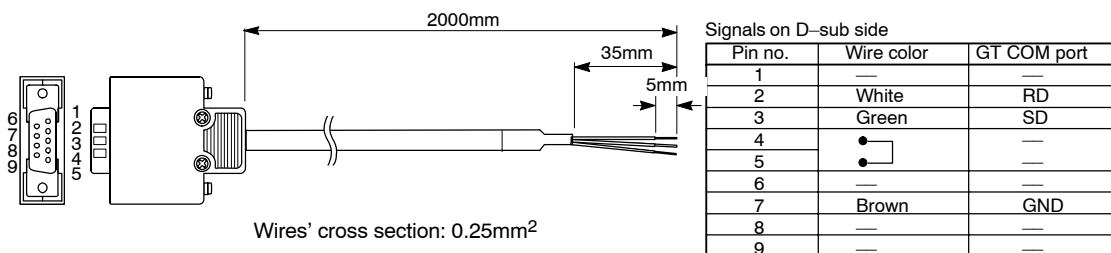

Specifications	Length	Product no.
D-sub 9-pin Single-side loose wiring	2m	AIP81842D

Connecting to the FP3 computer communication unit (CCU)

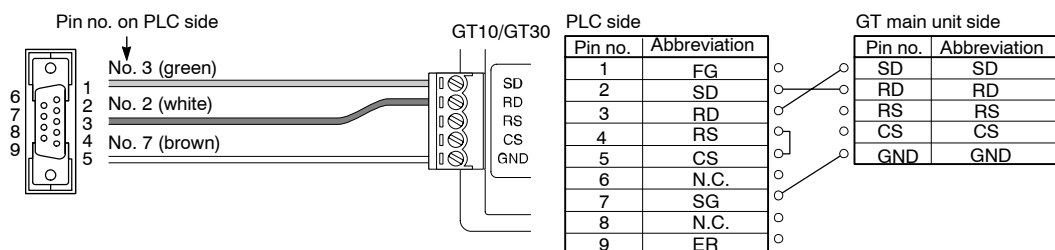

4.8 Connecting the FP-M

4.8.1 Connecting to the COM. Port

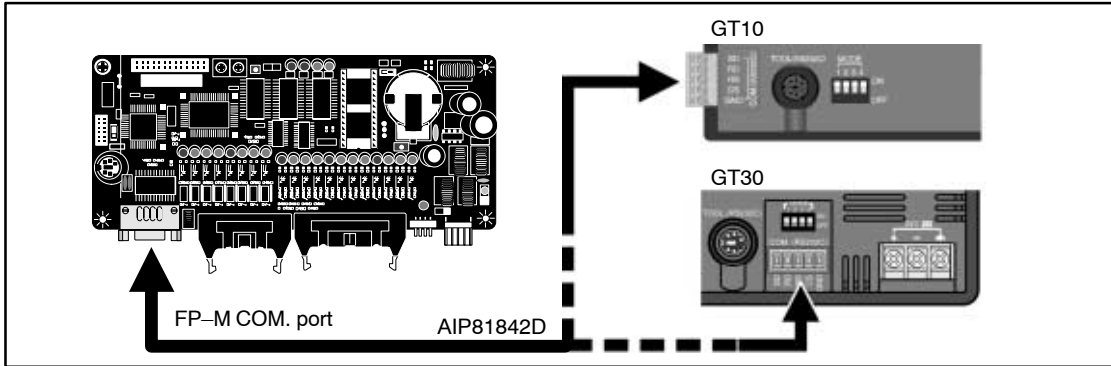

FP-M communication format settings

System register no.	Item	Value Set	System register value
412	Selection of target use of RS232C port	Computer link	K1
413	Data length	8 bits	K3
	Parity check	Yes	
	Parity setting	Odd	
	Stop bits	1 bit	
	Line return code	CR	
	Start code	No STX	
414	Baud rate setting	19200 bits/s	K0
415	Unit number	1	K1
416	Modem connection	No connection	H0

PLC communication cable: D-sub 9-pin loose-wire cable (AIP81842D)

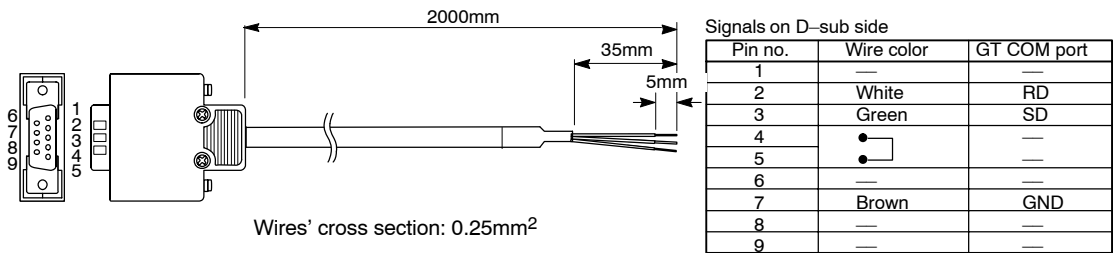

Specifications	Length	Product no.
D-sub 9-pin Single-side loose wiring	2m	AIP81842D

Connecting to the FP-M COM. Port

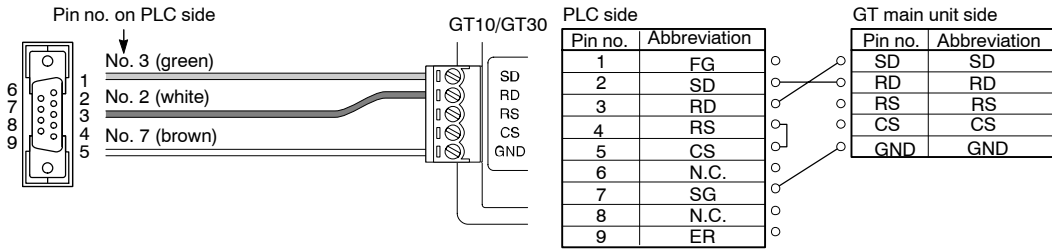

4.8.2 Connecting to the TOOL Port

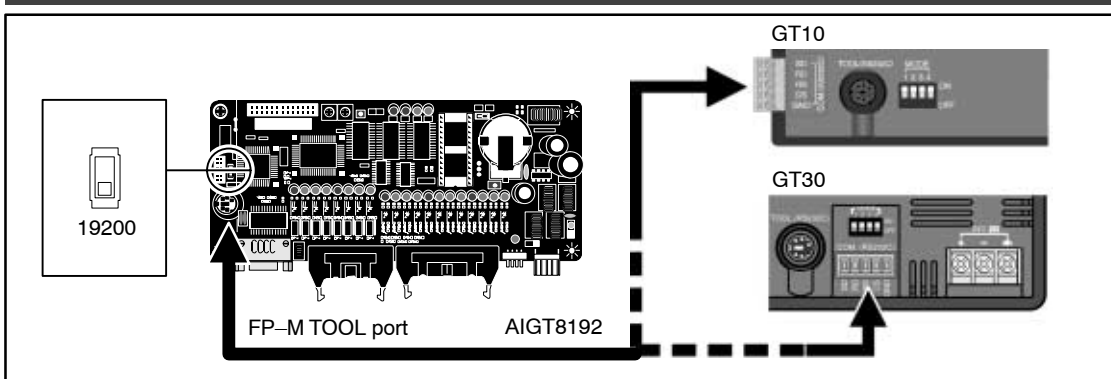

FP-M communication format settings

System register no.	Item	Value Set	System register value
410	Unit number	1	K1
411	Data length	8 bits	H0
	Modem connection	No connection	

PLC communication cable: Mini-DIN 5-pin loose-wire cable (AIGT8192)

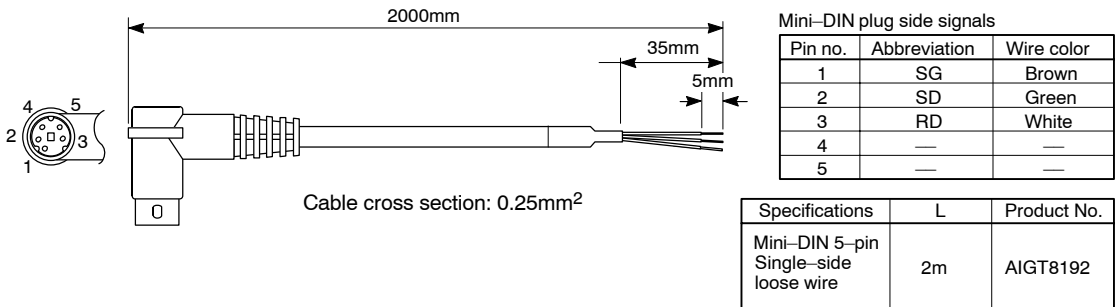

Connecting to the FP-M TOOL port

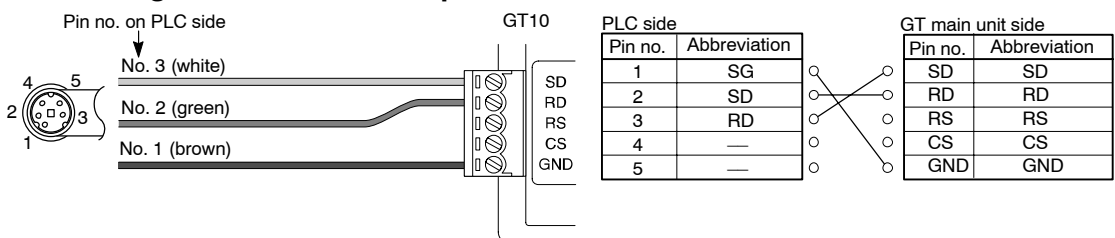

4.9 Automatic Communication Settings Function

After turning on the power supply, if there is no response from the PLC connected to the GT10/GT30, the GT10/GT30 switches to the automatic setting mode for the communication conditions. In the automatic setting mode, commands are sent to the PLC while changing the communication conditions in the sequence shown below.

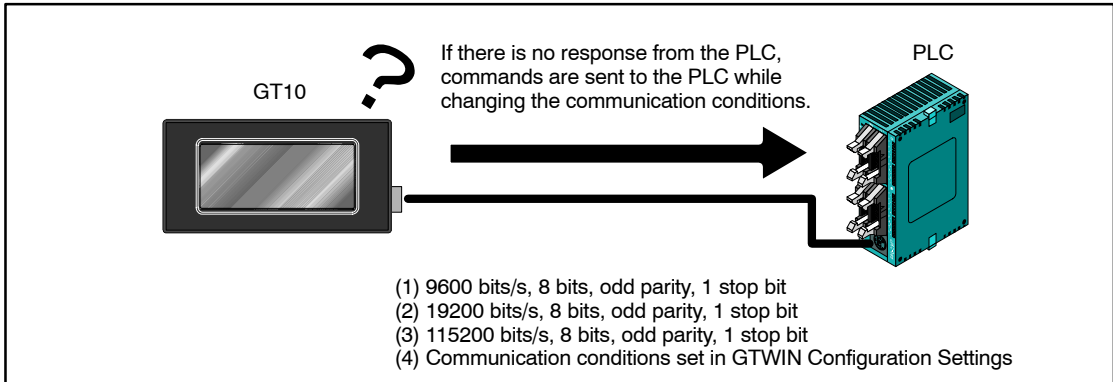

The GT10/GT30, in automatic setting mode, continues to repeat steps (1) to (4) until there is a response from the PLC. While it is repeating these steps, it is in the “Standby” mode under “GT10/GT30 Configuration” a “Communication Parameters” a “Handle Communication Error” on GTWIN. For information on how settings are entered, please refer to page 75 (GT10) and page 97 (GT30).



◆ EXPLANATION

- **Conditions when the automatic settings mode is in effect**
If communication is attempted the specified number of times and there is no response from the PLC, the GT10/GT30 goes into the automatic settings mode. The number of attempts is specified using the “No. of Retries” parameter under “GT10/GT30 Configuration” → “Communication Parameters” → “Handle Communication Error” on GTWIN. For information on how settings are entered, please refer to page 75 (GT10) and page 97 (GT30).
- **Automatically set communication conditions**
In the automatic settings mode, if there is a response from the PLC, subsequent communication is carried out under conditions matching the response. The main unit configuration settings are not updated, however, even if the communication parameters are different from those of the main unit configuration settings.



◆ CAUTION

- An error response from the PLC is taken as a response, and the GT10/GT30 does not go into the automatic settings mode.
- If the unit is connected to the COM port of the FP0/FP1/FP2/FP2SH/FP-M, communication between the FP device

and the PLC will not be possible if the target usage of the RS232C port has been set to “Computer Link”. Always set the setting on the PLC side to match “Computer Link”. For detailed information, please refer to Chapter 4, “Connecting and Communicating with the PLC”, on page 41.

4.10 Through Function

With the GT series, communication can be set to take place automatically between the COM. and TOOL ports in a “through function”. When the FP series tool software installed in the computer connected to the GT series as shown below is booted, PLC programs can be edited through the GT series.

The through function does not require any special settings, and is always in the standby mode.

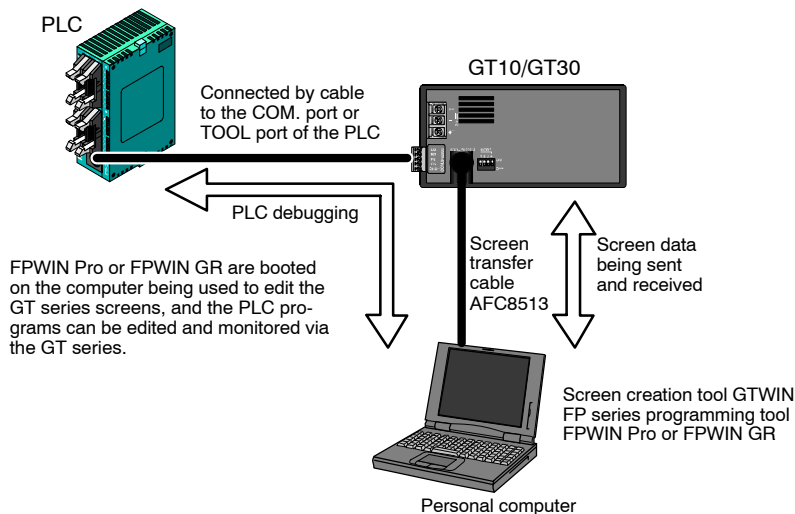

- Precautions when using the through function**

The system should be set up so that the interval for communication retries in the FP series software (FPWIN Pro or FPWIN GR) (A) is larger than that of the GT10 COM. port (B), meaning (A) > (B). If the system is set up so that A = B or A < B, the through function will not work properly.
- Restrictions on COM. port connections**

If the GT series is connected to the COM. port of the PLC, please be aware that some functions cannot be used, such as rewriting in the RUN mode in FPWIN Pro or FPWIN GR.
- Precautions when connecting the FP Programmer II to the TOOL port**

If the FP Programmer II is connected to the TOOL port of the GT series, the operating voltage of the GT series should be set to 25V DC or less. Also, the GT series should not be left connected to the

FP Programmer II on an ongoing basis.

GT10/GT30

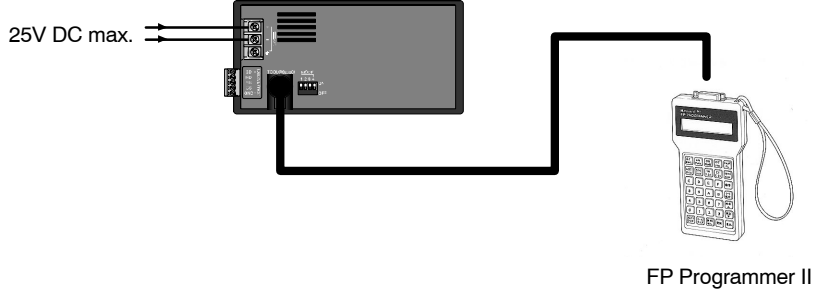

FP Programmer II

4.11 Connecting with a PLC by Mitsubishi Electric Corp.

4.11.1 FX Series

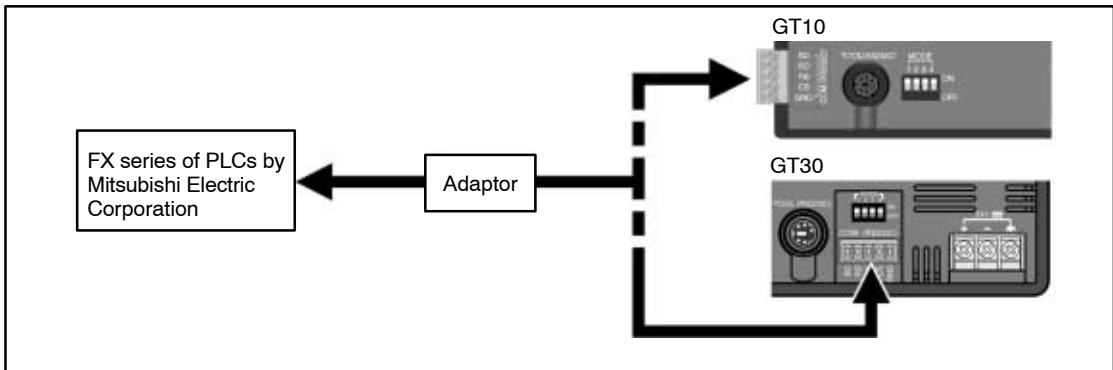

Making connections

CPU	Adaptor	Wiring diagram	GT series																																												
FX1N	FX1N-232-BD	<table border="1"> <thead> <tr> <th colspan="2">Mitsubishi PLC adaptor side</th> <th colspan="2">GT main unit side</th> </tr> <tr> <th>Pin no.</th> <th>Abbreviation</th> <th>Pin no.</th> <th>Abbreviation</th> </tr> </thead> <tbody> <tr> <td>1</td> <td>CD</td> <td>SD</td> <td>SD</td> </tr> <tr> <td>2</td> <td>RD</td> <td>RD</td> <td>RD</td> </tr> <tr> <td>3</td> <td>SD</td> <td>RS</td> <td>RS</td> </tr> <tr> <td>4</td> <td>ER</td> <td>CS</td> <td>CS</td> </tr> <tr> <td>5</td> <td>SG</td> <td>GND</td> <td>GND</td> </tr> <tr> <td>6</td> <td>DR</td> <td></td> <td></td> </tr> <tr> <td>7</td> <td></td> <td></td> <td></td> </tr> <tr> <td>8</td> <td></td> <td></td> <td></td> </tr> <tr> <td>9</td> <td></td> <td></td> <td></td> </tr> </tbody> </table>	Mitsubishi PLC adaptor side		GT main unit side		Pin no.	Abbreviation	Pin no.	Abbreviation	1	CD	SD	SD	2	RD	RD	RD	3	SD	RS	RS	4	ER	CS	CS	5	SG	GND	GND	6	DR			7				8				9				GT10/GT30
Mitsubishi PLC adaptor side			GT main unit side																																												
Pin no.	Abbreviation	Pin no.	Abbreviation																																												
1	CD	SD	SD																																												
2	RD	RD	RD																																												
3	SD	RS	RS																																												
4	ER	CS	CS																																												
5	SG	GND	GND																																												
6	DR																																														
7																																															
8																																															
9																																															
FX2N	FX2N-232-BD																																														

* Be aware that communication will not be possible if the above adaptor cannot be connected to the FX series.

Setting the communication conditions

Setting the communication conditions for the GT main unit

The following settings should be entered for the COM port communication condition settings.

Item	Value Set
Communication speed setting	9600 bits/s
Data length	7 bits
Parity check	Yes, Even
Stop bits	1 bit

Setting the communication conditions for the PLC

“0” should be stored in D8120. (“0” is the default value, so this setting should not need to be entered by the user.)

Devices that can be used

Device type	Address range	Points
Input relay	X000 to X377 (Octal notation)	256 points
Output relay	Y000 to Y377 (Octal notation)	256 points
Auxiliary relay	M0000 to M1535 (Decimal notation)	1536 points
Data register	D0000 to D1023 (Decimal notation)	1024 words

**◆ NOTES**

- Depending on the type being used, the address range may be limited to a small range. Please refer to the instruction manual of the PLC being used for detailed information.
- If input relays, output relays and auxiliary relays are being used in word units, addresses should be specified in 16–point units, starting from 000. (X000, X020, X040, ...)

**◆ REFERENCE**

For the contents of error codes, please refer to “Error Codes and How to Handle Them” on page 142.

4.12 Connecting with a PLC by Omron Corp.

4.12.1 SYSMAC C Series, α Series, CV Series, and CS1 Series

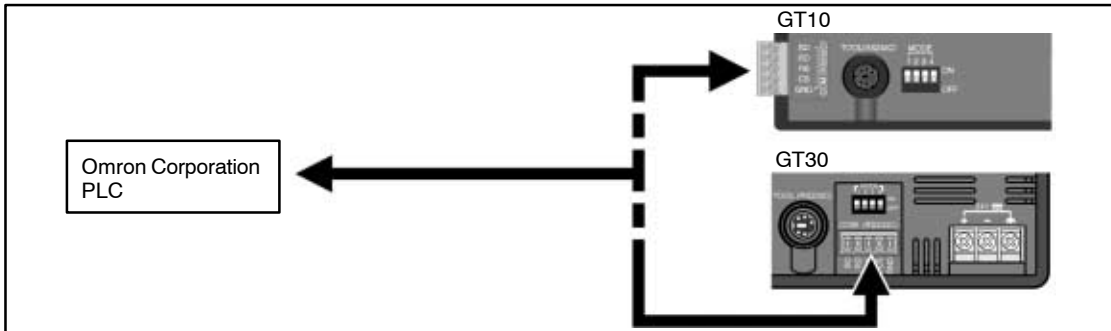

Making connections

SYSMAC C series (using link interface)

CPU	Link I/F	Wiring diagram	GT series																																
C200H	C200H-LK201* ¹ C120-LK201-V1* ²	<p>D-sub 25-pin on Omron PLC side</p> <table border="1"> <thead> <tr> <th>Pin no.</th> <th>Abbreviation</th> </tr> </thead> <tbody> <tr><td>1</td><td>FG</td></tr> <tr><td>2</td><td>SD</td></tr> <tr><td>3</td><td>RD</td></tr> <tr><td>4</td><td>RS</td></tr> <tr><td>5</td><td>CS</td></tr> <tr><td>6</td><td></td></tr> <tr><td>7</td><td>SG</td></tr> <tr><td>.</td><td></td></tr> <tr><td>20</td><td>ER</td></tr> </tbody> </table> <p>GT main unit side</p> <table border="1"> <thead> <tr> <th>Pin no.</th> <th>Abbreviation</th> </tr> </thead> <tbody> <tr><td>SD</td><td>SD</td></tr> <tr><td>RD</td><td>RD</td></tr> <tr><td>RS</td><td>RS</td></tr> <tr><td>CS</td><td>CS</td></tr> <tr><td>GND</td><td>GND</td></tr> </tbody> </table>	Pin no.	Abbreviation	1	FG	2	SD	3	RD	4	RS	5	CS	6		7	SG	.		20	ER	Pin no.	Abbreviation	SD	SD	RD	RD	RS	RS	CS	CS	GND	GND	GT10/GT30
	Pin no.	Abbreviation																																	
1	FG																																		
2	SD																																		
3	RD																																		
4	RS																																		
5	CS																																		
6																																			
7	SG																																		
.																																			
20	ER																																		
Pin no.	Abbreviation																																		
SD	SD																																		
RD	RD																																		
RS	RS																																		
CS	CS																																		
GND	GND																																		
C200HS	<p>C200H-LK201*¹ C120-LK201-V1*²</p> <p>Link interface on the CPU unit *³</p> <p>D-sub 9-pin on Omron PLC side</p> <table border="1"> <thead> <tr> <th>Pin no.</th> <th>Abbreviation</th> </tr> </thead> <tbody> <tr><td>1</td><td>FD</td></tr> <tr><td>2</td><td>SD</td></tr> <tr><td>3</td><td>RD</td></tr> <tr><td>4</td><td>RS</td></tr> <tr><td>5</td><td>CS</td></tr> <tr><td>6</td><td></td></tr> <tr><td>7</td><td></td></tr> <tr><td>8</td><td></td></tr> <tr><td>9</td><td>SG</td></tr> </tbody> </table> <p>GT main unit side</p> <table border="1"> <thead> <tr> <th>Pin no.</th> <th>Abbreviation</th> </tr> </thead> <tbody> <tr><td>SD</td><td>SD</td></tr> <tr><td>RD</td><td>RD</td></tr> <tr><td>RS</td><td>RS</td></tr> <tr><td>CS</td><td>CS</td></tr> <tr><td>GND</td><td>GND</td></tr> </tbody> </table>	Pin no.	Abbreviation	1	FD	2	SD	3	RD	4	RS	5	CS	6		7		8		9	SG	Pin no.	Abbreviation	SD	SD	RD	RD	RS	RS	CS	CS	GND	GND		
Pin no.	Abbreviation																																		
1	FD																																		
2	SD																																		
3	RD																																		
4	RS																																		
5	CS																																		
6																																			
7																																			
8																																			
9	SG																																		
Pin no.	Abbreviation																																		
SD	SD																																		
RD	RD																																		
RS	RS																																		
CS	CS																																		
GND	GND																																		

*1 This is the base installation type.

*2 This is the CPU installation type.

*3 This connects to the RS232C port.

CPU	Link I/F	Wiring diagram	GT series																																	
C500 C500F C1000H C2000 C2000H	C120-LK201-V1 ^{*2} C500-LK201-V1 ^{*1} C500-LK203 ^{*1}	D-sub 25-pin on Omron PLC side <table border="1"> <thead> <tr> <th>Pin no.</th> <th>Abbreviation</th> </tr> </thead> <tbody> <tr><td>1</td><td>FG</td></tr> <tr><td>2</td><td>SD</td></tr> <tr><td>3</td><td>RD</td></tr> <tr><td>4</td><td>RS</td></tr> <tr><td>5</td><td>CS</td></tr> <tr><td>6</td><td></td></tr> <tr><td>7</td><td>SG</td></tr> <tr><td>.</td><td></td></tr> <tr><td>20</td><td>ER</td></tr> </tbody> </table>	Pin no.	Abbreviation	1	FG	2	SD	3	RD	4	RS	5	CS	6		7	SG	.		20	ER	GT main unit side <table border="1"> <thead> <tr> <th>Pin no.</th> <th>Abbreviation</th> </tr> </thead> <tbody> <tr><td>SD</td><td>SD</td></tr> <tr><td>RD</td><td>RD</td></tr> <tr><td>RS</td><td>RS</td></tr> <tr><td>CS</td><td>CS</td></tr> <tr><td>GND</td><td>GND</td></tr> </tbody> </table>	Pin no.	Abbreviation	SD	SD	RD	RD	RS	RS	CS	CS	GND	GND	GT10/GT30
	Pin no.		Abbreviation																																	
1	FG																																			
2	SD																																			
3	RD																																			
4	RS																																			
5	CS																																			
6																																				
7	SG																																			
.																																				
20	ER																																			
Pin no.	Abbreviation																																			
SD	SD																																			
RD	RD																																			
RS	RS																																			
CS	CS																																			
GND	GND																																			
C1000HF	C500-LK203 ^{*1}																																			
C20H C28H C40H	Link interface on the CPU unit ^{*3}	D-sub 9-pin on Omron PLC side <table border="1"> <thead> <tr> <th>Pin no.</th> <th>Abbreviation</th> </tr> </thead> <tbody> <tr><td>1</td><td>FG</td></tr> <tr><td>2</td><td>SD</td></tr> <tr><td>3</td><td>RD</td></tr> <tr><td>4</td><td>RS</td></tr> <tr><td>5</td><td>CS</td></tr> <tr><td>6</td><td></td></tr> <tr><td>7</td><td>SG</td></tr> <tr><td>8</td><td></td></tr> <tr><td>9</td><td></td></tr> </tbody> </table>	Pin no.	Abbreviation	1	FG	2	SD	3	RD	4	RS	5	CS	6		7	SG	8		9		GT main unit side <table border="1"> <thead> <tr> <th>Pin no.</th> <th>Abbreviation</th> </tr> </thead> <tbody> <tr><td>SD</td><td>SD</td></tr> <tr><td>RD</td><td>RD</td></tr> <tr><td>RS</td><td>RS</td></tr> <tr><td>CS</td><td>CS</td></tr> <tr><td>GND</td><td>GND</td></tr> </tbody> </table>	Pin no.	Abbreviation	SD	SD	RD	RD	RS	RS	CS	CS	GND	GND	
Pin no.	Abbreviation																																			
1	FG																																			
2	SD																																			
3	RD																																			
4	RS																																			
5	CS																																			
6																																				
7	SG																																			
8																																				
9																																				
Pin no.	Abbreviation																																			
SD	SD																																			
RD	RD																																			
RS	RS																																			
CS	CS																																			
GND	GND																																			
C120 C120F	C120-LK201-V1 ^{*2}	D-sub 25-pin on Omron PLC side <table border="1"> <thead> <tr> <th>Pin no.</th> <th>Abbreviation</th> </tr> </thead> <tbody> <tr><td>1</td><td>FG</td></tr> <tr><td>2</td><td>SD</td></tr> <tr><td>3</td><td>RD</td></tr> <tr><td>4</td><td>RS</td></tr> <tr><td>5</td><td>CS</td></tr> <tr><td>6</td><td></td></tr> <tr><td>7</td><td>SG</td></tr> <tr><td>.</td><td></td></tr> <tr><td>20</td><td>ER</td></tr> </tbody> </table>	Pin no.	Abbreviation	1	FG	2	SD	3	RD	4	RS	5	CS	6		7	SG	.		20	ER	GT main unit side <table border="1"> <thead> <tr> <th>Pin no.</th> <th>Abbreviation</th> </tr> </thead> <tbody> <tr><td>SD</td><td>SD</td></tr> <tr><td>RD</td><td>RD</td></tr> <tr><td>RS</td><td>RS</td></tr> <tr><td>CS</td><td>CS</td></tr> <tr><td>GND</td><td>GND</td></tr> </tbody> </table>	Pin no.	Abbreviation	SD	SD	RD	RD	RS	RS	CS	CS	GND	GND	
Pin no.	Abbreviation																																			
1	FG																																			
2	SD																																			
3	RD																																			
4	RS																																			
5	CS																																			
6																																				
7	SG																																			
.																																				
20	ER																																			
Pin no.	Abbreviation																																			
SD	SD																																			
RD	RD																																			
RS	RS																																			
CS	CS																																			
GND	GND																																			
CQM1-CPU42 SRM1-C02 CPM2A CPM1-20CDR-A CQM1H-CPU21	RS232C port on CPU unit CPM1-CIF01 RS232C port on CPU unit CPM1-CIF01 RS232C port on CPU unit	D-sub 9-pin on Omron PLC side <table border="1"> <thead> <tr> <th>Pin no.</th> <th>Abbreviation</th> </tr> </thead> <tbody> <tr><td>1</td><td>FD</td></tr> <tr><td>2</td><td>SD</td></tr> <tr><td>3</td><td>RD</td></tr> <tr><td>4</td><td>RS</td></tr> <tr><td>5</td><td>CS</td></tr> <tr><td>6</td><td></td></tr> <tr><td>7</td><td></td></tr> <tr><td>8</td><td></td></tr> <tr><td>9</td><td>SG</td></tr> </tbody> </table>	Pin no.	Abbreviation	1	FD	2	SD	3	RD	4	RS	5	CS	6		7		8		9	SG	GT main unit side <table border="1"> <thead> <tr> <th>Pin no.</th> <th>Abbreviation</th> </tr> </thead> <tbody> <tr><td>SD</td><td>SD</td></tr> <tr><td>RD</td><td>RD</td></tr> <tr><td>RS</td><td>RS</td></tr> <tr><td>CS</td><td>CS</td></tr> <tr><td>GND</td><td>GND</td></tr> </tbody> </table>	Pin no.	Abbreviation	SD	SD	RD	RD	RS	RS	CS	CS	GND	GND	
Pin no.	Abbreviation																																			
1	FD																																			
2	SD																																			
3	RD																																			
4	RS																																			
5	CS																																			
6																																				
7																																				
8																																				
9	SG																																			
Pin no.	Abbreviation																																			
SD	SD																																			
RD	RD																																			
RS	RS																																			
CS	CS																																			
GND	GND																																			

- *1 This is the base installation type.
- *2 This is the CPU installation type.
- *3 This connects to the RS232C port.

SYSMAC C series (direct connection to CPU)

CPU *1	Usable cables	GT series
C200HS SRM1-C02 CQM1-CPU11 CQM1-CPU42 CPM1-20CDR-A CQM1H-CPU21 *2	Isolation cable by Omron Corporation CQM1-CIF01	GT10/GT30

*1 This is connected to the peripheral port.

*2 The CS1W-CN114 cable by Omron Corporation is required.



CAUTION

Please be aware that, because only one peripheral port is provided with the CQM1-CPU11, it cannot be used at the same time as a PLC.

SYSMAC α series (using link interface)

CPU	Link I/F	Wiring diagram	GT series																																		
C200HX- CPU85-Z CPU64 CPU44 C200HE- CPU42 C200HG- CPU63 CPU43	C200HW-COM06	<p>D-sub 9-pin on Omron PLC side</p> <table border="1"> <thead> <tr> <th>Pin no.</th> <th>Abbreviation</th> </tr> </thead> <tbody> <tr><td>1</td><td>FG</td></tr> <tr><td>2</td><td>SD</td></tr> <tr><td>3</td><td>RD</td></tr> <tr><td>4</td><td>RS</td></tr> <tr><td>5</td><td>CS</td></tr> <tr><td>6</td><td></td></tr> <tr><td>7</td><td></td></tr> <tr><td>8</td><td></td></tr> <tr><td>9</td><td>SG</td></tr> </tbody> </table> <p>GT main unit side</p> <table border="1"> <thead> <tr> <th>Pin no.</th> <th>Abbreviation</th> </tr> </thead> <tbody> <tr><td>SD</td><td>SD</td></tr> <tr><td>RD</td><td>RD</td></tr> <tr><td>RS</td><td>RS</td></tr> <tr><td>CS</td><td>CS</td></tr> <tr><td>GND</td><td>GND</td></tr> </tbody> </table>	Pin no.	Abbreviation	1	FG	2	SD	3	RD	4	RS	5	CS	6		7		8		9	SG	Pin no.	Abbreviation	SD	SD	RD	RD	RS	RS	CS	CS	GND	GND	GT10/GT30		
Pin no.	Abbreviation																																				
1	FG																																				
2	SD																																				
3	RD																																				
4	RS																																				
5	CS																																				
6																																					
7																																					
8																																					
9	SG																																				
Pin no.	Abbreviation																																				
SD	SD																																				
RD	RD																																				
RS	RS																																				
CS	CS																																				
GND	GND																																				
C200HE- CPU42-Z	RS232C port on CPU unit																																				
C200HX- CPU64-Z	C200-LK201-V1	<p>D-sub 25-pin on Omron PLC side</p> <table border="1"> <thead> <tr> <th>Pin no.</th> <th>Abbreviation</th> </tr> </thead> <tbody> <tr><td>1</td><td>FG</td></tr> <tr><td>2</td><td>SD</td></tr> <tr><td>3</td><td>RD</td></tr> <tr><td>4</td><td>RS</td></tr> <tr><td>5</td><td>CS</td></tr> <tr><td>6</td><td></td></tr> <tr><td>7</td><td>SG</td></tr> <tr><td>.</td><td></td></tr> <tr><td>.</td><td></td></tr> <tr><td>20</td><td>ER</td></tr> </tbody> </table> <p>GT main unit side</p> <table border="1"> <thead> <tr> <th>Pin no.</th> <th>Abbreviation</th> </tr> </thead> <tbody> <tr><td>SD</td><td>SD</td></tr> <tr><td>RD</td><td>RD</td></tr> <tr><td>RS</td><td>RS</td></tr> <tr><td>CS</td><td>CS</td></tr> <tr><td>GND</td><td>GND</td></tr> </tbody> </table>	Pin no.	Abbreviation	1	FG	2	SD	3	RD	4	RS	5	CS	6		7	SG	.		.		20	ER	Pin no.	Abbreviation	SD	SD	RD	RD	RS	RS	CS	CS	GND	GND	
Pin no.	Abbreviation																																				
1	FG																																				
2	SD																																				
3	RD																																				
4	RS																																				
5	CS																																				
6																																					
7	SG																																				
.																																					
.																																					
20	ER																																				
Pin no.	Abbreviation																																				
SD	SD																																				
RD	RD																																				
RS	RS																																				
CS	CS																																				
GND	GND																																				

SYSMAC CV series (using link interface)

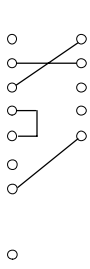
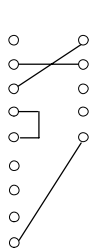
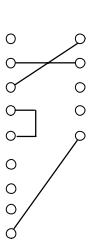
CPU	Link I/F	Wiring diagram	GT series																																																																		
CV500 CV1000 CVM1	CV500-LK201	<p>Communication port 1 connections D-sub 25-pin on Omron PLC side</p> <table border="1" data-bbox="555 299 755 566"> <thead> <tr> <th>Pin no.</th> <th>Abbreviation</th> </tr> </thead> <tbody> <tr><td>1</td><td>FG</td></tr> <tr><td>2</td><td>SD</td></tr> <tr><td>3</td><td>RD</td></tr> <tr><td>4</td><td>RS</td></tr> <tr><td>5</td><td>CS</td></tr> <tr><td>6</td><td></td></tr> <tr><td>7</td><td>SG</td></tr> <tr><td>.</td><td></td></tr> <tr><td>.</td><td></td></tr> <tr><td>20</td><td>ER</td></tr> </tbody> </table>  <table border="1" data-bbox="857 299 1064 446"> <thead> <tr> <th>Pin no.</th> <th>Abbreviation</th> </tr> </thead> <tbody> <tr><td>SD</td><td>SD</td></tr> <tr><td>RD</td><td>RD</td></tr> <tr><td>RS</td><td>RS</td></tr> <tr><td>CS</td><td>CS</td></tr> <tr><td>GND</td><td>GND</td></tr> </tbody> </table> <p>Communication port 2 connections D-sub 9-pin on Omron PLC side</p> <table border="1" data-bbox="555 627 755 875"> <thead> <tr> <th>Pin no.</th> <th>Abbreviation</th> </tr> </thead> <tbody> <tr><td>1</td><td>FG</td></tr> <tr><td>2</td><td>SD</td></tr> <tr><td>3</td><td>RD</td></tr> <tr><td>4</td><td>RS</td></tr> <tr><td>5</td><td>CS</td></tr> <tr><td>6</td><td></td></tr> <tr><td>7</td><td></td></tr> <tr><td>8</td><td></td></tr> <tr><td>9.</td><td>SG</td></tr> </tbody> </table>  <table border="1" data-bbox="857 627 1064 774"> <thead> <tr> <th>Pin no.</th> <th>Abbreviation</th> </tr> </thead> <tbody> <tr><td>SD</td><td>SD</td></tr> <tr><td>RD</td><td>RD</td></tr> <tr><td>RS</td><td>RS</td></tr> <tr><td>CS</td><td>CS</td></tr> <tr><td>GND</td><td>GND</td></tr> </tbody> </table>	Pin no.	Abbreviation	1	FG	2	SD	3	RD	4	RS	5	CS	6		7	SG	.		.		20	ER	Pin no.	Abbreviation	SD	SD	RD	RD	RS	RS	CS	CS	GND	GND	Pin no.	Abbreviation	1	FG	2	SD	3	RD	4	RS	5	CS	6		7		8		9.	SG	Pin no.	Abbreviation	SD	SD	RD	RD	RS	RS	CS	CS	GND	GND	GT10/GT30
	Pin no.	Abbreviation																																																																			
1	FG																																																																				
2	SD																																																																				
3	RD																																																																				
4	RS																																																																				
5	CS																																																																				
6																																																																					
7	SG																																																																				
.																																																																					
.																																																																					
20	ER																																																																				
Pin no.	Abbreviation																																																																				
SD	SD																																																																				
RD	RD																																																																				
RS	RS																																																																				
CS	CS																																																																				
GND	GND																																																																				
Pin no.	Abbreviation																																																																				
1	FG																																																																				
2	SD																																																																				
3	RD																																																																				
4	RS																																																																				
5	CS																																																																				
6																																																																					
7																																																																					
8																																																																					
9.	SG																																																																				
Pin no.	Abbreviation																																																																				
SD	SD																																																																				
RD	RD																																																																				
RS	RS																																																																				
CS	CS																																																																				
GND	GND																																																																				
Link interface on the CPU unit *1	<p>D-sub 9-pin on Omron PLC side</p> <table border="1" data-bbox="555 913 755 1155"> <thead> <tr> <th>Pin no.</th> <th>Abbreviation</th> </tr> </thead> <tbody> <tr><td>1</td><td>FG</td></tr> <tr><td>2</td><td>SD</td></tr> <tr><td>3</td><td>RD</td></tr> <tr><td>4</td><td>RS</td></tr> <tr><td>5</td><td>CS</td></tr> <tr><td>6</td><td></td></tr> <tr><td>7</td><td></td></tr> <tr><td>8</td><td></td></tr> <tr><td>9</td><td>SG</td></tr> </tbody> </table>  <table border="1" data-bbox="857 913 1064 1060"> <thead> <tr> <th>Pin no.</th> <th>Abbreviation</th> </tr> </thead> <tbody> <tr><td>SD</td><td>SD</td></tr> <tr><td>RD</td><td>RD</td></tr> <tr><td>RS</td><td>RS</td></tr> <tr><td>CS</td><td>CS</td></tr> <tr><td>GND</td><td>GND</td></tr> </tbody> </table>	Pin no.	Abbreviation	1	FG	2	SD	3	RD	4	RS	5	CS	6		7		8		9	SG	Pin no.	Abbreviation	SD	SD	RD	RD	RS	RS	CS	CS	GND	GND																																				
Pin no.	Abbreviation																																																																				
1	FG																																																																				
2	SD																																																																				
3	RD																																																																				
4	RS																																																																				
5	CS																																																																				
6																																																																					
7																																																																					
8																																																																					
9	SG																																																																				
Pin no.	Abbreviation																																																																				
SD	SD																																																																				
RD	RD																																																																				
RS	RS																																																																				
CS	CS																																																																				
GND	GND																																																																				

*1 This is connected to the HOSTLINK port.

Using the SYSMAC CS1 series (1 : 1)

CPU	Link I/F	Wiring diagram	GT series																																
CS1H-CPU67 CS1H-CPU66 CS1H-CPU65 CS1H-CPU64 CS1H-CPU63 CS1G-CPU45 CS1G-CPU44 CS1G-CPU43 CS1G-CPU42	RS232C port on CPU unit	<p>D-sub 9-pin on Omron PLC side</p> <table border="1"> <thead> <tr> <th>Pin no.</th> <th>Abbreviation</th> </tr> </thead> <tbody> <tr><td>1</td><td>FG</td></tr> <tr><td>2</td><td>SD</td></tr> <tr><td>3</td><td>RD</td></tr> <tr><td>4</td><td>RS</td></tr> <tr><td>5</td><td>CS</td></tr> <tr><td>6</td><td></td></tr> <tr><td>7</td><td></td></tr> <tr><td>8</td><td></td></tr> <tr><td>9</td><td>SG</td></tr> </tbody> </table> <p>GT main unit side</p> <table border="1"> <thead> <tr> <th>Pin no.</th> <th>Abbreviation</th> </tr> </thead> <tbody> <tr><td>SD</td><td>SD</td></tr> <tr><td>RD</td><td>RD</td></tr> <tr><td>RS</td><td>RS</td></tr> <tr><td>CS</td><td>CS</td></tr> <tr><td>GND</td><td>GND</td></tr> </tbody> </table>	Pin no.	Abbreviation	1	FG	2	SD	3	RD	4	RS	5	CS	6		7		8		9	SG	Pin no.	Abbreviation	SD	SD	RD	RD	RS	RS	CS	CS	GND	GND	GT10/GT30
	Pin no.	Abbreviation																																	
	1	FG																																	
2	SD																																		
3	RD																																		
4	RS																																		
5	CS																																		
6																																			
7																																			
8																																			
9	SG																																		
Pin no.	Abbreviation																																		
SD	SD																																		
RD	RD																																		
RS	RS																																		
CS	CS																																		
GND	GND																																		
Peripheral port on CPU unit *1	<p>Connection cable for the peripheral port (25-pin)</p> <table border="1"> <thead> <tr> <th>Pin no.</th> <th>Abbreviation</th> </tr> </thead> <tbody> <tr><td>1</td><td>FG</td></tr> <tr><td>2</td><td>RD</td></tr> <tr><td>3</td><td>SD</td></tr> <tr><td>4</td><td>CS</td></tr> <tr><td>5</td><td>RS</td></tr> <tr><td>6</td><td></td></tr> <tr><td>7</td><td>SG</td></tr> <tr><td>.</td><td></td></tr> <tr><td>.</td><td></td></tr> <tr><td>25</td><td></td></tr> </tbody> </table> <p>GT main unit side</p> <table border="1"> <thead> <tr> <th>Pin no.</th> <th>Abbreviation</th> </tr> </thead> <tbody> <tr><td>SD</td><td>SD</td></tr> <tr><td>RD</td><td>RD</td></tr> <tr><td>RS</td><td>RS</td></tr> <tr><td>CS</td><td>CS</td></tr> <tr><td>GND</td><td>GND</td></tr> </tbody> </table>	Pin no.	Abbreviation	1	FG	2	RD	3	SD	4	CS	5	RS	6		7	SG	.		.		25		Pin no.	Abbreviation	SD	SD	RD	RD	RS	RS	CS	CS	GND	GND
Pin no.	Abbreviation																																		
1	FG																																		
2	RD																																		
3	SD																																		
4	CS																																		
5	RS																																		
6																																			
7	SG																																		
.																																			
.																																			
25																																			
Pin no.	Abbreviation																																		
SD	SD																																		
RD	RD																																		
RS	RS																																		
CS	CS																																		
GND	GND																																		
CS1W-SCU21 CS1W-SCB21 CS1W-SCB41	<p>D-sub 9-pin on Omron PLC side</p> <table border="1"> <thead> <tr> <th>Pin no.</th> <th>Abbreviation</th> </tr> </thead> <tbody> <tr><td>1</td><td>FG</td></tr> <tr><td>2</td><td>SD</td></tr> <tr><td>3</td><td>RD</td></tr> <tr><td>4</td><td>RS</td></tr> <tr><td>5</td><td>CS</td></tr> <tr><td>6</td><td></td></tr> <tr><td>7</td><td></td></tr> <tr><td>8</td><td></td></tr> <tr><td>9</td><td>SG</td></tr> </tbody> </table> <p>GT main unit side</p> <table border="1"> <thead> <tr> <th>Pin no.</th> <th>Abbreviation</th> </tr> </thead> <tbody> <tr><td>SD</td><td>SD</td></tr> <tr><td>RD</td><td>RD</td></tr> <tr><td>RS</td><td>RS</td></tr> <tr><td>CS</td><td>CS</td></tr> <tr><td>GND</td><td>GND</td></tr> </tbody> </table>	Pin no.	Abbreviation	1	FG	2	SD	3	RD	4	RS	5	CS	6		7		8		9	SG	Pin no.	Abbreviation	SD	SD	RD	RD	RS	RS	CS	CS	GND	GND		
Pin no.	Abbreviation																																		
1	FG																																		
2	SD																																		
3	RD																																		
4	RS																																		
5	CS																																		
6																																			
7																																			
8																																			
9	SG																																		
Pin no.	Abbreviation																																		
SD	SD																																		
RD	RD																																		
RS	RS																																		
CS	CS																																		
GND	GND																																		

*1 The CS1W-CN225 or CS1W-CN625 cable is required in order to connect a peripheral board.



◆ REFERENCE

For the contents of error codes, please refer to “Error Codes and How to Handle Them” on page 142.

Setting the communication conditions

Setting the communication conditions for the GT main unit

The following settings should be entered for the COM port communication condition settings.

Item	Value Set
Communication speed setting	19200 bits/s
Data length	7 bits
Parity check	Yes, Even
Stop bits	1 bit

Setting the communication conditions for the PLC

The settings on the PLC side are as shown below. Settings cannot be entered for some items, depending on the model, but if a setting cannot be entered, it means that setting is not needed.

Item	Value Set
PLC main unit mode	Monitor mode
Mode setting	Higher-order link
Procedure	1 : N
Communication speed setting	19200 bits/s
Data length	7 bits
Parity check	Yes, Even
Stop bits	1 bit
Station No.	No. 0
CTS specification	Normally on
5 V supply	Not supplied
Communication method	RS232C

For most models of PLCs, the following method can be used for communication, but some items may vary depending on the model. Please refer to the instruction for the PLC being used when entering settings.

Communicating with the RS232C port of the CPU unit

The system areas should be set as indicated below.

Address	Value set	Setting contents
DM6600	0201 (HEX)	PLC main unit mode setting (monitor mode)
DM6645	0001 (HEX)	RS232C port mode setting (higher-order link)
DM6646	0004 (HEX)	Communication conditions settings (19200 bits/s, 7 bits, even, 1 bit)
DM6668	0000 (HEX)	Machine no. setting (Machine No. 0)

Communicating with a communication port

The system areas should be set as indicated below.

Communicating with Port A

Address	Value set	Setting contents
DM6600	0201 (HEX)	PLC main unit mode setting (monitor mode)
DM6550	0001 (HEX)	RS232C port mode setting (higher-order link)
DM6551	0004 (HEX)	Communication conditions settings (19200 bits/s, 7 bits, even, 1 bit)

Communicating with Port B

Address	Value set	Setting contents
DM6600	0201 (HEX)	PLC main unit mode setting (monitor mode)
DM6555	0001 (HEX)	RS232C port mode setting (higher-order link)
DM6556	0004 (HEX)	Communication conditions settings (19200 bits/s, 7 bits, even, 1 bit)

Communicating with a higher-order link interface unit

Always make sure the CPU mode is set to the monitor mode.

The baud rate is set using the DIP switches and rotary switch on the link interface unit. For detailed information, please refer to the instruction manual of the unit being used.

Communicating with a peripheral board

The system areas should be set as indicated below.

Address	Value set	Setting contents
DM6600	0201 (HEX)	PLC main unit mode setting (monitor mode)
DM6550	0001 (HEX)	RS232C port mode setting (higher-order link)
DM6551	0004 (HEX)	Communication conditions settings (19200 bits/s, 7 bits, even, 1 bit)

Devices that can be used

Device type	Address range	Points
Relay area	0000CH to 0252CH	253 words
Data memory area	DM0000 to DM6143	6143 words



◆ NOTES

- Depending on the type being used, the address range may be limited to a small range. Please refer to the instruction manual of the PLC being used for detailed information.
- Data cannot be written to relay areas 253–255CH.

Chapter 5

GT10 Configuration Settings

5.1 GT10 Configuration Settings

Before using the GT10 for the first time, it must be set up by entering the GT10 configuration settings indicated below. Always check and enter the settings under “Basic communication area to PLC”. For instructions on setting up the GT10, see page 29.

5.1.1 Two Types of GT10 Configuration Settings

1. Entering configuration settings from GTWIN screen creation tool . . page 73

With this method, GT10 configuration settings are entered from GTWIN screen creation tool, and the GT10 configuration file is sent to the GT10. Most items can be set using this method.

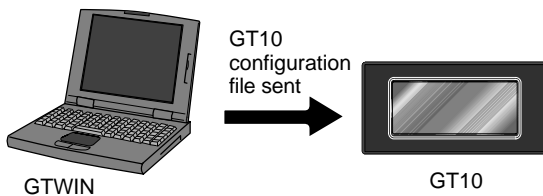

2. Entering configuration settings from the GT10 main unit page 85

Some of the settings, such as the communication parameters, the internal clock, and adjustments of the liquid crystal display contrast, can be set using the system menu of the GT10. Settings are entered using the touch switches on the front of the panel.

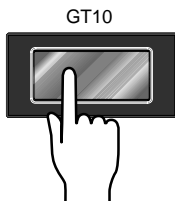

◆ EXPLANATION

Items in the GT10 Configuration Settings

Items that can be set from GTWIN	Items that can be set either way	Items that can be set from the GT10 system menu
Title setting	Communication parameters	Clock division setting for the internal clock
Type of PLC connected		LCD contrast setting
Basic communication area to PLC		Communication parameters
Communication parameters		Memory initialization
Auto-paging screen settings		Self-diagnosis
Startup screen (default screen) settings		
Reference destination setting for clock		
Backlight control		
Touch sounds		
Hold PLC device		
GT internal device hold		

5.2 Entering Configuration Settings with GTWIN

This section describes how configuration settings for the GT10 are entered from GTWIN screen creation tool.

5.2.1 Opening the GT Configuration Settings

The GT configuration settings are set by selecting [Configuration] on the menu displayed by clicking with the mouse on [File] or pressing the Alt + F keys. Then select the “GT Configuration” sub–menu under [Configuration].

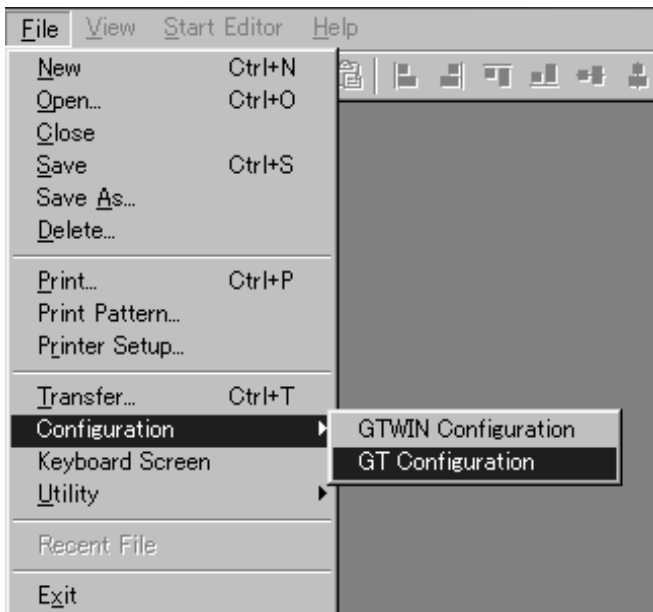

Configuration Settings

GTWIN Configuration — These are operating environment settings for GTWIN.

GT Configuration — These are configuration settings for the GT10. The file is sent from GTWIN to the GT10 after the settings have been entered.

5.2.2 GT Configuration Settings: “Basic Setup”

Selecting [Configuration] on the [File] menu of GTWIN and then the sub–menu [GT Configuration] displays the “Basic Setup” screen shown below.

This is used to specify the basic communication area used for communication between the GT10 and PLC, and the environment required for GT10 operation.

“Basic Setup” screen

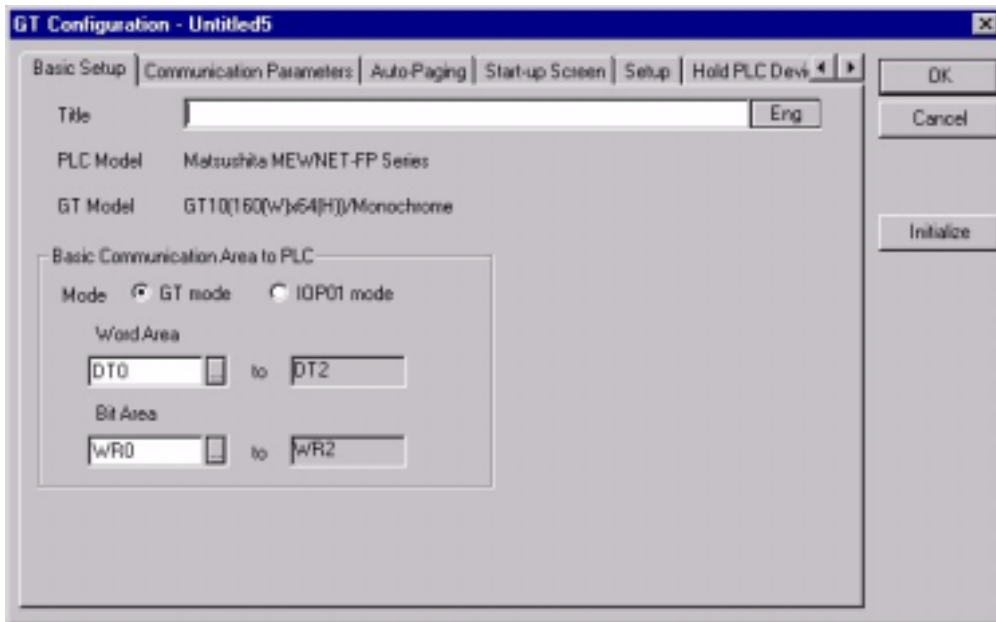

Title — The title of the configuration settings file is entered here. Titles are convenient if each GT10 has its own configuration settings.

PLC Model — The model of PLC specified when GTWIN is booted is displayed here.

GT Model — The model of GT specified when GTWIN is booted is displayed here.

Basic communication area to PLC

This is used to specify the mode in which communication takes place between the GT10 and PLC, and the internal PLC device used for basic communication.

Modes

Turn on the radio button for either “GT10 Mode” or “IOP01 Mode”.

– GT10 Mode — Select this if you are using the GT10 for the first time.

– IOP01 Mode — This mode is for users who are using a conventional model (I.O.P. B01C / M01L / D01TL). If this mode is selected, the basic communication area for communication between the GT10 and PLC is compatible with conventional models for the most part, except for a few items.



◆ REFERENCE

For information on the IOP01 mode, please see page 31, “IOP01 Mode”.

Device used

This specifies the internal PLC device used for basic communication between the GT10 and PLC.

- Word area — This specifies the type of device that reads and writes screen numbers and other information in word units, and the initial address.

- Bit area — This specifies the type of device that reads and writes backlight control and other bit information, and the initial address.

The type of device and addresses can be set by clicking on the  buttons for the various items.

Device settings dialog box

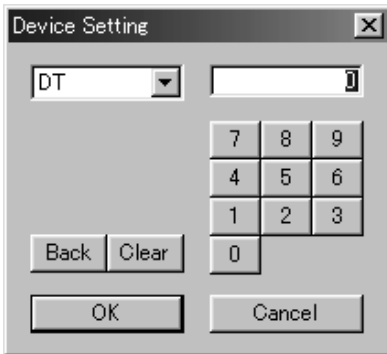

Clicking on the  button displays a pull-down menu. Select the device for which settings are to be entered, and use the ten-keys to enter addresses.

The  button functions as a backspace key when entering addresses.

The  button acts as a Clear key.



◆ REFERENCE

For detailed information on the basic communication area map, see “GT10 Basic Communication Area Map” on page 30.



◆ EXPLANATION

Standard settings

Clicking on the  button in the “GT Configuration” dialog box displays the following message. Clicking on [OK] sets the default values (the configuration settings entered when the unit is shipped) for all of the settings.

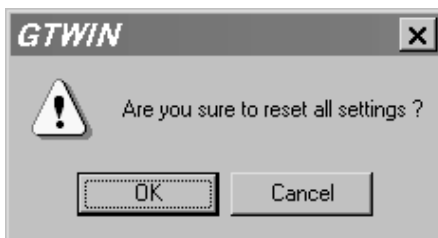

 For information on the contents of configuration settings entered when the unit is shipped, see “Contents of configuration settings for GT10 when shipped from the factory” on page 26.

5.2.3 GT Configuration Settings: “Communication Parameters”

Clicking on the “Communication Parameters” tab in the “GT Configuration” dialog box displays the following screen.

This is where communication parameters for the PLC and personal computer (GTWIN) connected to the GT10 are set.

“Communication Parameters” screen

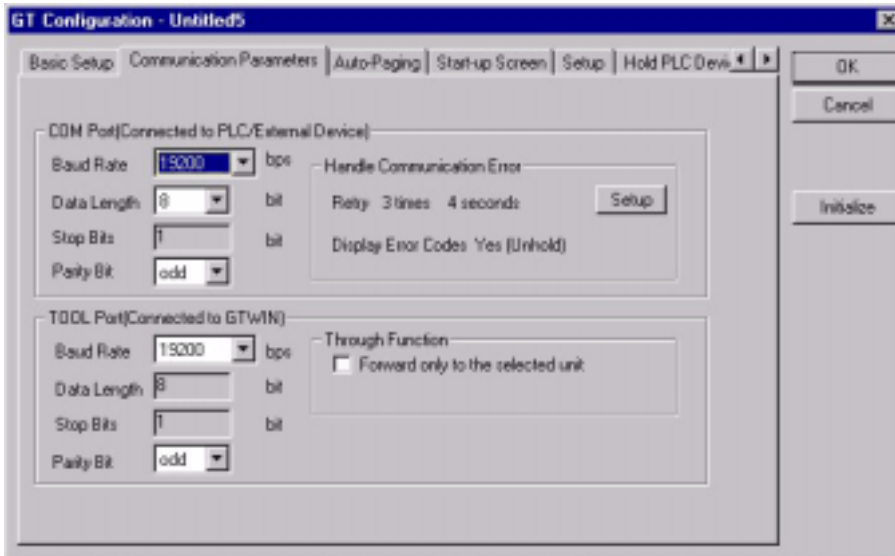

COM. port (Connected to PLC/External Device)

This is used to specify the communication speed and transmission format when the GT10 is connected to an external device (PLC).

Clicking on the  button displays a pull-down menu from which the value to be set can be selected.

- Baud Rate — Select 9600, 19200, 38400, 57600, 76,800 or 115200 bits/s.
- Data Length — Select either “7 bits” or “8 bits”.
- Stop Bits — This is fixed at “1 bit”.
- Parity Bit — Select “None”, “Odd”, or “Even”.

Handle Communication Error

Clicking on the  button displays the “Communication Error Remedy” dialog box. This is used to specify the processing to be used if a communication error occurs.

“Communication Error Remedy” dialog box

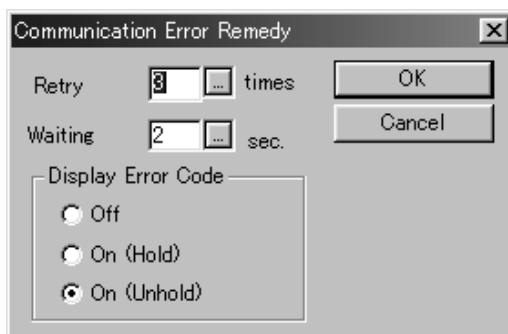

For “Retry” and “Waiting”, click the  button and specify the values in the “Value Set” dialog box that is displayed.

For “Display Error Code”, select “Off”, “On (Hold)”, or “On (Unhold)” by clicking the radio button of the desired value to turn it on.

Retry — This specifies the number of retries if a communication error occurs. The setting range is from 0 to 255 times.

Waiting — This specifies the interval between retries if a communication error occurs. The setting range is from 0 to 255 seconds.

“Display Error Code”

This switches the setting for the error code display used if a communication error occurs.

Off — No error code is displayed if a communication error occurs.

On (Hold) — An error code is displayed at the upper right of the screen if a communication error occurs, and continues to be displayed until the power supply is turned off.

On (Unhold) — An error code is displayed at the upper right of the screen if a communication error occurs, and is cleared when the cause of the error is eliminated.

 For contents of error codes, please see “Error Codes and How to Handle Them” on page 142.

TOOL Port (for GTWIN connection)

This is used to specify the communication speed and transmission format when the GT10 is connected to a personal computer (GTWIN).

Clicking on the  button displays a pull-down menu from which the value to be set can be selected.

- Baud Rate — Select 9600, 19200 or 115200 bits/s.
- Data Length — This is fixed at “8 bits”.
- Stop Bits — This is fixed at “1 bit”.
- Parity Bit — Select “None”, “Odd”, or “Even”.

Through function

If the “Forward only to the selected unit” check box is turned on, communication can be carried out via the through function only with unit numbers for a PLC received from a higher-order personal computer or higher-order PLC.

5.2.4 GT Configuration Settings: “Auto-Paging”

Clicking on “Auto-Paging” in the “GT Configuration” dialog box displays the screen shown below. Here, settings can be entered for a function that automatically switches the screens displayed on the GT10.

“Auto-Paging” screen

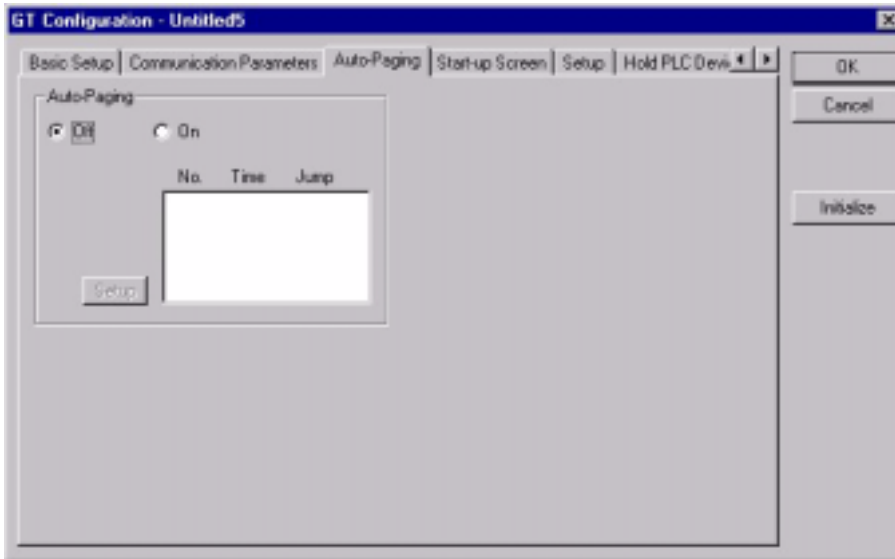

Auto-paging

This is used to specify the “Auto-paging function”, which automatically switches the specified screen when a given period of time has elapsed.

Off — The screen is not switched automatically.

On — The screen is switched automatically, in conformance with the specified contents.

Auto-paging settings

If “On” is selected for auto-paging, and the [Setup] button is clicked, a dialog box containing the following auto-paging settings is displayed.

Clicking on the button for “Screen No.”, “Time”, or “Jump to” displays a “Value Set” dialog box. Set the value and click the [Save] button to save values one at a time.

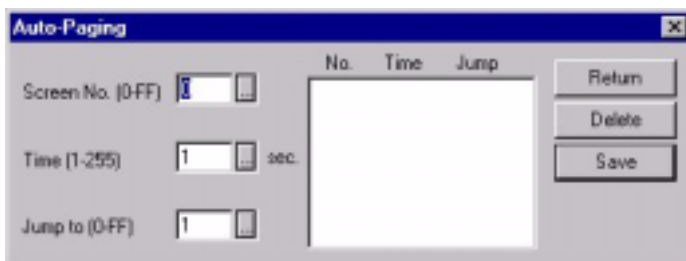

Screen No. — This specifies the screen targeted for auto-paging.

Time — This specifies the time for which the screen specified above is displayed. The setting range is from 1 to 255 seconds.

Jump to — This specifies the number of the next screen to be displayed.

[Return] — This completes the auto-paging settings and returns to the “Auto-Paging” dialog box.

[Delete] — This deletes screens registered for auto-paging.

[Save] — This saves the settings for the screen number, time, and jump destination as auto-paging settings.

5.2.5 GT Configuration Settings: “Startup Screen Settings”

Clicking on “Start-up Screen” in the “GT Configuration” dialog box displays the screen shown below. Here, the screen displayed when the GT10 is booted can be specified.

“Start-up Screen” screen

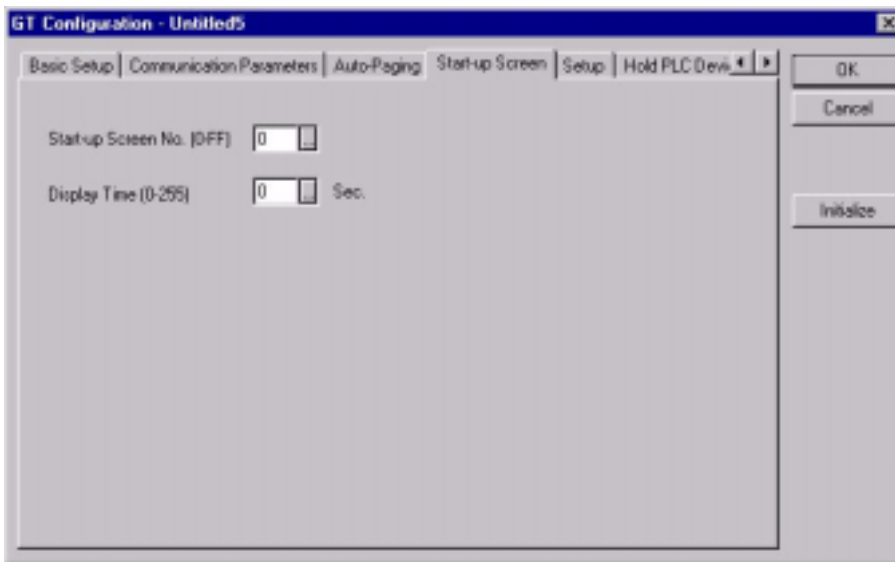

This is used to specify the screen that will be displayed when the GT10 is booted, as well as the time it will be displayed. Clicking on the button for each of the items displays a “Value Set” dialog box where the values can be specified.

Start-up Screen No. — This specifies the number of the screen that will be displayed when the GT10 is booted. Clicking on the button displays a “Value Set” dialog box where the value for the start-up screen number can be specified.

Display Time — This specifies the time for which the startup screen specified above will be displayed. The value can be set to any number between 0 and 255 seconds. Clicking on the button displays a “Value Set” dialog box where the start-up delay time can be specified.



◆ KEY POINTS

- When the above settings are entered, the screen specified with the “Startup Screen No.” parameter is displayed for the amount of time specified with the “Display Time” parameter.
- When the amount of time specified with the “Display Time” parameter elapses, the screen corresponding to the number stored

in the initial address of the word device under “Basic Communication Area to PLC” in the “Basic Setup” parameters under “GT Configuration” will be displayed.

- This function is used when it is necessary to delay the start-up time when the power supply on the PLC side is turned on.



CAUTION

- Communication between the GT10 and the PLC (external device) cannot be carried out during the time specified by the “Display Time” parameter.

5.2.6 GT Configuration Settings: “Setup”

Clicking on the “Setup” tab in the “GT Configuration” dialog box displays the screen shown below. Here, clock functions, backlight control, and other parameters can be specified.

“Setup” screen

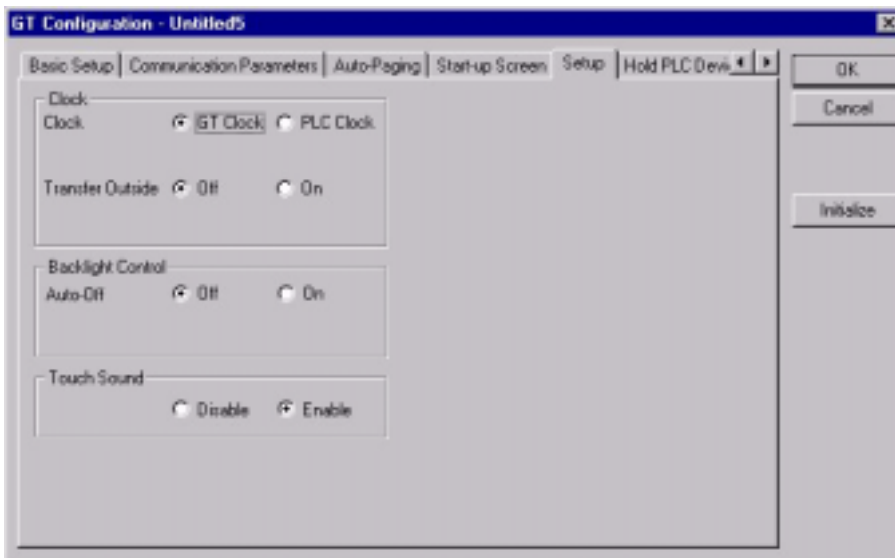

Clock

This is used to specify the reference destination for the clock displayed with the GT10. Select one of the radio buttons.

GT Clock — When the time is displayed, the internal clock in the GT10 is used as a reference for the value.

PLC Clock — When the time is displayed, the internal clock in the PLC is used as a reference for the value.

If the “PLC Clock” is referenced for the clock setting, clicking on the  button displays a screen where the type of device and the address can be specified.

Device Setting dialog box



Click on the  button to display the pull-down menu, and select the device from that menu. Enter the address using the ten-keys.

The  button functions as a backspace key when entering addresses.

The  button acts as a Clear key.

Transfer Outside

Clock data displayed in the GT10 can be transferred to an external device such as a PLC, using this setting.

Off — The GT10 clock data is not transferred to an external device.

On — The GT10 clock data is transferred to an external device.

If “On” is selected for the above “Transfer Outside” parameter, click on the  button to specify the output destination and the initial device, and specify the address.

Data storage sequence for internal PLC device

	Upper byte	Lower byte
Top address	Minutes data (H00 to H59)	Second data (H00 to H59)
Top address +1	Day data (H01 to H31)	Hour data (H00 to H23)
Top address +2	Year data (H00 to H99)	Month data (H01 to H12)
Top address +3	—	Day data (H00 to H06)

* In the day data, H00 indicates Sunday and H06 indicates Saturday.



If “On” is selected for the “Transfer Outside” parameter, the data will be transferred to the DT90054 as the default device. If this device address does not exist in the PLC connected to the GT10, however, re-specify the address so that it matches the model connected to the GT10.

Selecting a device address that does not exist in the PLC will cause an error (ER61) to occur.

Backlight control

Auto-Off

This is used to specify the Auto-Off backlight feature.

Off — The Auto-Off backlight feature is not used.

On — Auto-Off backlight feature is used. This parameter specifies the period of time that the GT10 is inactive before the backlight goes off automatically.

If “On” is set for the above Auto–Off backlight feature, clicking on the  button displays a screen where the time until the backlight goes off can be specified. Any time from one minute to 30 minutes can be specified.



◆ KEY POINTS

If the backlight is turned off automatically using the backlight control function, touching the screen turns it on again. If a touch switch happens to be located at that point on the screen, it will be invalid until the backlight has gone on again.

Touch Sounds

This sets the touch sounds corresponding to GT10 screens as either invalid or valid. Select one of the radio buttons.

Disable — Touch sounds are disabled.

Enable — Touch sounds are enabled.

5.2.7 GT Configuration Settings: “Hold PLC Device”

Clicking on the “Hold PLC Device” tab in the “GT Configuration” dialog box displays the screen shown below. “Hold PLC Device” is a function that enables internal PLC device values to be held on the GT10 side.

“Hold PLC Device” screen

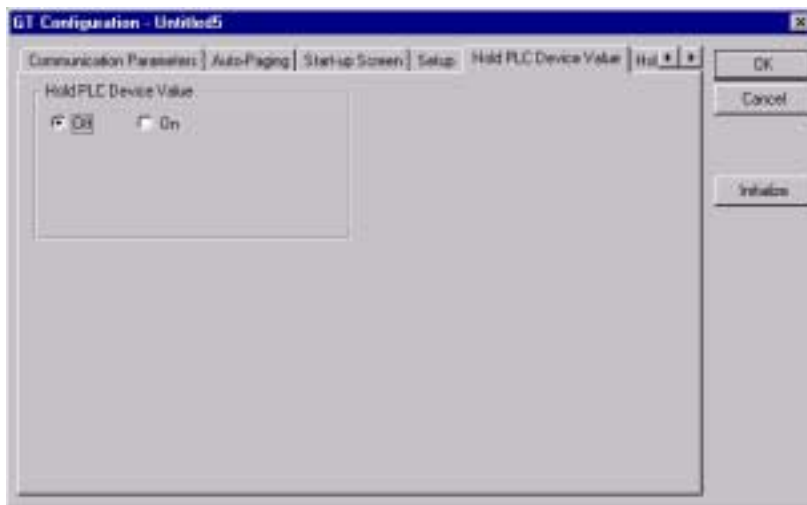

Hold PLC Device

The Hold PLC Device function reads the values for the specified internal PLC device to the SRAM in the GT10, and backs up the values.

Off — PLC devices are not held.

On — PLC devices are held (up to 24 words)

If “On” is selected for the above Hold PLC Device setting, “Device” and “Number of Word” parameters are displayed. Clicking on the  button displays a dialog box like

that shown below, where the type of initial device, the address, and the number of words can be specified.

Device Setting dialog box

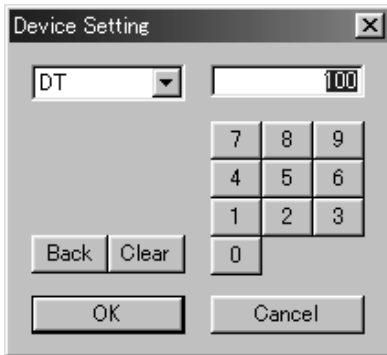

Click on the  button to display the pull-down menu, and select the device from that menu. Enter the address using the ten-keys.

The **Back** button functions as a backspace key when entering addresses.

The **Clear** button acts as a Clear key.



CAUTION

- Data for PLC devices held in the GT10 will be written to the internal PLC device the next time that the power supply is turned on.
- If the power supply on the GT10 side is not turned on, the data can be held for the period of time that the backup with the internal secondary battery is effective. For information on the internal secondary battery specifications, see “What the Internal Secondary Battery Does” on page 128.

5.2.8 GT Configuration Settings: “GT Internal Device Hold”

Clicking on the “GT Internal Device Hold” tab in the “GT Configuration Settings” dialog box displays the screen shown below. “GT Internal Device Hold” is a function that holds the values for an internal device (GDT or GWR) in the GT main unit.

“GT internal device hold” screen



GT internal device hold

“GT Internal Device Hold” is a function that backs up the values for an internal device (GWR or GDT) in the GT main unit.

Data registers

Don't hold . . . The GT internal device hold function is turned off.

Hold The GT internal device hold function is turned on.

Internal relays

Don't hold . . . The GT internal device hold function is turned off.

Hold The GT internal device hold function is turned on.

If the above setting for the GT internal device hold function is set to "Hold", a "Start No." item is displayed. Click on the  button to display the value setting dialog box shown below, and specify a starting number. After the setting has been entered, the contents of any addresses subsequent to the specified value will be held.

Value setting dialog box



Enter the starting number, using the ten-key pad.

The  button functions as a backspace key when entering addresses.

The  button acts as a Clear key.



◆ KEY POINTS

GT internal devices

Device type		Address range	Points
Memory	Data register	GDT0000 to GDT2047	2048 words
	Internal relay	WGR0000 to WGR0255	256 words
Bits	Internal relay	GR0000 to GR255F	4096 points

* The WGR and GR are the same memory, but in the WGR, bits are handled in word units.

5.3 Entering Configuration Settings from the GT10

5.3.1 What is the System Menu?

The system menu is a dedicated screen on which configuration settings for the GT10 are entered. Some of the items that can be specified here can also be set using GTWIN screen creation tool and then sent to the GT10, but others, such as the internal clock and adjustments to the LCD contrast level, can only be set using the system menu. This section explains how configuration settings are entered using the system menu.

5.3.2 Bringing Up the System Menu

The following procedure is used to bring up the system menu.

(1) Touch the four corners of the LCD touch panel simultaneously.

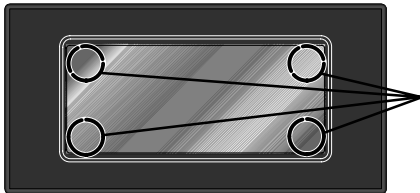

Touch these four corners at the same time, and continue pressing them for about one second.

(2) The initial screen of the system menu is displayed.

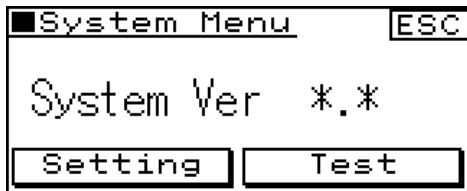

. indicates the ROM version of the GT10 system.

The initial screen of the system menu is displayed on the GT10. Touching either the [Setting] or [Test] key shifts to the next screen.

Touching the [ESC] key exits the system menu and returns to the normal operating mode.

(3) Select the mode.

[Setting]: Setting mode initial screen

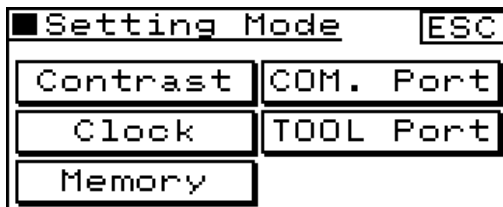

This is where configuration settings for the GT10, such as the contrast, clock, COM. port, TOOL port, and memory, are specified.

[Test]: Test mode initial screen

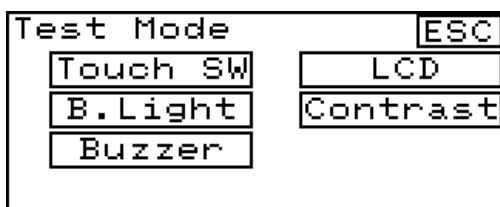

This is where GT10 configuration elements such as the touch switches, backlight, clock, buzzer, LCD, contrast, and memory are tested.

5.3.3 Setting Mode: “Communication Parameters” (COM. Port / TOOL Port)

Touching the [Setting] key on the initial screen of the system menu and then touching the [COM. Port] and [TOOL Port] keys on the setting mode menu displays the communication parameters setting screen. Here, parameters controlling the communication between the PLC and personal computer (GTWIN) connected to the GT10 are specified.

COM. port communication parameter settings (PLC communication parameter settings)

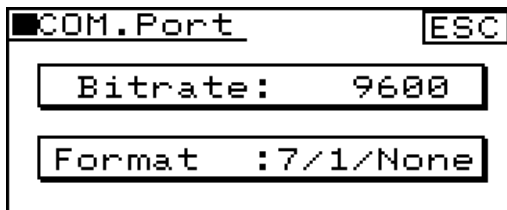

Procedure for bringing up the screen
[Initial screen]
↓
[Setting]
↓
[COM. port]

Bitrate: PLC communication speed

This sets the communication speed, or Baud rate, for communication with an external device (PLC) connected to the GT10.

Each time the [Function] key is pressed, the Baud rate switches in the sequence of 9600, 19200, 38400, 57600, 76800, 115200 bits/s. Set the speed to match that of the PLC connected to the GT10.

Format: Transmission format

This sets the communication parameters (data length, stop bits, parity) for the external device (PLC) connected to the GT10.

The items displayed are: Data length / Stop bit / Parity, and each time the [Function] key is pressed, the display switches in the sequence of: [7/1/None], [7/1/Odd], [7/1/Even], [8/1/None], [8/1/Odd], [8/1/Even]. Set the parameters to match those of the PLC connected to the GT10.



◆ SHORTCUTS

[RETURN] To complete the settings and return to the previous screen, touch the [ESC] key.



◆ EXPLANATION

COM. port communication parameter settings

The default (initial) values for the COM. port communication parameter settings are: 19200 bits/s, 8/1/Odd.

TOOL Port communication parameter settings (GTWIN communication parameter settings)

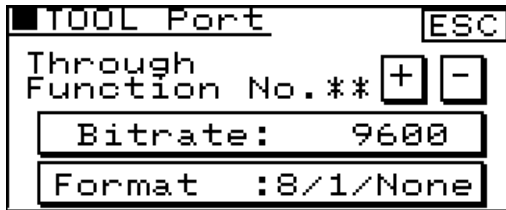

Procedure for bringing up the screen

[Initial screen]



[Setting]



[TOOL Port]

Through function: Through function destination setting

When the through function is being used, this specifies the number of the PLC at the other end of the connection. Normally, when used in a 1 : 1 configuration, this should be set to "00".

Bitrate: GTWIN communication speed

Each time the [Function] key is touched, the Baud rate switches in the sequence of 9600/19200/115200 bits/s. Set the speed to match that of the personal computer (GTWIN) connected to the GT10.

Format: Transmission format

This sets the communication parameters (data length, stop bits, parity) for the personal computer (GTWIN) connected to the GT10.

The items displayed are: Data length / Stop bit / Parity, and each time the [Function] key is pressed, the display switches in the sequence of: [8/1/None], [8/1/Odd], [8/1/Even].



◆ SHORTCUTS

[RETURN] To complete the settings and return to the previous screen, touch the [ESC] key.



◆ EXPLANATION

TOOL Port communication parameter settings

The default (initial) values for the TOOL Port communication parameter settings are: 19200 bits/s, 8/1/Odd.

5.3.4 Setting Mode: "Liquid Crystal Display Contrast Adjustment" (Contrast)

Touching [Setting] on the initial screen of the system menu and then the [Contrast] key of the setting mode menu displays the contrast adjustment screen. The contrast of the GT10 LCD is adjusted here.

Contrast adjustment screen

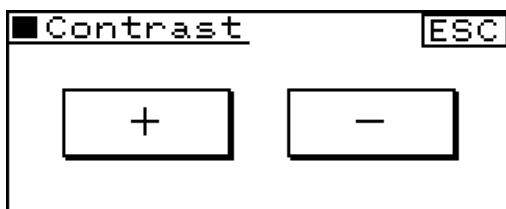

Procedure for bringing up the screen

[Initial screen]



[Setting]



[Contrast]



◆ SHORTCUTS

[ADJUST] Touching the **[+]** key increases the contrast, and touching the **[-]** key decreases it.

[RETURN] To complete the settings and return to the previous screen, touch the **[ESC]** key.

5.3.5 Setting Mode: “Clock Settings” (Clock)

Touching **[Setting]** on the initial screen of the system menu and then the **[Clock]** key of the setting mode menu displays the clock setting screen. The internal clock of the GT10 is set here.

Clock setting screen

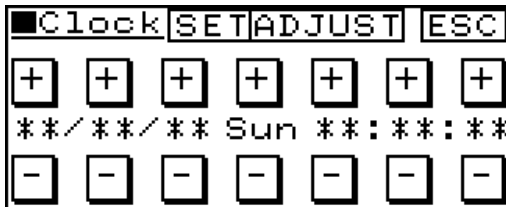

Procedure for bringing up the screen

[Initial screen]



[Setting]



[Clock]

The time displayed on the screen is the current time indicated by the internal clock of the GT10. Items can be changed by touching the item (year, month, day, date, hour, minute, second) and touching the **[+]** and **[-]** keys to change the values.



◆ SHORTCUTS

[ADJUST] Touching the **[+]** key increases the value, and touching the **[-]** key decreases it.

[SET] Touching the **[SET]** key updates the Value Set and restarts the clock. Touching the **[ADJUST]** key sets the seconds value of the current time to “00”. A seconds value of 0 to 29 is rounded off to the next lower value, and a seconds value of 30 to 59 is rounded off to the next upper value.



◆ EXAMPLE

If the time is set to 12 (hours) : 35 (minutes) : 29 (seconds)

→ 12 (hour) : 35 (minute) : 00 (seconds)

If the time is set to 12 (hours) : 35 (minutes) : 30 (seconds)

→ 12 (hour) : 36 (minute) : 00 (seconds)

[RETURN] To complete the settings and return to the previous screen, touch the **[ESC]** key.

5.3.6 Setting Mode: “Memory Initialization” (Clear Memory)

Touching [Setting] on the initial screen of the system menu and then the [Memory] key of the setting mode menu displays the memory initialization screen. The internal user memory of the GT10 is initialized here.

Memory initialization screen

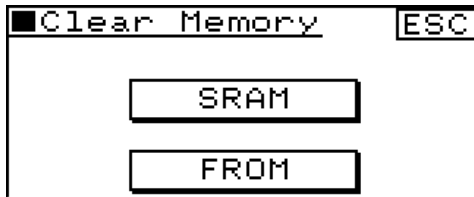

Procedure for bringing up the screen
 [Initial screen]
 ↓
 [Setting]
 ↓
 [Memory]

Touching the [SRAM] key deletes clock data and Hold PLC Device data held in the SRAM.

Touching the [FROM] key deletes screen data and main unit configuration settings saved to the main unit user memory (F–ROM).

When either of the above keys is touched, a confirmation message reading **CLEAR OK?** is displayed. To clear the data, touch the **CLEAR OK?** key. A buzzer sounds, and the memory is cleared. When the buzzer stops sounding, the memory has been completely cleared.



◆ SHORTCUTS

[RETURN] To complete the settings and return to the previous screen, touch the **[ESC]** key.



◆ CAUTION

- **[SRAM]** initialization deletes the Hold PLC Device data backed up in the SRAM. Please be sure that you want to do this before initializing the SRAM.
- **[FROM]** initialization deletes the base screen data, the main unit configuration setting data (the main unit configuration setting data returns to the default values) and contrast adjustment setting data (the contrast returns to the default value) in the user memory (F–ROM) of the main unit. Before initializing the F–ROM, always save screen data to a floppy disk or another medium with GTWIN.

5.3.7 Test Mode: “Self–Diagnosis”

Touching the [Test] key on the initial screen of the system menu displays the self–diagnosis screen. This is used to run a hardware check of the memory, buzzers, and other elements of the GT10.

Test mode screen

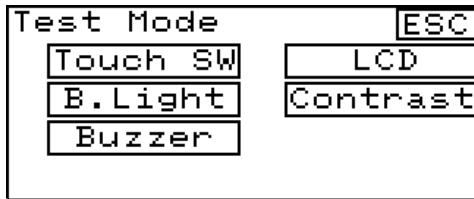

Procedure for bringing up the screen
 [Initial screen]
 ↓
 [Test] key

Touch SW

This runs an operation check of the touch switches.

B. Light

The color of the backlight changes at one-second intervals (in sequence from green a red a green a orange).

Buzzer

This runs an operation check of the buzzer.

LCD

This displays a pattern and runs an operation check of the display.

Contrast

Touch the [+] and [-] keys to check changes in the contrast.

◆ **SHORTCUTS**

[RETURN] To complete the settings and return to the previous screen, touch the [ESC] key.

◆ **EXPLANATION**

- **Test mode (self-diagnosis) screen**
 On the Test Mode screen, a dot appears next to the key switches of items that have been tested. (The dots are cleared when the screen is returned to the initial screen of the system menu.)

5.3.8 Inhibiting the System Menu Display

In order to prevent unauthorized persons from being able to change GT10 configuration settings, the GT10 is set up so that DIP switches can be used to make it impossible to display the system menu. Operation mode setting switches

If the second operation mode setting switch is turned on, as shown at the left, access to the system menu is denied.

Operation mode setting switches

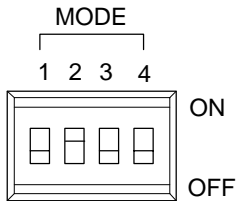

Switch no.	Function	OFF	ON
1	SRAM backup using secondary battery	No	Yes
2	Inhibits system menu shift	Shift possible	Shift inhibited
3	Usage inhibited	Should always be in the "OFF" position when unit is used.	
4			

Chapter 6

GT30 Configuration Settings

6.1 GT30 Configuration Settings

Before using the GT30 for the first time, it must be set up by entering the GT30 configuration settings indicated below. Always check and enter the settings under “Basic communication area to PLC”. For instructions on setting up the GT30, see page 37.

6.1.1 Two Types of GT30 Configuration Settings

1. Entering configuration settings from GTWIN screen creation tool . page 95

With this method, GT30 configuration settings are entered from GTWIN screen creation tool, and the GT30 configuration file is sent to the GT30. Most items can be set using this method.

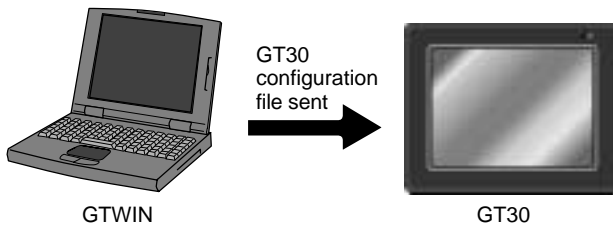

2. Entering configuration settings from the GT30 main unit page 108

Some of the settings, such as the communication parameters, the internal clock, and adjustments of the liquid crystal display contrast, can be set using the system menu of the GT30. Settings are entered using the touch switches on the front of the panel.



◆ EXPLANATION

Items in the GT30 Configuration Settings

Items that can be set from GTWIN	Items that can be set either way	Items that can be set from the GT30 system menu
Title setting	Communication parameters	Clock division setting for the internal clock
Type of PLC connected		LCD contrast setting
Basic communication area to PLC		Communication parameters
Communication parameters		Memory initialization
Auto-paging screen settings		Self-diagnosis
Startup screen (default screen) settings		
Reference destination setting for clock		
Backlight control		
Touch sounds		
Hold PLC device		
GT internal device hold		

6.2 Entering Configuration Settings with GTWIN

This section describes how configuration settings for the GT30 are entered from GTWIN screen creation tool.

6.2.1 Opening the GT Configuration Settings

The GT configuration settings are set by selecting [Configuration] on the menu displayed by clicking with the mouse on [File] or pressing the Alt + F keys. Then select the “GT Configuration” sub–menu under [Configuration].

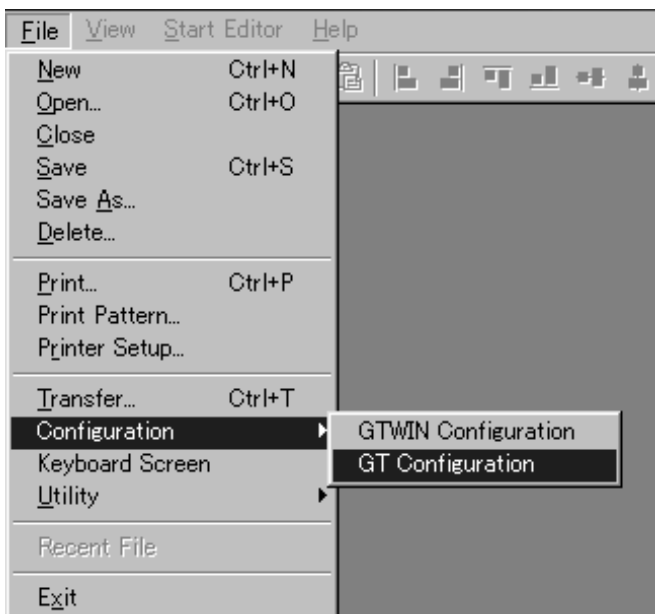

Configuration Settings

GTWIN Configuration — These are operating environment settings for GTWIN.

GT Configuration — These are configuration settings for the GT30. The file is sent from GTWIN to the GT30 after the settings have been entered.

6.2.2 GT Configuration Settings: “Basic Setup”

Selecting [Configuration] on the [File] menu of GTWIN and then the sub–menu [GT Configuration] displays the “Basic Setup” screen shown below.

This is used to specify the basic communication area used for communication between the GT30 and PLC, and the environment required for GT30 operation.

“Basic Setup” screen

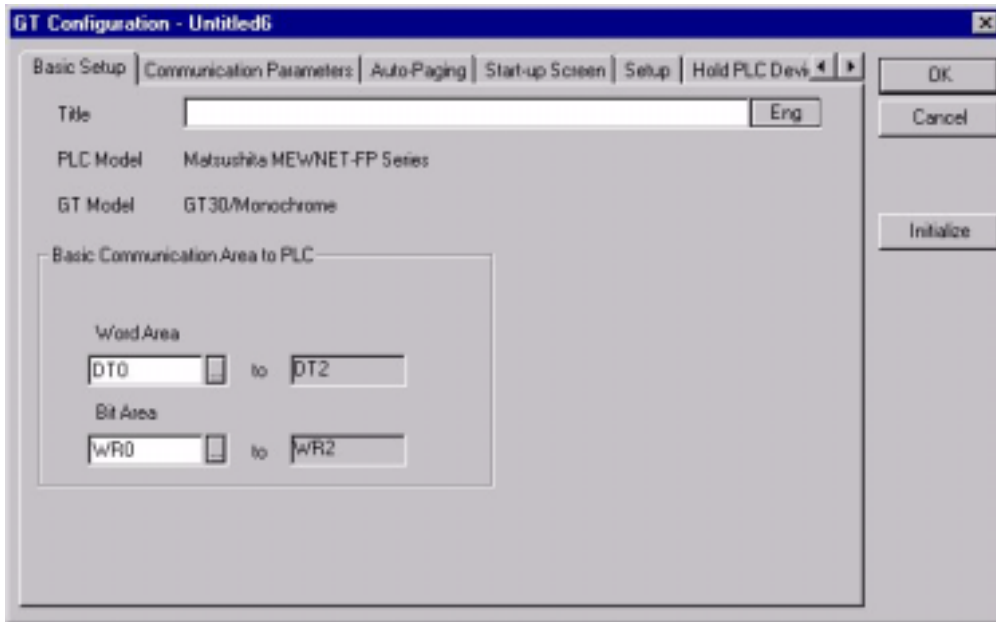

Title — The title of the configuration settings file is entered here. Titles are convenient if each GT30 has its own configuration settings.

PLC Model — The model of PLC specified when GTWIN is booted is displayed here.

GT Model — The model of GT specified when GTWIN is booted is displayed here.

Basic communication area to PLC

The following explains how to specify a device in the PLC to be used for basic communication between the GT30 and the PLC.

Device used

This specifies the internal PLC device used for basic communication between the GT30 and PLC.

- **Word area** — This specifies the type of device that reads and writes screen numbers and other information in word units, and the initial address.
- **Bit area** — This specifies the type of device that reads and writes backlight control and other bit information, and the initial address.

The type of device and addresses can be set by clicking on the buttons for the various items.

Device settings dialog box

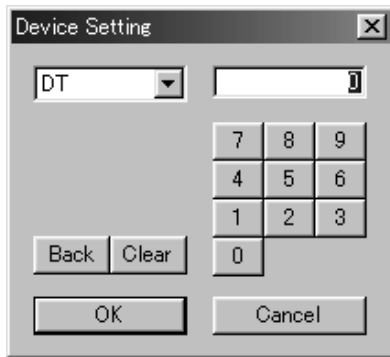

Clicking on the  button displays a pull-down menu. Select the device for which settings are to be entered, and use the ten-keys to enter addresses.

The  button functions as a backspace key when entering addresses.

The  button acts as a Clear key.



◆ REFERENCE

For detailed information on the basic communication area map, see “GT30 Basic Communication Area Map” on page 38.



◆ EXPLANATION

Standard settings

Clicking on the  button in the “GT Configuration” dialog box displays the following message. Clicking on [OK] sets the default values (the configuration settings entered when the unit is shipped) for all of the settings.

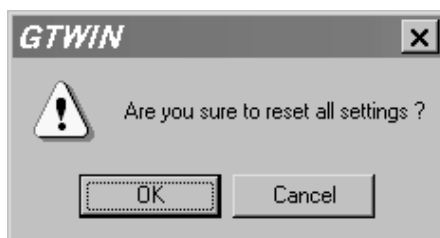

 For information on the contents of configuration settings entered when the unit is shipped, see “Contents of configuration settings for GT30 when shipped from the factory” on page LEERER MERKER.

6.2.3 GT Configuration Settings: “Communication Parameters”

Clicking on the “Communication Parameters” tab in the “GT Configuration” dialog box displays the following screen.

This is where communication parameters for the PLC and personal computer (GTWIN) connected to the GT30 are set.

“Communication Parameters” screen

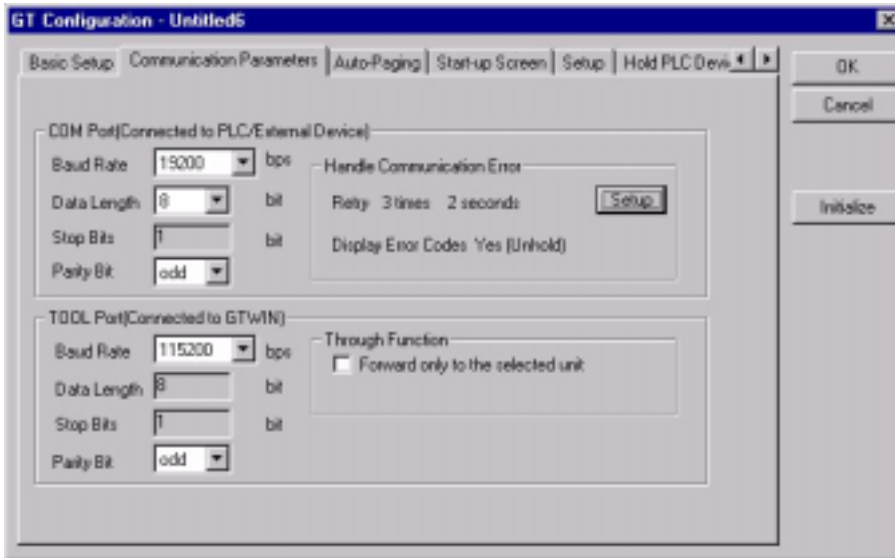

COM. port (Connected to PLC/External Device)

This is used to specify the communication speed and transmission format when the GT30 is connected to an external device (PLC).

Clicking on the  button displays a pull-down menu from which the value to be set can be selected.

- Baud Rate — Select 9600, 19200, 38400, 57600 or 115200 bits/s.
- Data Length — Select either “7 bits” or “8 bits”.
- Stop Bits — This is fixed at “1 bit”.
- Parity Bit — Select “None”, “Odd”, or “Even”.

Handle Communication Error

Clicking on the  button displays the “Communication Error Remedy” dialog box. This is used to specify the processing to be used if a communication error occurs.

“Communication Error Remedy” dialog box

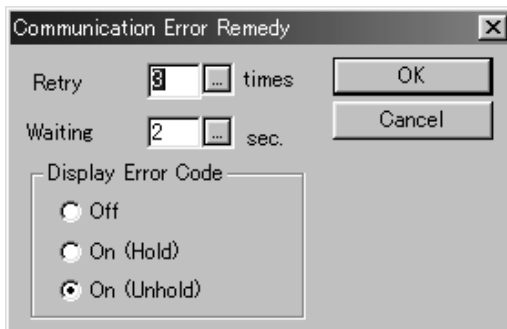

For “Retry” and “Waiting”, click the  button and specify the values in the “Value Set” dialog box that is displayed.

For “Display Error Code”, select “Off”, “On (Hold)”, or “On (Unhold)” by clicking the radio button of the desired value to turn it on.

Retry — This specifies the number of retries if a communication error occurs. The setting range is from 0 to 255 times.

Waiting — This specifies the interval between retries if a communication error occurs. The setting range is from 0 to 255 seconds.

“Display Error Code”

This switches the setting for the error code display used if a communication error occurs.

Off — No error code is displayed if a communication error occurs.

On (Hold) — An error code is displayed at the upper right of the screen if a communication error occurs, and continues to be displayed until the power supply is turned off.

On (Unhold) — An error code is displayed at the upper right of the screen if a communication error occurs, and is cleared when the cause of the error is eliminated.

 For contents of error codes, please see “Error Codes and How to Handle Them” on page 142.

TOOL Port (for GTWIN connection)

This is used to specify the communication speed and transmission format when the GT30 is connected to a personal computer (GTWIN).

Clicking on the  button displays a pull-down menu from which the value to be set can be selected.

- Baud Rate — Select 9600, 19200 or 115200 bits/s.
- Data Length — This is fixed at “8 bits”.
- Stop Bits — This is fixed at “1 bit”.
- Parity Bit — Select “None”, “Odd”, or “Even”.

Through function

If the “Forward only to the selected unit” check box is turned on, communication can be carried out via the through function only with unit numbers for a PLC received from a higher-order personal computer or higher-order PLC.

6.2.4 GT Configuration Settings: “Auto-Paging”

Clicking on “Auto-Paging” in the “GT Configuration” dialog box displays the screen shown below. Here, settings can be entered for a function that automatically switches the screens displayed on the GT30.

“Auto-Paging” screen

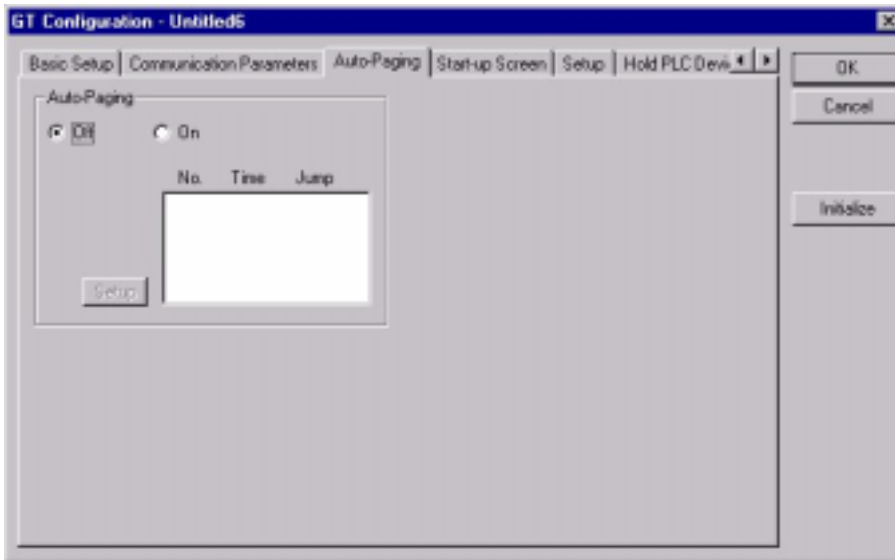

Auto-paging

This is used to specify the “Auto-paging function”, which automatically switches the specified screen when a given period of time has elapsed.

Off — The screen is not switched automatically.

On — The screen is switched automatically, in conformance with the specified contents.

Auto-paging settings

If “On” is selected for auto-paging, and the [Setup] button is clicked, a dialog box containing the following auto-paging settings is displayed.

Clicking on the button for “Screen No.”, “Time”, or “Jump to” displays a “Value Set” dialog box. Set the value and click the [Save] button to save values one at a time.

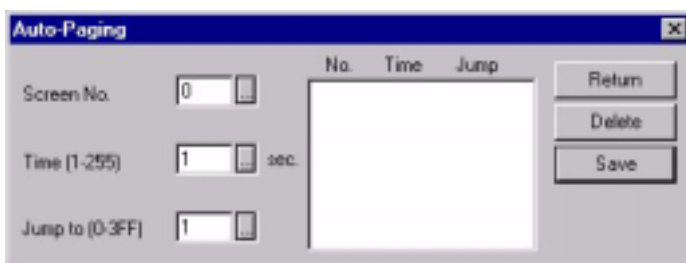

Screen No. — This specifies the screen targeted for auto-paging.

Time — This specifies the time for which the screen specified above is displayed. The setting range is from 1 to 255 seconds.

Jump to — This specifies the number of the next screen to be displayed.

[Return] — This completes the auto-paging settings and returns to the “Auto-Paging” dialog box.

[Delete] — This deletes screens registered for auto-paging.

[Save] — This saves the settings for the screen number, time, and jump destination as auto-paging settings.

6.2.5 GT Configuration Settings: “Startup Screen Settings”

Clicking on “Start-up Screen” in the “GT Configuration” dialog box displays the screen shown below. Here, the screen displayed when the GT30 is booted can be specified.

“Start-up Screen” screen

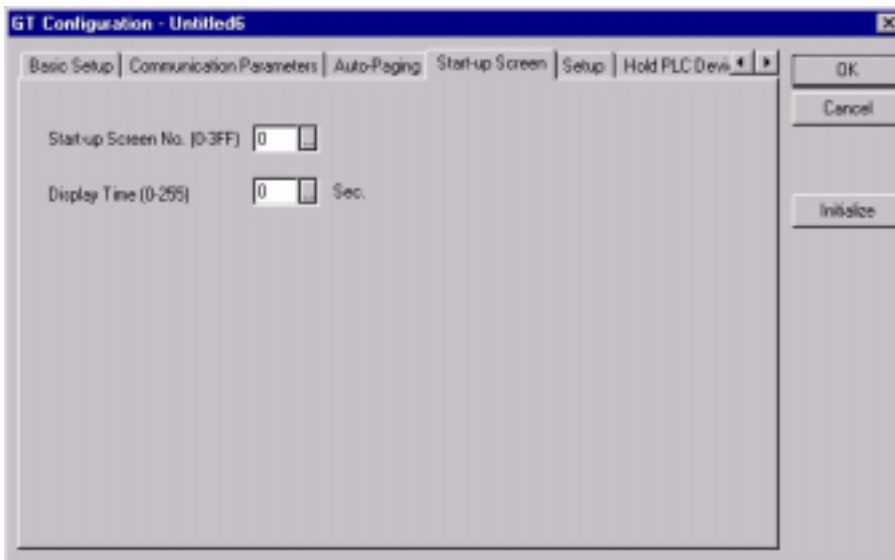

This is used to specify the screen that will be displayed when the GT30 is booted, as well as the time it will be displayed. Clicking on the button for each of the items displays a “Value Set” dialog box where the values can be specified.

Start-up Screen No. — This specifies the number of the screen that will be displayed when the GT30 is booted. Clicking on the button displays a “Value Set” dialog box where the value for the start-up screen number can be specified.

Display Time — This specifies the time for which the startup screen specified above will be displayed. The value can be set to any number between 0 and 255 seconds. Clicking on the button displays a “Value Set” dialog box where the start-up delay time can be specified.



◆ KEY POINTS

- When the above settings are entered, the screen specified with the “Startup Screen No.” parameter is displayed for the amount of time specified with the “Display Time” parameter.
- When the amount of time specified with the “Display Time” parameter elapses, the screen corresponding to the number stored

in the initial address of the word device under “Basic Communication Area to PLC” in the “Basic Setup” parameters under “GT Configuration” will be displayed.

- This function is used when it is necessary to delay the start-up time when the power supply on the PLC side is turned on.



◆ CAUTION

- Communication between the GT30 and the PLC (external device) cannot be carried out during the time specified by the “Display Time” parameter.

6.2.6 GT Configuration Settings: “Setup”

Clicking on the “Setup” tab in the “GT Configuration” dialog box displays the screen shown below. Here, clock functions, backlight control, and other parameters can be specified.

“Setup” screen

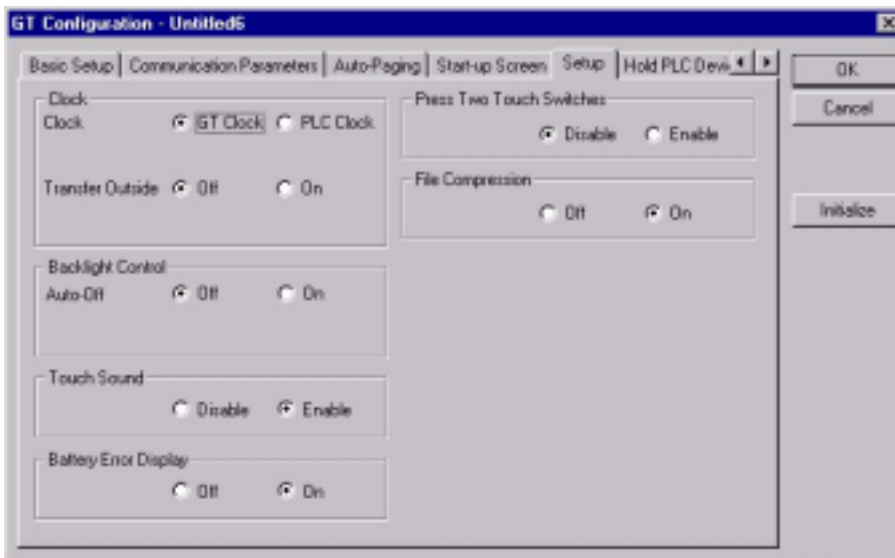

Clock

Clock

This is used to specify the reference destination for the clock displayed with the GT30. Select one of the radio buttons.

GT Clock — When the time is displayed, the internal clock in the GT30 is used as a reference for the value.

PLC Clock — When the time is displayed, the internal clock in the PLC is used as a reference for the value.

If the “PLC Clock” is referenced for the clock setting, clicking on the  button displays a screen where the type of device and the address can be specified.

Device Setting dialog box



Click on the  button to display the pull-down menu, and select the device from that menu. Enter the address using the ten-keys.

The  button functions as a backspace key when entering addresses.

The  button acts as a Clear key.

Transfer Outside

Clock data displayed in the GT30 can be transferred to an external device such as a PLC, using this setting.

Off — The GT30 clock data is not transferred to an external device.

On — The GT30 clock data is transferred to an external device.

If “On” is selected for the above “Transfer Outside” parameter, click on the  button to specify the output destination and the initial device, and specify the address.

Data storage sequence for internal PLC device

	Upper byte	Lower byte
Top address	Minutes data (H00 to H59)	Second data (H00 to H59)
Top address +1	Day data (H01 to H31)	Hour data (H00 to H23)
Top address +2	Year data (H00 to H99)	Month data (H01 to H12)
Top address +3	—	Day data (H00 to H06)

*In the day data, H00 indicates Sunday and H06 indicates Saturday.



CAUTION

If “On” is selected for the “Transfer Outside” parameter, the data will be transferred to the DT90054 as the default device. If this device address does not exist in the PLC connected to the GT30, however, re-specify the address so that it matches the model connected to the GT30.

Selecting a device address that does not exist in the PLC will cause an error (ER61) to occur.

Backlight control

Auto-Off

This is used to specify the Auto-Off backlight feature.

Off — The Auto-Off backlight feature is not used.

On — Auto-Off backlight feature is used. This parameter specifies the period of time that the GT30 is inactive before the backlight goes off automatically.

If “On” is set for the above Auto–Off backlight feature, clicking on the  button displays a screen where the time until the backlight goes off can be specified. Any time from one minute to 30 minutes can be specified.



◆ KEY POINTS

If the backlight is turned off automatically using the backlight control function, touching the screen turns it on again. If a touch switch happens to be located at that point on the screen, it will be invalid until the backlight has gone on again.

Touch Sounds

This sets the touch sounds corresponding to GT30 screens as either invalid or valid. Select one of the radio buttons.

Disable — Touch sounds are disabled.

Enable — Touch sounds are enabled.

Dead battery display

This specifies whether or not a dead battery mark will be displayed on the GT30 screen if the voltage of the internal battery drops too low.

Don't display — The dead battery mark is not displayed.

Display — The dead battery mark is displayed.

6.2.7 GT Configuration Settings: “Hold PLC Device”

Clicking on the “Hold PLC Device” tab in the “GT Configuration” dialog box displays the screen shown below. “Hold PLC Device” is a function that enables internal PLC device values to be held on the GT30 side.

“Hold PLC Device” screen

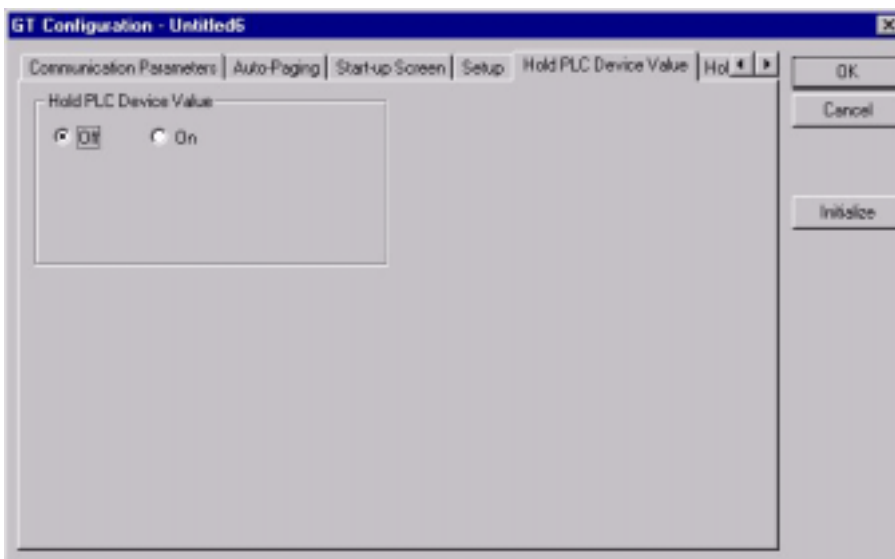

Hold PLC Device

The Hold PLC Device function reads the values for the specified internal PLC device to the SRAM in the GT30, and backs up the values.

Off — PLC devices are not held.

On — PLC devices are held (up to 24 words)

If “On” is selected for the above Hold PLC Device setting, “Device” and “Number of Word” parameters are displayed. Clicking on the  button displays a dialog box like that shown below, where the type of initial device, the address, and the number of words can be specified.

Device Setting dialog box

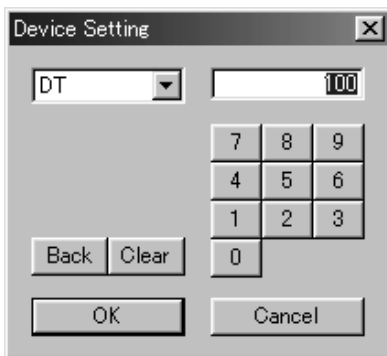

Click on the  button to display the pull-down menu, and select the device from that menu. Enter the address using the ten-keys.

The  button functions as a backspace key when entering addresses.

The  button acts as a Clear key.



- Data for PLC devices held in the GT30 will be written to the internal PLC device the next time that the power supply is turned on.
- The data held for the internal PLC device is backed up by means of a lithium battery. The service life of the battery is approximately two years. For detailed information, please see “What the Battery Does (DT30)” on page 130.

6.2.8 GT Configuration Setting: “GT Internal Device Hold”

Clicking on the “GT Internal Device Hold” tab in the “GT Configuration Settings” dialog box displays the screen shown below. “GT Internal Device Hold” is a function that holds the values for an internal device (GDT or GWR) in the GT main unit.

GT internal device hold screen

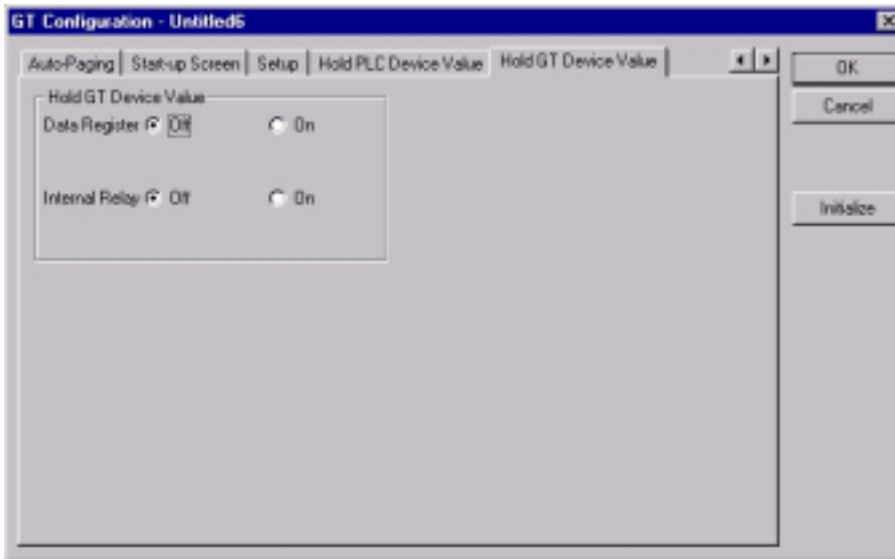

GT internal device hold

“GT Internal Device Hold” is a function that backs up the values for an internal device (GWR or GDT) in the GT main unit.

Data register

Don't hold — The GT internal device hold function is turned off.

Hold — The GT internal device hold function is turned on.

Internal relay

Don't hold — The GT internal device hold function is turned off.

Hold — The GT internal device hold function is turned on.

If the above setting for the GT internal device hold function is set to “Hold”, a “Start No.” item is displayed. Click on the  button to display the value setting dialog box shown below, and specify a starting number. After the setting has been entered, the contents of any addresses subsequent to the specified value will be held.

Value setting dialog box



Enter the starting number, using the ten-key pad.

The  button functions as a backspace key when entering addresses.

The  button acts as a Clear key.

**◆ KEY POINTS**

GT internal devices

Device type		Address range	Points
Memory	Data register	GDT0000 to GDT2047	2048 words
	Internal relay	WGR0000 to WGR0255	256 words
Bits	Internal relay	GR0000 to GR255F	4096 points

* The WGR and GR are the same memory, but in the WGR, bits are handled in word units.

6.3 Entering Configuration Settings from the GT30

6.3.1 What is the System Menu?

The system menu is a dedicated screen on which configuration settings for the GT30 are entered. Some of the items that can be specified here can also be set using GTWIN screen creation tool and then sent to the GT30, but others, such as the internal clock and adjustments to the LCD contrast level, can only be set using the system menu. This section explains how configuration settings are entered using the system menu.

6.3.2 Bringing Up the System Menu

The following procedure is used to bring up the system menu.

(1) Touch the four corners of the LCD touch panel simultaneously.

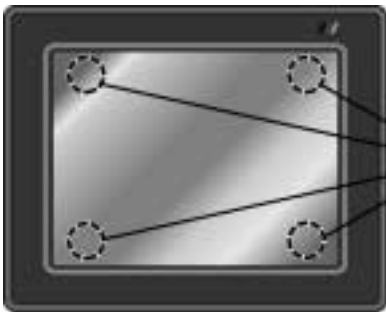

Touch these four corners at the same time, and continue pressing them for about one second.

(2) The initial screen of the system menu is displayed.

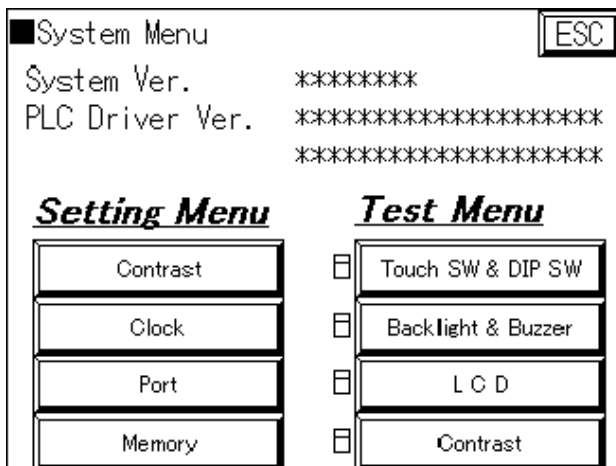

The initial screen of the system menu is displayed on the GT30. Touching the [ESC] key exits the system menu and returns to the normal operating mode.

* indicates the ROM version of the GT30 system.

6.3.3 Setting Mode: “Liquid Crystal Display Contrast Adjustment”

Touching [Setting] on the initial screen of the system menu and then the [Contrast] key of the setting mode menu displays the contrast adjustment screen. The contrast of the GT30 LCD is adjusted here.

Contrast adjustment screen (when using the color type)

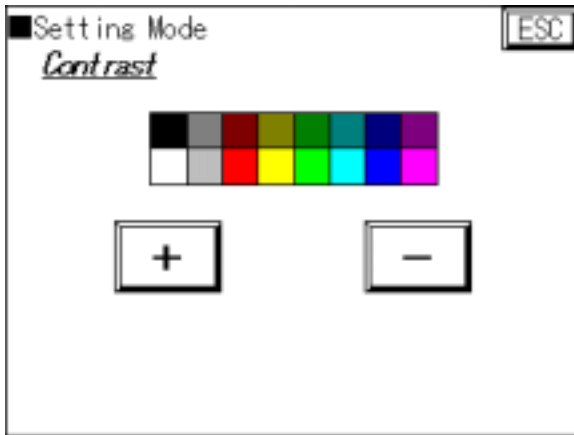

Procedure for bringing up the screen
 [Initial screen]
 ↓
 [Contrast]

Contrast adjustment screen (when using the monochrome type)

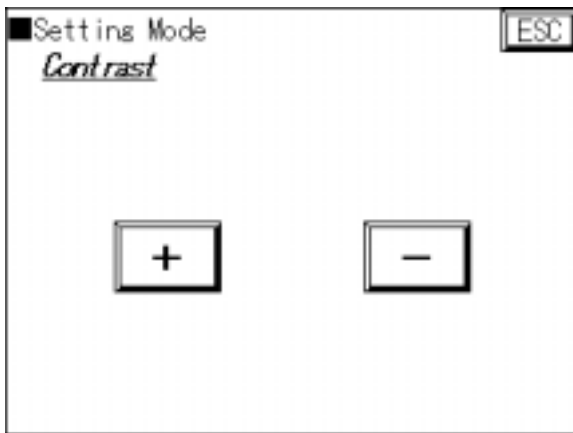

Procedure for bringing up the screen
 [Initial screen]
 ↓
 [Contrast]



◆ SHORTCUTS

[ADJUST] Touching the [+] key increases the contrast, and touching the [-] key decreases it.

[RETURN] To complete the settings and return to the previous screen, touch the [ESC] key.

6.3.4 Setting Mode: “Clock Settings” (Clock)

Touching [Setting] on the initial screen of the system menu and then the [Clock] key of the setting mode menu displays the clock setting screen. The internal clock of the GT30 is set here.

Clock setting screen

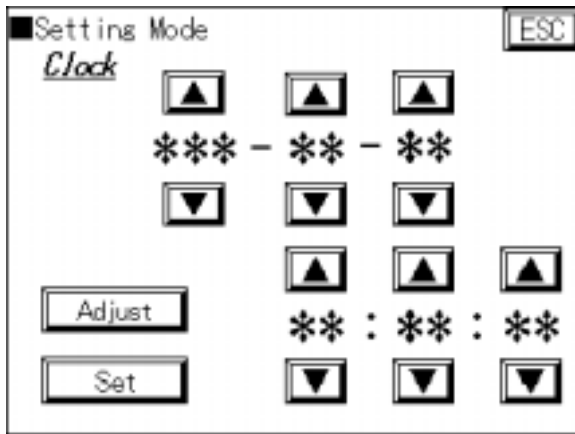

Procedure for bringing up the screen
 [Initial screen]
 ↓
 [Clock]

The time displayed on the screen is the current time indicated by the internal clock of the GT30. Items can be changed by touching the item (year, month, day, hour, minute, second) and touching the [+] and [-] keys to change the values.



◆ SHORTCUTS

[ADJUST] Touching the [+] key increases the value, and touching the [-] key decreases it.

[SET] Touching the [SET] key updates the Value Set and restarts the clock. Touching the [ADJUST] key sets the seconds value of the current time to "00". A seconds value of 0 to 29 is rounded off to the next lower value, and a seconds value of 30 to 59 is rounded off to the next upper value.



◆ EXAMPLE

If the time is set to 12 (hours) : 35 (minutes) : 29 (seconds)
 → 12 (hour) : 35 (minute) : 00 (seconds)
 If the time is set to 12 (hours) : 35 (minutes) : 30 (seconds)
 → 12 (hour) : 36 (minute) : 00 (seconds)

[RETURN] To complete the settings and return to the previous screen, touch the [ESC] key.



◆ EXPLANATION

Setting the day

The day is set automatically, based on the year, month, and date data.

6.3.5 Setting Mode: “Communication Parameters” (TOOL Port / COM. Port)

Touch the [Port] key on the initial screen of the system menu to display the communication parameters setting screen. Here, parameters controlling communication between the PLC and personal computer (GTWIN) connected to the GT30 are specified.

Port communication parameter settings

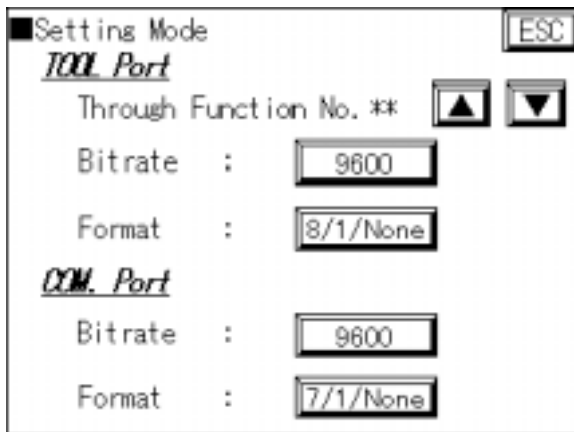

Procedure for bringing up the screen
[Initial screen]

↓
[Port]

TOOL Port communication parameter settings (GTWIN communication parameter settings)

Through function: Through function destination setting

When the through function is being used, this specifies the number of the PLC at the other end of the connection. Normally, when used in a 1 : 1 configuration, this should be set to “00”.

Bitrate: GTWIN communication speed

Each time the [Function] key is touched, the Baud rate switches in the sequence of 9600/19200/115200 bits/s. Set the speed to match that of the personal computer (GTWIN) connected to the GT30.

Format: Transmission format

This sets the communication parameters (data length, stop bits, parity) for the personal computer (GTWIN) connected to the GT30.

The items displayed are: Data length / Stop bit / Parity, and each time the [Function] key is pressed, the display switches in the sequence of: [8/1/None], [8/1/Odd], [8/1/Even].

COM. Port communication parameter settings (PLC communication parameter settings)

Bitrate: PLC communication speed

This sets the communication speed or Baud rate, for communication with an external device (PLC) connected to the GT30.

Each time the [Function] key is pressed, the Baud rate switches in the sequence of 9600/19200/38400/57600/115200 bits/s. Set the speed to match that of the PLC connected to the GT30.

Format: Transmission format

This sets the communication parameters (data length, stop bits, parity) for the external device (PLC) connected to the GT30.

The items displayed are: Data length / Stop bit / Parity, and each time the [Function] key is pressed, the display switches in the sequence of: [7/1/None], [7/1/Odd], [7/1/Even] [8/1/None], [8/1/Odd], [8/1/Even].

Set the parameter to match those of the PLC connected to the GT30.



◆ SHORTCUTS

[RETURN] To complete the settings and return to the previous screen, touch the [ESC] key.



◆ EXPLANATION

- **TOOL Port communication parameter settings**
The default (initial) values for the TOOL Port communication parameter settings are: 19200 bits/s, 8/1/Odd.
- **COM. port communication parameter settings**
The default (initial) values for the COM. port communication parameter settings are: 19200 bits/s, 8/1/Odd.

6.3.6 Setting Mode: “Memory Initialization” (Clear Memory)

Touching [Setting] on the initial screen of the system menu and then the [Memory] key of the setting mode menu displays the memory initialization screen. The internal user memory of the GT30 is initialized here.

Memory initialization screen



Procedure for bringing up the screen
[Initial screen]
↓
[Memory]

Touching the [SRAM] key deletes clock data and Hold PLC Device data held in the SRAM.

Touching the [FROM] key deletes screen data and main unit configuration settings saved to the main unit user memory (F-ROM).

When either of the above keys is touched, a confirmation message reading **CLEAR OK?** is displayed. To clear the data, touch the **CLEAR OK?** key. When **CLEARED** is displayed, the memory has been completely cleared.



◆ SHORTCUTS

[RETURN]To complete the settings and return to the previous screen, touch the **[ESC]** key.



◆ CAUTION

- **[SRAM]** initialization deletes the clock data and Hold PLC Device data backed up in the SRAM. Please be sure that you want to do this before initializing the SRAM.
- **[FROM]** initialization deletes the base screen data and the main unit configuration setting data (the main unit configuration setting data returns to the default values) in the user memory (F-ROM) of the main unit. Before initializing the F-ROM, always save screen data to a floppy disk or another medium with GTWIN.

6.3.7 Test Mode: “Self-Diagnosis”

The self-diagnosis is run from the initial screen of the system menu. This is used to run a hardware check of the memory, buzzers, and other elements of the GT30.

Touch SW & DIP SW

This runs an operation check of the touch switches and the DIP switches.

Backlight & Buzzer

This runs an operation check of the backlight and the buzzer.

LCD

This displays a pattern and runs an operation check of the display.

Contrast

Touch the **[+]** and **[-]** keys to check changes in the contrast.



◆ SHORTCUTS

[RETURN]To exit the system menu and return to the normal operation mode, touch the **[ESC]** key.



◆ EXPLANATION

- **Test Menu items**
A dot **[•]** is displayed to the left of the key switch for items on the Test Menu which have already been tested.

6.3.8 Inhibiting the System Menu Display

In order to prevent unauthorized persons from being able to change GT30 configuration settings, the GT30 is set up so that DIP switches can be used to make it impossible to display the system menu.

Operation mode setting switches

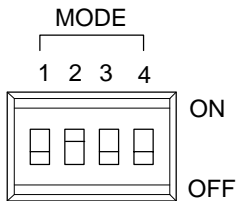

If the second operation mode setting switch is turned on, as shown at the left, access to the system menu is denied.

Switch no.	Function	OFF	ON
1	Usage inhibited	Should always be in the "OFF" position when unit is used.	
2	Inhibits system menu shift	Shift possible	Shift inhibited
3	Usage inhibited	Should always be in the "OFF" position when unit is used.	
4			

Chapter 7

How the Various Functions Are Used

7.1 Switching Screens

There are three ways to switch screens registered in the GT main unit.

7.1.1 Switching the Screen from the PLC

GT main unit screens can be switched from the PLC ladder program, by writing the number of the screen to be displayed in hexadecimal format to the initial word of the word device in the basic communication area.

At the same time that the screen is switched, the GT main unit writes the number of the screen to which the display was switched in the first to third words of the basic communication area, in hexadecimal format.

How communication is carried out between the GT main unit and the PLC (screen switching)

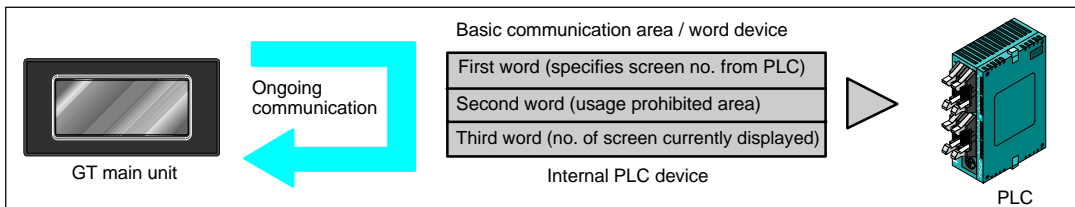

How screens are switched

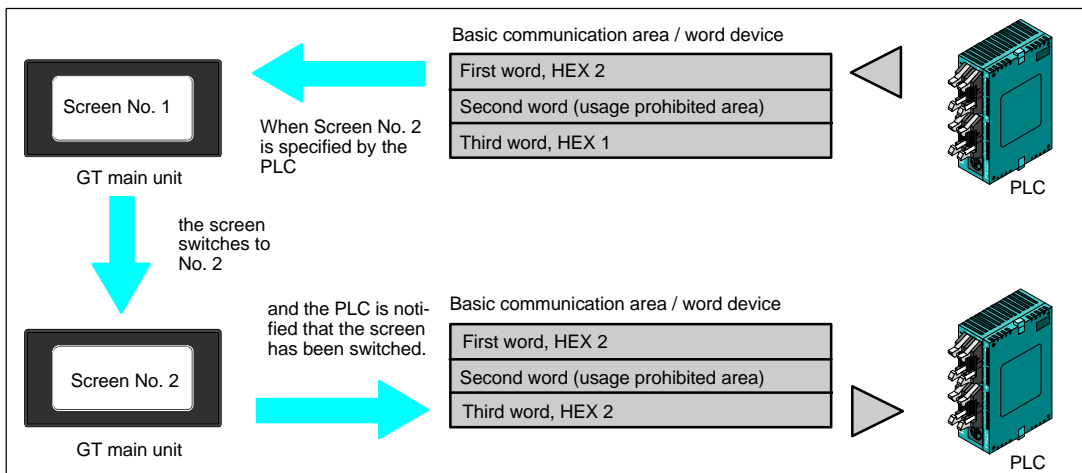

Example of ladder programs

Following are basic screen display programs in FPCWIN Pro and FPCWIN GR.

When the PLC directs the display unit to switch screens, indicate as shown in the programs both:

- the screen to be displayed using a hexadecimal number
- the destination of the screen as defined in the basic communication area

FPWIN Pro:

GVL In the **Global Variable List**, you define variables that can be accessed by all POU's in the project.

Global Variable List								
	Class	Identifier	Matsu	IEC_Add	Type	Init	Aut	Comment
0	VAR_GLOBAL	Addr_CommArea	DTD	%MW5.0	WORD	0		Address of first word in basic communication area

POU header In the POU header, all input and output variables are declared that are used for programming this function.

	Class	Identifier	Type	Initial	Comment
0	VAR	SwitchScreen	BOOL	FALSE	
1	VAR	ScreenToDisplay	WORD	16#2	No. of screen to be displayed
2	VAR_EXTERNAL	Addr_CommArea	WORD	0	Address of first word in basic communication area

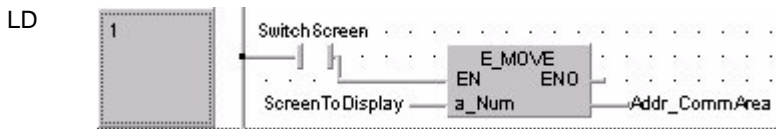

FPWIN GR:

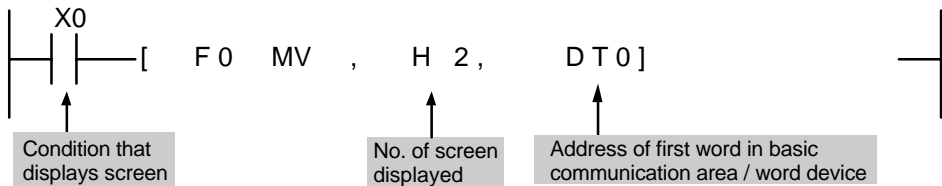

7.1.2 Switching the Screen with the GT Main Unit

Using the function switch unit

GTWIN has “function switching parts” (FSW0, FSW1, FSW2) in the parts library that can be used to switch screens on the GT main unit. These parts should be arranged on the base screen and assigned the attributes indicated below.

Function switching parts: Attribute editing dialog box

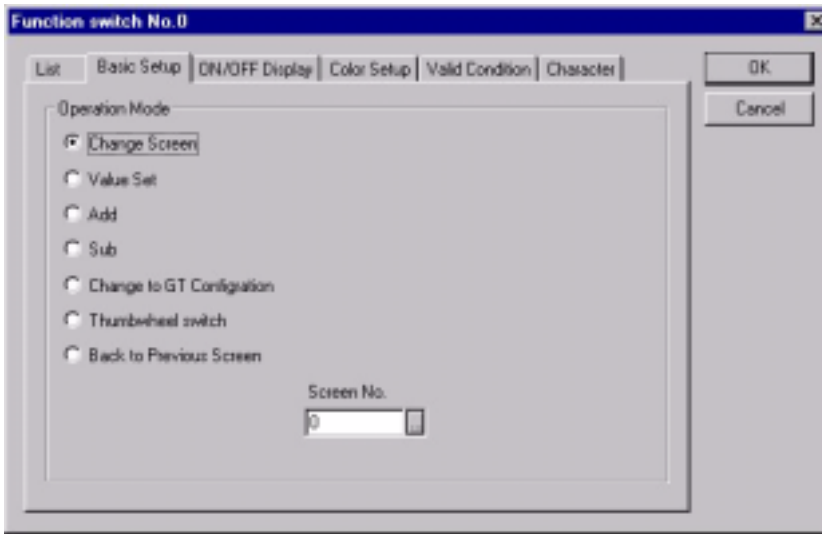

Double-clicking on the parts arranged on the base screen, or selecting a switch part, and clicking on the “Parts (T)” menu and then the “Edit Attribute” sub-menu displays the dialog box shown above.

(1) Using the “Change Screen” operation mode

Select the “Change Screen” operation mode and specify the number of the screen to be changed. Then press the switch part to switch the screen to the specified screen. To return to the screen displayed just prior to the currently displayed screen, the “Return to Previous Screen” operation mode can be used.

 In this case, the value of the third word in the basic communication area / word device (the number of the currently displayed screen) changes to that of the new screen number, but please be aware that the contents of the first word (the screen number specified by the PLC) do not change. For detailed information, see page 120.

(2) Using the “Value Set” operation mode

Select the “Value Set” operation mode and enter the following settings:

- Data format: Specify 1 word
- Output destination: Specify to first word of basic communication area / word device
- Value: Number of screen to be changed to (hexadecimal specification)

Each time the GT main unit switch part is pressed, the screen number is forcibly written by the GT main unit to the first word of the basic communication area / word device, and the screen is switched.

 If using this method, the values for both the first word of the basic communication area / word device (the screen number specified by the PLC) and the third word (the number of the currently displayed screen) are changed.

Using the auto-paging function



The GT main unit has an “Auto-paging” function that automatically switches the screen to a specified screen number when a certain period of time has elapsed. This function can be used to switch screens automatically.



 For information on setting the auto-paging function, please see page 78 (GT10) and page 100 (GT30).

 If using this function, please be aware that the value of the third word in the basic communication area / word device (the number of the currently displayed screen) changes to that of the new screen number, but the contents of the first word (the screen number specified by the PLC) do not change. For detailed information, see page 120.

Clicking on the  button displays the value setting dialog box shown below. Specify the number of the screen to which the display is to be changed.



If the value is entered with the  button pressed as shown at the left, a hexadecimal screen number is specified, and if the value is entered with the  button pressed, a decimal value is entered.

The  button acts as a backspace key when entering an address, and the  button functions as a Clear key.



◆ KEY POINTS

- **If the screen does not change as expected**
If the screen is changed from the PLC, and the GT main unit function switch parts are also used to change the screen (Change Screen operation mode), a case sometimes occurs in which the screen does not change, even though an instruction to change the screen has been issued by the PLC.

Example: Screen No. 1 is displayed in keeping with the instruction from the PLC, and the screen is changed to Screen No. 2 using the function switch parts.

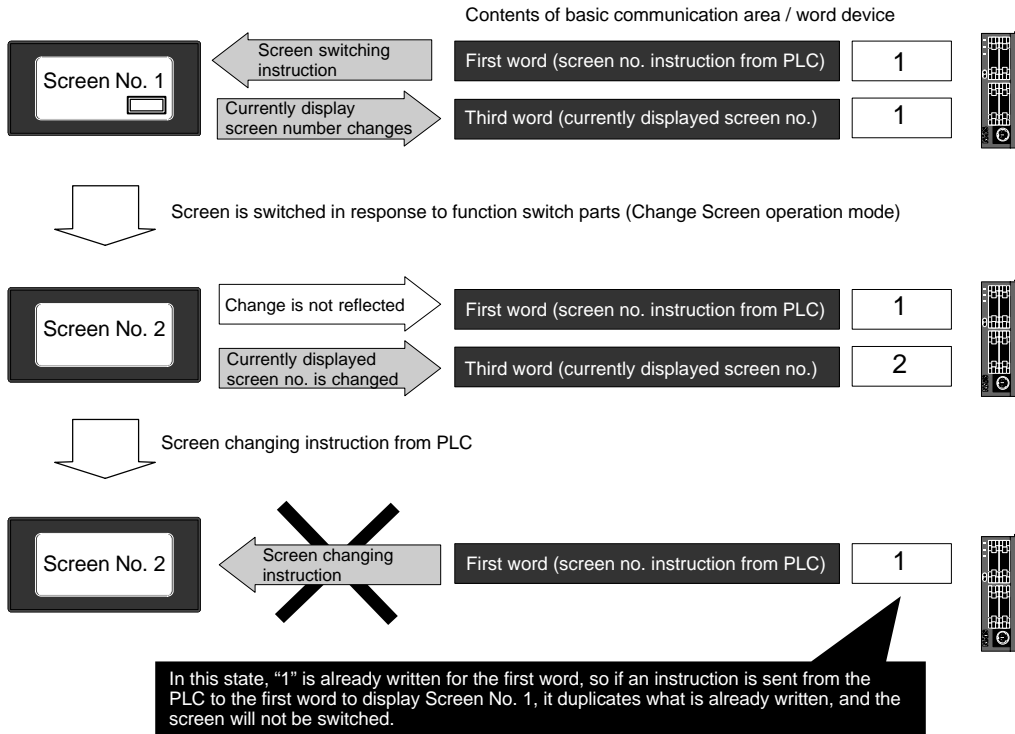

This problem can be solved in the following manner:

- Use the “forced–display flag” in the basic communication area/bit device.
 - 1) At the same time that the PLC issues an instruction to change the screen again to Screen No. 1, or shortly after that point, the forced–display flag in the first word/Bit E of the basic communication area/bit device is turned on, using the bit as a PLC bit operation instruction.
 - 2) When the forced–display flag begins to go on, the screen corresponding to the number written to the first word of the basic communication area/word device, meaning Screen No. 1, is forcibly displayed at the point that step 1 takes place. (This is carried out only at the rise of the forced–display flag).
 - 3) After the screen has been switched, the forced–display flag should be turned off.
- Set the operation mode of the function switch parts to “Value Set”. When the screen is switched using the function switch parts, as shown in the illustration above, the operation mode of the function switch parts is set to “Value Set” in order to switch the screen. (For detailed information, see page 117.) Using the “Value Set” mode changes the contents of the first word in the basic communication area/word device (the screen number specified by the PLC) and the third word (the number of the

currently displayed screen) to that of the new screen number, and thus avoids the kind of case described above.

7.2 GT10 Bit Device Functions

In order for communication to be carried out between the GT10 and PLC, an internal device area like that shown below is provided in the PLC. This basic communication area contains two types of devices: word devices, which are used to handle screen numbers and other data, and bit devices, which are used for bit information. The various bits of the bit devices are turned on and off from the PLC, and can be used to control various GT10 operations.

Bit devices

Word position	F	E	D	C	B	A	9	8	7	6	5	4	3	2	1	0	
N+0	BZ	Forced–display flag	Backlight Valid flag	Backlight Flashing	Backlight Color												
N+1	Usage prohibited																
N+2																BAT	Data Input In Progress flag

Explanation of system areas

BZ — This turns on the buzzer.

Forced–Display flag — At the rise when the bit is turned on, the screen specified by the PLC is forcibly displayed. (This is executed only when at the rise of the bit.)

Backlight Valid flag — When the bit is turned on, the backlight flashing/backlight color control becomes effective.

Backlight Flashing — 0: Lighted (normal), 1: Flashing

Backlight Color — 00: Off, 01: Green, 10: Red, 11: Orange

BAT — This goes on if clock data and Hold PLC Device data held in the SRAM are not being backed up normally. (This bit also goes on if the SRAM is not backed up by the internal secondary battery.)

Data Input In Progress flag — This is 1 while data is being input, and 0 when data input has been completed.



◆ EXPLANATION

DT0 to DT2 and WR0 to WR2 are set as the default values for the basic communication area.

For information on the contents of all areas of the basic communication area, please see page 30.

Changing the backlight color

Bits A and B of the first word of the bit device are used to change the backlight color. The color of the backlight can be changed by turning these bits on and off.

To make these settings valid, however, Bit D (Backlight Valid flag) must always be turned on at the same time.

Bit status		Backlight color
B	A	
OFF	OFF	Off
OFF	ON	Green
ON	OFF	Red
ON	ON	Orange

Using a flashing backlight

Bit C of the first word of the bit device is used to make the backlight flash. The backlight status can be changed by turning this bit on and off. To make this setting valid, however, Bit D (Backlight Valid flag) must always be turned on at the same time.

Bit status	Backlight status
C	
OFF	Lighted
ON	Flashing

Making the buzzer sound

Bit F of the first word of the bit device is used to make the buzzer sound. The buzzer status can be changed by turning this bit on and off.

Bit status	Buzzer status
F	
OFF	Stopped
ON	Buzzer output

Data Input in Progress flag

With the GT10, while data is being input from the screen keyboard part, Bit 0 of the third word of the bit device is on.

Applications should be set up so that, when this bit is on, the screen cannot be changed from the PLC.

7.3 GT30 Bit Device Functions

In order for communication to be carried out between the GT30 and PLC, an internal device area like that shown below is provided in the PLC. This basic communication area contains two types of devices: word devices, which are used to handle screen numbers and other data, and bit devices, which are used for bit information. The various bits of the bit devices are turned on and off from the PLC, and can be used to control various GT30 operations.

Bit devices

Word position	F	E	D	C	B	A	9	8	7	6	5	4	3	2	1	0	
N+0	BZ	Forced–display flag	Backlight Valid flag	Backlight Flashing	Backlight Color												
N+1	Usage prohibited																
N+2															BAT LOW flag	BAT	Data Input In Progress flag

Explanation of system areas

BZ — This turns on the buzzer.

Forced–Display flag — At the rise when the bit is turned on, the screen specified by the PLC is forcibly displayed. (This is executed only when at the rise of the bit.)

Backlight Valid flag — When the bit is turned on, the backlight flashing/backlight color control becomes effective.

Backlight Flashing — 0: Lighted (normal), 1: Flashing

Backlight Color — 00: Off, 01: Lighted, 10: Lighted, 11: Lighted

BAT — This goes on if clock data and Hold PLC Device data held in the SRAM are not being backed up normally. (This bit also goes on if the SRAM is not backed up by the internal secondary battery.)

Data Input In Progress flag — This is 1 while data is being input, and 0 when data input has been completed.

BAT LOW flag — This bit goes on if the battery capacitance drops too low. The battery should be replaced within one week of the time when this bit goes on.



◆ EXPLANATION

DT0 to DT2 and WR0 to WR2 are set as the default values for the basic communication area.

For information on the contents of all areas of the basic communication area, please see page 30.

Turning the backlight on and off

The A and B bits of the initial bit device word are used to turn the backlight on and off. These bits can be changed to change the backlight illumination status.

To make these settings valid, however, Bit D (Backlight Valid flag) must always be turned on at the same time.

Bit status		Backlight status
B	A	
OFF	OFF	Off
OFF	ON	Lighted
ON	OFF	
ON	ON	

Using a flashing backlight

Bit C of the first word of the bit device is used to make the backlight flash. The backlight status can be changed by turning this bit on and off. To make this setting valid, however, Bit D (Backlight Valid flag) must always be turned on at the same time.

Bit status	Backlight status
C	
OFF	Lighted
ON	Flashing

Making the buzzer sound

Bit F of the first word of the bit device is used to make the buzzer sound. The buzzer status can be changed by turning this bit on and off.

Bit status	Buzzer status
F	
OFF	Stopped
ON	Buzzer output

Data Input in Progress flag

With the GT30, while data is being input from the screen keyboard part, Bit 0 of the third word of the bit device is on.

Applications should be set up so that, when this bit is on, the screen cannot be changed from the PLC.

Chapter 8

Servicing and Maintenance

8.1 The Internal Secondary Battery (GT10)

Internal GT10 data is backed up in the following ways:

Screen data GT10 configuration data	Stored in the F-ROM. (No battery backup required.)
Hold PLC Device data Clock data GT internal device hold data	Stored in the SRAM. (Backed up by the internal secondary battery, which is charged when power is supplied to the GT10.)

The No. 1 operation mode setting switch on the back of the GT10 is used to specify whether or not the contents of the SRAM are backed up.

Operation mode setting switches

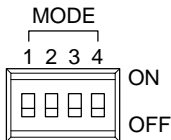

(status when shipped)

Switch no.	Function	OFF	ON
1	SRAM backup using secondary battery	No	Yes
2	Inhibits system menu shift	Shift possible	Shift inhibited
3	Usage inhibited	Should always be in the OFF position when unit is used	
4			

In order to prevent excessive discharging of the internal secondary battery when the unit is shipped from the factory, the No. 1 operation mode setting switch is set to the “OFF” position.

Before turning on the power supply, always set the No. 1 operation mode setting switch on the back of the GT10 to the “ON” position.

In order to back up the various types of data stored in the SRAM, as described above, the No. 1 operation mode setting switch on the back of the GT10 should always be set to the “ON” position before turning on the power supply.

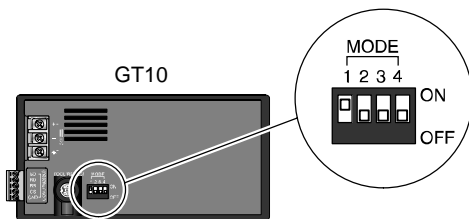

◆ EXPLANATION

* Secondary Battery Performance

Secondary battery performance, when operating at a normal temperature of 25°C, a normal humidity of 65% RH, and a voltage of 24V DC, is as follows:

Item	Details
Backup time	Min. 10 days when fully charged
Charge time	If the power has been off for 24 hours, it takes approx. 15 min. to fully charge. If the power has been off for 10 days, it takes approx. 2 hrs. to fully charge.
Service life	Approx. 7 years



◆ CAUTION

- 1) Frequent long periods with the power off will decrease the service life of the secondary battery.

- 2) For long periods with the power off, it is recommended that the No. 1 operation mode setting switch (SRAM backup with secondary battery) be set to "OFF" for storage. However, please note that when the switch is set to "OFF", the clock data and the device hold area data will not be backed up.**
- 3) Service life shorten beyond all measure when used in ambient operating temperatures of more than 40°C/104°F or when the operating voltage exceeds 25V DC.
If GT10 is used under this environment please consult with us about service life.**

8.2 Battery (GT30)

Internal GT30 data is backed up in the following ways:

Screen data GT30 configuration data	Stored in the F-ROM. (No battery backup required.)
Hold PLC Device data Clock data GT internal device hold data	Stored in the SRAM. (Backed up by battery in optional card)

In order to prevent the battery from discharging, an insulation sheet is inserted.

Before turning on the power, always remove the insulating sheet.

As noted above, in order to back up the various types of data stored in the SRAM, the insulation sheet should always be removed before turning on the power supply.

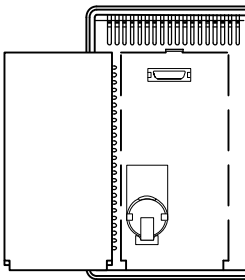

Remove insulation sheet



◆ EXPLANATION

* Battery Performance

Battery performance, when operating at a normal temperature of 25°C, a normal humidity of 65% RH, and a voltage of 24V DC, is as follows.

Item	Details
Service life	Approx. 2 years



◆ CAUTION

- If the battery voltage drops too low, the BAT LOW flag of the basic communication area map goes on. If the battery has run down completely, the BAT flag of the basic communication area map goes on. Please be aware that the BAT flag goes on the first time that the power supply is turned on after the unit is purchased, even though the battery insulation sheet has been removed.
- When replacing the lithium battery, insert the new battery within 20 seconds of removing the old one.

8.3 Replacing the Front Panel Protective Sheet

In order to protect the touch panel and keep it clean, the GT main unit comes with a protective sheet attached over the panel. If this protective sheet becomes dirty or worn, it should be replaced. Replacement sheets are available as an optional item.

Product name	Contents	Product number	
Front panel protective sheet	Front panel protective sheets for replacement (set of 10)	For GT10	AIGT180
		For GT30	AIGT380

Replacing the Front Panel Protective Sheet

Follow the steps below to replace the sheet:

1. Remove the attached front panel protective sheet.

First, peel off the front panel protective sheet already attached to the GT main unit, starting from the upper left edge, where the knob is.

2. Peel off the seal from the provided protector sheet and attach it to the unit.

Take out one of the replacement front panel protective sheets and peel off the seal with the shiny side. When attaching the sheet, align the adhesive edges with the front of the GT main unit.

3. Finish by peeling off the thin film attached to the top of the front panel protective sheet.

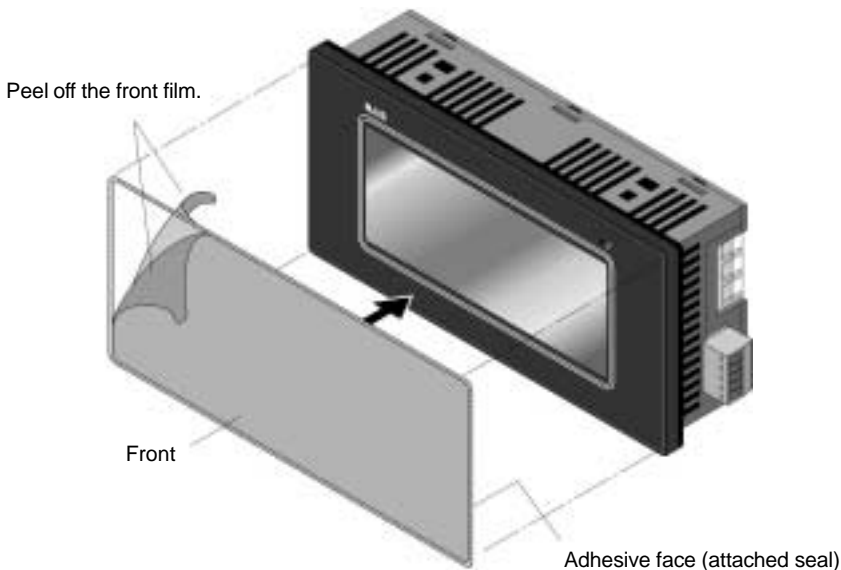

8.4 Replacing the Waterproof Packing

If the panel is being detached from the GT main unit and then reattached, the waterproof packing should be replaced, in order to assure that the panel remains waterproof (IP65).

Product name	Contents	Product number	
Waterproof packing	Waterproof packings for replacement (set of 10)	For GT10	AIGT181
		For GT30	AIGT381

Replacing the Waterproof Packing

Follow the steps below to replace the packing:

1. Remove the currently attached waterproof packing.

Remove the attached waterproof packing from the GT main unit.

2. Attach the provided waterproof packing.

Take out one of the replacement waterproof packing pieces and attach the outer edge as shown in the illustration (do not use the inner edge).

When doing this, fasten it to the front frame, being sure not to twist the waterproof packing.

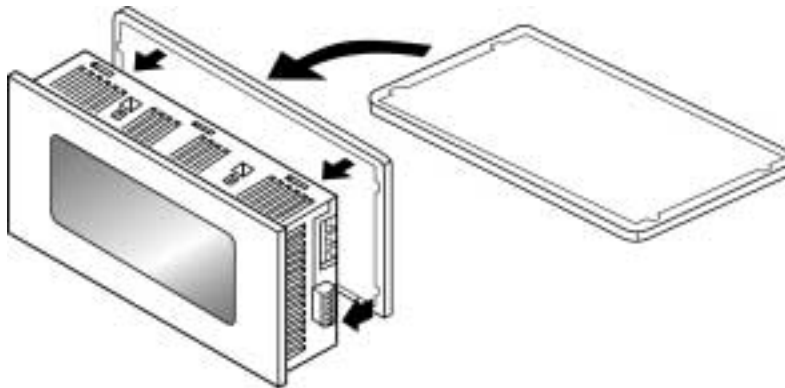

8.5 Replacing the Backlight (GT30 Only)

The average service life of the GT30 backlight is 50,000 hours (at room temperature, normal humidity, and 24 VDC). ("Service life" refers to the period over which the brightness diminishes by half, and does not mean that the backlight no longer lights at all.) If the backlight has become dim, it should be replaced with a replacement backlight.

The backlight is sold separately.

Product name	Contents	Product number
Replacement backlight	For color and B&W LCD types	AIGT382



CAUTION

When replacing the backlight, always turn off the power supply to the main unit. Also, we recommend wearing gloves when doing this, to prevent injuries.

Procedure: Replacing the Backlight

1. Remove the cover.
2. Disconnect the connector by pulling upward.

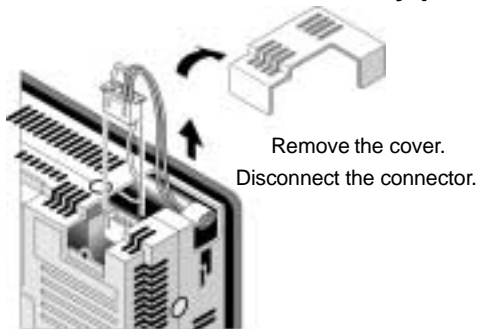

3. Gently pull out the backlight.

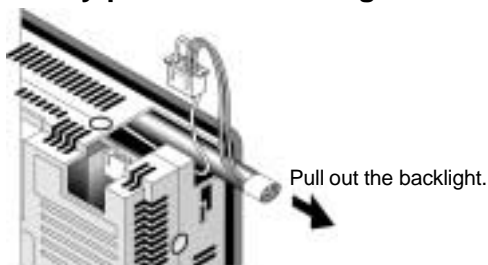

4. Install the new backlight, reconnect the connector and replace the cover.



NOTE

After replacing the backlight, be careful that the backlight cable is not pinched by the case, cutting through it.

Chapter 9

Troubleshooting

9.1 What to Do If Something Unusual Occurs (GT10)

Problem	Cause	Solution	Related
Screen is blank	<ol style="list-style-type: none"> 1) Power is not on. 2) (When only lamp and message parts are configured to the base screen) Value of substitute reference device value does not exist in substitute data. 	<ol style="list-style-type: none"> 1) Supply 24V DC power to unit. 2) Check the address of the substitute reference device and the device values on the PLC side. 	<p>page 21</p> <p>GTWIN HELP</p>
Error code [ER**] appears at the top right of the screen	An error has occurred in communication between the GT10 and an external device (e.g. PLC).	[Troubleshooting error codes] are listed on page 142. Refer to this section for details.	page 142
Screen displays [No Screen data]	There is no base screen data in the GT10. (Appears even when GT10 configuration data exists.)	Transfer base screen data from GTWIN.	GTWIN HELP
Screen displays [Screen No. Error]	<ol style="list-style-type: none"> 1) Screen settings from the PLC, the GT10's switch part or the auto-paging indicate an unregistered screen number. 2) When bringing up the keyboard screen during data input, an unregistered keyboard screen number was specified. 3) GT10 configuration data and keyboard screen data exist in the GT10, but there is no base screen data. 	<ol style="list-style-type: none"> 1) Create and register screen content or specify the correct screen number. 2) Create and register keyboard screen or specify the correct keyboard number. 3) Transfer base screen data from GTWIN. 	<p>page 118</p> <p>GTWIN HELP</p> <p>GTWIN HELP</p>
Screen displays [Memory is Full]	The total capacity of transferred base screen data exceeds the 384kbyte capacity of the GT10.	Delete part of the base screen data so that the total capacity doesn't exceed 384kbyte. Data capacity can be checked by going to [View (V)] → [Memory Usage Conditions] on GTWIN menu bar.	GTWIN HELP
An unspecified screen appeared / there is trouble when switching screens	<ol style="list-style-type: none"> 1) The screen specification in the PLC screen setting, the GT10 switch part or the auto-paging is wrong. 2) The startup screen is specified in the GT10 configuration settings (GTWIN). 3) An erroneous device or value is specified in the first word of the basic communication area word device. 	<ol style="list-style-type: none"> 1) Specify the correct screen number. 2) Check the start-up screen setting for the GT10 configuration settings in GTWIN. Delete unnecessary settings and re-transfer configuration data. 3) Check the device content specified on the PLC side in the first word of the basic communication area. (Do not use the basic communication area with ladder programs.) 	<p>page 118</p> <p>page 77</p> <p>page 29 to page 30</p>
Screen doesn't switch	<ol style="list-style-type: none"> 1) No screen number has been written to the screen setting area (the first word in the basic communication area word device) from the PLC. 2) The screen number to which you are attempting to switch has already been written from the PLC to the screen setting area (the first word in the basic communication area word device). 	<ol style="list-style-type: none"> 1) Specify correct screen number. 2) Refer to page 119 [If the screen does not change as expected]. (Do not use the basic communication area with ladder programs.) 	<p>page 118</p> <p>page 119</p>

Problem	Cause	Solution	Related
Screen is dim	<ol style="list-style-type: none"> 1) The power voltage may be low. 2) The contrast is set too low. 3) The backlight is off due to the [Backlight Auto-off] setting in the [Setup] of the GT10 configuration settings in GTWIN. 	<ol style="list-style-type: none"> 1) Supply 24V DC 0.3 A. 2) Bring up the system menu and adjust the contrast. 3) Touching any area of the screen lights that area. If a switch part is set on the touched area, the area will not light even if touched. To change the setting, change the content of the backlight auto-off settings. 	<p>page 21</p> <p>page 87</p> <p>page 81</p>
Backlight goes off too quickly	The backlight auto-off timer setting is too short.	Change the backlight auto-off timer setting.	page 81
Date / time display is incorrect	<ol style="list-style-type: none"> 1) The GT10 internal clock is incorrect. 2) Clock data is lost when power is off because the secondary battery is not set to ON. 3) The secondary battery is set to ON but due to long periods with the power off or on (over 10 days), the clock data has been lost. 4) The PLC's internal calendar timer used as a reference is incorrect. 	<ol style="list-style-type: none"> 1) Bring up the system menu and adjust the clock. 2) Turn off the power, and after turning on the No. 1 operation mode setting switch on the back of the GT10, power up the unit and adjust the clock. 3) Turn on the power and set the system menu clock data. In cases when power is off for approx. 10 days, it takes around 2 hours for the secondary battery to fully charge. 4) Adjust by rewriting the value in the PLC's internal calendar timer. 	<p>page 87</p> <p>page 128</p> <p>page 128</p> <p>All PLC manuals</p>
Hold PLC Device data content isn't saved	<ol style="list-style-type: none"> 1) Hold PLC Device data is being lost when power is turned off because secondary battery is not set to ON. 2) The secondary battery is set to ON, but due to long periods of power off or on (over 10 days), the Hold PLC Device data is being lost. 	<ol style="list-style-type: none"> 1) Turn off power, and after turning on the No. 1 operation mode setting switch on the back of the GT10, re-supply power to the unit. 2) Turn on the power and use the unit. In cases when power is off for approx. 10 days, it takes around 2 hours for the secondary battery to fully charge. 	<p>page 128</p> <p>page 128</p>
Touch panel doesn't work	<ol style="list-style-type: none"> 1) The switch part size setting does not match the touch panel grid. 2) Valid conditions have been set for the switch part, but those conditions have not been met. (Applies only to custom parts.) 	<ol style="list-style-type: none"> 1) When creating screens with GTWIN, match grid settings to touch panel and make them valid, then resize. 2) Check that the device status conditions on the PLC side are valid. 	<p>GTWIN HELP</p> <p>GTWIN HELP</p>
No operating sounds are heard when the touch panel is pressed.	<ol style="list-style-type: none"> 1) The [Switch Sounds] setting under [Options] in the switch part attributes is set to [Disabled]. 2) The [Touch Sounds] setting under [Setup] in the GT10 configuration settings in GTWIN is set to [Disabled]. 	<ol style="list-style-type: none"> 1) Change the setting to [Enabled]. 2) Change the setting to [Enabled]. 	<p>GTWIN HELP</p> <p>page 82</p>
Buzzer sounds continuously	Bit F of the first word in the basic communication area bit device is set to ON.	Set the F bit to OFF on the PLC side. (Do not use the basic communication area with ladder programs.)	page 122
Backlight color changes / flashes	Bits A and B, and Bit D, of the first word (backlight color setting) in the basic communication area bit device are set to ON. Or, Bits C and D (backlight flashing setting) are set to ON.	Perform correct bit operations on the PLC side. (Do not use the basic communication area with ladder programs.)	page 122

Problem	Cause	Solution	Related
Cannot transfer data from GTWIN	1) The screen transfer cable is not connected. 2) The PC and GT10 COM. port are connected.	1) Confirm that the screen transfer cable is correctly and firmly connected. 2) Connect to TOOL port with screen transfer cable.	GTWIN HELP
* Screen is blank (power supply and substitution settings above are correct) * An incorrect screen is displayed (error codes and erroneous date and time items noted above do not apply) * Switch doesn't work (grid and validity settings noted above are correct)	An error has occurred in the GT10 system.	1) After confirming the safety of the device, etc., turn off the power supply and then turn it on again. The GT10 CPU will be reset. 2) If 1) produces no change, bring up the system menu and initialize the memory (F-ROM), then transfer data again from GTWIN to the GT10. CAUTION: When doing this, all base screen data, GT10 setting data, keyboard screen data, and bitmap data will be lost. Before doing this, make sure all data has been backed uppage 3) If 2) produces no change, set the operating mode setting switches 2, 3 and 4 on the rear of the GT10 to ON and reset the power supply. CAUTION: When doing this, all of the contents will revert to those in effect at the time of shipping, and all of the GT10 memory contents will be cleared. Before doing this, make sure all data has been backed uppage	page 89

9.2 What to Do If Something Unusual Occurs (GT30)

Problem	Cause	Solution	Related
Screen is blank	<ol style="list-style-type: none"> 1) Power is not on. 2) (When only lamp and message parts are configured to the base screen) Value of substitute reference device value does not exist in substitute data. 	<ol style="list-style-type: none"> 1) Supply 24V DC power to unit. 2) Check the address of the substitute reference device and the device values on the PLC side. 	<p>page 21</p> <p>GTWIN HELP</p>
Error code [ER**] appears at the top right of the screen	An error has occurred in communication between the GT30 and an external device (e.g. PLC).	[Troubleshooting error codes] are listed on page 142. Refer to this section for details.	page 142
Screen displays [No Screen data]	There is no base screen data in the GT30. (Appears even when GT30 configuration data exists.)	Transfer base screen data from GTWIN.	GTWIN HELP
Screen displays [Screen No. Error]	<ol style="list-style-type: none"> 1) Screen settings from the PLC, the GT30's switch part or the auto-paging indicate an unregistered screen number. 2) When bringing up the keyboard screen during data input, an unregistered keyboard screen number was specified. 3) GT30 configuration data and keyboard screen data exist in the GT30, but there is no base screen data. 	<ol style="list-style-type: none"> 1) Create and register screen content or specify the correct screen number. 2) Create and register keyboard screen or specify the correct keyboard number. 3) Transfer base screen data from GTWIN. 	<p>page 118</p> <p>GTWIN HELP</p> <p>GTWIN HELP</p>
Screen displays [Memory is Full]	The total capacity of transferred base screen data exceeds capacity of the GT30. (Monochrome: 1.5 M bytes, color: 3.25 M bytes)	Delete part of the base screen data so that the total capacity doesn't exceed the capacity of GT30. Data capacity can be checked by going to [View (V)] → [Memory Usage Conditions] on GTWIN menu bar.	GTWIN HELP
An unspecified screen appeared / there is trouble when switching screens	<ol style="list-style-type: none"> 1) The screen specification in the PLC screen setting, the GT30 switch part or the auto-paging is wrong. 2) The startup screen is specified in the GT30 configuration settings (GTWIN). 3) An erroneous device or value is specified in the first word of the basic communication area word device. 	<ol style="list-style-type: none"> 1) Specify the correct screen number. 2) Check the start-up screen setting for the GT30 configuration settings in GTWIN. Delete unnecessary settings and re-transfer configuration data. 3) Check the device content specified on the PLC side in the first word of the basic communication area. (Do not use the basic communication area with ladder programs.) 	<p>page 118</p> <p>page 115</p> <p>page 37 to page 38</p>
Screen doesn't switch	<ol style="list-style-type: none"> 1) No screen number has been written to the screen setting area (the first word in the basic communication area word device) from the PLC. 2) The screen number to which you are attempting to switch has already been written from the PLC to the screen setting area (the first word in the basic communication area word device). 	<ol style="list-style-type: none"> 1) Specify correct screen number. 2) Refer to page 119 [If the screen does not change as expected]. (Do not use the basic communication area with ladder programs.) 	<p>page 118</p> <p>page 119</p>

Problem	Cause	Solution	Related
Screen is dim	<ol style="list-style-type: none"> 1) The power voltage may be low. 2) The contrast is set too low. 3) The backlight is off due to the [Backlight Auto-off] setting in the [Setup] of the GT30 configuration settings in GTWIN. 	<ol style="list-style-type: none"> 1) Supply 24V DC 0.5 A. 2) Bring up the system menu and adjust the contrast. 3) Touching any area of the screen lights that area. If a switch part is set on the touched area, the area will not light even if touched. To change the setting, change the content of the backlight auto-off settings. 	<p>page 21</p> <p>page 126</p> <p>page 121</p>
Backlight goes off too quickly	The backlight auto-off timer setting is too short.	Change the backlight auto-off timer setting.	page 121
Date / time display is incorrect	<ol style="list-style-type: none"> 1) The GT30 internal clock is incorrect. 2) No battery has been inserted. 3) The battery insulation sheet has not been removed. 4) The battery has run down. 5) The PLC's internal calendar timer used as a reference is incorrect. 	<ol style="list-style-type: none"> 1) Bring up the system menu and adjust the clock. 2) Open the cover on the option compartment and install a battery. 3) Open the cover on the option compartment and remove the battery insulation sheet. 4) Replace the battery. 5) Adjust by rewriting the value in the PLC's internal calendar timer. 	<p>page 127</p> <p>page 130</p> <p>page 130</p> <p>All PLC manuals</p>
Hold PLC Device data content isn't saved	<ol style="list-style-type: none"> 1) No battery has been inserted. 2) The battery insulation sheet has not been removed. 3) The battery has run down. 	<ol style="list-style-type: none"> 1) Open the cover on the option compartment and install a battery. 2) Open the cover on the option compartment and remove the battery insulation sheet. 3) Replace the battery. 	<p>page 130</p> <p>page 130</p>
Touch panel doesn't work	<ol style="list-style-type: none"> 1) The switch part size setting does not match the touch panel grid. 2) Valid conditions have been set for the switch part, but those conditions have not been met. (Applies only to custom parts.) 	<ol style="list-style-type: none"> 1) When creating screens with GTWIN, match grid settings to touch panel and make them valid, then resize. 2) Check that the device status conditions on the PLC side are valid. 	<p>GTWIN HELP</p> <p>GTWIN HELP</p>
No operating sounds are heard when the touch panel is pressed.	<ol style="list-style-type: none"> 1) The [Switch Sounds] setting under [Options] in the switch part attributes is set to [Disabled]. 2) The [Touch Sounds] setting under [Setup] in the GT30 configuration settings in GTWIN is set to [Disabled]. 	<ol style="list-style-type: none"> 1) Change the setting to [Enabled]. 2) Change the setting to [Enabled]. 	<p>GTWIN HELP</p> <p>page 122</p>
Buzzer sounds continuously	Bit F of the first word in the basic communication area bit device is set to ON.	Set the F bit to OFF on the PLC side. (Do not use the basic communication area with ladder programs.)	page 124
Backlight color changes / flashes	Bits C and D, of the first word (backlight flashing setting) in the basic communication area bit device are set to ON.	Perform correct bit operations on the PLC side. (Do not use the basic communication area with ladder programs.)	page 124

Problem	Cause	Solution	Related
Cannot transfer data from GTWIN	1) The screen transfer cable is not connected. 2) The PC and GT30 COM. port are connected.	1) Confirm that the screen transfer cable is correctly and firmly connected. 2) Connect to TOOL port with screen transfer cable.	GTWIN HELP
* Screen is blank (power supply and substitution settings above are correct) * An incorrect screen is displayed (error codes and erroneous date and time items noted above do not apply) * Switch doesn't work (grid and validity settings noted above are correct)	An error has occurred in the GT30 system.	1) After confirming the safety of the device, etc., turn off the power supply and then turn it on again. The GT30 CPU will be reset. 2) If 1) produces no change, bring up the system menu and initialize the memory (F-ROM), then transfer data again from GTWIN to the GT30. CAUTION: When doing this, all base screen data, GT30 setting data, keyboard screen data, and bitmap data will be lost. Before doing this, make sure all data has been backed uppage 3) If 2) produces no change, set the operating mode setting switches 2, 3 and 4 on the rear of the GT30 to ON and reset the power supply. CAUTION: When doing this, all of the contents will revert to those in effect at the time of shipping, and all of the GT30 memory contents will be cleared. Before doing this, make sure all data has been backed uppage	page 130

9.3 Error Codes and How to Handle Them

When an error occurs in the GT series, an error code displays at the top right of the screen. There are two types of error codes:

- GT series error codes
- PLC error codes



9.3.1 GT Series Error Codes

When connected to a FP series PLC

The following three types of error codes are displayed when there is an error in the GT main unit:

Code no.	Content	Cause and solution
FF	Time up error No response from the PLC.	1) The PLC connection cable is disconnected. Check the connection cable to make sure it is connected. 2) There is a temporary error due to noise, etc. Re-supply power to the PLC and GT main unit.
21	Data error A data error occurred during communication.	1) An error exists in the communication condition settings. Check the PLC and GT main unit communication speed and transfer format. 2) There is a temporary error due to noise, etc. Re-supply power to the PLC and GT main unit.
22	Overrun error The GT main unit cannot receive data.	The reception buffer in the GT main unit is overflowing. There could be an error in the PLC. Re-supply power to the PLC and GT main unit.

When connected to a PLC (FX) series made by Mitsubishi Electric

The following four types of error codes are displayed when there is an error in the GT main unit:

Code no.	Content	Cause and solution
FF	Time up error No response from the PLC.	Check the connection cable to make sure it is connected.
10	Data error A data error occurred during communication.	Check to see if there is an error in the communication parameters settings.
12	Overrun error The GT main unit cannot receive data.	The problem may be caused by a runaway PLC.
61	PLC error A NAK error has been returned by the PLC.	Check the PLC settings.

Connecting to a PLC made by Omron

The following three types of error codes are displayed when there is an error in the GT main unit:

Code no.	Content	Cause and solution
00	Time up error No response from the PLC.	Check the connection cable to make sure it is connected.
10	Data error A data error occurred during communication.	Check to see if there is an error in the communication parameters settings.
12	Overrun error The GT main unit cannot receive data.	The problem may be caused by a runaway PLC.

Error codes other than the above correspond to error codes for an Omron PLC.

9.3.2 PLC Error Codes

Error codes which are sent from the PLC are listed in the table below. For details, please refer to the separate [Computer Communication Unit Introductory Manual].

Code no.	Content	Cause and solution
21	Data error A data error occurred during communication.	<ol style="list-style-type: none"> 1) There is an error in the communication condition settings. Check the PLC and GT10 communication speed and transfer format. 2) There is a temporary error due to noise, etc. Re-supply power to the PLC and GT10.
22	Overrun error The PLC isn't receiving data.	The CPU unit's reception buffer is overflowing. There could be an error in the PLC. Re-supply power to the PLC and GT10.
40	BCC error A data error occurred during communication.	<ol style="list-style-type: none"> 1) There is a temporary error due to noise, etc. Re-supply power to the PLC and GT10. 2) There is an error in the CPU unit. Re-supply power to the PLC and GT10. 3) See note.
41	Format error The PLC has been sent a command that doesn't match the protocol.	<ol style="list-style-type: none"> 1) There is a temporary error due to noise, etc. Re-supply power to the PLC and GT10. 2) There is an error in the CPU unit. Re-supply power to the PLC and GT10. 3) See note.
42	NOT support error The GT10 has sent a non-supported command to the PLC.	<ol style="list-style-type: none"> 1) There is a temporary error due to noise, etc. Re-supply power to the PLC and GT10. 2) There is an error in the CPU unit. Re-supply power to the PLC and GT10. 3) See note.
53	BUSY error The PLC is currently processing another command.	A large amount of data is being communicated with another RS232C port on the PLC. Wait until the error is gone.
61	Data run error There is an error in the register or relay number.	A register or relay number which doesn't exist in the PLC was specified during screen creation using GTWIN. Correct the output device being used with the part, or the transfer of clock data to an external device.



◆ NOTE

For some older GT models, the cable may be too long. Try shortening the cable to max. 10 meters.

9.4 GT10 Screen Messages

In addition to screen data, the GT10 also displays the following messages.

When transferring data from personal computer to a GT10

This is displayed when data is being transferred from the computer to the GT10.



When transferring data from GT10 to a personal computer

This is displayed when data is being transferred from the GT10 to the computer.



When there is no base screen data

This is displayed when there is no base screen data. (It is displayed even if the configuration data has been sent.)

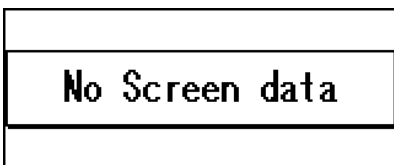

When the specified screen does not exist

This is displayed in cases such as when there is no data for a specified screen number. (For detailed information, see page 136.)

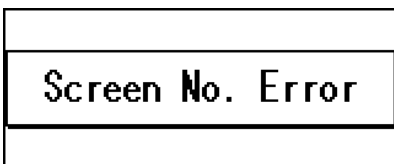

When the screen memory is full

This is displayed if the internal user memory (F-ROM) is full.

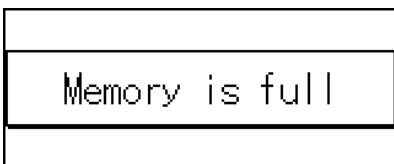

9.5 GT30 Screen Messages

In addition to screen data, the GT30 also displays the following messages.

When transferring data from personal computer to a GT30

This is displayed when data is being transferred from the computer to the GT30.



When transferring data from GT30 to a personal computer

This is displayed when data is being transferred from the GT30 to the computer.



When there is no base screen data

This is displayed when there is no base screen data. (It is displayed even if the configuration data has been sent.)

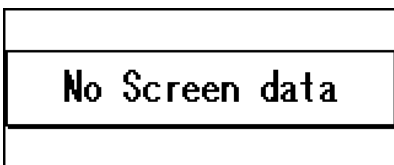

When the specified screen does not exist

This is displayed in cases such as when there is no data for a specified screen number. (For detailed information, see page 139.)

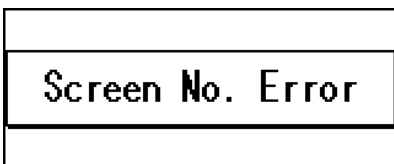

When the screen memory is full

This is displayed if the internal user memory (F-ROM) is full.

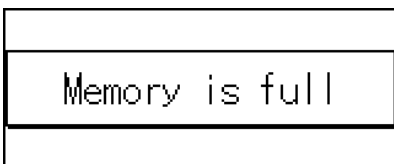

Part II

Screen Creation Tool

Terminal GTWIN

Before Using Terminal GTWIN

This section contains special precautions that should be read if you are using GTWIN for the first time. Please be sure to read it carefully.

Precautions Before Using GTWIN

Usage Environment and GT Main Unit Models that are Supported

Please confirm the environment in which GTWIN is being used.

Applicable Environment

Operating system — Windows 95 (OSR2 (Ver. 4.00.950B) or higher)/98/Me/NT
(Ver. 4.0 or higher)/2000

Required hard disk capacity — 50 Mbyte or more

Recommended CPU — Pentium II 300 MHz or more

Recommended memory — 64 Mbyte or more

Recommended screen resolution — 800 x 600 min.

Recommended display colors — 256 colors min.



◆ CAUTION

- **In order to use the Help function**
Internet Explorer 4.0 (or a subsequent version) by Microsoft must be installed in order to use GTWIN Help function. If you do not have the appropriate version of Internet Explorer, it can be downloaded from the Microsoft home page on the Web.
(Particular caution is required if using Windows 95 or NT.)
- **If using Windows 2000 or NT**
Please be aware that GTWIN cannot be installed unless you log in at the Administrator level when booting the system.

Applicable GT models

GTWIN is supported by the GT10 and GT30 series.

- **True Type fonts**
True Type fonts are drawn, and font characters ornamented, using the functions provided in Windows. Please be aware that, because of this, the fonts may be displayed somewhat differently, depending on the Windows version and computer model.

Special Precautions

Important Note About Saving Screen Data Files

The following measures should be taken to protect against data loss in the event that screen data files become damaged or missing.

Always back up screen data files.

Screen data saved in the GT main unit could possibly be destroyed by noise in the system. To protect against such a loss, screen data files which have been created should be backed up and saved in both a personal computer and on a floppy disk. (Data destroyed by noise cannot be retrieved.)

Make hard copies of your data.

Files which have been created should always be printed out and a hard copy stored in a safe place, in case programs are lost or data is inadvertently destroyed.

Chapter 10

Preparing GTWIN

10.1 Installing GTWIN

In order to use GTWIN:

- Windows 95 (OSR2 (Ver. 4.00.950B) or higher), Windows 98, Windows Me, NT (Ver. 4.0 or a subsequent version) or 2000 must be installed in the computer.
- The computer in which GTWIN is being installed must have at least 20 Mbyte of hard disk space available.

GTWIN is installed in a personal computer using the procedure outlined below. This explanation assumes that Windows is installed in the C: drive and that the CD drive is the E: drive. If your drives are configured differently, or if you are installing the program over a network, enter the appropriate drive name for your configuration.

Procedure:

1. **Exit any applications currently running.**
2. **Insert the setup CD into the CD-ROM drive.**
3. **Click on the “Start” button at the lower left of the screen, or press Cntl + ESC to display the Windows menu.**
4. **Select “Run”.**



5. Enter the name of the file on which the function is to be run, e.g. E:\Setup.exe.

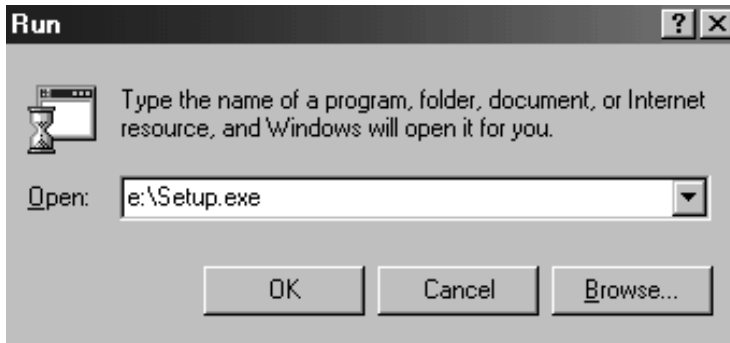

6. Click [OK].
A confirmation message is displayed.

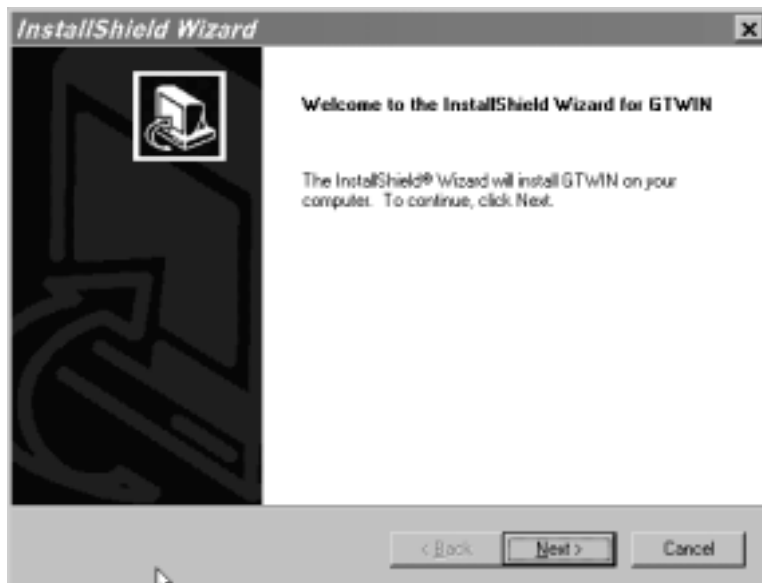

7. Confirm the contents and click [Next]. To interrupt the installation, click [Cancel].

8. Confirm the licensing agreement by clicking [Yes].

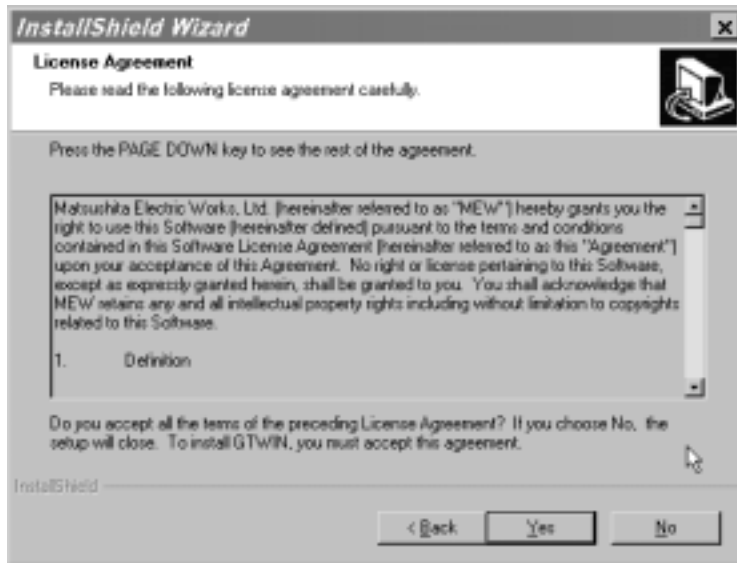

The setup process begins. (Selecting [No] cancels GTWIN setup.)

9. Register the user information.



The serial number is noted on the user card included in GTWIN package. Make sure it is entered correctly. **Make sure you keep a copy of the serial number in a safe place for future reference.**

The contents entered here can be confirmed under “Version Information” on the splash screen, and in the Help function, when GTWIN is booted.



Never eject the CD during the installation process.

10. Click [Next].
11. Select the installation destination.

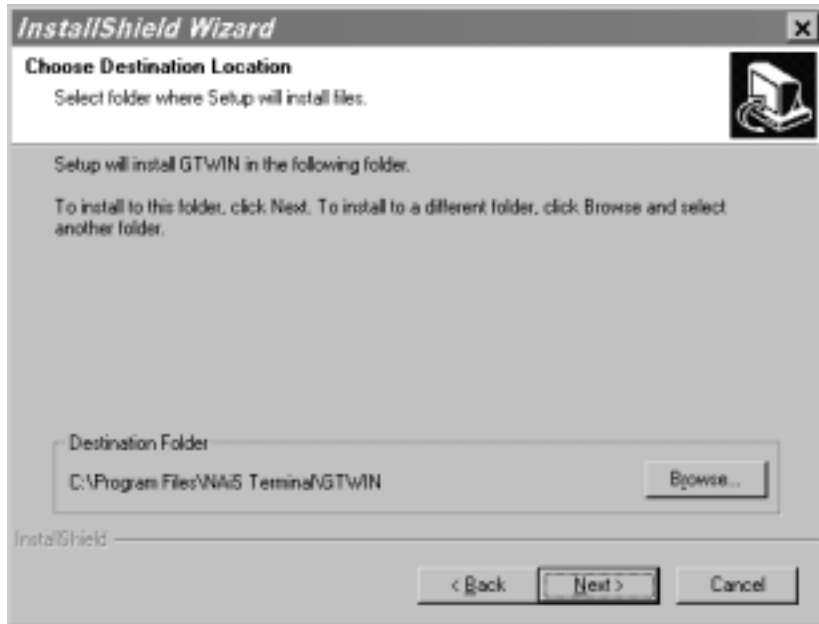

A dialog box is displayed where the folder to which GTWIN is to be installed can be confirmed. To install the program in the displayed folder, click on the [Next] button.

The displayed destination, "c:\ProgramFiles\NAiS Terminal\GTWIN", can be used just as it is. To install the program in a different folder, click on the [Browse] button and specify a folder.

12. Select the program folder.

The displayed name, "NAIS Terminal", can be used just as it is. To use a different folder name, simply enter that name.

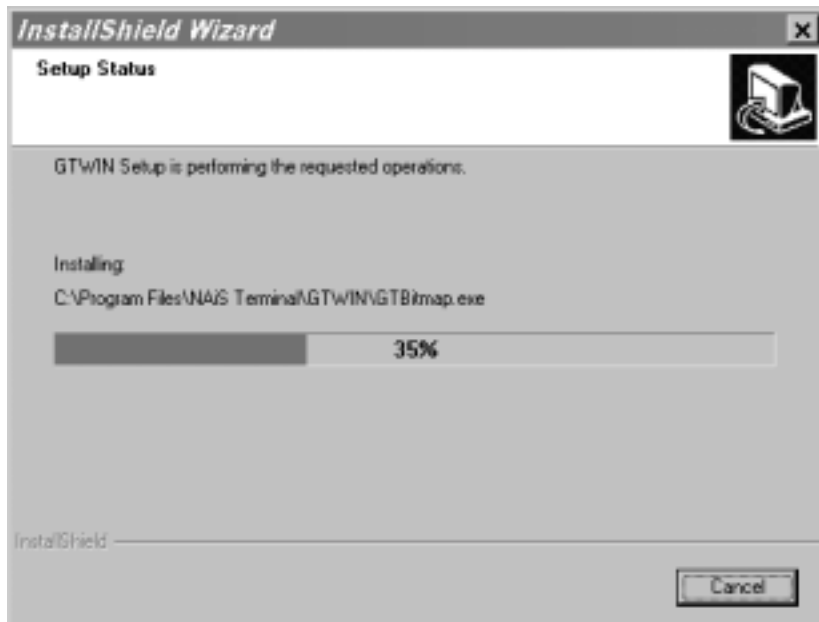
13. After selecting a program folder, click [Next].

The installation process begins.

14. When this screen is displayed, click [OK].

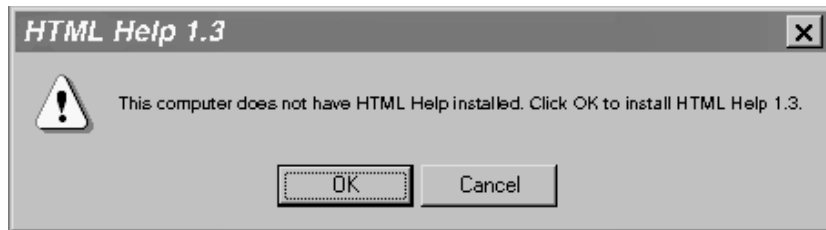

When the installation has been completed, a message like that shown here is displayed. Click on [OK]. The application required in order to access the Help function is installed. If this message does not appear, reboot the computer as described in step 15.

15. Reboot the computer.



When all of the process has been completed, a dialog box is displayed, confirming that the computer will be rebooted.

To use GTWIN, the computer must first be rebooted. Make sure this is done before attempting to use the program.

10.2 Booting GTWIN

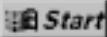
Click on the Windows  button and then select “Program”, “NAiS Terminal”, and “GTWIN” on the displayed Windows menu, in that order.

10.2.1 Selecting the Working Menu

When GTWIN is booted, a startup menu like that shown below is displayed on the screen. Turn on one of the three radio buttons and click on [OK].

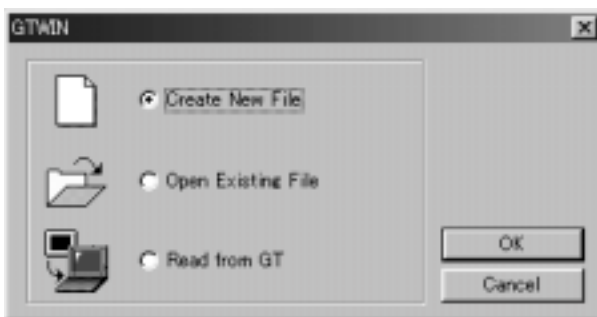

Create New File
Select this to create new screen data.

Open Existing File
Select this to read and edit screen data saved to a disk.
An Open File dialog box is displayed on the screen. Select a file to edit.

Read From GT
Select this to read and edit screen data saved to the GT10.

10.2.2 Selecting the Model

If “Create New File” or “Read From GT” is selected from the startup menu, a dialog box like that shown below is displayed, where the model can be selected. Click on the pull-down list button [] to the right of the display window, and select the model of PLC or GT being used. Then click on [OK].



PLC Model

– Matsushita MEWNET-FP Series

Select this if the GT10 is connected to the MEWNET-FP Series.

– General-Purpose serial

Select this if the GT10 is connected to a general-purpose RS232C device such as a personal computer or microcomputer board.

– Mitsubishi FX series

Select this when connecting to the FX series of PLCs made by Mitsubishi Electric.

– Omron C series

Select this when connecting to the C series of PLCs made by Omron Corporation.

GT Model

– GT10 monochrome

– GT10 (vertical) monochrome

– GT30 Monochrome

– GT30 color

10.2.3 Entering Settings for the Basic Communication Area to PLC

Before creating a screen, always enter the settings for the basic communication area to the PLC. For detailed instructions on entering settings, see page 29 (GT10) and page 37 (GT30).

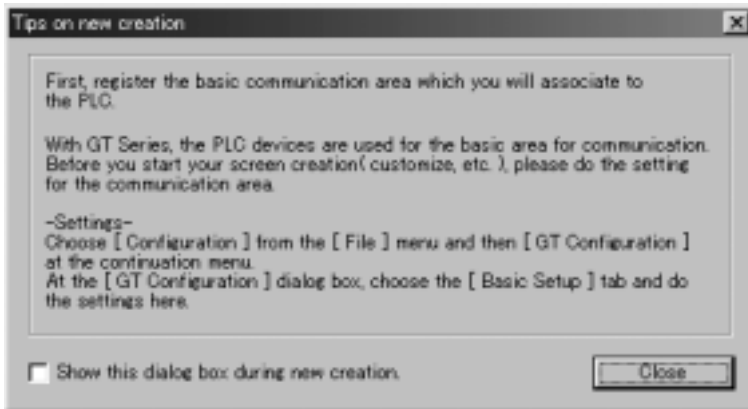

10.3 Exiting GTWIN

To exit GTWIN, follow the prescribed procedure.

Procedure:

1. Select [Exit] on the “File” menu.



2. Save the file.

If screen data has been edited but has not yet been saved, a message like that shown below is displayed on the screen. Click [Yes] to save the data.

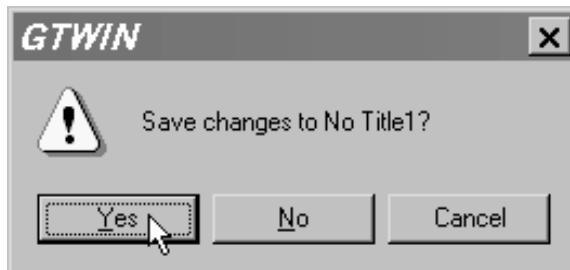

◆ KEY POINTS

GTWIN can also be exited by pressing [Alt] + [F4], or by clicking on the “Close” box at the upper right of GTWIN screen.

10.4 Procedures for Using GTWIN

If you are using GTWIN for the first time, follow the procedure outlined below.

Procedure:

1. Boot GTWIN.

Click on the menu items in the following sequence: “Start Menu” → “Programs” → “NAiS Terminal” → “GTWIN” → “GTWIN”. This boots GTWIN and displays a dialog box where the job can be selected. Select “New” to create a new file.

2. Select the model being used.

A model selection dialog box is displayed. Select the model of PLC and GT as indicated below.

– PLC Model: MEWNET–FP Series, or a general–purpose serial device (personal computer, microcomputer board, etc.), Mitsubishi FX series and Omron C series

– GT Model: GT10 monochrome, GT30 monochrome, GT30 color

3. Specify the basic communication area to the PLC.

When creating a new file, a basic communication area for the PLC must be set. A message dialog box is displayed on the screen. Follow the instructions to specify the basic communication area.

Click on “File (F)” on the menu bar, and then on “Configuration” and “GT Configuration”. This displays a dialog box where the GT main unit configuration settings can be entered.

Use the “Setup” tab to specify the basic communication area to the PLC.



If you are creating a new screen, select “GT10 Mode”, and if you are substituting a screen from an earlier model, select “IOP01 Mode”.

– If using the GT10 mode, specifying the first addresses for the word device and bit device reserves three consecutive words.

– If using the IOP01 mode, match the first address to the “System Area” of the earlier model.



For detailed information on the basic communication area to the PLC, and on the map, see page 29 (GT10) and page 37 (GT30).

4. Enter the GT configuration settings, and transfer the file to the GT main unit.

If contents other than “Basic communication area to the PLC” are being changed from the default values in the GT configuration settings, enter the various settings. When the settings have been entered, send the configuration settings file to the GT main unit.



For information on entering and transferring GT configuration settings, see “GT10 Setup Procedure” on page 26, “GT10 Configuration Settings” on page 72, “GT30 Setup Procedure” on page 34, “GT30 Configuration Settings” on page 107.

5. Open a base screen from the Screen Manager.

With the above step, preparation is now complete. The “Screen Manager” indicates the screen file itself, and the numerous small buttons each indicate an individual base screen (screen creation screen).

Opening and closing base screens

Either double-click on the button for the number of the screen to be created, or select the button and click on [Open]. This opens the base screen.

Clicking on the [Close] button  of the base screen closes the screen. If a screen has been created on the base screen, the contents of the screen will be saved to the computer memory, and a red mark will appear on the button.

Copying, moving, and deleting base screens

Select the base screen to be copied, moved, or deleted, and then press the “Copy”, “Move”, or “Delete” button. Multiple screens can be selected (simply select them consecutively). (They are possible between different screen files, however.)

Displaying the Screen Manager

To display the Screen Manager, select whether a map-type (default) or a list-type display is preferred. Then select “View (V)” on the menu bar, followed by “Screen Manager Display Method”. Select the preferred method. If a list-type display is selected, use “Base Screen” on the menu bar and then “Set Screen Attributes” to display a list of names.

6. Create the text and graphics for the screen.

To create text and graphics on a base screen, use the “Toolbox” under the tool bar.

Writing text



Clicking on the [Text] button  in the toolbox changes the mouse pointer to an “I” mark, enabling text input at any desired point on the base screen.

To exit from the input mode, click on the “Select”  button.

To change the text size and the color, use the [Font] button .

Drawing graphics

The buttons in the toolbox can be used to draw graphics. To exit from the input mode, click on the “Select”  button.

To change the color, use the [Graphic Color] button , and to change the type of line, use the [Line Type] button .

Filling in enclosed fields

Clicking on the [Fill] button  fills in a field enclosed by lines.

7. Arrange the parts on the screen.

Using the parts function, specify functions such as switches, data displays, and keyboards on the base screen. To use the parts function, select “Parts” on the menu bar, and then click on “Open Parts Library”. This displays a “Select Parts Library” screen. Normally, the “Standard” parts library is used.



For information on the differences between the various parts libraries and on using the parts function, see GTWIN Help function.

8. Save the screen file.

Save the screen file that has been created.

Click on "File" on the menu bar, and then on "Save As".

The "Save File" message dialog box is displayed. Confirm the contents carefully, and then save the file under any desired file name.

 With GTWIN, multiple files are saved (although treated as a single file by GTWIN). Because of this, a folder with the same name as the name of the file is automatically created in GTWIN when the file is saved, under the folder to which the file is being saved, and multiple files are saved in that folder. Please be aware of this when saving files.

9. Transfer the file to the GT.

Send the screen file that has been created to the GT, by clicking on "File" on the menu bar, and then on "Transfer".

 For information on how to transfer screen files, please refer to GTWIN Help function.

10. Print the screen contents.

– Clicking on "File" on the menu bar and then on "Print" displays a dialog box where the screen file can be printed.

– Clicking on "File" on the menu bar and then on "Print Pattern" displays a dialog box where the print pattern can be specified.

– To enter printer settings, click on "File" on the menu bar and then on "Printer Setup (R)".

 For information on printing methods, setting print patterns, and entering printer settings, please refer to GTWIN Help function.

Appendix A

Code Tables

A.1 BIN/HEX/BCD Code Correspondence Table

Decimal	Hexadecimal	Binary	BCD code
0	0000	00000000 00000000	0000 0000 0000 0000
1	0001	00000000 00000001	0000 0000 0000 0001
2	0002	00000000 00000010	0000 0000 0000 0010
3	0003	00000000 00000011	0000 0000 0000 0011
4	0004	00000000 00000100	0000 0000 0000 0100
5	0005	00000000 00000101	0000 0000 0000 0101
6	0006	00000000 00000110	0000 0000 0000 0110
7	0007	00000000 00000111	0000 0000 0000 0111
8	0008	00000000 00001000	0000 0000 0000 1000
9	0009	00000000 00001001	0000 0000 0000 1001
10	000A	00000000 00001010	0000 0000 0001 0000
11	000B	00000000 00001011	0000 0000 0001 0001
12	000C	00000000 00001100	0000 0000 0001 0010
13	000D	00000000 00001101	0000 0000 0001 0011
14	000E	00000000 00001110	0000 0000 0001 0100
15	000F	00000000 00001111	0000 0000 0001 0101
16	0010	00000000 00010000	0000 0000 0001 0110
17	0011	00000000 00010001	0000 0000 0001 0111
18	0012	00000000 00010010	0000 0000 0001 1000
19	0013	00000000 00010011	0000 0000 0001 1001
20	0014	00000000 00010100	0000 0000 0010 0000
21	0015	00000000 00010101	0000 0000 0010 0001
22	0016	00000000 00010110	0000 0000 0010 0010
23	0017	00000000 00010111	0000 0000 0010 0011
24	0018	00000000 00011000	0000 0000 0010 0100
25	0019	00000000 00011001	0000 0000 0010 0101
26	001A	00000000 00011010	0000 0000 0010 0110
27	001B	00000000 00011011	0000 0000 0010 0111
28	001C	00000000 00011100	0000 0000 0010 1000
29	001D	00000000 00011101	0000 0000 0010 1001
30	001E	00000000 00011110	0000 0000 0011 0000
31	001F	00000000 00011111	0000 0000 0011 0001
63	003F	00000000 00111111	0000 0000 0110 0011
⋮	⋮	⋮	⋮
255	00FF	00000000 11111111	0000 0010 0101 0101
⋮	⋮	⋮	⋮
9999	270F	00100111 00001111	1001 1001 1001 1001

A.2 ASCII Code Table

								b7									
								b6	0	0	0	0	1	1	1	1	
								b5	0	0	1	1	0	0	1	1	
								b4	0	1	0	1	0	1	0	1	
b7	b6	b5	b4	b3	b2	b1	b0	ASCII HEX code	Most significant digit								
									0	1	2	3	4	5	6	7	
				0	0	0	0	Least significant digit	0	NUL	DEL	SPACE	0	@	P	'	p
				0	0	0	1		1	SOH	DC ₁	!	1	A	Q	a	q
				0	0	1	0		2	STX	DC ₂	"	2	B	R	b	r
				0	0	1	1		3	ETX	DC ₃	#	3	C	S	c	s
				0	1	0	0		4	EOT	DC ₄	\$	4	D	T	d	t
				0	1	0	1		5	ENQ	NAK	%	5	E	U	e	u
				0	1	1	0		6	ACK	SYN	&	6	F	V	f	v
				0	1	1	1		7	BEL	ETB	'	7	G	W	g	w
				1	0	0	0		8	BS	CAN	(8	H	X	h	x
				1	0	0	1		9	HT	EM)	9	I	Y	i	y
				1	0	1	0		A	LF	SUB	*	:	J	Z	j	z
				1	0	1	1		B	VT	ESC	+	;	K	[k	{
				1	1	0	0		C	FF	FS	,	<	L	¥	l	
				1	1	0	1		D	CR	GS	-	=	M]	m	}
				1	1	1	0		E	SO	RS	.	>	N	^	n	~
				1	1	1	1		F	SI	US	/	?	O	_	o	DEL

Index

A

ASCII code table, 167

B

Backlight, GT30, 133

Basic communication area, 29, 37

Battery, Backup

GT10, 128

GT30, 130

BIN/HEX/BCD code table, 166

Bit device functions

GT10, 122

GT30, 124

C

Cable

PLC communication

D-sub 9-pin, 48, 49, 51, 52, 53,
55, 56

Mini-DIN 5-pin, 44, 46, 50, 57

PLC connection, xvi, xvii

Screen transfer, xvii

COM. port

FP-M, 56

FP-Sigma, 42

FP0, 45

FP1, 48

FP10SH, 52

FP2/FP2SH, 49

internal wiring, 9

Wiring, 23

Configuration settings

GT10, 72

GT30, 94

D

Dimensions

GT10, 11

GT30, 12

DIP switches

See also Operation mode setting
switches

GT10, 91

GT30, 114

E

Error codes, 142

GT10, GT30, 142

PLC, 144

F

FP-M, Connect, 56

FP-Sigma, Connect, 42

FP0, Connect, 45

FP1, Connect, 48

FP10SH, Connect, 52

FP10SH/FP3 CCU, 55

DIP switch settings, 55

FP2/FP2SH, Connect, 49

FP2/FP2SH CCU

Connect, 51

DIP switch settings, 51

FPWIN GR, 60

FPWIN Pro, 60

Front panel, Protective sheet, 131

G

GTWIN

- Booting, 158
- Exiting, 160
- Installing, 152
- Precautions, 149, 150
- Using the first time, 161

I

Installation, 16

- GT10, 17
- GT30, 19

M

Mitsubishi PLC, Connect, 62

O

Omron PLC, Connect, 64

Operation mode setting switches

- GT10, 6
- GT30, 8

P

Parts

- GT10, 5
- GT30, 7

Power supply

- Terminals, 10
- Wiring, 21

S

Screen messages

- GT10, 145
- GT30, 146

Setup

- GT10, 26
- GT30, 34

Specifications, 2

Switching screens, 116

T

Through function, 60

TOOL port

- FP-M, 57
- FP-Sigma, 43
- FP0, 46
- FP10SH, 53
- FP2/FP2SH, 50
- internal wiring, 9

Troubleshooting

- GT10, 136
- GT30, 139

W

Wiring

- COM. port, 23
- Power supply, 21

Record of Changes

Manual No.	Date	Description of Changes
ARCT1F340E	NOV. 2001	First edition
ARCT1F340V1.0END	JAN. 2002	First European edition
ARCT1F340V1.1EN	MAY 2003	Mini-DIN 5-pin loose-wire cable: color information corrected

GLOBAL NETWORK



North America

Aromat Corporation

Europe

Matsushita Electric Works

Asia Pacific

Matsushita Electric Works

China

Matsushita Electric Works

Japan

Matsushita Electric Works Ltd. Automation Controls Group

Europe

- **Europe** **Matsushita Electric Works (Europe) AG**
Rudolf-Diesel-Ring 2, D-83607 Holzkirchen, Tel. (08024) 648-0, Fax (08024) 648-111, www.mew-europe.com
- **Austria** **Matsushita Electric Works Austria GmbH**
Josef Madersperger Straße 2, A-2362 Biedermannsdorf, Austria, Tel. (02236) 2 68 46, Fax (02236) 46133, www.matsushita.at
- **Benelux** **Matsushita Electric Works Benelux B. V.**
De Rijn 4, (Postbus 211), 5684 PJ Best, (5680 AE Best), Netherlands, Tel. (0499) 37 2727, Fax (0499) 372185, www.matsushita.nl, www.matsushita.be
- **France** **Matsushita Electric Works France S.A.R.L.**
B.P. 44, F-91371 Verrières le Buisson CEDEX, France, Tél. 01 60 13 57 57, Fax 01 60 13 57 58, www.matsushita-france.fr
- **Germany** **Matsushita Electric Works Deutschland GmbH**
Rudolf-Diesel-Ring 2, 83607 Holzkirchen, Germany, Tel. (08024) 648-0, Fax (08024) 648-555, www.matsushita.de
- **Ireland** **Matsushita Electric Works UK Ltd. Irish Branch Office**
Waverley, Old Naas Road, Bluebell, Dublin 12, Republic of Ireland, Tel. (01) 460 09 69, Fax (01) 460 11 31, www.matsushita.ie
- **Italy** **Matsushita Electric Works Italia s.r.l.**
Via del Commercio 3-5 (Z.I. Ferlina), I-37012 Bussolengo (VR), Italy, Tel. (045) 675 27 11, Fax (045) 670 04 44, www.matsushita.it
- **Portugal** **Matsushita Electric Works Portugal España S.A. Portuguese Branch Office**
Avda 25 de Abril, Edificio Alvorada 5º E, 2750-512 Cascais, Portugal, Tel. (21) 482 82 66, Fax (21) 482 74 21
- **Scandinavia** **Matsushita Electric Works Scandinavia AB**
Sjöängsvägen 10, 19272 Sollentuna, Sweden, Tel. +46 8 59 47 66 80, Fax (+46) 8 59 47 66 90, www.matsushita.se
- **Spain** **Matsushita Electric Works España S.A.**
Parque Empresarial Barajas, San Severo, 20, 28042 Madrid, España, Tel. (91) 329 38 75, Fax (91) 329 29 76, www.matsushita.es
- **Switzerland** **Matsushita Electric Works Schweiz AG**
Grundstrasse 8, CH-6343 Rotkreuz, Switzerland, Tel. (041) 799 70 50, Fax (041) 799 70 55, www.matsushita.ch
- **UK** **Matsushita Electric Works UK Ltd.**
Sunrise Parkway, Linford Wood East, Milton Keynes, MK14 6LF, England, Tel. (01908) 231 555, Fax (01908) 231 599, www.matsushita.co.uk

North & South America

- **USA** **Aromat Corporation Head Office USA**
629 Central Avenue, New Providence, N.J. 07974, USA, Tel. 1-908-464-3550, Fax 1-908-464-8513, www.aromat.com

Asia

- **China** **Matsushita Electric Works, Ltd. China Office**
2013, Beijing Fortune, Building 5, Dong San Huan Bei Lu, Chaoyang District, Beijing, China, Tel. 86-10-6590-8646, Fax 86-10-6590-8647
- **Hong Kong** **Matsushita Electric Works Ltd. Hong Kong**
Rm1601, 16/F, Tower 2, The Gateway, 25 Canton Road, Tsimshatsui, Kowloon, Hong Kong, Tel. (852) 2956-3118, Fax (852) 2956-0398
- **Japan** **Matsushita Electric Works Ltd. Automation Controls Group**
1048 Kadoma, Kadoma-shi, Osaka 571-8686, Japan, Tel. 06-6908-1050, Fax 06-6908-5781, www.mew.co.jp/e-acg/
- **Singapore** **Matsushita Electric Works (Asia Pacific) Pte. Ltd.**
101 Thomson Road, #25-03/05, United Square, Singapore 307591, Tel. (65) 6255-5473, Fax (65) 6253-5689

Free Manuals Download Website

<http://myh66.com>

<http://usermanuals.us>

<http://www.somanuals.com>

<http://www.4manuals.cc>

<http://www.manual-lib.com>

<http://www.404manual.com>

<http://www.luxmanual.com>

<http://aubethermostatmanual.com>

Golf course search by state

<http://golfingnear.com>

Email search by domain

<http://emailbydomain.com>

Auto manuals search

<http://auto.somanuals.com>

TV manuals search

<http://tv.somanuals.com>