



MOTOROLA



9500 PORTABLE TELEPHONE
USER'S GUIDE



IRIDIUM

World Service

Getting Started

1. Insert the SIM card.
2. Remove battery cover.

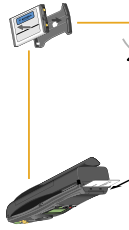

3. Install the battery.



4. Attach the battery compartment cover or optional cellular cassette.



5. Charge the battery.

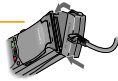

6. Attach the antenna.

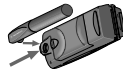

9500 PORTABLE QUICK REFERENCE

Quick Access Menu

Available from satellite mode only.

1. Find Name
2. Check Signal
3. Call Voicemail
4. Show Battery Meter
5. Lock Phone Now
6. Turn Vibrate Alert On/Off
7. Read Messages
8. Register Now
9. Forwarding On/Off

Phone Book

Add a number to the phone book:

1. Enter the phone number and then press **OK**.
2. Press **Left** to scroll to the desired memory type and then press **OK**.
3. Press **Left** to accept the number.
4. Enter a name, using **Left** and **Right** keys to enter letters and **OK** to scroll between letters. Press **Left** as many times as necessary to reach desired letter. When name is complete, press **OK**.
5. Enter a three-digit location number, and then press **Left** or **Right** to store the entry in the next empty memory location.

Recall a number from the phone book:

1. Press **OK**.
2. Enter the three-digit location number of the entry, and then press **OK**.
3. Press **Left** to call the displayed entry.

Recall last ten numbers dialed:

1. Press **OK** until you see Phone Book, and then press **Left**.
2. Press **Left** to scroll to Last Ten Calls, and then press **Left** to select.
3. Press **Left** to scroll to Last Calls Made and then press **Left** to select.
4. Press **Left** to scroll to the number you are looking for.
5. Press **Left** to place a call to that number.

Basic Operation

Turn the phone's power on/off:

Press and hold **Power**.

Place a call:

Extend and rotate the antenna, enter the phone number, and then press **Call**.



Answer a call:

Extend and rotate the antenna, open the keypad cover, and then press **Call**.

End a call:

Press **End** or close the keypad cover.

Special Features

Adjust earpiece volume:

Press upper and lower volume keys on the side of the phone.

Adjust ring volume:

Press **Up** and then the upper and lower volume keys on the side of the phone.

Clear the last digit in the display or exit a sub-menu:

Press **Clear**.

Clear the entire display or exit the menu system:

Press and hold **Power**.

Unlock the phone:

Enter your 4-digit unlock code (supplied to you by your service provider).

Display your phone number:

Press **Phone**.

Switch modes:

1. Press **Mode** until you see Mode Selection, and then press **Left**.
2. Press **Left** to scroll to Cellular Preferred, Satellite Preferred, Cellular Always or Satellite Always.
3. Press **Left** to select.

Antenna Lock
Release Button

Current State of
Service Indicator

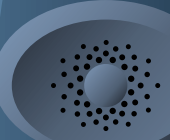

Signal Strength
Indicator

Earpiece

Volume
Keys

Real Time
Clock

Battery Level
Indicator

Display
Indicators

Display

SIM Card
Eject



Special Keys

Alphanumeric
Keypad

Battery Compartment/
Cellular Cassette Port



Special Keys

Microphone

SIM Card
Port

Accessory
Connector

Keypad
Cover

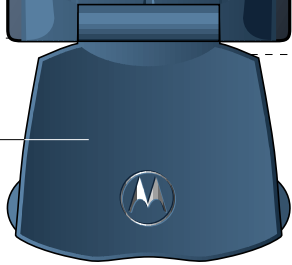

Options Menu Quick Reference

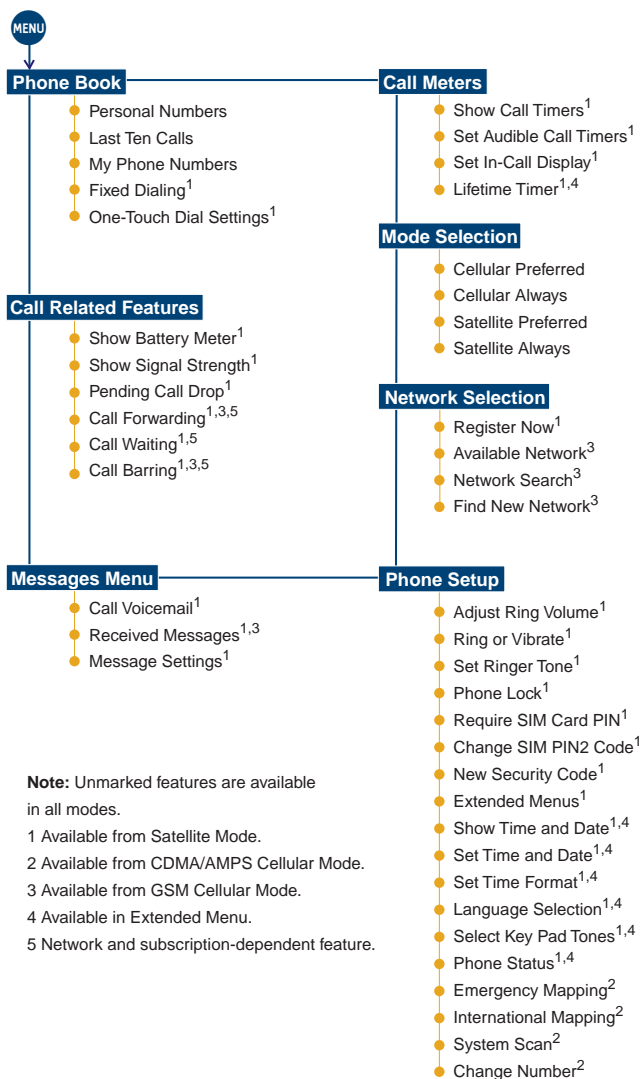

Note: Unmarked features are available in all modes.

1 Available from Satellite Mode.

2 Available from CDMA/AMPS Cellular Mode.

3 Available from GSM Cellular Mode.

4 Available in Extended Menu.

5 Network and subscription-dependent feature.

Welcome

The future of global telecommunications is here—a satellite telephone, providing you with communication all over the world.

The company that brought you the world's first commercially available cellular phone has done it again! Motorola proudly introduces its Satellite Series™ 9500 Portable Phone for the Iridium® system.

All Motorola wireless phones are designed and manufactured to meet Motorola's exacting specifications and world-class quality standards. During development, our laboratory testing team took the durable phone through rigorous durability tests including temperature, humidity, shock, dust, vibration, and drop tests—and it still worked! We're confident that the phone you purchased meets your own exacting standards.

Thank you for choosing Motorola, a global leader in communications technology.

Enjoy your new Satellite Series™ 9500 Portable Phone!



MOTOROLA

Personal Communications Sector
600 North U.S. Highway 45
Libertyville, Illinois 60048
In the US & Canada: 1-888-839-4647
Outside the US & Canada (Toll-Free Global Number):
+1-8000-839-4647
Direct Dial: +1-847-523-1898
TTY Toll-Free Number: 1-888-390-6456
TTY (outside the United States): +1-847-523-1841
Monday through Friday 7AM to 7PM (CST)

+ designates international dialing access code

, **MOTOROLA**, VibraCall, and Satellite Series are registered trademarks of Motorola, Inc.

Iridium, the Iridium logo, and Iridium World Service are registered trademarks and/or service marks of Iridium LLC.

©1998 Motorola, Inc.

Printed in U.S.A.

Contents

Welcome	1
Safety Information	7
Overview	11
Guide Overview	12
Phone Overview	14
The Indicators	17
Original Satellite Series Accessories	20
Getting Started	25
Attaching the Satellite Antenna	26
What Is a SIM Card?	27
Installing the SIM Card	28
Removing the Battery Covers	29
Installing the Battery	30
Charging the Battery	34
Checking the Battery	36
Battery Information	38
Installing the Cellular Cassette	39
Using Your Phone	41
Using Your Phone Feature Overview	42
Powering Up the Phone	43
Holding the Phone	45
Placing Calls	46
What's My SIM Card Phone Number?	50
Receiving Calls	51
Adjusting Earpiece Volume	53
Adjusting Ringer Volume	54
Using In-Call Features	55
In-Call Feature Overview	56
Muting a Call	57
Using Call Waiting	58
Placing a Call on Hold	60
Sending a Flash	62
Using the Menus	63
Using the Options Menus	64
Using the Quick Access Menu	66
Using The In-Call Menu	68

Managing the Phone Book	69
Entering the Phone Book Menu	70
Phone Book Feature Overview	71
What's on the Phone Book Menu?	72
Organizing Your Phone Book	74
Storing Names and Numbers	76
Entering Names	78
Using Pauses in Numbers	80
Using Phone Number Prefixes	82
Recalling Entries	83
Calling, Modifying, or Erasing an Entry	85
Checking Phone Book Capacity	86
Preventing Access to the Phone Book	87
Restricting Phone Use	88
Viewing the Last Ten Numbers Dialed	93
Viewing and Modifying Phone Numbers	94
One-Touch Dialing	96
Using Calling Features	97
Entering the Call Related Features Menu	98
Call Related Features Overview	99
What's on the Call Related Features Menu?	100
Forward Calls When Unavailable	102
Forward All Your Calls	104
Detailed Call Forwarding	106
Cancel All Forwarding	109
Showing the Battery Meter	110
Showing Signal Strength	111
Deactivating Pending Call Drop Signal	112
Activating Call Waiting	113
Restricting Calls with Call Barring	114
Using Message Services	119
Entering the Messages Menu	120
Messages Services Feature Overview	121
What's on the Messages Menu?	122
Checking Your Voicemail	124
Storing Your Voicemail Number	125
Managing Your Messages	126
Accessing Messages	128

Customizing Phone Features	131
Entering the Phone Setup Menu	132
Phone Setup Feature Overview	133
What's on the Phone Setup Menu?	134
Setting the Phone to Ring or Vibrate	137
Setting the Ringer Tone	138
Setting the Keypad Tones	139
Locking and Unlocking Your Phone	140
Protecting the SIM Card	142
Managing Other Security Settings	144
Managing Time and Date Settings	146
Activating Extended Menus	149
Selecting the Display Language	150
Managing Your Phone's Settings	151
Cellular Mode Settings	154
Accessing the Network	159
Entering the Network Menu	160
Network Feature Overview	161
What's on the Network Menu?	162
Registering With the Satellite Network	164
Cellular Mode (GSM) Settings	165
Selecting a Mode	169
Entering the Mode Selection Menu	170
Mode Selection Feature Overview	171
What's on the Mode Selection Menu?	172
Selecting a Mode	173
Selecting Satellite Mode	174
Timing Your Calls	177
Entering the Call Meters Menu	178
Call Meters Feature Overview	179
What's on the Call Meters Menu?	180
Showing Call Timers	181
Setting Audible Call Timers	183
Showing the In-Call Timer	185
Show the Lifetime Timer	186
Customizing the Menu System	187
Personalizing the Options Menu	188
Personalizing the Quick Access Menu	190

Menu Quick Reference	191
Phone Book Menu	192
Call Related Features Menu	194
Messages Menu	196
Phone Setup Menu	198
Network Selection Menu	200
Network Selection Menu	201
Troubleshooting	203
Glossary	207
Index	211
Patent Information	219

Safety Information

Exposure to Radio Frequency Signals

Your wireless handheld portable telephone is a low power radio transmitter and receiver. When it is ON, it receives and also sends out radio frequency (RF) signals.

International agencies have set standards and recommendations for the protection of public exposure to RF electromagnetic energy.

- International Commission on Non-Ionizing Radiation Protection (ICNIRP) 1996
- Verband Deutscher Elektrotechniker (VDE) DIN-0848
- United States Federal Commission, Radio Frequency Exposure Guidelines (1996)
- National Radiological Protection Board of the United Kingdom, GS 11, 1988
- American National Standards Institute (ANSI) IEEE. C95.1-1992
- National Council on Radiation Protection and Measurements (NCRP). Report 86
- Department of Health and Welfare Canada. Safety Code 6

These standards are based on extensive scientific review. For example, over 120 scientists, engineers, and physicians from universities, government health agencies, and industry reviewed the available body of research to develop the updated ANSI Standard.

The design of your phone complies with these standards when used normally.

Antenna Care

Use only the supplied or an approved replacement antenna. Unauthorized antennas, modifications, or attachments could damage the phone and may violate local agency regulations.

Phone Operation

NORMAL POSITION: Hold the phone as you would any other telephone. Make sure the antenna is extended fully and rotated to either the left or right detente. The antenna should be vertical to the ground and have a clear view of the sky.

TIPS ON EFFICIENT OPERATION: For your phone to operate most efficiently:

- Extend and rotate your antenna fully.
- Make sure the antenna has a clear view of the sky.
- Do not touch the antenna unnecessarily when the phone is in use. Contact with the antenna affects call quality and may cause the phone to operate at a higher power level than otherwise needed.

Batteries

Caution: All batteries can cause property damage, injury or burns if a conductive material, such as jewelry, keys or beaded chains, touches exposed terminals. The material may complete an electrical circuit and become quite hot. To protect against such unwanted current drain, exercise care in handling any charged battery, particularly when placing it inside your pocket, purse or other container with metal objects. When the battery is detached from the phone, your batteries are packed with a protective battery cover; please use this cover for storing your batteries when not in use.

Driving

Check the laws and regulations on the use of wireless telephones in the areas where you drive. Always obey them. Also, if using your phone while driving, please:

- Give full attention to driving -- driving safely is your first responsibility;
- Use hands-free operation, if available;
- Pull off the road and park before making or answering a call if driving conditions so require.

Electronic Devices

Most modern electronic equipment is shielded from RF signals. However, certain electronic equipment may not be shielded against the RF signals from your wireless phone.

Pacemakers

The Health Industry Manufacturers Association recommends that a minimum separation of six (6) inches be maintained between a handheld wireless phone and a pacemaker to avoid potential interference with the pacemaker. These recommendations are consistent with the independent research by and recommendations of Wireless Technology Research.

Persons with pacemakers:

- Should ALWAYS keep the phone more than six inches from their pacemaker when the phone is turned ON;
- Should not carry the phone in a breast pocket;
- Should use the ear opposite the pacemaker to minimize the potential for interference;
- If you have any reason to suspect interference is taking place, turn your phone OFF immediately.

Hearing Aids

Some digital wireless phones may interfere with some hearing aids. In the event of such interference, you may want to consult your hearing aid manufacturer to discuss alternatives.

Other Medical Devices

If you use any other personal medical device, consult the manufacturer of your device to determine if they are adequately shielded from external RF energy. Your physician may be able to assist you in obtaining this information.

Turn your phone OFF in health care facilities when any regulations posted in these areas instruct you to do so. Hospitals or health care facilities may be using equipment that could be sensitive to external RF energy.

Vehicles

RF signals may affect improperly installed or inadequately shielded electronic systems in motor vehicles. Check with the manufacturer or its representative regarding your vehicle. You should also consult the manufacturer of any equipment that has been added to your vehicle.

Posted Facilities

Turn your phone OFF in any facility where posted notices so require.

Aircraft

Airline regulations prohibit using your phone while in the air.

Switch OFF your phone before boarding an aircraft.

Blasting Areas

To avoid interfering with blasting operations, turn your phone OFF when in a blasting area or in areas posted:

- Turn off two-way radios.
- Obey all signs and instructions.

Potentially Explosive Atmospheres

Turn your phone OFF and do not remove your battery when you are in any area with a potentially explosive atmosphere. Obey all signs and instructions. Sparks from your battery in such areas could cause an explosion or fire resulting in bodily injury or even death.

Areas with a potentially explosive atmosphere are often but not always clearly marked. They include, but are not limited to: fueling areas such as gasoline stations; below deck on boats; fuel or chemical transfer or storage facilities; areas where fuel odors are present (for example, if a gas/propane leak occurs in a car or home); areas where the air contains chemicals or particles, such as grain, dust, or metal powders; and any other area where you normally would be advised to turn off your vehicle engine.

For Vehicles Equipped with an Air Bag

An air bag inflates with great force. DO NOT place objects, including both installed or portable wireless equipment, in the area over the air bag or in the air bag deployment area. If in-vehicle wireless equipment is improperly installed and the air bag inflates, serious injury could result.

Overview

This chapter provides an overview of your new satellite phone.

What You'll Learn

- overview of the user's guide
- overview of the satellite phone
- overview of the phone's indicators
- overview of the original Satellite Series™ accessories

Guide Overview

Understanding the Guide

Modes

Throughout this guide there are features that apply only to satellite mode and features that apply only to cellular mode (when you have an optional Cellular Cassette installed). For information on switching modes, see “Selecting a Mode” on page 169.

These conventions alert you to these features.

—This symbol next to a feature name indicates that your phone must be in satellite mode to access it.

—This symbol next to a feature name indicates that your phone must be in cellular mode to access it.

In addition look for the labels “**Satellite Mode**” or “**Cellular Mode**” in the margins for information related to each mode.

Key Presses

Key presses are represented in this guide using symbols so that you may locate and use the required sequence quickly. A sequence of key presses may be shown as follows:



This means you should press  followed by  and then , in sequence, not simultaneously.

Prompts and Messages



Your phone responds to key presses by displaying either a prompt that guides you to the next action or a message confirming that your action is complete. Prompts and messages are represented in this guide in LCD style, for example: `Enter PIN` or `Completed`.

Tips

In the margins of your guide are useful hints and ways to improve your phone's performance.

What's in the Guide?









As you explore your 9500 Portable Phone, use this guide to see what key to press and what happens when you press it. Here is what you'll learn in each chapter:

Chapter	Description
Getting Started	In this chapter, we'll show you how to install and charge your battery. Turn to page 25 to get started.
Using Your Phone	How do you make your first phone call? We'll answer this and more in this section. Go to "Using Your Phone" on page 41 for more information.
Using the Menus	Turn to page 63 to learn about how to use the menu system. This chapter teaches you how to navigate the menu system.
Managing the Phone Book	Turn to page 69 to learn how to make the most of your phone's built-in Phone Book.
Using Calling Features	If you subscribe to Call Barring, or Call Forwarding, turn to page 97 to learn how to use these network features and more.
Using Messaging Services	Did you know that you can be notified of voicemail or receive numeric and text messages through your Personal Mailbox? Turn to page 119.
Customizing Phone Features	Learn how to customize your phone's features in this chapter. Go to page 131.
Accessing the Network	Turn to page 159 to learn how to register with the satellite or cellular network, depending on your mode.
Switching Modes	If you have a Cellular Cassette installed in your portable phone, you can switch between cellular mode and satellite mode. See page 169.
 Timing Your Calls	View the time of your last call or set your phone to remind you after you've been talking for a certain amount of time. Go to page 177.
 Customizing Menus	Once you are familiar with the features in your menus, you can then begin to customize your menus to more closely fit your needs. See page 187.

Phone Overview



Special Keys

Key	Function
	turns the phone's power on and off
	displays messages
	selects menu settings or options, or initiates and answers calls
	stores numbers in the phone book
	recalls numbers from the phone book
	enters the Quick Access Menu when you are in satellite mode
	enters the Options Menu and scrolls forward through menu features
	clears characters from the screen or exits the Options Menu
	scrolls through the menu features

Volume Keys

The Volume keys are on the side of the phone. They adjust earpiece and ringer volume. For information on adjusting your volume, see page 53.

SIM Card Eject

The SIM card eject button is on the side of your phone. See "Remove the SIM Card" on page 28.

Satellite Antenna

When you are in satellite mode, to answer calls, make calls, and access satellite services, make sure the antenna is rotated up to either the left or right detente and fully extended. You can receive calls without extending and rotating the antenna, but you must do so to answer the call. Remember, the antenna must have a clear view of the sky.

When you are in cellular mode you do not need to extend or rotate the satellite antenna.

Satellite Antenna Lock Release Button

This button is located on the top of the phone. When you push this button, it releases the antenna so you can use the satellite phone with the 9570 Portable Dock or attach the Auxiliary Antenna. You may also want to remove the antenna if you spend a lot of time in cellular mode.

Cellular Cassette Connector

Insert an optional Cellular Cassette onto the back of the phone. The Cellular Cassette connector is located underneath the battery compartment cover next to the battery. The Cellular Cassette interfaces with your 9500 Portable Phone so that you can use it on the local cellular network.

Keypad Cover

Rotate and extend the antenna and open the keypad cover to answer an incoming call in satellite mode. If you are in cellular mode, you can just open the keypad cover to answer a call. Close the keypad cover to end a call. When the keypad cover is closed, the exposed keys on the keypad are inactive.

The Display

Your phone's Liquid Crystal Display (LCD) displays as many as four rows of 16 characters. When your phone has been idle a few seconds, the display's backlight is turned off.

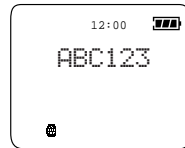

The LCD on your phone may respond slowly to key presses in extremely cold temperatures. This is normal and does not affect the phone operation in any way.

Accessory Connector

This connector, located on the bottom of the phone, provides the connection for an external power supply.





The Indicators







Current State of Service Light

The current state of service light is located at the top of your phone. With the keypad cover closed, this LED status indicator provides information on your phone's current state of service depending on your current mode.

If the LED is...	Then in satellite mode...	Then in cellular mode...
Alternating red and green	A call is incoming.	A call is incoming.
Flashing green	You are receiving a signal from the Iridium satellite network. You can place and receive calls.	You are receiving a signal from the cellular network. You can place and receive calls.
Flashing yellow	Your phone was not successful in registering with the satellite network and cannot receive incoming calls. Try again in a few minutes.	You are roaming.
Flashing yellow and red	Your SIM card may be inserted incorrectly, may not be inserted, or you may be in a restricted area.	You will not see this indicator in cellular mode.
Flashing red	Service is not available.	This means that service is not available, your SIM card is inserted incorrectly or not at all, or you may be in a restricted area.

Display Indicators

Indicator	Description
	<p>Signal Strength Indicator indicates the strength of the signal from the network. The more segments displayed in the bar graph, the stronger the signal.</p> <p>When you are in satellite mode, you can also check the strength of the signal at any time through the menu. See page 111.</p>
	<p>Battery Charge Indicator indicates the strength of the battery charge. The more segments displayed, the greater the battery charge.</p> <p>When you are in satellite mode, you can also check the strength of the charge at any time through the menu. See page 110.</p>
12:00	<p>Real Time Clock Indicator displays the time in either 12-hour or 24-hour format when you are in satellite mode. For more information, see page 147.</p>
	<p>Message Indicator appears when you receive a new message when you are in satellite mode or in GSM cellular mode. It flashes when the SIM card is full. See "Accessing Messages" on page 128.</p>
	<p>Satellite Mode Indicator appears when your phone is in satellite mode. See "Selecting a Mode" on page 169.</p>

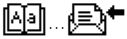
Indicator	Description
	<p>Home System Indicator appears when you are in your home cellular system (when you have the appropriate Cellular Cassette inserted) or when the phone has successfully registered with the Iridium satellite system.</p>
	<p>Roam Indicator appears when you are roaming on a cellular system (when you have the appropriate Cellular Cassette inserted). This indicator does not appear when the phone is in satellite mode.</p>
	<p>No Service Indicator appears when your phone is not capable of placing or receiving calls.</p>
	<p>In Use Indicator appears when a call is in progress.</p>
	<p>Scroll Bar appears on the right of the display when you are in a menu. The button on the scroll bar indicates where you are in the list.</p>
	<p>Check Mark indicates a menu item is currently selected.</p>
	<p>Quick Access Menu Icons allow you to easily identify Quick Access features as you scroll through the Quick Access Menu when you are in satellite mode.</p>

Original Satellite Series Accessories

Product appearance and specifications are subject to change without notice.

AC Travel Charger with International Plug Kit



The AC Travel Charger with International Plug Kit provides rapid charge for optimal performance and can be used to power the phone when the battery is depleted.

- Includes four international plug adapters for use in Europe, Australia, India, and the United Kingdom
- May be used with both 9500 Portable Phone and Desktop Charger
- Allows use of 9500 Portable Phone while recharging the battery
- Convenient self-storing cord
- Charges StarTAC™ wireless phone when used with optional StarTAC Adapter

Desktop Charger

The versatile, user-friendly Desktop Charger features two charger pockets to provide multiple rapid charging options.

- Front pocket charges 9500 Portable Phone or StarTAC wireless phone with batteries attached (with included plastic insert)
- Back pocket charges any Motorola Satellite Series or StarTAC wireless phone battery
- Rapid 3-hour charge time for standard battery
- At-a-glance LED indicator lights show current charging status for each charging pocket
- Requires AC Travel Charger or Auto Accessory Adapter

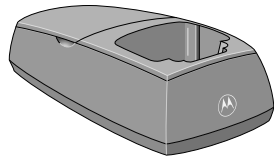

Solar Charger



Efficient, easy-to-use Solar Charger helps keep you in communication even in remote areas or locations with limited, erratic, or no power service.

- Uses solar power to recharge batteries or extend talk time
- Convenient, built-in stand allows angle adjustment
- Easy-to-read LCD metering system indicates optimal positioning of charging module for best performance
- Controller provides proper voltage by regulating energy flow between Solar Charger and phone
- Convenient, self-storing cable connector

Auto Accessory Adapter

Restores full battery power for 9500 Portable Phone operation or Desktop Charger functions from any operating vehicle (using standard 12-volt accessory port)

- Make and receive phone calls using the Auto Accessory Adapter for direct power when batteries are depleted
- Recharge battery while using Desktop Charger or attached to 9500 Portable Phone
- Charges StarTAC wireless phone with optional StarTAC Adapter



Batteries

Standard Capacity Lithium Ion Battery



- Provides up to 2 hours of talk time or 16 hours of standby time*
- Weighs 2.3 ounces/66 grams

High Capacity Lithium Ion Battery



- Provides up to 3.2 hours of talk time or 24 hours of standby time*
- Weighs 3.4 ounces/98 grams

Ultra High Capacity Lithium Ion Battery



- Provides up to 5.5 hours of talk time or 48 hours of standby time*
- Weighs 7 ounces/200 grams

* All talk and standby times are approximate and depend on network configuration, signal strength and the features selected.

StarTAC Adapter

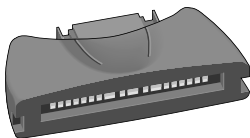

Extend your communication options using the StarTAC Adapter to charge StarTAC wireless phones via the Auto Accessory Adapter or the AC Travel Adapter.

Portable Auxiliary Antenna

From one car to another, this compact pocket-sized antenna with convenient magnetic mount goes in every vehicle you do to provide improved reception.

- use with the 9500 Portable Phone
- reliable magnetic mount, ceramic patch antenna
- attached 1.5-meter cable



Antenna Adapter



Provides required external antenna connection to 9500 Portable Phone or 9570 Portable Dock and is compatible with the Portable Auxiliary Antenna.

Carry Accessories



Leather Holster

This high-quality leather case helps protect the phone. It has a removable belt clip and a lanyard wrist strap.

Lanyard Wrist Strap

The lanyard wrist strap is made of nylon. It provides a convenient way to carry your phone.

Cellular Cassettes

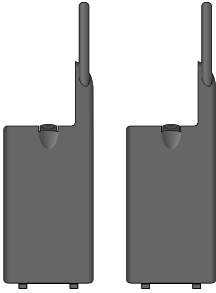

Cellular Cassettes are modules that when attached to the 9500 Portable Phone supports various terrestrial or land-based cellular systems. With an attached Cellular Cassette, you can make and receive calls in various cellular modes, assuming service subscription and coverage are available.

Cellular Cassettes create an innovative blend of cellular and satellite technology in one phone.

- When attached to the back of the 9500 Portable Phone, Cellular Cassettes enable dual mode satellite and cellular operation.
- Cellular Cassettes are designed to give you one flexible product that enables communication compatibility in areas that support cellular service in conjunction with satellite service.
- Cellular Cassettes enable flexible usage of cellular technologies and provide call delivery compatibility in areas that support cellular service.

9570 Portable Dock

The Satellite Series 9570 Portable Dock enables the 9500 Portable Phone operation in a flexible configuration using either the available AC/DC line power or auto accessory adapter:

- Fixed unit for in building usage (Requires use of external antenna)
- Charges 9500 Portable Phone while docked
- Auxiliary SIM Card for shared-use environment
- Lightweight Passive Handset for private communications
- Speakerphone for teleconferencing





* Product appearance and specifications are subject to change without notice.

Getting Started

Getting started with your new satellite phone is easy. Just charge your new batteries and insert your phone's SIM (Subscriber Identity Module) card. This chapter tells you how.

What You'll Learn

- attaching the antenna
- installing and charging your battery
- installing and using your SIM card
- installing your optional Cellular Cassette

Keep in Mind: If you see a  next to a feature, the phone must be in satellite mode. If you see a  next to a feature, the phone must be in cellular mode. See "Selecting a Mode" on page 169 to change modes.

Attaching the Satellite Antenna

Attach the Antenna

1. **Attach the antenna** in the down position.
2. **Press and hold** the button in at the top of the phone.
3. **Push the antenna until it clicks** into place and release the button.



Remove the Antenna

You may want to remove the satellite antenna to attach an auxiliary antenna, place the portable phone in the 9570 Portable Dock, or if you spend the majority of your time in cellular mode.

1. **Remove the antenna** in the down position.
2. **Press in the button** at the top of the phone.
3. **Remove** the antenna.

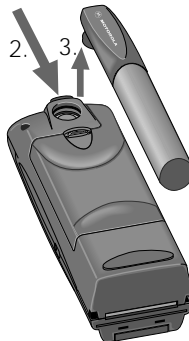

What Is a SIM Card?

Your SIM card (Subscriber Identity Module) is a smart card that contains your phone number, service details, and memory for storing Phone Book entries and messages. If you don't have your phone, you can insert your SIM card into a friend's phone and make use of your personal wireless service.

Keep in Mind: Your phone has limited functionality without the SIM card.

GSM SIM Card Capability

If you already have a GSM SIM card and your service provider has a roaming agreement with the Iridium satellite system, you can use it in your satellite telephone. You need an optional Cellular Cassette to access your local cellular/PCS service.

Keep in Mind: If you are using a GSM SIM card, you may not have access to certain features that are specific to the Iridium satellite system, and vice versa.

SIM Card Protection

Keep your SIM card in your wallet or purse when you're not using it. This helps keep your personal information secure and gives you access to your service even if you don't have your phone. If you forget your phone, insert your SIM card into a friend's phone to access your personal service.

Caution: Avoid bending, scratching, or exposing your card to static electricity, water, or dirt.

Installing the SIM Card

Make sure your phone is powered off before inserting or removing the SIM card. If you don't, you may damage the memory on your SIM card.

Tip: Make sure the side with the gold plate is facing up.

Insert the SIM Card

1. **Turn your phone off** by pressing and holding the  key.
2. **Insert the SIM card** into the slot at the base of the phone.



Remove the SIM Card

1. **Turn your phone off** by pressing and holding the  key.
2. **Slide the release button** toward the base of the phone.
3. **Pull the SIM card** out.

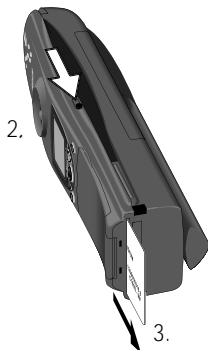

Removing the Battery Covers

Your new batteries are shipped uncharged and fitted with protective covers.

Save the covers for storing and carrying unused batteries. The covers prevent metal objects from contacting both battery terminals, reducing the risk of injury, or damage from a battery short circuit.

Remove the Battery Safety Cover

1. **Press in** the release latch.



2. **Continue pushing in and upwards** until the battery slips free from its cover.

Attach the Battery Safety Cover

1. **Lower the side** opposite the latch into the cover.



2. **Slip the side** with the release latch down until it clicks.

Installing the Battery

Insert the Battery

Keep in Mind: Insert only Motorola-approved batteries in your phone. If you insert an unapproved battery you will see *Invalid Batt.* You are able to discharge the battery, but you cannot recharge it.

Tip: The battery compartment is located on the back of the phone.

- 1. Remove or rotate the satellite antenna** before installing the battery. (See "Attaching the Satellite Antenna" on page 26.)
- 2. Press and hold the release latch** at the top of the battery compartment cover.
- 3. Pull the cover upward**, and then remove it from the phone.

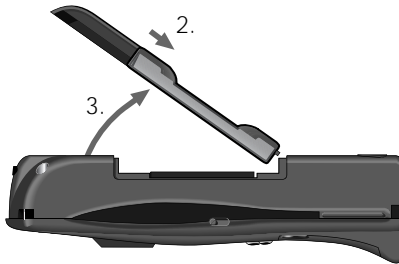

- 4. Insert the battery**, bottom-end first, into the compartment, and then press the battery downward until it clicks into place.

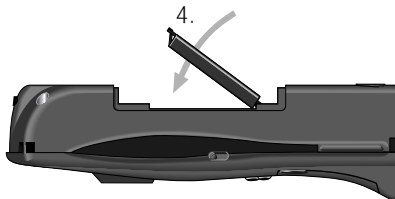

- 5. Insert the bottom end** of the compartment cover into the slots at the end of the compartment.
- 6. Snap the cover** down into place.

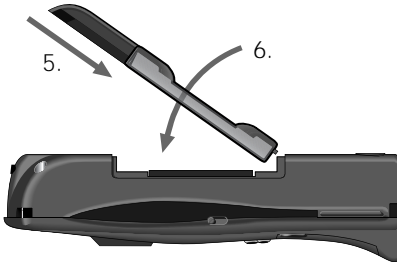

If you have an optional Cellular Cassette go to “Installing the Cellular Cassette” on page 39.

Tip: The battery compartment is located on the back of the phone.

Remove the Battery

- 1. Remove or rotate the satellite antenna** before removing the battery. (See "Attaching the Satellite Antenna" on page 26.)
- 2. Press and hold the release latch** at the top of the battery compartment cover.
- 3. Pull the cover upward**, and then remove it from the phone.

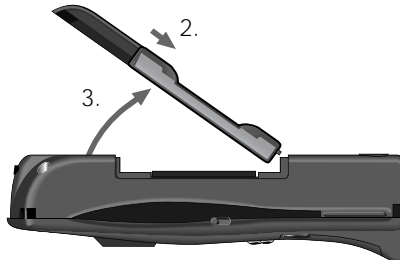

- 4. Press and hold the release latch** at the top of the battery.

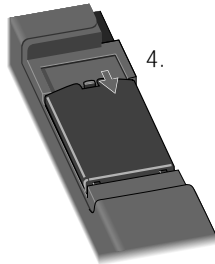

- 5. Pull the battery upward** and out of the phone.

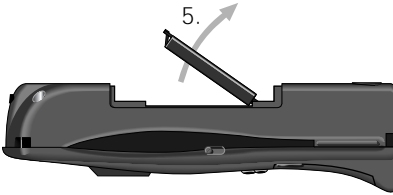

- 6. Insert the bottom end** of the battery compartment cover into the slots at the end of the compartment.

- 7. Snap the cover down** into place.

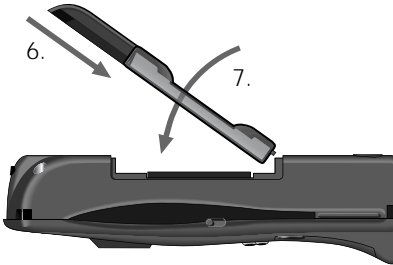

- 8. Replace** the battery cover. See "Attach the Battery Safety Cover" on page 29.

Charging the Battery

Any battery that hasn't been used for a month or more—including new batteries—should be charged for about 3–4 hours before use.

With the Desktop Charger

You can use the front pocket of the Desktop Charger to charge a battery attached to a phone. You can also charge a spare battery in the rear pocket. The front pocket charges first, then the charger switches to the rear pocket.

To charge:

- 1. Connect the Travel Charger** to the Desktop Charger.
- 2. Plug the Travel Charger** into the appropriate power source.
- 3. Insert your phone** with a battery attached.
- 4. Insert a spare battery** in the rear pocket, if desired.

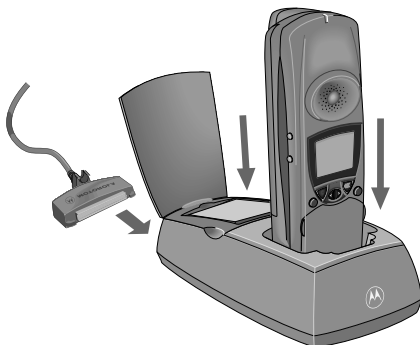

With the Internal Charger

A battery charger is built right into your phone. Using either the Travel Charger or Auto Accessory Adapter, you can plug the handset directly into a power source to charge the attached battery.

1. **Connect the Travel Charger** or Auto Accessory Adapter to the phone.

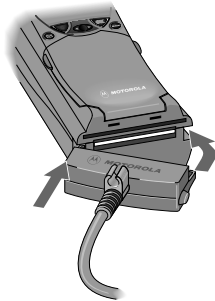

2. **Plug the Travel Charger** or Auto Accessory Adapter into the appropriate power source. The phone beeps, flashes the  indicator, and displays Charging Battery:



3. If the phone is powered on, **press**  twice to place the phone in charge-only mode.

If the phone is powered off, it automatically enters charge-only mode.

Keep in Mind: You can still place and answer calls while using the internal charger. If you wish to place or answer a call:

Press  to exit charge-only mode and return to normal operation.

Remember that talking on the phone uses power, so charging takes more time.

Checking the Battery

Satellite Mode

Low Battery Warning





When the battery level is low and only a few minutes of talk-time remains, your phone signals you in two ways:

- Low Battery appears on the display.
- A warning tone (two double beeps) sounds.

Keep in Mind: To help maintain the best battery and phone performance, recharge your battery as soon as possible after you receive the low battery warning.

Check Battery Power Status

To check your phone's power status:

1. Press , and then press  to scroll to Call Related Features.
2. Press  to select.
3. Press  to scroll to Show Battery Meter, and then press  to select.

You will see the battery charge level:



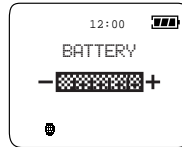

Low Charge



Full Charge

The display shows a fuel gauge. The more segments filled, the greater your battery's charge.

One of the following messages may also appear:

Message	Description
Not Available	The battery meter doesn't appear because a battery is not installed; the phone is operating from external power.
Charging Battery	The battery is being charged: <ul style="list-style-type: none">• If the phone is powered on, the  indicator flashes.• If phone is powered off, the  indicator does not appear.
Fast Charge Completed	The battery has completed charging. The  indicator stops flashing.
Invalid Batt.	You have an unapproved battery inserted in your phone. You are able to discharge the battery, but you cannot recharge it.

4. Press and hold  to exit.

You can only view the detailed battery meter while you are in satellite mode.

*Cellular
Mode*

Battery Information

For Maximum Battery Life

Caution: To prevent injuries or burns, do not allow metal objects to contact or short circuit the battery terminals.

To ensure that you enjoy maximum battery life and use your battery to its fullest capacity:

- Always use Motorola-approved battery chargers.
- Always use Motorola-approved batteries (Standard, High Capacity, Ultra High Capacity battery)
- Maintain the battery at or near room temperature when charging.
- When you don't plan on using a particular battery for a while, store the battery uncharged in a cool, dark, and dry place.
- To prolong the life of your batteries, avoid exposing them to temperatures below -30°C (-22°F) or above 60°C (140°F).
- Always take your phone with you when you leave your car.
- Use either the Standard or High Capacity battery when the Cellular Cassette is installed; the Ultra High Capacity battery does not fit when the Cellular Cassette is installed.

To Dispose of Batteries

To dispose of batteries, check with your local recycling center for a battery recycler near you. Never dispose of batteries in fire.

Installing the Cellular Cassette

Insert the Cellular Cassette

A Cellular Cassette is an optional module that attaches to your satellite phone to allow it to work with land-based cellular systems.

- 1. Remove or rotate the satellite antenna** before installing the Cellular Cassette. (See “Attaching the Satellite Antenna” on page 26.)
- 2. Press and hold the release latch** at the top of the battery compartment cover.
- 3. Pull the cover upward**, and then remove it from the phone.

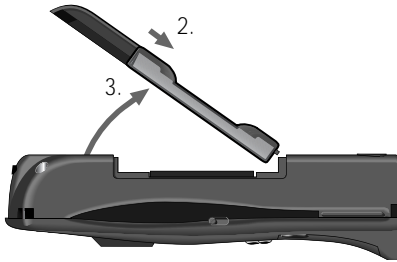

- 4. Insert the cellular cassette**, bottom-end first, into the compartment on top of the battery.
- 5. Press the cassette downward** until it clicks into place.

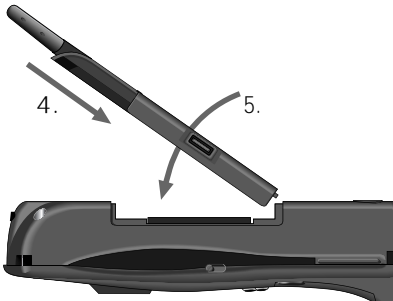

- 6. Save the battery compartment cover** for future use.

Tip: The phone switches between satellite mode and cellular mode based on your preferences. See “Selecting a Mode” on page 169.

Tip: You cannot use the Ultra High Capacity battery when the Cellular Cassette is installed.

Remove the Cellular Cassette

1. **Remove or rotate the satellite antenna** before removing the Cellular Cassette. (See “Attaching the Satellite Antenna” on page 26.)
2. **Press and hold the release latch** at the top of the cellular cassette.
3. **Pull the cassette upward**, and then remove it from the phone.

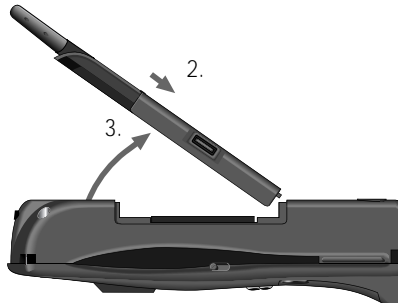

4. **Insert the bottom end** of the battery compartment cover into the slots at the end of the compartment.
5. **Snap the cover down** into place.

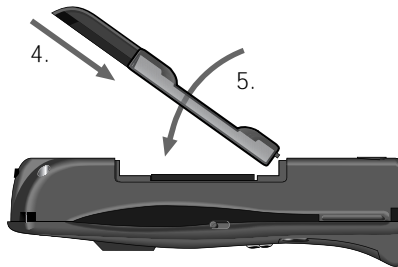



If your phone was powered on when you removed your Cellular Cassette, you will see `Cassette Removed` in your display for a few moments.

Using Your Phone

Read this section to learn how to get up and running with your new satellite phone.

What You'll Learn

- turning the phone's power on and off
- holding the phone
- placing and receiving calls
- determining your own phone number

Keep in Mind: If you see a  next to a feature, the phone must be in satellite mode. If you see a  next to a feature, the phone must be in cellular mode. See "Selecting a Mode" on page 169 to change modes.

Using Your Phone Feature Overview

Your feature selection varies depending on your mode setting. The table below shows the features available in each mode. See "Selecting a Mode" on page 169 for more information on changing modes.

Feature	Satellite	GSM	CDMA/AMPS
Adjust Earpiece and Ringer Volume	•	•	•
Automatic Redial	•		
Call a Number Embedded in a Message	•		
Dial a Number	•	•	•
Dial a Number from the Phone Book	•	•	•
Dial Numbers with Pauses	•	•	•
Dial Special Characters	•	•	•
End a Call	•	•	•
Make an Emergency Call	•	•	•*
Make an International Call	•	•	•*
Multiple Key Answer	•	•	•
Pending Call Drop	•		
Personal Mailbox	•	•	
Power Up the Phone	•	•	•
Receive a Call	•	•	•
Redial Last Number Called	•	•	•
Set to Ring or Vibrate	•		
Standby Mode	•	•	•
Unanswered Call Message	•		
What's My Phone Number	•	•	•
* You must set this feature up first in the Phone Setup Menu. SP Your service provider may have similar or additional features.			



Powering Up the Phone

Turn the Power On and Off

To turn your phone's power on:

1. **Insert your SIM card.** (See "Insert the SIM Card" on page 28.)
2. **Open the keypad cover** to expose the keypad.
3. **Press and hold**  to turn the phone on and off.

When you turn your phone's power on, it performs a self test to let you know it's operational. You may see a number of other power-on messages (see below).

When the  indicator disappears and the  appears, you are ready to start calling.

Power-On Messages

Once your phone is powered on, you may see:

Message	Description
Searching...	The phone is attempting to establish communications with the satellite or cellular network (depending on your mode). See "Accessing the Network" on page 159 for more information.
Rotate Antenna or Orient Antenna	You also hear a tone when you see these messages. Extend the antenna upward and make sure you have a clear view of the sky to continue registering.
Registering	Your phone is registering with the network. When the process is complete, you will see Registered . See "Accessing the Network" on page 159 for more information.
Enter Phone Unlock Code	Your phone was locked after the last use. Enter your four-digit unlock code and press  to proceed. See "Locking and Unlocking Your Phone" on page 140 for more information.

Message	Description
Enter PIN	Enter the four- to eight- digit SIM card PIN provided by your service provider and press  to proceed. See "Protecting the SIM Card" on page 142 for more information.
Invalid Batt.	You have an unapproved battery inserted in your phone. You are able to discharge the battery, but you cannot recharge it.
Insert Card	Power off your phone; make sure your SIM card is inserted completely; and then power your phone on again.
Insert Cassette	This message indicates that you are in a mode that requires a Cellular Cassette and the phone cannot find one. Either insert a Cellular Cassette or switch to Satellite Always mode. See "Selecting a Mode" on page 169 for more information.
Check Card	This message indicates that the SIM card is damaged or inserted the wrong way.
Check Cassette	This message indicates that the Cellular Cassette is damaged or inserted the wrong way.
Blocked	If the SIM card PIN code or PIN2 code is incorrectly entered three times in a row, your phone becomes blocked. See page 143 for information on unblocking it.
Bad Card See Supplier	Your SIM card has been damaged or incorrectly issued. Contact your service provider for information.

Standby

To conserve energy, your phone may turn off its backlight when you haven't pressed a key for a several seconds. The light reappears the next time you press a key.

Holding the Phone

1. **Extend the antenna** by pulling out on the end of it in the down position.

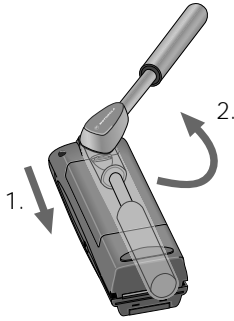

2. **Rotate the antenna** to either the left or right detente (the antenna will stop here).



When talking on the phone, the antenna should be vertical to the ground.



3. Make sure the antenna has a clear view of the sky.

Placing Calls

To place a call, your phone must be powered on, have a SIM card inserted, be unlocked, and be in contact with the satellite or cellular network (depending on your mode). See "Accessing the Network" on page 159 for network information.

Dial a Number

1. **FIRST, rotate and fully extend** the satellite antenna if you are in satellite mode. See "Holding the Phone" on page 45.
2. **Open the keypad cover** to expose the keypad.
3. **Enter the number** using the digit keys. As soon as you begin entering digits, you will see `Call?`.

When you are in satellite mode, you must enter the phone number in international format: [international access code or +] [country code] [phone number]

4. **Press **. You will see `Calling` followed by the number you dialed.

You will see either the flashing message `Calling` or the flashing messages `Calling`, followed by `Registering`, and the phone will play a series of setup tones.

if the call connects and is answered, `Connected` will appear on the display for a few seconds, followed by `End Call?`. If the call does not connect, you may see one of the following messages:

Message	Description
<code>Rotate Antenna Orient Antenna</code>	Make sure the antenna is fully extended and rotated upward and has a clear view of the sky.
<code>Call Failed System Busy Restricted Area Weak Signal</code>	The phone is unable to access the network. Try again in a few minutes.
<code>Redial?</code>	See "Automatic Redial" page 47.

Tip: If you make a mistake, press  once to delete the last digit, or press and hold  to clear all digits.

Tip: The international access code from the satellite network is 00 or +.

International Dialing

To make an international phone call:

1. Press and hold .

After a few seconds the international dialing prefix + appears in the display. This allows you to call from any country without knowing the local international access code.

2. Enter the country code followed by the phone number. The country code follows the conventional format.

Keep in Mind: If you are in CDMA/AMPS cellular mode, you must set up the international prefix mapping in order for this feature to work. See page 155 for more information.

Automatic Redial

If the number or your network is busy, you will see **Redial?** for five seconds.

Press  to redial the number automatically.

Keep in Mind: The maximum number of redial attempts is set by your service provider. If the call cannot be connected within this maximum, you will see the message **Redial Failed**.



This feature is only available in satellite mode.

*Satellite
Mode*

*Cellular
Mode*

Ending a Call



To end a call, perform one of the following tasks:

- Press .
- Close the keypad cover.
- Press .

Keep in Mind: If you rotate the satellite antenna down and you are in satellite mode, your call will be dropped.







Redial Last Number Called

Whenever your phone is on standby, you can redial the last number called:

1. Press  to display the last number dialed.
2. Press  again to place the call.

Dial Special Characters

You can insert special characters in your numbers:

To enter...	Then...
	Press  .
*	Press  .
+ (for international calls)	Press and hold  .
□ (for pause dialing)	Press and hold  .
supplementary service numbers, PINs, and unblocking	Press   .

Dial a Number With Pauses

Refer to “Using Pauses in Numbers” on page 80 for information on inserting pauses into numbers.

Dial a Number from the Phone Book

Your phone contains a phone book that you can use to store names and telephone numbers. Once you have stored information in your phone book, you can save dialing steps by using:

- one-touch dialing (satellite mode only)
- an entry from a location
- an entry of a name
- one of the last ten numbers called

Refer to “Managing the Phone Book” on page 69.

Make an Emergency Call

You can make an emergency call virtually anywhere in the world (without unlocking your phone) by dialing 112. Provided your phone has found a network, you are able to make an emergency call. The emergency call is directed to a central emergency operator.

Keep in Mind: If you are in a CDMA/AMPS cellular mode, you must set up your local emergency number for this feature to work. See page 155 for more information.

To make an emergency call:

Dial   

You will see **Emergency Calling**

In addition, your Iridium service provider may have provided an additional emergency calling code on your SIM card. Check with your service provider.

Call a Number in a Message

Details on how to call a number embedded in a message are in “Using Message Services” on page 119.

This feature is only available in satellite mode.





Satellite
Mode

Cellular
Mode

What's My SIM Card Phone Number?

Tip: Pressing   also brings up your phone's number.

You can retrieve and display your phone's number from your SIM card.

1. **Press**  until you see Phone Book, and then **press**  to select.
2. **Press**  until you see My Phone Number(s), and then **press**  to select. You will see your phone number.
3. **Press and hold**  to exit the menu.

Keep in Mind: If you do not see your number(s), they have not be programmed onto your SIM card. Contact your service provider for more information.

Receiving Calls

Receive a Phone Call

To receive a call, your phone must be powered on, have a SIM card inserted, be unlocked, and be in contact with the satellite or cellular network (depending on your mode). See “Accessing the Network” on page 159 for network information.

When you receive a call:

- Your phone rings and/or vibrates.
- If the keypad cover is closed, the status indicator alternates red and green.
- The phone displays **Call**, followed by **Answer?** on the next line.

To answer the call:

1. **FIRST, rotate and fully extend** the antenna if you are in satellite mode only. See “Holding the Phone” on page 45.
2. **Open the cover** to expose the keypad.

or

Press **OK** or **any digit key** (**1-9**, *****, or **#**) if the keypad cover is already open.

You will see **Connected**.

If the call does not connect properly, you may see one of the following messages:

Message	Description
Rotate Antenna	Make sure the antenna is fully extended and rotated upward.
Orient Antenna	You need to get a better view of the sky.
Call Failed	This message indicates that the antenna is not properly adjusted or the network signal is not strong enough.

Tip: See page 137 to set your phone's alert.

Satellite
Mode



Cellular
Mode

Satellite
Mode/
Cellular
Mode
(GSM)

Cellular
Mode
(CDMA/
AMPS)

Ending a Call

To end a call, perform one of the following tasks:

- Press .
- Close the keypad cover.
- Press .

Keep in Mind: If you rotate the satellite antenna down and you are in satellite mode, your call will be dropped.

Unanswered Calls

If you are away from your phone or choose not to answer a call, your phone displays the message Unanswered Call.

This feature is only available in satellite mode.

Personal Mailbox

Callers who are unable to reach you can leave numeric, text, and voice messages. The next time you register with the satellite or GSM cellular network (depending on your mode), you will receive these messages. Then you will have the option of returning the call or saving the message for later viewing.

For information on retrieving messages, see “Accessing Messages” on page 128.

This feature is not available in CDMA/AMPS cellular mode.

Adjusting Earpiece Volume

To adjust earpiece volume:

- **Increase the volume** by pressing the upper volume key.
- **Decrease the volume** by pressing the lower volume key.

As you press the keys, the phone's speaker demonstrates the new volume level. The bar graph in the display represents the volume level. The higher the graph, the louder the volume.

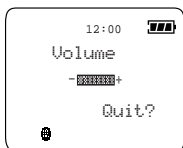

Tip: The volume keys are located on the side of the phone.

Adjusting Ringer Volume

Satellite Mode





Tip: You can also press  and then the up or down volume key to adjust ringer volume.

Cellular Mode

Use this feature to adjust the volume of the ringer. The phone sounds the new volume level as you adjust it.

Note: This feature behaves differently based on the mode you are in. Check your mode settings before using this feature. See “Selecting a Mode” on page 169 for more information.

To adjust the ringer volume in satellite mode:

1. **Press**  until you see **Phone Setup**, and then **press** .
2. **Press**  until you see **Adjust Ringer Volume**, and then **press**  to select.
3. **Increase the volume** by pressing the upper volume key.
or
Decrease the volume by pressing the lower volume key.
4. **Press and hold**  to exit the menu.

Keep in Mind: The adjustments you make here apply to cellular mode as well.

To adjust the ringer volume in cellular mode:

Press  and then the up or down volume key.



Keep in Mind: The adjustments you make here apply to satellite mode as well.

Using In-Call Features

Read this section to learn how to get up and running with your new satellite phone.

What You'll Learn

- Using Call Waiting
- Using Call Holding
- Using Call Muting

Keep in Mind: If you see a  next to a feature, the phone must be in satellite mode. If you see a  next to a feature, the phone must be in cellular mode. See “Selecting a Mode” on page 169 to change modes.



In-Call Feature Overview

The feature selection varies depending on your mode setting. The table below shows the features available in each mode. See "Selecting a Mode" on page 169 for more information on changing modes.

Feature	Satellite	GSM	CDMA/AMPS
Call Waiting	•		Service Provider*
Call Holding	•		Service Provider*
Call Muting	•		
Phone Flash			•
* Your service provider may have similar or additional features.			

Muting a Call

For privacy during a call, try muting the phone. You hear the party on the other end, but the other party does not hear you.

1. **Press**  until you see Mute Phone?.
2. **Press**  to select. You will see Mute.
3. **Press**  again to resume your conversation.

This feature is only available from satellite mode.

*Satellite
Mode*

*Cellular
Mode*

Using Call Waiting

Satellite Mode

You must subscribe to this network feature through your service provider(s).

Note: This feature behaves differently based your mode. Check your mode settings before using this feature. See "Selecting a Mode" on page 169.

If you have subscribed to Call Waiting, you must first activate it through the Options Menu (see page 113). After you activate it, you are notified of incoming calls while you are on the line in two ways. When a call comes in, you hear a beep and see the message `Call Waiting` followed by `Answer?`.

If you want to...	Then...
accept the waiting call	Press OK . Your current call is placed on hold.
reject the waiting call	Press C .
end current call before answering the waiting call	<ol style="list-style-type: none">1. Press MENU. You will see <code>End Active Call?</code>2. Press OK. Your phone rings and can now be answered normally.



You may see one of the following messages during call waiting activities:

Message	Description
<code>Trying</code>	Your phone is attempting to switch between the current and held call.
<code>Hold Failed</code>	The attempt to hold a call was unsuccessful.
<code>Cannot Hold Second Call</code>	A call is already on hold. You can only place one call on hold.
<code>Reconnect Failed</code>	The held call could not be made active again.
<code>Busy Try Later</code>	Your phone is working on a previous command. Wait a short time before repeating the new command.

CDMA/AMPS cellular users who have subscribed to this feature, are notified of an incoming call by two beeps. You may see a visual message, depending on your service provider.

To handle the call waiting, you must send a phone flash (see page 62 for more information) along with the appropriate feature code provided by your service provider. The current call is put on hold. To return to your initial call you must send another phone flash.

To send a phone flash:

1. **Press**  while you are in a call. You will see Flash Options followed by Select?
2. **Press** . You will see Send Flash?
3. **Enter the access code** for the feature you want to access, if necessary, and then **press**  to send the flash.

or

Press  to cancel the flash.

This feature is not available in GSM cellular mode.

Cellular
Mode
(CDMA/
AMPS)

Cellular
Mode
(GSM)

Placing a Call on Hold

Satellite Mode

You must subscribe to this network feature through your service provider(s).

Note: This feature behaves differently based on the mode you are in. Check your mode settings before using this feature. See "Selecting a Mode" on page 169.

You can place a call on hold to receive a new call or while making a new call. You can only place one call on hold at a time, so some options may not be accessible if you have already placed a call on hold.

To place a call on hold:

1. Press **MENU** until you will see **Call Hold**.
2. Press **OK**. Your current call is put on hold and you will see **Call Holding** followed by **Reconnect?**.

Once you a call is on hold, you have these options:

If you want to...	Then...
Make a new call	<ol style="list-style-type: none">1. Press MENU until you will see Make New Call, and then press OK to select.2. Dial the number as usual, and then press OK to place the call.
Switch Between Calls	When you are connected to either number, you will see 2 Calls followed by Switch? . Press OK to switch to the other call and automatically place the current call on hold.
End Both Calls	Close the flip cover. or Press MENU until you will see End Current & Held Call , and then press OK to select. Both calls are disconnected, and the display returns to standby.

If you want to...	Then...
End Current Call	Press C at any time.
End Call that is on Hold	Press MENU until you will see End Held Call, and then press OK to select. The held call is disconnected, the current call remains connected, and you see End Call?.

You may see one of these messages:

Message	Description
Trying	Your phone is attempting to switch between the current and held call.
Hold Failed	The attempt to hold a call was unsuccessful.
Cannot Hold Second Call	A call is already on hold. You can only place one call on hold.
Reconnect Failed	The held call could not be made active again.
Busy Try Later	Your phone is working on a previous command. Wait a short time before repeating the new command.

To place a call on hold, you must send a phone flash (see page 62 for more information) along with the appropriate feature code provided by your service provider. To return to your initial call, you must send another phone flash. To send a phone flash, see page 62.

This feature is not available in GSM cellular mode.

*Cellular
Mode
(CDMA/
AMPS)*

*Cellular
Mode
(GSM)*

Sending a Flash



Satellite Mode

Cellular Mode (CDMA/ AMPS)

This feature only applies to CDMA/AMPS cellular users.

Many CDMA/AMPS network features (for example, Call Waiting, Call Holding, Call Forwarding) require you to send a "flash" over the air during a call to access them. This is similar to when you press the switch hook on your conventional phone in your home or office to switch between calls. The flash alerts the network that you want to use a particular network feature. Your service provider will provide you with the appropriate codes to send with the flash for the features to which you have subscribed.

To send a phone flash:

1. **Press**  while you are in a call. You will see *Flash Options* followed by *Select?*
2. **Press** . You will see *Send Flash?*
3. **Enter the access code** for the feature you want to access, if necessary, and then **press**  to send the flash.

or

Press  to cancel the flash.

Cellular Mode (GSM)

This feature only applies to CDMA/AMPS cellular users.



Using the Menus

Many of your phone's features are organized into lists of options called *menus*. There are three menus: the Options Menu, the Quick Access Menu, and the In-Call Menu. Some of these options give you access to additional lists of options called *submenus*.

Learn how to navigate through your phone's three main menus. Once you become familiar with these menus and their features go to page 187 to personalize your menus.

What You'll Learn

- using the Options Menu
- using the Quick Access Menu
- using the In-Call Menu

Keep in Mind: If you see a  next to a feature, the phone must be in satellite mode. If you see a  next to a feature, the phone must be in cellular mode. See "Selecting a Mode" on page 169 to change modes.







Using the Options Menu

The Options Menu gives you access to the features and options included with your phone. The submenus that appear under the Options Menu vary depending on your mode setting. See "Selecting a Mode" on page 169.

Menu	Satellite	GSM	CDMA/AMPS
Phone Book	•	•	•
Call Related Features	•	•	•
Messages	•	•	
Phone Setup	•		•
Network Selection	•	•	
Mode Selection	•	•	•
Call Meters	•		

Navigate the Options Menus



Learning how to use just a few buttons enables you to move freely through the entire menu system.

If you want to...	Then...
Enter the Options Menu	Press  to access the Options Menu. You will see the first available submenu.
Scroll through the Options Menu	<ul style="list-style-type: none"> • Press  to scroll forward. • Press   to scroll backward or forward.
Select Options and Submenus	Press  to select a menu option or submenu when that option or submenu name is displayed.
Exit Features and Menus	<ul style="list-style-type: none"> • Press  to exit the feature or submenu. • Press and hold  to exit the Options Menu.







Keep in Mind: If you press  during a call, you will see the In-Call Menu which is described on page 68.

How the Phone Responds

As you scroll through the Options Menu, you will see one of three questions on the bottom line of the display. If your phone asks:

If your phone asks...	Then...
View Options?	Press  to enter the submenu.
Select?	Press  to select the displayed feature.
Quit?	Press  to exit the feature.

Display Icons Chart

If you see...	Then...
 Completed	This indicates a feature has been activated.
 Failed	The display returns to the menu in a few seconds.
Enter PIN or Enter Name	Enter requested information. Then press  .
 Busy Try Later	You may have requested information while your phone was completing another task.
	This indicates where you are in a menu.
	Your phone may take a few seconds to request settings from the network.

Customize the Options Menu

To personalize the Options Menu—to hide and move features—see page 188.

You can only customize the menus in satellite mode.

Satellite
Mode

Cellular
Mode

Using the Quick Access Menu

Satellite Mode

The Quick Access Menu is a way to keep your favorite menu options readily accessible. Each digit key, **1** to **9**, has a Quick Access feature assigned to it. See the chart on page 67 for the default setup. If you know the number of the feature, activating that option takes only two button pushes! If you don't know the number or want to review your options, just scroll through the icon menu and read the tag attached to each option.



Activate the Feature Directly

To access the feature directly:

Press , and then **press** the digit key of the feature.









Scroll to the Feature

To scroll to the feature:

1. **Press** .
2. **Press**  to scroll through the available features (listed below).
3. **Press**  to select a feature.

Default Quick Access Settings

The list of icons explained below are the default settings and icons for the Quick Access Menu.

	Find Name searches your Phone Book by the first three letters in a name.
	Check Signal checks the strength of the signal from the satellite network.
	Call Voicemail calls your Voicemail number to check your Voicemail.
	Battery Meter displays a fuel gauge indicating charge. The more bars, the greater the charge.
	Lock Now locks your phone immediately.
	Vibrate On/Off activates or deactivates VibrateCall™ depending on the current setting.
	Read Messages displays the newest message received.
	Register Now initiates a systematic manual search for a network on which to register.
	Forward On/Off activates or deactivates unconditional call forwarding depending on the current setting.

Customize the Quick Access Menu

See page 190 to learn how to customize the menu.

The Quick Access menu is not available from cellular mode.

*Cellular
Mode*

Using The In-Call Menu

This menu lets you access specific features while you are in a call. Because this menu is not available until you are actually in a call you, cannot review it off-line.

Entering the In-Call Menu

While you are in a call:

Press  to view the In-Call Menu features.

In-Call Menu Features

The In-Call menu dynamically changes depending on the type of call you are in and the mode you have selected.

These options appear in the in-call menu, when you are in satellite mode.

*Satellite
Mode*

Single Active Call	Hold Call? Make New Call? Turn Mute On or Off?
Held Call	Make New Call? End Active Call?
Active Call and a Call Waiting	End Active Call? Reject Call Waiting? Turn Mute On or Off?
Active Call and a Held Call	End Active Call? Turn Mute On or Off? End Held Call? End Active & Held Call?
Held Call and a Call Waiting	Reconnect Held Call? Reject Call Waiting? End Held Call?

When you are in CDMA/AMPS cellular mode and you press  during a call, you will see Flash Options followed by Select?.

There is not an in-call menu in GSM cellular mode.

*Cellular
Mode*



Managing the Phone Book

Your satellite phone can store up to 100 names and numbers, and your SIM card expands memory capacity even more.

Use the dedicated keys or the Options Menu to access the same functions. With the Options Menu you can also access Phone Book maintenance and security features.





What You'll Learn

- recalling and storing phone numbers
- organizing the Phone Book
- accessing automated calling systems
- storing phone number prefixes
- restricting calls with Fixed Dialing
- editing the memory information
- viewing your own phone number



Keep in Mind: If you see a  next to a feature, the phone must be in satellite mode. If you see a  next to a feature, the phone must be in cellular mode. See "Selecting a Mode" on page 169 to change modes.

Entering the Phone Book Menu

To enter the Phone Book menu:

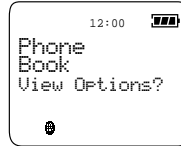
1. **Press**  to scroll forward.
or
Press   to scroll backward or forward.
2. **Press**  when you see:



3. **Press**  to scroll through the submenu.
or
Press   to scroll backward or forward through the submenu.

Phone Book Feature Overview

The feature selection in the Phone Book menu varies depending on your mode setting. The table below shows the features available in each mode. See "Selecting a Mode" on page 169 for more information on changing modes.

Feature	Satellite	GSM	CDMA/AMPS
Add a Phone Book Entry	•	•	•
Call, Modify or Erase an Entry	•	•	•
Check Phone Book Capacity	•		
Enter Names	•	•	•
Find an Entry by Location	•	•	•
Find an Entry by Name	•	•	•
Fixed Dialing	•		
Modify Your Phone Number(s)	•		
One-Touch Dialing	•		
Pause Dialing	•	•	•
Phone Number Prefixes	•		
Prevent Access to Phone Book	•		
View Last Ten Numbers Dialed	•	•	•
View Your Own Phone Number	•	•	•

What's on the Phone Book Menu?

Satellite
Mode

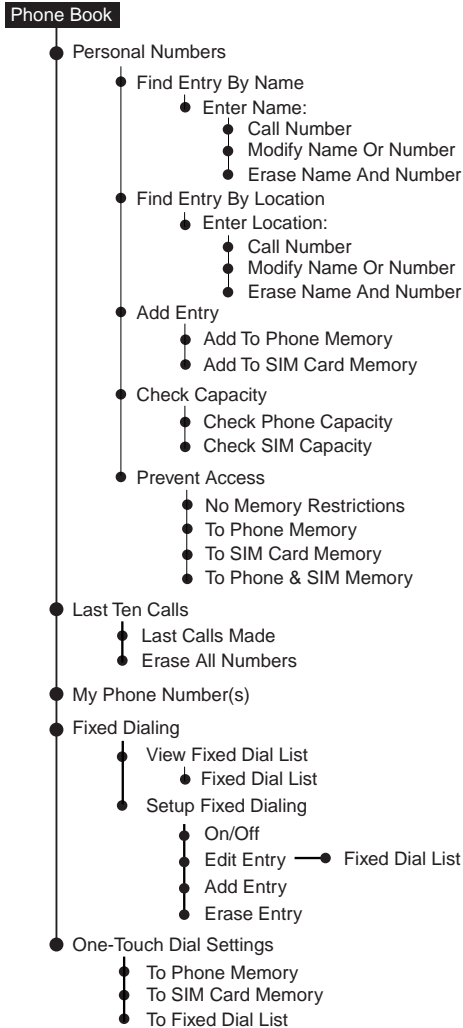

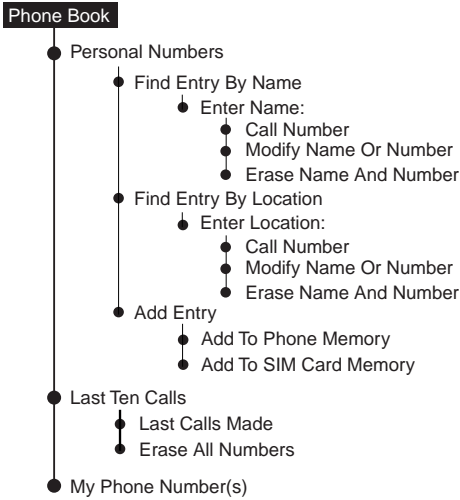

Organizing Your Phone Book

Each name and phone number in your phone book is stored in a numbered memory location. The satellite phone has two types of memory—phone memory and SIM card memory.

	Phone Memory	SIM Card Memory¹
Personal Numbers	100 entries	155 entries
Fixed Dial Numbers	No entries	40 entries
Phone Number Digits	32	20
Name Characters	16	16
Location Numbers	1 - 100	101 - 255

¹ SIM card capacity varies depending upon the card issued by your service provider.

Your phone's memory can seem overwhelming if you don't have a strategy for organizing your Phone Book. Begin setting up your Phone Book by asking yourself three questions:

Which numbers do I call most?

Make a list of the numbers you call most frequently. You'll probably want to store these numbers in the first nine memory locations of your Phone Book. You can then dial them with a single keystroke by using One-Touch dialing (satellite mode only).

When do I use these numbers?





Group the numbers on the list according to when you use them. Most people call a different set of numbers during the day than they do in the evening and on weekends. You can switch One-Touch dialing to your phone's memory (locations 1–9), your SIM card's memory (locations 101–109), or to your Fixed Dial List (locations 1–9). Store your evening and weekend numbers on one type of memory and your daytime numbers on another.

Which numbers do I need to keep secure?

Use your SIM card to store the numbers you need to keep secure, like the numbers of friends and family members. Because your SIM card is the size of a credit card, you can easily keep it securely in your wallet when you aren't using it. If you wish, you can even require a PIN code every time your SIM card is inserted into *any* phone. (To deactivate your PIN code, see page 142.) Store more public numbers, like business associates and travel agents in your phone's memory.

Tip: If you have many entries, group them in blocks of ten to make them easier to find.







1-2-3: Getting to Personal Numbers...

1. Press  until you see Phone Book, and then press .
2. Press  to scroll to Personal Numbers, and then press .
3. Press  to scroll to one of the features described below.

Storing Names and Numbers

Add an Entry

Use the Options Menu

1. Follow the steps in "1-2-3: Getting to Personal Numbers..." to get to Add Entry, and then press .
2. Press  to scroll to Add to Phone Memory or Add to SIM Memory.
3. Press  to select. You will see Enter Number.
4. Enter a number, and then press . You will see Enter Name.
5. Enter a name (see "Entering Names" on page 78), and then press . You will see Enter Location.
6. Enter a location number, 1-100 for phone memory or 101-255 for SIM memory, and then press . You will see Stored XXX.







or

Press  to select the next available location. You will see Stored XXX.

7. Press and hold  to exit the menu.

Tip: When in satellite mode, numbers must be entered in international format.

Use the Dedicated Keys

1. **Enter the phone number** you want to store.
2. **Press**  to begin storing.
3. **Press**   to scroll to the desired memory type Add to SIM Card Memory or Add to Phone Memory, and then **press** . You will see Enter Number, followed by the number you entered.
4. **Press**  to accept the number. You will see Enter Name.
5. **Enter a name** (see “Entering Names” on page 78), and then **press** . You will see Enter Location.
6. **Enter a three-digit location number**, and then **press** . You will see Stored XXX.

or

Press  to store the entry in the next empty memory location. You will see Stored XXX.

Adding Entry Messages

When you enter the location number for your entry, you may see one of these messages:

Message	Description
Stored XXX	You have stored the entry.
Range XXX-XX	You have chosen a memory location outside the appropriate range. Enter a new number within the range listed on the display.
Overwrite?	You have chosen an occupied location. Press  to overwrite the location or press any other key to try another location.

Tip: If you have more than one number for the same person, try attaching a descriptive tag to the name, like Home, Office, or Mobile.

Entering Names

You can use the keypad to produce any letter in the alphabet. For example, press **2^{abc}** to enter the letters A, B, or C, as shown:

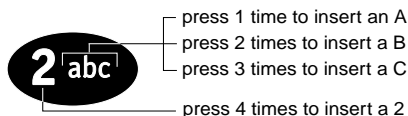

Tip: Press and hold any numeric key to insert a lower case letter.

Enter Characters

1. **Enter a letter** by pressing a key as many times as necessary.
2. **Press** **< >** to advance the cursor.
3. **Repeat steps 1 and 2** as many times as necessary, and then **press** **OK**.

Correct an Entry

To make a change:

1. **Press** **< >** to scroll to the character you want to delete.
 2. **Press** **C** to delete one character at a time.
- or
- Press and hold** **C** to clear the display.

Available Characters

Use this chart as a guide for producing characters:

1	Space . 1 ? ! , @ _ & : " () ' ` i % £ \$ Space . 1 ? ! , @ _ & : " () ' ` i % £ \$
2 abc	A B C 2 Ä Å à AE ß Ç a b c 2 ä å à ae ß ç
3 def	D E F 3 Δ É È Φ d e f 3 Δ é è Φ
4 ghi	G H I 4 Γ ì g h i 4 Γ ì
5 jkl	J K L 5 Λ j k l 5 Λ
6 mno	M N O 6 Ñ Ö Ø Ò Ω m n o 6 ñ ö ø ò Ω
7 pqrs	P Q R S 7 Π Β Σ p q r s 7 Π Β Σ
8 tuv	T U V 8 Θ Û Ü t u v 8 θ ù ù
9 wxyz	W X Y Z 9 Ξ Ψ w x y z 9 Ξ Ψ
0 +	+ - 0 x * / = > < # + - 0 x * / = > < #

The upper line for each key shows the upper case characters. The lower line for each key shows the lower case characters.

Using Pauses in Numbers

Tip: You can store as many as 16 characters. A pause is equal to one character.

When you call automated systems, a recorded message prompts you for numbers such as PIN numbers and account numbers. You can store these numbers in the same memory location as the automated system's access number. Separate the numbers with "pauses"—special characters that tell your phone to wait a few seconds before sending additional numbers—and store the string in the same way you would other numbers.

Enter Pauses in Numbers

1. **Enter the phone number** you use to access the automated system.
2. **Press and hold** . You will see a pause character (⏸) inserted into the number entry.
3. **Enter the next group of numbers.** For example, enter your PIN number. If the automated system requires a * or #, enter those symbols, too.
4. **Repeat steps 2 to 3** as many times as necessary.
5. **To store the entry** follow the procedures in "Add an Entry" on page 76.

Dial Numbers With Pauses

To dial a number with pauses in satellite mode or in GSM cellular mode:

1. **Recall the entry.** (See "Recalling Entries" on page 83.)
2. **Press**  to place the call.

The first pause in the number waits until the call is answered. When the automated system answers, your phone waits a few seconds and then automatically sends the next set of numbers, then the next, until all numbers are sent.

To dial a number with pauses in CDMA/AMPS cellular mode:

1. **Recall the entry.** (See "Recalling Entries" on page 83.)
2. **Press**  to place the call.

The first pause in the number waits until the call is answered.

The phone then waits for you to send the next set of numbers. You will see *Send Digits?*

3. Press  to send the next set of digits
4. Repeat this until all the digit sequences are sent.

Satellite
Mode/
Cellular
Mode
(GSM)

Cellular
Mode
(CDMA/
AMPS)

Using Phone Number Prefixes

Satellite Mode

Tip: Try naming the prefix by area, like Downtown, Suburbs, or Germany.

Cellular Mode

You can save time when you dial by storing the prefixes that you often use. This is sometimes called “postscripting.” Your satellite phone allows you to change or add to Phone Book entries without overwriting them.

Store a prefix in your Phone Book just as you would any other number. See “Storing Names and Numbers” on page 76.



Use a Stored Prefix

To use a stored prefix:

1. **Recall the prefix** from your Phone Book. (See “Recalling Entries” on page 83.)
2. **Add** the finishing numbers.
3. **Press**  to place the call.





Change a Similar Entry

To change an entry to a similar number:

1. **Recall the number** from your Phone Book. (See “Recalling Entries” on page 83.)
2. **Press**  to delete the unwanted digits.
3. **Enter** the replacement digits.
4. **Press**  to place the call.

This feature is not available in cellular mode.

1-2-3: Getting to Personal Numbers...



1. Press  until you see Phone Book, and then press .
2. Press  to scroll to Personal Numbers, and then press .
3. Press  to scroll to one of the features described below.

Recalling Entries

Find an Entry by Name





Search your Phone Book by the first few letters of the entry.

Keep in Mind: If you have restricted access to either SIM card or phone memory and you are in satellite mode, those entries won't be available. For more information, see page 87.

1. **Follow the steps in "1-2-3: Getting to Personal Numbers..."** to get to Find Entry By Name. You will see Find Name?.
2. Press  to select. You will see Enter Name.
3. **Enter 1 to 3 characters** (or as many as needed) of the entry, and then press . If necessary, scroll to the entry you are looking for.
4. Press  to access options for that entry, and then proceed to "Calling, Modifying, or Erasing an Entry" on page 85.

Tip: Your phone sorts SIM card and phone memory together alphabetically.



1-2-3: Getting to Personal Numbers...

1. Press  until you see *Phone Book*, and then press .
2. Press  to scroll to *Personal Numbers*, and then press .
3. Press  to scroll to one of the features described below.

Find an Entry by Location

If you know the location number of the entry, here is an easy way to recall it.



Use the Options Menu

1. **Follow the steps** "1-2-3: Getting to Personal Numbers..." to get to *Find Entry By Location*, and then press  to select. You will see *Enter Location*.
2. **Enter the location number**, and then press . You will see the entry displayed.

If you enter an empty location number, you'll see *Location XXX is Empty*. Your phone then selects the next largest available location. If there are no numbers stored, you will see *No Numbers Stored*.

3. Press  to access options for that entry, and then proceed to "Calling, Modifying, or Erasing an Entry" on page 85.

Use the Dedicated Keys

1. Press .
2. **Enter the three-digit location number** of the entry, and then press .



If you enter an empty location number, you will see *Location XXX is Empty*. Your phone then selects the next largest available location. If there are no numbers stored, you will see *No Numbers Stored*.

3. Press  to call the displayed entry. You will see the number followed by *Calling*.





Calling, Modifying, or Erasing an Entry

Once you have selected a Phone Book entry, you can call, change, or erase that entry.



Call a Selected Entry

1. **Find an entry**, and then **press** . See “Recalling Entries” on page 83.
2. **Press**  until you see `Call Number`, and then **press** . You will see `Calling` followed by the number you dialed.

Modify a Name or Number





1. **Find an entry**, and then **press** . See “Recalling Entries” on page 83.
2. **Press**  until you see `Modify Name or Number`, and then **press** . You will see `Edit Number`, followed by the phone number stored in that entry.
3. **Enter changes** to the number, and then **press** . You will see the name stored in that entry.
4. **Enter changes** to the name, and then **press** . You will see `Modified XXX`.

Erase a Name and Number

1. **Find an entry**, and then **press** . See “Recalling Entries” on page 83.
2. **Press**  until you see `Erase Name and Number`, and then **press** . You will see `Erased xxx`.

Tip: For help entering letters or changing entries, see “Entering Names” on page 78.





1-2-3: Getting to Personal Numbers...

1. Press  until you see Phone Book, and then press .
2. Press  to scroll to Personal Numbers, and then press .
3. Press  to scroll to one of the features described below.

Checking Phone Book Capacity

Satellite Mode

Use this feature to see how many available memory locations you have in either SIM card or phone memory.

1. Follow the steps in "1-2-3: Getting to Personal Numbers..." to get to Check Capacity, and then press  to select.
2. Press  until you see Check Phone Capacity or Check SIM Capacity, and then press . You will see XXX Unused Locations.
3. Press and hold  to exit the menu.





Cellular Mode

This feature is only available in satellite mode.

Preventing Access to the Phone Book

You may want to restrict memory access when loaning your phone to others. You can choose to prevent access to the phone memory, SIM memory, or both.

Keep in Mind: If you switch to cellular mode these restrictions will not apply.

1. **Follow the steps in** "1-2-3: Getting to Personal Numbers..." to get to **Prevent Access**, and then **press**  to select.
2. **Press**  until you see the restriction type you desire: **No Memory Restrictions**, **To SIM Card Memory**, **To Phone Memory**, or **To Phone & SIM Memory**.
3. **Press**  to select the displayed option. You see **Enter Security Code**.
4. **Enter security code**. Enter your six-digit security code. You will see **Completed**.
5. **Press and hold**  to exit the menu.

Keep in Mind: If you prevent access to both your phone memory **and** SIM memory and then try to access an entry, you will see **Restricted**.

If you restrict access to either your phone memory **or** SIM memory and try to access an entry stored in that type of memory, you will see a list of the entries that are not restricted.





This feature is not available in cellular mode. When you switch to cellular mode, the restrictions you set in satellite mode will not apply.

Satellite Mode

Tip: The factory default security code is: 000000.

Cellular Mode

1-2-3: Getting to Fixed Dialing...

1. Press  until you see Phone Book, and then press .
2. Press  until you see Fixed Dialing, and then press .
3. Press  to scroll to one of the features described below.

Restricting Phone Use

Satellite Mode





Tip: You should have received your PIN2 code from your service provider.

Cellular Mode

With the Fixed Dialing feature, you can restrict calling on your phone to a list of numbers that you create. When this feature is active, you can only call numbers or use prefixes (for example, country codes or area codes) that exactly match those that are stored in your list. You can store up to 40 entries on your fixed dial list. These entries are stored on your SIM card.

Activate Fixed Dialing

Use this option to set up your Fixed Dial list.









1. **Follow the steps in "1-2-3: Getting to Fixed Dialing..."** to get to **Setup Fixed Dialing**, and then press  to select. You will see **Enter PIN2**.
2. **Enter code.** Enter your SIM PIN2 code, and then press .
3. Press  until you see **On** or **Off**, and then press . You will see **Completed**.
4. **Press and hold**  to exit the menu.

Keep in Mind: You must turn Fixed Dialing off in order to make and receive calls in cellular mode.

This feature is not available in cellular mode. You must deactivate this feature from satellite mode in order to make and receive calls in cellular mode.

Add an Entry

To add an entry:

1. **Follow the steps in** "1-2-3: Getting to Fixed Dialing..." to get to **Setup Fixed Dialing**, and then **press**  to select. You will see **Enter PIN2**.
2. **Enter code**. Enter your SIM PIN2 code, and then **press** .
3. **Press**  until you see **Add Entry**, and then **press** . You will see **Enter Number**.
4. **Enter the number**, and then **press** . You will see **Enter Name**.
5. **Enter the name**, and then **press** . You will see **Enter Location**.
6. **Enter a location number**, and then **press** . You will see **Completed**.
7. **Press and hold**  to exit the menu.

This feature is not available in cellular mode. You must deactivate this feature from satellite mode in order to make and receive calls in cellular mode.





Satellite Mode

Tip: Phone numbers must be in international format.

Tip: See "Entering Names" on page 78 for help entering letters.

Cellular Mode









1-2-3: Getting to Fixed Dialing...

1. Press  until you see Phone Book, and then press .
2. Press  until you see Fixed Dialing, and then press .
3. Press  to scroll to one of the features described below.

Satellite Mode

Erase an Entry

To erase an entry:











1. **Follow the steps in "1-2-3: Getting to Fixed Dialing..."** to get to Setup Fixed Dialing, and then press  to select. You will see Enter PIN2.
2. **Enter code.** Enter your SIM PIN2 code, and then press .
3. Press  until you see Erase Entry, and then press  to select. You will see the first entry in your Fixed Dial list.
4. Press  to scroll to the number you wish to erase, and then press . You will see Erase xxx?.
5. Press  to confirm. You will see Completed.
6. **Press and hold**  to exit the menu.

This feature is not available in cellular mode. You must deactivate this feature from satellite mode in order to make and receive calls in cellular mode.

Cellular Mode

Edit an Entry

To edit an entry:





1. **Follow the steps in "1-2-3: Getting to Fixed Dialing..."** to get to **Setup Fixed Dialing**, and then **press**  to select. You will see **Enter PIN2**.
2. **Enter code**. Enter your SIM PIN2 code, and then **press** .
3. **Press**  until you see **Edit Entry**, and then **press**  to select. You will see the first entry in your Fixed Dial list.
4. **Press**  to scroll to the entry you want to change, and then **press** . You will see the current number for that location.
5. **Enter changes** to the number, and then **press** . You will see the current name for that location.
6. **Enter changes** to the name, and then **press** . You will see the current location.
7. **Enter a new location**, and then **press** . You will see **Completed**.
8. **Press and hold**  to exit the menu.

This feature is not available in cellular mode. You must deactivate this feature from satellite mode in order to make and receive calls in cellular mode.

Satellite
Mode

Cellular
Mode



1-2-3: Getting to Fixed Dialing...

1. Press  until you see Phone Book, and then press .
2. Press  until you see Fixed Dialing, and then press .
3. Press  to scroll to one of the features described below.

Satellite Mode

View Your Fixed Dial List

This feature enables you to review, but not change, your Fixed Dial list.

1. **Follow the steps in "1-2-3: Getting to Fixed Dialing..."** to get to View Fixed Dial List, and then press  to select. You will see the first number on your Fixed Dial list.
2. Press  to scroll through the numbers on your Fixed Dial list.
3. **Press and hold**  to exit the menu.

Cellular Mode

This feature is not available in cellular mode. You must deactivate this feature from satellite mode in order to make and receive calls in cellular mode.

1-2: Getting to Phone Book Features...

1. Press **MENU** until you see Phone Book, and then press **OK**.
2. Press **MENU** to scroll to one of the features described below. You will see the feature name, along with Select?.



Viewing the Last Ten Numbers Dialed

Don't worry about forgetting the number you dialed earlier. The last ten numbers you dialed are saved.

1. **Follow the steps in "1-2: Getting to Phone Book Features..."** to get to Last Ten Calls, and then press **OK** to select.
2. Press **MENU** to scroll to Last Calls Made or Erase All Numbers, and then press **OK** to select.
3. If you select Last Calls Made, press **MENU** to scroll to the number you are looking for, and then press **OK** to place a call to that number.
or
If you select Erase All Numbers, you will see Completed.
4. **Press and hold C** to exit the menu.

Tip: If you want to add a number from Last Ten Calls to your Phone Book, press **M+** when the number is displayed, then follow the steps in "Storing Names and Numbers" on page 76.

1-2: Getting to Phone Book Features...



1. Press  until you see Phone Book, and then press .
2. Press  to scroll to one of the features described below. You will see the feature name, along with Select?.

Viewing and Modifying Phone Numbers

Tip: Pressing   also brings up your phone number.

View Your SIM Phone Number(s)





Use this feature to view your phone number(s). You can have up to five phone numbers.

1. **Follow the steps in "1-2: Getting to Phone Book Features..."** to get to My Phone Number(s).
2. Press  to select. You will see your phone's voice number followed by Modify?.
3. Press  to scroll through your numbers.
4. **Press and hold**  to exit the menu.

Keep in Mind: If you do not see your number(s), they have not be programmed onto your SIM card. Contact your service provider for more information.

Modify Your Phone Numbers

If you've recently switched your phone number, use this feature to quickly store your most recent information.



1. **Complete the steps** in "View Your SIM Phone Number(s)" on page 94 to get to the number you want to modify.
2. **Press**  to modify the number. You will see *Edit. Number* followed by the number for the selected entry.
3. **Enter changes** to the number, and then **press** . You will see *Edit. Name* followed by the name for the entry selected.
4. **Enter changes** to the name (see "Entering Names" on page 78) and then **press** . You will see *Stored*.
5. **Press and hold**  to exit the menu.

This feature is not available in cellular mode. However, the modifications you make to your number(s) in satellite mode are available in cellular mode.

Satellite
Mode

Cellular
Mode

1-2: Getting to Phone Book Features...





1. Press  until you see Phone Book, and then press .
2. Press  to scroll to one of the features described below. You will see the feature name, along with Select?.

One-Touch Dialing

Satellite Mode

One-Touch dialing enables you to place calls instantly. You can choose to dial the phone numbers in the first nine memory locations in either your SIM memory, phone memory, or your Fixed Dial List. You choose which type of memory you want to be active with this feature.

Set Up One-Touch Dialing

1. Follow the steps in "1-2: Getting to Phone Book Features..." to get to One-Touch Dial Setting, and then press  to select.
2. Press  to scroll through To Phone Memory, To SIM Card Memory, or To Fixed Dial List, and then press  to select the displayed option. You will see Completed.
3. Press and hold  to exit the menu.

Use One-Touch Dialing

Using One-Touch Dial is easy—just press and hold a keypad digit! To use One-Touch dialing:

Press and hold the appropriate digit key.

For example, press and hold  to dial the number stored in location 2 of your phone memory, location 2 of your Fixed Dial list, or 102 of your SIM memory, depending on your setting.

One-touch dialing features are only available from satellite mode.

Tip: You do not need to press  to call the number when you're using One-Touch dialing.



Cellular Mode

Using Calling Features

This chapter describes call-related features. Many of these features are network features that you must subscribe to in order to access.





What You'll Learn

- checking battery power level
- showing the strength of the signal your phone is receiving
- activating/deactivating the Pending Call Drop signal
- forwarding calls when you're not available
- restricting use of your phone



Keep in Mind: If you see a  next to a feature, the phone must be in satellite mode. If you see a  next to a feature, the phone must be in cellular mode. See "Selecting a Mode" on page 169 to change modes.

Entering the Call Related Features Menu

To enter the Call Related Features menu:

1. **Press**  to open the Options Menu.
2. **Press**  to scroll forward.
or
Press  to scroll backward or forward.
3. **Press**  when you see:



4. **Press**  to scroll through the submenu.
5. **Press**  to scroll backward or forward through the submenu.

Call Related Features Overview

The feature selection in the Call Features menu varies depending on your mode setting. The table below shows the features available in each mode. See "Selecting a Mode" on page 169 for more information on changing modes.

Feature	Satellite	GSM	CDMA/AMPS
Activating Call Waiting	•		Service Provider*
Bar Incoming Calls All Calls When Roaming	•	• •	
Bar Outgoing Calls: All Calls International Calls International Calls Except Home	•	• • •	
Change Your Bar Password	•	•	
Deactivate Pending Call Drop	•		
Forward All Your Calls	•	•	Service Provider*
Forward Calls When Unavailable	•	•	Service Provider*
Select When Calls Are Forwarded: Voice Calls Data Calls Fax Calls	•	• • •	Service Provider*
Show Signal Strength	•		
Show the Battery Meter	•		
* Your service provider may offer similar or additional services.			

What's on the Call Related Features Menu?

Satellite Mode

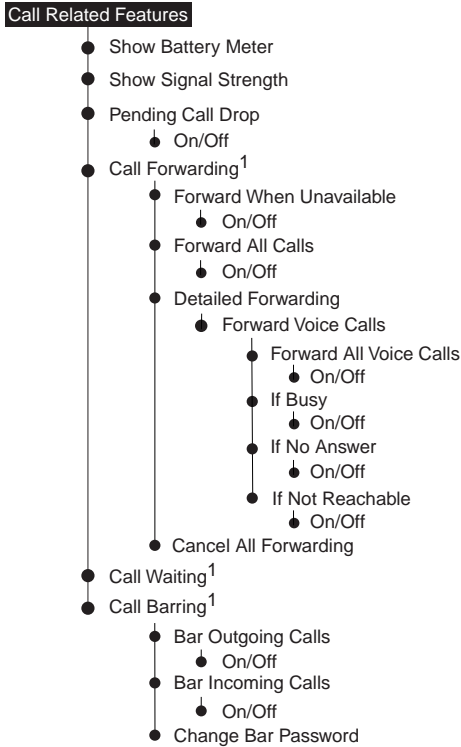

1 These features are network and subscription dependent.

Call Related Features

- Call Forwarding¹
 - Forward When Unavailable
 - On/Off
 - Forward All Calls
 - On/Off
 - Detailed Forwarding
 - Forward Voice Calls
 - Forward All Voice Calls
 - On/Off
 - If Busy
 - On/Off
 - If No Answer
 - On/Off
 - If Not Reachable
 - On/Off
 - Forward Fax Calls
 - Forward Data Calls
 - Cancel All Forwarding
- Call Barring¹
 - Bar Outgoing Calls
 - On/Off
 - Intl Calls
 - Intl Calls Except Home
 - All Calls
 - Bar Incoming Calls
 - On/Off
 - When Roaming
 - All Calls
 - Change Bar Password





¹ These features are network and subscription dependent.

This menu is not available in CDMA/AMPS cellular mode.

Cellular
Mode
(GSM)

Cellular
Mode
(CDMA/
AMPS)

1-2-3: Getting to Call Forwarding...







1. Press  until you see *Call Related Features*, and then press .
2. Press  to scroll to *Call Forwarding*, and then press .
3. Press  to scroll to one of the features described below.

Forward Calls When Unavailable

Use this feature when you can't answer a call. You must subscribe to this network feature through your service provider(s).

Keep in Mind: This feature behaves differently based on your mode. Check your mode settings before using this feature. See "Selecting a Mode" on page 169.





To activate this feature in satellite mode:

1. **Follow the steps in "1-2-3: Getting to Call Forwarding..."** to get to *Forward When Unavailable*, and then press  to select.
2. Press  to scroll to *On* or *Off*, and then press  to select.
 - If you select *On*, continue with **step 3**.
 - If you select *Off*, continue with **step 5**.
3. Press  to scroll to *VoiceMail* or *Other Number*, and then press  to select.
 - If you select *VoiceMail*, continue with **step 5**.
 - If you select *Other Number*, then you will see *Enter Number*. Continue with **step 4**.
4. **Enter the number** you want calls forwarded to, and then press . Your phone takes a moment to request the setting from the network, and then you will see *Call Forward On*.
5. **Press and hold**  to exit the menu.

Satellite Mode





 **Tip:** If you have not yet stored a voicemail number, go to page 125 to learn how.

To activate this feature in GSM cellular mode:

1. **Follow the steps in** "1-2-3: Getting to Call Forwarding..." to get to Forward When Unavailable, and then **press**  to select.
2. **Press**  to scroll to On or Off, and then **press**  to select.
 - If you select On, you will see Enter Number. Continue with **step 3**.
 - If you select Off continue with **step 4**.
3. **Enter the number** you want calls forwarded to, and then **press** . Your phone takes a moment to request the setting from the network, and then you will see Call Forward On.
4. **Press and hold**  to exit the menu.

To activate Call Forwarding features in CDMA/AMPS cellular mode, you must send a phone flash along with the appropriate feature code provided by your service provider.





To send a phone flash:

1. **Press**  while you are in a call. You will see Flash Options followed by Select?
 2. **Press** . You will see Send Flash?
 3. **Enter the access code** for the feature you want to access, if necessary, and then **press**  to send the flash.
- or
- Press**  to cancel the flash.

Cellular
Mode
(GSM)

Cellular
Mode
(CDMA/
AMPS)







1-2-3: Getting to Call Forwarding...

1. Press  until you see Call Related Features, and then press .
2. Press  to scroll to Call Forwarding, and then press .
3. Press  to scroll to one of the features described below.

Forward All Your Calls

When you select this option, all your calls are forwarded to the number you choose. Your phone does not ring. You must subscribe to this network features through your service provider(s).

To activate this feature in satellite mode:

1. **Follow the steps in "1-2-3: Getting to Call Forwarding..."** to get to Forward All Calls, and then press  to select.
2. Press  to scroll to either On or Off, and then press  to select.
 - If you select On, continue with **step 3**.
 - If you select Off, continue with **step 5**.
3. Press  to scroll to Voicemail or Other Number, and then press  to select.
 - If you select Voicemail, continue with **step 5**.
 - If you select Other Number, then you will see Enter Number. Continue with **step 4**.
4. **Enter the number** you want all your calls forwarded to, and then press .





Your phone takes a moment to request the setting from the network, and then you will see Call Forward On.

5. **Press and hold**  to exit the menu.

Satellite Mode

 **Tip:** If you have not yet stored a voicemail number, go to page 125 to learn how.

To activate this feature in GSM cellular mode:

1. **Follow the steps in** "1-2-3: Getting to Call Forwarding..." to get to **Forward All Calls**, and then **press**  to select.
2. **Press**  to scroll to either **On** or **Off**, and then **press**  to select.
 - If you select **On**, you will see **Enter Number**. Continue with **step 3**.
 - If you select **Off**, continue with **step 4**.
3. **Enter the number** you want all your calls forwarded to, and then **press** .

Your phone takes a moment to request the setting from the network, and then you will see **Call Forward On**.





4. **Press and hold**  to exit the menu.

To activate this feature in CDMA/AMPS cellular mode, see "Forward Calls When Unavailable" on page 102.

*Cellular
Mode
(GSM)*

*Cellular
Mode
(CDMA/
AMPS)*

1-2-3: Getting to Call Forwarding...

1. Press  until you see Call Related Features, and then press .
2. Press  to scroll to Call Forwarding, and then press .
3. Press  to scroll to one of the features described below.







Detailed Call Forwarding

You must subscribe to this network feature through your service provider(s).

Keep in Mind: Forward When Unavailable and Forward All Calls override these settings.

Voice Calls



To activate this feature in satellite mode:

1. Follow the steps in "1-2-3: Getting to Call Forwarding..." to get to Detailed Forwarding, and then press .
2. Press  to scroll to Forward Voice Calls, then press .
3. Press  to scroll to the option you desire Forward All Voice Calls, If Busy, If No Answer, or If Not Reachable.
4. Press  to select the displayed option.
 - If you select If Busy or If Not Reachable, your calls are automatically forwarded to your Personal Mailbox. Continue with **step 6**.
 - If you select Forward All Voice Calls or If No Answer, continue with **step 5**.
5. Press  to scroll to either Voicemail or Other Number, and then press .
- If you select Voicemail, continue with **step 7**.
- If you select Other Number, then you will see Enter Number. Continue with **step 6**.







Satellite Mode

Tip: For information on retrieving messages, see "Accessing Messages" on page 128.

 **Tip:** If you have not yet stored a voicemail number, go to page 125 to learn how.

6. **Enter the number** you want calls forwarded to, then **press** . Your phone takes a moment to request the setting from the network, then displays **Call Forward On**.
7. **Press and hold**  to exit the menu.

To activate this in GSM cellular mode:





1. **Follow the steps in** "1-2-3: Getting to Call Forwarding..." to get to **Detailed Forwarding**, and then **press**  to select.
2. **Press**  to scroll to **Forward Voice Calls**, then **press**  to select.
3. **Press**  to scroll to the option you desire **Forward All Voice Calls, If Busy, If No Answer, or If Not Reachable**.
4. **Press**  to select the displayed option.
 - If you select **If Busy** or **If Not Reachable**, then your calls are automatically forwarded to your **Personal Mailbox**. Continue with **step 6**.
 - If you select **Forward All Voice Calls** or **If No Answer**, you will see **Enter Number**. Continue with **step 5**.
5. **Enter the number** you want calls forwarded to, then **press** . Your phone takes a moment to request the setting from the network, then displays **Call Forward On**.
6. **Press and hold**  to exit the menu.

To activate this feature in CDMA/AMPS cellular mode, see "Forward Calls When Unavailable" on page 102.

*Cellular
Mode
(GSM)*

*Cellular
Mode
(CDMA/
AMPS)*

1-2-3: Getting to Call Forwarding...

1. Press  until you see Call Related Features, and then press .
2. Press  to scroll to Call Forwarding, and then press .
3. Press  to scroll to one of the features described below.

Satellite Mode







Cellular Mode (GSM)

Cellular Mode (CDMA/ AMPS)

Fax and Data Calls

The forwarding fax and data calls features are only available in GSM cellular mode.

To forward a fax or data call from GSM Cellular mode:

1. **Follow the steps in "1-2-3: Getting to Call Forwarding..."** to get to Detailed Forwarding, and then press  to select.
Press  to scroll to Forward Fax Calls or Forward Data Calls and then press  to select.
2. Press  to scroll to On or Off. If you select On continue with **step 3**, otherwise continue with **step 4**.
3. **Enter the number** you want calls forwarded to, and then press . Your phone takes a moment to request the setting from the network, and then displays Call Forward On.
4. **Press and hold**  to exit the menu.

To activate this feature in CDMA/AMPS cellular mode, see "Forward Calls When Unavailable" on page 102.

Cancel All Forwarding

Use this option to clear all Call Forwarding settings.

To cancel Call Forwarding settings:

1. **Follow the steps in "1-2-3: Getting to Call Forwarding..."** to get to **Cancel All Forwarding**, and then **press**  to select.

You will see **Call Forward Off**. All Call Forwarding settings are now set to **Off**.



2. **Press and hold**  to exit the menu.

To activate this feature in CDMA/AMPS cellular mode, see "Forward Calls When Unavailable" on page 102.

*Satellite
Mode/
Cellular
Mode
(GSM)*

*Cellular
Mode
(CDMA/
AMPS)*

1-2: Getting to Call Related Features...

1. Press  until you see Call Related Features, and then press .
2. Press  to scroll to one of the features described below. You will see the feature name, along with Select?.

Showing the Battery Meter

Satellite Mode

1. Follow the steps in "1-2: Getting to Call Related Features..." to get to Show Battery Meter.
2. Press  to select.

The display shows a fuel gauge. The more segments filled, the greater your battery's charge:



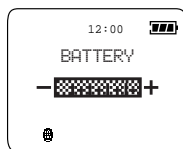

Low Charge



Full Charge

Tip: Refer to "Charging the Battery" on page 34 for more information on your battery.

You may also see one of these messages:

Not Available	The battery meter doesn't appear because a battery is not installed; the phone is operating from external power.
Charging Battery	The battery is being charged: <ul style="list-style-type: none">• If the phone is powered on the  indicator flashes.• If phone is powered off, the  indicator does not appear.
Fast Charge Completed	The battery has completed charging. The  indicator stops flashing.

3. Press and hold  to clear the display.

This feature is only available from satellite mode.

Cellular Mode

Showing Signal Strength

Use this feature to check the strength of the signal that your phone is receiving from the Iridium satellite network. If you are in cellular mode the signal strength is displayed automatically if you are registered.

1. **Follow the steps in** "1-2: Getting to Call Related Features..." to get to **Show Signal Strength**.
2. **Press**  to select. You will see:



If the antenna is not rotated, you will see **Rotate Antenna**. Rotate the antenna to continue.

After a few seconds, if the phone is able to locate a signal, the signal strength indicator appears in the upper left corner of the display.



The signal strength meter remains on the display for several seconds. If the phone cannot locate a signal, you will see **Weak Signal**.



3. **Press and hold**  to exit the menu.

This feature is only available from satellite mode.

*Satellite
Mode*

*Cellular
Mode*

1-2: Getting to Call Related Features...





1. Press  until you see **Call Related Features**, and then press .
2. Press  to scroll to one of the features described below. You will see the feature name, along with **Select?**.

Deactivating Pending Call Drop Signal

Satellite Mode

Under rare circumstances, due to system overcapacity or a satellite outage, a satellite may not be available to take your call. When this happens, your phone notifies you with a series of three consecutive tones and displays **Pending Call Drop**. The tones continue periodically until a new satellite moves into range or the call is dropped.

To deactivate the alert tones:





1. **Follow the steps in the "1-2: Getting to Call Related Features..."** to get to **Pending Call Drop**, and then press  to select.
2. Press  to scroll to either **On** or **Off**, and then press  to select.
3. **Press and hold**  to exit the menu.

This feature only applies to satellite mode.

Cellular Mode

Activating Call Waiting

Subscribers to Call Waiting can use this feature to decide whether or not to take incoming calls while on the line. To activate call waiting:

1. **Follow the steps in** "1-2: Getting to Call Related Features..." to get to **Call Waiting**, and then **press**  to select.
2. **Press**  to scroll to **On** or **Off**, and then **press**  to select the desired option.
3. **Press and hold**  to exit the menu.

For information on using call waiting, see "Using Call Waiting" on page 58.

CDMA/AMPS users do not have to activate Call Waiting through the menu system. For information on using Call Waiting in CDMA/AMPS cellular mode, see "Using Call Waiting" on page 58.





This feature is not available in GSM cellular mode.

*Satellite
Mode*

*Cellular
Mode
(CDMA/
AMPS)*

*Cellular
Mode
(GSM)*

1-2-3: Getting to Call Barring...

1. Press  until you see Call Related Features, and then press .
2. Press  to scroll to Call Barring, and then press .
3. Press  to scroll to one of the features described below. You will see the feature name, along with Select?.





Restricting Calls with Call Barring

You can use Call Barring to restrict both incoming and outgoing calls. Call Barring is useful if you're loaning your phone to others or when you wish to control incoming calls. When you change one of your Call Barring settings, your phone takes a few seconds to request the setting from the network.

Bar Outgoing Calls

This setting enables you to receive incoming calls but prevents outgoing calls.





To activate this feature in satellite mode:

1. **Follow the steps in "1-2-3: Getting to Call Barring..."** to get to Bar Outgoing Calls, and then press  to select.
2. Press  to scroll to On or Off, and then press  to select.
You will see Enter Password.
3. **Enter your bar password**, and then press . You will see Completed.
4. **Press and hold**  to exit the menu.

Satellite Mode

Tip: Your service provider gives you a bar password.

To activate this feature in GSM cellular mode:

1. **Follow the steps in “1-2-3: Getting to Call Barring...”** to get to **Bar Outgoing Calls**, and then **press**  to select.
2. **Press**  to scroll to **Int'l Calls**, **Int'l Calls Except Home**, **All Calls**, or **Off**, and then **press**  to select.
You will see **Enter Password**.
3. **Enter your bar password**, and then **press** . You will see **Completed**.
4. **Press and hold**  to exit the menu.





This feature is not available in CDMA/AMPS cellular mode.

Cellular Mode (GSM)

Tip: Your service provider gives you a bar password.

Cellular Mode (CDMA/AMPS)

1-2-3: Getting to Call Barring...

1. Press  until you see Call Related Features, and then press .
2. Press  to scroll to Call Barring, and then press .
3. Press  to scroll to one of the features described below. You will see the feature name, along with Select?.





Satellite Mode

Tip: Your service provider gives you a bar password.





Bar Incoming Calls

This setting allows you to place calls, but refuses incoming calls. Callers hear a recording telling them you are unavailable. To be sure not to miss a call see "Detailed Call Forwarding" on page 106.

To activate this feature in satellite mode:

1. **Follow the steps in "1-2-3: Getting to Call Barring..."** to get to Bar Incoming Calls, and then press  to select.
2. Press  to scroll to On or Off, and then press  to select.
You will see Enter Password.
3. **Enter your bar password**, and then press . You will see Completed.
4. **Press and hold**  to exit the menu.

To activate this feature in GSM cellular mode:

1. **Follow the steps in "1-2-3: Getting to Call Barring..."** to get to Bar Incoming Calls, and then **press**  to select.
2. **Press**  to scroll to When Roaming, All Calls, or Off, and then **press**  to select.
You will see Enter Password.
3. **Enter your bar password**, and then **press** . You will see Completed.
4. **Press and hold**  to exit the menu.





This feature is not available in CDMA/AMPS cellular mode.

Cellular Mode (GSM)

Tip: Your service provider gives you a bar password.

Cellular Mode (CDMA/AMPS)

1-2-3: Getting to Call Barring...

1. Press  until you see Call Related Features, and then press .
2. Press  to scroll to Call Barring, and then press .
3. Press  to scroll to one of the features described below. You will see the feature name, along with Select?.





Satellite Mode/ Cellular Mode (GSM)

Tip: If you are changing the password for the first time, use the password supplied by your service provider.

Cellular Mode (CDMA/ AMPS)

Change Bar Password

When you subscribe to Call Barring, your service provider gives you a four-digit bar password. Use this feature to change it to something easy to remember.

1. **Follow the steps in "1-2-3: Getting to Call Barring..."** to get to Change Bar Password, and then press  to select. You will see Enter Password.
2. **Enter bar password**, and then press . You will see Enter New Password.
3. **Enter the new bar password**, and then press .
4. **Enter the new bar password** again to confirm, and then press .
5. **Press and hold**  to exit the menu.

This feature is not available in CDMA/AMPS cellular mode.



Using Message Services

Did you know that you can receive voicemail and fax notification messages and numeric and text messages through your Personal Mailbox service—wherever in the world you may be? Wherever you are, you'll have instant reference to all your communication.

Keep in Mind: Message Services are only available in satellite mode and GSM cellular mode unless otherwise indicated.

What You'll Learn

- checking your voicemail messages
- reading, saving and deleting messages

Keep in Mind: If you see a  next to a feature, the phone must be in satellite mode. If you see a  next to a feature, the phone must be in cellular mode. See "Selecting a Mode" on page 169 to change modes.

Entering the Messages Menu

To enter the Messages menu:

1. Press  to access the Message submenu directly, and then go on to **step 4**.

or

Press  to access the Options Menu and then go on to **step 2**.

2. Press  to scroll forward.

or

Press  to scroll backward or forward.

3. Press  when you see:



4. Press  to scroll through the submenu.

or

Press  to scroll backward or forward through the submenu.

Messages Services Feature Overview

The feature selection in the Messages menu varies depending on your mode setting. The table below shows the features available in each mode. See "Selecting a Mode" on page 169 for more information on changing modes.

Feature	Satellite	GSM	CDMA/AMPS
Call a Number Embedded in the Message	•		
Check Voice Mail	•		
Delete a Message	•	•	
Go to Next Message	•	•	
Message Notification	•	•	
Read A New Message	•	•	
Read A Stored Message	•	•	
Store Voice Mail Number	•		

What's on the Messages Menu?

Satellite
Mode

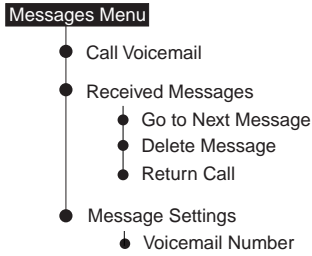

Messages Menu



- Received Messages
 - Go to Next Message
 - Delete Message

This menu is not available in CDMA/AMPS cellular mode.

*Cellular
Mode
(GSM)*

*Cellular
Mode
(CDMA/
AMPS)*

1-2: Getting to Message Features...

1. **Press**  to enter the Messages menu.
2. **Press**  to scroll to one of the features described below. You will see the feature name, along with *Select?*.

Checking Your Voicemail

Satellite Mode

This feature makes checking your voicemail simple.

1. **Follow the steps in** "1-2: Getting to Message Features..." to get to *Call Voicemail*.
2. **Press**  to select. You will see your voicemail number followed by *Calling*.







If you have not previously stored a Voicemail Number, then you will see *No Number Available*. See page 125 to enter a number.

Cellular Mode

This feature is not available in cellular mode.

Storing Your Voicemail Number

To store a voicemail number:

1. **Follow the steps in** "1-2: Getting to Message Features..." to get to **Message Settings**, and then **press**  to select.
2. **Press**  to select **Voicemail Number**. You will see **Enter Voicemail Number** followed by your current voicemail number. If this is the first time you have stored a number, continue with to **step 4**.
3. **Press**  to clear one digit at a time, **or press and hold**  to erase the entire number.
4. **Enter the new number**, and then **press** . You will see **Completed**.
5. **Press and hold**  to exit the menu.

This feature is not available in cellular mode.

Satellite Mode

Tip: Use pause dialing to store your voicemail access and PIN numbers together. See "Using Pauses in Numbers" on page 80.

Cellular Mode

Managing Your Messages

How Your Phone Notifies You of Messages

If your phone is powered on, it notifies you of received messages in the following ways:

- **An alert sounds and/or the phone vibrates.**

Your phone beeps and/or vibrates three times to inform you of an incoming message. See page 138 to set your phone's alert.

- **The message icon () is displayed.**
- **The message is displayed immediately** if the message is a fax or voicemail notification message. The message remains on the display for several seconds.

or

Message Read Now? is displayed if the message is an alphanumeric, text message of up to 160 characters. For more information see "Read a New Message" on page 128.

How Messages Are Stored

Your phone stores all messages on your SIM card. The total number of messages that you can store depends on your service provider.

If the message indicator is flashing, your SIM card is full. See "Delete Messages" on page 129 to make room for the new message.

What Messages Contain





You can receive short text or numeric messages in your Personal Mailbox. Text messages may contain up to 160 characters. Numeric messages—typically phone numbers—may contain up to 20 digits.

Your Personal Mailbox works along with Call Forwarding. For more information, refer to “” on page 52.

Messages contain multiple screens with the following information:

- the message
- the date and time the message was sent
- the phone number (if available) from which the message was sent

1-2-3: Accessing Your Messages...

1. Press  to access the Messages menu.
2. Press  until you see Received Messages, and then press  to select.
3. Press  to scroll to one of the features described below.

Accessing Messages



Satellite
Mode/
Cellular
Mode
(GSM)

Read a New Message

Keep in Mind: If you are in cellular mode and you remove your GSM Cellular Cassette you are not able to access your messages. Switch to satellite mode or reinsert your GSM Cellular Cassette.





Notification Messages

When you receive an incoming fax or voicemail notification message, it automatically scrolls across your screen. You can:

- Press  to store it on your SIM card.
- Press  to delete it.

Text Messages

When you receive a new alphanumeric message, you will see Message Read Now? To read it:



1. Press  and continue with **step 2.**
or
Press  to read the message later. See "Read a Stored Message" on page 129."
2. Press  or  to move forward through a message one screen at a time.
3. Press  to access options for that entry, then proceed to page 130.

This feature is not available in CDMA/AMPS cellular mode.

Cellular
Mode
(CDMA/
AMPS)

Read a Stored Message

To read a stored message:

1. **Follow the steps in** "1-2-3: Accessing Your Messages..." to enter the message center. If you have messages you will see the number of messages stored. If you do not have any messages, you will see **No Messages**.
2. **Press**  or  to move forward through a message one screen at a time.
3. **Press**  to access options for that entry, and then proceed to page 130.

or

Press and hold  to exit the menu.





This feature is not available in CDMA/AMPS cellular mode.

Satellite
Mode/
Cellular
Mode
(GSM)

Cellular
Mode
(CDMA/
AMPS)

Delete Messages

Use this option to make room for new messages:

1. **Follow the steps in** "Go to the Next Message" above until you see the message you want to delete, and then **press** .
2. **Press**  until you see **Delete Message**, and then **press** . You will see **Message Deleted**.
3. **Press and hold**  to exit the menu.

This feature is not available in CDMA/AMPS cellular mode.

Satellite
Mode/
Cellular
Mode
(GSM)

Cellular
Mode
(CDMA/
AMPS)

Satellite
Mode/
Cellular
Mode
(GSM)



Cellular
Mode
(CDMA/
AMPS)

Satellite
Mode





Cellular
Mode

Go to the Next Message

To go to the next message:

1. **Follow the steps** in “Read a Stored Message” on page 129.
2. **Press**  until you see **Go To Next Message** and then **press** .





You will see the next message. If you are at the end of your message list you will see the first message again.

3. **Press**  or   to move forward through a message one screen at a time.
4. **Repeat steps 2 to 3** until you have read all your messages.
5. **Press and hold**  to exit the menu.

This feature is not available in CDMA/AMPS cellular mode.

Return a Call

A callback number appears in quotes within the message. If one is enclosed, you can instantly place a call to that number. If a callback number is not included, your phone selects the first number in the message.

1. **Follow the steps** in “Go to the Next Message” on page 130 to display the desired message, and then **press** .
2. **Press**  until you see **Return Call**, and then **press** . You will see the number followed by **Call?**.
3. **Press**  to place a call to that number. You will see the number followed by **Calling**.



This feature is not available in cellular mode.

Customizing Phone Features

Once you're comfortable with the basic features of your new phone, use this chapter to set your phone up the way you like it.





What You'll Learn

- adjusting your phone's ringer volume
- choosing from ten different ringer styles
- choosing your phone's keypad tones
- locking and unlocking your phone
- changing and setting codes for security
- setting home and away time and date
- resetting or clearing your phone's settings
- selecting the language displayed by your phone



Keep in Mind: If you see a  next to a feature, the phone must be in satellite mode. If you see a  next to a feature, the phone must be in cellular mode. See "Selecting a Mode" on page 169 to change modes.

Entering the Phone Setup Menu

To enter the Phone Setup menu (satellite mode and CDMA/AMPS cellular mode only):

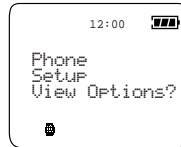
1. **Press**  to open the Options Menu.
2. **Press**  to scroll forward.
or
Press  to scroll backward or forward.
3. **Press**  when you see:



4. **Press**  to scroll through the submenu.
or
Press  to scroll backward or forward through the submenu.

Phone Setup Feature Overview

The Phone Setup feature selection (available in the Phone Setup menu as well as through keystrokes) varies depending on your mode setting. The table below shows the features available in each mode. See “Selecting a Mode” on page 169 for more information on changing modes.

Feature	Satellite	GSM	CDMA/AMPS
Activate Extended Menus	•		
Activate/Deactivate PIN Code	•		
Adjust Ringer Volume**	•	•	•
Change Clock Display	•		
Change PIN Code	•		
Change Unlock Code	•		
Change/Unblock PIN2 Code*	•		
Emergency Number Mapping			•
International Prefix Mapping			•
Lock the Phone	•		
Master Clear/Master Reset	•		
Review Phone Settings	•		
Select Display Language	•		
Select Keypad Tones	•		
Select System Mode			•
Set Phone to Ring or Vibrate	•		
Set Ringer Tone	•		
Set Time and Date Format	•		
Switch Between Numbers			•
Unblock PIN Code*	•	•	•
Unlock the Phone*	•	•	•
View/Set Time and Date	•		

* These features are not accessed through the menu system

** This feature is not available through the menu in cellular mode.

What's on the Phone Setup Menu?

Satellite Mode

Phone Setup

- Adjust Ring Volume
- Ring or Vibrate
 - Ring Only
 - Vibrate Only
 - Vibrate Then Ring
 - No Ring or Vibrate
- Set Ringer Tone
 - Standard Tone
 - ●
●
●
● High Tone
- Phone Lock
 - Automatic Lock
 - On/Off
 - Lock Now
 - Change Unlock Code
- Require SIM Card PIN
 - On/Off
 - Change SIM PIN Code
- Change SIM PIN2 Code
- New Security Code
- Extended Menus
 - On/Off
- Show Time and Date¹
 - Show Home Time & Date
 - Show Away Time & Date
 - Change Clock
 - Away Time
 - Home Time
- Set Time and Date¹
 - Set Home Time & Date
 - Set Away Time & Date
- Set Time Format¹
 - 12 Hour
 - 24 Hour
- Language Selection¹
 - Automatic
 - ●
●
● Türkçe
- Select Key Pad Tones¹
 - No Tones
 - Normal Tones
 - Single Tone
- Phone Status¹
 - Status Review
 - Master Reset
 - Master Clear

¹ This feature is available when the Extended Menu is active.

Phone Setup



- Emergency Mapping
- Intl. Dialing Prefix
- System Scan
 - Std A/B
 - Scan A/B
 - Std B/A
 - Scan B/A
 - Scan A
 - Scan B
 - Home Only
 - Preferred SIDs
- Change Number

This menu is not available in GSM cellular mode.

*Cellular
Mode
(CDMA/
AMPS)*

*Cellular
Mode
(GSM)*

1-2: Getting to Phone Setup...

1. Press  until you see Phone Setup, and then press .
2. Press  to scroll to one of the features described below. You will see the feature name, along with Select?.



Adjusting the Ringer Volume

Satellite Mode

Tip: You can also press , and then the up or down volume key.

Cellular Mode

Use this feature to adjust the volume of the ringer. The phone sounds the new volume level as you adjust it.

1. **Follow the steps in "1-2: Getting to Phone Setup..."** to get to Adjust Ring Volume, and then press  to select.
2. **Increase the volume** by pressing the upper volume key.
or
Decrease the volume by pressing the lower volume key.
3. **Press and hold**  to exit the menu.

Keep in Mind: The adjustments you make here apply to cellular mode as well.





To adjust the ringer volume in cellular mode:

Press  and then the up or down volume key.

Keep in Mind: The adjustments you make here apply to satellite mode as well.

Setting the Phone to Ring or Vibrate

This feature is ideal for situations where a ringing phone is inappropriate or in noisy places where you might not hear the ringer. The vibrating alert notifies you of incoming calls by discreet vibrations.

1. **Follow the steps in** "1-2: Getting to Phone Setup..." to get to Ring or Vibrate, and then **press**  to select.
2. **Press**  to scroll to Ring Only, Vibrate Only, Vibrate then Ring, or No Ring or Vibrate, and then **press**  to select the displayed option. You will see Completed.
3. **Press and hold**  to exit the menu.



You cannot set this feature in cellular mode. You must set this feature from satellite mode. However, the settings you select in satellite mode will apply in cellular mode.

Satellite Mode

Tip: If you select Vibrate then Ring, your phone vibrates for two cycles, and then rings.

Cellular Mode



1-2: Getting to Phone Setup...

1. Press  until you see Phone Setup, and then press .
2. Press  to scroll to one of the features described below. You will see the feature name, along with Select?.

Setting the Ringer Tone

Satellite Mode

Select your favorite tone and you'll recognize your phone's ring immediately—even in a crowd.

1. Follow the steps in "1-2: Getting to Phone Setup..." to get to Set Ringer Tone, and then press  to select.
2. Press  to scroll through the options Standard Tone, Single Ring Tone, British Tone, French Tone, German Tone, Bravo Tone, Three Ring Tone, Siren Tone, Quick Tone, or High Tone.

You hear a one ring cycle demonstration.





3. Press  to select the desired option.
4. Press and hold  to exit the menu.

Cellular Mode

You cannot set this feature in cellular mode. You must set this feature from satellite mode. However, the settings you select in satellite mode will apply in cellular mode.

Setting the Keypad Tones

Choose the sounds your phone makes when its keys are pressed.





1. **Follow the steps in** "1-2: Getting to Phone Setup..." to get to **Select Keypad Tones**, and then **press**  to select.
2. **Press**  to choose **Normal Tones**, **Single Tone**, or **No Tones**, and then **press** .
3. **Press and hold**  to exit the menu.

You cannot set this feature in cellular mode. You must set this feature from satellite mode. However, the settings you select in satellite mode will apply in cellular mode.

*Satellite
Mode*

*Cellular
Mode*

1-2-3: Getting to Phone Lock...





1. Press  until you see Phone Setup, and then press .
2. Press  until you see Phone Lock, and then press .
3. Press  to scroll to one of the features described below.

Locking and Unlocking Your Phone

These features can help you prevent unwanted use of your phone.

Lock the Phone Automatically

Use this feature to set your phone to lock itself every time it is powered on.

1. Follow the steps in "1-2-3: Getting to Phone Lock..." to get to Automatic Lock, and then press  to select.
2. Press  to choose On or Off, and then press  to select. You will see Completed.
3. Press and hold  to exit the menu.

You cannot set this feature in cellular mode. You must set this feature from satellite mode. However, the settings you select in satellite mode will apply in cellular mode.

Lock the Phone Instantly

Use this feature to lock your phone immediately.

1. Follow the steps in "1-2-3: Getting to Phone Lock..." to get to Lock Now.
2. Press  to select. You will see: Locked.

Keep in Mind: Once you unlock your phone, it remains unlocked until you lock it again.

You cannot set this feature in cellular mode. You must set this feature from satellite mode. However, the settings you select in satellite mode will apply in cellular mode.

Satellite
Mode

Cellular
Mode

Satellite
Mode





Cellular
Mode

Unlock the Phone

1. **Enter unlock code.** Enter your four-digit phone unlock code.
2. **Press** .

Change the Unlock Code

The lock code is originally set to 1234. You should change it as soon as possible.

1. **Follow the steps in "1-2-3: Getting to Phone Lock..."** to get to **Change Unlock Code**, and then **press**  to select. You will see **Enter Security Code**.
2. **Enter security code.** Enter your six-digit security code. You will see your current lock code and **Enter Phone Unlock Code**.
3. **Press**  to clear one digit at a time, **or press and hold**  to clear all the digits.
4. **Enter new code.** Enter a new four-digit unlock code, and then **press** . You will see **Phone Lock** and the new lock code.
5. **Press and hold**  to exit the menu.

You cannot change this feature in cellular mode. You must change this feature from satellite mode. However, the changes you select in satellite mode will apply in cellular mode.





Tip: The factory default unlock code is 1234.

Satellite Mode

Tip: The factory default security code is 000000.

Cellular Mode

1-2-3: Getting to Require SIM Card PIN...

1. Press  until you see Phone Setup, and then press .
2. Press  until you see Require SIM Card PIN, and then press .
3. Press  to scroll to one of the features described below. You will see the feature name followed by View Options?.





Protecting the SIM Card

Satellite Mode

You can use a PIN code to protect the information stored on your SIM card even when it is inserted into someone else's phone.

Activate and Deactivate the SIM Card PIN

When you activate the SIM code, your phone requests the code whenever the phone is powered on. To change this setting, you need to enter the PIN that your service provider gave you.





1. **Follow the steps in "1-2-3: Getting to Require SIM Card PIN..."**
2. Press  to scroll On or Off, and then press . You will see Enter PIN.
3. **Enter PIN code.** Enter the 4- to 8-digit code your service provider gave you, and then press . You will see Completed.
4. **Press and hold ** to exit the menu.

Cellular Mode

You cannot activate this feature in cellular mode. You must activate this feature from satellite mode. However, once you activate this feature in satellite mode, it will be active in cellular mode as well.

Change the SIM PIN Code

To choose your own PIN code:

1. **Follow the steps in "1-2-3: Getting to Require SIM Card PIN..."** to get to **Change SIM Card PIN**, and then **press**  to select. You will see **Enter Old PIN**.
2. **Enter the current PIN code**, and then **press** . You will see **Enter New PIN**.
3. **Enter a new PIN code**, and then **press** . You will see **Repeat New PIN**.
4. **Re-enter the new code**, and then **press**  again. You will see **Completed**.
5. **Press and hold**  to exit the menu.









You cannot change this feature in cellular mode. You must change this feature from satellite mode. However, the changes you make in satellite mode will apply in cellular mode.

Satellite
Mode



Cellular
Mode

Unlock the PIN Code

If your PIN number is entered incorrectly three times in a row, **Blocked** appears in the display. You need to enter a PIN unblocking key (PUK), which you can obtain from your service provider. Use the following key sequence to unblock your phone:

1. **Press**  ,  ,  ,  , .
2. **Enter unblocking key**. Enter the 8-digit unblocking key, and then **press** .
3. **Enter a new PIN code**, and then **press** .
4. **Re-enter the new PIN code**, and then **press** .

1-2: Getting to Phone Setup...

1. Press  until you see Phone Setup, and then press .
2. Press  to scroll to one of the features described below. You will see the feature name, along with Select?.

Managing Other Security Settings





Satellite Mode

Your phone includes other security features:

- a SIM PIN2 code for accessing Fixed Dialing settings and other subscription-dependent features
- a security code controls access to security and other menu options

Change the SIM PIN2 Code

Your SIM PIN2 code is used to access Fixed Dialing settings. This four- to eight-digit code is issued to you when you subscribe to the feature. Use this feature to choose a new code.









1. **Follow the steps in "1-2: Getting to Phone Setup..."** to get to Change SIM Card PIN2 Code, and then press  to select. You will see Enter Old PIN2.
2. **Enter the current PIN2 code**, and then press . You will see Enter New PIN2.
3. **Enter new PIN2 code**, and then press . You will see Repeat New PIN.
4. **Re-enter the new PIN2 code**, and then press  again. You will see Completed.
5. **Press and hold**  to exit the menu.

Cellular Mode

You cannot change this feature in cellular mode. You must change this feature from satellite mode. However, the changes you make in satellite mode will apply in cellular mode.

Unlock the PIN2 Code





If your old PIN2 number is entered incorrectly three times in a row, **Blocked** appears in the display. You need to enter a PIN unblocking key (PUK), which you can obtain from your service provider.

1. **Press**  ,  ,  ,  ,  , .
2. **Enter unblocking key.** Enter the 8-digit unblocking code, and then **press**  . Your service provider supplies this code.
3. **Enter a new PIN2 code**, and then **press** .
4. **Re-enter the new PIN2 code**, and then **press** .

You cannot unblock the PIN2 code from cellular mode.

Change the Security Code

The security code is your phone's primary security number. You use it to reset your phone to its default settings and prevent access to your phone book. It is originally set to 000000.

1. **Follow the steps in the "1-2: Getting to Phone Setup..."** to get to **New Security Code**, and then **press**  to select. You will see **Enter Security Code**.
2. **Enter the current security code**, and then **press**  . You will see **Enter New Security Code**.
3. **Enter a new security code**, and then **press**  . You will see **Secur. Code** and the six-digit number selected.
4. **Press and hold**  to exit the menu.

You cannot change this feature in cellular mode. You must change this feature from satellite mode. However, the changes to this feature will apply in cellular mode.



Satellite
Mode

Cellular
Mode

Satellite
Mode

Cellular
Mode

1-2: Getting to Phone Setup...

1. Press  until you see Phone Setup, and then press .
2. Press  to scroll to one of the features described below. You will see the feature name, along with Select?.





Managing Time and Date Settings

Satellite Mode

Cellular Mode

View the Time and Date







Use this feature to view the current time and date in one of two time zones.

1. **Follow the steps in "1-2: Getting to Phone Setup..."** to get to Show Time and Date, and then press  to select.
2. Press  to choose Show Home Time and Date or Show Away Time and Date, and then press . You will see the current time and date for the location selected in display.
3. **Press any key** to clear the time and date from the display and return to the menu.
4. **Press and hold**  to exit the menu.

This feature is not available in cellular mode.

Change the Time Displayed





Use this feature to determine which time is displayed on your real time clock indicator.

1. **Follow the steps in** "1-2: Getting to Phone Setup..." to get to **Show Time and Date**, and then **press**  to select.
2. **Press**  to scroll to **Change Clock**, and then **press** .
3. **Press**  to scroll to either **Home Time** or **Away Time**, and then **press**  to select.
4. **Press and hold**  to exit the menu.

This feature is not available in cellular mode.

Set the Time Format

You can choose a 12-hour or 24-hour time format.

1. **Follow the steps in** "1-2: Getting to Phone Setup..." to get to **Set Time Format**, and then **press** .
2. **Press**  to choose either **12-hour** or **24-hour**, and then **press** .
3. **Press and hold**  to exit the menu.

This feature is not available in cellular mode.



Satellite
Mode

Cellular
Mode

Satellite
Mode

Cellular
Mode

1-2: Getting to Phone Setup...

1. Press  until you see *Phone Setup*, and then press .
2. Press  to scroll to one of the features described below. You will see the feature name, along with *Select?*.









Satellite Mode

Tip: The time displayed (home or away) on the real time clock indicator is the one you selected on page 147.

Cellular Mode

Set the Time and Date





To make it easy to check the local time when you travel, your phone can save the current time and date for two different time zones.

1. **Follow the steps in "1-2: Getting to Phone Setup..."** to get to *Set Time and Date*, and then press  to select.
2. Press  to choose *Set Home Time & Date* or *Set Away Time & Date*, and then press . You will see *Enter Time* and the time currently set.
3. Press  to accept the displayed time.
or
Enter the time in 24-hour format, and then press . You will see *Enter Date* and the date currently set.
4. Press  to accept the displayed date. You will see *Completed*.
or
Enter the date in day(dd)-month(mm)-year(yy) form and then press . You will see *Completed*.
5. Press and hold  to exit the menu.

This feature is not available in cellular mode.

Activating Extended Menus

This feature activates and deactivates the Extended Menus. See page 188 to learn how Extended Menus can make your phone even simpler to use.

1. **Follow the steps in** "1-2: Getting to Phone Setup..." to get to **Extended Menus**, and then **press**  to select.
2. **Press**  to choose **On** or **Off**, and then **press** . You will see **Completed**.
3. **Press and hold**  to exit the menu.



Press and hold  to activate the extended menus temporarily. The extended menus are deactivated when you exit the Options Menu.

This feature is not available in cellular mode. You will see all of the available cellular menu options when you are in cellular mode, regardless of whether this feature is active or not.

*Satellite
Mode*

*Cellular
Mode*





1-2: Getting to Phone Setup...



1. Press  until you see Phone Setup, and then press .
2. Press  to scroll to one of the features described below. You will see the feature name, along with Select?.

Selecting the Display Language

Satellite Mode

Use this feature to select the language in which your phone displays messages.





1. **Follow the steps in "1-2: Getting to Phone Setup..."** to get to Language Selection, and then press  to select.
2. Press  to scroll through the choices, and then press  to select the displayed option.
3. **Press and hold**  to exit the menu.

If you accidentally change the language of your phone's display message, press    to return to the language selection menu.

Cellular Mode

You cannot select this feature in cellular mode. You must select this feature from satellite mode. However, the selection you make will apply in cellular mode.

1-2-3: Getting to Phone Status...

1. Press  until you see `Phone Setup`, and then press .
2. Press  until you see `Phone Status`, and then press .
3. Press  to scroll to one of the features described below.



Managing Your Phone's Settings

View all your phone's settings that have changed from their defaults, and reset them to their original settings if you like.

Review the Phone's Settings

Use this feature to review but not change your phone's settings.

Keep in Mind: This feature does not show you the settings for your cellular mode-specific features.





1. Follow the steps in "1-2-3: Getting to Phone Status..." to get to `Status Review`, and then press .
2. Press  to scroll through the list of all the menu items you have changed.
3. Press and hold  to exit the menu.

This feature is not available in cellular mode.

*Satellite
Mode*

*Cellular
Mode*

1-2-3: Getting to Phone Status...



1. Press  until you see Phone Setup, and then press .
2. Press  until you see Phone Status, and then press .
3. Press  to scroll to one of the features described below.

Reset Options to Factory Defaults

Use the Master Reset option to reset all settings to their original default settings. The Master Reset option:

- resets audible call timers, the in-call display meter, and the automatic lock
- resets Extended Menus to default setting and return language selection to original
- restores keypad tones to normal, ringer tones to standard, and the volume level to the middle of its range
- reset cellular mode (CDMA/AMPS) emergency number and international prefix
- resets mode selection (this may cause the phone to switch modes)

To reset all settings:

1. **Follow the steps in "1-2-3: Getting to Phone Status..."** to get to Master Reset, and then press  to select. You will see Enter Security Code.
2. **Enter your six-digit security code.** You will see Reset Complete.
3. **Press and hold**  to exit the menu.

You cannot reset your settings from cellular mode. However, when you reset your setting from satellite mode, you cellular cassette settings are reset as well.

Satellite Mode

Tip: The factory default security code is 000000.

Cellular Mode

Clear All Stored Information



The Master Clear option resets the same items as Master Reset, plus the following:

- clear phone book entries from phone memory (not from SIM memory)
- clear last calls made list
- reset resettable call timers

Master Clear does not clear the:

- fixed dial list
- my number(s) list
- received messages list

To clear the settings:

1. **Follow the steps** in “1-2-3: Getting to Phone Status...” to get to Master Clear, and then **press**  to select. You will see Enter Security Code.
2. **Enter your six-digit security code.** You will see Reset Complete.
3. **Press and hold**  to exit the menu.



You cannot clear your settings from cellular mode. However, when you clear your setting from satellite mode, you cellular cassette settings are cleared as well.

Satellite Mode

Tip: The factory default security code is 000000.

Cellular Mode

1-2: Getting to Phone Setup...

1. Press  until you see Phone Setup, and then press .
2. Press  to scroll to one of the features below. You will see the feature name, along with Select?.

Cellular Mode Settings

Satellite Mode



Cellular Mode (CDMA/AMPS)

Cellular Mode (GSM)

Set Up the Emergency Number

This feature does not apply to satellite mode. You will not see this menu option in this mode.

This feature allows you to dial 112 to make an emergency call even if your local emergency number is not 112. The default number is 911.



1. **Follow the steps in "1-2: Getting to Phone Setup..."** to get to Emergency Mapping, and then press  to select. You will see Enter Number?.
2. **Enter number.** Enter your local emergency number and then press .
3. **Press and hold**  to exit the menu.

This feature does not apply to GSM cellular mode. You will not see this menu option in this mode.

Setup an International Prefix

This feature does not apply to satellite mode. You will not see this menu option in this mode.

This feature allows you to use the **0+** key (international prefix +) to make an international call without entering the access code for the country, no matter what mode you are in. The default prefix is 001.

- 1. Follow the steps in "1-2: Getting to Phone Setup..."** to get to Intl. Dialing Prefix, and then **press**  to select. You will see Enter Number?
- 2. Enter number.** Enter the international access code for the country you are in, and then **press** .
- 3. Press and hold**  to exit the menu.



This feature does not apply to GSM cellular mode. You will not see this menu option in this mode.

*Satellite
Mode*

*Cellular
Mode
(CDMA/
AMPS)*

*Cellular
Mode
(GSM)*

1-2: Getting to Phone Setup...

1. Press  until you see **Phone Setup**, and then press .
2. Press  to scroll to one of the features below. You will see the feature name, along with **Select?**.

Satellite
Mode

Cellular
Mode
(CDMA/
AMPS)



System Scan

This feature does not apply to satellite mode. You will not see this menu option in this mode.

The System Scan feature lets you select the type of cellular system your phone accesses. This feature is configured by your cellular service provider.

Select a System Scan Method

Your system ID is shown on your display when you are registered with the system. An A indicates you are registered with an analog system and a D indicates you are registered with a digital system.

1. **Follow the steps in "1-2: Getting to Phone Setup..."** to get to **System Scan**, and then press  to select.
2. Press  to scroll to **Std A/B**, **Scan A/B**, **Std B/A**, **Scan B/A**, **Scan A**, **Scan B**, **Home Only**, or **Preferred SIDs**, and then press  to select.

See the table on page 157 for a detailed description of these settings.

3. **Press and hold**  to exit the menu.



System Scan Settings

Standard Mode	<p>Your phone first seeks a home type system, then a non-home type system.</p> <ul style="list-style-type: none"> • If home system is non-wireline (type A), you will see Std A/B. • If home system is wireline (type B), you will see Std B/A.
Reversed Preference Mode	<p>Your phone first seeks a non-home type system, then a home type system. (This mode may be useful in fringe areas or certain roaming situations.)</p> <ul style="list-style-type: none"> • If home system is non-wireline (type A), you will see Scan B/A. • If home system is wireline (type B), you will see Scan A/B.
Home Only Mode	Your phone does not operate outside its home system. You will see Will Home Only .
Scan A Mode	Your phone operates only within non-wireline (A) systems. You will see Scan A .
Scan B Mode	Your phone operates only within wireline (B) systems. You will see Scan B .
Enhanced Preferred Scanning Mode	<p>Your phone scans for home or programmed preferred System ID numbers (SIDs) first. This mode requires entry of the SIDs for the systems in which you wish to operate. Contact your cellular service provider for SID information.</p> <p>If you have selected two system operation, the phone seeks cellular service according to the system type mode selected for each phone number.</p> <p>You will see Preferred SIDs.</p>

This feature does not apply to GSM cellular mode. You will not see this menu option in this mode.

*Cellular
Mode
(GSM)*

1-2: Getting to Phone Setup...

1. Press  until you see Phone Setup, and then press .
2. Press  to scroll to one of the features below. You will see the feature name, along with Select?.

Satellite Mode

Cellular Mode (CDMA/AMPS)





Cellular Mode (GSM)

Switching Phone Numbers

This feature does not apply to satellite mode. You will not see this menu option in this mode.

Your phone can operate on four different home systems depending on your Cellular Cassette. The Change Number feature lets you change your active number to the one appropriate for your current area. All the phone numbers are designated as your home system, but only one number can be active at any given time. Calls are placed and received by the currently active number only.

To change the active phone number:

1. Follow the steps in "1-2: Getting to Phone Setup..." to get to Change Number, and then press  to select. You will see your active number with a ✓ next to it.
2. Press  to scroll through your phone numbers and press  to switch to that phone number.
Note: Contact your service provider to add additional numbers to this list.
3. Press  to confirm the new setting. You will see Set.
4. Press and hold  to exit the menu.



This feature does not apply to GSM cellular mode. You will not see this menu option in this mode.

Accessing the Network

This section shows you how to register with the network.

What You'll Learn

- accessing the Iridium satellite network
- setting up cellular mode network selection

Keep in Mind: If you see a  next to a feature, the phone must be in satellite mode. If you see a  next to a feature, the phone must be in cellular mode. See "Selecting a Mode" on page 169 to change modes.

Entering the Network Menu

To enter the Network Selection menu:

1. Press  to open the Options Menu.

2. Press  to scroll forward.

or

Press  to scroll backward or forward.

3. Press  when you see:

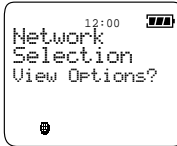

4. Press  to scroll through the submenu.

or

Press  to scroll backward or forward through the submenu.

Network Feature Overview

The feature selection in the Network menu varies depending on your mode setting. The table below shows the features available in each mode. See "Selecting a Mode" on page 169 for more information on changing modes.

Feature	Satellite	GSM	CDMA/AMPS
Available Networks		•	
Find New Network		•	
Network Search		•	
Register Now	•	•	

What's on the Network Menu?

Satellite
Mode

Network Selection

- Register Now

Network Selection



- Available Networks
 - Register Now
- Network Search
 - Registration Preferences
 - Automatic Search
 - Manual Search
- Find New Network

*Cellular
Mode
(GSM)*

This menu is not available in CDMA/AMPS cellular mode.

*Cellular
Mode
(CDMA/
AMPS)*

1-2: Getting to Network Selection...

1. Press  until you see *Network Selection*, and then press .
2. Press  to scroll to one of the features described below. You will see the feature name, along with *Select?*.

Registering With the Satellite Network

Satellite Mode

If you know your phone is outside the range of your local service, use this feature to access Iridium satellite service.

Your phone searches for the Iridium satellite network.

1. **Rotate and extend the antenna** upward. See “Holding the Phone” on page 45.
2. **Follow the steps in “1-2: Getting to Network Selection...”** to get to *Register Now*.
3. Press  to select. You will see *Registering...*. This may take a few seconds.

If the phone finds the signal, you will see *Registered* and the signal strength indicator:



The  indicator also appears.

If the phone is unsuccessful you may see one of these messages: *Rotate Antenna*, *Orient Antenna*, *System Busy*, *Restricted Area*, or *Weak Signal*.

Cellular Mode

This feature does not apply to cellular mode. You will not see this menu option in this mode.





Cellular Mode (GSM) Settings



These network selection features are available in GSM cellular mode only. For information on switching to cellular mode, see “Selecting a Mode” on page 169.

Scan for Available Networks

This feature does not apply to satellite mode. You will not see this menu option in this mode.

This option scans to see which networks are operating in your current location.

1. **Follow the steps in “1-2: Getting to Network Selection...”** to get to **Available Networks**, and then **press** . You will see **Scanning** and then a list of the available networks.
2. **Press**  to scroll to the network you want to register with, and then **press** . You will see **Register Now?**.
3. **Press**  to register with that network. You will see **Searching**.

When your phone has completed registering with the network, you will see the name of the network and either the  or  indicator.



This feature does not apply to CDMA/AMPS cellular mode. You will not see this option in this mode.

Satellite
Mode

Cellular
Mode
(GSM)

Cellular
Mode
(CDMA/
AMPS)

1-2: Getting to Network Selection...

1. Press  until you see *Network Selection*, and then press .
2. Press  to scroll to one of the features described below. You will see the feature name, along with *Select?*.

*Satellite
Mode*

*Cellular
Mode
(GSM)*

Set Network Search Method





This feature does not apply to satellite mode. You will not see this menu option in this mode.

When your phone needs to register with a network, it generates a sorted list of networks. The network list is sorted in the following order:







- the home network
- networks from a preferred list
- random list of other networks found above a certain signal strength
- remaining networks in descending order of signal strength

Any forbidden networks stored in the SIM card are not included in the sorted list. This feature allows you to determine how the phone tries to register with a system. See the table on page 167 for a description of the available search methods.

To set your network search method:

1. **Follow the steps in "1-2: Getting to Network Selection..."** to get to *Network Search*, and then press . You will see *Registration Preferences*.
2. Press .
3. Press  to scroll to *Automatic Search* or *Manual Search*, and then press . You will see *Completed*.



You can select one of the following methods:

Automatic Search	The phone tries to register with the first network in the sorted list that satisfies the GSM network search rules (described on the previous page). If this is successful your phone displays the network name.
Manual Search	<p>The phone presents you with a sorted list of networks within range. You select the network with which you want to register. You will see Search Network followed by Search?</p> <ol style="list-style-type: none">1. Press  to generate the sorted list.2. Press  to select the network you want to register with, and then press . You will see Register Now?.3. Press  to register with that network. <p>When your phone has completed registering with the network, you will see the name of the network and the  or  indicator.</p>

This feature does not apply to CDMA/AMPS cellular mode. You will not see this option in this mode.

*Cellular
Mode
(CDMA/
AMPS)*

1-2: Getting to Network Selection...

1. Press  until you see `Network Selection`, and then press .
2. Press  to scroll to one of the features described below. You will see the feature name, along with `Select?`.

Satellite Mode

Cellular Mode (GSM)

Cellular Mode (CDMA/AMPS)

Find a New Network



This feature does not apply to satellite mode. You will not see this menu option in this mode.

When your phone tries to register with a network, it excludes your current network from the search. If the attempt fails, your phone then attempts to reregister with the previous network.

1. **Follow the steps in "1-2: Getting to Network Selection..."** to get to `Find New Network`, and then press .

If you are using the automatic method, you will see `Searching` and then the name of the network.

If you are using the manual method continue with **step 2**.

2. Press  to scroll to the network you want to register with, and then press . You will see `Searching` and then the name of the network.

This feature does not apply to CDMA/AMPS cellular mode. You will not see this option in this mode.

Selecting a Mode





If you have an optional Cellular Cassette installed in your satellite phone, you can access the cellular network as well as the satellite network.

What You'll Learn



- selecting automatic modes
- selecting manual modes

Entering the Mode Selection Menu

To enter the Mode Selection menu:

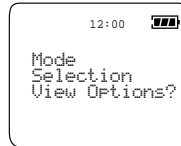
1. Press  to open the Options menu.
2. Press  to scroll forward.
or
Press  to scroll backward or forward.
3. Press  when you see:



4. Press  to scroll through the submenu.
or
Press  to scroll backward or forward through the submenu.

Mode Selection Feature Overview

The feature selection in the Mode Selection menu varies depending on your mode setting. The table below shows the features available in each mode. This chapter shows you how to change modes.

Feature	Satellite	GSM	CDMA/AMPS
Cellular Always	•	•	•
Cellular Preferred	•	•	•
Satellite Always	•	•	•
Satellite Preferred	•	•*	•

* This feature may not be available for some GSM Cellular Cassette users. Check with your service provider.

What's on the Mode Selection Menu?

All Modes

Mode Selection

- Cellular Preferred
- Cellular Always
- Satellite Preferred
- Satellite Always

Selecting a Mode

Preferred or Automatic Modes



When you select a preferred mode, your phone looks for that type of service first. If it cannot find your preferred service, after about five minutes, it switches automatically to your non-preferred service. If the phone switches to a non-preferred service, it checks at regular intervals (every 30 minutes) to see if your preferred service has become available. The exact intervals that your phone switches modes and checks for preferred service varies depending on your SIM card. Check with your service provider.

Keep in Mind: The phone postpones a switch between modes while you are in a call or are actively using one of the phone's features.

Always or Manual Modes

If you select an always mode, your phone always accesses that type of service. If you become out-of-range in that mode, the phone does not switch to the other type of service. You have to manually switch it to the other mode by changing the settings in this menu.

1-2: Getting to Mode Selection...

1. Press  until you see Mode Selection, and then press .
2. Press  to scroll to one of the features described below.

Selecting Satellite Mode

Tip: You must have a Cellular Cassette installed in your phone for this selection to work properly.

Select Satellite Preferred Mode

If you select this feature, your phone uses your Iridium satellite service if possible. When you are in satellite mode, you will see the  indicator in the lower left corner of your display.

If you are out of range and are unable to access a satellite, your phone switches automatically to cellular mode. If this happens, you no longer will see the  indicator in the lower left corner of your display.

1. Follow the steps in "Selecting a Mode" to get to Satellite Preferred.
2. Press  to select.

If you see the message Check Cassette or Insert Cassette, make sure your cassette is installed and is installed properly.

3. Press and hold  to exit the menu.



Keep in Mind: This option may not be available for some GSM Cellular Cassette users. If you power your phone up with a GSM Cellular Cassette inserted, your phone may switch to Cellular Preferred mode.

Select Satellite Always Mode

If you select this feature, your system always accesses the Iridium satellite network. When you are in satellite mode, you will see the  indicator in the lower left corner of your display.

- 1. Follow the steps in "1-2: Getting to Mode Selection..."** to get to **Satellite Always**.
- 2. Press ** to select.

1-2: Getting to Mode Selection...

1. Press  until you see Mode Selection, and then press .
2. Press  to scroll to one of the features described below.

Selecting Cellular Mode

Tip: You must have a Cellular Cassette installed in your phone for these selections to work properly.

Select Cellular Preferred Mode

This is the default selection. When this mode is active, your phone uses your cellular service if possible. If you are out of range, your phone switches to satellite mode. If this happens, you will see the  indicator in the lower left corner of your display.

1. Follow the steps in "Selecting a Mode" to get to Cellular Preferred.
2. Press  to select.

If you see the message Check Cassette or Insert Cassette, make sure your Cellular Cassette is installed properly.

Select Cellular Always Mode

If you select this feature, your system always accesses the cellular network.

1. Follow the steps in "1-2: Getting to Mode Selection..." to get to Cellular Always.
2. Press  to select.

If you see the message Check Cassette or Insert Cassette, make sure your Cellular Cassette is installed properly.



Timing Your Calls

Your phone's call meters give you a variety of options for tracking the time you spend on the phone. You can monitor the length of individual calls, set a timer to track monthly usage, or have the phone alert you with tones at specific intervals.

The features described in this chapter are only available in satellite mode.





What You'll Learn

- viewing your phone's call timers to monitor your air-time
- setting your phone's audible alerts to sound at intervals you specify
- activating an in-call display of the elapsed time of your current call
- checking the total airtime of your phone since it was manufactured



Keep in Mind: If you see a  next to a feature, the phone must be in satellite mode. If you see a  next to a feature, the phone must be in cellular mode. See "Selecting a Mode" on page 169 to change modes.

Entering the Call Meters Menu

To enter the Call Meters menu:

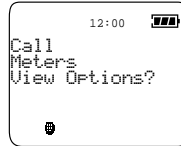
1. **Press**  to open the Options menu.
2. **Press**  to scroll forward.
or
Press  to scroll backward or forward.
3. **Press**  when you see:



4. **Press**  to scroll through the submenu.
or
Press  to scroll backward or forward through the submenu.

Call Meters Feature Overview

The feature selection in the Call Meters menu varies depending on your mode setting. The table below shows the features available in each mode. See "Selecting a Mode" on page 169 for more information on changing modes.

Feature	Satellite	GSM	CDMA/AMPS
Reset All Timers	•		
Set Repetitive Alert Timer	•		
Set Single Alert Timer	•		
Show Time of Last Call	•		
Show Total Time of All Calls	•		
View In-call Timer	•		
View Lifetime Timer	•		

What's on the Call Meters Menu?

Satellite
Mode

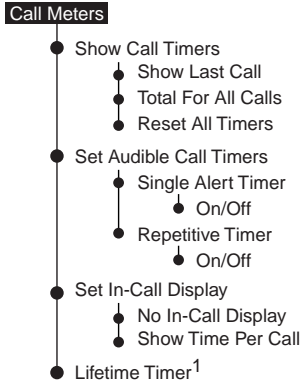





1 This feature is available when the Extended Menu is active.

This menu is not available in cellular mode.

Cellular
Mode

1-2-3: Getting to Show Call Timers...

1. Press  until you see Call Meters, and then press .
2. Press  until you see Show Call Timers, and then press .
3. Press  to scroll to one of the features described below.

Showing Call Timers

This submenu helps you track your airtime. Keep a running tab of your monthly usage or view the airtime of your most recent call.

Show the Time of the Last Call

Use this feature to display the elapsed time of your most recent call.

1. **Follow the steps in "1-2-3: Getting to Show Call Timers..."** to get to Show Last Call, and then press  to select.

You will see the airtime of the most recent call in hours, minutes, and seconds. After several seconds, the display returns to Show Last Call.





2. **Press and hold**  to exit the menu.

This feature is not available in cellular mode.

*Satellite
Mode*

*Cellular
Mode*

1-2-3: Getting to Show Call Timers...

1. Press  until you see Call Meters, and then press .
2. Press  until you see Show Call Timers, and then press .
3. Press  to scroll to one of the features described below.

Satellite Mode

Show Total Time for All Calls

Use this feature to display your total airtime since you last reset the Call Timer.

1. Follow the steps in "1-2-3: Getting to Show Call Timers..." to get to Total For All Calls, and then press  to select.

You will see the airtime accumulated since the timer was last reset. The airtime is displayed in hours, minutes, and seconds. After several seconds, the display returns to Total For All Calls.

2. Press and hold  to exit the menu.

This feature is not available in cellular mode.

Cellular Mode

Reset All Timers

Reset your timers at the beginning of each billing cycle to keep track of your spending.

1. Follow the steps in "1-2-3: Getting to Show Call Timers..." to get to Reset All Timers, and then press  to select.

You will see Completed. The display then returns to Reset All Timers.

2. Press and hold  to exit the menu.





Keep in Mind: This does not reset the Lifetime Timer described on page 186.

Satellite Mode

Cellular Mode

This feature is not available in cellular mode.

1-2-3: Getting to Audible Call Timers...







1. Press  until you see Call Meters, and then press .
2. Press  until you see Set Audible Call Timers, and then press .
3. Press  to scroll to one of the features described below.

Setting Audible Call Timers

Let your phone watch the clock for you. The call timers signal at a set time or interval with beeps only you can hear.

Set the Single Alert Timer

Use this feature to set your phone to alert you after an elapsed time.





1. Follow the steps in "1-2-3: Getting to Audible Call Timers..." to get to Single Alert Timer, and then press  to select.
2. Press  to scroll to On or Off, and then press  to select.
 - If you select On, you will see Enter Seconds. Continue with **step 3**.
 - If you select Off, you will see Completed. Continue with **step 4**.
3. Press  to accept the current setting. You will see Seconds XXX.
or
Enter a number from 11 to 999, and then press . You will see Seconds XXX.
4. Press and hold  to exit the menu.

This feature is not available in cellular mode.

Satellite
Mode

Cellular
Mode





1-2-3: Getting to Audible Call Timers...

1. Press  until you see Call Meters, and then press .
2. Press  until you see Set Audible Call Timers, and then press .
3. Press  to scroll to one of the features described below.

Satellite Mode

Set the Repetitive Timer

Use this feature to set your phone to alert you at specific intervals, for example every 45 seconds.

1. Follow the steps in "1-2-3: Getting to Audible Call Timers..." to get to Repetitive Timer, and then press  to select.
2. Press  to scroll to On or Off, then press  to select.
 - If you select On, you will see Enter Seconds. Continue with **step 3**.
 - If you select Off, you will see Completed. Continue with **step 4**.
3. Press  to accept the current setting. You will see Seconds XXX.

or



Enter a number from 11 to 999, and then press . You will see Seconds XXX.

4. Press and hold  to exit the menu.

This feature is not available in cellular mode.





Cellular Mode

1-2: Getting to Call Meters...

1. Press  until you see Call Meters, and then press .
2. Press  to scroll to one of the features described below.

Showing the In-Call Timer

Use this feature to display a running clock of the airtime elapsed while on a call.



1. Follow the steps in "1-2: Getting to Call Meters..." to get to Set In-Call Display, and then press  to select.
2. Press  to scroll to Show Time Per Call or No In-Call Display, and then press  to select.
3. Press and hold  to exit the menu.

This feature is not available in cellular mode.

*Satellite
Mode*

*Cellular
Mode*

1-2: Getting to Call Meters...

1. Press  until you see Call Meters, and then press .
2. Press  to scroll to one of the features described below.

Show the Lifetime Timer

Satellite Mode

Tip: The Lifetime Meter can't be reset. Reset All Timers has no effect on this timer.

Cellular Mode

Use this feature to show the total time of all calls for the life of your phone.

1. Follow the steps in "1-2: Getting to Call Meters..." to get to Lifetime Timer, and then press  to select.

You will see the total airtime of your phone since it was manufactured, including the airtime spent in cellular mode.

2. Press and hold  to exit the menu.

This feature is not available in cellular mode. However, when you view your lifetime time in satellite mode, the total airtime includes the airtime spent in cellular mode.





Customizing the Menu System

Do you think your 9500 Portable Phone has too many features for everyday use? You can do something about it by hiding the features you don't always need. Is your favorite feature not on the Quick Access menu? It's easy to change the defaults to your favorite features. By customizing your menus, your favorite features are always quick and easy to find! This chapter shows you how.

Keep in Mind: The menu systems can only be customized in Iridium satellite mode. See "Selecting a Mode" on page 169 for more information.

What You'll Learn

- personalizing the Options Menu
- personalizing the Quick Access Menu

Keep in Mind: If you see a  next to a feature, the phone must be in satellite mode. If you see a  next to a feature, the phone must be in cellular mode. See "Selecting a Mode" on page 169 to change modes.

Personalizing the Options Menu







Satellite Mode

You can customize the Options Menu by moving features in and out of the Extended Menu.

Move Menu Features

To move menu features:







1. **Find the feature** you want to move.
2. **Press and hold** . You will see one of two responses depending on where that menu feature currently is. If you see:

<p>Remove From Short Menu (the feature is in the Short Menu)</p>	<p>Press  to move the feature to the Extended Menu. You will see Menu Item Moved.</p> <p>or</p> <p>Press  scroll to Leave in Short Menu, and then press  to select. You will see Move Cancelled.</p>
<p>Add To Short Menu (the feature is in the Extended Menu)</p>	<p>Press  to move the feature to the Short Menu. You will see Menu Item Moved.</p> <p>or</p> <p>Press  to scroll to Leave in Long Menu, and then press  to select. You will see Move Cancelled.</p>

Keep in Mind: Some features and submenus cannot be moved. You will see Cannot Move Menu Item.

Activate/Deactivate Extended Menu

Use the Options Menu to activate and deactivate Extended Menu. Activate it when you need access to every feature. Deactivate it for everyday use.

1. **Press**  until you see Phone Setup, and then **press**  to select.
2. **Press**  until you see Extended Menus, and then **press**  to select.
3. **Press**  to scroll to either On or Off, and then **press**  to select.

If you activate the Extended Menu, you will notice that all the hidden features are now accessible.

Access Hidden Features

If you want access to a feature hidden in the Extended Menu, but don't want to leave the Extended Menu active, you can use this shortcut:

Press and hold  for a few seconds.

All Extended Menu features are accessible until you exit the Options Menu.







These features are not available in cellular mode. You will see all of the available cellular menu options when you are in cellular mode, regardless of whether the Extended menu is active or not.

*Cellular
Mode*





Personalizing the Quick Access Menu

Satellite Mode

You can put any of the features listed below in the Quick Access Menu instead of the defaults listed on page 67.

	Find by Location recalls Phone Book entries by memory location numbers.
	Add Entry to Phone stores entered numbers in the next available phone memory location.
	Add Entry to SIM stores entered numbers in the next available SIM card location.
	Phone Mute on or off mutes the phone.
	Ring Volume displays and sets the incoming call ring tone volume.
	Switch Memory switches One-Touch dialing between the phone and SIM memories depending on the current setting.
	Last Call Timer displays the duration of your last call.

To change the default quick access features to one of the features listed above, choose the feature you want to replace, and then choose the replacement.

1. **Press**  and then **press**  to scroll to the feature you wish to change.
2. **Press and hold**  to access the list of features available.
3. **Press**  to scroll through the list until you find the desired feature.
4. **Press**  to store the displayed feature in the new location.

You will see **Completed**.

This feature is not available in cellular mode.

Cellular Mode

Menu Quick Reference

The Options Menu changes depending on the mode you are in. This section provides a quick reference of the menu structure and features for each mode.

What You'll Learn

- Menu Quick Reference

Phone Book Menu

Satellite
Mode

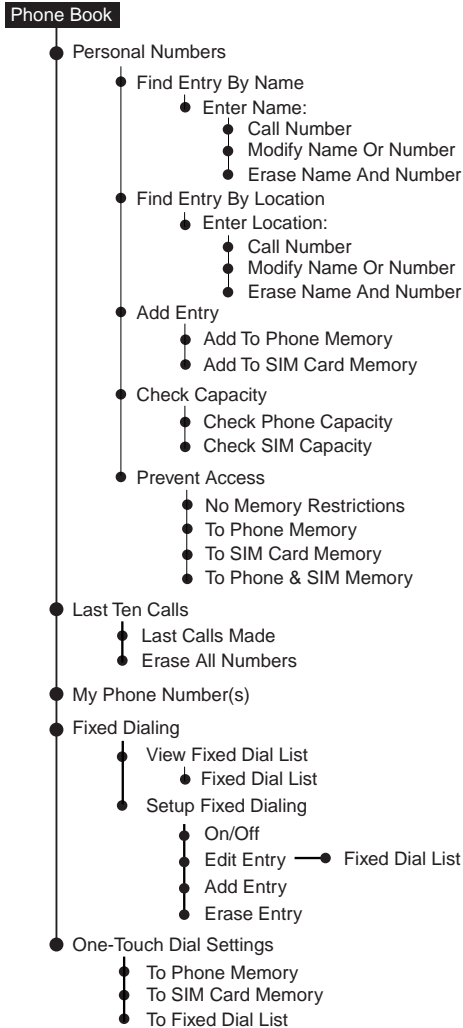

Phone Book Menu

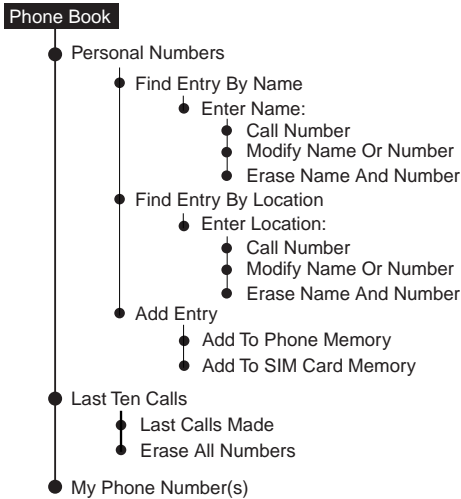

Cellular
Mode

Call Related Features Menu

Satellite Mode

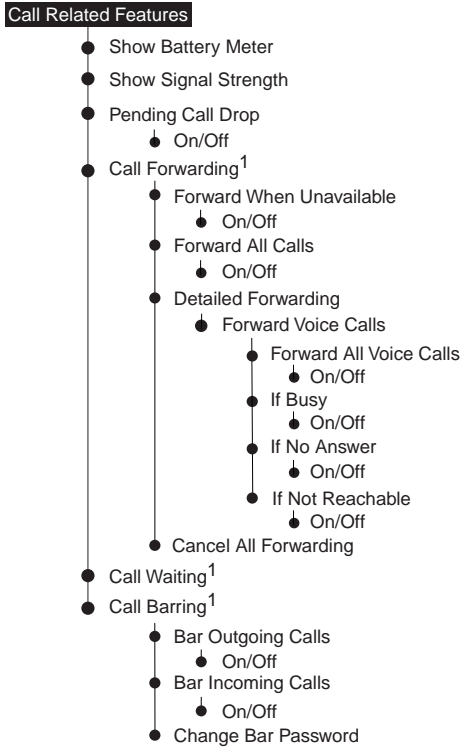

Call Related Features Menu

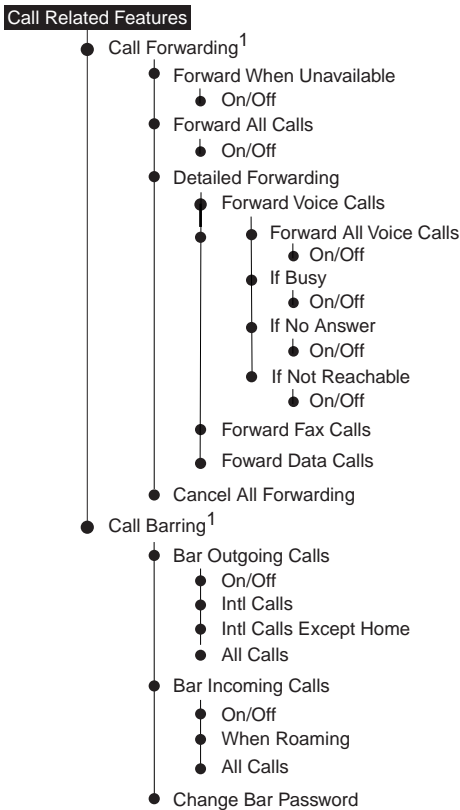

Cellular
Mode
(GSM)

This menu is not available in CDMA/AMPS cellular mode.

Cellular
Mode
(CDMA/
AMPS)

Messages Menu

Satellite
Mode

Messages Menu

- Call Voicemail
- Received Messages
 - Go to Next Message
 - Delete Message
 - Return Call
- Message Settings
 - Voicemail Number

Messages Menu

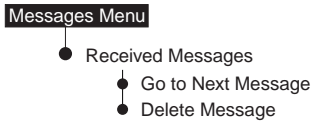

This menu is not available in CDMA/AMPS cellular mode.

*Cellular
Mode
(GSM)*

*Cellular
Mode
(CDMA/
AMPS)*

Phone Setup Menu

Satellite Mode

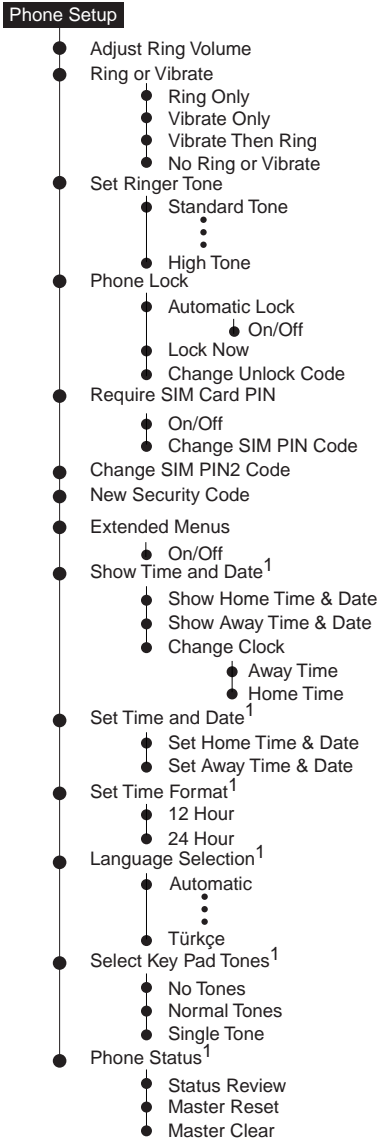

¹ This feature is available when the Extended Menu is active.

Phone Setup Menu

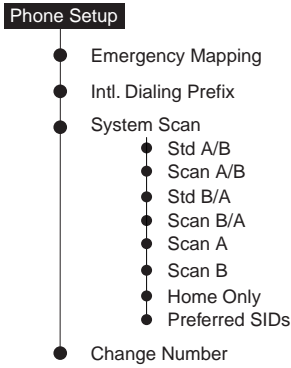

This menu is not available in GSM cellular mode.

*Cellular
Mode
(CDMA/
AMPS)*

*Cellular
Mode
(GSM)*

Network Selection Menu

Satellite
Mode

Network Selection

- Register Now

Network Selection Menu

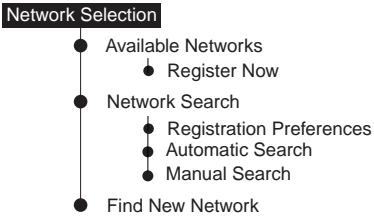

*Cellular
Mode
(GSM)*

This menu is not available in CDMA/AMPS cellular mode.

*Cellular
Mode
(CDMA/
AMPS)*

Mode Selection and Call Meters Menus

All Modes

Mode Selection Menu

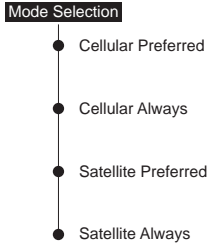

Satellite Mode

Call Meters Menu

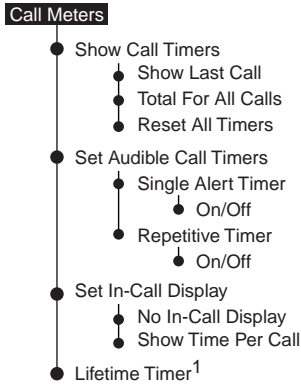

1 This feature is available when the Extended Menu is active.

This menu is not available in cellular mode.

Cellular Mode





Troubleshooting

This section tells you what to do if you experience one of these problems:

Problem	Solution
You can't turn the phone's power on.	Check the battery. Is it charged, properly fitted, and are the contacts clean and dry?
You can't make calls.	<ul style="list-style-type: none">• Check the antenna. Is it fully extended and rotated? Do you have a clear view of the sky?• Did you enter the number in international format? All calls made from the Iridium satellite system must be in international format (satellite mode only).• Check the signal strength meter. If the signal is weak, move to an open space or, if you are in a building, move closer to a window.• Check the Network Selection settings. Try Manual Registration or if in GSM cellular mode try Manual Selection, or try another network.• Check your Operator coverage map.• Is Restricted displayed? Check the Call Barring setting.• Has a new SIM card been inserted? Check that no new restrictions have been imposed.• Check to see if you have your Fixed Dialing list enabled. If so, you can only make calls to numbers or prefixes that are on the list. If you are in cellular mode you must disable this feature. You must check and disable the feature from satellite mode.
You can't receive calls.	<ul style="list-style-type: none">• Check to see that your phone is powered on.• Check the antenna. Is it fully extended and rotated? Do you have a clear view of the sky?• Check the signal strength. If the signal is weak, move to an open space or, if you are in a building, move closer to a window.• Check the Call Forwarding and Call Barring settings.• Check the Ringer setting. If it is off, there is no audible ringer.• Check to see if your Fixed Dialing list is enabled. If you are in cellular mode you must disable it. You must check and disable the feature from satellite mode.

Problem	Solution
You can't make international calls.	<ul style="list-style-type: none"> • Have you included the relevant codes? Press and hold the 0+ key to display the international dialing prefix (+) and then enter the appropriate country code followed by the phone number. • If you are in cellular mode, some service providers automatically bar the ability to make international calls. Contact your service provider. • Are you in a CDMA/AMPS cellular mode? You must map the international access code in order to use the 0+ key to display the international dialing prefix (+).
Your phone won't unlock.	<ul style="list-style-type: none"> • Have you inserted a new SIM card? Enter the new PIN code. • Do you have a replacement phone? Enter the default phone unlock code —1234. • Have you forgotten the unlock code? Press MEMO to change the unlock code (you need your security code).
Your PIN is blocked.	Enter the PIN unblocking code or contact your service provider.
Your PIN2 is blocked.	Enter the PIN2 unblocking code or contact your service provider.
Your SIM card won't work.	<ul style="list-style-type: none"> • Is the card inserted the correct way? • Is the gold chip visibly damaged or scratched? Return the card to your service provider. • Check the SIM and phone contacts. If they are dirty, clean them with an antistatic cloth.
You can't access your messages.	<ul style="list-style-type: none"> • Are you in the correct mode? If you do not have a GSM cellular cassette installed, you must be in satellite mode to access your messages. • Is your GSM Cellular Cassette inserted? In order to access messages from cellular mode, you must have a GSM Cellular Cassette inserted.
You can't cancel Call Forwarding or Call Barring.	Wait until you are in an area with good network coverage and try again.
The  symbol is flashing.	There is not enough memory available to store another message. Use the Messages menu to delete one or more messages.

Problem	Solution
<p>The battery won't charge.</p>	<ul style="list-style-type: none"> • Check the charger. Is it properly connected? Are its contacts clean and dry? • Check the battery contacts. Are they clean and dry? • Check the battery temperature. If it is warm, let it cool before recharging. • Is it an old battery? Battery performance declines after several years use. Replace the battery. • Make sure you have a Motorola approved battery installed. If you see Invalid Batt. in the display, you will not be able to charge this battery.
<p>The battery drains faster than normal.</p>	<ul style="list-style-type: none"> • Are you in an area of variable coverage? This uses extra battery power. • Is your antenna fully rotated and extended? Do you have a clear view of the sky? This helps use less battery power. • Is it a new battery? A new battery needs two to three charge/discharge cycles to attain normal performance. • Is it an old battery? Battery performance declines after several years of use. Replace the battery. • Is it a battery that hasn't been completely discharged? Allow the battery to fully discharge (until the phone turns itself off) and then charge the battery overnight. • Are you using your phone in extreme temperatures? At extreme hot or cold temperatures, battery performance is significantly reduced.
<p>You find your phone becoming warm during use.</p>	<p>You may notice this during long calls or during charging. The heat is produced by the electronic components within your phone and is quite normal.</p>
<p>Your phone has your SIM card inside but the display says:</p>	<ul style="list-style-type: none"> • Check Card or Insert Card. Check that the SIM card has been inserted correctly. The contacts of the SIM card may be dirty. Turn the phone off, remove the SIM card and rub the gold chip on the card with a clean cloth. Replace the card in the phone. • Blocked or Bad Card See Supplier. Please contact your service provider.
<p>Your phone has a Cellular Cassette installed but the display says:</p>	<p>Check Cassette or Insert Cassette Check that the Cellular Cassette has been inserted correctly.</p>

Problem	Solution
<p>You do not have a Cellular Cassette and your phone says Insert Cassette</p>	<p>Make sure you have the correct mode settings selected. You are either in Cellular Always mode or a Preferred mode.</p>
<p>You find your phone's prompts in a language other than your own.</p>	<p>Press , , . This routes you directly to the language selection submenu. Press  until you see your preferred language. Press  to select. You must be in satellite mode to do this.</p>

Glossary

A

accessory connector port A socket on the bottom of the phone where you can attach accessories such as a travel charger, desktop charger, auto accessory adapter or data accessories.

airtime The amount of time you spend using a cellular or satellite system. Especially, the time between successfully placing a call and terminating a call.

AMPS Advanced Mobile Phone Service. An analog network protocol.

antenna The devices on your phone that send and receive satellite or cellular signals.

Auto Accessory Adapter An accessory device that allows you to power your phone and charge any attached batteries from a car's cigarette lighter.

C

CDMA Code Division Multiple Access. A digital technology.

cellular A wireless personal telecommunications system which uses terrestrial base station controllers.

cellular carrier One of several competing organizations in a given geographic area that owns and operates a cellular system.

Cellular Cassette An optional module that is inserted into the portable phone and gives it access to the cellular system.

cellular mode When your phone is in this mode it is accessing the cellular system. You must have the appropriate cellular cassette installed.

cellular system The cellular equipment in a given geographic area that relays signals to and from individual cellular telephones and the landline telephone system.

clear-line-of sight In order for your phone to communicate to the satellite network, your antenna must have a clear view of the sky.

D

default A feature's original setting as pre-programmed in the factory.

DTMF See Dual Tone Multi-Frequency tones.

dual mode phone A phone designed to operate on a cellular network and the Iridium satellite network.

Dual Tone Multi-Frequency Tones The tones that your phone transmits when you press a key on the keypad. These tones are used to access automated calling systems such as voicemail.

E

Emergency Call This feature allows you to make an emergency call even if your phone is locked by dialing 112.

F

fringe area The outermost range of a cellular system or the Iridium satellite system where signals are weak.

G

GSM Global System for Mobile Communications—A digital network protocol.

H

home system The local cellular system or satellite network where you obtain your wireless service.

home type system A cellular/satellite system of the same type as your local system. See also non-home type system, and system type.

I

In-Call Menu The menu that appears when you press  during a call. It allows you to access features like call holding.

indicator A light or icon on your phone that gives you information about your phone's status.

Iridium System A system of 66 satellites that offer global communication.

L

landline The telephone system used for conventional office and home phones.

lock Use this feature to prevent unauthorized access to your satellite telephone.

lock code A four-digit code used to unlock a locked phone.

M

memory location A space in the internal Phone Book (both Phone Memory and SIM memory) where you can store a telephone number and a name. Each of the Phone's memory locations can hold up to 32 digits and 16 letters. The SIM card memory can hold up to 20 digits and 16 letters.

menu feature Any feature that can be accessed through the menu system.

menu system The hierarchical arrangement of your phone's features that allows for quick, intuitive access.

message A feature that allows the user to view pager-like alphanumeric messages.

N

name directory An alphabetical list of the names and telephone numbers you have stored into your phone's internal Phone Book.

NAMPS Narrow-Band AMPS. An analog technology.

non-home type system A system type different from your home system. See also home type system and system type.

non-wireline A cellular carrier that is not the same company as the conventional telephone company.

O

One-Touch Dialing To use this feature, press and hold a number on the keypad, **1** through **9 wxyz** and your call is placed.

Options Menu The first level of the menu system hierarchy, which contains the six main feature menus: Phone Book, Call-Related Features, Messages, Phone Setup, Network Selection, Mode Selection, Call Meters.

P

pause A special character that tells your phone to "pause" or wait for your input before sending a group of numbers stored in memory.

PIN or PIN2 Code Personal Identification Network Code. A private numeric password that allows you to access your SIM card and some network services.

Portable Dock An accessory for the portable phone that converts it to a speaker phone. It runs off either AC power or auxiliary batteries.

prompt A message requesting input.

Q

Quick Access Menu A set of features that is activated by pressing **↑** and a digit key (**1** to **9 wxyz**).

R

roam To use a cellular system outside of your home system, usually when you travel beyond the range of your home system. If you are roaming you see the **▲** indicator (cellular mode only).

S

satellite mode When you are in this mode you are accessing the Iridium satellite system. You see the **🌐** indicator.

scroll To move backward or forward through a list; for example: to move backward or forward through the menu system or the name directory.

security code A six-digit code used to access sensitive features.

service provider A company affiliated with a cellular or satellite carrier that provides cellular/satellite service to its customers.

SID See System Identification.

signal The radio waves that carry information between your phone and the satellite or cellular system.

SMS Short Messaging Services.

standby-time The amount of time that your phone is left powered on to receive calls.

status indicator See indicator.

submenu A secondary level of your phone's menu system hierarchy.

System Identification An up to five-digit number that identifies your home cellular system. An even number indicates a wireline system and an odd number indicates a non-wireline system.

system mode A setting that determines the system type that your cellular phone accesses (CDMA/AMPS cellular mode).

system type A designation that indicates one of two competing cellular carriers in a given geographic area. The non-wireline carriers operate on "A" block frequencies and the wireline carriers operate on "B" block frequencies.

T

talk-time The amount of time that you spend talking on the phone.

TDMA Time Division Multiple Access. A digital technology.

toggle To switch between two possible options; for example: on vs. off.

Travel Charger An accessory device that allows you to power your phone and charge any attached batteries from a wall outlet.

V

volume keys Located on the side of your phone, the upper and lower volume keys are used to adjust ringer and earpiece volume.

W

wireline system A cellular carrier that is the same company as the conventional telephone company.

Index

A

- accessing hidden features 189
- accessing the network 159
- accessories 20
- accessory connector port 16
 - defined 207
- adapter
 - antenna 23
 - Auto Accessory 21
 - StarTAC 22
 - travel 20
- adding an entry 77
 - dedicated keys 76
 - menu 76
 - messages 77
- adjusting earpiece volume 53
- adjusting ringer volume 54, 136
- air bags 10
- aircraft 10
- airtime
 - defined 207
- AMPS
 - defined 207
- antenna 15
 - adapter 23
 - care 7
 - correct position 45
 - defined 207
 - extending 45
 - inserting 26
 - left detente 45
 - removing 26
 - right detente 45
 - rotate 43
- attaching battery covers 29
- Auto Accessory Adapter 21
 - defined 207
- automatic modes 173
- automatic redial 47, 54

available characters 79

B

- batteries 22
 - battery charge indicator 18
 - battery covers 29
 - battery meter 36, 110
 - cautions 38
 - charging 36
 - charging tips 38
 - check power status 36
 - desktop charging 34
 - disposing of 38
 - drains too fast 205
 - full charge 36
 - inserting 30
 - low battery warning 36
 - low charge 36
 - messages 37, 110
 - removing 32, 40
 - safety considerations 8
 - showing the battery meter 36, 110
 - storing 38
 - tips 38
 - using internal charger 35
 - won't charge 205
- battery covers 29
 - attaching 29
 - removing 29
- blasting areas 10
- Busy Try Later 58
- buttons
 - SIM card eject 15

C

- Call Answer? 51
- call barring 114
- Call Failed 46, 51
- call forwarding

- all calls 104
- cancelling 109
- when unavailable 102
- call holding 60
- Call Meters menu 177, 178, 202
- call muting 57
- Call Related Features menu 194
- call timers
 - audible 183
 - lifetime 186
 - repetitive 184
 - resetting all 182
 - showing all calls 182
 - showing last call 181
 - single alert 183
 - viewing in-call 185
- call waiting 58
 - accepting 58
 - activating 113
 - ending 58
 - rejecting 58
- calling an entry 85
- can't make calls 203
- Cannot Hold Second Call 58
- carry accessories 23
- CDMA
 - defined 207
- cellular
 - defined 207
- cellular carrier
 - defined 207
- Cellular Cassette 24, 169
 - connector 16
 - defined 207
 - inserting 39
 - messages 205
 - removing 40
- cellular mode
 - defined 207
 - selecting 176
- cellular system
 - defined 207
- characters 79
- charger
 - desktop 20

- solar 21
- travel 20
- Charging Battery 35, 37, 110
- check mark 19
- checking battery power status 36
- clear key 15
- clearing stored information 153
- clear-line-of-sight 15
 - defined 207
- compatibility 27
- Connected 51
- connection messages 46
- correcting an entry 78
- current state of service indicator 17
- customizing
 - Options Menu 188
 - phone features 131
 - Quick Access Menu 67, 190

D

- date
 - setting 148
 - viewing 146
- dedicated key 77
- default
 - defined 207
- Desktop Charger 20
- desktop charging of your battery 34
- detailed call forwarding 106
 - fax and data calls 108
 - voice calls 106
- detentes, antenna 45
- dialing a number 46
- dialing numbers with pauses 81
- dialing special characters 48
- Display 16
- disposing of batteries 38
- driving 8
- DTMF
 - defined 207
- dual mode phone
 - defined 207

Dual Tone Multi-Frequency Tones
defined 208

E

electronic devices 8
emergency call
defined 208
placing 50
setup 154
ending a call 48, 52
entering characters 78
entering names 78
entering pauses in numbers 80
erasing name and number 85
explosive atmospheres 10
exposure to radio frequency
signals 7
extended menus 189
accessing hidden features 189
activating 149, 189

F

factory defaults 152
Fast Charge Complete 37, 110
finding entry by location
dedicated keys 84
menu 84
finding entry by name 83
fixed dialing
adding an entry 89
editing an entry 91
modifying an entry 90
setting up 88
viewing list 92
flash 59, 61, 62, 103, 105, 107,
108, 109
fringe area
defined 208
function keys
defined 208

G

getting started 25
GSM

defined 208
GSM network selection
find new network 168
scan available networks 165
search method 166
automatic 167
manual 167
guide overview 12

H

hearing aids 9
hidden features 189
Hold Failed 58
holding 58, 60
holding the phone 45
home system 19
defined 208
home type system
defined 208

I

icons
display 65
quick access 19
Quick Access Menu custom
icons 190
Quick Access Menu default
icons 67
In Use symbol 19
In-Call Menu 68
call holding 60
call muting 57
call waiting 58
CDMA/AMPS Cellular Mode 68
defined 208
Satellite Mode 68
sending a flash 62
in-call timer 185
indicators 208
battery charge 18
check mark 19
current state of service 17
home system 19
In Use symbol 19

- no service 19
- quick access 19
- real time clock 18
- Roam symbol 19
- scroll bar 19
- short message service symbol 18
- signal strength 18
- inserting a battery 30
- inserting antenna 26
- inserting pauses into numbers 50
- inserting the Cellular Cassette 39
- inserting the SIM card 28
- international calling 47
- International Plug Kit 20
- international prefix 155
 - setup 155
- Invalid Batt 30, 37
- Iridium System
 - defined 208

K

- key presses 12
- keypad cover 16
- keypad tones
 - selecting 139
- keys
 - clear 15
 - memory recall 15
 - memory store 15
 - menu 15
 - message 15
 - power 15
 - quick access key 15
 - scroll 15
 - volume 15, 210

L

- landline
 - defined 208
- language
 - setting 150
- lanyard wrist strap 23
- last ten numbers dialed 93

- leather holster 23
- lifetime timer 186
- lock
 - defined 208
- lock code
 - defined 208
- locking phone
 - automatically 140
 - instantly 140
- low battery warning 36

M

- managing messages 126
- manual modes 176
- master clear 153
- master reset 152
- medical devices 9
- memory
 - phone 74
 - SIM 74
- memory location
 - defined 208
- memory recall key 15
- memory store key 15
- menu 63
 - Call Meters 178, 202
 - Call Related Features 100, 194
 - feature
 - defined 208
 - key 15
 - Messages 120, 196
 - Mode Selection 202
 - Network 160
 - Network Selection 159, 200
 - Phone Book 72, 192
 - Phone Setup 134, 198
 - quick reference 191
 - Selecting a Mode 169
 - system
 - defined 208
- menus
 - personalized menus 188
- message (SMS)
 - defined 208

- message key 15
- messages 119
 - adding an entry 77
 - battery 37, 110
 - connection 46
 - current state of service light 17
 - deleting 129
 - managing 126
 - notification 126
 - power on 43
 - reading 129
 - returning calls 130
 - Rotate Antenna 43
 - storing 126, 129
 - text 127
 - what's in one 127
- messages and prompts 12
- Messages menu 120, 196
- mode selection
 - automatic 173
 - cellular always 174
 - cellular preferred 176
 - manual 176
 - satellite 164
 - satellite always 175
 - satellite preferred 174
- Mode Selection menu 170, 202
- modifying name and number 85
- multiple key answer 51
- muting 57

N

- name directory
 - defined 209
- NAMPS
 - defined 209
- navigating the Options Menu 64
- Network Selection menu 160, 200
- networks
 - find new network 168
 - scan available 165
 - search method 166
 - automatic 167
 - manual 167

- no service 19
- non-home type system
 - defined 209
- non-wireline
 - defined 209
- Not Available 37, 110
- notification messages
 - fax 127
 - voicemail 127

O

- one-touch dialing
 - defined 209
 - setting up 96
 - using 96
- Options Menu
 - customizing 65, 188
 - defined 209
 - display icons 65
 - exiting 64
 - extended menus 189
 - moving features 188
 - navigating 64
 - phone response 65
 - scrolling 64
 - selecting options and submenus 64
- Orient Antenna 46, 51

P

- pacemakers 9
- package contents 20
- passwords
 - changing call bar password 118
- pause
 - defined 209
- pause dialing 50, 80
- pending call drop signal
 - deactivating 112
- Personal Mailbox Service 52
- Phone Book 49
 - adding an entry 76
 - calling an entry 85

- checking capacity 86
- erasing name and number 85
- find entry by location 84
- find entry by name 83
- last ten numbers dialed 93
- menu 70
- modifying name and number 85
- organizing 74
- preventing access 87
- storing names and numbers 76
- Phone Book Menu 192
- phone calls
 - automatic redial 47, 54
- phone flash 59, 61, 62, 103, 105, 107, 108, 109
- phone memory 74
- phone number 50, 94
- phone operation 8
- Phone Setup menu 134, 198
- PIN code
 - changing 143
 - defined 209
 - unblocking 143
- PIN2 code
 - changing 144
 - is blocked 204
 - unblocking 145
- placing calls
 - calling a phone book entry 85
 - dialing a number 46
 - embedded in a message 49, 130
 - emergency calls 50
 - from the phone book 49
 - international 47
 - last ten numbers dialed 93
 - number in a message 49
 - one-touch dialing 96
- Portable Dock 24
 - defined 209
- posted facilities 9
- power key 15
- power on messages 43
- powering your phone on 43
- prefixes 82

- preventing access to phone book 87
- preventing incoming calls 116
- preventing outgoing calls 114
- prompt
 - defined 209
- prompts and messages 12
- protecting SIM card with a PIN code 142
- Protecting Your SIM Card with a PIN Code 142

Q

- quick access icons 19
- quick access key 15
- Quick Access Menu 66
 - activating feature 66
 - custom icons 190
 - customizing 67, 190
 - default icons 67
 - defined 209
 - scrolling 66

R

- real time clock 18
- recalling entries 83
- receiving calls
 - answering 51
 - indicators 51
- Reconnect Failed 58
- Redial Failed 47
- Redial? 46, 47
- redialing last number called 48
- registering with satellite network 164
- removing a battery 32
- removing antenna 26
- removing battery covers 29
- removing the battery 32
- removing the Cellular Cassette 40
- removing the SIM card 28
- repetitive timer 184
- resetting options to defaults 152
- Restricted Area 46

- restricting calls 114
 - password 118
- restricting incoming calls 116
- restricting outgoing calls 114
- restricting phone use 88
- ringer tone
 - setting 138
- roam
 - defined 209
- Roam symbol 19
- Rotate Antenna 43, 45, 46, 51

S

- safety covers 29
- safety information 7
- satellite mode 164, 175
 - defined 209
 - selecting 174
- satellite network
 - registering 164
- scroll
 - defined 209
- scroll bar 19
- scroll keys 15
- scrolling
 - Options Menu 64
 - Quick Access Menu 66
- security code
 - changing 145
 - defined 209
- selecting a mode 169
- self tests 43
- send flash 59, 61, 62, 103, 105, 107, 108, 109
- service provider
 - defined 209
- setting phone to ring or vibrate 137
- settings
 - clearing 153
 - reviewing 151
- Short message service symbol 18
- SID. *See* System ID number
- signal

- defined 210
- signal strength 111
- signal strength symbol 18
- SIM card 27
 - changing PIN code 143
 - changing PIN2 code 144
 - deactivating PIN code 142
 - dual card capability 27
 - eject button 15
 - inserting 28
 - messages 205
 - protecting 142
 - removing 28
 - unblock PIN2 code 145
 - unblocking PIN code 143
- SIM memory 74
- single alert timer 183
- SMS
 - defined 210
- Solar Charger 21
- special characters 48
- special keys 15
- standby time 22, 44
 - defined 210
- StarTAC Adapter 22
- status indicator
 - defined 210
- storing batteries 38
- storing names and numbers 76
- submenus 63
 - defined 210
- switching between numbers 158
- symbols 12
- System Busy 46
- System ID number
 - defined 157, 210
- system mode
 - defined 210
 - selecting 156
- system scan 156
 - method 156
- system scan settings 157
- system type
 - defined 210

T

- talk-time
 - defined 210
- TDMA
 - defined 210
- time
 - setting 148
 - setting format 147
 - viewing 146
- timing calls 177
- tips 12
- toggle
 - defined 210
- Travel Charger 20
 - defined 210
- troubleshooting 203
 - battery drains fast 205
 - battery won't charge 205
 - can't cancel Call Forwarding or Barring 204
 - can't make international call 204
 - can't receive calls 203
 - can't turn power on 203
 - Cellular Cassette messages 205
 - message symbol is flashing 204
 - phone won't unlock 204
 - PIN is blocked 204
 - SIM card messages 205
 - SIM card won't work 204
 - wrong language in the display 206
 - your phone is hot 205
- Trying 58

turning the SIM card PIN On or Off 142

U

- unanswered calls 52
- unblocking PIN code 143
- unblocking SIM PIN2 code 145
- unconditional call forwarding 67
- understanding the guide 12
- unlock code
 - changing 141
- unlocking phone 141
- using the desktop charger 34
- using the internal charger 35
- using the SIM card 27
- using your phone 43

V

- vehicles 9
- vibrate 137
- voicemail
 - checking 124
 - storing number 125
- volume
 - earpiece 53
 - ringer 54, 136
- volume keys 15
 - defined 210

W

- Weak Signal 46
- what's my phone number 50, 94
- wireline system
 - defined 210

Patent Information

Manufactured under one or more of the following U.S. patents:

4121218	4616314	4741034	D306594	5083304	D337332	D354062	D368696
4138681	4617520	4742562	4912602	D324024	5230007	5384825	5510693
4193036	D286778	D295627	4918732	D324388	5230093	D356084	5511235
4254382	4626309	4746242	4922178	5095503	5233633	5402447	D369162
4302845	4628529	D295973	4945570	D325028	5235492	5406146	5513078
4312074	4629829	D295975	4954796	D325583	5237257	5406562	D369359
4327319	4630304	4751737	4959851	5109536	5239127	D357224	5519303
4329666	4630305	D296187	4963812	D325915	5241545	D357457	5519346
4369516	4633141	4761621	4963843	5113436	5241548	5410741	5524276
4369522	4636593	4764737	4965537	5117450	5241650	D357680	5524278
4378603	4636741	D297734	4972355	5121047	5241693	D357681	D370463
4390963	D288432	D297735	4972432	5122480	5242767	5428836	5530922
D269873	4648125	4777564	4972455	5122722	D339582	D359734	5542116
4398265	4649543	Re. 32768	4975808	D327061	5249302	D359735	5544250
4400584	D288683	D299136	4984290	5128834	5251331	D359959	D372481
4400585	4654655	4797929	D314173	D328302	D340710	5432017	5546275
D270835	D289156	4798975	D315330	5142551	5260988	D360632	5546380
D271491	4662691	4800348	D315346	5142696	5261119	5438684	D372896
Re. 31470	4667333	4802236	D315543	5146620	5262710	D361070	5551078
4431977	4668917	4809356	D315559	5148471	5263052	5442680	5559471
4434461	4670747	4811377	D315565	5148473	5276707	5446763	D374424
4455534	4672502	4811404	5004992	5148961	5278994	5448763	D374872
4462098	4680787	4827226	D315907	5150359	D343173	5448771	5572193
D275951	4681476	4827507	5008925	5150384	5280637	5453997	5574976
4484153	4683585	4829274	D316417	5152006	D344087	D362840	5577268
4485486	4692726	4837534	D316859	5157693	5287553	5457744	D375732
4486624	4704588	D301476	5017856	5163159	5287555	5459640	D375733
D276809	D292578	4843621	5018188	5164652	5287556	5463646	D375734
4491972	4706036	4845772	5020091	5166596	D344511	5465412	D375932
D277667	D292920	D302015	5020092	5175759	5301365	5469177	D375952
4504834	4710724	4851966	5020093	5175874	5321847	5475752	D376127
D278708	4711361	4868576	5028083	D332261	D348880	D365094	5588041
4523155	4715063	4870686	5028859	5182749	5349588	D365817	5589796
4546329	4716319	D303656	5029044	D332785	5359696	5486843	5590177
4550426	4716391	4876552	5029233	5185566	5361400	5487184	5594778
4551696	4723305	4879533	5031028	5187809	5363071	5488335	5594951
4564821	D294257	D305427	5036532	5193223	5365549	5488649	D377792
D282169	4727306	4896124	5053924	5195106	D352497	D366872	D377934
4571595	4727583	4897873	5057762	5195108	5366826	5493198	5604050
4573017	4730195	D305717	D320780	5201069	D353131	5493714	5606730
4574243	4734635	4904549	5059885	5204977	D353361	5497126	D378366
4585957	4736277	4905288	5060294	5210793	5375143	5497382	5613229
4602218	4737976	4905301	D322783	5214675	5375258	D367640	5613863
D284759	4740794	D306293	D322955	5222104	5379324	5499394	5615233
D285439	4741018	D306441	5081674	5222251	D354055	5506490	5621763

Other patents pending.

In order to access Iridium LLC Global Customer Care
(24 hours a day, 7 days a week), dial one of the following numbers:

English:	811* or +8817-629-90051 or +407-661-3204
Spanish:	812* or +8817-629-90052 or +407-661-3205
Portuguese:	813* or +8817-631-90053 or +31-79-347-1513
Russian:	814* or +8817-631-90054 or +31-79-347-1514
German:	815* or +8817-631-90055 or +31-79-347-1515
Italian:	816* or +8817-631-90056 or +31-79-347-1516
French:	817* or +8817-631-90057 or +31-79-347-1517
Japanese:	818* or +8817-637-90058 or +61-2-9215-1518
Cantonese:	819* or +8817-637-90059 or +61-2-9215-1519
Mandarin:	820* or +8817-637-90060 or +61-2-9215-1520
Korean:	821* or +8817-637-90061 or +61-2-9215-1521
Thai:	822* or +8817-637-90062 or +61-2-9215-1522
Arabic:	823* or +8817-631-90063 or +61-2-9215-1523
Other:	824* or +8817-637-90064 or +61-2-9215-1524

TTY Toll-Free Number 1-888-390-6456

TTY (outside the United States) +1-847-523-1841

+ designates international dialing access code (00)

*Toll free from the Satellite Series™ 9500 Portable Telephone.



MOTOROLA



products for
the iridium system

In order to contact Motorola (Monday thru Friday 7AM to 7PM [CST]),
dial one of the following numbers:
US & Canada: 1-888-839-4647
Outside the US & Canada: (Toll-Free Global Number): +1-8000-839-4647
Direct Dial: +1-847-523-1898

TTY Toll-Free Number 1-888-390-6456
TTY (outside the United States): +1-847-523-1841
+ designates international dialing access code (00)

www.motorola.com

©1998 Motorola, Inc.

Ⓜ, MOTOROLA, and the SATELLITE SERIES logo are trademarks or
registered trademarks of Motorola, Inc.

Iridium, the Iridium logo, and Iridium World Service are
trademarks and/or service marks of Iridium LLC.

68P09420A79-0

Free Manuals Download Website

<http://myh66.com>

<http://usermanuals.us>

<http://www.somanuals.com>

<http://www.4manuals.cc>

<http://www.manual-lib.com>

<http://www.404manual.com>

<http://www.luxmanual.com>

<http://aubethermostatmanual.com>

Golf course search by state

<http://golfingnear.com>

Email search by domain

<http://emailbydomain.com>

Auto manuals search

<http://auto.somanuals.com>

TV manuals search

<http://tv.somanuals.com>