



C51 Series

Connected System Phone
Digital 5.8 GHz Expandable

Model Family: SD7561

Users Guide

For a copy of a large-print version of this guide, or for product-related questions, please visit us online:

www.motorola.com/cordless

Or contact us at:

1-800-353-2729 U.S.A.

1-800-461-4575 Canada

1-888-390-6456 TTY (Text Telephone)

Copyright © 2006 Motorola, Inc. All rights reserved. No part of this publication may be reproduced in any form or by any means or used to make any derivative work (such as translation, transformation, or adaptation) without written permission from Motorola, Inc.

Motorola reserves the right to revise this publication and to make changes in content from time to time without obligation on the part of Motorola to provide notification of such revision or change. Motorola provides this guide without warranty of any kind, either implied or expressed, including but not limited to, the implied warranties of merchantability and fitness for a particular purpose. Motorola may make improvements or changes in the product(s) described in this manual at any time.

MOTOROLA and the Stylized M Logo are registered in the US Patent & Trademark Office. PhoneWrap is a registered trademark of Motorola, Inc. All other product or service names are the property of their respective owners.

Table of Contents

Important Safety Instructions	viii
Welcome	1
Handset Overview	2
Base Unit Overview	3
Main Menu Display Overview.....	4
Battery Safety Instructions.....	5
Installing the Handset Battery.....	6
Installing Base Unit Batteries (optional)	7
Selecting a Location for Your Base Unit.....	8
Connecting the Base Unit	9
Charging the Handset Battery.....	9
Installing the Mounting Bracket (optional)	10
How to Use this Guide	10
Using Your New System	12
System Indicators and Icons	14

Handset Information	14
Base Unit LEDs.....	14
<i>Customizing Your System</i>	15
Customizing Ring Tones and Volume	17
Setting the Date and Time	18
Display Language Menu	19
Color Handset Display Options	20
Naming Your Handset.....	21
Setting an Alarm	23
Using the Setup Devices Menu.....	24
Reviewing Caller ID Records	25
<i>Using the Phonebook.....</i>	26
Adding a Phonebook Entry	27
Dialing a Phonebook Entry.....	28
Editing a Phonebook Entry.....	28
Deleting a Phonebook Entry	29

Using the Answering Machine	30
Setting Up Your Answering Machine from the Base Unit	30
Setting Up Your Answering Machine from a Handset	31
Answering Machine and Base Unit Setup Options	32
Message Window Display Indicators	34
Checking Your Messages	35
Using the Remote Access Feature	36
Using Your System with Multiple Handsets	37
Setting Intercom Options	37
Using Your Phone as an Intercom	38
Transferring Calls Between Handsets	39
Changing the Order of Devices	40
Changing Default Phone Line Settings	41
Registering a New Handset	41
Troubleshooting	42
Warranty	44

FCC Information

FCC Compliance Class B Digital Device

This equipment has been tested and found to comply with the limits for a Class B digital device, pursuant to Part 15 of the FCC Rules. These limits are designed to provide reasonable protection against harmful interference in a residential installation. This equipment generates, uses, and can radiate radio frequency energy and, if not installed and used in accordance with the instructions, may cause harmful interference to radio communications. However, there is no guarantee that interference will not occur in a particular installation. If this equipment does cause harmful interference to radio or television reception, which can be determined by turning the equipment off and on, the user is encouraged to try to correct the interference by one of the following measures:

- Reorient or relocate the receiving antenna.
- Increase the separation between the equipment and receiver.
- Connect the equipment into an outlet on a circuit different from that to which the receiver is connected.
- Consult the dealer or an experienced radio/TV technician for help.

Privacy of communications may not be ensured when using this telephone.

Caution: Changes or modifications not expressly approved by Motorola for compliance could void the user's authority to operate the equipment.

This device complies with Part 15 of the FCC Rules. Operation is subject to the following two conditions: (1) This device may not cause harmful interference, and (2) this device must accept any interference received, including interference that may cause undesired operation.

FCC Declaration of Conformity

Motorola, Inc., Connected Home Solutions, 101 Tournament Drive, Horsham, PA 19044, 1-215-323-1000, declares that this cordless phone complies with 47 CFR Parts 2 and 15 of the FCC Rules as Class B digital devices.

Canadian Compliance

This Class B digital apparatus complies with Canadian ICES-003. Cet appareil numérique de la classe B est conforme à la norme NMB-003 du Canada.

Federal Communications Commission (FCC) Part 68 Statement

This Motorola cordless phone complies with Part 68 of the FCC rules and the requirements adopted by the Administrative Council for Terminal Attachments (ACTA). On the bottom of this equipment is a label that contains, among other information, a product identifier in format US: AAAEQ##TXXXX. If requested, this information must be provided to the telephone company.

The Ringer Equivalence Number (REN) is used to determine the number of devices that may be connected to the telephone line. Excessive RENs on the telephone line may result in the devices not ringing in response to an incoming call. In most, but not all areas, the sum of the RENs should not exceed five (5.0). To be certain of the number of devices that may be connected to the line, as determined by the total RENs, contact the telephone company.

For products approved after July 23, 2001, the REN for this product is part of the product identifier that has the format US: AAAEQ##TXXXX. The digits represented by ## are the REN without a decimal point (e.g., 03 is a REN of 0.3). For earlier products, the REN is separately shown on the label.

This equipment uses the following USOC jack: RJ11C. A plug and jack used to connect this equipment to the premises wiring and telephone network must comply with the applicable FCC Part 68 rules and requirements adopted by the ACTA. A compliant telephone cord and modular plug is provided with this product. It is designed to be connected to a compatible modular jack that is also compliant. See installation instructions for details.

Connection to Party Line Service is subject to state tariffs. Contact the state public utility commission, public service commission, or corporation commission for information. If this equipment causes harm to the telephone network, the telephone company will notify you in advance that the temporary discontinuance of services may be required. If advance notice is not practical, the telephone company will notify the customer as soon as possible. Also, you will be advised of your right to file a complaint with the FCC if you believe it is necessary.

The telephone company may make changes in its facilities, equipment, operations, or procedures that could affect the operation of the equipment. If this happens, the telephone company will provide advance notice in order for you to make necessary modifications to maintain uninterrupted service.

If trouble is experienced with this equipment, for repair or warranty information, please contact Motorola, Inc. at 1-877-466-8646. If the equipment is causing harm to the telephone network, the telephone company may request that you disconnect the equipment from the network until the problem is solved.

This equipment is hearing aid compatible.

If your home has specially wired alarm equipment connected to the telephone line, ensure the installation of the cordless phone does not disable your alarm equipment. If you have questions about what will disable alarm equipment, consult your telephone company or a qualified installer.

CAUTION: To maintain compliance with the FCC's RF exposure guidelines place the base unit at least 20 cm from nearby persons.

For body worn operation, this phone has been tested and meets the FCC RF exposure guidelines when used with the belt clip supplied or designated for this product. Use of other accessories may not ensure compliance with FCC RF exposure guidelines.

Industry Canada CS-03 Declaration of Conformity

This product meets the applicable Industry Canada technical specifications. The Ringer Equivalence Number (REN) is an indication of the maximum number of devices allowed to be connected to a telephone interface. The termination on an interface may consist of any combination of devices subject only to the requirement that the sum of the RENs of all the devices does not exceed five.

If this equipment does cause harmful interference to radio or television reception, which can be determined by turning the equipment on and off, the user is encouraged to try to correct the interference with one or more of the following measures:

- Reorient or relocate the receiving antenna (that is, the antenna for the radio or television that is "receiving" the interference).
- Reorient or relocate and increase the separation between the devices.

Important Safety Instructions

When using your telephone equipment, basic safety precautions should always be followed to reduce the risk of fire, electric shock, and injury:

1. Read and understand all instructions.
2. Follow all warnings and instructions marked on the product.
3. Unplug this product from the wall outlet before cleaning. Do not use liquid or aerosol cleaners. Use a damp cloth for cleaning.
4. Do not use this product near water (for example, near a bathtub, kitchen sink, or swimming pool).
5. Do not place this product on an unstable surface, such as a table, shelf, or stand. The product may fall, causing serious damage.
6. Slots and openings in the back or bottom of the base unit and handset are provided for ventilation. To protect them from overheating, these openings must not be blocked by placing the product on a soft surface such as a bed, sofa, or rug. This product should never be placed near or over a radiator or heat register. This product should not be placed in any area where proper ventilation is not provided.
7. This product should be operated only from the type of power source indicated on the marking label. If you are not sure of the type of power supply in your home, consult your dealer or local power company.

8. Do not allow anything to rest on the power cord. Do not install this product where it can be stepped on.
9. Never push objects of any kind into this product through slots in the base or handset. They may touch dangerous voltage points or short out parts that could result in a risk of fire or electric shock.
10. Never spill liquid of any kind on the product.
11. To reduce the risk of electric shock, do not disassemble this product. Instead, take it to an authorized service facility. Opening or removing parts of the base or handset other than specified access doors may expose you to dangerous voltages or other risks. Incorrect reassembly can cause electric shock when the product is subsequently used.
12. Do not overload wall outlets and extension cords, as this can result in the risk of fire or electric shock.
13. Unplug this product from the wall outlet and refer servicing to an authorized service facility under the following conditions:
 - When the power supply cord or plug is damaged or frayed.
 - If liquid has been spilled onto the product.
 - If the product has been exposed to rain or water.
 - If the product does not operate normally by following the operating instructions. Adjust only those controls that are covered by the operating instructions, as improper adjustment of other controls may result in damage and often requires extensive work by an authorized technician to restore the product to normal operation.

- If the product has been dropped and the base and/or handset has been damaged.
 - If the product exhibits a distinct change in performance.
14. Avoid using a telephone (other than cordless) during an electrical storm. There is a remote risk of electric shock from lightning.
 15. Do not use the telephone to report a gas leak in the vicinity of the leak.
 16. Only put the handset of your telephone next to your ear when it is in normal talk mode.

Welcome

Congratulations on your purchase of a Motorola SD7561 Series telephone. Check the contents listing on the product packaging to ensure that your purchase includes each of the items listed.

Product registration is an important step toward enjoying your new Motorola product. Registering helps us facilitate warranty service, and permits us to contact you should your Motorola product require an update or other service. Registration is not required for warranty coverage.

To register your product online, visit:

<http://broadbandregistration.motorola.com>

Product registration is not available in Canada.

Please retain your original dated sales receipt for your records. For warranty service of your Motorola product, you will need to provide a copy of your dated sales receipt to confirm warranty status.

Handset Overview

1. Volume controls
2. LCD display
3. Left and right softkeys
4. Redial log of last five numbers dialed
5. Phone On/Flash
6. Temporary tone dialing key
7. Speakerphone
8. Microphone
9. Connect to other registered devices
10. Add pause in number
11. Up and down scroll key
12. Phone Off/Cancel
13. Headset jack (2.5 mm)
14. Delete
15. In use/Ringer and message indicator

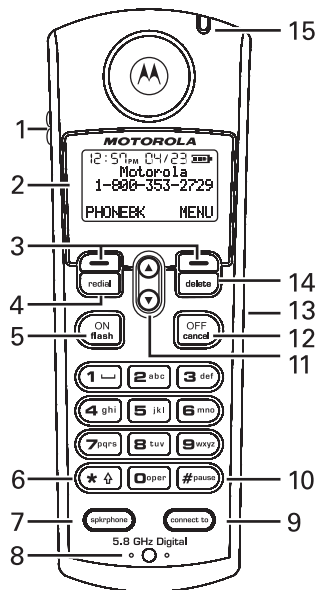

Base Unit Overview

1. Page button
2. Handset charging cradle
3. Up light
4. Speaker/In use and new message indicator
5. Volume control buttons
6. Message display
7. Set minutes
8. Set hour
9. Set or check day and time
10. Message playback controls

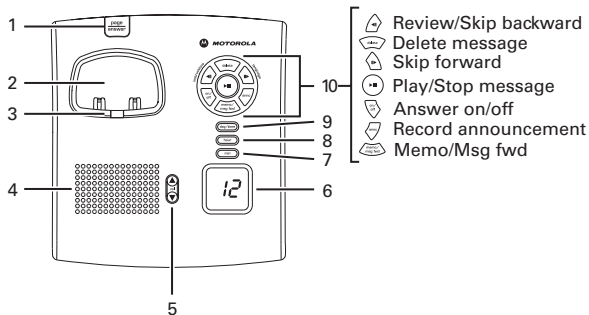

NOTE: The **INSTRUCTION** key is for use during the initial setup of your answering machine. Press the **LANGUAGE** key at any time to switch the system language to English or French.

Main Menu Display Overview

1. Device name
2. Answering machine status
3. Left softkey options
4. Right softkey options
5. Ringer status
6. Number of messages waiting
7. Battery charging icon (appears only when the handset is in the cradle or with **LOW BATTERY** message)

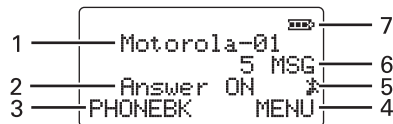

Caller ID Display Overview

1. Time of day the call was received
2. Name of caller
3. Left softkey option
4. Right softkey option
5. Order of call and number of calls received
6. Caller's phone number
7. Date the call was received

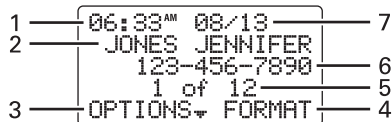

NOTE: Caller ID information is supplied only if you subscribe to the service with your telephone company.

Battery Safety Instructions

- Do not burn, disassemble, mutilate, or puncture the battery. The battery contains toxic materials that could be released, resulting in injury and/or explosion.
- **CAUTION:** There is a risk of explosion if you replace the battery with an incorrect battery type. Use only the battery that came with your phone or an authorized replacement recommended by the manufacturer.
- Keep batteries out of the reach of children.
- Remove batteries if storing over 30 days.
- The rechargeable batteries that power this product must be disposed of properly and may need to be recycled. Refer to your battery's label for battery type. Contact your local recycling center for proper disposal methods.

Installing the Handset Battery

1. Remove any stickers or inserts, if present.
2. Remove the battery door by pressing down on the indentation and sliding downward.
3. Plug the battery connector into the receptacle. (Make sure the black wire is on the right.)
4. Insert the battery into the battery compartment.
5. Replace the battery door.
6. Attach the belt clip (optional).

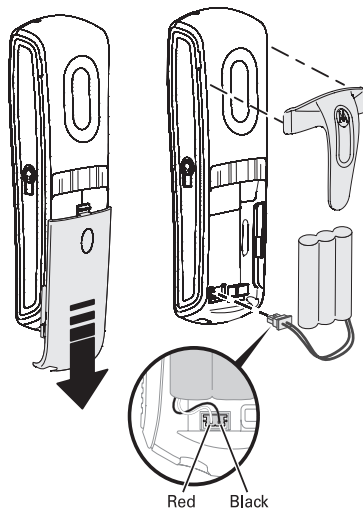

Installing Base Unit Batteries (optional)

1. Push the battery door latch forward using a small tool to remove it from the base unit.
2. Insert four AA batteries (not included).
3. Replace the battery door.

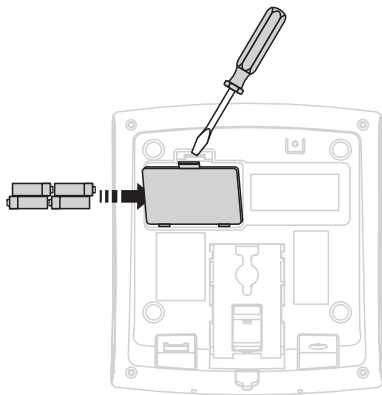

Selecting a Location for Your Base Unit

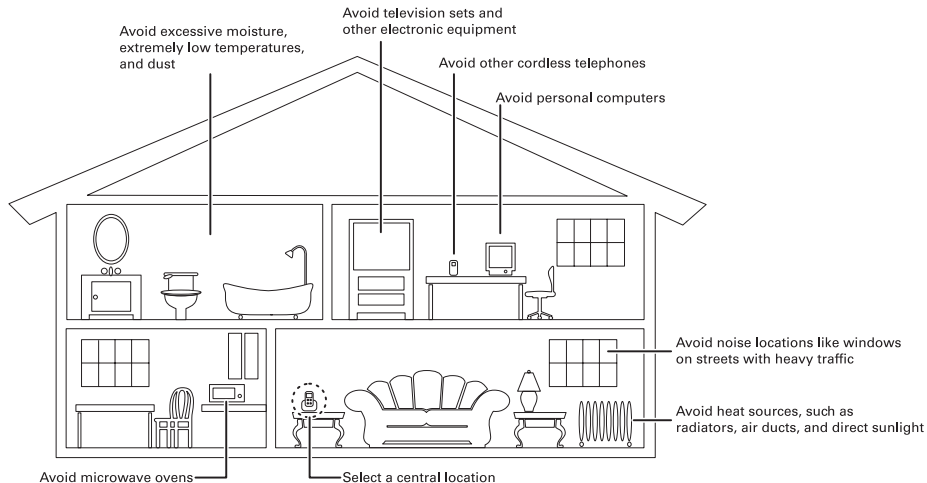

Connecting the Base Unit

1. Insert the phone and power cords into the back of the base unit.
2. Plug the phone cord into a wall jack, and the power cord into an electrical outlet.
3. Place the base on a sturdy surface, or mount it to a telephone wall jack (see Installing the Mounting Bracket).

Charging the Handset Battery

The initial battery charge time is 10–12 hours. After the initial charge, a maintenance charge of eight hours should be sufficient. Be sure to place the handset in its base when not in use to insure maximum daily performance.

NOTE: If your handset displays a **LOW BATTERY** message, or the handset seems completely inactive (the LCD is blank and does not activate when you press the keys), charge the handset.

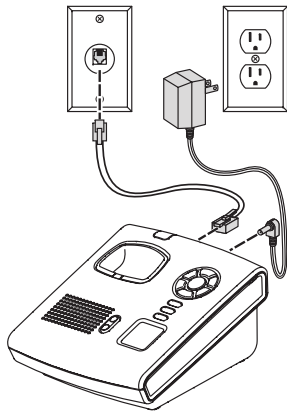

Installing the Mounting Bracket (optional)

1. Press the release button and push the mounting bracket forward to remove it from the bottom of the base unit.

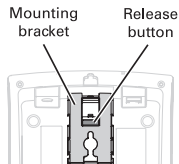

2. Turn the mounting bracket upside down.
3. Align the tabs of the mounting bracket with the slots on the bottom of the base unit.
4. Push the mounting bracket forward, sliding it into place. There is a click when it is seated correctly.
5. After connecting the phone and power cords (see instructions on the previous page), align the base unit with the mounting studs on the wall jack. Slide the base unit down on the mounting studs until it locks into place.

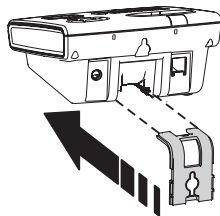
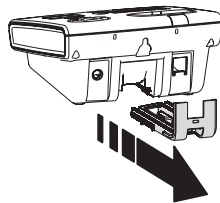

How to Use this Guide

This guide makes use of two fonts to distinguish between **FUNCTIONS** and **FEATURES/OPTIONS**.

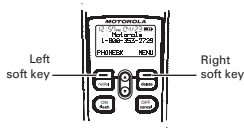

- **FUNCTION** keys are found on the handset and allow you to perform actions such as placing calls (**ON/FLASH**), ending calls (**OFF/CANCEL**), and connecting to (**CONNECT TO**) different devices.
- **FEATURES/OPTIONS** are only visible on the display and allow you to access menus such as **Ringer**, **Alarm Clock**, and **Phonebook**. When you see the **FEATURES/OPTIONS** font in this guide, use the softkeys to access the feature menu and to see the available options.

The left and right softkeys are located above the **REDIAL** and **DELETE** keys. Use the softkeys to select features and options that appear on the display directly above the corresponding softkeys (Using Your New System for additional information).

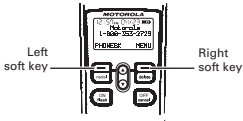

Using Your New System

Use the chart below to learn how to use the functions and features of your new system.

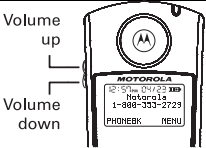
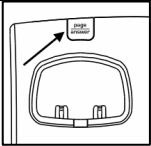

ON/FLASH	Press to answer a call. Press again to switch to a waiting call.
OFF/CANCEL	Press to end a call or cancel an action.
Left and right softkeys	<p>The softkeys are located above the REDIAL and DELETE keys. Use the softkeys to select features listed directly above the button on the display. Available functions change as you move from one screen to the next.</p> 
Scroll keys	Use to navigate through menu options. (An up and down arrowhead  indicates additional options are available.)
Redial	Press to see the last five numbers dialed. Use the scroll key to select a number from the list. Press ON/FLASH or SPKRPHONE to dial the selected number. Press OFF/CANCEL to exit the redial review list without dialing a number.
Delete	Use to edit phone numbers and names, and to delete items from the phonebook.

Spkrphone	Use to make or answer a call hands-free. To make a call, dial the number first or after pressing the key. Press to switch between the speakerphone and the earpiece.
Connect to	Press to connect to any device registered to your base unit. Scroll to and select a device. Press the corresponding softkey to connect to the device (e.g., press the PAGE softkey to initiate an intercom call).
Volume controls	<p>Press the VOL ▲ ▼ keys on the left side of the handset to adjust the listening volume to a comfortable level. When you are not on a call, use the volume control keys to turn the ringer volume to HIGH, MED, LOW, or OFF.</p> 
Page	<p>The PAGE button is found only on the base unit, directly behind the handset cradle. Use the PAGE button to register new devices, and to locate misplaced handsets. To locate a handset, press the PAGE button. Registered devices beep and Paging from base appears on the displays. To end the page, press the EXIT softkey, or press the PAGE button again.</p> 

System Indicators and Icons

When using your system you may see one or more of the following messages, icons, and LEDs.

Handset Information

Indicator	Description
Call muted	The microphone is muted
	The ringer is off
	The battery is charging
	The speakerphone is in use

Base Unit LEDs

LED	Description
in use	On when a handset is off-hook.
up light/page	On when the handset is charging in the cradle. Flashes when paging a handset.

Customizing Your System

Customizing your system features (e.g., **Ringer**, **Language**, etc.) requires a few basic steps. The table below lists the necessary steps.

NOTE: You can change the options in sequence or skip through the menu. Use the scroll keys to move from one option to the next.

To customize a setting:

1. Press the **MENU** softkey.
2. Scroll to and select the desired feature (e.g., **Ringer**, **Date/Time**, **Language**).
3. Scroll to the option you wish to change (e.g., **Day volume**, **Ringer Tone**, **Key Beeps**).
4. Press the **CHANGE** softkey. You will see and/or hear the available options.
5. Continue to press **CHANGE** or use the scroll keys to sample the settings until you reach the desired selection.
6. Press the **DONE** softkey to save the new setting.
7. Scroll to the next option you wish to change and repeat steps 3 through 6.
8. Press the **DONE** softkey when you have finished making all of your changes. The system returns you to the main menu.
9. Press the **EXIT** softkey or **OFF/CANCEL** to return to the main screen.

OPTIONS	SETTINGS	NOTES
Day Volume	<ul style="list-style-type: none">• High• Medium• Low• Off	The default setting for day hours is from 6 AM to 9 PM.
Night Volume	<ul style="list-style-type: none">• High• Medium• Low• Same as day*• Off	*Volume setting remains the same for day and night hours. The default setting for night hours is from 9 PM to 6 AM.
Ringer Tone	Scroll through the list to hear samples of each available ring tone.	Plays when you receive a call from a number not stored in your phonebook. 20 ring tones are provided. Five additional spaces allow you to download ring tones from www.openLCR.com , a third-party website that allows you to purchase additional ring tones, images, and other services.

Customizing Ring Tones and Volume

OPTIONS	SETTINGS	NOTES
Phonebook Tone	See Ringer Tone	Plays when you receive a call from a number stored in your phonebook.
Alarm Tone	Scroll through the list to hear samples of each available ring tone.	Sounds when your alarm goes off.
Key Beeps	<ul style="list-style-type: none">• On• Off• Link to ringer*	When on, the keys beep when pressed. *Turns key beeps on when the ringer is on, and off when the ringer is off.

Setting the Date and Time

If you subscribe to caller ID with your local telephone company, the date and time set automatically with the first incoming call.

OPTIONS	SETTINGS	NOTES
Time	Enter the current time.	
Time Format	<ul style="list-style-type: none">• 12 hour clock• 24 hour clock	
Date (MM/DD) or (DD/MM)	Enter the current date in the selected format.	
Date Format	<ul style="list-style-type: none">• Month and Day (MM/DD)• Day and Month (DD/MM)	
Year (YYYY)	Enter the current year.	You must set this option even if you have caller ID.
Night Time	Enter the range of nighttime hours for use with the night volume ringer setting (e.g., From 09:00 PM, To 06:00 AM).	

Display Language Menu

OPTIONS	SETTINGS	NOTES
Language	English Francais	If you accidentally change the language setting, follow these steps: <ol style="list-style-type: none"><li data-bbox="701 304 1158 363">1. Press OFF/CANCEL until you are at the standby screen.<li data-bbox="701 368 1096 394">2. Press the right softkey once.<li data-bbox="701 399 1133 425">3. Press the scroll button up once.<li data-bbox="701 430 1082 456">4. Press the left softkey once.<li data-bbox="701 462 1158 521">5. Scroll to the desired language and press the left softkey.

Color Handset Display Options

If you have a color handset, in addition to ringer options, you can modify your display's wallpaper and color pallets from the **Display Setup** menu.

OPTIONS	SETTINGS	NOTES
Contrast	Contrast levels 0–10	Use the scroll keys to make the display contrast lighter or darker.
Wallpaper	10 images are supplied with the handset. You can download additional images from www.openLCR.com .	Displays in the background of your handset screen.
Menu Color	Five color options available	
Backlite timer	10-second intervals ranging from 10 to 60	Sets the amount of time before your display fades to black.
Base Setting	<ul style="list-style-type: none"> • Day time ON • Always ON 	The handset display backlight remains on during daytime hours, or is always on when the handset is charging.

Naming Your Handset

Each registered handset has a default name (e.g., **Handset-A-01**; the number represents the order in which the handset was registered to the base unit and remains part of the name). You can rename your handset to make it easily distinguishable from other registered handsets.

To name your handset:

1. Press the **MENU** softkey.
2. Scroll to and select **Name Handset**.
3. Use the **BACKSP** softkey or the **DELETE** key to erase the current name. Use the keypad to enter the new name. See the key chart on the next page.
4. Press the **DONE** softkey when you have finished making all of your changes.
5. Press the **EXIT** softkey or **OFF/CANCEL** to return to the main screen.

NOTES:

- Pressing the * key toggles between shift/no shift.
- When the cursor is a flashing underscore, lower case (No Shift) characters are active.
- When the cursor is a flashing box, upper case (Shift) characters are active.

Buttons	Number of Presses— No Shift				
	1	2	3	4	5
1	space	&	\$:	1
2	a	b	c	[2
3	d	e	f]	3
4	g	h	i	@	4
5	j	k	l	\	5
6	m	n	o	.	6
7	p	q	r	s	7
8	t	u	v	!	8
9	w	x	y	z	9
#	#				

Buttons	Number of Presses— Shifted				
	1	2	3	4	5
1	_	-	*	,	1
2	A	B	C	(2
3	D	E	F)	3
4	G	H	I	+	4
5	J	K	L	/	5
6	M	N	O	'	6
7	P	Q	R	S	7
8	T	U	V	?	8
9	W	X	Y	Z	9
#	#				

Setting an Alarm

When entering the time, use leading zeroes (e.g., 05:45).

To set your alarm clock:

1. Press the **MENU** softkey.
2. Scroll to and select **Alarm Clock**.
3. Use the keypad to enter the time you wish the alarm to sound.
4. Press 1 for **AM** or 2 for **PM** when prompted.
5. Press the **On/Off** softkey to set the alarm occurrences (e.g., **On Once**, **On Daily**, **Off**).
6. Press the **DONE** softkey when you have finished making all of your changes.
7. Press the **EXIT** softkey or **OFF/CANCEL** to the main screen.

ALARM CLOCK SETTINGS	NOTES
On Once On Daily Off	One-time-only alarm event Daily alarm event Alarm feature is off

Using the Setup Devices Menu

The **Setup devices** menu allows you to configure optional devices, such as cell docks and cameras, after you have registered them to your base unit.

To set up additional devices:

1. Press the **MENU** softkey.
2. Scroll to and select **Setup devices**.
3. Scroll to the device you wish to configure.
4. Press the **SETUP** softkey.
5. Scroll to and select the option you wish to change.
6. Press the **EXIT** softkey after you have completed all changes.

Reviewing Caller ID Records

There are two ways to access caller ID records. The fastest way is to press the scroll key.

Use the second option, detailed below, if you wish to store a number in the phonebook or dial a number directly from the call list.

To review caller ID records:

1. Press the **MENU** softkey.
2. Scroll to and select **Recent calls**.
3. Use the scroll key to move up or down the list. The system displays the most recent call first.
4. Press the **OPTIONS** softkey to **Store** or **Delete** one or all call records.
5. Press the **FORMAT** softkey to change the way a number is dialed (1+area code+number, area code+number, or number only).
6. Press the **EXIT** softkey or **OFF/CANCEL** after you have completed your review.

RECENT CALL OPTIONS	NOTES
Delete	Press to remove a single entry in the list.
Delete all	Press to remove all entries.
Store	Press to store a number in the list.

Using the Phonebook

Each handset has a private phonebook that can store up to 50 names with numbers. Stored names can be up to 11 characters long; numbers can be up to 24 digits.

NOTES:

- If the phonebook is full, the handset will display **PHONEBK FULL** when you try to add an entry.
- While entering numbers, press the **#/PAUSE** key twice to add a two-second pause (for instance, if you need to wait for an outside line). A letter “P” appears in the number on the display.

Adding a Phonebook Entry

Each registered handset can store up to 50 entries.

To add a phonebook entry:

1. Press the **PHONEBK** softkey.
2. Scroll to and select **New Entry**.
3. Scroll to and select **Name, Number, or Ringer**.
4. Enter the name (up to 11 characters) or the number (up to 24 digits). Use the **BACKSP** softkey or **DELETE** key to edit the name and number entries.

NOTE: To move to the next option (e.g., **Name, Number, or Ringer**), you can press the corresponding softkey, or press down on the scroll key.

5. Select the **Ringer** option to choose a ring tone that plays when you receive a call from this phone number.
6. Press the **CHANGE** softkey or use the scroll key to hear samples of the ring tones.
7. Press the **DONE** softkey when you have finished making all of your changes.

Dialing a Phonebook Entry

To call a phonebook entry:

1. Press the **PHONEBK** softkey.
2. Scroll to the name or use the keypad to press the first letter in the contact's name.
3. Press the **ON/FLASH** or **SPKRPHONE** key to dial the number.

Editing a Phonebook Entry

To edit a phonebook entry:

1. Press the **PHONEBK** softkey.
2. Scroll to the desired entry.
3. Press the **OPTIONS** softkey to edit the entry.

OR Press the **VIEW** softkey to change the dialing format by using the **FORMAT** softkey (e.g., 1+area code+number, area code+number, or number only).

4. Scroll to and select **EDIT**.
5. Scroll to and select **Name**, **Number**, or **Ringer**.
6. Use the **BACKSP** softkey or **DELETE** key to edit the name and/or number.
Press **CHANGE** or use the scroll key to listen to and select a new ring tone.
7. Press the **DONE** softkey when you have finished making all of your changes.

Deleting a Phonebook Entry

To delete a phonebook entry:

1. Press the **PHONEBK** softkey.
2. Scroll to the desired entry.
3. Press the **OPTIONS** softkey.
4. Scroll to and select **DELETE**.
5. Press the **YES** softkey at the **Delete Item?** prompt. The display reads, **Phonebk entry deleted**.

Using the Answering Machine

Your telephone's integrated answering machine uses audible prompts to help you set up the device. You can access your answering machine from the base unit or from any registered handset.

Setting Up Your Answering Machine from the Base Unit

To set up your answering machine from the base unit:

1. Plug in the base unit. The answering machine announces *Press review to receive setup instructions.*
2. Press the **INSTRUCTIONS** button. The answering machine announces the following:
 - *Press and hold announcement key to record announcement. Release key to stop recording.*
 - *Press announcement key to check announcement.*
 - *Press and hold minute or hour key to set time.*
 - *Press minute key to set exact minute.*
 - *Press and hold Day/Time key to set day.*
 - *Press the Day/Time key to check day and time.*

NOTE: If you decide not to record an announcement, the prerecorded announcement (*Please leave your message after the tone.*) plays.

Setting Up Your Answering Machine from a Handset

The **Setup devices** menu allows you to set up your answering machine, change your base unit's settings, and customize any additional devices (e.g., cell docks, cameras, handsets) you add to your system.

To set up additional devices:

1. Press the **MENU** softkey.
2. Scroll to and select **Setup devices**.
3. Scroll to the device you wish to customize.
4. Press the **SETUP** softkey.
5. Press the **EXIT** softkey after you have completed all changes.

Answering Machine and Base Unit Setup Options

Answering Machine Setup Options

OPTIONS	SETTINGS	NOTES
<p>Answer ON/OFF</p> <p>Outgoing Msg</p> <p>Ring Number</p> <p>Security ID*</p> <p>Forward Msg's**</p>	<p>Play OGM, Record OGM, Change OGM</p> <p>3, 4, 5, 6, toll saver</p> <p>Enter any three-digit number</p> <p>Set Forward Number, Forward ON/OFF, View Unit ID</p>	<p>From any touch-tone phone, dial your number. After the outgoing message plays and you hear the tone, enter your three-digit Security ID to hear your messages.</p> <p>**Enter a phone number for message forwarding. Set the feature to ON and press the MEMO/MSG FWD button. When you have new messages, your system dials the programmed Set Forward Number. After answering, enter your Security ID for remote access.</p>

NOTES:

- Selecting the **toll saver** option allows you to check for messages from a remote location without accruing charges for the call. If the answering machine picks up right away, there are new messages. If the phone continues to ring, there are no new messages.
- The **Forward Msg's** feature must be set to **ON** or messages will not be forwarded.

Base Unit Setup Options

OPTIONS	SETTINGS	NOTES
Tone/Pulse Name Base Ringer Alarm Clock Date/Time Record Quality* Charge LED**	*Med qual/Longr Hi qual/Shortr **ON, OFF, Night time off	*Select high quality for greater resonance but shorter recording time, or select medium recording quality with a longer recording time. **When a handset is charging in the base unit's cradle, you can turn the upright on, off, or off during evening hours.

NOTE: Changing the **Tone/Pulse** setting at the base unit changes the setting for all registered handsets.

Message Window Display Indicators

WINDOW DISPLAYS:	DESCRIPTION
0~59	The number displayed (0 through 59) indicates the total number (combined old and new) of messages in the system. NOTE: When the number is blinking, you have new messages.
CL (blinking)	The clock has not been set.
== (blinking)	The outgoing message is playing, or a message or memo is being recorded.
--	The answering machine is off.
An (blinking)	The answering machine is answering a call.
F (blinking)	The answering machine memory is full.
L1 to L6	Appears when you change the volume level using the volume control keys on the base unit.
LA	Line Access—a handset is checking the answering machine.
EL	The English voice prompt is set.
LF	The French voice prompt is set.
IE	The Spanish voice prompt is set.

Checking Your Messages

You can check messages directly from the base unit or from any registered handset. When checking messages from the base unit, press the desired control key to play, rewind, fast forward, or delete a message.

To check your messages from a registered handset:

1. Scroll to and select **Messages**. The handset automatically goes into speakerphone mode and announces the available options:
 - *Press **2** to play messages, press 2 again to stop*
 - *Press **0** while playing a message to erase*
 - *Press **1** to review*
 - *Press **3** to skip*
 - *Press **4** to turn off or on*
 - *Press **5** to record new memo*
 - *Press **7** to review menu again*
2. You can select the desired option at the audio prompt, or scroll through the list and press the **SELECT** softkey.
3. Press the **EXIT** softkey or **OFF/CANCEL** to end the review session.

Using the Remote Access Feature

To use the remote access feature from a touch tone phone:

1. Dial your telephone number.
2. Enter your remote access code (preset to 123) after the outgoing announcement plays and you hear the tone. The system announces the available menu options:
 - *Press 2 to play messages, press 2 again to stop*
 - *Press 0 while playing a message to erase*
 - *Press 1 to review*
 - *Press 3 to skip*
 - *Press 4 to turn off or on*
 - *Press 5 to record new memo*
 - *Press 7 to review menu again*
3. Press the corresponding number key for the desired option.
4. Hang up to end the review session.

NOTE: If the answering machine is set to OFF, the system will answer on the tenth ring, announce, "Answer off," and wait seven seconds for your security ID code. If no code is entered, the system ends the call. You can turn on your system remotely by pressing "4" on the keypad. If the memory is full, on the tenth ring, the system answers and announces, "Memory full," and waits seven seconds for your security ID code.

Using Your System with Multiple Handsets

If you have at least two handsets registered to your base unit, you can use the intercom and the call transferring features.

Setting Intercom Options

To set your intercom options:

1. Press the **MENU** softkey.
2. Scroll to and select **Set Intercom**.
3. Scroll to and select the option that tells the handset how to answer a page (pick up automatically after either the first or third ring and answer in speakerphone mode), or turn off auto-answer.
4. Press the **EXIT** softkey to return to the main screen.

Using Your Phone as an Intercom

To use the intercom feature:

1. When not on a call, press the **CONNECT TO** button on any handset.
2. Scroll to the name of the device that you wish to contact.
3. Press the **PAGE** softkey. Both devices beep.
4. Answer the page by pressing the **OK** softkey, or **ON/FLASH**.
5. Press **OFF/CANCEL** on either handset to end the call.

Transferring Calls Between Handsets

During an outside call, you can transfer the call from one handset to another (for example from **Handset-A-01** to **Handset-B-02**).

To transfer an outside call from one handset to another:

1. Press the **CONNECT TO** key on the handset with the outside call. The system automatically places the call on hold.
2. Scroll to and select the handset you wish to contact (e.g., **Handset-B-02**).
3. Answer the page by pressing the **OK** softkey or **ON/FLASH** on the other handset.
4. Announce the call if you wish, and then press the **CONF** softkey to join all handsets on the call.
5. Press **OFF/CANCEL** to transfer the call.

NOTE: If the second handset does not respond within 30 seconds, the outside call returns to the first handset, and **CALL BACK** appears on the display. If the returned call is not answered within 60 seconds, the outside call ends automatically.

Changing the Order of Devices

By default, registered devices appear in your **CONNECT TO** list in the order in which they were registered. You can change this order using the **DEVICE REORDER** menu.

To change the order of registered devices:

1. Press the **MENU** softkey.
2. Scroll to and select **Device Reorder**.
3. Scroll to and select the device you wish to move. An asterisk (*) appears beside the device name.
4. Use the scroll key to move the arrow to the location to which you wish to move the device.
5. Press the **MOVE** softkey to reposition the item.
6. Press the **EXIT** softkey to return to the menu.

Changing Default Phone Line Settings

NOTE: This feature is for use when you add one or more Motorola C51 Series Cell Docks or Internet phone modules. See the device user guide for additional instructions.

Registering a New Handset

Devices packaged with your base unit are pre-registered. You can register up to 12 devices (e.g., handsets, cameras, cell docks) to your base unit. For information on registering other devices, please consult the user guide.

To register a new handset:

1. Press the **MENU** softkey.
2. Scroll to and select **Register**.
3. Press and hold the base unit's **PAGE** button (located on the base unit in the charging cradle). **Wait Registering...** appears on the display. **Handset (X) Registered** appears when the process is complete.

Troubleshooting

The suggestions below should solve most problems you might encounter while using your phone. If you still have difficulty after trying these suggestions, visit us on the web at www.motorola.com/cordless.

If the phone does not work at all:

- Make sure the power cord is plugged firmly into the base unit and electrical outlet.
- Make sure the phone cord is plugged firmly into the base unit and the telephone wall jack.
- Make sure the battery is properly inserted and fully charged. **LOW BATTERY** appears on the display when the battery needs charging.

If there is no dial tone:

- First, try all the suggestions above.
- If you still do not hear a dial tone, disconnect the base unit from the telephone jack and connect a different phone. If there is no dial tone on that phone, contact your local telephone company.

If there is noise, static, or a weak signal when you are away from the base unit:

- You may be out of range. Either move closer to the base unit, or relocate it.
- The layout of your home may be limiting the range.

If there is noise, static, or a weak signal even when you are near the base unit:

- Household appliances plugged into the same circuit as the base unit can sometimes cause interference. Try moving the appliance or the base unit to another outlet.

If the handset does not ring when you receive a call:

- Make sure you have the ringer turned on and loud enough to hear. (See the instructions on the ring tone and ringer volume for additional information.)
- Make sure the telephone line cord is plugged firmly into the base unit and the telephone wall jack.
- Make sure the power cord is plugged into the base unit and an electrical outlet.
- Move closer to the base unit.

If you hear other calls while using your phone:

- Disconnect your base unit from the telephone jack, and plug in a different telephone. If you still hear other calls, contact your local telephone company.

Common Troubleshooting Steps for Your Cordless Phone

If the handset or base unit does not seem to be responding normally, try putting the handset in its base. If it does not seem to respond, do the following (in the order listed):

1. Disconnect the power to the base.
2. Disconnect the handset and base backup battery.
3. Wait a few minutes.
4. Connect power to the base unit.
5. Re-install the battery.
6. Wait approximately 60 seconds for the handset to re-establish its link with the base.

Warranty

Motorola Limited Warranty for Consumer Products, Accessories, and Software Purchased in the United States or Canada

What Does this Warranty Cover?

Subject to the exclusions contained below, Motorola, Inc. warrants its cordless telephones ("Products"), Motorola-branded or certified accessories sold for use with these Products ("Accessories"), and Motorola software contained on CD-ROMs or other tangible media and sold for use with these Products ("Software") to be free from defects in materials and workmanship under normal consumer usage for the period(s) outlined below. This limited warranty is a consumer's exclusive remedy, and applies as follows to new Motorola Products, Accessories, and Software purchased by consumers in the United States or Canada, which are accompanied by this written warranty:

Products and Accessories as defined above, unless otherwise provided for below. Length of coverage: one (1) year from the date of purchase by the first consumer purchaser of the product unless otherwise provided for below.

- **Decorative Accessories and Cases.** Decorative covers, bezels, PhoneWrap® covers and cases. Length of coverage: limited lifetime warranty for the lifetime of ownership by the first consumer purchaser of the product.
- **Monaural Headsets.** Ear buds and boom headsets that transmit mono sound through a wired connection. Length of coverage: limited lifetime warranty for the lifetime of ownership by the first consumer purchaser of the product.
- **Products and Accessories that are Repaired or Replaced.** Length of coverage: The balance of the original warranty or for ninety (90) days from the date returned to the consumer, whichever is longer.
- **Software.** Applies only to physical defects in the media that embodies the copy of the software (e.g. CD-ROM, or floppy disk). Length of coverage: ninety (90) days from the date of purchase.

Exclusions

Normal Wear and Tear. Periodic maintenance, repair, and replacement of parts due to normal wear and tear are excluded from coverage.

Batteries. Only batteries whose fully charged capacity falls below 80% of their rated capacity and batteries that leak are covered by this limited warranty.

Abuse & Misuse. Defects or damage that result from: (a) improper operation, storage, misuse or abuse, accident or neglect, such as physical damage (cracks, scratches, etc.) to the surface of the product resulting from misuse; (b) contact with liquid, water, rain, extreme humidity or heavy perspiration, sand, dirt or the like, extreme heat, or food; (c) use of the Products or Accessories for commercial purposes or subjecting the Product or Accessory to abnormal usage or conditions; or (d) other acts which are not the fault of Motorola, are excluded from coverage.

Use of Non-Motorola Products and Accessories. Defects or damage that result from the use of Non-Motorola branded or certified Products, Accessories, Software or other peripheral equipment are excluded from coverage.

Unauthorized Service or Modification. Defects or damages resulting from service, testing, adjustment, installation, maintenance, alteration, or modification in any way by someone other than Motorola, or its authorized service centers, are excluded from coverage.

Altered Products. Products or Accessories with (a) serial numbers or date tags that have been removed, altered, or obliterated; (b) broken seals or that show evidence of tampering; (c) mismatched board serial numbers; or (d) nonconforming or non-Motorola housings, or parts, are excluded from coverage.

Communication Services. Defects, damages, or the failure of Products, Accessories or Software due to any communication service or signal you may subscribe to or use with the Products, Accessories or Software is excluded from coverage.

Software Embodied in Physical Media. No warranty is made that the software will meet your requirements or will work in combination with any hardware or software applications provided by third parties, that the operation of the software products will be uninterrupted or error free, or that all defects in the software products will be corrected.

Software NOT Embodied in Physical Media. Software that is not embodied in physical media (e.g. software that is downloaded from the internet), is provided "as is" and without warranty.

Who is Covered

This warranty extends to the first end-user purchaser, only.

What will Motorola Do?

Motorola, at its option, will repair, or replace any Products, Accessories or Software that does not conform to this warranty. We may use functionally equivalent reconditioned/refurbished/pre-owned or new Products, Accessories or parts. No data, software, or applications added to your Product, Accessory or Software, including but not limited to personal contacts, games, and ringer tones, will be reinstalled. To avoid losing such data, software and applications please create a back up prior to requesting service.

How to Get Warranty Service or Other Information

In the USA, call

1-800-353-2729

TTY 1-888-390-6456

In Canada, call:

1-800-461-4575

TTY 1-888-390-6456

For accessories and software, please call the telephone number designated above for the product with which they are used. You will receive instructions on how to ship the Products, Accessories, or Software, at your expense, to a Motorola Authorized Repair Center. To obtain service, you must include: (a) a copy of your receipt, bill of sale or other comparable proof of purchase; (b) a written description of the problem; (c) the name of your service provider, if applicable; (d) the name and location of the installation facility (if applicable) and, most importantly; (e) your address and telephone number.

What Other Limitations Are There?

ANY IMPLIED WARRANTIES, INCLUDING WITHOUT LIMITATION THE IMPLIED WARRANTIES OF MERCHANTABILITY AND FITNESS FOR A PARTICULAR PURPOSE, SHALL BE LIMITED TO THE DURATION OF THIS LIMITED WARRANTY, OTHERWISE THE REPAIR, OR REPLACEMENT AS PROVIDED UNDER THIS EXPRESS LIMITED WARRANTY IS THE EXCLUSIVE REMEDY OF THE CONSUMER, AND IS PROVIDED IN LIEU OF ALL OTHER WARRANTIES, EXPRESS OF IMPLIED. IN NO EVENT SHALL MOTOROLA BE LIABLE, WHETHER IN CONTRACT OR TORT (INCLUDING NEGLIGENCE) FOR DAMAGES IN EXCESS OF THE PURCHASE PRICE OF THE PRODUCT, ACCESSORY OR SOFTWARE, OR FOR ANY INDIRECT, INCIDENTAL, SPECIAL OR CONSEQUENTIAL DAMAGES OF ANY KIND, OR LOSS OF REVENUE OR PROFITS, LOSS OF

BUSINESS, LOSS OF INFORMATION OR DATA, SOFTWARE OR APPLICATIONS OR OTHER FINANCIAL LOSS ARISING OUT OF OR IN CONNECTION WITH THE ABILITY OR INABILITY TO USE THE PRODUCTS, ACCESSORIES, OR SOFTWARE TO THE FULL EXTENT THESE DAMAGES MAY BE DISCLAIMED BY LAW.

Some states and jurisdictions do not allow the limitation or exclusion of incidental or consequential damages, or limitation on the length of an implied warranty, so the above limitations or exclusions may not apply to you. This warranty gives you specific legal rights, and you may also have other rights that vary from state to state or from one jurisdiction to another.

Laws in the United States and other countries preserve for Motorola certain exclusive rights for copyrighted Motorola software such as the exclusive rights to reproduce and distribute copies of the Motorola software. Motorola software may only be copied into, used in, and redistributed with, the Products associated with such Motorola software. No other use, including without limitation disassembly of such Motorola software or exercise of the exclusive rights reserved for Motorola, is permitted.



Connected System Phone
Digital 5.8 GHz Expandable

Model Family: SD7561

525833-001
01/06

Free Manuals Download Website

<http://myh66.com>

<http://usermanuals.us>

<http://www.somanuals.com>

<http://www.4manuals.cc>

<http://www.manual-lib.com>

<http://www.404manual.com>

<http://www.luxmanual.com>

<http://aubethermostatmanual.com>

Golf course search by state

<http://golfingnear.com>

Email search by domain

<http://emailbydomain.com>

Auto manuals search

<http://auto.somanuals.com>

TV manuals search

<http://tv.somanuals.com>