



MOTOROLA
intelligence everywhere™

Commercial Series

CM360

User Guide

6866545D06 - O

Issue: October 2003

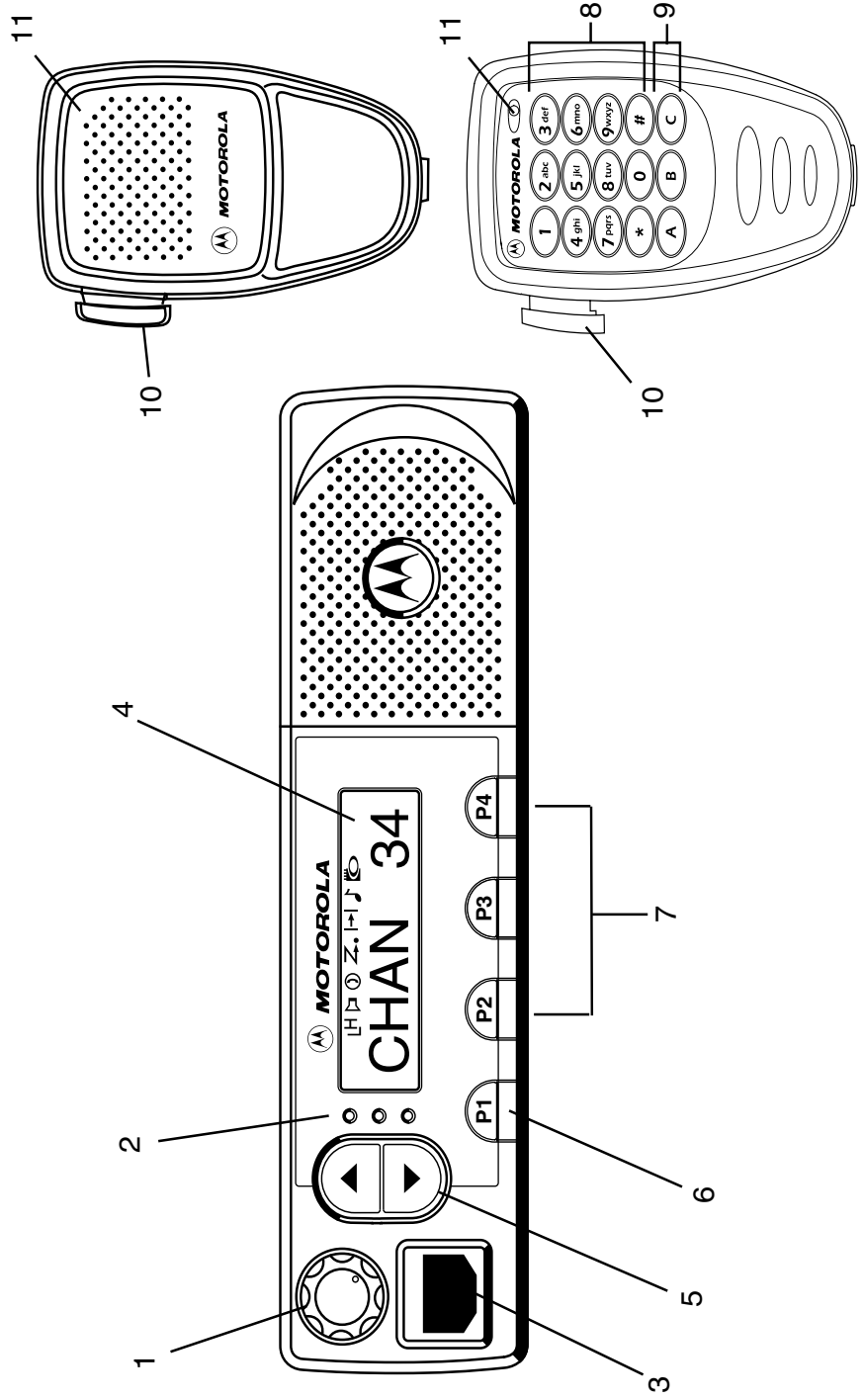

CONTENTS

Radio Overview	3
Radio Controls	3
Microphone Controls	3
Programmable Buttons	4
Keypad Keys	7
Menu Keys	8
Menu Navigation Chart	9
LCD Display and Icons	10
Audio Signal Tones	11
LED Indicators	12
Getting Started	13
Turning the Radio On-Off	13
Adjusting the Radio's Volume	13
Radio On Message	13
Selecting a Radio Channel	14
Memory Channel	15
Sending a Call	15
Receiving a Call	16
Cancelling a Call	16
Ending a Call	16

Radio Calls	17
Selective Calls	17
Making a Selective Call	17
Receiving a Selective Call	17
Contact List	18
Missed Calls	24
Status Calls	26
Sending a Status Call	30
Receiving a Status Call	30
Emergency Calls	31
DTMF	32
Features	35
Voice Storage	35
Voice Recorder	35
Emergency Message	37
Public Address Mode	38
Car Radio Mute	38
Utilities	39
Scan	39
Call Forward	42
Talkaround	43
External Alarm	44
Lone Worker	45
Power Level	46

Companding	47
Backlight	48
Brightness	49
Local/Distance	50
Option Board	51
Voice Operated Transmit (VOX)	52
Stun/Unstun	52
Radio Information	53

Computer Software Copyright

The products described in this manual may include copyrighted computer programmes stored in semiconductor memories or other media. Laws in the United States of America and other countries preserve for Motorola Europe and Motorola Inc. certain exclusive rights for copyrighted computer programmes, including the right to copy or reproduce in any form the copyrighted computer programme. Accordingly, any copyrighted computer programmes contained in the products described in this manual may not be copied or reproduced in any manner without the express written permission of the holders of the rights. Furthermore, the purchase of these products shall not be deemed to grant either directly or by implication, estoppel, or otherwise, any licence under the copyrights, patents, or patent applications of the holders of the rights, except for the normal non-exclusive royalty free licence to use that arises by operation of the law in the sale of the product.

RADIO OVERVIEW

This user guide covers the operation of the CM360 Mobile Radio.



Caution

Before using this product, read the operating instructions for safe usage contained in the Product Safety and RF Exposure booklet 6866537D37_ enclosed with your radio.



ATTENTION!

This radio is restricted to occupational use only to satisfy ICNIRP RF energy exposure requirements. Before using this product, read the RF energy awareness information and operating instructions in the Product Safety and RF Exposure booklet (Motorola Publication part number 6866537D37_) to ensure compliance with RF energy exposure limits.

RADIO CONTROLS

The numbers below refer to the illustrations on the inside front cover.

- 1. On-Off / Volume Knob**
Used to turn the radio on or off, and to adjust the radio's volume.
- 2. LED Indicators**
Indicates channel, scan, and monitor status, as well as receipt of a selective call.
- 3. Mic Jack**

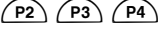
- 4. LCD Display**
An 8 character single line display with up to 8 radio status icons.
- 5. Navigation up or down**
Used for channel scrolling, menu navigation or, in menu mode, used for scrolling Address or Status lists. 
- 6. Menu Button** 
Used to access and select the menu options.
- 7. Programmable Buttons** 
Dual function programmable buttons. Short press selects function 1; long press selects function 2.

MICROPHONE CONTROLS

(Keypad Microphone)

Hold the microphone 2.5 to 5 cm (1-2 inches) from your mouth, and speak clearly into it.

- 8. Keypad**
- 9. Programmable Keys** 
- 10. Push-to-talk (PTT)**
Press and hold down this button to talk; release it to listen.
- 11. Microphone**

PROGRAMMABLE BUTTONS

Several of your radios keys and buttons can be programmed, by Customer Programming Software (CPS), as short -cut buttons for many of the radio's features. Programmable buttons include:

CM360   

Keypad microphone   

Each button is dual function; a short press may select one function, a long press may select the second.

Check with your dealer for a complete list of the functions your radio supports.

Feature	Description	Selection
Monitor 1/Cancel	Monitor 1 allows you to select between signalling squelch, carrier squelch and unsquelch, and to suspend scan when landed on a channel in scan mode. Cancel allows you to cancel an incoming or outgoing call.	Short or Long
Monitor 2/Cancel	Monitor 2 opens squelch regardless of signalling or carrier present. Cancel allows you to cancel an incoming or outgoing call.	Long
Call 1, 2, 3 and 4	Allows you to transmit assigned calls. Two calls may be allocated to one button, using the short/long press for selection.	Short or Long
Missed Calls List	Provides direct access to the Missed Call List feature.	Short or Long
Contact List	Provides direct access to the Contact List menu feature and direct keypad entry if programmed to a microphone button. The up/down keys scroll the list.	Short or Long
Contact Multicall	Provides direct access to the Contact Multicall menu feature. (Not available on the keypad microphone).	Short or Long
Status List	Provides direct access to the Status List menu feature and direct keypad entry if programmed to a microphone button. The up/down keys scroll the list.	Short or Long

Feature	Description	Selection
Status Multicall	Provides direct access to the Status Multicall menu feature. (Not available on the keypad microphone).	Short or Long
Channel	Provides direct access into the Channel mode. The up/down keys are set to increment/decrement the channel number in Menu mode.	Short or Long
Memory Channel (1 & 2)	Provides direct channel access on a single button press.	Short or Long
Store Memory Channel (1 & 2)	Programs a button to provide direct channel access.	Long
Scan (On/Off)	Toggles between start and stop of the scan operation.	Short or Long
Nuisance Delete/Cancel (Voice Storage)	To delete a nuisance (unwanted) channel when scanning, with exception of priority channel, last channel in scan list and home channel. Cancel, deletes messages being played back from the Voice Storage feature.	Short or Long
Nuisance Delete	To delete a nuisance (unwanted) channel when scanning, with exception of priority channel, last channel in scan list and home channel.	Short or Long
Cancel (Voice Storage)	Cancel, deletes messages being played back from the Voice Storage feature.	Short or Long
Record/Play-back (Voice Recorder)	To record/play-back incoming calls, emergency messages or memos using voice recorder feature.	Short or Long
Emergency	Activates emergency alarm sequence. A pre-recorded message (using the voice storage feature) may be sent to enable the user's location or status to be determined.	Long: On Off: depending on Programme

Feature	Description	Selection
Lone Worker (On/Off)	To identify user as a lone worker. Radio enters emergency sequence unless user responds, when prompted, by pressing any radio button.	Short or Long
Power Level (Hi/Low)	Toggles the radio's transmit power level between High and Low.	Short or Long
Talkaround (On/Off)	Sets the transmit channel frequency to the same as the receive channel frequency to talk directly with another radio without going through a system or dispatcher.	Short or Long
Call Forward (On/Off)	Transfers calls automatically to another radio if you are unable to take the call.	Short or Long
Xpand (On/Off)	Toggles between compression/expansion of audio signal and normal audio signal.	Short or Long
Option Board (On/Off)	Toggles the option board between on and off.	Short or Long
DTMF Keypad (On/Off)	To place the keypad microphone into permanent DTMF live dial mode.	Short or Long
External Alarm (On/Off)	Toggles the External Alarm feature on and off. Note: May be programmed as permanently On.	Short or Long
Backlight (On/Off)	Toggles the display backlight between On and Off or between "timed On" and Off.	Short or Long
Basestation/Local/Distance	Toggles between local and distance. Local reduces interference from other radios in close proximity and is used for basestations. Distance improves the radio range.	Short or Long

KEYPAD KEYS

(Keypad Microphone)

1	2 abc	3 def
4 ghi	5 jkl	6 mno
7 pqrs	8 tuv	9 wxyz
*	0	#
A	B	C

Your radio may be operated with a DTMF (Dual-Tone Multi-Frequency) microphone that has a direct entry keypad. The keypad is used when dialling a phone number, making a radio call, or for numeric channel selection.

The keypad microphone has three programmable buttons (A, B, and C) below the keypad that can be programmed to conveniently activate selected radio features. Each button is dual function; a short press may select one function, a long press may select the second.

The # button can be programmed to send a call.

MENU KEYS

Menu Select Key

The  button is dedicated to Menu access and menu option selections.

- **Short press** 

Used to enter the Menu Mode. When in Menu Mode, this key is also used to make menu selections.
- **Long press** 

Normally used to move up to the next higher Menu level. When the top level menu is selected, this key is used to exit the Menu Mode.
- However when in the bottom level menu (e.g. contact list, status multical entry), this key selects the entry.
- The radio also exits the Menu Mode after an “Inactivity Time” timeout

Up /Down Navigation Keys

Used to scroll when in Menu Mode. Increment/decrement channel number or scroll contact and status lists.

Refer to the menu navigation chart for menu selectable features.

Using the Menu

You enter the menu at the “Missed Calls” feature only if there are missed calls in the stack. If there are no missed calls in the stack, the menu is entered at the “Contact List” feature.

Use the Up/Down navigation keys to scroll through the menu options. If you scroll past the end option the selection wraps around and starts again.

When you reach the required option, a short press on the  button selects that option and enters the Sub-menu.

Use the Up/Down Navigation keys to scroll through the sub-menu options and select the option with a short press on the  button.

Exiting the Menu

You may exit the menu by a long press on  from the top level of the menu hierarchy.

The radio also exits the menus if there has been no inputs via the navigation buttons for the “Inactivity Time” or after a selection has been made.

MENU NAVIGATION CHART

(Refer to Menu Navigation guidelines—
lower, left-hand corner of this page)

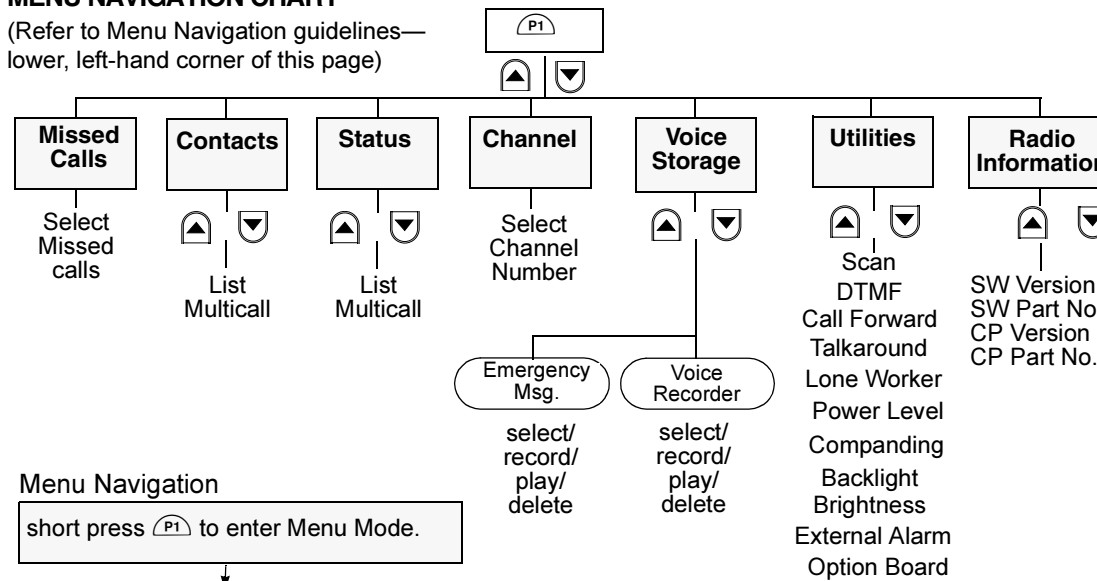

Menu Navigation

short press **P1** to enter Menu Mode.

▲ or ▼ to scroll through the Menu options.

short press **P1** to select Menu option

long press **P1** return to previous menu level

▲ or ▼ to scroll through the Menu sub-list.

long press **P1** to select bottom level menu entry and return to default display.

RADIO OVERVIEW

LCD DISPLAY AND ICONS

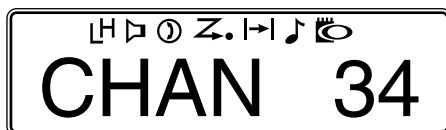

Displays radio Status, Addresses or Channel, on one line of 8 characters. The top line of the display shows radio status icons, explained in the table below:

Symbol	Name and Description
	Option Board Indicator Indicates that an option board is fitted in the radio.
	Voice Recorder Indicator Flashes to indicate that there are stored messages or memos in the voice recorder.
L H	Power Level Indicator “L” lights when your radio is configured to transmit in Low Power. “H” lights when your radio is configured to transmit in High Power.

Symbol	Name and Description
	Monitor Indicator On indicates carrier squelch. Off indicates signalling squelch.
	Scan Indicator Indicates that you are scanning. The dot is lit during priority scan mode when scan has landed on priority channel.
	DTMF Indicator Indicates DTMF is enabled.
	Missed Call Indicator On indicates call in list. Off indicates no calls in list. Flashing, indicates new call in list.
	Talkaround Indicator Indicates talkaround enabled.





Note: At extremely low temperatures, you may experience a slight delay in displaying new information. This is normal and does not affect the function of your radio.

AUDIO SIGNAL TONES

High pitched tone Low pitched tone

Tone	Signal	Description
Power up OK		Radio self-test OK.
Power up Fail		Radio self-test fail.
Button/ Keypad Error		Button/keypad key/ menu key press not permitted.
Engaged		Channel busy or not permitted to transmit.
Call Failed		Call failed to connect.
Force Monitor		Radio must monitor channel before transmission permitted.
Button Feature Enable		Any option button pressed to enable a feature.
Button Feature Disable		Any option button pressed to disable a feature.
Group Call		Radio receives a Group Call.

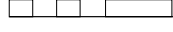
Tone	Signal	Description
Individual Call		Radio receives an Individual Call.
Call Reminder		Reminder of unanswered call.
TOT Pre-Alert		Warns of expiry of time out timer.
Monitor Alert		Alerts to change of squelch.
Voice Storage		Voice Storage-Recording.
Voice Storage		Voice Storage-Warning.
Voice Storage		Voice Storage-Full.
Scan Start		Radio starts scanning.
Scan Stop		Radio stops scanning.
Priority Call Decode		Radio detects a priority call.
Priority Channel		Radio landed on the priority channel.
Lone Worker		Reminds lone worker to respond.

Tone	Signal	Description
Hardware Error		Hardware error, tone continues until valid operation.
Cancel Message		Previous message or message currently being played from Voice Storage has been deleted.
Channel Free Beep		Indicates current channel is free.
Incoming Emergency Alert		Indicates an emergency situation.
Keypad Acknowledge		Confidence tone when any key pressed.
Call Stacked		Indicates that call has been stacked. Sounded on calling radio.
Ringtones	English/French/General	Incoming calls (high tones), outgoing calls (low tones).

LED INDICATORS

Three LEDs show radio status as follows:

LED	State	Indication
Green	Solid	Successful power up
Green	Off	After successful power up.
Green	Flashing	Radio is scanning
Red	Solid	Radio transmitting
Red	Flashing	Channel busy - when receiving
Yellow	Solid	Radio selectively called - until answer timer expires
Yellow	Flashing	Group call reminder - after answer timer expires
Yellow	Double Flash	Individual call reminder - after answer timer expires

GETTING STARTED

TURNING THE RADIO ON / OFF

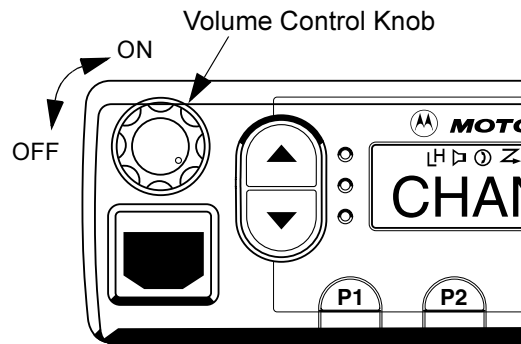

ON	OFF
Rotate the On/Off/Volume Control knob clockwise until you hear a click.	Rotate the On/Off/Volume Control knob counterclockwise until you hear a click. The display clears and the LED indicators turn off .

Adjusting the Volume

Turn the **On/Off/Volume Control** knob clockwise to increase the volume, or counterclockwise to decrease the volume.

Radio On Message

At power up the radio may display a message customised by your dealer, e.g.:

RADIO ON

After this text has been displayed, the radio performs a self test routine. During the routine the Green LED lights. On completion of a successful self test the radio produces the Self-Test pass Tone, the Green LED indicator goes out and the display shows the screen that was in use at power down, typically:

CHAN 35

This may be a number or an alias and will be the current channel.

Note: If your radio fails the self test routine the display will show the failure number. Record the number and consult your dealer



SELECTING A RADIO CHANNEL

Your radio offers up to 100 channels, however some may not be programmed. Check with your dealer for more information.

Your radio will power up on a preprogrammed designated channel or the channel that it was on when it was powered down.

Change Channels

Method 1

- 1 In the idle state use  or  to change channel e.g.:



CHAN 34

Method 2.0 (Keypad Microphone)

If the default mode for the keypad microphone is **Channel** entry then:

- 1 Enter the desired channel number from the keypad, e.g. 05:

CHAN 5

- 2 Either Long press on  or press  on the keypad (if programmed) to select the channel.

CHAN 5

- 3 Display shows: (for 2 seconds)

SELECTED

- 4 Display shows channel selected

CHAN 5

Method 2.1 (Keypad Microphone)



If the default mode for the keypad microphone is not channel entry, then enter the channel mode.

Method 2.2

Press the channel mode direct access button, if programmed by your dealer. Enter and select the channel number according to Method 2.0

Method 2.3 :

- 1 Short press on  To enter Menu

- 2  or  until:

CHANNEL

- 3 Short press on  To select

- 4 Display shows e.g.:

CHAN 11

- 5 Enter and select the channel number according to **Method 2.0**

Note: The keypad microphone cannot be used to enter the channel number during a call or whilst the radio is in a scan.

MEMORY CHANNEL

Up to two programmable buttons (P2, P3 or P4) can be programmed as Memory Channel buttons which allow you quick access to frequently used channels. The buttons may be pre-programmed by your dealer or are programmable by yourself.

If pre-programmed by your dealer, an appropriate press of the button will take you to the assigned channel.

To program a Memory Channel button yourself, select the desired channel in the normal way and long press the button. The button is then programmed to the selected channel; a short press on the button will take you to that channel.

Note: The programming is retained when you turn off the radio.

SENDING A CALL

1. Select the desired radio channel.
2. Press the **PTT** button and speak clearly into the microphone. Your mouth should be 2.5 to 5 cm away from the microphone.
3. When transmitting, the red indicator will light continuously.
4. Release the **PTT** button to listen.

Your radio may be configured for 'Transmit Inhibit' under certain conditions (e.g. when the channel is in use by others) in which case, the channel busy tone will sound when you press the PTT or call button to indicate that transmission is inhibited.

When the channel is free, the Channel Free beep will sound, and you can make a call.

If your radio is equipped with a transmit time out timer (TOT), a warning tone will sound a few seconds before the transmission is cut off. Your radio may be programmed to inhibit retransmission within a preset time.

RECEIVING A CALL

1. Turn your radio on and adjust the volume level.
2. Switch to the desired radio channel.
3. If, at any time, a call is received you will hear the call at the volume level you have set.

Note: The system may have a limited call time and the call may be terminated automatically if this call time is exceeded.

CANCELLING A CALL

At any time while setting up a call, it may be cancelled by pressing the Monitor/Call Cancel button, or replacing the microphone in its holder (referred to as going "on hook") .
The call timer can also cancel a call.

ENDING A CALL

A call should always be ended by pressing the Monitor/Call Cancel button, or replacing the microphone in its holder.

RADIO CALLS

SELECTIVE CALLS

Making a Selective Call

You can make a selective call to a particular radio, known as an individual call, or a group of radios, known as a group call.

You can make calls by using the **Contact List**, the **Missed Calls List** or **Manual Dialling** (using the keypad microphone).

Receiving a Selective Call

When you receive a selective call, you will hear either,
an individual call alert tone ,

or a group call alert tone .

The LED Indicator will light (yellow) and the display will show the alias (name) or number (address) of the calling radio e.g.

Alias	<input type="text" value="DEREK"/>
or Address	<input type="text" value="2345"/>

To answer the call:

1. Press the PTT button or Call button.
2. The call will terminate automatically when the conversation has ended or press the Monitor/ Call Cancel button.

CONTACT LIST

When the radio is in the “idle” state or during a call, the contact list may be used to access up to 255 preprogrammed numbers via the menu. Depending on the way your radio is programmed, the radio will display either the alpha alias (name) or the number to be dialled.

The Contacts menu has two sub-menus:

List : which accesses the list of preprogrammed names and numbers;

Multicall : which allows any address digits to be entered.









Note: There are two forms of Multicall, **Basic Multicall**, where the user selects the person or number to be called, and **Advanced Multicall**, where the user first selects the telegram to be sent and then selects the person or number to be called.

There are two methods to enter the Contacts menu:

Method 1





Press the Contact List or Contact Multicall direct access button, if programmed by your dealer.

Method 2

- 1 Short press on  to enter the menu
- 2  or  until: 
- 3 Short press on  to select
- 4  or  to toggle  between
- and 
- 5 Short press on  to select

List

On selection of Contact List

- 1  or  until required entry is displayed 
- 2 Short press on  

Once the desired address is displayed, there are two methods to select the address:

Method 1

- 1 Long press on  To confirm selection
- 2 Display shows: (for 2 seconds) 

Method 2











Press the PTT button or Call 1-4 to select address and make the call.

Call1-4 are pre-programmed call buttons.

Note: During a call you may enter the contact list as described above and make another call to a third party, or initiate a new call. In either case the call may be a voice or status call.

Basic Multicall

On selection of Contact **Multicall** , the last selected address will appear on the display.

- 1 the left most digit will flash. 12345
- 2  or  to edit the first digit to the required number. 42345
- 3 Short press on  to move the flashing edit digit to the right. 42345
- 4  or  to edit the second digit to the required number. 47345
- 5 Short press on  to move the flashing edit digit to the right. 47345
- 6 Continue using the  or  and  until the right most digit is edited. 47147
- 7 Short press on  returns the edit digit from the right most digit to the first digit. The number can be corrected if required 47147

Once the desired address is displayed, there are two methods to select the address:

Method 1



- 1 Long press on  To confirm selection
- 2 Display shows: SELECTED
(for 2 seconds)

Method 2

Press the PTT button or Call 1-4 to select address and make the call.
Call 1-4 are pre-programmed call buttons.

Keypad Edit (keypad microphone only)

The direct access button from the keypad microphone takes you to the List option only. The last person called from the list is displayed. Note that the last multicall or keypad entry is not shown.

- 1 Press Mic (A), (B) or (C) whichever is programmed as Contact list /keypad entry.
 - 2 The last selected list entry is displayed e.g. JOHN
 - 3 Either  or  until required entry e.g.. PHIL
- or Enter address digits directly on microphone keypad e.g. 5234

Note: If you enter an incorrect address, you must exit the menu (either by selecting the present entry or allowing the menu to time out), then re-enter the contact list via the programmed button on the keypad microphone.

Once the desired name or address is displayed, there are three methods to select the entry :

- Method 1**
- 1 Long press on  To confirm selection
 - 2 Display shows: (for 2 seconds) SELECTED









- Method 2**
- 1 Press  on the keypad (if programmed) To confirm selection
 - 2 Display shows: (for 2 seconds) SELECTED





Method 3
 Press the PTT button or Call 1-4 to select address and make the call.
 Call1-4 are pre-programmed call buttons.

Advanced Multicall

Advanced Multicall users must first select the telegram to be sent, then enter the address digits into the telegram.

Enter the Contacts Multicall either via the menu, or a button programmed for direct access.

- 1 The telegram digit is displayed TEL 1
- 2  or  to select the telegram to be used (1 to 9): TEL 3
- 3 Short press on  changes the display to show address digits, and the left most digit flashes for editing 12345
- 4  or  to edit the first digit to the required number. 42345
- 5 Short press on  to move the flashing edit digit to the right. 42345
- 6  or  to edit the second digit to the required number. 47345

- 7 Short press on  to move the flashing edit digit to the right. 47345
- 8 Continue using the  or  and  until the right most digit is edited. 47247
- 9 Short press on  returns to the telegram to edit if required. TEL 3

Once the desired telegram and address are entered, there are two methods to select them:

Method 1

- 1 Long press on  To confirm selection
- 2 Display shows: SELECTED
(for 2 seconds)

Method 2

Press Call 1-4 to select the telegram and address and make the call.

Call1-4 are pre-programmed call buttons, and must be programmed to send an *advanced multicall* call.

Keypad Edit (keypad microphone only)

The direct access button from the keypad microphone takes you to the List option only.

- 1 Press Mic **A**, **B** or **C** whichever is programmed as Contact list /keypad entry.
- 2 The last selected list entry is displayed e.g. **JOHN**
- 3 Enter the desired telegram number (1 to 9) (TEL 3 is not displayed until the number is entered) **TEL 3**
- 4 Enter the desired address digits directly on microphone keypad e.g. **526**

Note: If you enter an incorrect telegram or address, you must exit the menu (either by selecting the present entry or allowing the menu to time out), then re-enter the contact list via the programmed button on the keypad microphone.

Once the desired telegram and address are entered, there are two methods to select them:

Method 1

- 1 Long press on **P1** To confirm selection
- 2 Display shows: **SELECTED**

Method 2

Press Call 1-4 or # to select the telegram and address and make the call.
Call1-4 are pre-programmed call buttons. Call1-4 and # must be programmed to send an *advanced multical* call.

MISSED CALLS

If a call remains unanswered, the call will be stored by your radio, provided that Missed Calls has been programmed into your radio.

Up to ten calls can be stored. If the same radio calls more than once, the most recent call is stored.

When ten calls have been stored, depending on the radio programming, the eleventh call received may overwrite the first or not be stored by the radio.

When a new call has been stored by the radio, the Missed Call icon  will flash and the display will show the alias (name) or number (address) of the last calling radio e.g.





· 526

When the Missed Calls list has been read and any missed calls retained, the Missed Call icon is illuminated.

The Missed Call List can be entered directly by pressing the Missed Call button (if programmed) when the radio is in the “idle” state or via the menu.

If using the Missed Call button, follow the procedures from step 3 below.

To view the calls in the list via the menu

- | | | |
|---|--|--|
| 1 | Short press on  | MISSED C |
| 2 | Short press on  shows first call in list | ALIASXXX |
| 3 |  or  until required call found | ALIASYYY |
| 4 | Long press on  or press a call button or # to send the call | ALIASYYY |
| 5 | Radio returns to default display | CHAN 1 |

Note 1. The address of the called radio is stored and therefore, if there is no reply, it can be called again later by pressing the call or # button, provided that no other calls are made in the meantime.







Note 2. If a message in the Missed Calls list has an associated status message, the caller's alias /number will contain an S suffix

JOHN

After 2 seconds the display will change to show the status alias/number

FREE

On a successful call set-up, the entry is automatically deleted from the Missed Calls list. Unanswered calls may be deleted from the Missed Calls list at any time by :

- 1 Short press on  MISSED C
- 2 Short press on  shows first call in list ALIASXXX
- 3  or  until required call found ALIASYYY
- 4 Short press on  displays prompt DELETE?
- 5 Long press on  confirms deletion
Short press on  returns to step 1 DELETED
- 6 After deleting the call, the display returns to the 'idle' display. CHAN XX

Note: The calls in the list are not deleted when the radio is turned off.

STATUS CALLS

A status is a code for transmitting prearranged messages, e.g. status "05" may indicate "Return to Base". The prearranged messages and associated code digits are contained in a Status List which contains up to 255 entries. This list is used for both incoming calls, when the status of the calling radio is displayed, and outgoing calls, when your status is sent either to a requesting radio or to other radios.

The Status menu has two sub-menus:

List : which accesses the list of preprogrammed names and numbers;







Multicall : which allows any status digits to be entered.

There are two methods to enter the Status menu:

Method 1





Press the Status List or Status Multicall direct access button, if programmed by your dealer.

Method 2

- 1 Short press on  to enter the menu
 - 2  or  until:
 - 3 Short press on  to select
 - 4  or  to toggle between
 - and*
 - 5 Short press on  to select
-

List

On selection of Status List

- 1  or  until required entry is displayed 
- 2 Short press on  

Once the desired address is displayed, there are two methods to select the address:

Method 1

- 1 Long press on  To confirm selection
- 2 Display shows: (for 2 seconds) 

Method 2











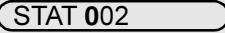

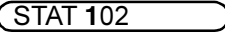

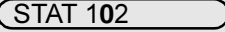
Press the PTT button or Call 1-4 to select address and make the call.

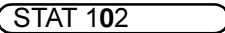
Call 1-4 are pre-programmed call buttons.

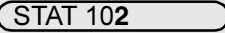
Note: During a call you may enter the status list as described above and make another call to a third party, or initiate a new call. In either case the call may be a voice or status call.

Multicall

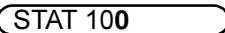
On selection of Status **Multicall**, the last selected status will appear on the display, .

- 1 the left most digit will flash. 
- 2  or  to edit the first digit to the required number. 
- 3 Short press on  to move the flashing edit digit to the right. 
- 4  or  to edit the second digit to the required number. 
- 5 Short press on  to move the flashing edit digit to the right. 
- 6 Continue using the  or  and  until the right most digit is edited. 
- 7 Short press on  returns the edit digit from the right most digit to the first digit. The number can be corrected if required. 

Once the desired address is displayed, there are two methods to select the address:

Method 1

- 1 Long press on  To confirm selection
- 2 Display shows:  (for 2 seconds)



Method 2

Press the PTT button or Call 1-4 to select address and make the call.

Call1-4 are pre-programmed call buttons.

Keypad Edit (keypad microphone only)

The direct access button from the keypad microphone takes you to the List option only. The last status sent from the list is displayed. Note that the last multical or keypad entry is not shown.

- 1 Press Mic (A), (B) or (C) whichever is programmed as Status list /keypad entry.
 - 2 The last selected list entry is displayed e.g. STAT 01
 - 3 Either  or  until required entry e.g.. STAT 03
- or Enter status digits directly on microphone keypad e.g. 5234

Note: If you enter an incorrect status, you must exit the menu (either by selecting the present entry or allowing the menu to time out), then re-enter the status list via the programmed button on the keypad microphone.

Once the desired status is displayed, there are three methods to select the entry :

Method 1

- 1 Long press on  To confirm selection
- 2 Display shows: SELECTED

Method 2

- 1 Press  on the keypad (if programmed) To confirm selection
- 2 Display shows: SELECTED

Method 3

Press the PTT button or Call 1-4 to select status and make the call.
Call1-4 are pre-programmed call buttons.

Sending a Status Call

To send status message to another radio, select radio Alias/ID from Contact List via menu and send as detailed.

Note: During a call you may enter the status list as described above and make another status call to a third party or initiate a new status call.



Receiving a Status Call

Your radio receives a Status Call when:

- 1 Individual Call alert sounds
- 2 Display shows: **ON BREAK**
or
STAT 4
alternating with
Alias/Number

Where Status message "04" / "On Break" is an example status message. Note that status number (04) only, will be displayed if the associated message is not programmed into your radio. Alias/Number is the name or number of the calling radio.

EMERGENCY CALL



Your radio can be programmed (buttons   and ) to give you a one-button quick access to call a particular radio or centre (predefined by your dealer) in emergency situations. This is the *Emergency Call*. The call can only be programmed to operate with a long press.

When you make an Emergency call, your radio goes into an Emergency state, which can be programmed to:

- continually receive speech,
 - the radio can receive and transmit.
1. Use a long press on the **Emergency** button to initiate the Emergency call.
 2. Emergency can be stopped by:
 - switching the radio **Off** and **On** again.
 - a **reset** message received by your radio.
 - the emergency time duration is reached.

Note: The emergency time duration and reset message are programmed into your radio by your dealer.

You may pre-record a message (for example to confirm your location or status), which is sent automatically when the emergency call is activated. Refer to Voice Storage to use this feature.

Should you receive an Emergency call the incoming emergency alert tone    will sound.

DTMF

(Keypad Microphone only)

DTMF means Dual Tone Multi Frequency and is used when the radio is required to operate in a radio system with an interface to telephone systems.

There are two methods of accessing DTMF Live Dial Mode, either Automatic or Manual:

Automatic method

To do this, your radio must send a telephone interconnect to a station that connects you to a phone line. After you have finished your call, the radio sends a clear down call (if programmed) to shutdown the connection to the phone line.

Sending the Telephone Interconnect Call

Your radio can be programmed to send the interconnect call in one of the following ways:

- automatically - when a call button (Call 1 - 4 or PTT) has been programmed with the interconnect call, or a contact list entry has been programmed for DTMF access.
- manually - when you dial the code using the keypad microphone.

If in doubt, please contact your dealer or network manager for further information.

To initiate a DTMF call with Automatic Telephone Interconnect Call

- 1 Press dedicated Call Button (Call 1-4 or PTT), you will hear a tone sequence.

Display icon lit: 

- 2 Wait for call to be set up when you will hear a dial tone.

Display shows: 

- 3 Enter desired phone number on the keypad microphone, taking care not to press the PTT. Note: Each DTMF digit is transmitted instantly.

Display shows entered digits: 

- 4 Once the radio has connected to the called number, you can begin the conversation. Even though this is a phone call, your conversation mimics a radio call, that means that both parties speak in turn, i.e. press the PTT to talk, release to listen.

- 5 To end the call press the Monitor Button or change channel when the clear down call is sent automatically from your radio to shutdown the phone line.

To initiate a DTMF call with Manually Dialed Telephone Interconnect Call

- 1 Enter the interconnect call from the keypad microphone, you will hear a tone sequence.
Display shows e.g. 122
- 2 Press dedicated Call Button (PTT or Call 1-4)
Display icon lit: ①
- 3 Wait for call set up and you hear a dial tone.
Display shows: ENTER
- 4 Enter desired phone number, taking care not to press the PTT.
Note: Each DTMF digit is transmitted instantly.
Display shows e.g. 8116
- 5 Once the radio has connected to the called number, you can begin the conversation. Even though this is a phone call, your conversation mimics a radio call, and both parties speak in turn, i.e. press PTT to talk, release to listen.
- 6 To end the call press the Monitor Button or change channel. The clear down call is sent automatically from your radio to shutdown the phone line.

Note: The radio starts a programmable timer the moment both parties stop transmitting (talking). If the time-out timer expires, the radio will end the phone call.

Permanent DTMF Mode

Press the pre-programmed DTMF button once, to put the keypad microphone into permanent DTMF live dial mode. Press the DTMF button again to disable the DTMF live dial. The radio then returns to the IDLE STATE and select calls can be made.

Alternatively, use the DTMF menu option to enable or disable permanent DTMF Mode.

Note: Permanent DTMF mode is not available in scan or during a call.

Using the DTMF Button











1. Press the **DTMF** button to switch **on** permanent DTMF Mode when the feature enable alert will sound, the display icon ① is lit and the display will show:

DTMF ON

2. Press the **DTMF** button again to switch **off** permanent DTMF Mode when the feature disable alert will sound, the display icon ① is extinguished and the display will show:

DTMF OFF

Using the Menu

- 1 Ensure radio is in IDLE STATE.
- 2 Short press on  to enter menu
- 3  or  until
- 4 Short press on  to select
- 5  or  until:
- 6 Short press on  to show current status.
- 7  or  toggles on/off
- 8 Long press on  to select
- 9 Display shows: (for 2 seconds)
- 10 Radio exits menu mode and display shows e.g.:

To initiate a DTMF call in permanent live-dial.

- 1 Enter the interconnect call from the keypad microphone, you will hear a tone sequence.
Display shows e.g.
- 2 Wait for call to be set up when you will hear a dial tone.
Display shows:
- 3 Enter desired phone number, taking care not to press the PTT.
Note: Each DTMF digit is transmitted instantly.
Display shows entered digits:
- 4 Once the radio has connected to the called number, you can begin the conversation. Even though this is a phone call, your conversation mimics a radio call, that means that both parties speak in turn, i.e. press the PTT to talk, release to listen.
- 5 To end the call press the Monitor Button or change channel when the clear down call is sent automatically from your radio to shutdown the phone line.

FEATURES











VOICE STORAGE

Voice storage allows you to perform various voice related tasks which include voice recorder and an emergency message feature.

Voice Recorder

You can record and playback incoming calls or make a memo using the voice recorder feature, which allows up to 2 minutes of recording.

To enter the radio into the **Voice Recorder** mode, using the menu:

- 1 Ensure radio is in IDLE STATE.
- 2 Short press on  to enter menu
- 3  or  until 
- 4 Short press on  to select
- 5  or  until: 
- 6 Long press on  to select.
- 7 Display shows: (for 2 seconds) 

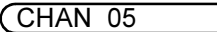
- 8 Radio exits menu mode and display shows e.g.: 

If at **step 7**, a previous message is stored, it must be deleted prior to proceeding.

Display shows: (for 2 seconds) 

Long press on  to delete message(s).

Display shows: (for 2 seconds) 

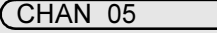
Radio exits menu mode and display shows e.g.: 

Repeat steps 1 to 7 above to select desired voice storage mode.

Once in **Voice Recorder** mode, an incoming call or memo can be recorded at any time by:

- 1 Press and hold the **Voice Storage Record** button, the Voice Storage Recording alert sounds momentarily.

You will see:

RECORDER

- 2 *Either* Record the call or part of the call,
or Speak clearly into the microphone to record your memo

- 3 The Voice Storage Warning alert sounds when the memory is nearly full.

You will see:

STGE LOW

- 4 The Voice Storage Full alert sounds when the memory is full and recording ceases.

You will see:

STGE FULL

- 5 Release the **Voice Storage Record** button at any time to stop recording.

Subsequent messages can be stored by repeating steps 1 to 5 above.

To **playback** a recorded call or memo:

- 1 Ensure radio is in IDLE STATE
- 2 Press the **Voice Storage Play** button to playback the first recorded call or memo.

You will see:

PLAYING

- 3 Press the **Voice Storage Play** button again to skip to the next message to be played back.

To **delete** a recorded call or memo:

- 1 Playback message as described in above procedure.
- 2 Press the **Cancel (Voice Storage)** button to delete the message currently being played back.

Emergency Message

You can pre-record an emergency message to be sent automatically when the emergency call feature is activated. This message may contain, for example, your location or status which may prove useful to the recipient, especially if, in the emergency situation, you are unable to talk.

To **pre-record** an emergency message, using the menu :

- 1 Ensure radio is in IDLE STATE.
- 2 Short press on **P1** to enter menu
- 3 **▲** or **▼** until **VOX STOR**
- 4 Short press on **P1** to select
- 5 **▲** or **▼** until **EMERGENCY**
- 6 Long press on **P1** to select
- 7 Display shows: **SELECTED**
(for 2 seconds)
- 8 Press and hold the **Voice Storage Record** button, the Voice Storage Recording alert sounds momentarily.
You will see: **RECORDER**
- 9 Speak clearly into the radio microphone to record your message.

- 10 The Voice Storage Warning alert sounds when the memory is nearly full.
You will see: **STGE LOW**
 - 11 The Voice Storage Full alert sounds when the memory is full and recording ceases.
You will see: **STGE FULL**
 - 12 Release the **Voice Storage Record** button at any time to stop recording.
 - 13 Press the **Voice Storage Play** button to playback the emergency message.
You will see: **PLAYING**
- You can change the message at any time by repeating the above procedure.
-
- If at **step 7**, a previous message is stored, it must be deleted prior to proceeding.
- Display shows: **DEL MSGS**
(for 2 seconds)
- Long press on **P1** to delete message(s).
- Display shows: **DELETED**
(for 2 seconds)
- Radio exits menu mode and display shows e.g.: **CHAN 05**
-
- Repeat steps 1 to 7 above to select desired voice storage mode.

PUBLIC ADDRESS MODE

The Public Address mode allows you to use your radio audio as a public address system. You can use your radio microphone as normal and the audio is routed through the radio to an external loudspeaker fitted to your vehicle.

A switch, external to your radio, switches the audio from your radio to the external loudspeaker.

This feature is programmed and fitted by your dealer.

To access the Public Address system:

- 1 Turn external switch to the **PA** position.

Display shows:

PUB ADDR

- 2 Press microphone PTT and talk.
- 3 To exit PA mode, turn external switch to the **RADIO** position.

Note 1: While in PA mode you can still hear incoming radio calls as long as you **do not** press the PTT.

Note 2: You must exit PA mode in order to answer or make radio calls.

CAR RADIO MUTE

The Car Radio Mute feature automatically mutes your in-car audio entertainment system to allow you to hear incoming calls or to stop audio interference when you are making a call.

This feature may be programmed into your radio by your dealer.

UTILITIES

The utilities described below are programmed into your radio by your dealer and are accessible either via a programmable button or via the menu.

DTMF

DTMF means Dual Tone Multi Frequency and is used when the radio is required to operate in a radio system with an interface to telephone systems.

You can switch **On** or **Off** Permanent DTMF Mode by using a pre-programmed **DTMF** button or via the menu, please refer to "DTMF" on page 32.

Note: You must be using a keypad microphone to perform DTMF calls.

SCAN





You can monitor several channels in order to receive any call that is transmitted on any of these channels. Sixteen different channels can be programmed into each scan list. Each channel can share the same scan list or have different scan lists assigned to them.

Once the radio's scan operation is activated and the radio detects a call coming through a channel in its scan list, it switches to that channel for you to receive the call.













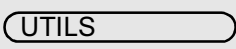

Starting or Stopping Scan

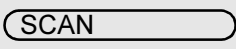
You can start or stop a scan operation by using a pre-programmed **Scan** button or via the menu, either when the radio is in the IDLE STATE or when in a call.

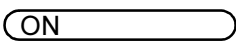
Using the Scan Button

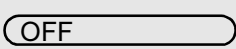

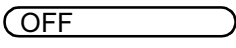
1. Press the **Scan** button to start scanning. The scan start alert tone  will sound and the display icon  will be lit.
2. Press the **Scan** button again to stop scanning. The scan stop alert tone  will sound and the display icon  is extinguished.

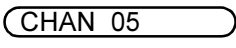
Using the Menu

- 1 Ensure radio is in IDLE STATE, or in a call.
- 2 Short press on  to enter menu
- 3  or  until 
- 4 Short press on  to select
- 5  or  until: 
- 6 Short press on  to show current status. 
- 7  or  toggles on/off 
- 8 Long press on  to select 
- 9 Display shows: (for 2 seconds) 
- 10 Radio exits menu mode and display shows e.g.: 

The scan start alert tone will sound, the display icon  will be lit and the LED indicator will blink green during a scan operation. When a call on a channel is detected the LED will stop blinking and the channel number will be displayed.

Priority Channel

A scan list may contain a priority channel. This means that a particular channel (for example, a commonly used channel) may be checked more frequently than other channels in the list during a scan operation. Priority channels are programmed into your radio scan lists by your dealer, however when a priority channel is included in a scan list, the scan icon changes from  to  when scan has landed on the priority channel.

Talkback

If the programmable Talkback option is set, you can respond to any calls received during the scan operation by pressing the PTT button before the programmed hang-time ends. Check with your dealer for details.

Deleting a Nuisance Channel

If a channel continually generates unwanted calls/noise (a “nuisance” channel), you can temporarily remove it from the scan list by performing a *Nuisance Channel Delete* operation:

1. While the radio is on the Nuisance Channel, press the **Nuisance Delete** button until you hear the scan start alert tone.



Note: You cannot perform a Nuisance Channel Delete on a priority channel or if there is only one remaining channel in the scan list.

Adding A Deleted Nuisance Channel Back Into The Scan List

Using the Scan Button

1. Press the **Scan** button to stop scanning. The scan stop alert tone will sound.
2. Press the **Scan** button again to re-start scanning. The scan start alert tone will sound, and the scan list will contain all programmed channels.

Using the Menu

1. Follow the instructions for selecting **Scan On/Off** via the menu
2. Select **Scan Off**. Your radio will stop scanning, the scan stop alert tone will sound, the display icon  and the LED indicator will be extinguished.
3. Select **Scan On**. Your radio will re-start scanning, the scan start alert tone will sound, the display icon  will be lit, the LED indicator will blink green and the scan list will contain all programmed channels.

CALL FORWARD

You can call forward calls to your radio to another radio if you are unable to take calls or are away from your radio.

You can switch Call Forward **On** or **Off** by using a pre-programmed **Call Forward** button or via the menu.

Using the Call Forward Button

















1. Press the **Call Forward** button to switch **on** Call Forward, when the feature enable alert will sound and the display will show:

FWD ON

2. Press the **Call Forward** button again to switch **off** Call Forward when the feature disable alert will sound and the display will show:

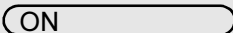
FWD OFF

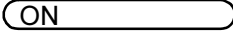
Using the Menu

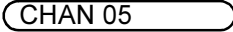
- 1 Ensure radio is in IDLE STATE.
- 2 Short press on  to enter menu
- 3  or  until 
- 4 Short press on  to select
- 5  or  until: 
- 6 Short press on  to show current status. 
- 7  or  toggles on/off 
- 8 Long press on  to select 
- 9 Display shows: (for 2 seconds) 
- 10 Radio exits menu mode and display shows e.g.: 

TALKAROUND

In your communications network, you may be using a system to cover a larger area than is possible with your radio. However, you can communicate with another radio within your radio's range without going through the system by using the Talkaround feature. This is especially useful when the system is down. You can switch Talkaround **On** or **Off** by using a pre-programmed **Talkaround** button or via the menu.

Using the Talkaround Button

1. Press the **Talkaround** button to switch **on** Talkaround when the feature enable alert will sound, the display icon |→| is lit and the display will show:



2. Press the **Talkaround** button again to switch **off** Talkaround when the feature disable alert will sound, the display icon |→| is extinguished and the display will show:



Using the Menu

- 1 Ensure radio is in IDLE STATE.
- 2 Short press on to enter menu
- 3 or until
- 4 Short press on to select
- 5 or until:
- 6 Short press on to show current status.
- 7 or toggles on/off
- 8 Long press on to select
- 9 Display shows: (for 2 seconds)
- 10 Radio exits menu mode and display shows e.g.:

EXTERNAL ALARM

The external alarm feature activates the vehicle horn and/or lights to inform you of an incoming call when you are away from your vehicle.

You can switch External Alarm **On** or **Off** by using a pre-programmed **External Alarm** button or via the menu. Alternatively the alarm may be programmed permanently **On** by your dealer.

An activated alarm can be cancelled by:

1. Answering the call.
2. The external alarm timer times out.

Using the External Alarm Button













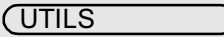

1. Press the **External Alarm** button to switch External Alarm **on**, when the feature enable alert will sound and the display will show:

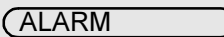
ALRM ON

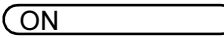
2. Press the **External Alarm** button again to switch External Alarm **off**, when the feature disable alert will sound and the display will show:

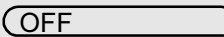
ALRM OFF

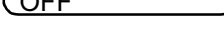
Using the Menu

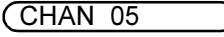
- 1 Ensure radio is in IDLE STATE.
- 2 Short press on  to enter menu
- 3  or  until 
- 4 Short press on  to select
- 5  or  until: 
- 6 Short press on  to show current status. 
- 7  or  toggles on/off 
- 8 Long press on  to select 
- 9 Display shows: (for 2 seconds) 
- 10 Radio exits menu mode and display shows e.g.: 

Note: If programmed permanently **On** by your dealer, the alarm will always be active and generate an alarm when you receive a call. The Display will show:

EXT ALRM

LONE WORKER

The Lone Worker feature enables you to work alone with added safety. You can switch the feature **On** or **Off** by using a pre-programmed **Lone Worker** button, or via the menu.

















Using the Lone Worker Button

1. Press the **Lone Worker** button to switch Lone Worker **on**, when the feature enable alert will sound and the display will show:

 - If you have not pressed any buttons within a programmed time, you will be reminded that **Lone Worker** is switched **on** by a high pitched alert tone (Lone Worker Reminder) being sounded.
 - Press **any button** to respond and cancel the alert, if you do **not** the radio will enter the Emergency state.

2. Press the **Lone Worker** button again to switch Lone Worker **off**, when the feature disable alert will sound and the display will show:

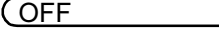
3. You may also switch off Lone Worker by changing the channel or switching radio **off** and **on** again.

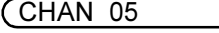
Using the Menu

- 1 Ensure radio is in IDLE STATE.
- 2 Short press on  to enter menu
- 3  or  until 
- 4 Short press on  to select
- 5  or  until: 
- 6 Short press on  to show current status. 
- 7  or  toggles on/off 
- 8 Long press on  to select 
- 9 Display shows: (for 2 seconds) 
- 10 Radio exits menu mode and display shows e.g.: 

POWER LEVEL

You can transmit your calls at different transmit power levels. A higher level means you can reach a radio that is farther away. A lower power level reduces the possibility of interference. Use the high power setting only when necessary.

You can switch between **high** and **low** power levels by using a pre-programmed **Power Level** button or via the menu.

Using the Power Level Button















1. Press the **Power Level** button to switch to **high power** when the feature enable alert will sound, the display icon **H** is lit and the display will show:

HI POWER

2. Press the **Power Level** button again to switch to **low power** when the feature disable alert will sound, the display icon **L** is lit and the display will show:

LOW PWR

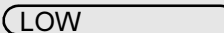
Using the Menu

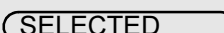
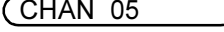
- 1 Ensure radio is in IDLE STATE.
- 2 Short press on  to enter menu
- 3  or  until 
- 4 Short press on  to select
- 5  or  until: 
- 6 Short press on  to show current status. 
- 7  or  toggles High/Low 
- 8 Long press on  to select 
- 9 Display shows: (for 2 seconds) 
- 10 Radio exits menu mode and display shows e.g.: 

COMPANDING

Companding is a collective term to define **compressing** the audio signal on transmission and **expanding** the audio signal on reception. The overall effect is to reduce noise in the received signal, giving you crisper, clearer audio clarity. Companding should only be used when other radios in your system have the same companding feature available.

You can switch Companding **On** or **Off** by using a pre-programmed **Companding** button or, via the menu.

Using the Companding Button















1. Press the **Companding** button to switch Companding **on**, when the feature enable alert will sound and the display will show:

XPANDON

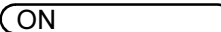
2. Press the **Companding** button again to switch Companding **off**, when the feature is disabled an alert will sound and the display will show:

XPANDOFF

Using the Menu

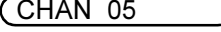
- 1 Ensure radio is in IDLE STATE.
- 2 Short press on  to enter menu
- 3  or  until 
- 4 Short press on  to select
- 5  or  until: 
- 6 Short press on  to show current status. 
- 7  or  toggles on/off 
- 8 Long press on  to select 
- 9 Display shows: (for 2 seconds) 
- 10 Radio exits menu mode and display shows e.g.: 

BACKLIGHT

Backlight illuminates the radio display and menu navigation keys.

Your radio can be programmed to have the backlight permanently on, permanently off or a timed period, when any new information being displayed causes the backlight to remain on for 10 seconds.

You can switch the Backlight **On** or **Off** by using a pre-programmed **Backlight** button or via the menu.

Using the Backlight Button

1. Press the **Backlight** button to switch Backlight **on**, when the feature enable alert will sound and the display will show:

LITE TMD or **LITE ON**

2. Press the **Backlight** button again to switch Backlight **off**, when the feature disable alert will sound and the display will show:

LITE OFF

Using the Menu

- 1 Ensure radio is in IDLE STATE.
- 2 Short press on **(P1)** to enter menu
- 3 **▲** or **▼** until **UTILS**
- 4 Short press on **(P1)** to select
- 5 **▲** or **▼** until: **BACKLITE**
- 6 Short press on **(P1)** to show current status. **LITE ON**
- 7 **▲** or **▼** toggles on/off/timed **LITE TMD**
- 8 Long press on **(P1)** to select **LITE TMD**
- 9 Display shows: (for 2 seconds) **SELECTED**
- 10 Radio exits menu mode and display shows e.g.: **CHAN 05**













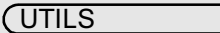

BRIGHTNESS

This feature allows you to alter the brightness of the radio display and menu keys to suit conditions. The feature is only available with "Backlight" selected On.

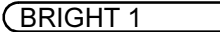
You can only alter the brightness feature via the menu.

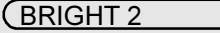
There are three levels of brightness including maximum and minimum. The backlight can only be turned Off (i.e. zero) from the "Backlite" menu option.

Using the Menu :

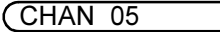
- 1 Ensure radio is in IDLE STATE.
- 2 Short press on  to enter menu
- 3  or  until 
- 4 Short press on  to select
- 5  or  until: 
- 6 Short press on  to show current status. 
- 7  or  scrolls 1, 2 and 3 
- 8 Long press on  to select 
- 9 Display shows: (for 2 seconds) 
- 10 Radio exits menu mode and display shows e.g.: 



LOCAL / DISTANCE

Distance is the standard mode of operation, and maximises receive radio range.

Local reduces interference from other radios in close proximity and is typically used for base station configurations.

You can switch between **Local** and **Distance** by using a pre-programmed **Local/Distance** button.

Using the Local/Distance Button

1. Press the **Local/Distance** button to switch to **Local** when the feature enable alert will sound.
2. Press the **Local/Distance** button again to switch to **Distance** when the feature disable alert will sound.

OPTION BOARD

Your radio is capable of being fitted with an option board. Each board will extend the capability of your radio by adding a new feature such as voice storage, voice scrambler or trunking. See your dealer for the availability and suitability of the various option boards.

You can switch the Option Board **On** or **Off** by using a pre-programmed **Option Board** button or via the menu.

Using the Option Board Button

















1. Press the **Option Board** button to switch the Option Board **on**, when the feature enable alert will sound and the display will show:

OPT ON

2. Press the **Option Board** button again to switch the Option Board **off**, when the feature disable alert will sound and the display will show:

OPT OFF

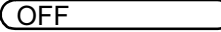
Using the Menu

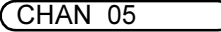
- 1 Ensure radio is in IDLE STATE.
- 2 Short press on  to enter menu
- 3  or  until 
- 4 Short press on  to select
- 5  or  until: 
- 6 Short press on  to show current status. 
- 7  or  toggles on/off 
- 8 Long press on  to select 
- 9 Display shows: (for 2 seconds) 
- 10 Radio exits menu mode and display shows e.g.: 

VOICE OPERATED TRANSMIT (VOX)

When the VOX accessory is connected, your radio may be used with hands-free operation.

The VOX feature intelligently senses background noise, so that it adapts automatically to the noise level in the environment in which you are working.

To start the VOX feature:

1. Ensure that the VOX accessory is connected to the rear accessory connector of the radio.
2. Switch the radio to a VOX channel.

You can disable the VOX feature by pressing the PTT button on the hand held microphone. This allows you to use the hand held microphone as normal.

To re-enable the VOX feature:

1. Change channel away from and back to the VOX channel.

STUN/UNSTUN

For added security and to avoid abuse of the radio system in which you operate, a feature known as **Stun/Unstun** is included in your radio.

This feature can only be activated by your system manager or administrator.

For example, if your radio is stolen and is being used illegally, your system administrator can send a signal which will **stun** the radio making it incapable of being used. This feature is also useful if the system is being abused by a user who is not complying with the correct communications protocol.

The radio can only be unstunned, i.e. returned to operational use, by an **unstun** signal sent from the system administrator or returning the radio for reprogramming.

RADIO INFORMATION

To enable you and your dealer/system administrator to establish, quickly, the software and radio parameters programmed into your radio, a feature known as **Radio Information** can be accessed via the menu.

On selection of **Radio Information**, your radio display will indicate:

- Software (SW) version
- Software (SW) part number
- Codeplug (CP) version
- Codeplug (CP) part number

Using MenuTo access Radio Information

Short press on  to enter menu



1 Ensure radio is in IDLE STATE.

2 Short press on  to enter menu

3  until



4 Short press on  to select

5  or  to scroll
SW VER
SW P/N
CP VER
CP P/N



6 Short press on  to select

7 Display shows e.g.

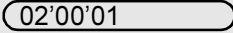

8 Short press on  returns up 1 menu level.



9 After no activity on navigation keys, radio exits menu mode and display shows e.g.:



RADIO INFORMATION

RADIO INFORMATION

NOTES

English

54

Free Manuals Download Website

<http://myh66.com>

<http://usermanuals.us>

<http://www.somanuals.com>

<http://www.4manuals.cc>

<http://www.manual-lib.com>

<http://www.404manual.com>

<http://www.luxmanual.com>

<http://aubethermostatmanual.com>

Golf course search by state

<http://golfingnear.com>

Email search by domain

<http://emailbydomain.com>

Auto manuals search

<http://auto.somanuals.com>

TV manuals search

<http://tv.somanuals.com>