



EX600

User Guide
Guide de l'utilisateur



CONTENTS

Safety	5
Safety and General Information	5
Radio Frequency (RF) Operational Characteristics	5
Portable Radio Operation and EME Exposure	5
Two-way Radio Operation	6
Body-worn Operation	6
Antenna Care	7
Approved Accessories	7
Electromagnetic Interference/Compatibility ..	7
Facilities	7
Aircraft	7
Medical Devices	7
Safety and General	8
Operational Warnings	8
Operational Cautions	9
Intrinsically Safe Radio Information	10
FMRC Approved Equipment	10
Repair of FMRC Approved Products ..	11
Radio Overview	15
Parts of the Radio EX600™ Model	15
On/Off/Volume Knob	16

Channel Selector Knob	16
Push-to-Talk (PTT) Button	16
Microphone	16
LED Indicator	16
Programmable Buttons	16
Indicator Tones	18
Menu Keys	18
Keypad Keys	19
LCD Screen	21
Audio Indicators for Programmable Buttons	22
Improved Audio Features	23
Low Level Expansion (LLE)	23
Companding (X-Pand)	23
Getting Started	25
Battery Information	25
Battery Care and Tips	25
Charging your Battery	26
Battery Charge Status	27
Accessory Information	28
Attaching the Battery	28
Removing the Battery	28
Attaching the Antenna	29
Removing the Antenna	29
Attaching the Side Connector Cover ..	30
Turning The Radio On or Off	30

Adjusting the Volume	31	To Add or Delete Channels in a	
Selecting a Zone.	31	Scan List	43
Selecting a Radio Channel.	32	Prioritizing a Channel in a Scan List . .	43
Sending a Call	32	Setting Priority Channels	44
Receiving a Call	32	Phone	45
Radio Calls	33	Making a Phone Call	45
Making a Selective Call	33	Modifying The Phone List	46
Receiving a Selective Call	33	To Add an Entry	46
Sending a Call Alert Page	34	To Delete an Entry	47
Receiving a Call Alert Page	34	To Edit an Entry	48
Radio Check	35	Audio/Tone Settings	49
Sending an Emergency Alert	35	Utilities	51
Editing a Radio Call List	36	Setting the Time	53
Repeater or Talkaround Mode	37	Warranty	55
Setting Tight or Normal Squelch.	37	Limited Warranty	55
Setting the Power Level	38	Accessories	59
Name and Call Tone Tagging.	39	Carry Cases	59
Scan	41	Audio Accessories	59
Starting or Stopping Scan	41	Batteries	59
Talkback	41	Chargers	59
Deleting a Nuisance Channel	42	Antennas	60
Restoring a Channel Back to the			
Scan List	42		
Editing a Scan List	42		

COMPUTER SOFTWARE COPYRIGHTS

The Motorola products described in this manual may include copyrighted Motorola computer programs stored in semiconductor memories or other media. Laws in the United States and other countries preserve for Motorola certain exclusive rights for copyrighted computer programs, including, but not limited to, the exclusive right to copy or reproduce in any form the copyrighted computer program. Accordingly, any copyrighted Motorola computer programs contained in the Motorola products described in this manual may not be copied, reproduced, modified, reverse-engineered, or distributed in any manner without the express written permission of Motorola. Furthermore, the purchase of Motorola products shall not be deemed to grant either directly or by implication, estoppel, or otherwise, any license under the copyrights, patents or patent applications of Motorola, except for the normal non-exclusive license to use that arises by operation of law in the sale of a product.

Notes

SAFETY

SAFETY AND GENERAL INFORMATION

IMPORTANT INFORMATION ON SAFE AND EFFICIENT OPERATION

READ THIS INFORMATION BEFORE USING YOUR MOTOROLA TWO-WAY RADIO

The information provided in this document supersedes the general safety information contained in user guides published prior to October 2000. For information regarding radio use in a hazardous atmosphere refer to the Factory Mutual (FM) manual supplement included with radio models that offer this capability and/or the intrinsic safety radio information section of this user manual.

RADIO FREQUENCY (RF) OPERATIONAL CHARACTERISTICS

To transmit (talk) you must push the Push-To-Talk button; to receive (listen) you must release the Push-To-Talk button. When the radio is transmitting, it generates radio

frequency (RF) energy; when it is receiving, or when it is off, it does not generate RF energy.

PORTABLE RADIO OPERATION AND EME EXPOSURE

Your Motorola radio is designed to comply with the following national and international standards and guidelines regarding exposure of human beings to radio frequency electromagnetic energy (EME):

- United States Federal Communications Commission, Code of Federal Regulations; 47 CFR part 2 sub-part J
- American National Standards Institute (ANSI) / Institute of Electrical and Electronic Engineers (IEEE) C95. 1-1992
- Institute of Electrical and Electronic Engineers (IEEE) C95.1-1999 Edition
- National Council on Radiation Protection and Measurements (NCRP) of the United States, Report 86, 1986
- International Commission on Non-Ionizing Radiation Protection (ICNIRP) 1998

- Ministry of Health (Canada) Safety Code 6. Limits of Human Exposure to Radio Frequency Electromagnetic Fields in the Frequency Range from 3 kHz to 300 GHz, 1999
- Australian Communications Authority Radiocommunications (Electromagnetic Radiation - Human Exposure) Standard 1999 (applicable to wireless phones only)

To assure optimal radio performance and make sure human exposure to radio frequency electromagnetic energy is within the guidelines set forth in the above standards, always adhere to the following procedures:

Two-way Radio Operation

When using your radio, **hold the radio in a vertical position with the microphone one to two inches (2.5 to 5 centimeters) away from the lips.**



Body-worn Operation

To maintain compliance with FCC RF exposure guidelines, if you wear a radio on your body when transmitting, always place the radio in a **Motorola approved clip, holder, holster, case, or body harness for this product.** Use of non-Motorola-approved accessories may exceed FCC RF exposure guidelines. **If you do not use a Motorola approved body-worn accessory and are not using the radio in the intended use positions along side of the head in the phone mode or in front of the face in the two-way radio mode, then ensure the antenna and radio is kept the following minimum distances from the body when transmitting:**

- Phone or Two-way radio mode: one inch (2.5 centimeters)
- Data operation using any data feature with or without an accessory cable: one inch (2.5 centimeters)

Antenna Care

Use only the supplied or an approved replacement antenna. Unauthorized antennas, modifications, or attachments could damage the radio and may violate FCC regulations.

DO NOT hold the antenna when the radio is “IN USE”. Holding the antenna affects call quality and may cause the radio to operate at a higher power level than needed.

Approved Accessories

For a list of approved Motorola accessories look in the appendix or accessory section of your radio’s User Guide.

ELECTROMAGNETIC INTERFERENCE/COMPATIBILITY

Note: Nearly every electronic device is susceptible to electromagnetic interference (EMI) if inadequately shielded, designed or otherwise configured for electromagnetic compatibility.

Facilities

To avoid electromagnetic interference and/or compatibility conflicts, turn off your radio in any facility where posted notices instruct you to do so. Hospitals or health care facilities may be using equipment that is sensitive to external RF energy.

Aircraft

When instructed to do so, turn off your radio when on board an aircraft. Any use of a radio must be in accordance with applicable regulations per airline crew instructions.

Medical Devices

- **Pacemakers**

The Health Industry Manufacturers Association recommends that a minimum separation of 6 inches (15 centimeters) be maintained between a handheld wireless radio and a pacemaker. These recommendations are consistent with those of the U.S. Food and Drug Administration.

Persons with pacemakers should:

- ALWAYS keep the radio more than 6 inches (15 centimeters) from their pacemaker when the radio is turned ON.
- Not carry the radio in the breast pocket.
- Use the ear opposite the pacemaker to minimize the potential for interference.
- Turn the radio OFF immediately if you have any reason to suspect that interference is taking place.

- **Hearing Aids**

Some digital wireless radios may interfere with some hearing aids. In the event of such interference, you may want to consult your hearing aid manufacturer to discuss alternatives.

- **Other Medical Devices**

If you use any other personal medical device, consult the manufacturer of your device to determine if it is adequately shielded from RF energy. Your physician

may be able to assist you in obtaining this information.

SAFETY AND GENERAL

Use While Driving

Check the laws and regulations on the use of radios in the area where you drive. Always obey them.

When using your radio while driving, please:

- Give full attention to driving and to the road.
- Use hands-free operation, if available.
- Pull off the road and park before making or answering a call if driving conditions so require.

OPERATIONAL WARNINGS



WARNING

FOR VEHICLES WITH AN AIR BAG

Do not place a portable radio in the area over an air bag or in the air bag deployment area. Air bags inflate with great force. If a portable radio is placed in the air bag deployment area and the air bag inflates, the radio may be propelled

with great force and cause serious injury to occupants of the vehicle.

POTENTIALLY EXPLOSIVE ATMOSPHERES

Turn off your radio prior to entering any area with a potentially explosive atmosphere, unless it is a radio type especially qualified for use in such areas as "Intrinsically Safe" (for example, Factory Mutual, CSA, UL, or CENELEC). Do not remove, install, or charge batteries in such areas. Sparks in a potentially explosive atmosphere can cause an explosion or fire resulting in bodily injury or even death.

Note: The areas with potentially explosive atmospheres referred to above include fueling areas such as below decks on boats, fuel or chemical transfer or storage facilities, areas where the air contains chemicals or particles, such as grain, dust or metal powders, and any other area where you would normally be advised to turn off your vehicle engine. Areas with potentially explosive atmospheres are often but not always posted.

BLASTING CAPS AND AREAS

To avoid possible interference with blasting operations, turn off your radio when you are near electrical blasting caps, in a blasting area, or in areas posted: "Turn off two-way radio." Obey all signs and instructions.

OPERATIONAL CAUTIONS



Caution

ANTENNAS

Do not use any portable radio that has a damaged antenna. If a damaged antenna comes into contact with your skin, a minor burn can result.

BATTERIES

All batteries can cause property damage and/or bodily injury such as burns if a conductive material such as jewelry, keys, or beaded chains touch exposed terminals. The conductive material may complete an electrical circuit (short circuit) and become quite hot. Exercise care in handling any charged battery, particularly when placing it inside a pocket, purse, or other container with metal objects.

INTRINSICALLY SAFE RADIO INFORMATION

FMRC Approved Equipment

Anyone intending to use a radio in a location where hazardous concentrations of flammable material exist (hazardous atmosphere) is advised to become familiar with the subject of intrinsic safety and with the National Electric Code NFPA 70 (National Fire Protection Association) Article 500 (hazardous [classified] locations).

An Approval Guide, issued by Factory Mutual Research Corporation (FMRC), lists manufacturers and the products approved by FMRC for use in such locations. FMRC has also issued a voluntary approval standard for repair service ("Class Number 3605").

FMRC Approval labels are attached to the radio to identify the unit as being FM Approved for specified hazardous atmospheres. This label specifies the hazardous Class/Division/Group along with the part number of the battery that must be used. Depending on the design of the portable unit, this FM label can be found on the back or the bottom of the radio

housing. The FM Approval mark is shown below:



WARNINGS



WARNING

- Do not operate radio communications equipment in a hazardous atmosphere unless it is a type especially qualified for such use (e.g., FMRC Approved). An explosion or fire may result.
- Do not operate an FMRC Approved Product in a hazardous atmosphere if it has been physically damaged (e.g., cracked housing). An explosion or fire may result.
- Do not replace or charge batteries in a hazardous atmosphere. Contact sparking may occur while installing or removing batteries and cause an explosion or fire.

WARNINGS



WARNING

- Do not replace or change accessories in a hazardous atmosphere. Contact sparking may occur while installing or removing accessories and cause an explosion or fire.
- Do not operate an FMRC Approved Product unit in a hazardous location with the accessory contacts exposed. Keep the connector cover in place when accessories are not used.
- Turn a radio off before removing or installing a battery or accessory.
- Do not disassemble an FMRC Approved Product unit in any way that exposes the internal electrical circuits of the unit.
- Radios must ship from the Motorola manufacturing facility with the hazardous atmosphere capability and FM Approval labeling. Radios will not be “upgraded” to this capability and labeled in the field.
- A modification changes the unit’s hardware from its original design configuration. Modi-

fications can only be made by the original product manufacturer at one of its FMRC-audited manufacturing facilities.

WARNINGS



WARNING

- Failure to use an FMRC Approved Product unit with an FMRC Approved battery or FMRC Approved accessories specifically approved for that product may result in the dangerously unsafe condition of an unapproved radio combination being used in a hazardous location.
- Unauthorized or incorrect modification of an FMRC Approved Product unit will negate the Approval rating of the product.

Repair of FMRC Approved Products

REPAIRS FOR MOTOROLA PRODUCTS WITH FMRC APPROVAL ARE THE RESPONSIBILITY OF THE USER.

You should not repair or relabel any Motorola-manufactured communication equipment bearing the FMRC Approval label (“FMRC Approved Product”) unless you are familiar

with the current FMRC Approval standard for repairs and service (“Class Number 3605”). You may want to consider using a repair facility that operates under 3605 repair service approval.

WARNINGS



WARNING

- Incorrect repair or relabeling of any FMRC Approved Product unit could adversely affect the Approval rating of the unit.
- Use of a radio that is not intrinsically safe in a hazardous atmosphere could result in serious injury or death.

FMRC's Approval Standard Class Number 3605 is subject to change at any time without notice to you, so you may want to obtain a current copy of 3605 from FMRC. Per the December 1994 publication of 3605, some key definitions and service requirements are as follows:

Repair

A repair constitutes something done internally to the unit that would bring it back to its original condition—Approved by FMRC. A repair should be done in an FMRC Approved facility.

Items not considered as repairs are those in which an action is performed on a unit which does not require the outer casing of the unit to be opened in a manner which exposes the internal electrical circuits of the unit. You do not have to be an FMRC Approved Repair Facility to perform these actions.

Relabeling

The repair facility shall have a method by which the replacement of FMRC Approval labels are controlled to ensure that any relabeling is limited to units that were originally shipped from the Manufacturer with an FM Approval label in place. FMRC Approval labels shall not be stocked by the repair facility. An FMRC Approval label shall be ordered from the original manufacturer, as needed, to repair a specific unit. Replacement labels may be obtained and applied by the repair facility, provided there is satisfactory evidence that the unit being relabeled was originally an FMRC Approved unit. Verification may include, but is not limited to: a unit with a damaged Approval label, a unit with a defective housing displaying an Approval label, or a customer invoice indicating the serial number of the unit and purchase of an FMRC Approved model.

Do Not Substitute Options or Accessories

The Motorola communications equipment certified by Factory Mutual is tested as a system and consists of the FM Approved portable, FM Approved battery, and FM Approved accessories or options, or both. This FM Approved portable and battery combination must be strictly observed. There must be no substitution of items, even if the substitute has been previously Approved with a different Motorola communications equipment unit. Approved configurations are listed in the FM Approval Guide published by FMRC, or in the product FM Supplement. This FM Supplement is shipped from the manufacturer with the FM Approved radio and battery combination. The Approval Guide, or the Approval Standard Class Number 3605 document for repairs and service, can be ordered directly from Factory Mutual Research Corporation located in Norwood, Massachusetts.

Notes

RADIO OVERVIEW

PARTS OF THE RADIO

EX600™ Model

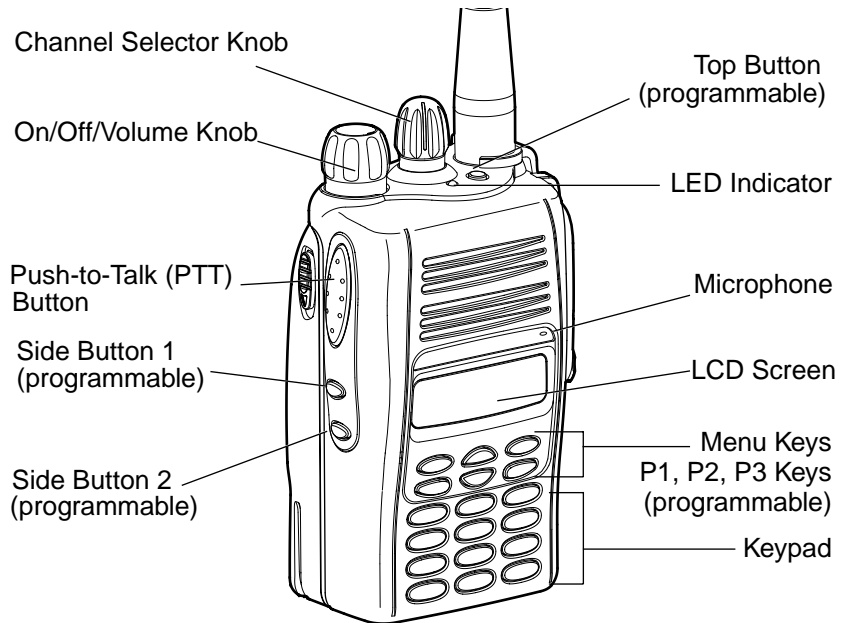

On/Off/Volume Knob

Turns the radio on or off, and adjusts the radio's volume.

Channel Selector Knob

Switches the radio to different channels.

Push-to-Talk (PTT) Button

Press and hold down this button to talk, release it to listen.

Microphone

Speak clearly into the microphone when sending a call.

LED Indicator

Gives battery status, power-up status, radio call information and scan status.

Programmable Buttons







Several of the radio's buttons can be programmed as short-cut buttons for many of the radio's features. Programmable buttons include:

- top button
- two side buttons

Each button can access up to two features, depending on the type of button press:

- **short press** - quickly pressing and releasing the programmable buttons, or
- **long press** - pressing and holding the programmable buttons for at least 1 1/2 seconds, or
- **hold down** - pressing and holding down the programmable buttons while checking status or making adjustments.

The table on pages 17 and 18 summarizes the programmable features available.

Function	Indicator	Short Press	Long Press	Hold Down	Page	Button
Emergency (Top button only)		Initiate Emergency Alert.	Cancel Emergency status.	—	35	
Monitor		Turn monitor function off.	Continually monitor selected channel.	—	—	
Volume Set	—	—	—	Sound a tone for adjusting your radio's volume level.	31	
Battery Gauge		—	—	Check the battery's charge status.	27	
Scan/Nuisance Channel Delete		Toggle scan on and off.	Delete a nuisance channel while scanning.	—	42	
Power Level	LH	Toggle transmit power level between High and Low.†		—	38	
Keypad Lock		—	Toggle keypad between Locked and Unlocked.	—	—	
Repeater/ Talkaround		Toggle between using a repeater or transmitting directly to another radio.†		—	37	

† This function is activated by **EITHER** a short **OR** a long press, but not both.

Function	Indicator	Short Press	Long Press	Hold Down	Page	Button
Squelch	—	Toggle squelch level between Tight and Normal.†		—	37	
Phone	①	Access Phone Mode.†		—	45	
Speed Dial	—	Access your phone list.†		—	45	
Radio Call	—	Make a radio call.†		—	33	
Light	—	Turn on your radio backlight.†		—	—	

† This function is activated by **EITHER** a short **OR** a long press, but not both.

INDICATOR TONES

High pitched tone Low pitched tone



Self Test Pass Tone



Self Test Fail Tone



Positive Indicator Tone



Negative Indicator Tone

Menu Keys

Exit



Up



Menu/
Select



Left



Down



Right

Menu/Select Key

Used to enter Menu Mode. When in Menu Mode, this key is also used to make menu selections.

Exit Key

Used to move to the previous Menu level (short press) or to exit Menu Mode (long press).

Up Key and **Down Key**

Used for scrolling when in Menu Mode. The  key can also be programmed.

Right Key

Moves the cursor right or inserts a space when editing. This key can also be programmed.

Left Key

Used as a backspace key when editing. This key can also be programmed.

Keypad Keys

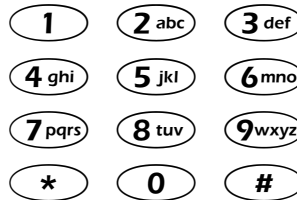

These keys are used for:

- dialing a phone number
- making a radio call
- entering information when programming radio lists

Each key can generate several different characters. For example, to enter the character “C,” press the  key three times. (Refer to table on page 20.)





Entering Characters Using the Keypad

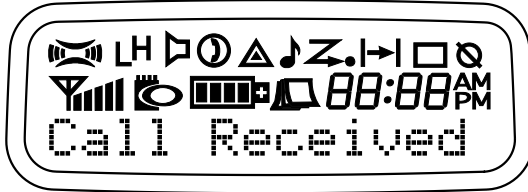





Key	Number of Times Key is Pressed														
	1	2	3	4	5	6	7	8	9	10	11	12	13	14	15
0	0	()	<	>											
1	1	&	%	#	*										
2 abc	A	B	C	2	a	b	c	2	Á	Ç	à	á	ç		
3 def	D	E	F	3	d	e	f	3	È	É	Ê	è	é	ê	
4 ghi	G	H	I	4	g	h	i	4	Í	ì	í				
5 jkl	J	K	L	5	j	k	l								
6 mno	M	N	O	6	m	n	o	6	Ñ	Ó	Ô	ò	ó	ô	ö
7 pqrs	P	Q	R	S	7	p	q	r	s	7					
8 tuv	T	U	V	8	t	u	v	8	Ú	ù	ú				
9 wxyz	W	X	Y	Z	9	w	x	y	z	9	Y	y			
*	*	/	+	-	=										
#	#	Blank Space	-	.	!	?	'	"	,	;					







LCD Screen



The top two screen rows display menu and radio status information:

Symbol	Indication
 X-Pand™	The X-Pand feature is activated. When in narrow band, this feature improves audio quality.
 Power Level	Low Power “L” or High Power “H” is activated.
 Monitor	The selected channel is being monitored.
 Phone	Phone Mode is selected.

Symbol	Indication
 Emergency	An Emergency Alert is being sent.
 Call Received	A Selective Call or Call Alert has been received.
 Scan	The Scan feature has been activated. Also, during Scan, indicates that there is some activity on a non-priority channel.
 Priority 1 Scan (• flashing)	During Scan, indicates that there is some activity on a <i>Priority 1</i> channel.
 Priority 2 Scan (• steady)	During Scan, indicates that there is some activity on a <i>Priority 2</i> channel.
 Talkaround	You are not transmitting through a repeater.

Symbol	Indication
 Programming Mode	A Program List is being edited.
 Keypad Lock	The keypad is locked.
 Signal Strength	The more bars, the stronger the signal being received.
 Battery Level	The number of bars (0 - 4) shown indicates the charge remaining in your battery.
 Not Currently Assigned	
 Clock	Shows the time (12- or 24-hour).

AUDIO INDICATORS FOR PROGRAMMABLE BUTTONS



High-Low Tone



Low-High Tone

In addition to having visual indicators, some programmable buttons use tones to indicate one of two modes:

Programmable Buttons	High-Low Tone	Low-High Tone
Scan	Starts Scan operation	Stops Scan operation
Tx Power	Transmits at low power	Transmits at high power
Squelch	Operates in tight squelch	Operates in normal squelch
Repeater/Talkaround	DOES NOT use the repeater	Uses the repeater

IMPROVED AUDIO FEATURES

Low Level Expansion (LLE)

The LLE feature of your radio improves voice quality by reducing unwanted background noise when receiving a message. It is compatible with most major types of audio processing systems available today.

Comanding (X-Pand)

Comanding is a feature that allows further improvement of voice quality. It compresses your voice at transmission, and expands it when receiving while simultaneously reducing extraneous noise. However, to enjoy this benefit, ALL transmitting and receiving radios must have this feature activated.

NOTE: Contact your dealer for your radio's current comanding settings or to change the settings.

Notes

GETTING STARTED

BATTERY INFORMATION

Battery Care and Tips

This product is powered by a rechargeable battery.

The following battery tips will help you obtain the highest performance and longest cycle life from your Motorola rechargeable battery.

- Batteries are shipped uncharged from the factory. Always charge a new battery 14 - 16 hours before initial use, regardless of the status indicated by the charger.
- Charging in non-Motorola equipment may lead to battery damage and void the battery warranty.
- When charging a battery that is attached to the radio, turn the radio off to ensure a full charge.
- The battery should be at about 77°F (25°C) (room temperature) whenever possible. Charging a cold battery, (below 50°F [10°C]) may result in leakage of electrolyte and ultimately, in failure of the battery.
- Charging a hot battery (above 95°F [35°C]) results in reduced discharge capacity, affecting the performance of the radio. Motorola rapid-rate battery chargers contain a temperature-sensing circuit to ensure that the battery is charged within these temperature limits.
- New batteries can be stored up to two years without significant cycle loss. Store new/unused batteries in a cool dry area.
- Batteries which have been in storage should be charged overnight.
- Do not return fully charged batteries to the charger for an “extra boost”. This action will **significantly** reduce cycle life.
- Do not leave your radio and battery in the charger when not charging. Continuous charging will shorten battery life. (Do not use your charger as a radio stand.)

- For optimum battery life and operation use only Motorola brand chargers. They were designed to operate as an integrated energy system.

Charging your Battery

When the battery level is very low, you need to recharge the battery before you can continue to use your radio.

- Place the radio with the battery attached or the battery alone in the charger.
- The charger's LED would indicate the charging progress.

NOTE: Because new batteries or batteries that have not been used for several months could prematurely indicate full charge (solid green LED), charge the batteries for 14 to 16 hours prior to initial use to achieve optimal performance.







LED color	Battery/Charger Status
No LED Indication	Battery inserted incorrectly.
Single flash of Green	Successful charger power-up.
Flashing Red *	Battery is unchargeable or not making proper contact.
Flashing Yellow	Charger is getting ready to charge.
Red	Battery is charging.
Flashing Green†	Battery is 90% (or more) charged.
Green	Battery is fully charged.

* Remove the battery from charger and use a pencil eraser to clean the four metal contacts on the bottom of the battery. Place the battery back into the charger. If the LED indicator continues to flash red, replace the battery.

† A standard battery may require one hour to charge to 90% capacity.

Battery Charge Status

You can check battery charge status by holding down the preprogrammed **Battery Gauge** button (see page 17). The charge status is shown by the LED indicator or the number of bars in the  status indicator symbol.

Battery Level	LED Indicator	Status Indicator 
High	Green	
Sufficient	Yellow	 or 
Low	Flashing red	
Very Low	None	 (flashing)

Battery chargers will only charge the Motorola authorized batteries listed below; other batteries may not charge.

Part No.	Description
JMNN4023	1000 mAH Li-Ion High Capacity Battery
JMNN4024	1320 mAH Li-Ion Ultra High Capacity Battery

ACCESSORY INFORMATION

Attaching the Battery

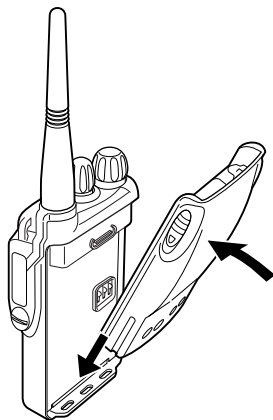

- 1 Fit the extensions at the bottom of the battery into the slots at the bottom of the radio.
- 2 Press the top part of the battery towards the radio until a double click is heard.

Note: It is important to make sure that both battery latches are secured.

Removing the Battery

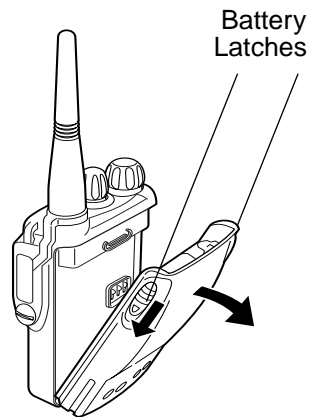

- 1 Turn off the radio (see page 30).
- 2 Slide the battery latches, on both sides of the battery, downwards.
- 3 Pull the top part of the battery away from the radio.

Attaching the Antenna

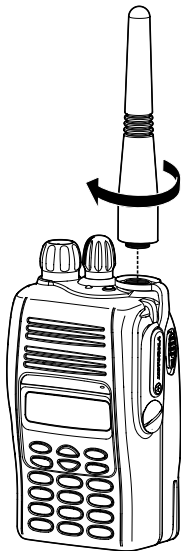

- 1 Align the threaded end of the antenna with the radio's antenna connector.
- 2 Turn the antenna clockwise to attach it.

Removing the Antenna

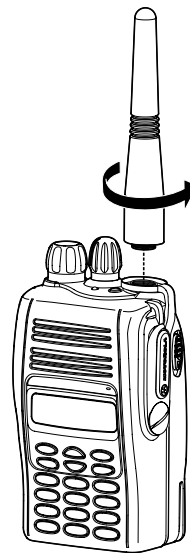

- 1 Turn the antenna counterclockwise to remove it.

Attaching the Side Connector Cover

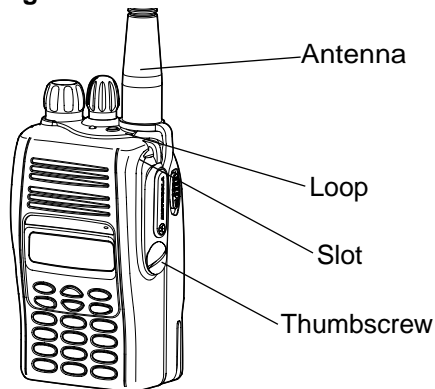

- 1 Place the loop (attached to the side connector cover) over the antenna; then slide it downward until it touches the top of the radio.
- 2 Insert the tab on the top of the cover into the slot above the connector.
- 3 Position the cover over the connector and align the thumbscrew with the threaded hole in the radio.
- 4 Tighten the thumbscrew to hold the cover in place. **Do not overtighten the thumbscrew.**

TURNING THE RADIO ON OR OFF

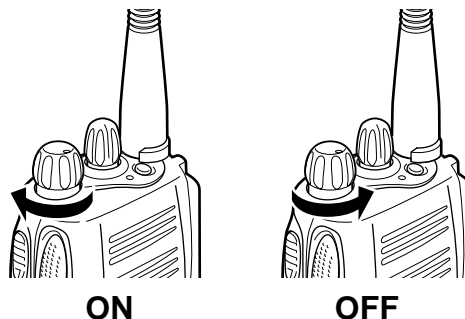

- 1 Turn the **On/Off/Volume** (see page 15) knob clockwise to turn on the radio. You will hear the Self Test Pass Tone and see a green LED if the radio powers up successfully. If the radio fails to power up, you will hear the Self Test Fail Tone.
- 2 Turn the **On/Off/Volume** knob counterclockwise, until a click is heard, to turn off the radio.









ADJUSTING THE VOLUME

- 1 Press and hold the **Volume Set** button (see page 17); you will hear a continuous tone.
- 2 Turn the **On/Off/Volume** knob to the desired volume level.
- 3 Release the **Volume Set** button.

SELECTING A ZONE

A zone is a group of up to 16 channels. To access a channel in a zone, you need to select the zone first.

To select a zone:

- 1  to enter Menu Mode.
- 2  or  until  **Zone**
- 3  to select  **Zone**
- 4  or  until you see the desired zone name.
- 5  to select the zone.

SELECTING A RADIO CHANNEL

Your radio offers 128 channels (8 zones of 16 channels each).

Note: Due to government regulations, some channels may not be programmed. Ask your Motorola Representative for more information.

To select a channel:

- 1 Select the appropriate Zone, if required (see "Selecting a Zone" on page 31).
 - 2 Turn the **Channel Selector** knob clockwise or counterclockwise until you reach the desired channel, as shown on the LCD display.
-

SENDING A CALL

- 1 Turn your radio on.
 - 2 Use the **Channel Selector** knob (see page 15) to select to the desired channel.
 - 3 Press the **PTT** button (see page 15), and speak clearly with your mouth about 2.5 to 5 cm (one to two inches) away from the microphone.
 - 4 Release the **PTT** button when you finish speaking.
-

RECEIVING A CALL













- 1 Turn your radio on.
 - 2 Adjust the radio's volume (see page 31).
 - 3 Switch to the desired channel.
 - 4 If at any time a call comes through, you will hear the call at the volume level you have set.
-

RADIO CALLS

MAKING A SELECTIVE CALL

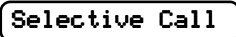
You can make a selective call to a particular radio or group of radios, provided the signalling protocol supports it.

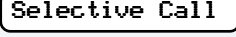
To make a Selective Call:

- 1  to enter Menu Mode.
- 2  or  until 
- 3  to select 
- 4  or  until 
- 5  to select 
- 6  or  to locate the desired ID in the Radio Call List.
–or–
Enter the ID number of the radio you want to call.

- 7 Press the **PTT** button to send the call.

The radio sounds a continuous tone.

- 8 Press the **PTT** button and talk; release the **PTT** button to listen.

- 9 When finished with the call

 to return to



–or–

Hold down  to exit Menu Mode.

RECEIVING A SELECTIVE CALL

When you receive a selective call:















- You will hear two alert tones.
- The LED Indicator will light yellow.
- The LCD screen will display  and the pre-programmed name or ID of the calling radio.



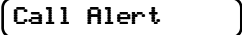

To answer the call, press the **PTT** button.

SENDING A CALL ALERT PAGE

You can alert another person by sending a *Call Alert* page.

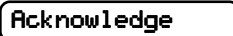
To send a Call Alert page:

- 1  to enter Menu Mode.
- 2  or  until 
- 3  to select 
- 4  or  until 
- 5  to select 
- 6  or  to locate the desired ID in the Radio Call List.
 –or–
 Enter the ID number of the radio you want to page.
- 7 Press the **PTT** button to send the page.
 you will see 

- 8 If the Call Alert page is received,
 you will see 
 If not received,
 you will see 
 to return to 
 –or–
 Hold down  to exit Menu Mode.

RECEIVING A CALL ALERT PAGE

When your radio receives a Call Alert page, it continuously sounds four alert tones, and displays the  symbol with the ID of the calling radio, until you respond.











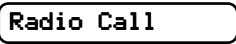

Press the **PTT** button to answer the page, or press any other key to cancel it.

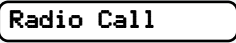
Note: Your radio will display only the last Call Alert page received. Also, your radio will not receive any Selective Calls until you clear the page.

RADIO CHECK

This feature allows you to determine if a radio is within range without disturbing the user of the receiving radio. Radio Check can also be used when attempts with Selective Call and Call Alert fail. (This feature is available only if your signalling protocol supports it.)

To perform a Radio Check:

- 1  to enter Menu Mode.
- 2  or  until 
- 3  to select 
- 4  or  until 
- 5  to select 
- 6  or  to locate the desired ID in the Radio Call List.
-or-
Enter the ID number of the radio you are checking.

- 7 Press the **PTT** button.

you will see

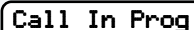

- 8 If the Radio Check is received,

you will see



If not received,

you will see



- 9  to return to



-or-

Hold down  to exit Menu Mode.

SENDING AN EMERGENCY ALERT

If programmed by your dealer, the orange **Top** button can send a priority Emergency Alert (see page 17) to a specific radio or dispatch center. Emergency alerts have priority over all other calls.

The  symbol will appear on the LCD screen when your radio is in the Emergency Alert state.

An Emergency Alert can be programmed to do one of the following:

- show  and sound a tone

–or–

- show  (silent Emergency)

–or–

- activate the microphone so that all activity can be transmitted (for a predetermined amount of time).

To activate the Emergency Alert, press the **Emergency** button.

To cancel the Emergency Alert, press and hold down the **Emergency** button.

EDITING A RADIO CALL LIST

The ID numbers in your Radio Call List are preprogrammed by your dealer. However, you can edit the names associated with these IDs. The  symbol will appear on the LCD screen when you are editing.

Note: The radio cannot receive any calls while you are editing.

To Edit a Call List entry:

1  to enter Menu Mode.

2  or  until 



3  to select 

4  or  until 

5  to select 

6  or  until 

7  to select 

8  or  until you locate the desired entry.

9  to select the entry.

10 Use your keypad to edit the entry (page 19).

11  to save your changes.

you will see 

12  to return to 

–or–

Hold down  to exit Menu Mode.

REPEATER OR TALKAROUND |→| MODE

Talkaround Mode enables you to communicate with another radio when either:

- the repeater is not operating

–or–

- your radio is out of the repeater's range but within communicating distance of another radio.

Note: The |→| symbol will appear on the LCD screen when Talkaround Mode is selected.

To select either Repeater Mode or Talkaround Mode:

Press the preprogrammed **Repeater/Talkaround** button (see page 17) to toggle between Repeater Mode and Talkaround Mode.



–or–

1  to enter Menu Mode.

2  or  until 

3  to select



4  or  until



or until



5  to confirm your selection.

SETTING TIGHT OR NORMAL SQUELCH

Use this feature to filter out nuisance (unwanted) calls and/or background noise. However, tightening squelch could cause calls from remote locations to be filtered out as well. In this case, normal squelch may be more desirable.











To select tight or normal squelch:



Press the preprogrammed **Squelch** button (see page 18) to toggle between tight and normal squelch,

–or–

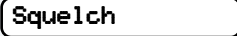
Do the following:

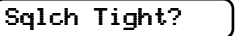
1  to enter Menu Mode.

- 2  or  until 
- 3  to select 
- 4  or  until 
- 5  to select 
- 6  or  until 

or until 
- 7  to confirm your selection.

SETTING THE POWER LEVEL

Each channel in your radio has a predefined transmit power level that can be changed.

- *High power (H)* allows you to reach a radio that is farther away.
- *Low power (L)* conserves the battery's charge.
- *Auto power* automatically sets the optimal power level based on the strength of the signal received. If the received signal is











weak, the transmit level will be set to high, and vice-versa.

Note: Be aware that a message received from a nearby radio might change your radio's power level to low. This may cause radios that are farther away not to receive your transmissions.





To set the power level:

Press the preprogrammed **Power Level** button (see page 17) to toggle between *low* and *high*,
–or–

Do the following:

- 1  to enter Menu Mode.
- 2  or  until 
- 3  to select 
- 4  or  until 
- 5  to select 

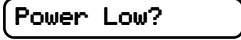
The display shows the current power level.

- 6  or  until 
- or until 
- or until 















7  to confirm the selection.

NAME AND CALL TONE TAGGING

You can program your radio to sound a particular alert tone when a specific user is calling (name tone tagging), or when receiving a particular type of radio call (call tone tagging).

There are eight alert tones to select from.

To tag a specific user's **name**:

- 1  to enter Menu Mode.
- 2  or  until 
- 3  to select 
- 4  or  until 
- 5  to select 
- 6  or  until you see the name you want to tag.
- 7  to confirm the selection.

8 or until you see and hear the tone you want to use for this name.

9 to confirm the selection.

You will see

Name Tag Set

10 to return to

Name Tone Tag

–or–

Hold down to exit Menu Mode.

To tag a type of radio **call**:

1 to enter Menu Mode.

2 or until

Audio/Tones

3 to select

Audio/Tones

4 or until

Call Tone Tag

5 to select

Call Tone Tag

6 or until you see the call type you want to tag.

7 to confirm the selection.

8 or until you see and hear the tone you want to use for this type of call.

9 to confirm the selection.

You will see

Call Tone Set

10 to return to

Call Tone Tag

–or–

Hold down to exit Menu Mode.

SCAN

You can monitor multiple channels and receive any calls that are transmitted on them. Sixteen different channels can be programmed into each scan list by your Motorola Representative. Your radio will automatically switch to a scan list channel when it detects activity on it.

Note: The same channels can be assigned to different scan lists.

STARTING OR STOPPING SCAN

The  symbol, and the channel you are transmitting on, will appear on the LCD screen when you start a scan operation.

The LED indicator blinks green during a scan operation, and stops blinking when the radio switches to a channel.

Note: If you enter Menu Mode while the radio is scanning, scanning will stop. It will resume when you exit Menu Mode.

To start or stop a scan operation:

Press the preprogrammed **Scan** button (see page 17) to start or stop scanning.

–or–

Do the following:

1  to enter Menu Mode.

2  or  until 

3  to select 

4  or  until 

–or–



5  to confirm your selection.

TALKBACK

While your radio is scanning, Talkback allows you to participate in a call in progress. You must press the **PTT** button to participate in the call; otherwise, scanning continues to the next channel.

DELETING A NUISANCE CHANNEL

If a channel continually generates unwanted calls or noise (a “nuisance” channel), use the **Scan** button to temporarily delete the channel from the scan list:

- 1 While the radio is on the nuisance channel, hold down the **Scan** button until you hear a tone.
- 2 Release the **Scan** button. The nuisance channel is deleted.

Note: You cannot delete a priority channel or the last remaining channel in a scan list.

Restoring a Channel Back to the Scan List

To restore a previously deleted channel back to the scan list, restart the scan operation or turn your radio off and on again.

EDITING A SCAN LIST

















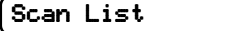

A scan list is a group of up to 16 channels. Each position on the **Channel Selector** knob can have a scan list assigned to it. The same channel can be included in several scan lists, and the same scan list can be assigned to several **Channel Selector** positions. For example:

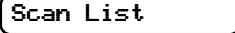





Position 2	Position 14
1	1
3	2
5	3
6	11

When you edit a scan list, you can either add, delete, or prioritize channels.

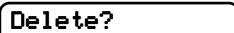
Your radio cannot receive any calls while you are editing a scan list. The symbol will be displayed while you are in edit mode.

To Add or Delete Channels in a Scan List

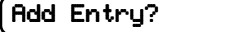
- 1  to enter Menu Mode.
- 2  or  until 
- 3  to select 
- 4  or  until 
- 5  to select 
- 6  or  until 
or until 
- 7  to confirm your selection.
- 8  or  until you see the channel you want to add or delete.
Note: You cannot delete the last remaining channel of a scan list.
- 9  to confirm your selection.

- 10 If you added a channel, you will see 
–or–
If you deleted a channel, you will see 
 to confirm the deletion, you will see 
- 11  to return to 
or to return to 
–or–
Hold down  to exit Menu Mode.

Prioritizing a Channel in a Scan List

You may want to check the activity on one or two channels more frequently than others. You can do this by prioritizing them:

Priority Channel	Scanning Sequence
None specified	Ch1 → Ch2 → Ch3 → Ch4 → ... Ch1

Priority Channel	Scanning Sequence
Channel 2 (Priority 1)	Ch2 → Ch1 → Ch2 → Ch3 → Ch2 → Ch4 → Ch2 → ... Ch1
Channel 2 (Priority 1) and Channel 8 (Priority 2)	Ch2 → Ch1 → Ch8 → Ch3 → Ch2 → Ch4 → Ch8 → ... Ch1

Note: Even if there is activity on a non-priority channel, your radio will automatically switch to an active priority channel and indicate the activity with a short tone.

Setting Priority Channels

- 1 to enter Menu Mode.
- 2 or until **Program Lists**
- 3 to select **Program Lists**
- 4 or until **Scan List**
- 5 to select **Scan List**

6 or until **Edit Priority?**

7 to select **Edit Priority?**

8 or until **Priority #1?**

or until **Priority #2?**

9 to select the desired priority level.

10 or until you see the channel you want to prioritize.

11 to prioritize that channel.

12 to return to **Edit Priority?**

–or–

Hold down to exit Menu Mode.

Notes: You cannot reprioritize a *Priority 1* channel to *Priority 2*.

If you want to reprioritize all channels, you must delete each priority channel from the scan list and add it back.

PHONE

If your radio has access to a telephone system, you can make a phone call. To do this, your radio must send an access code to a station that connects it to a phone line. (Ask your Motorola Representative for more details.) After completing a call, your radio must send a deaccess code to hang up.

MAKING A PHONE CALL ①

You can make a phone call by using the preprogrammed **Phone** button (see page 18) or the menu. ① will appear on the LCD screen when you are in Phone Mode.



To initiate a phone call:

Press the **Phone** Button,

–or–

Do the following:

1  to enter Menu Mode.

2  or  until

Phone

3  to select

Phone

- 4 You will hear a series of tones, indicating that an access code is being sent automatically, and see your access code;



–or–

enter your access code using the keypad.

- 5 When you hear a dial tone:

Enter the phone number using the keypad.

–or–

 or  to select a number from the phone list; then press the **PTT** button to send it.

–or–

- a Press and release the preprogrammed **Speed Dial** button (see page 18) to use the Speed Dial feature.
- b Press the key (1 to 9) corresponding to the number you want to call, or press “0” if you want to call the last number dialed.

Note: Press the **PTT** button, if required for your radio.

- 5 Note:** To redial the last number dialed (if not using Speed Dial), press and release the **PTT** button. The radio sends the last number dialed.

–or–

If you entered your access code using the keypad, press the  key once to access the last number dialed; then press and release the **PTT** button.

- 6** Hold the radio in a vertical position with the microphone 1 to 2 inches (2.5 to 5 cm) away from your mouth. Press and hold the **PTT** button to talk; release it to listen.



- 7** When you are finished with your phone call: Enter the deaccess code using the keypad.
–or–

If your radio has the deaccess code preprogrammed, go to step 8.

- 8** To end the phone call, do one of the following: Press the **Phone** button.
–or–

- 9**  to return to

Phone

–or–

Hold down  to exit Menu Mode.

MODIFYING THE PHONE LIST

You can modify a phone list in three ways:



- Add an entry
- Delete an entry
- Edit an existing entry

The  symbol will appear on the LCD screen when you are modifying the phone list.

Note: The radio cannot receive any calls while you are modifying the phone list.

To Add an Entry



- 1**  to enter Menu Mode.

- 2**  or  until

Program Lists

- 3**  to select

Program Lists

- 4**  or  until

Phone Lists

5 to select **Phone List**

6 or **P2** until **Add Entry?**

7 to select **Add Entry?**

you will see **Enter Name**

8 Use the keypad to enter the name (see page 19).

9 to store the name.
you will see **Enter Phone #**

10 Use the keypad to enter the phone number. You can also add a dash (press **P3**) and a Pause Indicator (hold down **#**) until the # character on the LCD screen changes to a "P".

11 to select the phone number.

12 or **P2** to store the number in a phone list location other than the one displayed.

13 to store the phone number.
you will see **Entry Saved**

14 to return to **Add Entry?**

–or–

Hold down to exit Menu Mode.

To Delete an Entry

1 to enter Menu Mode.

2 or **P2** until **Program Lists**

3 to select **Program Lists**

4 or **P2** until **Phone List**

5 to select **Phone List**

6 or **P2** until **Delete Entry?**

7 to select **Delete Entry?**

8 or **P2** until you see the entry you want to delete.

- 9 to select the entry.
you will see **Delete?**
- again to confirm the deletion.
you will see **System Scan**
- 10 to return to **System Scan**
-or-
Hold down to exit Menu Mode.

To Edit an Entry

- 1 to enter Menu Mode.
- 2 or **P2** until **Program Lists**
- 3 to select **Program Lists**
- 4 or **P2** until **Phone List**
- 5 to select **Phone List**
- 6 or **P2** until **Edit Entry?**
- 7 to select **Edit Entry?**

- 8 or **P2** until you see the entry you want to edit.

- 9 to select the entry.
- 10 or **P2** until **Edit Name?**
(to edit the name),
or until **Edit Number?**
(to edit the phone number),
or until **Edit Location?**
(to edit the location in the phone list).

- 11 to confirm your selection.
- 12 Use the keypad to edit the entry (see page 19).
-or-
 or **P2** until you see the location where you want to store the phone number.
- 13 to store the information.
- 14 to return to **Edit Entry?**
-or-
Hold down to exit Menu Mode.



AUDIO/TONE SETTINGS

You can customize the audio and tone feature settings on your radio by:



1  to enter Menu Mode.

2  or  until 

3  to select 

4  or  until you see the feature you want to change (see the table below).

5  to select the feature. You will see the feature's current setting.

6  or  for available settings. (For Name and Call Tone Tagging, see page 39.)

7  to select the desired setting.

Audio/Tone Settings

Feature	What it Does	Settings
Alert Vol Lvl	Makes the volume level of the audio and alert tones independent. These two volume levels can be adjusted independently.	Ind Alert Off Ind Alert On
Tone Disable	Turns all tones on or off.	Tones On Tones Off
Name Tone Tag	Assigns a specific ring tone when receiving a call from a specific user (see page 39 for details).	Standard Alert #1 - #7

Audio/Tone Settings (Continued)

Feature	What it Does	Settings
Call Tone Tag	Assigns a specific tone when receiving a specific type of radio call (see page 39 for details).	Standard Alert #1 - #7
Escalert	Increases the volume of the alarm tones when a call is not answered.	Escalert On Escalert Off
X-Pand	Provides the same audio quality for 12.5kHz channels as for 25kHz channels.	X-Pand On X-Pand Off
Keypad Tones	Turns keypad tones on or off.	Tones On Tones Off



UTILITIES

You can customize some of your radio's features by:



1  to enter Menu Mode.

2  or  until **Utilities**

3  to select **Utilities**

4  or  until you see the feature you want to change (see table below).

5  to select the feature. You will see the feature's current setting.

6  or  for available settings.

7  to select the desired setting.

Utilities Features

Feature	What it Does	Settings
Squelch	Sets radio squelch at either normal or tight (see page 37).	Sqclh Normal Sqclh Tight
Power Level	Changes the power level of the radio to high, low, or auto (see page 38).	Power High Power Low Power Auto

Utilities Features (continued)

Feature	What it Does	Settings
Clock	Sets the time, or turns the clock on or off (see page 53).	Clock On Clock Off Set Time?
Reminder Alarm	Sets the alarm, or turns it on or off (see page 53).	Alarm On Alarm Off Set Time?
Language Selection	Selects the language to be shown in your radio's displays.	English Spanish Portuguese French
Light Disable	Turns the display and keypad backlight feature on or off.	Lights On Lights Off
Software Ver #	Displays the radio's software version number when you press  .	—

SETTING THE TIME

To set the time:

1  to enter Menu Mode.

2  or  until 

3  to select 

4  or  until 

or until 

5  to confirm your selection.

6  or  until 

7  to select 

8 When a setting is blinking, you can change it with  or .

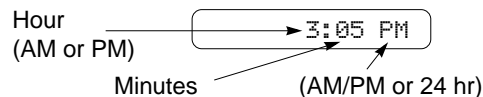

Note: You cannot select “24 hr” for **Reminder Alarm**.

9  to move to the next setting.

10  to save your changes.

11  to return to 

or to return to 

–or–

Hold down  to exit Menu Mode.

Notes

WARRANTY

LIMITED WARRANTY MOTOROLA COMMUNICATION PRODUCTS

I. WHAT THIS WARRANTY COVERS AND FOR HOW LONG:

MOTOROLA INC. (“MOTOROLA”) warrants the MOTOROLA manufactured Communication Products listed below (“Product”) against defects in material and workmanship under normal use and service for a period of time from the date of purchase as scheduled below:

EX600 Units	Three (3) Years
-------------	-----------------

Product Accessories	One (1) Year
---------------------	--------------

Motorola, at its option, will at no charge either repair the Product (with new or reconditioned parts), replace it (with a new or reconditioned Product), or refund the purchase price of the Product during the warranty period provided it is returned in accordance with the terms of this warranty. Replaced parts or boards are warranted

for the balance of the original applicable warranty period. All replaced parts of Product shall become the property of MOTOROLA.

This express limited warranty is extended by MOTOROLA to the original end user purchaser only and is not assignable or transferable to any other party. This is the complete warranty for the Product manufactured by MOTOROLA.

MOTOROLA assumes no obligations or liability for additions or modifications to this warranty unless made in writing and signed by an officer of MOTOROLA. Unless made in a separate agreement between MOTOROLA and the original end user purchaser, MOTOROLA does not warrant the installation, maintenance or service of the Product.

MOTOROLA cannot be responsible in any way for any ancillary equipment not furnished by MOTOROLA which is attached to or used in connection with the Product, or for operation of the Product with any ancillary equipment, and all such equipment is expressly excluded from this warranty. Because each system which may use the Product is unique, MOTOROLA disclaims liability for range, coverage, or operation of the system as a whole under this warranty.

II. GENERAL PROVISIONS:

This warranty sets forth the full extent of MOTOROLA'S responsibilities regarding the Product. Repair, replacement or refund of the purchase price, at MOTOROLA's option, is the exclusive remedy. THIS WARRANTY IS GIVEN IN LIEU OF ALL OTHER EXPRESS WARRANTIES. IMPLIED WARRANTIES, INCLUDING WITHOUT LIMITATION, IMPLIED WARRANTIES OF MERCHANTABILITY AND FITNESS FOR A PARTICULAR PURPOSE, ARE LIMITED TO THE DURATION OF THIS LIMITED WARRANTY. IN NO EVENT SHALL MOTOROLA BE LIABLE FOR DAMAGES IN EXCESS OF THE PURCHASE PRICE OF THE PRODUCT, FOR ANY LOSS OF USE, LOSS OF TIME, INCONVENIENCE, COMMERCIAL LOSS, LOST PROFITS OR SAVINGS OR OTHER INCIDENTAL, SPECIAL OR CONSEQUENTIAL DAMAGES ARISING OUT OF THE USE OR INABILITY TO USE SUCH PRODUCT, TO THE FULL EXTENT SUCH MAY BE DISCLAIMED BY LAW.

III. STATE LAW RIGHTS:

SOME STATES DO NOT ALLOW THE EXCLUSION OR LIMITATION OF INCIDENTAL

OR CONSEQUENTIAL DAMAGES OR LIMITATION ON HOW LONG AN IMPLIED WARRANTY LASTS, SO THE ABOVE LIMITATION OR EXCLUSIONS MAY NOT APPLY.

This warranty gives specific legal rights, and there may be other rights which may vary from state to state.

IV. HOW TO GET WARRANTY SERVICE:

You must provide proof of purchase (bearing the date of purchase and Product item serial number) in order to receive warranty service and, also, deliver or send the Product item, transportation and insurance prepaid, to an authorized warranty service location. Warranty service will be provided by Motorola through one of its authorized warranty service locations. If you first contact the company which sold you the Product (e.g., dealer or communication service provider), it can facilitate your obtaining warranty service. You can also call Motorola at 1-800-927-2744 US/Canada.

V. WHAT THIS WARRANTY DOES NOT COVER:

- A) Defects or damage resulting from use of the Product in other than its normal and customary manner.
- B) Defects or damage from misuse, accident, water, or neglect.
- C) Defects or damage from improper testing, operation, maintenance, installation, alteration, modification, or adjustment.
- D) Breakage or damage to antennas unless caused directly by defects in material workmanship.
- E) A Product subjected to unauthorized Product modifications, disassembles or repairs (including, without limitation, the addition to the Product of non-Motorola supplied equipment) which adversely affect performance of the Product or interfere with Motorola's normal warranty inspection and testing of the Product to verify any warranty claim.
- F) Product which has had the serial number removed or made illegible.
- G) Rechargeable batteries if:
 - 1) any of the seals on the battery enclosure of cells are broken or show evidence of tampering.
 - 2) the damage or defect is caused by charging or using the battery in equipment or service other than the Product for which it is specified.
- H) Freight costs to the repair depot.
- I) A Product which, due to illegal or unauthorized alteration of the software/firmware in the Product, does not function in accordance with MOTOROLA's published specifications or the FCC type acceptance labeling in effect for the Product at the time the Product was initially distributed from MOTOROLA.
- J) Scratches or other cosmetic damage to Product surfaces that does not affect the operation of the Product.
- K) Normal and customary wear and tear.

VI. PATENT AND SOFTWARE PROVISIONS:

MOTOROLA will defend, at its own expense, any suit brought against the end user purchaser to the extent that it is based on a claim that the Product or parts infringe a United States patent, and MOTOROLA will pay those costs and damages finally awarded against the end user purchaser in any such suit which are attributable to any such claim, but such defense and payments are conditioned on the following:

- A) that MOTOROLA will be notified promptly in writing by such purchaser of any notice of such claim;
- B) that MOTOROLA will have sole control of the defense of such suit and all negotiations for its settlement or compromise; and
- C) should the Product or parts become, or in MOTOROLA's opinion be likely to become, the subject of a claim of infringement of a United States patent, that such purchaser will permit MOTOROLA, at its option and expense, either to procure for such purchaser the right to continue using the Product or parts or to replace or modify the same so that it becomes non-infringing or to grant such purchaser a credit for the Product or parts as depreciated and accept its return. The depreciation will be an equal amount per year over the lifetime of the Product or parts as established by MOTOROLA.

MOTOROLA will have no liability with respect to any claim of patent infringement which is based upon the combination of the Product or parts furnished hereunder with software, apparatus or devices not furnished by MOTOROLA, nor will MOTOROLA have any liability for the use of ancillary equipment or software not furnished by MOTOROLA which is attached to or used in

connection with the Product. The foregoing states the entire liability of MOTOROLA with respect to infringement of patents by the Product or any parts thereof.

Laws in the United States and other countries preserve for MOTOROLA certain exclusive rights for copyrighted MOTOROLA software such as the exclusive rights to reproduce in copies and distribute copies of such Motorola software. MOTOROLA software may be used in only the Product in which the software was originally embodied and such software in such Product may not be replaced, copied, distributed, modified in any way, or used to produce any derivative thereof. No other use including, without limitation, alteration, modification, reproduction, distribution, or reverse engineering of such MOTOROLA software or exercise of rights in such MOTOROLA software is permitted. No license is granted by implication, estoppel or otherwise under MOTOROLA patent rights or copyrights.

VII. GOVERNING LAW:

This Warranty is governed by the laws of the State of Illinois, USA.

ACCESSORIES

Motorola offers a number of accessories to enhance the productivity of your two-way radio. Many of the available accessories are listed below. For a complete list, see your Motorola Representative.

CARRY CASES

HLN9985	Waterproof Bag
JMZN4020	Radio Handstrap
JMZN4023	Plastic Carry Holder with Swivel Belt Clip

AUDIO ACCESSORIES

JMMN4062	2 Wire Surveillance Earpiece.
JMMN4064	Ear Microphone VOX/PTT Radio Interface Module
JMMN4066	Lightweight Headset with Boom Microphone and in-line PTT
JMMN4073	Remote Speaker Microphone

BATTERIES

JMNN4023	1000 mAH Li-Ion High Capacity Battery
JMNN4024	1320 mAH Li-Ion Ultra High Capacity Battery

CHARGERS

AAHTN3000	120V Single-Unit Rapid Charger, US Plug
AAHTN3003	120V Multi-Unit Rapid Charger, US Plug

Note: You must use the "C" version multi-charger or newer to be compatible with the EX600 model.

ANTENNAS

PMAD4012	VHF 136-155 MHz, 9cm, Stubby
PMAD4013	VHF 155-174 MHz, 9cm, Stubby
PMAD4014	VHF 136-155 MHz, 14cm, Standard
PMAD4015	VHF 155-174 MHz, 14cm, Standard
PMAD4023	VHF 150-161 MHz, 14cm
PMAD4025	VHF 150-161 MHz, 9cm
PMAE4002	403-433 MHz, Stubby
PMAE4003	433-470 MHz, Stubby
NAE6483	403-520 MHz, Whip
PMAE4006	UHF 470-510 MHz, 9cm, Helical
PMAE4007	UHF 490-527 MHz, 9cm
PMAE4008	UHF 470-530 MHz, Whip

Menu Navigation Chart

(Refer to Menu Navigation guidelines—
lower, left-hand corner of this page)

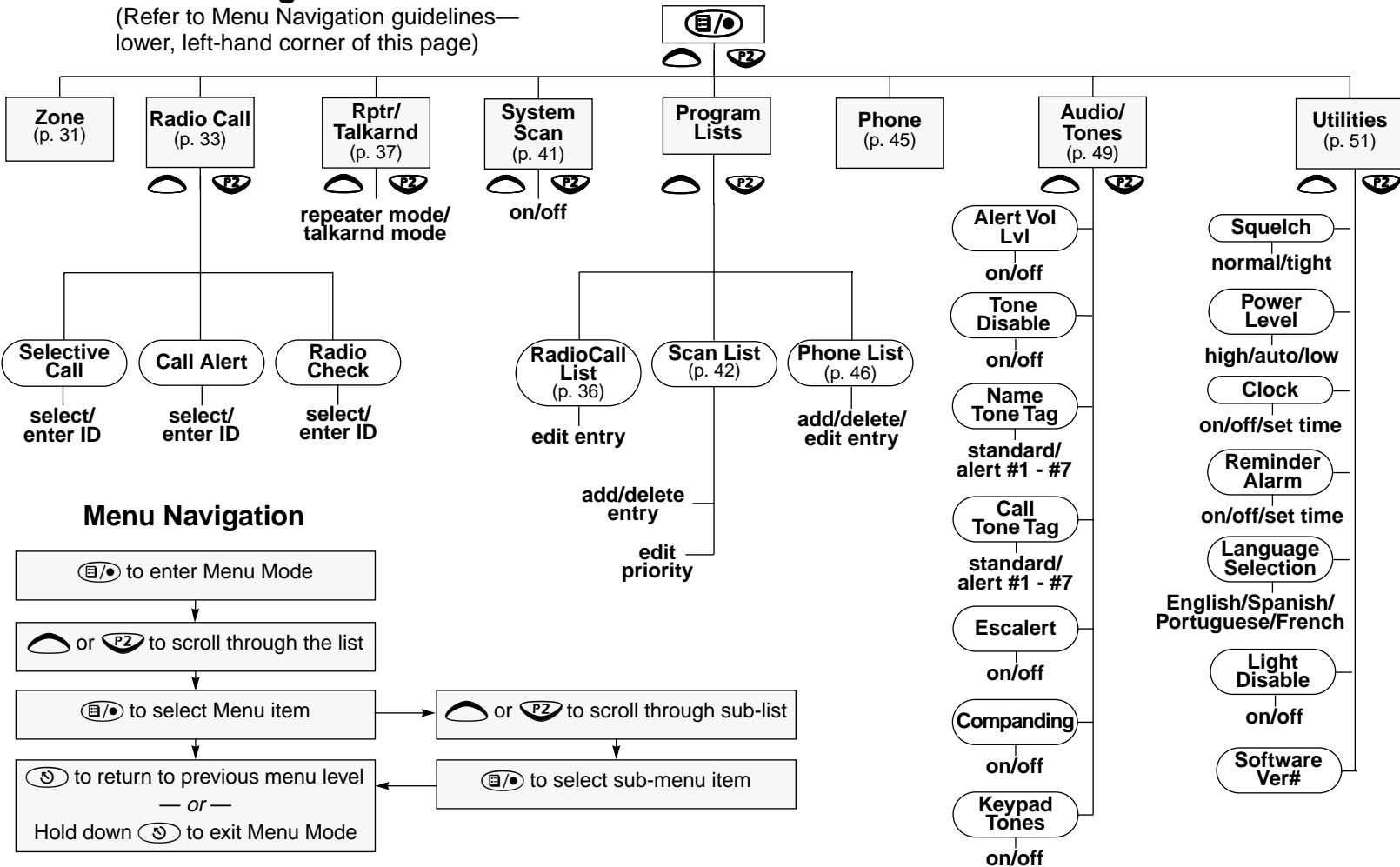

Motorola, the stylized M logo are trademarks of Motorola, Inc.
® Reg. U.S. Patent & Trademark Office. All other product or
service names are the property of their respective owners.
© 2001 Motorola, Inc. All rights reserved. Printed in U.S.A.

Motorola, le logo stylisé M sont des marques de commerce de
Motorola, Inc. MD Marque déposée. U.S. Patent & Trademark
Office. Tous les autres noms de produits ou services
appartiennent à leurs propriétaires respectifs.
© 2001 Motorola, Inc. Tous droits réservés. Imprimé aux États-Unis.



68P81094C70-O

Free Manuals Download Website

<http://myh66.com>

<http://usermanuals.us>

<http://www.somanuals.com>

<http://www.4manuals.cc>

<http://www.manual-lib.com>

<http://www.404manual.com>

<http://www.luxmanual.com>

<http://aubethermostatmanual.com>

Golf course search by state

<http://golfingnear.com>

Email search by domain

<http://emailbydomain.com>

Auto manuals search

<http://auto.somanuals.com>

TV manuals search

<http://tv.somanuals.com>