



**Professional Series
Two-Way Radio User Guide**











**Séries professionnelles
Guide de l'utilisateur de radio bidirectionnelle**

HT1250•LS+ VHF/UHF

CONTENTS

Computer Software Copyrights	4	Push-to-Talk (PTT) Button	12
Safety	5	Microphone	12
Product Safety and RF Exposure		Menu Keys	12
Compliance	5	Keypad Keys	13
Battery Information	5	Display	15
Charging Batteries	5	Programmable Buttons	16
Introduction	7	Audio Indicators for Programmable Buttons	22
Trunked Radio Systems	7	Getting Started	23
PassPort® Trunked Systems	7	Battery Information	23
LTR® Trunked Systems	7	Charging the Battery	23
Conventional Radio Systems	8	Battery Charge Status	24
HT1250•LS+ Radio Features	8	Attaching the Battery	25
Radio Wide Features	8	Removing the Battery	25
PassPort Zone Features	8	Accessory Information	26
LTR Zone Features	9	Attaching the Antenna	26
Conventional Zone Features	9	Removing the Antenna	26
Radio Overview	11	Attaching the Belt Clip	27
Parts of your Radio	11	Removing the Belt Clip	27
HT1250•LS+ Models	11	Attaching the Side Connector Cover	28
On/Off/Volume Knob	12	Turning your Radio On or Off	28
Zone Selector Knob	12	Adjusting the Volume	29
LED Indicator	12	Selecting a Trunked Zone and Talkgroup	29
		Sending a Trunked Call	29

Selecting a Conventional Zone and Channel	30	PassPort Signaling	43
Sending a Conventional Call	30	Selective Call	43
Receiving a Trunked or Conventional Call	31	Sending a Selective Call using the Preprogrammed Button	43
Repeater or Talkaround → Mode	31	Sending a Selective Call through the Menu	43
Call Light	32	Sending a Selective Call using the One-Touch Button	45
Home Channel Revert	32	Receiving a Selective Call 🎵	46
PassPort Trunking	33	Call Alert	47
Seamless Roaming	33	Sending a Call Alert using the Preprogrammed Button	47
Initial Registration	33	Sending a Call Alert through the Menu	47
Roaming and Registering between Sites	34	Sending a Call Alert using the One-Touch Button	48
Site/MIN View	35	Receiving a Call Alert 🎵	49
PTT ID Alias	36	Radio Calls	51
Roam Request	36	Making a Selective Call	51
Home Site Revert	37	Receiving a Selective Call 🎵	52
Roam Lock	38	Sending a Call Alert Page	53
To Activate Roam Lock	38	Receiving a Call Alert Page 🎵	54
To Deactivate Roam Lock	39	Radio Check	55
PassPort Primary Talkgroup	39	Sending a Status	55
Site / Talkgroup Restriction	39	Sending a Message	56
Site Restriction	40	Receiving a Message	57
Group Restriction	41		
Troubleshooting	41		

Sending an Emergency Alert 	57	Receiving a Phone Call  through a	
(Conventional and LTR modes Only)	57	Trunked or Conventional System	74
Editing a Radio Call List 	58	Modifying the Phone List 	74
Name and Call Tone Tagging	59	Voice Storage	77
Scan	61	Incoming Call Recording	78
Talkback	61	Selective Incoming Call Recording	78
PassPort Primary Auto Group Scan	61	All Incoming Call Recording	78
PassPort Group Scan 	62	Voice Memo Recording	79
Auto Group Scan 	63	Recorded Message Playback	81
All Group Scan 	63	Recorded Message Delete	82
System Scan 	64	Recorded Message Transmission	83
Deleting a Nuisance Channel or		Automatic Message Reply:	
Talkgroup	65	“When Available”	83
Editing a Scan List	66	Audio/Tone Settings	85
View a Scan List	67	Utilities	87
Adding or Deleting Talkgroups or		Setting Tight or Normal Squelch	90
Channels in a Scan List	67	Setting the Power Level 	90
Prioritizing a Talkgroup or Channel		Setting the Clock or Alarm	91
in a Scan List	68	Warranty	93
Phone	71	Limited Warranty	93
Making a Phone Call  through a		Accessories	99
Trunked System	71	Carry Accessories	99
Making a Phone Call  through a		Carry Cases	99
Conventional System	72	Chargers	99

Headsets and Accessories	100
Microphones	101
Ear Microphone System	101
Integrated Microphone/Receiver	101
Earpiece	102
Adapters	103
Batteries	103
Antennas	104

COMPUTER SOFTWARE COPYRIGHTS

The Motorola products described in this manual may include copyrighted Motorola computer programs stored in semiconductor memories or other media. Laws in the United States and other countries preserve for Motorola certain exclusive rights for copyrighted computer programs, including, but not limited to, the exclusive right to copy or reproduce in any form the copyrighted computer program. Accordingly, any copyrighted Motorola computer programs contained in the Motorola products described in this manual may not be copied, reproduced, modified, reverse-engineered, or distributed in any manner without the express written permission of Motorola. Furthermore, the purchase of Motorola products shall not be deemed to grant either directly or by implication, estoppel, or otherwise, any license under the copyrights, patents or patent applications of Motorola, except for the normal non-exclusive license to use that arises by operation of law in the sale of a product.

SAFETY

PRODUCT SAFETY AND RF EXPOSURE COMPLIANCE



Caution

Before using this product, read the operating instructions for safe usage contained in the Product Safety and RF Exposure booklet enclosed with your radio.

ATTENTION!

This radio is restricted to occupational use only to satisfy FCC RF energy exposure requirements. Before using this product, read the RF energy awareness information and operating instructions in the Product Safety and RF Exposure booklet enclosed with your radio (Motorola Publication part number 68P81095C98) to ensure compliance with RF energy exposure limits.

For a list of Motorola-approved antennas, batteries, and other accessories, visit the following web site which lists approved accessories:

<http://www.motorola.com/cgiss/index.shtml>.

BATTERY INFORMATION

Charging Batteries

This product is powered by a nickel-cadmium (NiCd), nickel-metal-hydride (NiMH), or lithium-ion rechargeable battery. Charge the battery before use to ensure optimum capacity and performance. The battery was designed specifically to be used with a Motorola charger. Charging in non-Motorola equipment may lead to battery damage and void the battery warranty.

Note: When charging a battery attached to a radio, turn your radio off to ensure a full charge.

The battery should be at about 77°F (25°C) (room temperature), whenever possible. Charging a cold battery (below 50°F [10°C]) may result in leakage of electrolyte and ultimately in failure of the battery. Charging a hot battery (above 95°F [35°C]) results in reduced discharge capacity, affecting the performance of your radio. Motorola rapid-rate battery chargers contain a temperature-sensing circuit to ensure that batteries are charged within the temperature limits stated above.

Notes

INTRODUCTION

Welcome to Motorola's HT Series family of radio users. This user guide supports HT1250•LS+™ radios. These radios combine the very latest in two-way technology while delivering outstanding functionality at the touch of a button.

HT1250•LS+ portable radios operate on UHF/VHF PassPort, LTR Trunked, and Conventional radio systems.

Contact your Motorola dealer for a list of features available with your radio.

TRUNKED RADIO SYSTEMS

Trunked systems allow a large number of users to share a relatively small number of frequencies or repeaters without interfering with each other. The airtime of all the repeaters in a Trunked system is pooled, which maximizes the amount of airtime available to any one radio and minimizes channel congestion.

PassPort® Trunked Systems

PassPort is an enhanced trunking protocol developed by Trident Micro Systems that

supports wide-area dispatch networking. A network is formed by linking several Trunked sites together to form a single system. This offers users an extended communication coverage area. In addition, users with PassPort-enabled radios can seamlessly roam among all sites within the network. Seamless roaming means that you do not have to manually change the zones on your radio when roaming from site to site.

LTR® Trunked Systems

LTR is a transmission-based trunking protocol developed by the E. F. Johnson Company for primarily single-site trunking applications. In transmission trunking, a repeater is used only for the duration of a single transmission. Once a transmission is completed, that repeater becomes available to other users. This means that a conversation comprised of many transmissions may occur over several different channels within the LTR system. This method of trunking provides system efficiency by making repeaters available to all users after every transmission.

CONVENTIONAL RADIO SYSTEMS

Conventional radio systems typically refer to unit-to-unit communications through a single channel. Conventional systems also allow radio users to extend communication coverage by relaying their messages through a repeater. To ensure coordinated use by multiple talkgroups, each radio user must monitor the channel or repeater before transmitting to verify that the system is not currently busy.

HT1250•LS+ RADIO FEATURES

Note: Throughout this manual there are features listed as Trunked and Conventional. **Trunked** indicates the feature functions in both PassPort and LTR zones unless otherwise noted. **Conventional** indicates the feature functions in Conventional zones only.

Radio Wide Features

- 14-Character Alphanumeric Display
- 7 Programmable Feature Buttons
- Up to 15 PassPort and/or LTR Zones with up to 16 Talkgroups per Zone

- Up to 16 or 32 Conventional Channels (depending on model capability)
- X-Pand™ Audio Enhancement
- Home Channel Revert
- Telephone Interconnect
- User-programmable Phone and Scan Lists
- Voice Storage Capability

PassPort Zone Features

- Unique Mobile Identification Number (MIN) per radio
- Unique Electronic Serial Number (ESN) per radio
- Registration/Deregistration upon Power-up and Power-down
- Automatic Seamless Roaming between Networked Sites
- Site/Talkgroup Restriction
- Optional Primary Talkgroup
- Primary Talkgroup Transmit Inhibit
- Registered Site and Mobile Identity View
- User-initiated Roam Request
- Primary Auto Group Scan and PassPort Group Scan
- Roam (Site) Lock
- Push-To-Talk (PTT) ID Aliasing

- NTIA Band Support (403-420 MHz) including 9 MHz Rx/Tx Separation in both 25 KHz and 12.5 KHz channel spacing.*
- Call Signalling Features
 - PTT ID Alias or MIN (Display of Mobile Identification Number or Alias if preprogrammed in the radio.)
 - Selective Call
 - Call Alert

LTR Zone Features

- MDC-1200 Signaling
 - Call Alert
 - Selective Call
 - Emergency Alert*
 - Message*
 - Status*
 - Selective Radio Inhibit
 - Radio Check
 - PTT-ID
 - Call List Name/Call Tone Tagging
- Auto Group System and All Group Scan
- System Scan with 2 Priority Levels

Conventional Zone Features

- MDC-1200 Signaling**
 - Call Alert
 - Selective Call
 - Emergency Alert
 - Message
 - Status
 - Selective Radio Inhibit
 - Radio Check
 - PTT-ID
 - Call List Name/Call Tone Tagging
- Monitor and Sticky Permanent Monitor
- System Scan with two Priority Levels

* Only supported in UHF Band I (403-470 MHz) HT1250•LS+ Radios

**Not available in all models. Please check with your dealer for feature availability.

Notes

RADIO OVERVIEW

PARTS OF YOUR RADIO

HT1250•LS+ Models

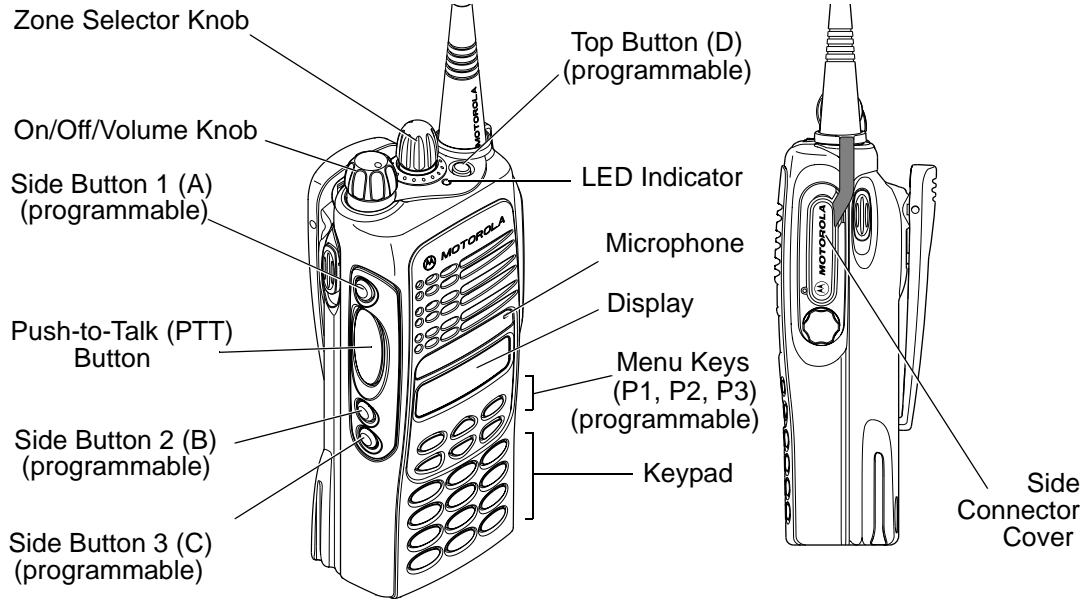

On/Off/Volume Knob

Turns your radio on or off, and adjusts your radio's volume.

Zone Selector Knob

Switches your radio to different Trunked and Conventional zones. It is also used to scroll through menu choices in Menu mode.

LED Indicator

Indicates battery status (see page 24); or the status of power-up, scan, or receipt of a talkgroup or selective call as shown below:

LED Color	Indicates
Steady red	Your radio is transmitting (PTT button pressed).
Flashing red	Your radio is attempting to access a Trunked system (PTT button pressed), or Your radio is receiving (PTT button released).
Double flashing yellow	Call Light feature activated, or Individual Selective Call received (Trunked operation only).

LED Color	Indicates
Single flashing yellow	Group Selective Call received (Trunked operation only). Individual Selective Call or Call Alert (PassPort operation only).
Momentary green	Your radio has powered up successfully.
Double flashing green	System or All Group Scan operation, or PassPort Group Scan.

Push-to-Talk (PTT) Button

Press and hold down this button to talk; release it to listen.

Microphone

When sending a message, hold the microphone 1 to 2 inches (2.5 to 5 centimeters) away from your mouth, and speak clearly into it.

Menu Keys

Exit



Left



Up



Down



Menu/Select



Right





Menu/Select Key 

Used to enter Menu mode. When in Menu mode, also used to make menu selections.

Exit Key 

Used to move to the previous menu level (short press) or to exit Menu mode (long press).

Up Key  and **Down Key** 

- Used to scroll through the preprogrammed talkgroups of a selected Trunked zone, or through Conventional channels in a Conventional zone.
- Used to scroll when in Menu mode.
- The  key can also be programmed to activate a radio feature (see page 16).

Right Key 

Moves the cursor right or inserts a space when editing Call, Scan, and Phone lists. This key can also be programmed to activate a radio feature (see page 16).

Left Key 

Used as a backspace key when editing Radio Call, Scan, and Phone lists. This key can also be programmed to activate a radio feature (see page 16).

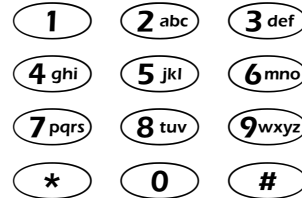
Keypad Keys

These keys are used to:

- Dial a phone number
- Enter a specific radio ID number when making a Selective Call or Call Alert
- Enter information when programming Radio Call, Scan and Phone lists

Each key can generate several different characters. For example, to enter the character “C,” press the  key three times. (Refer to the table on the following page.)





Entering Characters Using the Keypad

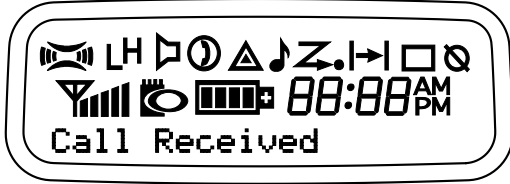

Key	Number of Times Key is Pressed														
	1	2	3	4	5	6	7	8	9	10	11	12	13	14	15
0	0	()	< >												
1	1	&	%	#	*										
2 abc	A	B	C	2	a	b	c	2	Á Ç	à á ç					
3 def	D	E	F	3	d	e	f	3	È É Ê	è é ê					
4 ghi	G	H	I	4	g	h	i	4	Í Ì	í					
5 jkl	J	K	L	5	j	k	l	5							
6 mno	M	N	O	6	m	n	o	6	Ñ Ó Ô	ò ó ô ö					
7 pqrs	P	Q	R	S	7	p	q	r	s	7					
8 tuv	T	U	V	8	t	u	v	8	Ú Û	ú					
9 wxyz	W	X	Y	Z	9	w	x	y	z	9	Ý	ý			
*	*	/	+	-	=										
#	#	Blank Space	-	.	!	?	'	”	,	;	:				





Display

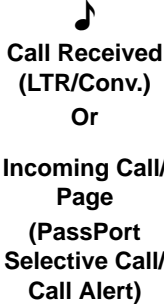





The top two screen rows display menu and radio status information:

Symbol	Indication
	The X-Pand feature is activated. When in narrow band, this feature improves audio quality.
	Low Power "L" or High Power "H" is activated.
	The selected channel is being monitored (Conventional operation only).
	Phone mode is selected.

Symbol	Indication
	An Emergency Siren is being sounded or an Emergency Alarm is being sent.
	A Selective Call or Call Alert has been received (LTR trunked and Conventional operation only). A Selective Call or Call Alert has been transmitted or received. Flashing icon indicates call attempt in progress, while a solid icon indicates that the call has been established (PassPort operation only).
	When the green LED is blinking, it indicates that the System, PassPort Scan, or All Group Scan feature has been activated. When the green LED is off, it indicates that non-prioritized Auto Group Scan has been activated.

Symbol	Indication
 Priority 1 Scan (● flashing)	Indicates activity on a Priority 1 talkgroup or channel during System Scan.
 Priority 2 Scan (● steady)	<ul style="list-style-type: none"> When the green LED is on, it indicates activity on a Priority 2 talkgroup or channel during System Scan. When the green LED is off, it indicates prioritized Auto Group Scan has been activated.
 Talkaround	You are not transmitting through a repeater (Conventional operation only).
 Programming Mode	A Program list is being edited.
 Keypad Lock	The keypad is locked.

Symbol	Indication
 Battery Level	The number of bars (0–4) shown indicates the charge remaining in your battery.
 Clock	Shows the time (12- or 24-hour).
 Signal Strength	The more bars, the stronger the signal being received by your radio.
 PassPort Zone	A PassPort zone has been selected.

Programmable Buttons

Your dealer can program several of your radio's buttons as shortcuts to many of your radio's features.

Programmable buttons include:

- The three Side Buttons (A, B, C) and the Top Button (D)
- The three Lower Menu Keys (P1, P2, P3) (when your radio is not in Menu mode)

Each button can be programmed to access up to two features, depending on the type of button press:

- **Short Press**—quickly pressing and releasing the programmable buttons,
—or—
- **Long Press**—pressing and holding the programmable buttons for a period of time (programmable for 1/2 to 1 1/2 seconds),
—or—
- **Hold Down**—pressing and holding down the programmable buttons while checking status or making adjustments.

The table on page 18 summarizes the programmable features available along with the page number where the feature is explained.

Ask your dealer to write down, in the “Button” column, the names of the programmable buttons next to the features that have been programmed to them. Your dealer can use the abbreviations shown in the radio illustration on page 11 of this use guide (for example, A for Side Button 1, D for Top Button, etc.). Your dealer can also indicate whether the button press is short press (SP) or long press (LP) where applicable.

Contact your dealer for a complete list of features available with your radio.

Programmable Features

Feature	Indicator	Short Press	Long Press	Hold Down	Page	Button
Battery Gauge	LED Color	—	—	Check the battery's charge status.	24	
Edit Scan List	—	Add, delete or prioritize talkgroups and channels.			66	
Emergency ^{‡†}	▲	Initiate Emergency Alert	Cancel Emergency Alert	—	57	
Home Channel Revert	—	Directly access your favorite Trunked zone and talkgroup or Conventional channel. [†]		—	32	
Keypad Lock	⊘	—	Toggle the keypad between locked and unlocked.	—	—	
Light	—	Turn on your radio's backlight. [†]		—	—	
Message ^{‡§}	—	Direct entry to the Message menu. [†]		—	56	
Monitor [§]	▶	Exit Permanent Monitor mode.	Enter Permanent Monitor mode.	Continually monitor channel	—	
Phone	📞	Directly access Phone mode. [†]		—	72	

[†] This feature is activated by **EITHER** a short **OR** a long press, but not both.

[§] Conventional operation only. [‡]LTR Trunked operation only. *PassPort Trunked operation only.

Programmable Features

Feature	Indicator	Short Press	Long Press	Hold Down	Page	Button
Power Level	LH	Toggle the transmit power level between high and low.†		—	90	
Radio Call‡§	LED Color	Directly access the Radio Call menu.†		—	51	
Member Call †§	—	Directly access one of the first 3 members of your Radio Call List.		—	51, 53	
Speed Call †§	—	Display last entry called. †		—	51, 53	
Repeater/Talkaround§	→	Toggle between using a Conventional repeater or transmitting directly to another radio.†		—	31	
Roam Request*	Searching	Manually initiate PassPort roaming function.†	Stop PassPort roaming function.	—	36	
Home Site Revert*	Searching	Turn Home Site Revert on.†		—	37	
Roam Lock*	—	Turn Roam Lock on or off.†		—	38	
Selective Call* (Preprogrammed Button)	LED Color	Send a Selective Call.†		—	43	

† This feature is activated by **EITHER** a short **OR** a long press, but not both.

§ Conventional operation only. ‡LTR Trunked operation only. *PassPort Trunked operation only.

Programmable Features

Feature	Indicator	Short Press	Long Press	Hold Down	Page	Button
Selective Call* (One-Touch Button)	—	Directly access the Radio Call List.†		—	45	
Call Alert* (Preprogrammed Button)	LED Color	Send a Call Alert†		—	47	
Call Alert* (One-Touch Button)	—	Directly access the Radio Call List.†		—	48	
Scan/Delete Nuisance Channel		Turn PassPort Group, All Group, and System scan on or off.	Delete a nuisance channel while scanning.	—	65	
Site/MIN View*	—	Display the PassPort site number on which the unit is registered, the Home Site and unit's Mobile Identification Number (MIN).†		—	35	
Speed Dial	—	Quickly access the speed dial phone list.†		—	73	
Squelch§	—	Toggle the squelch level between tight and normal.†		—	90	
Status‡§	—	Directly access the Message menu.†		—	55	

† This feature is activated by **EITHER** a short **OR** a long press, but not both.

§ Conventional operation only. ‡LTR Trunked operation only. *PassPort Trunked operation only.

Programmable Features

Feature	Indicator	Short Press	Long Press	Hold Down	Page	Button
Voice Storage Record/ Playback	—	Playback recorded messages.	Record voice memos.	—	81	
Voice Storage Playback Exit	—	Exit Voice Storage Play Back mode.†		—	81	
Voice Storage Playback Delete	—	Delete recorded messages.†		—	82	
Volume Set	—	—	—	Sound a tone to adjust your radio's volume level.	29	

† This feature is activated by **EITHER** a short **OR** a long press, but not both.

§ Conventional operation only. ‡LTR Trunked operation only. *PassPort Trunked operation only.

AUDIO INDICATORS FOR PROGRAMMABLE BUTTONS

In addition to having visual indicators, some programmable buttons use tones to indicate one of two modes:



High-Low Tone



Low-High Tone

Button	High-Low Tone	Low-High Tone
Scan	Stop scan	Start scan
Power Level	High power selected	Low power selected
Squelch (no visual indicator)	Normal squelch	Tight squelch
Keypad Lock	Unlocked	Locked
Repeater/ Talkaround	Uses Conventional repeater	Does not use Conventional repeater

GETTING STARTED

BATTERY INFORMATION

Charging the Battery

If a battery is new or its charge level is very low, you need to charge it before use.

Note: Batteries are shipped uncharged from the factory. Always charge a new battery 14 to 16 hours before initial use, regardless of the status indicated by the charger.

To charge the battery, place the battery, with or without the radio, in the charger. The charger LED indicates the charging progress:

LED Color	Battery/Charger Status
No LED indication	Battery inserted incorrectly.
Single green flash	Successful charger power-up.
Flashing red*	Battery is not chargeable or not making proper contact.
Steady red	Battery in rapid-charge mode.

LED Color	Battery/Charger Status
Flashing yellow	Battery in charger, not in rapid-charge mode but waiting to be charged.
Flashing green [†]	Battery 90% (or more) charged.
Steady green	Battery fully charged.







* Remove the battery from the charger. Clean the battery contacts with isopropyl alcohol applied to a soft cloth. Place the battery back in the charger. If the LED indicator continues to flash red, replace the battery.

† A standard battery may require one hour to charge to 90%.

Battery Charge Status

You can check your battery's charge status in two ways:

- The charge status is shown by the  status indicator symbol on the display. This symbol is shown automatically.
- Hold down the preprogrammed **Battery LED Indicator** button (see page 16). The charge status is shown by the color of your radio's LED indicator.

Battery Level	LED Indicator	Status Indicator 
High	Green	
Sufficient	Yellow	 or 
Low	Flashing red	
Very Low	None	 (flashing)

Battery chargers will only charge the Motorola-authorized batteries listed below. Other batteries may not charge.

Part No.	Description
HNN9008	1500 mAH NiMH High-Capacity Battery (standard)
HNN9009	1900 mAH NiMH Ultra-High-Capacity Battery
HNN9010	1800 mAH NiMH, Ultra-High-Capacity - Factory Mutual
HNN9011	1200 mAH Ni-CD, High-Capacity Battery - Factory Mutual
HNN9012	1300 mAH Ni-CD High-Capacity Battery
HNN9013	1200 mAH Lithium Ion Battery
HPNN4045	1200 mAH NiMH, 7.5 V Battery
HNN4001	Impres™ 1900 mAH NiMH, 7.5 V Battery
HNN4002	Impres™ 1800 mAH NiMH, 7.5 V Battery - Intrinsically Safe (FM)
HNN4003	Impres™ 2000 mAH Li-ion, 7.5 V Battery

Attaching the Battery

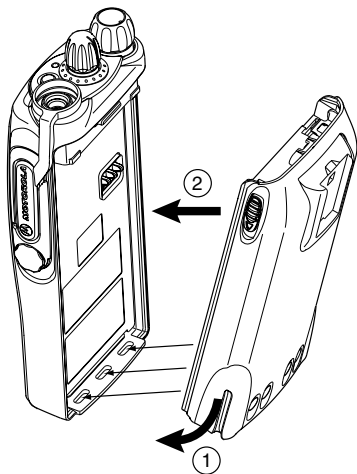

- 1 Fit the extensions at the bottom of the battery into the bottom slots on your radio.
- 2 Press the top part of the battery toward your radio until you hear a click.

Removing the Battery

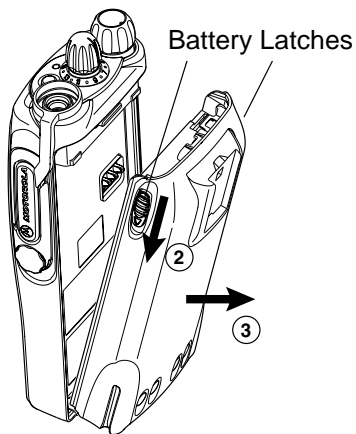

- 1 Turn off your radio (see page 28).
- 2 Slide both battery latches downward.
- 3 Pull the top part of the battery away from your radio.

ACCESSORY INFORMATION

Attaching the Antenna

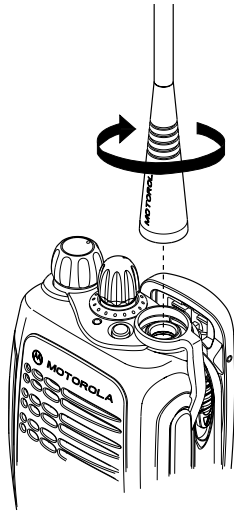

Turn the antenna clockwise to attach it.

Removing the Antenna

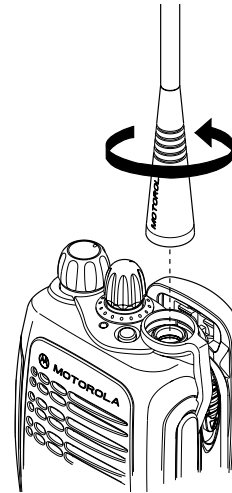

Turn the antenna counterclockwise to remove it.

Attaching the Belt Clip

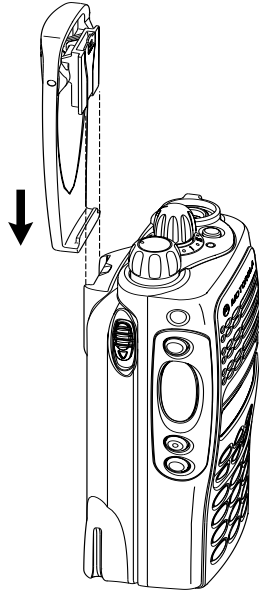

- 1 Align the grooves of the belt clip with those of the battery.
- 2 Press the belt clip downward until you hear a click.

Removing the Belt Clip

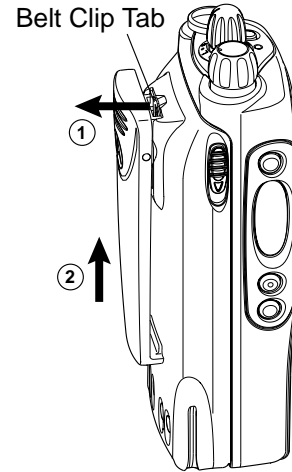

- 1 Use a key to press the belt clip tab away from the battery.
- 2 Slide the belt clip upward to remove it.

Attaching the Side Connector Cover

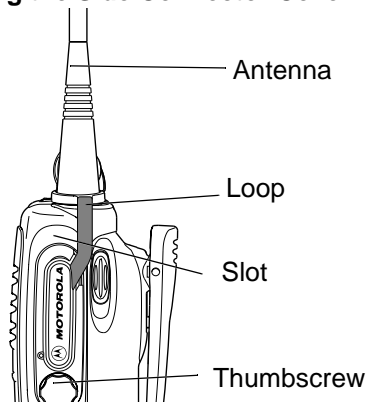

- 1 Place the loop (attached to the side connector cover) over the antenna; then slide it downward until it touches the top of the radio.
- 2 Insert the tab on the top of the cover into the slot above the connector.
- 3 Position the cover over the connector and align the thumbscrew with the threaded hole in the radio.
- 4 Tighten the thumbscrew to hold the cover in place. **Do not overtighten the thumbscrew.**

TURNING YOUR RADIO ON OR OFF

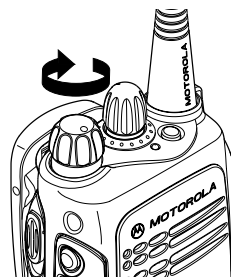

ON

Turn the **On/Off/Volume** knob clockwise. If power-up is successful, you hear a Self-Test Pass Tone



and see the LED momentarily turn green.

If your radio fails to power up, you hear a Self-Test Fail Tone

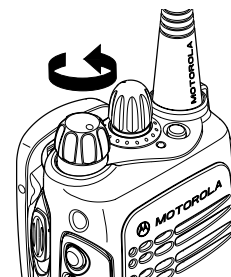
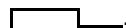

OFF

Turn the **On/Off/Volume** knob counterclockwise until you hear a click.

ADJUSTING THE VOLUME

Turn the **On-Off/Volume Control** knob clockwise to increase the volume or counterclockwise to decrease the volume.



—or—

- 1 Hold down the **Volume Set** button (see page 21); you hear a continuous tone.
- 2 Turn the **On-Off/Volume Control** knob to the desired volume level.
- 3 Release the **Volume Set** button.

SELECTING A TRUNKED ZONE AND TALKGROUP

Up to 15 PassPort and/or LTR trunked zones (containing 16 talkgroups each) can be programmed into your radio.

To select a Trunked zone and Talkgroup:

- 1 Use the **Zone Selector** knob to select the appropriate Trunked zone.
- 2  or  until you see the desired preprogrammed talkgroup on the display.

Note: The display shows  (the PassPort Zone symbol) when a PassPort Zone is selected.

SENDING A TRUNKED CALL

To send a Trunked call:

- 1 Hold your radio in a vertical position at a distance of about 1 to 2 inches (2.5 to 5 centimeters) from your mouth.



- 2 Press and hold the **PTT** button.

–or–

Press and release the **PTT** button and wait three seconds.

- If access to the Trunked system is successful, the LED indicator lights steady red.

In addition, your dealer can program your radio to sound a short, high-pitched (talk permit) tone, indicating successful Trunked system access.

- If access to the Trunked system was unsuccessful, the LED indicator flashes red and a low-pitched (talk prohibit) tone sounds, indicating that the system was busy or out of range.

- 3 With the **PTT** button depressed, speak clearly into the microphone.

- 4 Release the **PTT** button to listen.

You will see the Alias (if preprogrammed) or MIN of the calling radio on your radio's display.

SELECTING A CONVENTIONAL ZONE AND CHANNEL

Up to a total of 16 conventional channels, in one or more conventional zones, can be programmed into your radio as follows:

- 1 Use the **Zone Selector** knob to select the appropriate Conventional zone.
- 2  or  until you see the desired Conventional channel on the display.

SENDING A CONVENTIONAL CALL

Note: In the United States, FCC regulations require you to monitor the Conventional channels before sending a call. The Monitor feature (see page 16) can be accessed through one of your programmable buttons (if programmed by your dealer).

- 1 Hold your radio in a vertical position at a distance of about 1 to 2 inches (2.5 to 5 centimeters) from your mouth.



- 2 Press the **PTT** button and speak clearly into the microphone. The LED indicator lights steady red while the call is being sent.
- 3 Release the **PTT** button to listen.

RECEIVING A TRUNKED OR CONVENTIONAL CALL

- 1 Turn your radio on.
- 2 Adjust your radio's volume (see page 29).
- 3 Use the **Zone Selector** knob to select the desired Trunked or Conventional zone. Make sure the **PTT** button is released.
- 4 Listen for voice activity. The LED indicator flashes red when your radio is receiving.

Note: The Mobile Identification Number (XXXX) or Alias (if preprogrammed) of the calling radio appears on the display if Caller ID is enabled.

XXXX

REPEATER OR TALKAROUND |→| MODE

Note: This feature is available only with Conventional operation.

Talkaround mode enables you to communicate with another radio when:

- The repeater is not operating
—or—
- Your radio is out of the repeater's range, but within communicating distance of another radio.



Note: The display shows |→| when Talkaround mode is selected.

To select Repeater or Talkaround mode:

Press the preprogrammed **Repeater/Talkaround** button (see page 16) to toggle between Repeater and Talkaround mode.

—or—



1  to enter Menu mode.

2  or  until

Rptr/Talkarnd

3  to select

Rptr/Talkarnd

4  or  until



or until



5  to confirm your selection.

CALL LIGHT

(TRUNKED OPERATION ONLY)

The Call Light indicator informs you that you have received a call from a specified talkgroup (as programmed by your dealer). The yellow LED indicator will flash continuously, indicating that a Trunked call has been received.

To turn the Call Light off, do one of the following:

- Press the **PTT** button.
- Select another Trunked or Conventional zone.
- Press any preprogrammed button.
- Turn your radio off, and then on again.

HOME CHANNEL REVERT

The Home Channel Revert feature allows you to instantly access your favorite Trunked talkgroup or Conventional channel at the touch of a button.

To activate Home Channel Revert:

Press the preprogrammed **Home Channel Revert** button (see page 18).

PASSPORT TRUNKING

PassPort® is an enhanced, wide-area trunking protocol developed by Trident Micro Systems. Up to 128 Trunked sites can be linked together to form one PassPort system, which means that your communications can extend far beyond the reach of a single trunked site.

SEAMLESS ROAMING

PassPort Trunking systems offer you the ability to seamlessly roam among all sites in a network. Seamless Roaming means that you do not have to manually change the zones on your radio when roaming from site to site. As you roam throughout a PassPort System's coverage area, your HT1250•LS+ radio regularly monitors the RSSI (Received Signal Strength Indication) level of the site on which you are currently registered. In addition, if the signal strength falls below the acceptable threshold preprogrammed by your dealer, your radio starts monitoring the RSSI level of adjacent sites within the network. This allows the HT1250•LS+ radio to quickly roam to the site with the strongest signal, which provides

you with optimal audio quality throughout your communications.

Initial Registration

Your HT1250•LS+ radio needs to register on the PassPort system before communication with your talkgroup can begin. Registration automatically takes place upon radio power up or after selecting the desired PassPort zone on the selector knob unless your radio is Site Restricted from that site or Group Restricted from that talkgroup. What you see:

- 1 Upon radio Power up, you see:
(if you select a PassPort zone after your radio has powered up, see step 2).

A rectangular display box with rounded corners and a thin black border, containing the word "PassPort" in a bold, sans-serif font.

- 2 The display shows the selected **PassPort Zone Alias** (if preprogrammed).

A rectangular display box with rounded corners and a thin black border, containing the text "ZONE ALIAS" in a bold, sans-serif font.

- 3 The display shows the selected **Talkgroup Alias** (if preprogrammed).

TLKGRP ALIAS

Note: If your radio performs a more extensive frequency search in order to attempt registration, you may see:

SEARCHING

- 4 Upon successful PassPort Registration, you see:

REG SITE XXX

Note: Your radio sounds a “Low-High” tone upon successful PassPort System registration. XXX is a number that indicates the site within the PassPort system on which you have registered.

- 5 After successfully registering to a site, the selected PassPort talkgroup alias appears and remains on the display.

TLKGRP ALIAS

Roaming and Registering between Sites

Once initial registration with the PassPort system has occurred, your radio constantly monitors the RSSI to ensure an acceptable signal level is maintained (as programmed by your dealer). When the RSSI in your radio falls below this acceptable level, your HT1250•LS+ radio attempts to roam to and register onto another site within the PassPort system. This process happens automatically and requires no action on your part. What you see:

- 1 When your radio is searching for a new site or attempting successful registration to a site, or if the radio roams to a restricted site, you see:

SEARCHING

Note: This message is displayed until registration occurs. For more information about site restriction, please contact your dealer.

- 2 When your radio has successfully registered to a new site in the PassPort System, XXX indicates the site number you see:

REG SITE XXX

Note: You will not see this if your radio is Site Restricted from the site it is trying to access.

- 3 The selected PassPort talkgroup alias appears and remains on the display.

TLKGRP ALIAS

Note: If the radio is set to a restricted talkgroup, you see:

GrpRestrict

For more information about Site and Group Restriction, see page 39.

SITE/MIN VIEW

There may be circumstances when you want to view the number of the PassPort site on which you are registered as well as your Mobile Identification Number (MIN) of your HT1250•LS+ radio.

To Start and Stop Viewing Site/MIN:

- 1 Press the preprogrammed **SITE/MIN View** button (see page 16).

The display shows the number of the site on which you are currently registered.

site now XXX

Note: If the preprogrammed button is activated prior to or during registration, a bad key chirp is sounded and you see

site now n/a

The display indicates the Home Site ID (HSID) and Mobile Identification Number (MIN). XXX indicates the HSID, YYYYY indicates the MIN.

IAM XXX-YYYYY

Note: This message can still be activated even if your radio is not registered.

PTT ID ALIAS



Your HT1250•LS+ radio supports the display of the Alias of the calling radio when receiving a group dispatch call in PassPort mode. This Alias corresponds to the MIN of the calling radio in the Radio Call List.

Note: Alias will be displayed only if preprogrammed in the radio via the PassPort Customer Programming Software (PPCPS). Otherwise, the MIN is displayed.

ROAM REQUEST

Since your radio has the RSSI feature, your HT1250•LS+ radio automatically roams to an affiliated site when the signal from the registered site becomes too weak for quality communication. This RSSI threshold is programmed by your dealer. However, if you believe the signal strength would be better on another site, you may want to manually initiate the roaming process. This feature is called Roam Request.

To Start a Roam Request:

- 1 Press the preprogrammed **Roam Request** button (see page 16).
- 2 When your radio is searching for a new site or attempting registration to a site, you see: 
- 3 When your radio has successfully registered to the new site on the PassPort System, you see: 

—or—

A bad key chirp may sound and you see:

Roam Not Avail

This can occur under the following circumstances:

- When registration to a site with a higher RSSI than your current site is unavailable.
- When the preprogrammed button is pressed before your radio has collected its “neighbor list”. A “neighbor list” is a list of frequencies from adjoining sites within the PassPort system that are used during the roam process.
- When your radio is programmed for a single site system (Home Site only).

In these cases, wait a few seconds and try again.

- 4 The selected PassPort talkgroup alias appears and remains on the display.

TLKGRP ALIAS

To Cancel a Roam Request:

Press and hold the preprogrammed **Roam Request** button (see page 19) again.

You see:

Cncl Roam Req

Note: Your radio then attempts to return to the previously registered site.

HOME SITE REVERT

This feature allows you to force a HT1250•LS+ radio to search for its home site and register on it while the radio is currently registered on an affiliated site.

- 1 Press the preprogrammed **Home Site Revert** button (see page 19).
- 2 When the radio is searching for a new site or attempting registration to a site, you see:

SEARCHING

3 When the radio has successfully registered to its PassPort home site, you see:

REG SITE XXX

- The radio sounds a “Low-High” tone upon successful PassPort System registration. The XXX number indicates the site within the PassPort system on which you have registered.

Note: If the radio is already registered on its home site and Home Site Revert is initiated, a bad key chirp is sounded.

4 After successfully registering on the home site, the selected PassPort talkgroup alias appears and remains on the display.

TLKGRP ALIAS

Notes:

- The radio must currently be registered on an affiliated site.
- If the radio cannot register to its Home Site for any reason, the radio reverts back to its current affiliated site.

ROAM LOCK

Because of the RSSI (Received Signal Strength Indication) feature, the HT1250•LS+ radio automatically roams to a different site when the signal falls below the RSSI level programmed in your radio by your dealer. In some instances (inside a building or in fringe areas), you may want to prevent your radio from roaming. This is possible by enabling the Roam (Site) Lock function.

Note: If you are currently on an affiliated site and wish to lock onto your home site, you need to first press the preprogrammed Home Site Revert button prior to pressing the preprogrammed Roam Lock button.

To Activate Roam Lock

- 1 Press the preprogrammable **Roam Lock** button (see page 19).

2 You see.

TLKGRP ALIAS

Alternating with:

Roam Locked

at one second intervals.

- A good key chirp is heard.

Note: A radio can be roam-locked only when it is registered to a site.

To Deactivate Roam Lock

To cancel Roam Lock, either press the preprogrammable **Roam Lock** button again *or* turn off your radio *or* switch zones/talkgroups. Your radio automatically re-registers onto the PassPort system.

Note: Once deactivated, the radio follows the roaming criteria programmed in the radio.

PASSPORT PRIMARY TALKGROUP

This is the first talkgroup preprogrammed in your list. Per definition, it always has the

highest-level priority among all other preprogrammed talkgroups, also called secondary talkgroups. As such, any transmission on the primary talkgroup is heard on all other idle talkgroups regardless of where the radio is registered (home or affiliated sites). In addition, a user can respond to a call on the primary talkgroup simply by pressing the **PTT** button within a preprogrammed period of time.

If you prefer to use the primary talkgroup for “announcement” calls, you can disable the transmit function. In addition, if you do not have a need for a primary talkgroup, it is possible to disable the level of priority of this talkgroup in the programming software.

Note: Please contact your local dealer for additional information.

SITE / TALKGROUP RESTRICTION (Access Privileges by MIN)

The HT1250•LS+ portable radio offers two “access privilege” features called Site and Talkgroup Restriction. These features, however, can only be enabled or disabled through the PassPort infrastructure (if the

Access Privileges by MIN option is available). These features allow the radio to register and operate normally on the home site and on specific affiliated sites or talkgroups which are not restricted as programmed at the infrastructure level by the system operator.

Note: All sites except the Home Site can be site and/or talkgroup restricted.

Site Restriction

The registration and roaming process is unaffected for "non-restricted" radios. However, when a radio is site-restricted from a certain affiliated site in the system, it is prohibited from registering on that site and immediately tries to register to its home site. If the radio is unable to register on the home site, the radio moves on to the next frequency (in its neighbor list of sites) and attempts to register there.

What you see:

For 3 seconds:

SiteRestrict

then:

Until successful registration to its home site or a non-restricted affiliated site.

Searching

–or–

If the radio does not support this feature or the system does not receive an acknowledgement message from the radio. You see:

Disabled

Note: If your radio is disabled, power it down and contact your local dealer.

For additional information about site/talkgroup restriction, please contact your local dealer.

Group Restriction

The registration and roaming process is unaffected for "non-restricted" radios. However, when a radio is talkgroup-restricted from all unrestricted affiliated sites in the system (except the home site where it is always available), it is not able to register on that talkgroup. In this case you have to either switch talkgroups within the same site or roam to the home site (via the Home Site Revert feature) or initiate a Roam Request to a different talkgroup on an affiliated site.

You see:

GrpRestrict

If you subsequently initiate a roam request to the home site or to a different talkgroup on an affiliated site, you see:

Searching

TROUBLESHOOTING

While in PassPort zones, your radio may display specific messages to indicate you should contact your dealer for assistance.

Message	What it Means
"Invalid Group ID"	Your dealer needs to verify talkgroup programming in your radio or the PassPort system.
"DISABLED"	Your radio requires reactivation on the PassPort system (not applicable to Conventional and LTR functionality).
Blank display upon power up with a fully charged battery.	Your radio needs to be returned to your dealer for reactivation or service.

Notes:

PASSPORT SIGNALING

Selective Call and Call Alert are available in the HT1250•LS+ radio using the PassPort protocol. As such, no third party can hear the conversation of two users engaged in a Selective Call. Selective Call and Call Alert are mutually exclusive. If one of the users is engaged in a Selective Call or Call Alert while roaming to a different site, the Selective Call or Call Alert will end.

SELECTIVE CALL

You can initiate a Selective Call to a particular radio in three different ways:

- Using a preprogrammed button.
- Through the menu.
- Using the One-Touch button.

Sending a Selective Call using the Preprogrammed Button

- Press the preprogrammed **Selective Call** button (see page 19). Proceed to Step 4.

–or–

Sending a Selective Call through the Menu

1  to enter menu mode.



2  or  until 

3  to select 

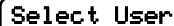

- The LED indicator lights a steady yellow.
- The display shows  and the preprogrammed alias or ID of the last active Selective Call is displayed.

4 If the unit has not been engaged in a Selective Call after power-up, you see:



 or  to locate the desired alias or ID in the Radio Call List.

–or–

 or  then press the first letter of the desired alias using the DTMF keys to start an alphabetical search. (Full keypad model only.)

–or–

Enter the ID number of the radio you wish to call. (Full keypad model only.)

–or–

Press * and the DTMF key (0 to 9) (if programmed by your dealer) corresponding to the radio you wish to call.

Note: This option does not require you to press the **PTT** button to send the Selective Call.

- 5 Press the **PTT** button to send the Selective Call.
 - While the Selective Call is being established the  blinks and the LED indicator flashes red momentarily.
 - A talk permit tone sounds.

- 6 Once the Selective Call is received and acknowledged by the target radio, the  displays solid.

Notes:

- If the Selective Call cannot be established, you see:

No Acknowledge

 for 5 seconds. The LED indicator turns off.
- If all channels are busy while attempting a Selective Call,

you see:

System Busy

and will hear a delayed busy tone as long as the **PTT** button is pressed.

If the **PTT** button is kept pressed and the system frees up a channel, the radio automatically attempts to re-establish the call.

-  to end the Selective Call and revert to talkgroup dispatch, or press the pre-programmed Selective Call button. You can then manually re-initiate the call. (See Step 1.)

7 Press the **PTT** button to talk; release to listen.

8  to end the Selective Call.

Note: If the Selective Call has prematurely ended,

you see: 



and a tone sounds (if preprogrammed by your dealer).

Sending a Selective Call using the One-Touch Button

1 Press and hold the preprogrammed **One-Touch** button.

- The LED indicator lights a steady yellow.
- The display shows  and the preprogrammed alias or ID is displayed.

2 The Selective Call is sent automatically.

- 3
- While the Selective Call is being established the  blinks and the LED indicator flashes red momentarily.
 - Once the Selective Call is established the  displays solid.

Notes:

- If preprogrammed by your dealer, your radio sounds a short high-pitched tone (call established tone) to indicate that you are ready to engage in a conversation.
- If the Selective Call cannot be established,

you see: 

for 5 seconds. The LED indicator turns off.

- If all channels are busy while attempting a Selective Call,

you see: 

and will hear a delayed busy tone as long as the **PTT** button is pressed.

If the **PTT** button is kept pressed and the system frees up a channel, the radio automatically attempts to re-establish the call.

-  to end the Selective Call and revert to talkgroup dispatch, or press the preprogrammed Selective Call button. You can then manually re-initiate the call. (See Step 1.)

4 Press the **PTT** button to talk; release to listen.

5  to end the Selective Call.

Note: If the Selective Call has prematurely ended,

you see:

Call Ended

and a tone sounds (if preprogrammed by your dealer).

Receiving a Selective Call

1 When you receive a Selective Call:

- The  blinks and, if preprogrammed by your dealer, the LED indicator lights steady yellow.

You see:

Incoming Call

followed by the preprogrammed alias or ID of the calling radio.

- Once the Selective Call is established the  displays solid.

Note: If preprogrammed by your dealer, your radio sounds a short high-pitched tone (call established tone) to indicate that you are ready to engage in a conversation.

2 To answer the Selective Call, press the **PTT** button to talk; release to listen.

3  to end the Selective Call.

Note: If the Selective Call has prematurely ended,

you see:

Call Ended

and a tone sounds (if preprogrammed by your dealer).

CALL ALERT

You can alert another person by sending a Call Alert to a particular radio in three different ways:

- Using a preprogrammed button.
- Through the menu.
- Using the One-Touch button.

Sending a Call Alert using the Preprogrammed Button

- Press the preprogrammed **Call Alert** button (see page 20). Proceed to Step 4.

Sending a Call Alert through the Menu

1  to enter menu mode.



2  or  until 

3  to select 



- The LED indicator lights a steady yellow.
- The display shows  and the preprogrammed alias or ID of the last active Call Alert is displayed.

- 4 If the unit has not been engaged in a Call Alert after power-up, you see:



 or  to locate the desired alias or ID in the Radio Call List.

–or–

 or  then press the first letter of the desired alias using the DTMF keys to start an alphabetical search. (Full keypad model only.)

–or–

Enter the ID number of the radio you wish to page. (Full keypad model only.)

–or–

Press * and DTMF key (0 to 9) (if programmed by your dealer) corresponding to the radio you wish to page.

Note: This option does not require you to press the **PTT** button to send the Call Alert.

- 5 Press the **PTT** button to send the Call Alert.
- While the Call Alert is being established the 🎵 blinks and the LED indicator flashes red momentarily.

- 6 Once the Call Alert is received and acknowledged by the target radio, the 🎵 displays solid and you see:

Acknowledge

Notes:

- If the Call Alert cannot be established, you see: **No Acknowledge** for 5 seconds. The LED indicator turns off.
- If all channels are busy while attempting a Call Alert, you see: **System Busy**

and will hear a delayed busy tone as long as the **PTT** button is pressed.

If the **PTT** button is kept pressed and the system frees up a channel, the radio automatically attempts to re-establish the call.

- 📞 to end the Call Alert and revert to talkgroup dispatch, or press the preprogrammed Call Alert button. You can then manually re-initiate the call. (See Step 1.)

- 7 📞 to end the Call Alert.

Sending a Call Alert using the One-Touch Button

- 1 Press and hold the preprogrammed **One-touch** button.
 - The LED indicator lights steady yellow.
 - The display shows 🎵 and the preprogrammed alias or ID is displayed.
- 2 The Call Alert is sent automatically.

- The LED indicator lights steady red.

Note: Your radio sounds a continuous tone (if programmed by your dealer).

- 3
- While the Call Alert is being established the 🎵 blinks and the LED indicator flashes red momentarily.
 - Once the Call Alert is established the 🎵 displays solid.

Notes:

- If preprogrammed by your dealer, your radio sounds a short high-pitched tone (page established tone) to indicate that the page was successful.

If the Call Alert cannot be established,

you see:

No Acknowledge

for 5 seconds. The LED indicator turns off.

- If all channels are busy while attempting a Call Alert,

you see:

System Busy

and will hear a delayed busy tone as long as the **PTT** button is pressed.

If the **PTT** button is kept pressed and the system frees up a channel, the radio automatically attempts to re-establish the call.

-  to end the Call Alert and revert to talkgroup dispatch, or press the preprogrammed Call Alert button. You can then manually re-initiate the call. (See Step 1.)

4  to end the Call Alert.

Receiving a Call Alert 🎵

1 When you receive a Call Alert:

- The 🎵 blinks and, if preprogrammed by your dealer, the LED indicator lights steady yellow.

You see:

Incoming Page

followed by the preprogrammed alias or ID of the calling radio.

- Once the Call Alert is established the  displays solid.

Note: If preprogrammed by your dealer, your radio sounds a short high-pitched tone (page established) to indicate that the page was successful.

- 2 To answer the Call Alert, press the **PTT** button to talk; release to listen.

- 3  to end the Call Alert.

RADIO CALLS

Note: Available in LTR and Conventional modes only based on model feature set of your HT1250•LS+ radio. Please check with your dealer.

In LTR Trunked mode, Radio Call features are available only if the system is available.

MAKING A SELECTIVE CALL

You can make a Selective Call to a particular radio or to a group of radios, as programmed by your dealer.

To Make a Selective Call

Press the preprogrammed Radio Call button (see page 19), and proceed to step 4 on page 52.

—or—

- 1 Press the preprogrammed **Member Call** button corresponding to the member you wish to call.

You see:

Name xxxx

alternating with:

Selective Call

Note: For DTMF radio models, if you press any digit on the keypad (#1-9), the display shows the corresponding entry from the Radio Call List.

- 2 Proceed to step 7 on page 52.

—or—

- 1 Press the preprogrammed **Speed Call** button.

You see the Alias (if preprogrammed) or ID of the last called entry.

Name xxxx

Note: For DTMF radio models, if you press any digit on the keypad (#1-9), the display shows the corresponding entry from the Radio Call List.

- 2 Proceed to step 7 on page 52.

–or–

1  to enter Menu mode.



2  or  until **Radio Call**

3  to select **Radio Call**

4  or  until **Selective Call**

5  to select **Selective Call**

The LED lights a steady yellow

6  or  to locate the desired ID in the Radio Call list.

–or–

Enter the ID number of the radio you want to call (full keypad models only).

7 Press the **PTT** button to send the call.

- Your radio sounds a continuous tone (if programmed by your dealer) and the LED lights a steady red.

8 Press the **PTT** button and talk; release the **PTT** button to listen.

9  to return to

–or–

Selective Call

Hold down  to exit Menu mode.

RECEIVING A SELECTIVE CALL

When you Receive a Selective Call

- The display shows  and the preprogrammed name or ID of the calling radio.
- The LED flashes yellow (if programmed by your dealer).
- You hear an alert tone.

To answer the call, press the **PTT** button.

Note: In LTR Trunked mode, unless you make a Selective Call back to the caller within the preprogrammed time, your response is heard by all members of your talkgroup.

SENDING A CALL ALERT PAGE

You can alert another person by sending a Call Alert page.

To Send a Call Alert Page

Press the preprogrammed Radio Call button (see page 19) and proceed to step 4:

–or–

- 1 Press the preprogrammed **Member Call** button corresponding to the member you wish to call.

You see:

Name xxxx

alternating with:

Call Alert

Note: For DTMF radio models, if you press any digit on the keypad (#1-9), the display shows the corresponding entry from the Radio Call List.

- 2 Proceed to step 7 on page 54.

–or–

- 1 Press the preprogrammed **Speed Call** button.

You see the Alias (if preprogrammed) or ID of the last called entry.



Name xxxx

Note: For DTMF radio models, if you press any digit on the keypad (#1-9), the display shows the corresponding entry from the Radio Call List.

- 2 Proceed to step 7 on page 54.

–or–



- 1  to enter Menu mode.

- 2  or  until

Radio Call

- 3  to select

Radio Call



- 4  or  until

Call Alert

- 5  to select

Call Alert

The LED lights a steady yellow.

6  or  to locate the desired ID in the Radio Call list.

–or–

Enter the ID number of the radio you want to page.

7 Press the **PTT** button.

The display alternately shows

Call In Prog

and the preprogrammed name or ID.

The LED lights a steady yellow and then flashes red every time your radio attempts to transmit the call.

8 If the Call Alert page is received by the target radio, you see

Acknowledge

If the page was not received, you see

No Acknowledge

The radio sounds a short alert tone.

9  to return to
–or–

Call Alert

Hold down  to exit Menu mode.

RECEIVING A CALL ALERT PAGE

When you receive a Call Alert Page:

- The display shows  **Call Received** and the preprogrammed name or ID of the calling radio.
- You hear four alert tones, either once or continuously, as programmed by your dealer.
- The LED flashes a single yellow for a group call, or flashes a double yellow for an individual call.









To answer the page, press the **PTT** button; to cancel the page, press any other key.

Note: Your radio displays only the last Call Alert page received. In addition, your radio does not receive any future Selective Calls until you clear the page.

RADIO CHECK

Radio Check allows you to determine if a radio is within the range of the Trunked or Conventional system and turned on, without disturbing the user of that radio. This feature can also be used when attempts with Selective Call and Call Alert fail.

To perform a Radio Check:

- 1  to enter Menu mode.
- 2  or  until **Radio Call**
- 3  to select **Radio Call**
- 4  or  until **Radio Check**
- 5  to select **Radio Check**
- 6  or  to locate the desired ID in the Radio Call list.
-or-
Enter the ID number of the radio you are checking.
- 7 Press the **PTT** button.

You see

Call In Prog

- 8 If the Radio Check is received by the target radio, you see **Acknowledge**

If the Radio is not received,
you see

No Acknowledge

- 9  to return to
-or-



Radio Check

Hold down  to exit Menu mode.



SENDING A STATUS

This feature gives you the ability to send a status update to the base. The Status feature makes more efficient use of the channel compared to voice transmissions. Your dealer can program your radio with status updates of up to 14 characters.

To send a Status:

- 1  to enter Menu Mode.
- 2  or  until **Status**

3  to select **Status**

4  or  to locate the desired status in the preprogrammed list.

–or–

when using the enhanced keypad microphone only, enter the number of the status you wish to send.

–or–

if programmed by your dealer (see page 20), press the button that has been preprogrammed for a specific status.

Note: You cannot retransmit the current status update.

5 Press the **PTT** button.

You see: **Update In Prog**

Note: If the radio is not able to send the status or does not receive an acknowledgement if one is expected, you see **No Acknowledge**

If the radio is not able to send the status and no acknowledgement is expected, you see **No Channel**

SENDING A MESSAGE



This feature gives you the ability to send and receive preprogrammed messages. Data messages make more efficient use of channels compared to voice transmissions. Your dealer can program your radio with messages of up to 14 characters.

To send an Electronic (Data) Message:

1  to enter Menu mode.

2  or  until **Message**

3  to select **Message**

- 4  or  to locate the desired message in the preprogrammed list.

–or–

when using the enhanced keypad microphone only, enter the number of the message you wish to send.

–or–

if programmed by your dealer (see page 18), press the button that has been preprogrammed for a specific message.

Note: You cannot re-transmit the current message update.

- 5 Press the **PTT** button.

You see

Msg In Prog

Note: If the radio is not able to send the message or the radio does not receive an acknowledgement if an one is expected,

you see

No Acknowledge

If the radio is

not able to send the message and no acknowledgement is expected, you see

No Channel

RECEIVING A MESSAGE

When your radio receives a message:

- You hear two alert tones.
- The yellow LED indicator flashes.
- The display alternately

shows

Msg Received

and the preprogrammed alias.

Note: If you receive a message that is not programmed into your radio, the display alternately shows the following:

Message #_

No Alias

SENDING AN EMERGENCY ALERT



(CONVENTIONAL AND LTR MODES ONLY)

In the event of an emergency, you may need to quickly get the attention of others for help. The Emergency Alert feature, if programmed by your dealer, causes your radio to send a priority Emergency Alert (see page 18) to a specific radio or dispatch center.

The display shows  when your radio is in the Emergency Alert state.

Note: In Conventional mode, Emergency Alerts have priority over all other calls.

An Emergency Alert can be programmed to do one of the following:

- show  and sound a tone
–or–
- show  (silent Emergency)
–or–
- activate the microphone so that all activity can be transmitted (for a predetermined amount of time).

To activate Emergency Alert, press the preprogrammed **Emergency** button.

To cancel Emergency Alert, press and hold the preprogrammed **Emergency** button, or press the **PTT** button.



EDITING A RADIO CALL LIST

Your radio has a Radio Call list that contains the names and radio IDs of several talkgroups or individuals. The ID numbers in the Radio Call List are programmed by your dealer, and cannot be changed from your radio. However, you can edit the names associated with these IDs. The display shows  when you are editing.

Note: The radio cannot receive any calls while you are editing.

To edit a Call List entry:

1  to enter Menu mode.

2  or  until

Program Lists

3  to select



Program Lists

4  or  until

RadioCall List

5  to select

RadioCall List

6  or  until

Edit Entry?

7 to select

Edit Entry?

8 or until you locate the desired entry.

9 to select the entry.

10 Use your keypad to edit the entry (page 13).

11 to save your changes.

Entry Saved

12 to return to

Edit Entry?

–or–

Hold down to exit Menu mode.

NAME AND CALL TONE TAGGING

You can program your radio to sound a particular alert tone when a specific user is calling (name tone tagging), or when receiving a particular type of radio call (call tone tagging).

Note: Name and call tone tagging are valid only for Selective Calls and Call Alerts.

You can select from seven tones (see page 86).

To tag a specific User's Name:

1 to enter Menu mode.

2 or until

Audio/Tones

3 to select

Audio/Tones

4 or until

Name Tone Tag

5 to select

Name Tone Tag

6 or until you see the name you want to tag.

7 to confirm the selection.

8 or until you see and hear the tone you want to use for this name.

9 to confirm the selection.

You see

Name Tag Set

10 to return to

Name Tone Tag

–or–

Hold down to exit Menu mode.

To tag a Type of Radio Call:



1  to enter Menu mode.

2  or  until **Audio/Tones**



3  to select **Audio/Tones**

4  or  until **Call Tone Tag**

5  to select **Call Tone Tag**

6  or  until you see the call type you want to tag.

7  to confirm the selection.

8  or  until you see and hear the tone you want to use for this type of call.

9  to confirm the selection.

You see **Call Tone Set**

10  to return to **Call Tone Tag**

–or–

Hold down  to exit Menu mode.

SCAN

Your radio is equipped with the Scan feature, which allows you to search for, lock onto, and monitor voice activity on Trunked talkgroups and Conventional channels.

There are up to five types of Scan available in HT1250•LS+ models. The table below summarizes the Scan types available with each model.

Zone	PassPort Primary Auto Scan	Pass-Port Group Scan	LTR Auto Group Scan	LTR All Group Scan	System Scan
PassPort Trunked	X	X			
LTR Trunked			X	X	X
Conventional					X

"X" indicates that this type of Scan can be enabled through a programmable button (see page 16) or through your radio menu.

TALKBACK

When activity is detected during any type of scan, scanning stops and the active talkgroup or channel appears and remains on the display until scanning resumes. Your dealer can program the amount of time you can respond (or "TALKBACK") to the caller before your radio resumes scanning.

You must press the **PTT** button to participate in the call; otherwise, your radio continues to scan other talkgroups or channels.

PASSPORT PRIMARY AUTO GROUP SCAN

(PASSPORT TRUNKED OPERATION ONLY)

PassPort Primary Auto Group Scan automatically scans the primary (first) talkgroup within the selected PassPort zone. Any time you are positioned on a PassPort talkgroup other than the first one, your radio automatically scans activity on the first talkgroup within that zone.

Note: This feature is automatically enabled in your radio and not through the radio menu or through a preprogrammed scan button.

PASSPORT GROUP SCAN

(PASSPORT TRUNKED OPERATION ONLY)

PassPort Group Scan scans talkgroups within the selected PassPort Trunked zone, as programmed by your dealer. Up to 16 different talkgroups can be programmed into each Scan list, with one Scan list assigned to each position on the **Zone Selector** knob. You can edit these Scan lists through your radio's menu (see page 66).

When PassPort Group Scan is enabled:

- The  symbol appears on the display.
- The LED indicator blinks green during PassPort Group Scan operation; it stops blinking when your radio switches to an active talkgroup or channel.

Note: PassPort Group Scan is not available when registered on an affiliated (non-home) site.

If you switch to another PassPort zone, LTR, or Conventional zone while your radio is scanning, scanning resumes upon return to the PassPort zone where PassPort Group Scan was enabled.

If your radio is turned off while scanning, the radio resumes scanning when you turn it back on. If your radio registers on a non-home site, scanning is not enabled until your radio registers at its home site.

To start PassPort Group Scan operation:

Press the preprogrammed **Scan** button (see page 16).

To stop PassPort Group Scan operation:

Press the preprogrammed **Scan** button again.

To start or stop PassPort Group Scan operation through the menu:

1  to enter Menu mode.

2  or  until 

3  to select 

You see the current scan status.

4  or  until 

-or-



5  to confirm your selection.

AUTO GROUP SCAN

(LTR TRUNKED OPERATION ONLY)

Auto Group Scan automatically scans talkgroups within an LTR Trunked zone as programmed by your dealer. Auto Group Scan can be non-prioritized or prioritized:



- Non-prioritized Auto Group Scan automatically scans all talkgroups programmed with Auto Group Scan.
- Prioritized Auto Group Scan automatically scans the selected talkgroup and all lower four-numbered talkgroups. For example, if Talkgroups 1, 3, and 4 have been programmed by your dealer with Auto Group Scan and Talkgroup 4 is selected,

your radio automatically scans talkgroups 1, 3, and 4, and skips Talkgroup 2.

To start Auto Group Scan:

Select a talkgroup that has been programmed for Auto Group Scan by your dealer.

Note: You do not have to press a preprogrammed **Scan** button.

- The display shows  when non-prioritized Auto Group Scan has been activated.
- The display shows  when prioritized Auto Group Scan has been activated.
- The LED indicator does not light up during Auto Group Scan.

To stop Auto Group Scan:

Select a talkgroup that has not been programmed for Auto Group Scan by your dealer.

ALL GROUP SCAN

(LTR TRUNKED OPERATION ONLY)

With All Group Scan, your radio scans all talkgroups within the selected LTR Trunked zone.

When All Group Scan is enabled:

- The display shows **Z** .
- The LED indicator blinks green; it stops blinking when your radio switches to an active talkgroup.

Note: If you enter Menu mode while your radio is scanning, scanning stops. The radio resumes scanning when you exit Menu mode.

To start All Group Scan, press the preprogrammed All Group Scan button (see page 16) once.

To stop All Group Scan, press the preprogrammed All Group Scan button again.

–or–



To start or stop All Group Scan Operation through the menu:

1  to enter Menu mode.

2  or  until **All Group Scan**

3  to select **All Group Scan**

You see the current scan status.

4  or  until

All Group On?

–or–

All Group Off?

5  to confirm your selection.

SYSTEM SCAN **Z**

(LTR TRUNKED AND CONVENTIONAL OPERATION ONLY)

System Scan scans Trunked talkgroups and Conventional channels between LTR and Conventional zones, as programmed by your dealer. Up to 16 different talkgroups or Conventional channels can be programmed into each Scan list. You can edit these lists through your radio's menu (see page 66).

When System Scan is enabled:

- The display shows **Z** .
- The LED indicator blinks green during System Scan operation; it stops blinking when your radio switches to an active talkgroup or channel.

Note: If you enter Menu mode while your radio is scanning, scanning stops. The radio resumes scanning when you exit Menu mode.



To start or stop a System Scan:

Press the preprogrammed **Scan** button (see page 22) to start or stop scanning,

–or–

Do the following:

1  to enter Menu mode.



2  or  until

System Scan

3  to select

System Scan

You see the current scan status.

4  or  until

Sys Scan On?

–or–

Sys Scan Off?

5  to confirm your selection.

Notes:

- In conventional zones only, if there is activity on a non-priority channel, the radio disconnects the user from the current conversation and automatically switches to an active priority channel. This is indicated with a short alert tone.
- Your radio can either revert to a “selected” channel or the “last active” channel depending on its programming. For additional details, contact your local dealer.

DELETING A NUISANCE CHANNEL OR TALKGROUP

Note: This feature is available only with PassPort Group Scan or System Scan operation.

If a talkgroup or channel continually generates unwanted calls (a “nuisance” channel), use the preprogrammed **Scan** button to temporarily delete the talkgroup or channel from the Scan list.

To temporarily Delete a Nuisance Channel/
Talkgroup:

- 1 While your radio's receiving activity is on the nuisance channel, press and hold the **Scan** button until you hear a high-pitched tone (valid key press).
- 2 Release the **Scan** button. The nuisance channel has been temporarily deleted from your Scan list.
Note: In PassPort mode, you cannot delete a priority channel/talkgroup (see page 68), or the currently selected talkgroup in a Scan list.

To restore a previously deleted Channel/
Talkgroup to the Scan List, restart the scan
operation or turn your radio off and on again.

Note: In PassPort mode, the talkgroup can
also be restored by scrolling through the
list, or switching the current selected
talkgroup or zone.

EDITING A SCAN LIST

Note: *This feature is applicable to PassPort
Group Scan or System Scan operation
only.*

One Scan list is assigned to each of the 16
positions on the **Zone Selector** knob. Each
Scan list can contain up to 16 talkgroups and/
or channels. The same talkgroup or channel
can be included in several Scan lists, and the
same Scan list can be assigned to several
Zone Selector positions.

When you edit a Scan list, you can either add,
delete, or prioritize talkgroups or channels.

Note: In PassPort mode, talkgroups cannot be
prioritized.

Your radio cannot receive any calls while you
are editing a Scan list. The display shows
symbol while you are editing.

Note: In Conventional operation, even if there
is activity on a non-priority channel, your
radio automatically switches to an active
priority channel and indicates the activity
with a short tone.

VIEW A SCAN LIST

To view Talkgroups or Channels in a Scan list:

1  to enter Menu mode.

2  or  until 

3  to select 



4  or  until 

Note: One Scan list per mode of operation is available.

5  to select 

6  or  until 

7  to confirm your selection.

8  or  to see the talkgroup or channel in your list.

9 Hold down  to exit Menu mode.

ADDING OR DELETING TALKGROUPS OR CHANNELS IN A SCAN LIST

To add or delete Talkgroups or Channels in a Scan list:

1  to enter Menu mode.

2  or  until 

3  to select 

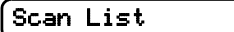
4  or  until 

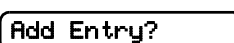

Note: One Scan list per mode of operation is available.

5  to select 

6  or  until 

or until 

7  to confirm your selection.

- 8  or  until you see the talkgroup or channel you want to add or delete.

Note: You cannot delete the Primary talkgroup from a Scan List in PassPort mode.

- 9  to confirm your selection.

- 10 If you added a talkgroup or channel,

you see

–or–

Entry Saved

If you delete a talkgroup or channel,

You see

 to confirm the deletion.

You see

Entry Deleted

- 11  to return to

–or–

Hold down  to exit Menu mode.

Add Entry?

Delete Entry?

PRIORITIZING A TALKGROUP OR CHANNEL IN A SCAN LIST

Note: This feature is available with System Scan operation only.



















You can check the activity on one or two talkgroups or channels more frequently than others by prioritizing them.

Priority Channel	Scanning Sequence
None specified	Ch1->Ch2->Ch3-> Ch4->...Ch1
Channel 2 (Priority 1)	Ch2->Ch1->Ch2->Ch3-> Ch2->Ch4->Ch2->...Ch1
Channel 2 (Priority 1) and Channel 8 (Priority 2)	Ch2->Ch1->Ch8->Ch3-> Ch2->Ch4->Ch8->...Ch1



Note: In Conventional operation only, even if there is activity on a non-priority channel, your radio automatically switches to an active priority channel and indicates the activity with a short tone.

Setting Priority Talkgroups or Channels

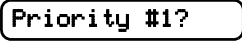
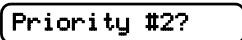
To set a Priority Talkgroup or Channel:

- 1  to enter Menu mode.
- 2  or  until 
- 3  to select 
- 4  or  until 
- 5  to select 
- 6  or  until 
- 7  to select 
- 8  or  until 
or until 

You see the current priority talkgroup or channel.

- 9  to select the desired priority level.
- 10  or  until you see the talkgroup or channel you want to prioritize.

11  to prioritize that talkgroup or channel.

12  to return to 
-or-

Hold down  to exit Menu mode.

Note: You cannot reprioritize a Priority 1 talkgroup or channel to Priority 2.

Notes

SCAN

PHONE

Your HT1250•LS+ radio allows you to place and receive telephone calls through Trunked and Conventional systems (depending on phone line availability). Telephone calls through a repeater allow only one person to speak at a time.

MAKING A PHONE CALL ① THROUGH A TRUNKED SYSTEM

Note: The following instructions assume your radio has been programmed as follows by your dealer using Customer Programming Software (CPS).

- Dial type: Live
- Access/Deaccess type: Immediate Auto
- Tone Span: Timed - 100 ms tone duration

To initiate a Phone Call:

- 1 Select a Trunked zone and talkgroup that have been programmed for telephone.

- 2  to enter Menu mode.

–or–



Press the preprogrammed **Phone** button, and skip to step 5.

–or–

Press and release the **Speed Dial** button to use the speed dial feature. Then press the (1 to 9) key corresponding to the number you want to call on the Phone list. Or press 0 if you want to call the last number dialed. Press the **PTT** button. A dial tone sounds. Press the **PTT** button again to send the phone number.

–or–

For an LTR Trunked system, press and hold the **PTT** button while dialing a number. (If your radio has been programmed for Hot keypad, this is a radio-wide setting).

- 3  or  until

Phone

- 4  to confirm

Phone

The display shows ① when you are in Phone mode.

- 5 Press and Release the **PTT** button.
- If phone access is successful, a dial tone sounds.
 - If phone access is unsuccessful, a low-pitched alternating tone sounds. Disconnect the call (see step 8) and try again.

- 6 Enter the phone number with the keypad. The number is automatically sent without pressing the **PTT** button again.

–or–

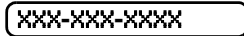

 or  to

select a number from



- 7 Press and release the **PTT** button again to send the number.

- 8 Hold your radio in a vertical position with the microphone 1 to 2 inches (2.5 to 5 centimeters) away from your mouth. Press the **PTT** button to talk; release it to listen.

- 9 Press and hold  to disconnect the call and exit Phone mode.
The display no longer shows .

MAKING A PHONE CALL THROUGH A CONVENTIONAL SYSTEM

To initiate a Phone Call:



Press the preprogrammed **Phone** button, and skip to step 5.

–or–

Press the **PTT** button, and if the Hot keypad feature has been programmed by your dealer, do the following:

- 1 Select a Conventional zone and channel that have been programmed for telephone.

- 2  to enter Menu mode.

- 3  or  until



- 4  to select



The display shows  when you are in Phone Mode.

- 5 (For Conventional operation with auto access only). You hear a series of tones, indicating that an access code is being sent automatically, and see your access code:

–or–



Enter your access code using the keypad.

- 6 When you hear a dial tone:

Enter the phone number using the keypad.

XXX-XXX-XXXX

–or–

 or  to select a number from the phone list.

XXX-XXX-XXXX

–or– (see step 7)

- 7 a Press and release the preprogrammed **Speed Dial** button (see step 6) to use the Speed Dial feature.
- b Press the key (1 to 9) corresponding to the number you want to call, or press 0 if you want to call the last number dialed.

Note: To redial the last number dialed (if not using Speed Dial), press and release the **PTT** button immediately after the access code is sent. Your radio sends the last number dialed.

–or–

If you entered your access code using the keypad, press the  key once to access the last number dialed; then press and release the **PTT** button.

- 8 Press and release the **PTT** button, if required for your radio.



- 9 Hold your radio in a vertical position with the microphone 1 to 2 inches (2.5 to 5 centimeters) away from your mouth. Press the **PTT** button to talk; release it to listen.

- 10 To disconnect a phone call, do one of the following:

Enter the deaccess code using the keypad.



–or–

If your radio has the deaccess code programmed, go to step 9.

- 11 To disconnect the call and exit Phone mode, press and hold . The display no longer shows .

RECEIVING A PHONE CALL THROUGH A TRUNKED OR CONVENTIONAL SYSTEM

To receive a Phone Call:

- 1  or  to select an LTR Trunked talkgroup or Conventional channel that has been programmed for telephone.

–or–

Activate any scan type containing a telephone talkgroup or channel (see page 61).

Note: You do not have to select a PassPort talkgroup or zone in PassPort mode.

When a phone call is received, a ringing tone sounds, alerting you to answer the phone call.

Note: The display shows  when the radio is in PassPort mode.

- 2 Press the **PTT** button to answer the phone call. Press the **PTT** button to talk; release it to listen.

- 3 To disconnect the phone call and exit Phone and Menu mode, press and hold .

Note: The display no longer shows  in PassPort mode.

MODIFYING THE PHONE LIST















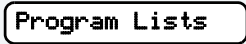







Your radio contains a Phone list that holds up to 25 phone numbers. The Phone list is shared between Trunked and Conventional Phone operation. You can modify the Phone list in three ways through your radio's menu:

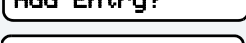



- Add an entry
- Delete an entry
- Edit an existing entry

The display shows  when you are modifying the phone list.





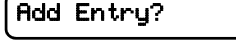













To add an Entry to the Phone List:





- 1  to enter Menu mode.

- 2  or  until 
- 3  to select 
- 4  or  until 
- 5  to select 
- 6  or  until 
- 7  to select 
You see 
- 8 Enter the name using the keypad (see page 13).
- 9  to store the name.
You see 
- 10 Enter the phone number using the keypad. You can also add a dash (press ) and a Pause Indicator (hold down  until the # character on the display changes to a "P").
- 11  to store the phone number.
- 12  or  until you see the location in the list where you want to store the phone number.



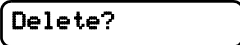









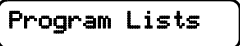

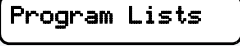

- 13  to store the phone number.
You see 
- 14  to return to 
- 15 Hold down  to exit Menu mode.













To delete an Entry from the Phone List:

- 1  to enter Menu mode.
- 2  or  until 
- 3  to select 
- 4  or  until 
- 5  to select 
- 6  or  until 
- 7  to select 
- 8  or  until you see the entry you want to delete.
- 9  to select the entry.

- 10 You see  again to confirm the deletion.
- You see 
- 11  to return to
–or–
Hold down  to exit Menu mode.

To edit a Phone List Entry:

- 1  to enter Menu mode.
- 2  or  until 
- 3  to select 
- 4  or  until 
- 5  to select 
- 6  or  until 
- 7  to select 
- 8  or  until you see the entry you want to edit.

- 9  to select the entry.
- 10  or  until 
(to edit the name),
or until 
(to edit the phone number),
or until 
(to edit the location in the phone list).
- 11  to confirm your selection.
- 12 Use the keypad to edit the entry (see page 14),
–or–
 or  until you see the location where you want to store the phone number.
- 13  to store the information.
- 14  to return to 
–or–
Hold down  to exit Menu mode.

VOICE STORAGE

Voice Storage is standard in HT1250•LS+ radios. Please check with your dealer for compatibility.

The Voice Storage feature enables your radio to perform seven types of voice related functions:

- Incoming Call Recording
- Voice Memo Recording
- Recorded Message Playback
- Recorded Message Delete
- Recorded Message Transmission
- Automatic Message Reply (“When Available”)
- Message Time Stamping

There is a total of 120 seconds recording time available for all voice storage activity. Your dealer can divide the 120 seconds into a defined number of equal length time slots. The following table summarizes the slot length options available with the HT1250•LS+ radio:

Number of Equal Length Slots	Slot Length (Seconds)
1	120
2	60
5	24
10	12
20	6

When recording calls, keep in mind these time slot guidelines:

- As a time slot becomes close to full, you see a timer count down the final five seconds.
When a time slot is completely full, an alert tone sounds.
- You see Msg Slot Full
- Recording stops.
- When all message slots have at least one message stored, an alert tone sounds.

If a voice storage record function is requested, the display shows:

Memory Full

INCOMING CALL RECORDING

The HT1250•LS+ radio allows you to record incoming calls in either of two ways:

- Selective Incoming Call Recording
- All Incoming Call Recording

Note: Your radio records the caller's audio transmissions only.

Selective Incoming Call Recording

This feature enables you to record incoming calls selectively, or on a call-by-call basis.

To selectively record an Incoming Call:

- 1 Press and hold the preprogrammed **Record/Playback** button (see page 16) while receiving the call.

You see

Recording

A confirmation tone sounds, indicating that your radio has started recording.

Your radio continues to record the call until the message slot is full or until you release the preprogrammed **Record/Playback** button.

- 2 Release the **Record/Playback** button to stop recording.















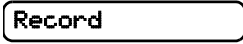

All Incoming Call Recording

This feature enables you to automatically record all incoming Trunked and Conventional dispatch calls, Trunked and Conventional telephone interconnect calls, and MDC selective calls.

This feature is useful when you want to be aware of channel activity while you are away from your radio.

Note: This feature does not function in Scan mode.

To record all Incoming Calls:

- 1  to enter Menu mode.
- 2  or  until 
- 3  to select 
- 4  or  until 
- 5  to select 
- 6  or  until 
- 7  to select 
- 8 The display continuously flashes, except when a call is being recorded.

You see while your radio is recording. 
Your radio also records the time stamp and the channel alias in the message slot.

- 9 Press  to stop recording.

–or–

Go to step 1 again to continue recording in the next available slot.

Note: Five seconds before the message slot ends,

you see:
(where XX =
remaining
seconds).



The "voice storage full" alert sounds when the message slot is full, and recording stops.

You see



VOICE MEMO RECORDING

In addition to recording calls received, your HT1250•LS+ radio enables you to record voice memos or personal reminders. This feature is useful when you want to quickly save phone numbers, names, or any other brief voice information. You can record voice memos using the preprogrammed **Record/Playback** button (see page 21) or your radio's menu.







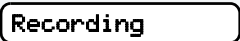





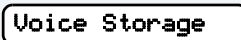

Important Note:

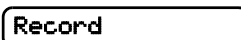

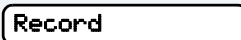
To record properly, incoming calls cannot be received while a voice memo is being recorded.

To record a Voice Memo using the Preprogrammed Record/Playback Button:

- 1 Press and hold the preprogrammed **Record/Playback** button.
 - You see 
 - A confirmation tone sounds, indicating that your radio has started recording.
- 2 Speak clearly into the microphone to record your memo. (Do not press the **PTT** button.) Your radio records your memo until the message slot is full, or until you release the preprogrammed **Record/Playback** button.
- 3 Release the **Record/Playback** button to stop recording.

To record a Voice Memo using the menu:

- 1  to enter Menu mode.
- 2  or  until 
- 3  to select 
- 4  or  until 
- 5  to select 
- 6  or  until 
- 7  to select
You see: 
- 8 Without pressing the **PTT** button, speak clearly into the microphone to record your memo. Your radio records your memo until the message slot is full or until you press .

Note: To stop recording at any time, press .
- 9 Press  to stop recording.
–or–
Repeat steps 7 and 8 to store additional messages.

RECORDED MESSAGE PLAYBACK

Your HT1250•LS+ radio allows you to list, select, and Playback previously recorded incoming call or voice memo messages. You can play back a message using the preprogrammed **Record/Playback** button (see page 21) or your radio's menu.

Note: Recorded message **Playback** cannot be initiated while your radio is receiving. In addition, your radio does not receive any incoming calls while you play back your messages.

Playing Msg XXX

To play back a Message using the Preprogrammed Record/Playback Button:

- 1 Press and release the preprogrammed **Record/Playback** button.

- The first message plays, and the display shows (XXX = the message number)

Playing Msg XXX

- 2 To advance to the next message at any time during Play back, press and release the **Record/Playback** button again.

- 3 To exit/cancel Play Back mode, press and release the preprogrammed **Playback Exit** button (see page 21).

–or–



Press  to stop play back.

To play back a Message using the Menu:

- 1  to enter Menu mode.

- 2  or  until **Voice Storage**

- 3  to select **Voice Storage**

- 4  or  until **Playback**

- 5  to select **Playback**

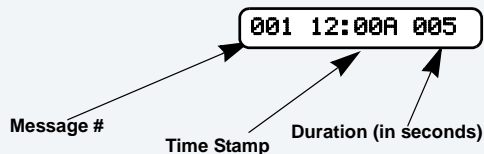

- 6  or  until **001 12:00A 005**

7  to select



8  or  to select the desired message.

9 Press  to play the selected message.



10  or  anytime during playback to advance to the next message.

RECORDED MESSAGE DELETE













Your HT1250•LS+ radio allows you to delete previously recorded incoming call or voice memo messages. You can delete a message using either the preprogrammed **Delete Playback** button (see page 21) or your radio's menu.

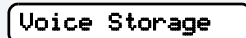

Note: You can delete messages only one at a time.

To delete a Message using the Preprogrammed Delete Playback Button:

- 1 Press and release the preprogrammed **Record/Playback** button (see page 21).
- 2  or  to select the desired message.
- 3 Press and hold the preprogrammed **Delete Playback** button to delete current message.
- 4  to stop deleting messages.

To delete a Message using the Menu:

- 1  to enter Menu mode.
- 2  or  until 
- 3  to select 
- 4  or  until 
- 5  to select 
- 6  or  to select the desired message.
- 7 Press  to delete the selected message.

- 8  or  to select the another message to be deleted, then go to step 7.

–or–

Press  to stop deleting messages.

RECORDED MESSAGE TRANSMISSION

This feature allows you to transmit a recorded message to another radio user.

To transmit a Recorded Message:















- 1 Press and hold the **PTT** button to initiate the message transmission.
- 2 While holding down the **PTT** button, press the preprogrammed **Record/Playback** button to select and play back the desired recorded call or memo.
- 3 When finished transmitting your message, press the **Record/Playback** button again to stop transmitting.

AUTOMATIC MESSAGE REPLY: “WHEN AVAILABLE”

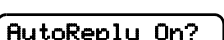

(LTR TRUNKED AND CONVENTIONAL OPERATION ONLY)

The Automatic Message Reply feature allows you to transmit a recorded message to a caller when your radio receives an MDC Selective call.

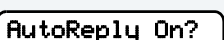
To enable the Automatic Message Reply feature:

- 1  to enter Menu mode.
- 2  or  until 
- 3  to select 
- 4  or  until 
- 5  to select 
- 6  or  until 
- 7  to select 

To record a Message:

1  or  until **Recorded Msg**

2  to select **Recorded Msg**

Note: You see **Recording**

3 Without pressing the **PTT** button, speak clearly into the microphone to record your memo. Your radio records your memo until the message slot is full or until you press .

You see: **Msg Slot Full**

4 To exit or cancel recording, press .

When Automatic Message Reply is enabled, the recorded message is automatically transmitted whenever your radio receives an Individual call.

To disable the Automatic Message Reply feature:

1  to enter Menu mode.

2  or  until **Utilities**

3  to select **Utilities**

4  or  until **When Available**

5  to select **When Available**

6  or  until **AutoReply Off?**

7  to select **AutoReply Off?**



AUDIO/TONE SETTINGS

You can customize the audio and tone feature settings on your radio as follows:



1  to enter Menu mode.

2  or  until 

3  to select 

4  or  until you see the feature you want to change (see the table on the following page).

5  to select the feature. You see the feature's current setting.

6  or  to see a list of available settings. (For Name and Call Tone Tagging, see page 59.)

7  to select the desired setting.

Audio/Tone Settings

Feature	What it Does	Settings
Alert Vol Lvl	Makes the volume level of the audio and alert tones independent. If turned on, it makes the alert tones follow your radio's default settings; if turned off, the alert tones are sounded at the setting determined by the position of the volume knob.	Ind Alert Off Ind Alert On
Tone Disable	Turns all alert and audio tones on or off.	Tones On Tones Off
Name and Call Tone Tagging †§	Assigns a specific ring tone when receiving a call from a specific user (see page 59).	Standard Alert #1 – #7
Call Tone Tag †§	Assigns a specific tone when receiving a specific type of radio call (see page 59).	Standard Alert #1 – #7
Escalert †§	Increases the volume of the alarm tones when a radio call is not answered.	Escalert On Escalert Off
Companding	Provides the same audio quality for 12.5 kHz and for 25 kHz channels.	Compand On Compand Off
Keypad Tones	Turns keypad tones on or off except for programmable buttons (see page 16).	Tones On Tones Off

† LTR Trunked operation only.

§ Conventional operation only.



UTILITIES

You can customize some of your radio's feature as follows:

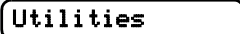

1  to enter Menu mode.

2  or  until 

3  to select 

4  or  until you see the feature you want to change (see table on the following page).

5  to select the feature. You see the feature's current setting.

6  or  for available settings.

7  to select the desired setting.



Utilities Features

Feature	What it Does	Settings
Squelch §	Sets radio squelch to normal or tight (see page 90).	Sqlch Tight Sqlch Normal
Power Level	Changes your radio's power level to high, low, or auto (see page 90).	Power High Power Low Power Auto
Clock	Sets the time, or turns the clock on or off (see page 91).	Clock On Clock Off Set Time
Reminder Alarm	Sets the alarm, or turns it on or off (see page 91).	Alarm On Alarm Off Set Time
Language Selection §‡	Selects the language to be shown on your radio's display.	English Spanish Portuguese French

§ *Conventional Operation only.*

‡ *LTR Trunked operation only.*

Utilities Features

Feature	What it Does	Settings
Light Disable	Turns your radio's LED indicator, the display, and keypad backlight on or off.	Lights on Lights off
When Available ‡§	Transmits a recorded message to a caller when your radio receives an MDC Selective call.	Auto reply on Auto reply off Record msg Review msg
Software Ver ‡	<p>In LTR Trunked and Conventional operation, displays your radio's software version number when you press .</p> <p>In PassPort operation, displays the PassPort software version number when you press .</p> <p>Note: The LTR and Conventional software version number may be different than the PassPort software version number.</p>	—

§ Conventional Operation only.

‡ LTR Trunked operation only.

SETTING TIGHT OR NORMAL SQUELCH

(CONVENTIONAL OPERATION ONLY)

Use this feature to filter out nuisance (unwanted) calls and/or background noise. However, tightening squelch could cause calls from remote locations to be filtered out as well. In this case, normal squelch may be more desired.



To select Tight or Normal Squelch:

Press the preprogrammed **Squelch** button (see page 20) to toggle between tight and normal squelch,

–or–

Do the following:



1  to enter Menu mode.

2  or  until

Utilities

3  to select



Utilities

4  or  until

Squelch

5  to select

Squelch

6  or  until

Sq1ch Tight?

–or–

until

Sq1ch Normal?

7  to confirm the selection.

SETTING THE POWER LEVEL \lfloor \mathbb{H}

Each channel in your radio has a predefined transmit power level that can be changed.

- *High power* (**H**) allows you to reach a radio that is farther away.
- *Low power* (**L**) conserves the battery's charge.
- *Auto power* (Conventional operation only) automatically sets the optimal power level based on the strength of the signal received. If the received signal is weak, the transmit level will be set to high, and vice versa.

Note: A message received from a nearby radio might change your radio's power level to low. This may cause radios that are farther away not to receive your transmissions.

In PassPort mode, the power level is predefined radio wide.

To set the Power Level:

Press the preprogrammed **Power Level** button (see page 19) to toggle between *low* and *high*,
—or—

1  to enter Menu mode.

2  or  until **Utilities**

3  to select **Utilities**

4  or  until **Power Level**

5  to select **Power Level**

The display shows the current power level.

6  or  until **Power High?**

or until **Power Low?**

or until **Power Auto?**

7  to confirm the selection.

SETTING THE CLOCK OR ALARM

To set the Clock/Alarm:

1  to enter Menu mode.

2  or  until **Utilities**

3  to select **Utilities**



4  or  until **Clock**

or until **Reminder Alarm**

5  to confirm your selection.

6  or  until **Set Time?**



7  to select **Set Time?**

- 8 When a setting is blinking, you can change it with  or .

Hour (AM or PM) → 
Minutes → (AM/PM or 24 hr)

Note: You cannot select “24 hr” for



- 9  or  to move to the previous or next setting.

- 10  to save your changes.

- 11  to return to



or



or

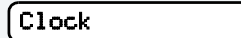

–or–

Hold down  to exit Menu mode.

WARRANTY

LIMITED WARRANTY MOTOROLA COMMUNICATION PRODUCTS

I. WHAT THIS WARRANTY COVERS AND FOR HOW LONG:

MOTOROLA INC. (“MOTOROLA”) warrants the MOTOROLA manufactured Communication Products listed below (“Product”) against defects in material and workmanship under normal use and service for a period of time from the date of purchase as scheduled below:

HT1250•LS+ Portable Units	Two (2) Years
Product Accessories	One (1) Year

Motorola, at its option, will at no charge either repair the Product (with new or reconditioned parts), replace it (with a new

or reconditioned Product), or refund the purchase price of the Product during the warranty period provided it is returned in accordance with the terms of this warranty. Replaced parts or boards are warranted for the balance of the original applicable warranty period. All replaced parts of Product shall become the property of MOTOROLA.

This express limited warranty is extended by MOTOROLA to the original end user purchaser only and is not assignable or transferable to any other party. This is the complete warranty for the Product manufactured by MOTOROLA.

MOTOROLA assumes no obligations or liability for additions or modifications to this warranty unless made in writing and signed by an officer of MOTOROLA. Unless made in a separate agreement between MOTOROLA and the original end user purchaser, MOTOROLA does not warrant the installation, maintenance or service of the Product.

MOTOROLA cannot be responsible in any way for any ancillary equipment not furnished by MOTOROLA which is attached to or used in connection with the Product, or for operation of the Product with any ancillary equipment, and all such equipment is expressly excluded from this warranty. Because each system which may use the Product is unique, MOTOROLA disclaims liability for range, coverage, or operation of the system as a whole under this warranty.

II. GENERAL PROVISIONS:

This warranty sets forth the full extent of MOTOROLA'S responsibilities regarding the Product. Repair, replacement or refund of the purchase price, at MOTOROLA's option, is the exclusive remedy. THIS WARRANTY IS GIVEN IN LIEU OF ALL OTHER EXPRESS WARRANTIES. IMPLIED WARRANTIES, INCLUDING WITHOUT LIMITATION, IMPLIED WARRANTIES OF MERCHANTABILITY AND FITNESS FOR A PARTICULAR PURPOSE, ARE LIMITED TO THE

DURATION OF THIS LIMITED WARRANTY. IN NO EVENT SHALL MOTOROLA BE LIABLE FOR DAMAGES IN EXCESS OF THE PURCHASE PRICE OF THE PRODUCT, FOR ANY LOSS OF USE, LOSS OF TIME, INCONVENIENCE, COMMERCIAL LOSS, LOST PROFITS OR SAVINGS OR OTHER INCIDENTAL, SPECIAL OR CONSEQUENTIAL DAMAGES ARISING OUT OF THE USE OR INABILITY TO USE SUCH PRODUCT, TO THE FULL EXTENT SUCH MAY BE DISCLAIMED BY LAW.

III. STATE LAW RIGHTS:

SOME STATES DO NOT ALLOW THE EXCLUSION OR LIMITATION OF INCIDENTAL OR CONSEQUENTIAL DAMAGES OR LIMITATION ON HOW LONG AN IMPLIED WARRANTY LASTS, SO THE ABOVE LIMITATION OR EXCLUSIONS MAY NOT APPLY.

This warranty gives specific legal rights, and there may be other rights which may vary from state to state.

IV. HOW TO GET WARRANTY SERVICE:

You must provide proof of purchase (bearing the date of purchase and Product item serial number) in order to receive warranty service and, also, deliver or send the Product item, transportation and insurance prepaid, to an authorized warranty service location. Warranty service will be provided by Motorola through one of its authorized warranty service locations. If you first contact the company which sold you the Product (e.g., dealer or communication service provider), it can facilitate your obtaining warranty service. You can also call Motorola at 1-800-927-2744 US/Canada.

V. WHAT THIS WARRANTY DOES NOT COVER:

- A) Defects or damage resulting from use of the Product in other than its normal and customary manner.
- B) Defects or damage from misuse, accident, water, or neglect.
- C) Defects or damage from improper testing, operation, maintenance, installation, alteration, modification, or adjustment.
- D) Breakage or damage to antennas unless caused directly by defects in material workmanship.
- E) A Product subjected to unauthorized Product modifications, disassemblies or repairs (including, without limitation, the addition to the Product of non-Motorola supplied equipment) which adversely affect performance of the Product or interfere with Motorola's normal warranty inspection and testing of the Product to verify any warranty claim.
- F) Product which has had the serial number removed or made illegible.
- G) Rechargeable batteries if:
 - 1) any of the seals on the battery enclosure of cells are broken or show evidence of tampering.
 - 2) the damage or defect is caused by charging or using the battery in equipment or service other than the Product for which it is specified.
- H) Freight costs to the repair depot.
- I) A Product which, due to illegal or unauthorized alteration of the software/ firmware in the Product, does not function in

accordance with MOTOROLA's published specifications or the FCC type acceptance labeling in effect for the Product at the time the Product was initially distributed from MOTOROLA.

- J) Scratches or other cosmetic damage to Product surfaces that does not affect the operation of the Product.
- K) Normal and customary wear and tear.

VI. PATENT AND SOFTWARE PROVISIONS:

MOTOROLA will defend, at its own expense, any suit brought against the end user purchaser to the extent that it is based on a claim that the Product or parts infringe a United States patent, and MOTOROLA will pay those costs and damages finally awarded against the end user purchaser in any such suit which are attributable to any such claim, but such defense and payments are conditioned on the following:

- A) that MOTOROLA will be notified promptly in writing by such purchaser of any notice of such claim;
- B) that MOTOROLA will have sole control of the defense of such suit and all negotiations for its settlement or compromise; and
- C) should the Product or parts become, or in MOTOROLA's opinion be likely to become,

the subject of a claim of infringement of a United States patent, that such purchaser will permit MOTOROLA, at its option and expense, either to procure for such purchaser the right to continue using the Product or parts or to replace or modify the same so that it becomes non-infringing or to grant such purchaser a credit for the Product or parts as depreciated and accept its return. The depreciation will be an equal amount per year over the lifetime of the Product or parts as established by MOTOROLA.

MOTOROLA will have no liability with respect to any claim of patent infringement which is based upon the combination of the Product or parts furnished hereunder with software, apparatus or devices not furnished by MOTOROLA, nor will MOTOROLA have any liability for the use of ancillary equipment or software not furnished by MOTOROLA which is attached to or used in connection with the Product. The foregoing states the entire liability of MOTOROLA with respect to infringement of patents by the Product or any parts thereof.

Laws in the United States and other countries preserve for MOTOROLA certain exclusive rights for copyrighted MOTOROLA software such as the exclusive rights to reproduce in copies and

distribute copies of such Motorola software. MOTOROLA software may be used in only the Product in which the software was originally embodied and such software in such Product may not be replaced, copied, distributed, modified in any way, or used to produce any derivative thereof. No other use including, without limitation, alteration, modification, reproduction, distribution, or reverse engineering of such MOTOROLA software or exercise of rights in such MOTOROLA software is permitted. No license is granted by implication, estoppel or otherwise under MOTOROLA patent rights or copyrights.

VII. GOVERNING LAW:

This Warranty is governed by the laws of the State of Illinois, USA.

Notes

ACCESSORIES

Motorola offers a number of accessories to enhance the productivity of your two-way radio. Many of the available accessories are listed below. For a list of Motorola approved accessories, visit the following web site which lists approved accessories:

<http://www.motorola.com/cgiss/index.shtml>

CARRY ACCESSORIES

HLN9714_	Spring 2 1/2" Belt Clip
HLN9844_	Spring 1.5" Belt Clip
HLN9952_	Belt Clip Carry Holder
HLN6602_	Universal Chest Pack
HLN9985_	Waterproof Bag
NTN5243_	Carry Strap
RLN4815_	Fanny Pack Carry Accessory (Universal Radio Pack)

CARRY CASES

HLN9677_	Leather DTMF Case, Thin Battery with Belt Loop
HLN9689_	Leather DTMF Case, Standard Battery with Belt loop

HLN9690_	Leather DTMF Case, Thin Battery with Swivel
HLN9694_	Leather DTMF Case, Standard Battery with Swivel
HLN9701_	Nylon Case, with Belt Loop - Fits all Batteries
HLN9946_	Leather Keypad Case with Belt Loop
HLN9998_	Leather Keypad Case with Swivel
HLN9945_	Leather Keypad Case with Belt Loop
HLN9955_	Leather Keypad Case with Swivel

CHARGERS

AAHTN3000_	120 V, Rapid Rate, Single-Unit Intelli-Charger
AAHTN3003_	120 V, 6-Unit, Rapi-Rate Intelli-Charger
NLN7967_	Wall Mount Kit for Multi-Unit Charger
RLN4883_	Travel Charger (includes voltage regulated lighter adapter, custom charger bse, coil cord, and mounting bracket)
RL-76345	Battery Optimizing System (BOS) Adapter Plate
WPLN4071_R	Battery Optimizing System - 110 V AC, 50/60 Hz, 4 Station
WPLN4079-R	Battery Maintenance System Plus (BMS Plus) - 110 V AC, 50/60 Hz

WPPN4079-R	BMS Battery Adapter (For Ni-Cad and NiMH Batteries)
WPLN4107-R	Motorola Conditioning Charger Kit (includes 7.2 Volt base, removable adapter plate and transformer, 60 minute Rapid Charger, 110 V)
WPPN4065-R	Motorola Conditioning Charger. Four-Station Base only. 110 V (requires Adapter Plate)
WPPN4082-R	Adapter Plate Only (for Motorola Conditioning Charger)
RLN4814_	Vehicular Mounting Bracket (for use with Motorola Single Unit Conditioning Charger Bases)
HLN9793_	Charger Insert Spacer (compatible with A version chargers only)
HLN9794_	Charger Insert Spacer (compatible with B and C version chargers only)

HEADSETS AND ACCESSORIES

AARMN4018_	Lightweight Headset with Boom Microphone and In-Line PTT - FM (Factory Mutual) Approved
AARMN4031_	Lightweight Headset with Swivel Boom Microphone - (FM Approved (VOX operational only on Conventional channel)

AARMN4017_	Ultra-Light Headset - FM Approved (VOX operational only on Conventional channel)
AARMN4032_	Medium Weight Dual Muff Headset, Over the Head with Noise Cancelling Mic - FM Approved
AARMN4019_	Medium Weight Over-the-Head Dual Muff Headset with Noise Cancelling Microphone and in line PTT. FM Approved
ARMN4020_	Heavy Duty Muff Headset with Noise Cancelling Microphone and PTT on Earcup, Noise Reduction Rating = 24 dB - FM Approved (VOX operational only on Conventional channel)
RMN4051_	2-Way Hard-hat Mount Headset, Black - Noise Reduction Rating = 22 dB (required RKN4097)
RMN4052_	Tactical HeadBand-Style Headset, Gray - Noise Reduction Rating = 24 dB (requires RKN4097)
RMN4053_	Tactical Hard-hat Mount Headset, Gray - Noise Reduction Rating = 22 dB (requires RKN4097)
RMN4054_	Receive-Only Hard-hat Mount Headset with 3.5mm right angle plug - Noise Reduction Rating = 22 dB
RMN4055_	Receive-Only HeadBand-Style Headset with 3.5mm right angle plug - Noise Reduction Rating = 24 dB

RKN4097_	In-Line Adapter Cable for user with RMN4051, RMN4052, and RMN4053 Headsets
ENMN4014_	3-Wire Surveillance Kit with Microphone and PTT (Black) - FM Approved
ENMN4012_	Ultra Lightweight, Behind the Head, Headset with Streamlined Boom Microphone
ENMN4013_	Flexible Ear Receiver (Flexible Earloop and Speaker that Rests External to the Ear
ENMN4016_	Medium Duty Headset, Behind the Head, with In-line PTT with Noise Cancelling Boom Microphone

MICROPHONES

HMN9052_	Standard Remote Speaker Microphone
AAHMN9053_	Noise-Cancelling Remote Speaker Microphone - FM Approved
AAHKN9055_	Remote Speaker Microphone Replacement Cable

EAR MICROPHONE SYSTEM

BDN6677_	Ear Microphone - Black (for noise levels up to 95 dB) - requires Interface Module
BDN6678_	Ear Microphone - Beige (for noise levels up to 95 dB) - requires Interface Module

BDN6641_	Ear Microphone - Gray (for high noise levels from 95 dB to 105 dB) - requires Interface Module - FM Approved
RMN4044_	Interface Module for PTT Operation Only - FM Approved
0180358B38	Finger Push to Talk Switch for Ear Microphone System - FM Approved
0180300E83	Body Switch Push to Talk for Ear Microphone System
AARMN4045_	Ear Microphone Interface Module PTT or VOX
ENMN4017_	3-Wire Surveillance Kit with Microphone and PTT (Beige)

INTEGRATED MICROPHONE/RECEIVER

This devices's acoustic technology does not rely on conduction for communication.

NTN1722_	Integrated Ear Microphone/Receiver System with PTT on Radio Adapter - FM Approved
NTN1723_	Integrated Ear Microphone/Receiver System wit Palm PTT - FM Approved
NTN1724_	Integrated Ear Microphone/Receiver System with Ring PTT - FM Approved

NNTN4187_	Integrated Microphone/Receiver with Remote Push-to-Talk Body Switch - FM Approved
NNTN4188_	Replacement Remote Push-to-Talk Body Switch
NTN8821_	CommPort Maintenance Kit - includes Replacement Ear Tubes (qty. 10), Windscreens (qty. 2) and Microphone Seal Strips (qty. 10)
NTN8986_	Adhesive Pads (qty. 90) for Secure Attachment to the Ear
NTN8988_	Ear Straps (qty. 10) for Secure Attachment to the Ear
NKN6525_	Replacement Snap-on-Side PTT Cable for NTN1737
NKN6508_	Replacement Cable for NTN1722
RLN4760_	Small Custom Earpiece, Right Ear (for use with NTN8371)
RLN4761_	Medium Custom Earpiece, Right Ear (for use with NTN8371)
RLN4762_	Large Custom Earpiece, Right Ear (for use with NTN8371)
RLN4763_	Small Custom Earpiece, Left Ear (for use with NTN8371)
RLN4764_	Medium Custom Earpiece, Left Ear (for use with NTN8371)
RLN4765_	Large Custom Earpiece, Left Ear (for use with NTN8371)

NKN6510_	Replacement Palm PTT Cable for NTN1723
NKN6512_	Replacement Ring PTT Cable for NTN1723

EARPIECE

AARLN4885_	Receive Only Foam Earbud with 3.5mm plug - (for use with AAHMN9053, AAHMN8054, and AAHMN9057) - FM Approved
AARMN4022_	2-Wire Earpiece with Microphone and PTT (Beige) - FM Approved
AARMN4029_	2-Wire Earpiece with Microphone and PTT (Black) - FM Approved
RLN5316_	2-Wire Comfort Ear Piece with Combined Microphone and PTT, Beige Surveillance Kits with Extended-Wear Comfort Earpieces include a Low Noise Enhancement (NTN8371) already attached for extra comfort and convenience.
RLN5315_	2-Wire Comfort Ear Piece with Combined Microphone and PTT, Black Surveillance Kits with Extended-Wear Comfort Earpieces include a Low-Noise Enhancement (NTN8371) already attached for extra comfort and convenience.

AARMN4021_	Earpiece with Volume Control (Beige) - FM Approved
AARMN4028_	Earpiece with Volume Control (Black) - FM Approved
RLN4941_	Receive-Only Earpiece with translucent tube, rubber eartip, and 3.5mm plug (for use with AAHMN9053, AAHMN9054, and AAHMN9057)
RLN4922_	Completely Discrete Earpiece Kit - must be used with any standard 2 or 3 wire surveillance earpiece kit
NTN8370_	Extreme Noise Earpiece Adapter Kit, Noise Reduction Rating - 28 dB (for use with AARMN4022 and AARMN4029)
NTN8371_	Low Noise Earpiece Adapter Kit (for use with AARMN4022 and AARMN4029)
RLN5037_	Replacement Ear Tubes (qty 10)

ADAPTERS

HLN9820_	Accessory Dust Cover
AAHLN9716_	Audio Accessory Adapter for the user of GP300/P1225•LS audio accessories - FM Approved (not compatible with BDN6706 or BDN6646)
AAHLN9717_	3.5mm Accessory Adapter
3080384G15	Cigarette Lighter Adapter
RLN4853_	Adapter 10 to 20 pin

AARKN4073_	Cloning Cable
AARKN4074_	Programming/Test Cable (requires RIB box)
AARKN4075_	Programming cable (includes internal Rib)
0180305G54	Shop battery eliminator cable. Requires RLN4510A (7.5 volt source)
RLN4510_	7.5 Volt Universal Battery Eliminator

BATTERIES

HNN9008_R	1500 mAH NiMH High Capacity Battery (standard)
HNN9009_R	1900 mAH NiMH Ultra High Capacity Battery
HNN9010_R	1800 mAH NiMH, Ultra High Capacity - FM Approved
HNN9011_R	1200 mAH Ni-Cad, High Capacity Battery - FM Approved
HNN9012_R	1300 mAH Ni-Cad High Capacity Battery
HNN9013_R	1200 mAH Lithium Ion Battery
HPNN4045	1200 mAH NiMH High Capacity Battery
HNN4001	Impres™ 1900 mAH NiMH, 7.5 V Battery
HNN4002	Impres™ 1800 mAH NiMH, 7.5 V Battery - Intrinsically Safe (FM)
HNN4003	Impres™ 2000 mAH Li-ion, 7.5 V Battery

ANTENNAS

NAB6064_	Lowband, Heliflex
PMAD4012_	VHF 136–155 MHz 9 cm, Stubby
PMAD4013_	VHF 155–174 MHz 9 cm, Stubby
PMAD4014_	VHF 136–155 MHz 14 cm, Standard Length
PMAD4015_	VHF 155–174 MHz 14 cm, Standard Length
PMAD4023_	VHF 150–161 MHz
PMAD4025_	VHF 150–161 MHz, Stubby
NAD6502_	VHF 146–174 MHz, Heliflex
NAD6579_	VHF 148–161 MHz, Whip
8504762J01	VHF 136–155 MHz, Whip
8504762J02	VHF 155–174 MHz, Whip
PMAE4002_	UHF 403–433 MHz
PMAE4003_	UHF 433–470 MHz
NAE6483AR	UHF 403–520 MHz, Whip
PMAE4006_	UHF 470–510 MHz
PMAE4007_	UHF 490–527 MHz
PMAE4008_	UHF 470–530 MHz, Whip

Menu Navigation Chart

(Refer to Menu Navigation guidelines—
lower, left-hand corner of this page)

- * — Available in PassPort trunked zones only
- ** — Available in PassPort signaling only
- ‡ — Available in LTR trunked zones only
- § — Available in conventional zones only

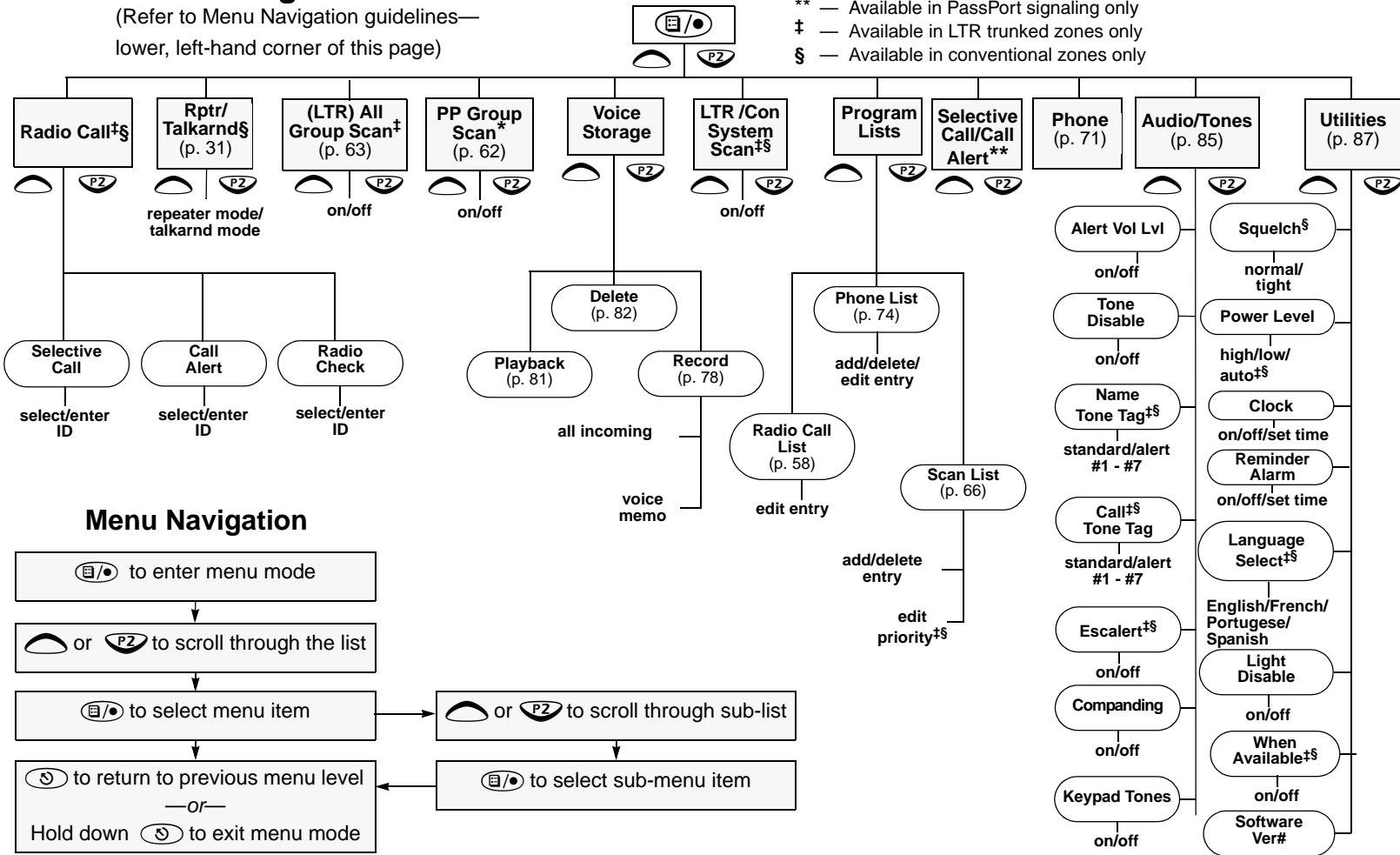



MOTOROLA and the Stylized M Logo are registered in the U.S. Patent and Trademark Office. All other product or service names are the property of their respective owners.
© Motorola, Inc. 2002, 2003, 2004.

MOTOROLA et le logo stylisé M sont homologués au Patent and Trademark Office des Etats-Unis. Tous les autres noms de produits ou services appartiennent à leurs propriétaires respectifs.
© Motorola, Inc. 2002, 2003, 2004.



6881088C42-E

Free Manuals Download Website

<http://myh66.com>

<http://usermanuals.us>

<http://www.somanuals.com>

<http://www.4manuals.cc>

<http://www.manual-lib.com>

<http://www.404manual.com>

<http://www.luxmanual.com>

<http://aubethermostatmanual.com>

Golf course search by state

<http://golfingnear.com>

Email search by domain

<http://emailbydomain.com>

Auto manuals search

<http://auto.somanuals.com>

TV manuals search

<http://tv.somanuals.com>