

RDM Series MURS Two-Way Radios

User Guide



CONTENTS

Contents	i
Safety	iv
Batteries and Chargers	
Safety Information	v
Introduction	1
FCC Licensing	
Information	3
Radio Overview	4
Display Model – RDM2080d	4
Non-Display Model –	
RDM2020	5
Battery Features	9
Drop-in Tray Charger and	
Power Supply	10
Charging The Battery	16
Installing Spring Action	
Belt Clip	23

Getting Started	24
Turning radio ON/OFF	24
Adjusting volume	24
Reading the Display	
(RDM2080d Model)	24
Selecting a Channel	25
Talking and Monitoring	25
Receiving a Call	25
Scan	25
Signal Strength and Channel	
Busy Indicators	
(RDM2080d Model)	26
Low Battery Alert	27
Talk Range	27
Computer Programming	
Software	28
Radio Cloning	30
Basic Configuration	31
Menu Options (RDM2080d	
Model)	31
Battery Save	31

Battery Type Settings (RDM2080d Model)	32	Frequency Selection	39
Channel Alias (RDM2080d Model)	32	CTSS/DPL Codes	39
Cloning Mode	33	Auto Scan	39
Roger Beep Tone (End of Transmission Tone)	34	Advanced Configuration (RDM2080d Model)	40
Keypad Beep (RDM2080d Model)	34	Other Advanced Configurations (RDM2080d Model)	41
Keypad Lock/Unlock (RDM2080d Model)	34	Call Tone	41
VOX - Voice Operated Transmit	35	Microphone Gain Level	41
iVOX - Internal Voice Operated Transmit (RDM2080d Model)	36	Scramble	42
VOX/iVOX Sensitivity Settings (RDM2080d Model)	36	Side Button Preset to Channel Select	43
Nuisance Channel Delete	37	Advanced Configuration (RDM2020 Model)	44
PL Defeat	38	Reading Values Through	
Reset to Factory Defaults	38	Beeps and LED Indicators	45
Advanced Configuration	39	Reading Frequency Values	46
Entering Advanced Configuration Mode	39	Reading CTCSS/DPL Values	46
		Reading Auto-Scan Values	47
		Changing Values	47
		Configuring a Frequency	47
		Configuring a Code	48
		Configuring Auto-Scan	48

Frequency and Code Charts	50
Use and Care	57
Troubleshooting	58
Motorola Limited Warranty for the United States and Canada	62
Accessories	66

SAFETY

PRODUCT SAFETY AND RF EXPOSURE COMPLIANCE



Caution

Before using this product, read the RF energy awareness information and operating instructions in the Product Safety and RF Exposure booklet enclosed with your radio to ensure compliance with RF energy exposure limits.

For a list of Motorola-approved, batteries, and other accessories, visit the following website:

www.motorola.com/RDX

BATTERIES AND CHARGERS SAFETY INFORMATION

This document contains important safety and operating instructions. Read these instructions carefully and save them for future reference.

Before using the battery charger, read all the instructions and cautionary markings on

- the charger,
 - the battery, and
 - the radio using the battery
1. To reduce risk of injury, charge only rechargeable Motorola-authorized batteries. Other batteries may explode, causing personal injury and damage.
 2. Use of accessories not recommended by Motorola may result in risk of fire, electric shock, or injury.

3. To reduce risk of damage to the electric plug and cord, pull by the plug rather than the cord when disconnecting the charger.
4. An extension cord should not be used unless absolutely necessary. Use of an improper extension cord could result in risk of fire and electric shock. If an extension cord must be used, make sure that the cord size is 18 AWG for lengths up to 6.5 feet (2.0 m), and 16 AWG for lengths up to 9.8 feet (3.0 m).
5. To reduce risk of fire, electric shock, or injury, do not operate the charger if it has been broken or damaged in any way. Take it to a qualified Motorola service representative.
6. Do not disassemble the charger; it is not repairable and replacement parts are not available. Disassembly of the charger may result in risk of electrical shock or fire.

7. To reduce risk of electric shock, unplug the charger from the AC outlet before attempting any maintenance or cleaning

OPERATIONAL SAFETY GUIDELINES

- Turn the radio OFF when charging battery.
 - The charger is not suitable for outdoor use. Use only in dry locations/conditions.
 - Connect charger only to an appropriately fused and wired supply of the correct voltage (as specified on the product).
 - Disconnect charger from line voltage by removing main plug.
- The outlet to which this equipment is connected should be nearby and easily accessible.
 - Maximum ambient temperature around the power supply equipment must not exceed 40 °C (104 °F).
 - Power output from the power supply unit must not exceed the ratings stated on the product label located at the bottom of the charger.

INTRODUCTION

Thank you for purchasing the Motorola® RDM Series MURS Two-Way Radio. This radio is a product of Motorola's more than 75 years of experience as a world leader in the designing and manufacturing of communications equipment. The RDM Series MURS Two-Way Radios provide cost-effective communications for businesses such as retail stores, restaurants, schools, construction sites, manufacturing, property and hotel management and more. Motorola Business two-way radios are the perfect communications solution for all of today's fast-paced industries.

Note: Read this user guide carefully to ensure you know how to properly operate the radio before use.

**Business Radios,
RPSD 1C15, Motorola
8000 West Sunrise Boulevard
Plantation, Florida 33322**

PACKAGE CONTENTS

- Radio with fixed antenna
- Spring Action Belt-Clip
- Lithium-Ion Battery
- Power Supply
- User Guide
- Warranty Card
- Drop-in Tray Charger
- Product Safety & RF Exposure Booklet

For a copy of a large-print version of this user guide or for product-related questions, contact:

1-800-448-6686 in the USA

1-800-461-4575 in Canada

1-866-522-5210 on your TTY (Text Telephone)

For product information visit us at:

www.motorola.com/business

This User Guide covers the following RDM Series models:

Model	Frequency Band	Transmit Power	Number of Channels	Display
RDM2080d	MURS	2 W	8	Yes
RDM2020	MURS	2 W	2	No

FCC LICENSING INFORMATION

REGULATION ON MURS (MULTI-USE RADIO SERVICE) FREQUENCIES

The RDM2020/2080 radios are exclusively MURS frequencies radios. These devices also comply with Part 15 of the FCC Rules. Operation is subject to the following two conditions:

1. This device does not cause harmful interference, and
2. This device must accept any interference received, including interference that may cause undesired operation.

FCC License is not required. This device operates on frequencies authorized for use in the Multi-Use Radio Service (MURS). MURS frequencies are available for unlicensed business or personal use. Take into account that change or modifications not expressly

approved by Motorola may void the user's authority granted by the FCC to operate this radio and should not be made. To comply with FCC requirements, transmitter adjustments should be made only by or under the supervision of a person certified as technically qualified to perform transmitter maintenance and repairs in the private land mobile and fixed services as certified by an organization representative of the user of those services. Replacement of any transmitter component (crystal, semiconductor, etc.) not authorized by the FCC equipment authorization for this radio could violate FCC rules. Use of this radio outside the country where it was intended to be distributed is subject to government regulations and may be prohibited.

For questions regarding FCC license, call 1-888-CALL-FCC (1-888-225-5322) or go to www.fcc.gov.

RADIO OVERVIEW

DISPLAY MODEL – RDM2080d

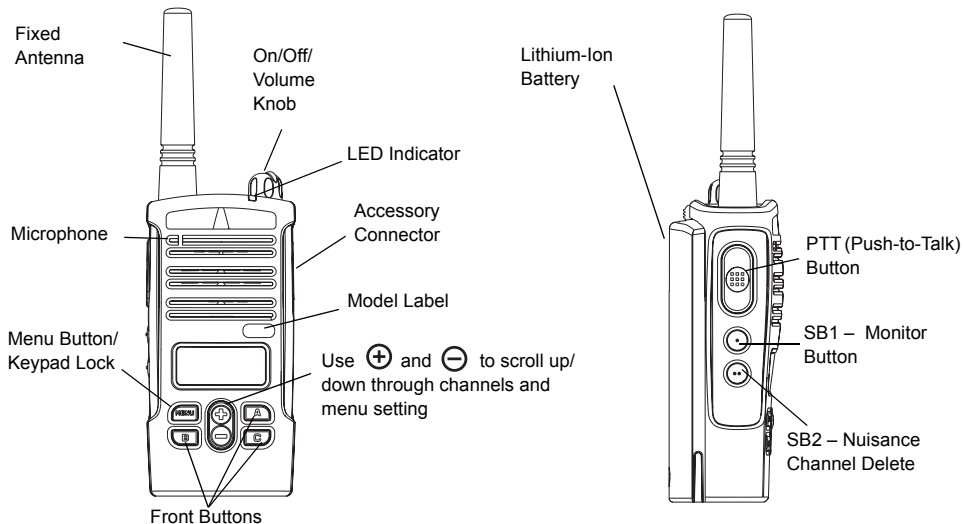

NON-DISPLAY MODEL – RDM2020

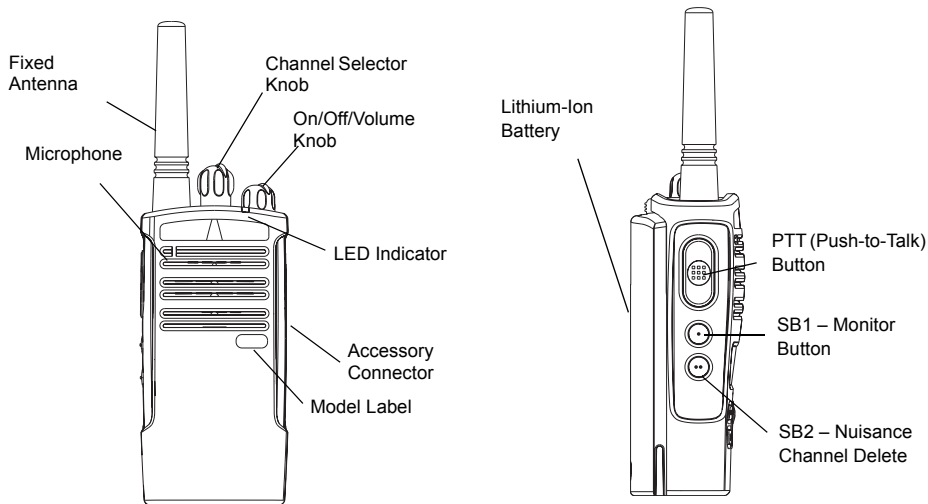

On/Off/Volume Knob

Used to turn the radio ON or OFF and to adjust the radio's volume.

Channel Selector Knob

Used to switch the radio to different channels.

Accessory Connector

Used to connect compatible audio accessories.

Microphone

Speak clearly into the microphone when sending a message.

Fixed Antenna

The antenna is not removable.

LED Indicator

Used to give battery status, power-up status, radio call information and scan status.

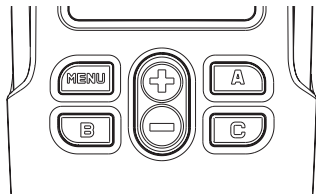
Front Buttons (RDM2080d Model Only)

-  **Button**

This button provides access to set up features like VOX/iVOX levels, battery type, etc. It also allows for navigation through various features while configuring the unit.

-  **Toggle Up/Down Buttons**

Used to change channels and to scroll up/down menu options or set up configurable values. These buttons are not configurable.











Configurable Buttons

Button	Monitor	Scan / Nuisance Delete	Call Tone	Scramble	Backlight	Channel Preset 1	Channel Preset 2	No Operation
SB1	Default	✓	✓	✓	N/A	N/A	N/A	✓
SB2	✓	Default	✓	✓	N/A	N/A	N/A	✓
BUTTON A (*)	✓	✓	Default	✓	✓	✓	✓	✓
BUTTON B (*)	✓	✓	✓	✓	✓	Default	✓	✓
BUTTON C (*)	✓	✓	✓	✓	✓	✓	Default	✓

Buttons are configured to default functions, other features may be assigned to these buttons as shown in the table.

(*) RDM2080d Model only

Icons Chart (RDM2080d Model)

Icon	Symbol	Comments
Battery Level		Displayed during normal radio mode operation, displays battery life remaining.
Channel		Displayed during normal radio operation and when programming channel features.
Code		Displayed during normal radio operation and when programming codes features.
Frequency		Displayed during normal radio operation.
Keypad lock		Displayed whenever the Keypad lock feature is enabled (keypad is locked).
Program		Displayed whenever the radio is set up to Advanced Configuration Mode.
Scan		Displayed whenever the radio is set to SCAN mode.
Scramble		Displayed whenever scramble is enabled.
Signal Strength		RSSI Display Icon numbers of bars will indicate the strength of the received signal.
Vox/IVox		Displayed when IVOX/VOX enabled or when programming MIC/MIC gain features.

BATTERY FEATURES

The RDM Series MURS Two-Way Radio provides Lithium-Ion batteries that come in different capacities that will define the battery life. It also offers the option to use Alkaline batteries.

About the Li-Ion Battery

The RDM Series MURS Two-Way Radio comes equipped with a rechargeable Li-Ion battery. This battery should be charged before initial use to ensure optimum capacity and performance.

Motorola batteries are designed specifically to be used with a Motorola charger and vice versa. Charging in non-Motorola equipment may lead to battery damage and void the battery warranty. The battery should be at about 77 °F (25 °C) (room temperature), whenever possible. Charging a cold battery (below 50 ° F [10 °C]) may result in leakage of electrolyte and ultimately in failure of the

battery. Charging a hot battery (above 95 °F [35 °C]) results in reduced discharge capacity, affecting the performance of the radio.

Motorola rapid-rate battery chargers contain a temperature-sensing circuit to ensure that batteries are charged within the temperature limits stated above.

Battery Recycling and Disposal

Li-Ion rechargeable batteries can be recycled. However, recycling facilities may not be available in all areas. Under various U.S. state laws and the laws of several other countries, batteries must be recycled and cannot be disposed of in landfills or incinerators. Contact your local waste management agency for specific requirements and information in your area. Motorola fully endorses and encourages the recycling of Li-Ion batteries. In the U.S. and Canada, Motorola participates in the nationwide Rechargeable Battery Recycling Corporation (RBRC) program for Li-Ion battery collection and recycling.

Many retailers and dealers participate in this program. For the location of the drop-off facility closest to you, access RBRC's Internet web site at:

<http://www.call2recycle.org/>

or call:

1-800-8-BATTERY

This internet site and telephone number also provides other useful information concerning recycling options for consumers, businesses and governmental agencies.

DROP-IN TRAY CHARGER AND POWER SUPPLY

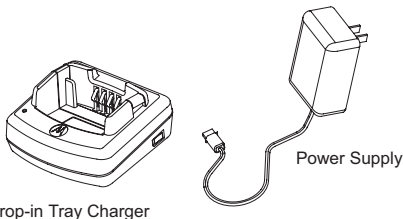

The radio is equipped with one Drop-in Tray Charger and one Power Supply with Adaptor. For details, see "Chargers" on page 67.

Installing the Battery

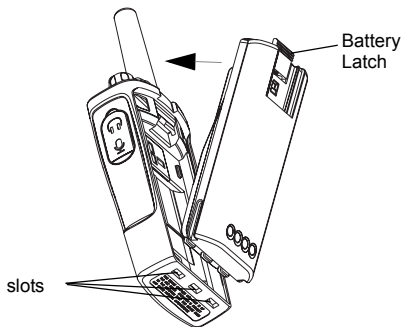

1. Turn OFF the radio.
2. With the Motorola logo side up, fit the tabs at the bottom of the battery into the slots at the bottom of the radio.
3. Press the top part of the battery towards the radio until a click is heard.

Removing the Battery

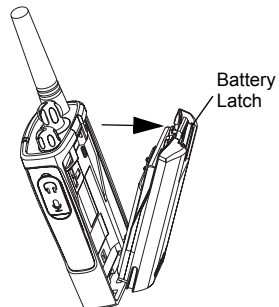

1. Turn OFF the radio.
2. Push down and hold the battery latch.
3. Pull the top of the battery out and lift it from the slots located at the bottom of the radio.

Alkaline Battery Pack (Optional)

Installing Alkaline Batteries

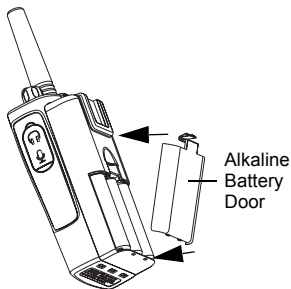

1. Turn OFF the radio and remove the Li-Ion battery.
2. Assemble alkaline battery frame in the same steps as installing the Li-Ion battery.
3. Pull the battery door from alkaline battery frame out and slide five AA alkaline batteries into the frame, matching the markings inside the compartment.
4. Replace the battery door on the battery frame.

Removing Alkaline Batteries

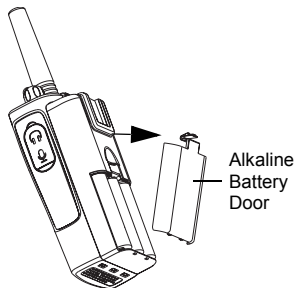

1. Turn OFF the radio and remove the battery door on the battery frame.
2. Remove the five AA alkaline batteries from the battery frame.
3. Replace the battery door on the battery frame.
4. Slide the battery latches, on both sides of the battery pack to remove the battery frame.

Li-Ion Battery Life

When the Battery Save feature is ON (enabled by default) the battery life will be longer. The following chart summarizes battery life estimations:

Li-Ion Battery Life with Battery Save feature ON	
Battery Type	2 Watts
Standard	12 hours
High	24 hours
Ultra High	26 hours

Note: Battery life is estimated based on the following standard duty cycle: 5% Transmit, 5% Receive and 90% Standby.

Alkaline Battery Life



The following chart estimates the Alkaline battery life:

Alkaline Battery Life	
Battery Save Feature	2 Watts
ON	26 hours

Note: Battery life is estimated based on the following standard duty cycle: 5% Transmit, 5% Receive and 90% Standby.

Battery Meter (RDM2080d Model)

The battery meter located in the upper left corner of the display model indicates the remaining battery power.

RDM Series Battery Meter			
Battery Type	3 Bars	2 Bars	1 Bar
			
Li-Ion	100% – 70%	70% – 30%	30% – 0%
AA	100% – 70%	70% – 30%	30% – 0%

CHARGING THE BATTERY

The RDM Series MURS Two-Way Radio offers a Standard Charger and a Rapid Charger, which are designed to charge either the battery with the radio or a standalone battery.

The RDM radio comes equipped with a Standard Charger.

Use only use Motorola-approved Drop-in Tray Single Unit Charger or Drop-in Tray Multi Unit Charger to charge the Motorola-approved battery.

Note: When acquiring additional chargers or power supplies, make sure you have similar drop-in tray chargers and power supplies sets (all “rapid” or all “standard”). For part number details, refer to “Chargers” on page 67.

Charging The Battery Attached to the Radio

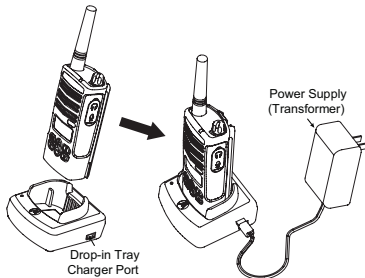

1. Place the drop-in tray charger on a flat surface.
2. Insert the connector of the power supply into the port on the side of the drop-in tray charger.
3. Plug the AC adaptor into a power outlet.
4. Insert the radio with battery into the tray with the front of the radio facing the front of the charger.

Note: Before charging a battery attached to a radio, turn the radio OFF to ensure a full charge. See “Operational Safety Guidelines” on page vi for more information.

Charging a Standalone Battery

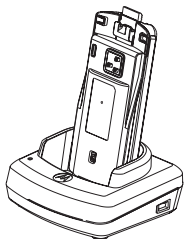

To charge a stand alone Motorola battery, follow steps 1 to 3 in the previous section and insert the battery into the tray, with the inside surface of the battery facing the front of the charger. Ensure the slots in the battery correctly engage in the charger (see next section for battery type details).

Charging a Standard Battery

The drop-in tray charger has a removable bracket that is adjustable depending on the type of battery that needs to be charged. The drop-in tray charger's default position will charge a standard battery. The following image shows the orientation of the bracket for each battery:

Adjustable bracket
with slots on the top

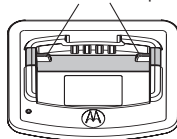

Standard

Adjustable bracket
with slots on the bottom

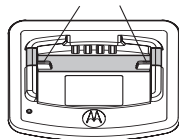

High and Ultra High Capacity

Charging a High Capacity or Ultra High Capacity Battery

The bracket in the charger must be adjusted to the correct position for either Standard or High capacity battery.

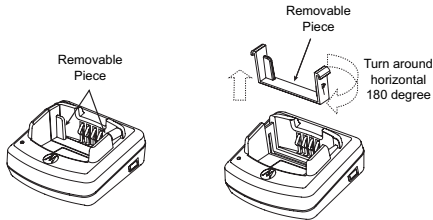

To adjust the charger to accommodate the High capacity or Ultra High capacity battery:

1. Squeeze both tabs on each side of the removable bracket in the drop-in charger tray and lift the bracket from the tray.
2. Rotate the removable bracket 180 degrees and replace it by fitting it in the charger slot until it snaps. The label on the removable bracket should show "High & Ultra Capacity Battery" facing the front of the charger.
3. Repeat same procedure to return to the charging a Standard Battery position. The label on the removable bracket should show "Standard Battery" facing front.

Drop-in Tray Charger LED Indicators

Standard Charger LED Indicator		
Status	LED Status	Comments
Power ON	Steady red for 3 seconds	The charger has powered up
Charging	Blinking red (slow)	The charger is currently charging
Charging Complete	Steady red	Battery is fully charged
Battery Fault(*)	Blinking red (fast)	Battery had a fault when it was inserted

(*) Normally re-seating the battery will correct this issue.

Rapid Charger LED Indicator

Status	LED Status	Comments
Power ON	Steady green for 3 seconds	The charger has powered up
Charging	Blinking green	The charger is currently charging
Top-off Charging	Blinking green (slow)	Battery is near fully charged
Charge Complete	Steady green	Battery is fully charged
Battery Fault (*)	Blinking red (fast)	Battery had a fault when it was inserted
Waiting to Charge (**)	Double-blink yellow	Battery charging conditions not suitable

(*) Normally re-seating the battery pack will correct this issue.

(**) Battery temperature is too warm or too cold or wrong power supply is being used

Estimated Charging Time

The following table provides the estimated charging time of the battery. For further details, see "Battery" on page 66.

Estimated Charging Time			
Charging Solution	Battery Type		
	Standard	High Capacity	Ultra High Capacity
Standard Charging Solution	7 hours	12 hours	13 hours
Rapid Charging Solution	1.5 hours	3 hours	3.5 hours

Charging Batteries using a Multi Unit Charger- MUC (Optional)

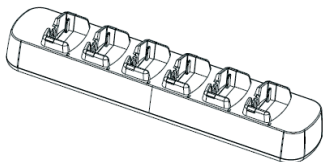

The Multi Unit Charger (MUC) allows drop-in charging of up to 6 batteries with radios attached or stand alone batteries.

To charge the batteries follow the same procedure described for the Single Unit Charger.

Note: The Multi Unit Charger is capable of cloning up to 3 radios (3 Source radios and 3 Target radios). See "RADIO Cloning" on page 30 for details.

MUC LED Indicator

Status	LED Status	Comments
Charging	Steady Red Indication	The charger is currently charging
Charge Complete	Steady Green Indication	Battery is fully charged
Battery Fault (*)	Blinking red (fast)	Battery was faulty when inserted
(*) Normally re-seating the battery pack will correct this issue.		

INSTALLING SPRING ACTION BELT CLIP

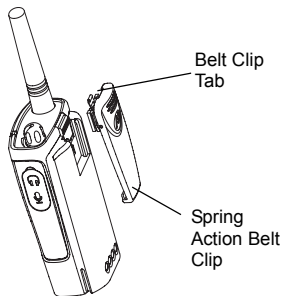

1. Slide the spring action belt clip rails into the belt clip grooves on the back of the battery and slide it down until the belt clip tab snaps into place.
2. To remove, pull back the metal release tab on the belt clip tab and push the spring action belt clip upward to remove. (If needed, use a small flat screw driver to leverage the metal release).

GETTING STARTED

TURNING RADIO ON/OFF

Turn the On/Off/Volume knob clockwise to turn ON the radio. The radio will chirp and the LED will briefly blink a red light.

To turn the radio OFF rotate the On/Off/Volume knob counterclockwise until you hear a “click” and the radio LED indicator turns OFF.

ADJUSTING VOLUME

Turn the On/Off/Volume knob clockwise to increase the volume, or counterclockwise to decrease the volume.

READING THE DISPLAY (RDM2080d MODEL)

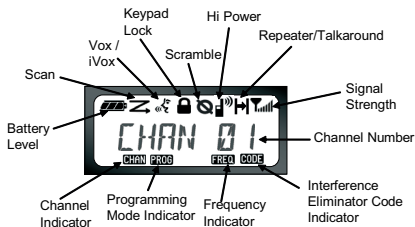

Note:

- The radio display shown here is for icon location only. Each radio display may appear different (channel and code) based on the pre configured radio defaults. Pressing any button, except the PTT button, will turn on the backlight.
- Repeater capability is not available for these radio models.

SELECTING A CHANNEL

To select a channel on the RDM2080d model, press the toggle \oplus/\ominus buttons until you reach the desired channel.

To select a channel on the RDM2020 model, rotate the Channel Selector Knob and select either Channel 1 or 2.

TALKING AND MONITORING

It is important to monitor traffic before transmitting to ensure that you do not “talk over” someone who is already transmitting.

Note: The monitoring feature is pre-configured on the SB1 button.

To start monitoring and talking:

1. Press and hold the SB1 button to access channel traffic. If no activity is present, the radio emits a static noise.
2. Press the SB1 button again to release.
3. Once channel traffic has cleared, press the PTT button to talk. When transmitting, the radio LED blinks red.

RECEIVING A CALL

1. Select a channel by pressing the toggle buttons \oplus/\ominus until you reach the desired channel.
2. Make sure the PTT button is released and listen for voice activity.
3. The LED indicator blinks RED while your radio is receiving.
4. To respond, hold the radio vertically 1 to 2 inches (2.5 to 5 cm) from your mouth. Press the PTT button to talk; release it to listen.

SCAN

The scan mode allows the radio to move through the channel scan list looking for eligible transmission activity to receive or to un mute to. The scanning feature is pre configured in the SB2.

To toggle scanning on/off:

1. Short press the SB2 button. When a transmission is detected, the radio stops scanning and stays on the active channel.

Whenever the radio is set up in “Scan Mode” the LED will signal a fast red blink.

If there is transmission in another channel during this time, the radio will stay on the active channel and the transmission on the other channel will not be heard.

When the transmission is over in the active channel, the radio will wait for 5 seconds before resuming Scan again.

2. To scan a channel without Interference Eliminator Codes (CTCSS/DPL), set the code for the channels to '0' in the CTCSS/DPL Advanced Configuration Mode.

Note: If Auto-Scan has been enabled for a particular channel, there is no need to press the SB2 to start scanning, as the radio will do it automatically.

SIGNAL STRENGTH AND CHANNEL BUSY INDICATORS (RDM2080d MODEL)

While receiving, the radio displays the strength indicator icon  and the LED blinks faster. The signal strength icon can change from one bar (weakest) to six bars (strongest) depending on the radio reception coverage. This can help determine when a radio is moving out of range.

Note: Obstacles that block the signal path may affect the strength of the incoming signal.



LOW BATTERY ALERT

This feature provides a sequence of loud and high beep tones to alert that the battery level is low. The LED blinks orange several times. The RDM2080d also provides a battery gauge icon on the screen that indicates the battery level as shown in the previous image.

TALK RANGE

<i>Industrial</i>	<i>Multi-Level</i>
Inside steel/concrete Industrial buildings	Inside multi-level buildings
Up to 220,000 Sq. Ft.	Up to 13 Floors

COMPUTER PROGRAMMING SOFTWARE

In addition to the features that can be configured in Basic and Advanced Configuration via the radio panel, the Computer Programming Software (CPS) can additionally configure Transmit Time-Out Timer, PL Reverse Burst, Alternate Battery Selection, Backlight settings, Buttons Reset, CPS Manager Lock, LED enabled/disabled, Power Up Text, and Edit Scan List.

The Programming Cable RKN4155 (sold separately) is required. The CPS Software is available for download at no cost at: www.motorola.com/RDX

To configure the radio using the CPS, connect the radio via the Drop-in Charger Tray and CPS Programming Cable as shown in the picture below.

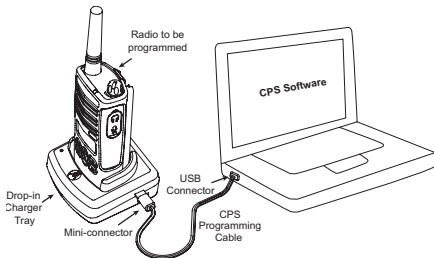

Transmit Time-Out Timer

This timer sets the amount of time (60, 120 or 180 sec.) that the radio can continuously transmit before transmission is automatically terminated. A continuous tone is generated when this timer expires, indicating a time-out.

PL Reverse Burst

PL Reverse Burst causes a Private Line (PL) code to be sent at the end of a transmission once the PTT button is released. This sub-audible tone causes the receiving radio to mute its speaker before loss of a carrier is detected. Muting the speaker eliminates unwanted noise (squelch tail) during loss of carrier detection.

Choices available are: 180/240.

Alternate Battery Selection

The radio is capable of supporting multiple batteries solutions; therefore, the user can configure a battery type when using the accessory battery pack tray, only when the radio does not detect a valid battery type on its own. Choices available are: Alkaline, Nickel, and Lithium Ion.

RADIO CLONING

The RDM Series MURS Two-Way radio profiles from one radio (the “Source” radio) to a second radio (the “Target” radio) by using any one of these 3 methods:

- One Multi Unit Charger (optional accessory)
- Two Single Unit Chargers and a Radio-to-Radio cloning cable (optional accessory)
- the CPS (free software download)

Cloning with a Multi-Unit Charger (MUC)

The Source radio has to be in Pocket 1, 3 or 5 while the Source radio to be cloned has to be in Pockets 2, 4 or 6, matching in the MUCs pockets by pairs as follows: 1 and 2 or 3 and 4 or 5 and 6.

When cloning, the MUC does not need to be plugged into a power source, but ALL radios require charged batteries.

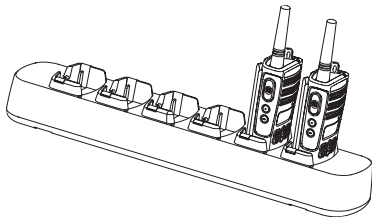

To clone radios with the MUC:

1. Turn ON the Target radio and place it into one of the MUC Target Pockets
2. Power the Source radio following the sequence below:
Long press the PTT button and SB2 simultaneously while turning the radio ON. Wait for 3 seconds before releasing the buttons until a distinctive audible tone is heard.

BASIC CONFIGURATION

MENU OPTIONS (RDM2080d MODEL)

The menu options only activate whenever there is an audio accessory connected to the radio, iVOX is enabled and/or a battery type has been changed.

To enter MENU options:

1. Short press the MENU button. The radio will navigate to the first feature option available.

Features can be navigated with the  buttons.

2. After selecting the desired settings, press MENU to save and go to the next option, or long press the PTT button to save and exit or turn OFF the radio to exit without saving changes.

Note: When there is no activity for more than ten seconds, MENU mode will time out.

BATTERY SAVE

This feature extends the battery life by placing the radio in “Idle” mode each time there is no radio activity. The battery safe feature default setting is set ON.

To toggle Battery Save on/off:

1. Press SB1 and SB2 simultaneously for 2 or 3 seconds while powering up the radio until a quick series of beeps is heard, which indicates that Battery Save mode is ON.
2. Repeat step one until the standard power-up tone is heard, which indicates that Battery Save mode is OFF.

Note: The transmission threshold increases when Battery Save mode is ON. To have a slightly better transmission threshold, set Battery Save mode to OFF so that the radio is always ready to transmit or receive without any delays.

BATTERY TYPE SETTINGS (RDM2080d MODEL)

Only if the battery pack is not detected, the radio will enable the battery type setting to select either Lithium-Ion or Alkaline.

To change battery settings:

1. Press the MENU button as many times as needed until the radio shows the current battery type. The display will show either "LITHIUM" or "ALKALINE". Also a full battery icon will be shown as follows:



2. Select the battery setting according to the battery being installed on the radio.
3. Press the PTT button to save the changes.

CHANNEL ALIAS (RDM2080d MODEL)

This feature allows the editing of the channel name or alias.

To configure channel alias:

1. Press PTT button and \oplus simultaneously while turning radio ON for 3 sec. The radio will emit a special beep. The display will show the channel alias blinking as shown.



2. Choose the channel number that will be edited by pressing the \oplus/\ominus buttons.
3. Press the PTT button or MENU to start editing the channel name. A cursor will blink at the end of the channel name.

4. Use button **B** to move the cursor to the left.



5. When the cursor is located in the first character, the radio produces a bonk tone.
6. Use the \oplus/\ominus buttons to change the current selected character to the next ASCII value in alphabetical order (from A to Z). The characters will be uppercase letters.
To toggle character between uppercase and lower case, press the **A** button. The supported lower case characters are:
b, c, d, g, h, i, l, o, r, u.
To insert special characters press the **C** button. The supported special characters and numbers are shown in the following order: 0 - 9 * {}? &% . + / - _ ' ' \. Character (') is used for blank spaces.

Note: If the radio is left idle for more than 3 seconds, the current character will be accepted and the cursor will advance one space to the right.

7. Long press the PTT button to save and go back to the “Channel Aliasing Selection Mode” to edit other channel alias name, -- or --
Turn OFF the radio to exit without saving changes.

Notes: If the channel alias name is left blank, the radio will play a bad key chirp and will stay in the editing menu mode until the channel name is edited and saved.
To exit Channel Aliasing Mode, long press the PTT button.

CLONING MODE

Enables radio to enter cloning mode in order to clone its profile settings into other radios (using the Radio to Radio Cloning Cable or Multi-Unit Charger).

To enable/disable Cloning Mode:

1. Press PTT and SB2 buttons while turning the radio ON.
The RDM2080d emits a distinctive sound and shows the word CLONE on the display.
The RDM2020 emits a distinctive sound and the LED indicates two orange heartbeats
2. Turn the radio OFF and back ON to disable Cloning mode.

Note: See "RADIO Cloning" on page 30 for more details.

ROGER BEEP TONE (END OF TRANSMISSION TONE)

This feature allows the radio to send a distinct tone at the end of each transmission. The Roger Beep default setting is set to OFF.

To toggle Roger Beep Tone on/off:

1. Short press the SB1 button while turning the radio ON until a distinctive beep is heard, which indicates that Roger Beep Tone is ON.
2. Repeat step one until the standard power-up

tone is heard, which indicates that Roger Beep Tone is OFF.

Note: The tone sent at the end of each transmission is intended to notify the receiver that the transmission is complete.

KEYPAD BEEP (RDM2080d MODEL)

This feature enables the radio to emit an audible tone each time a button is pressed. Turning this beep off enables silent menu operation.

To toggle Keypad Beep on/off:

1. Short press SB2 button while turning the radio ON. The keypad operation will be silent.
2. Repeat step one to activate the keypad beep.

KEYPAD LOCK/UNLOCK (RDM2080d MODEL)

The keypad can be locked to avoid accidental changes in the radio settings. The keypad lock default setting is set to UNLOCKED. When the keypad is locked, an icon is displayed on the screen.



To toggle Keypad Lock on/off:

1. Press and hold MENU for 4 seconds to lock the radio keypad. All buttons lock with the exception of the PTT and Button A if “Call Tone” has been configured.
2. To unlock, press MENU for 4 seconds.

Note: This feature can be disabled from being configured via the radio panel in the CPS.

VOX - VOICE OPERATED TRANSMIT

Enables the radio to automatically transmit due to recognition of voice. The radio automatically stops transmitting when audio is no longer present.

Before using this feature, the VOX level must be configured via the CPS. The default value for VOX level is set to OFF.

To set up a VOX accessory:

1. Turn the radio OFF and open the accessory cover.
2. Firmly insert the plug from the audio accessory into accessory port.
3. Turn the radio back ON. The radio will beep and the LED blinks double red. The RDM2080d shows the VOX icon .
4. Lower radio volume **BEFORE** placing accessory near ear.
5. To transmit, speak into accessory microphone without pressing the PTT button.

6. To receive, stop talking.

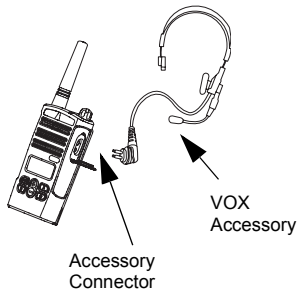

Note: VOX can be temporarily disabled by pressing the PTT button or removing the audio accessory.

IVOX - INTERNAL VOICE OPERATED TRANSMIT (RDM2080d MODEL)

Enables the radio to automatically transmit due to recognition of voice without the use of audio accessories. The radio automatically stops transmitting when audio is no longer present.

To enable iVOX on the radio:

1. Press and hold the PTT button while turning the radio ON. The display will show the  icon.
2. To transmit, talk directly into the microphone without pressing the PTT button. There is a short threshold in the transmission that can be adjusted by changing the iVOX level in the CPS.
3. Turn OFF the radio to disable iVOX.

Note: iVOX operation can be temporarily disabled by pressing the PTT button while the radio is ON.

VOX/IVOX SENSITIVITY SETTINGS (RDM2080d MODEL)

Before changing VOX sensitivity settings, this feature must be configured via the CPS and an audio accessory must be connected to the radio. Before configuring iVOX sensitivity, the iVOX feature must have been enabled by pressing the PTT button while powering up the radio. The default sensitivity value for VOX is

set to OFF and the default sensitivity value for iVOX is set to Medium.

To configure VOX/iVOX sensitivity:

1. Short press the MENU button and navigate until the following screens are displayed:
If iVOX is enabled the radio will display the following:



If VOX is enabled (with accessory connected) the radio will display the following:



2. To change the sensitivity level, use the (+) / (-) buttons and choose from the following options:

0 = OFF (For VOX accessories only)

1 = Low sensitivity

2 = Medium sensitivity

3 = High sensitivity

3. Long press the PTT button to save and exit, --or-- short press the PTT button to configure the next feature without saving.

NUISANCE CHANNEL DELETE

This feature temporarily removes channels from the “Scan List” to disregard irrelevant conversations on a “nuisance” channel that tie up the radio’s scanning.

To delete a channel from the scan list:

1. Short press the SB2 button to enable “Scan Mode.” This feature is pre configured by default.
2. Wait until the radio stops on the “nuisance” channel.
3. Long press the SB2 button. The nuisance channel is temporarily deleted during the scanning session.

Note: The next time Scanning is enabled, the channel will be back in the scanning list.

PL DEFEAT

Also known as “Squelch defeat”, this feature allows to listen or monitor any activity in the channel without noise.

To toggle PL Defeat on/off:

1. Short press SB1 to enable PL/DPL defeat.
2. Short press SB1 again to disable PL/DPL defeat.

RESET TO FACTORY DEFAULTS

Reset to Factory Defaults will set back all radio features to the original factory default settings. To do so, press the PTT, SB2 and SB1 buttons simultaneously while turning ON the radio until you hear a high tone chirp.

ADVANCED CONFIGURATION

Advanced Configuration is an optional configuration mode that allows the customization of additional features via the front panel.

To establish a proper two-way communication, the Channel, Frequency, and Interference Eliminator Code must be the same on both radios, which will depend on the stored profile that has been pre configured on the radio.

ENTERING ADVANCED CONFIGURATION MODE

To enter Advanced Configuration Mode, press and hold both PTT and SB1 buttons simultaneously for 3 to 5 seconds while turning radio ON. The LED will start to blink green. The RDM2080d will also show the icon **PROG** on the screen.

These features can be configured in Advanced Configuration Mode:

FREQUENCY SELECTION

Any of the preset MURS frequencies can be assigned to each channel. See "RDM Series MURS Frequency Chart" on page 50.

CTSS/DPL CODES

This feature also called Interference Eliminator Code, helps minimize interference by offering a choice of code combinations that filter out static, noise, and unwanted messages. See code table "CTCSS and PL/DPL Codes" on page 52 for specific code details.

AUTO SCAN

This feature enables to set a particular channel to automatically start scanning each time that channel is selected.

ADVANCED CONFIGURATION (RDM2080d MODEL)

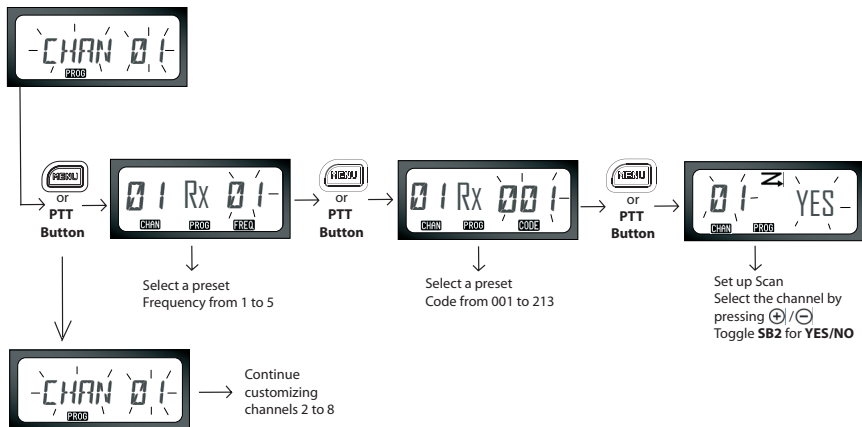

- Notes:** To save changes long press the PTT button. The radio will return to “Idle” Advanced Configuration Mode. To exit Advanced Configuration Mode, long press the PTT button to return to normal radio operation. Whenever the radio wraps around to the beginning of the Advanced Configuration Mode options, the changes will be automatically saved, even if the radio is turned OFF. To exit Advanced Configuration Mode without saving changes (as long as the radio has not return to the beginning), turn the radio OFF.

OTHER ADVANCED CONFIGURATIONS (RDM2080d MODEL ONLY)

Call Tone

This feature sends an alert notification to other radios in the fleet prior to the transmission with the intent to grab the receiver's attention so the transmission is not missed.

In order to configure this feature via the front panel, it must first be enabled via the CPS.

To configure call tones:

1. Enter "Advanced Configuration Mode" and scroll through the menu options until the screen shows the image below:



The current call tone setting will be blinking. A call tone value (0,1,2 or 3) must be selected by pressing the \oplus/\ominus buttons. The call tone will pre-play before being selected.

2. Long press the PTT button to save and exit, --or-- short press the PTT button to configure the next feature without saving.

Microphone Gain Level

The sensitivity of the microphone can be adjusted in both the radio's microphone and the accessory's microphone to fit different users or operating environments.

The Gain determines the microphone's transmitted audio volume level for the receiving radio's speaker.

To configure microphone gain level:

1. Enter "Advanced Configuration Mode" and scroll through the options by short pressing the PTT button until the screen shows the image below:



The current microphone gain level setting will blink.

2. Select the desired microphone gain level by pressing the \oplus/\ominus buttons (1 = low gain, 2 = Medium gain or 3 = high gain).
3. Long press the PTT button to save and exit, --or-- short press the PTT button to configure the next feature without saving.

To configure Accessory Microphone Gain:

1. Enter Advanced Configuration Mode and scroll through the configuring options by short pressing the PTT button until the screen shows the image below:



The current accessory microphone gain level setting will be blinking.

2. Select the desired gain level (1 = Low gain, 2 = Medium gain or 3 = High gain) by pressing the \oplus/\ominus buttons.

3. Long press the PTT button to save and exit --or-- short press the PTT button to configure the next feature without saving.

Scramble

This feature provides voice privacy by encrypting the transmission. Transmissions will sound garbled to anyone listening without the same Scramble Code activated on their radio. It does not guarantee confidentiality, but it does increase privacy.

To enable scramble:

1. Enter Advanced Configuration Mode and selected the channel in which scramble will be enabled.

2. Scroll up/down through the configuring options by short pressing the PTT button, until the screen shows the image below:



The current scramble setting will blink.

3. Select the desired scramble value (0,1,2 or 3) by pressing the \oplus/\ominus buttons.
4. Long press the PTT button to save and exit, --or-- short press the PTT button to configure the next feature without saving.

Side Button Preset to Channel Select

Any channel can be mapped to either button **B** or **C** as a preset channel.

To map a channel to a side button:

1. Enter “Advanced Configuration Mode” and choose the channel to be preset using the \oplus/\ominus buttons.
2. Press and hold the **B** or **C** button for 2 to 3 seconds. A short press of either preset button (B and C) will play a good key chirp.

Note: When scanning, a short press of either preset button will change the home channel to the preset channel. The display will show **FREQ/PL** and will continue to scan from the new home channel.

ADVANCED CONFIGURATION (RDM2020 MODEL)

Before start configuration, the channel must be selected. This can be done before or at any time during the Advanced Configuration Mode by turning the Channel Selector knob to the desired channel.

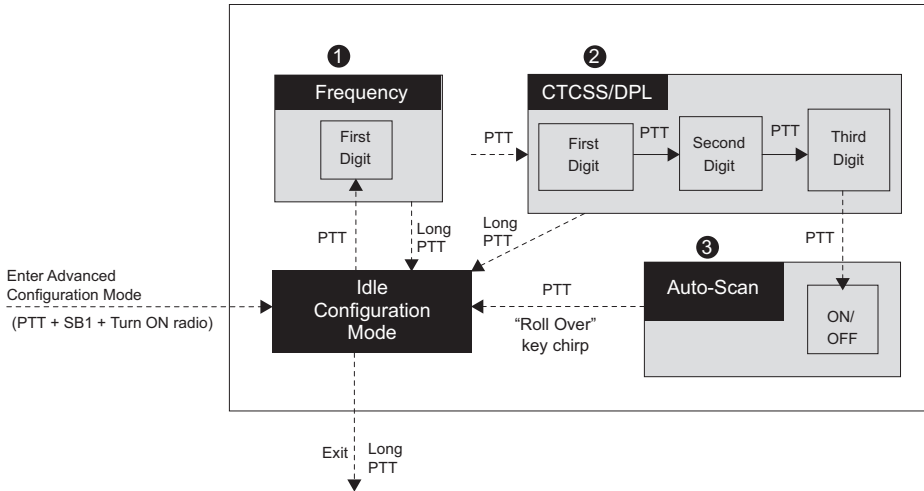

Reading Values Through Beeps and LED Indicators

As the RDM2020 model does not have a display to show the values that are being configured, the radio will communicate this information using beeps and LED indications.

Number	Confirmation Beep	LED Indication
0	Zero beep	One short orange blink
1	One beep	One short red blink
2	Two beeps	Two short red blinks
3	Three beeps	Three short red blinks
4	Four beeps	Four short red blinks
5	Long beep	One long red blink
6	Long beep and one beep	One long and one short red blinks
7	Long beep and two beeps	One long and two short red blinks
8	Long beep and three beeps	One long and three short red blinks
9	Long beep and four beeps	One long and four short red blinks

Reading Frequency Values

The Frequency value is only one digit as RDM Series MURS Two-Way radios have 5 predefined frequencies.

To read frequency values:

1. From "Idle" Advanced Configuration Mode, short press the PTT button to hear the first value (Refer to "Advanced Configuration (RDM2020 Model)" on page 44). This value corresponds to the frequency's first digit value.

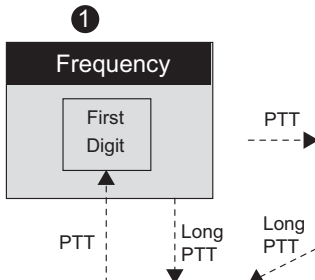

2. Short press the PTT button to read CTCSS/DPL values.

Reading CTCSS/DPL Values

When reading the values for CTCSS/PL Codes the radio signals the digit codes each time the PTT button is short pressed. The RDM Series have up to 213 codes available (Refer to "Frequency and Code Charts" on page 50).

The following is an example of the order in which the radio signals the "118" CTCSS/DPL code:

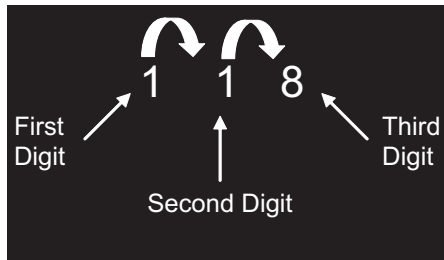

To read CTCSS/DPL Values:

1. Short press the PTT button. The radio signals the first digit "1".

2. Short press PTT button again and the radio signals the second digit “1”.
3. Short press PTT again and radio signals the third digit “8”.

Reading Auto-Scan Values

After finishing reading CTCSS/DPL codes, if you short press PTT once again, the radio takes you to Auto-Scan as per “Advanced Configuration (RDM2020 Model)” on page 44 (Step 3). Auto-Scan only has two values:

<i>Radio Signal Value</i>	<i>Status</i>
0	OFF
1	ON
Note: Auto-Scan is set to OFF by default.	

Changing Values

Each time the radio signals and beeps, the current value can be changed by short pressing SB1 to increase or by short pressing SB2 to decrease. The radio will then signal the new setting it has been configured to.

To abort the value configured, turn the radio OFF or change channel using the channel knob.

If the radio “rolls-over” to the “Idle” Advanced Configuration Mode, the radio emits a “chirp” and radio LED starts blinking green again. All values that were changed are automatically saved.

Configuring a Frequency

Assuming current frequency value is set up to channel 1, with the MURs default frequency “1” (equivalent to 154.60000 MHz), and it will be changed to Frequency Number = “4” (which is mapped to 151.88000 MHz), follow the sequence below:

1. Enter Advanced Configuration Mode.
2. Short press the PTT button to enter Frequency Mode. Radio will signal current value “1” with one beep (a red blinks).
3. Press the SB1 button once to increase digit to “2” (two beeps & two red blinks).
4. Press the SB1 button once to increase digit to “3” (three beeps & three red blinks).
5. Press the SB1 button again to increase digit to “4” (four beeps & four red blinks).
6. Long press the PTT button. LED indicator will show a green heartbeat to indicate “Idle” state.
7. Long press the PTT button to exit Advanced Configuration Mode or turn the radio OFF.

Configuring a Code

Assuming current code value is set to factory default “001”, and it will be changed to CTCSS/DPL Code = 103 follow the sequence below:

1. Enter Advanced Configuration Mode.
2. Short press the PTT button three times (Enter CTCSS/DPL Programming Selection Mode). Radio LED will blink orange to indicate that current value is “0”.
3. Press the SB1 button once (to change first digit to “1”) LED indicator blinks red.
4. Short press the PTT button (to move forward and program second digit). Radio LED blinks orange to indicate current value is “0”.
5. Short press the PTT button and move ahead to program the third digit. LED indicator blinks red to indicate current value is “1”.
6. Press the SB1 button to change the ‘third digit’ to “2”. Press the SB1 button to change again this “third digit” to “3”. The radio will signal the chosen value.

7. Long press the PTT button to save changes and return to “Idle” Advanced Configuration Mode. Once in “Idle” Advanced Configuration Mode, LED indicator will start blinking a green heartbeat.
8. Long press the PTT button to exit Advanced Configuration Mode.

Configuring Auto-Scan

Auto-Scan is the last Advanced Configuration Mode and can be set to “ON” or “OFF” on a particular channel.

To set Auto-Scan to “ON”:

1. Enter Advanced Configuration Mode and select the desired channel.
2. Short press the PTT button six times to enter Auto-Scan Programming Selection Mode. The radio will signal beeps and will show the current Auto-Scan setting (refer to “Reading Auto-Scan Values” on page 47).
3. Short press the SB1 button to toggle ON/OFF the Auto-Scan feature in the channel. When ON radio LED will blink RED once. When OFF radio LED will blink ORANGE once.

FREQUENCY AND CODE CHARTS

RDM SERIES MURS FREQUENCY CHART

RDM2080d MURS Display Model – Default Frequencies and Codes

Channel	Frequency (MHz)	Code #	Code Value	Channel Name/Alias	Bandwidth
1	154.570	1	67.0 Hz	Channel 1	20.0 kHz
2	154.600	1	67.0 Hz	Channel 2	20.0 kHz
3	151.820	1	67.0 Hz	Channel 3	11.25 kHz
4	151.880	1	67.0 Hz	Channel 4	11.25 kHz
5	151.940	1	67.0 Hz	Channel 5	11.25 kHz
6	154.570	0	CSQ	Channel 6	20.0 kHz
7	154.600	0	CSQ	Channel 7	20.0 kHz
8	151.820	0	CSQ	Channel 8	11.25 kHz

RDM2020 MURS Non-Display Model – Default Frequencies and Codes

Channel	Frequency (MHz)	Code #	Code Value	Channel Name/Alias	Bandwidth
1	154.570	1	67.0 Hz	Channel 1	20.0 kHz
2	154.600	1	67.0 Hz	Channel 2	20.0 kHz

CTCSS AND PL/DPL CODES

CTCSS Codes

CTCSS	Hz		CTCSS	Hz		CTCSS	Hz
1	67.0		14	107.2		27	167.9
2	71.9		15	110.9		28	173.8
3	74.4		16	114.8		29	179.9
4	77.0		17	118.8		30	186.2
5	79.7		18	123		31	192.8
6	82.5		19	127.3		32	203.5
7	85.4		20	131.8		33	210.7
8	88.5		21	136.5		34	218.1
9	91.5		22	141.3		35	225.7
10	94.8		23	146.2		36	233.6
11	97.4		24	151.4		37	241.8
12	100.0		25	156.7		38	250.3
13	103.5		26	162.2		122 (*)	69.3

Note: (*) New CTCSS code.

PL/DPL Codes (cont.)

DPL	Code		DPL	Code		DPL	Code
39	23		55	116		71	243
40	25		56	125		72	244
41	26		57	131		73	245
42	31		58	132		74	251
43	32		59	134		75	261
44	43		60	143		76	263
45	47		61	152		77	265
46	51		62	155		78	271
47	54		63	156		79	306
48	65		64	162		80	311
49	71		65	165		81	315
50	72		66	172		82	331
51	73		67	174		83	343
52	74		68	205		84	346
53	114		69	223		85	351
54	115		70	226		86	364

PL/DPL Codes (cont.)

DPL	Code		DPL	Code		DPL	Code
87	365		104	565		121	754
88	371		105	606		123	645
89	411		106	612		124	Customized PL
90	412		107	624		125	Customized PL
91	413		108	627		126	Customized PL
92	423		109	631		127	Customized PL
93	431		110	632		128	Customized PL
94	432		111	654		129	Customized PL
95	445		112	662		130	Inverted DPL 39
96	464		113	664		131	Inverted DPL 40
97	465		114	703		132	Inverted DPL 41
98	466		115	712		133	Inverted DPL 42
99	503		116	723		134	Inverted DPL 43
100	506		117	731		135	Inverted DPL 44
101	516		118	732		136	Inverted DPL 45
102	532		119	734		137	Inverted DPL 46
103	546		120	743		138	Inverted DPL 47

PL/DPL Codes (cont.)

DPL	Code		DPL	Code		DPL	Code
139	Inverted DPL 48		156	Inverted DPL 65		173	Inverted DPL 82
140	Inverted DPL 49		157	Inverted DPL 66		174	Inverted DPL 83
141	Inverted DPL 50		158	Inverted DPL 67		175	Inverted DPL 84
142	Inverted DPL 51		159	Inverted DPL 68		176	Inverted DPL 85
143	Inverted DPL 52		160	Inverted DPL 69		177	Inverted DPL 86
144	Inverted DPL 53		161	Inverted DPL 70		178	Inverted DPL 87
145	Inverted DPL 54		162	Inverted DPL 71		179	Inverted DPL 88
146	Inverted DPL 55		163	Inverted DPL 72		180	Inverted DPL 89
147	Inverted DPL 56		164	Inverted DPL 73		181	Inverted DPL 90
148	Inverted DPL 57		165	Inverted DPL 74		182	Inverted DPL 91
149	Inverted DPL 58		166	Inverted DPL 75		183	Inverted DPL 92
150	Inverted DPL 59		167	Inverted DPL 76		184	Inverted DPL 93
151	Inverted DPL 60		168	Inverted DPL 77		185	Inverted DPL 94
152	Inverted DPL 61		169	Inverted DPL 78		186	Inverted DPL 95
153	Inverted DPL 62		170	Inverted DPL 79		187	Inverted DPL 96
154	Inverted DPL 63		171	Inverted DPL 80		188	Inverted DPL 97
155	Inverted DPL 64		172	Inverted DPL 81		189	Inverted DPL 98

PL/DPL Codes (cont.)

DPL	Code		DPL	Code		DPL	Code
190	Inverted DPL 99		199	Inverted DPL 108		208	Inverted DPL 117
191	Inverted DPL 100		200	Inverted DPL 109		209	Inverted DPL 118
192	Inverted DPL 101		201	Inverted DPL 110		210	Inverted DPL 119
193	Inverted DPL 102		202	Inverted DPL 111		211	Inverted DPL 120
194	Inverted DPL 103		203	Inverted DPL 112		212	Inverted DPL 121
195	Inverted DPL 104		204	Inverted DPL 113		213	Inverted DPL 123
196	Inverted DPL 105		205	Inverted DPL 114			
197	Inverted DPL 106		206	Inverted DPL 115			
198	Inverted DPL 107		207	Inverted DPL 116			

USE AND CARE



Use a soft damp cloth
to clean the exterior



Do not immerse
in water



Do not use alcohol or
cleaning solutions

If the radio is submerged in water...

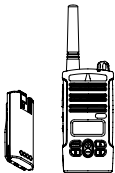

Turn radio OFF and
remove batteries

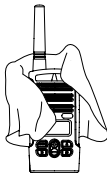

Dry with soft cloth



Do not use radio until
completely dry

TROUBLESHOOTING

<i>Symptom</i>	<i>Try This...</i>
No Power	Recharge or replace the Li-Ion battery. Reposition or replace AA batteries. Extreme operating temperatures may affect battery life. Refer to See "About the Li-Ion Battery" on page 9.
Hearing other noises or conversation on a channel	Confirm Interference Eliminator Code is set. Frequency or Interference Eliminator Code may be in use. Change settings: either change frequencies or codes on all radios. Make sure radio is at the right frequency and code when transmitting. Refer to "Talking and Monitoring" on page 25
Message Scrambled	Scramble Code might be ON, and/or setting does not match the other radios' settings.
Audio quality not good enough	Radio settings might not be matching up correctly. Double check frequencies, codes and bandwidths to make sure they are identical in all radios

Symptom	Try This...
Limited talk range	<p>Steel and/or concrete structures, heavy foliage, buildings or vehicles decrease range. Check for clear line of sight to improve transmission.</p> <p>Wearing radio close to body such as in a pocket or on a belt decreases range. Change location of radio. To increase range and coverage, you can either reduce obstructions or use UHF radio instead of VHF MURS radio. UHF radios provide greater coverage in industrial and commercial buildings. (FCC license may be required). VHF MURS is designed for outdoor or smaller or wood structures. Increasing power provides greater signal range and increased penetration through obstructions. Refer to See Talking and Monitoring on page 25.</p>
Message not transmitted or received	<p>Make sure the PTT button is completely pressed when transmitting.</p> <p>Confirm that the radios have the same Channel, MURS Frequency, Interference Eliminator Code and Scramble Code settings. Refer to “Talking and Monitoring” section on page 25 for further information.</p> <p>Recharge, replace and/or reposition batteries. Refer to “About your Li-Ion Battery” section on page 9.</p> <p>Obstructions and operating indoors, or in vehicles, may interfere. Change location. Refer to “Talking and Monitoring” Section on page 25.</p> <p>Verify that the radio is not in Scan. Refer to “Scan” on page 25 and “Nuisance Channel Delete” on page 37.</p>

<i>Symptom</i>	<i>Try This...</i>
Heavy static or interference	Radios are too close; they must be at least five feet apart. Radios are too far apart or obstacles are interfering with transmission. Refer to “Talking and Monitoring” on page 25.
Low batteries	Recharge or replace Li-Ion battery. Replace AA batteries. Extreme operating temperatures affect battery life. Refer to “About the Li-Ion Battery” on page 9.
Drop-in Charger LED light does not blink	Check that the radio/battery is properly inserted and check the battery/charger contacts to ensure that they are clean and charging pin is inserted correctly. Refer to “Charging the Battery” section on page 16, “Drop-in Tray Charger LED Indicators” section on page 19 and “Installing the Battery” section on page 11.
Low battery indicator is blinking although new batteries are inserted	Verify that the radio is set to the correct battery type. Refer to “Installing the Battery” section on page 11, “Installing Alkaline Batteries” section on page 12 and “About your Li-Ion Battery” section on page 9.

<i>Symptom</i>	<i>Try This...</i>
Cannot activate VOX	<p>VOX feature might be set to OFF.</p> <p>Use the CPS to ensure that the VOX Sensitivity level is not set to '0'.</p> <p>Accessory not working or not compatible.</p> <p>Refer to the "VOX" section on page 35.</p>
Battery does not charge although it has been placed in the drop-in charger for a while	<p>Check drop-in tray charger is properly connected and correspond to a compatible power supply.</p> <p>Ensure that you have the drop-in tray charger adjustable piece placed on the right position.</p> <p>Refer to "Charging the Battery Attached to the Radio" section on page 16.</p> <p>Check the charger's LEDs indicators to see if the battery has a problem. Refer to "Drop-in Tray Charger LED Indicators" section on page 19.</p>

Note: Whenever a feature in the radio seems to not correspond to the default or pre configured values, check to see if the radio has been configured using the CPS with a customized profile.

MOTOROLA LIMITED WARRANTY FOR THE UNITED STATES AND CANADA

What Does this Warranty Cover?

Subject to the exclusions contained below, Motorola, Inc. warrants its telephones, pagers, and consumer and business two-way radios (excluding commercial, government or industrial radios) that operate via Family Radio Service or General Mobile Radio Service, Motorola-branded or certified accessories sold for use with these Products (“Accessories”) and Motorola software contained on CD-ROMs or other tangible media and sold for use with these Products (“Software”) to be free from defects in materials and workmanship under normal consumer usage for the period(s) outlined below.

This limited warranty is a consumer’s exclusive remedy, and applies as follows to new Motorola Products, Accessories and Software purchased by consumers in the United States, which are accompanied by this written warranty.

Products and Accessories

Products Covered	Length of Coverage
Products and Accessories as defined above, unless otherwise provided for below.	One (1) year from the date of purchase by the first consumer purchaser of the product unless otherwise provided for below.
Decorative Accessories and Cases. Decorative covers, bezels, PhoneWrap™ covers and cases.	Limited lifetime warranty for the lifetime of ownership by the first consumer purchaser of the product.
Business Two-way Radio Accessories	One (1) year from the date of purchase by the first consumer purchaser of the product.
Products and Accessories that are Repaired or Replaced.	The balance of the original warranty or for ninety (90) days from the date returned to the consumer, whichever is longer.

Exclusions

Normal Wear and Tear. Periodic maintenance, repair and replacement of parts due to normal wear and tear are excluded from coverage.

Batteries. Only batteries whose fully charged capacity falls below 80% of their rated capacity and batteries that leak are covered by this limited warranty.

Abuse & Misuse. Defects or damage that result from: (a) improper operation, storage, misuse or abuse, accident or neglect, such as physical damage (cracks, scratches, etc.) to the surface of the product resulting from misuse; (b) contact with liquid, water, rain, extreme humidity or heavy perspiration, sand, dirt or the like, extreme heat, or food; (c) use of the Products or Accessories for commercial purposes or subjecting the Product or Accessory to abnormal usage or conditions; or (d) other acts which are not the fault of Motorola, are excluded from coverage.

Use of Non-Motorola Products and

Accessories. Defects or damage that result from the use of Non-Motorola branded or certified Products, Accessories, Software or other peripheral equipment are excluded from coverage.

Unauthorized Service or Modification. Defects or damages resulting from service, testing, adjustment, installation, maintenance, alteration, or modification in any way by someone other than Motorola, or its authorized service centers, are excluded from coverage.

Altered Products. Products or Accessories with (a) serial numbers or date tags that have been removed, altered or obliterated; (b) broken seals or that show evidence of tampering; (c) mismatched board serial numbers; or (d) nonconforming or non-Motorola housings, or parts, are excluded from coverage.

Communication Services. Defects, damages, or the failure of Products, Accessories or Software due to any communication service or signal you may subscribe to or use with the Products Accessories or Software is excluded from coverage.

Software

Products Covered	Length of Coverage
Software. Applies only to physical defects in the media that embodies the copy of the software (e.g. CD-ROM, or floppy disk).	Ninety (90) days from the date of purchase.

Exclusions

Software Embodied in Physical Media. No warranty is made that the software will meet your requirements or will work in combination with any hardware or software applications provided by third parties, that the operation of the software products will be uninterrupted or error free, or that all defects in the software products will be corrected.

Software NOT Embodied in Physical Media.

Software that is not embodied in physical media (e.g. software that is downloaded from the internet), is provided “as is” and without warranty.

WHO IS COVERED?

This warranty extends only to the first consumer purchaser, and is not transferable.

HOW TO OBTAIN WARRANTY SERVICE OR OTHER INFORMATION?

Contact your Motorola point of purchase.

SOFTWARE COPYRIGHT NOTICE

The Motorola products described in this manual may include copyrighted Motorola and third party software stored in semiconductor memories or other media. Laws in the United States and other countries preserve for Motorola and third party software providers certain exclusive rights for copyrighted software, such as the exclusive rights to distribute or reproduce the copyrighted software. Accordingly, any copyrighted software contained in the Motorola products may not be modified, reverse-engineered, distributed, or reproduced in any manner to the extent allowed by law.

Furthermore, the purchase of the Motorola products shall not be deemed to grant either directly or by implication, estoppel, or otherwise, any license under the copyrights, patents, or patent applications of Motorola or any third party software provider, except for the normal, non-exclusive, royalty-free license to use that arises by operation of law in the sale of a product.

PATENT NOTICE

This product is covered by one or more of the following United States patents.

5896277 5894292 5864752 5699006 5742484
D408396 D399821 D387758 D389158 5894592
5893027 5789098 5734975 5861850 D395882
D383745 D389827 D389139 5929825 5926514
5953640 6071640 D413022 D416252 D416893
D433001

EXPORT LAW ASSURANCES

This product is controlled under the export regulations of the United States of America. The Governments of the United States of America may restrict the exportation or re-exportation of this product to certain destinations. For further information contact the U.S. Department of Commerce.

ACCESSORIES

AUDIO ACCESSORIES

Part No.	Description
53815	Headset with Boom Microphone BR
53862	Remote Speaker Microphone BR
53863	Earpiece with Microphone BR
53865	Headset with Swivel Boom Microphone
53866	Earbud with Clip PTT Microphone BR
56517	Earpiece with Inline Microphone
56518	Earpiece with Boom Microphone

BATTERY

Part No.	Description
RLN6306	Alkaline Battery Frame
RLN6351	Standard Li-Ion Battery
RLN6305	High Capacity Li-Ion Battery
RLN6308	Ultra High Capacity Li-Ion Battery

CARRY ACCESSORIES

Part No.	Description
RLN6302	Hard Leather Carry Case
RLN6307	Spring Action Belt Clip

POWER SUPPLIES AC PIN ADAPTORS

Part No.	Description
RLN6349	North America AC Pin Adaptor

SOFTWARE APPLICATIONS

Part No.	Description
RVN5147	Computer Programming Software (CPS)

CABLES

Part No.	Description
RLN6303	Radio to Radio Cloning Cable
RKN4155	CPS Programming Cable

CHARGERS

Part No.	Description
RLN6304	Rapid Accessory Charging Kit (includes Power Supply, Drop-in Tray Charger, and AC Pin adaptor).
RLN6309	Multi Unit Charger (MUC)
RLN6175	Standard Drop-in Tray Charger

POWER SUPPLIES

Part No.	Description
RPN4054	Standard US Fixed Power Supply
RPN4058	Standard Exchange AC pin Power Supply
RLN6170	Rapid Exchange AC pin Power Supply

Notes



Motorola Inc.
1301 E. Algonquin Rd.
Schaumburg, IL 60196-1078 U.S.A.

MOTOROLA, the RDM Series MURS Radio and the Stylized M Logo are registered in the US Patent & Trademark Office.

All other product or service names are the property of their respective owners.

© 2010 by Motorola, Inc.

All rights reserved.

Printed in Malaysia.



68012002002-A

Free Manuals Download Website

<http://myh66.com>

<http://usermanuals.us>

<http://www.somanuals.com>

<http://www.4manuals.cc>

<http://www.manual-lib.com>

<http://www.404manual.com>

<http://www.luxmanual.com>

<http://aubethermostatmanual.com>

Golf course search by state

<http://golfingnear.com>

Email search by domain

<http://emailbydomain.com>

Auto manuals search

<http://auto.somanuals.com>

TV manuals search

<http://tv.somanuals.com>