

Professional Digital Two-Way Radio System

# MOTOTRBO™ XPR™ 6300 / XPR™ 6350

## Non-Display Portable

User Guide





## Declaration of Conformity

This declaration is applicable to your radio **only** if your radio is labeled with the FCC logo shown below.

### DECLARATION OF CONFORMITY

Per FCC CFR 47 Part 2 Section 2.1077(a)



Responsible Party  
Name: Motorola, Inc.

Address: 1301 East Algonquin Road, Schaumburg, IL 60196-1078, U.S.A.  
Phone Number: 1-888-567-7347

Hereby declares that the product:

Model Name: **XPR 6300/XPR 6350**

conforms to the following regulations:

FCC Part 15, subpart B, section 15.107(a), 15.107(d) and section 15.109(a)

#### **Class B Digital Device**

As a personal computer peripheral, this device complies with Part 15 of the FCC Rules. Operation is subject to the following two conditions:

1. This device may not cause harmful interference, and
2. This device must accept any interference received, including interference that may cause undesired operation.

**Note:** This equipment has been tested and found to comply with the limits for a Class B digital device, pursuant to part 15 of the FCC Rules. These limits are designed to provide reasonable protection against harmful interference in a residential installation. This equipment generates, uses and can radiate radio frequency energy and, if not installed and used in accordance with the instructions, may cause harmful interference to radio communications. However, there is no guarantee that interference will not occur in a particular installation.

If this equipment does cause harmful interference to radio or television reception, which can be determined by turning the equipment off and on, the user is encouraged to try to correct the interference by one or more of the following measures:

- Reorient or relocate the receiving antenna.
- Increase the separation between the equipment and receiver.
- Connect the equipment into an outlet on a circuit different from that to which the receiver is connected.
- Consult the dealer or an experienced radio/TV technician for help.

# Contents

This User Guide contains all the information you need to use the MOTOTRBO XPR Series Digital Portable Radios.

- Declaration of Conformity** . . . . . i
- Important Safety Information** . . . . . v
  - Product Safety and RF Exposure Compliance . . . . . v
- Software Version** . . . . . v
- Computer Software Copyrights** . . . . . vi
- Getting Started** . . . . . 1
  - How to Use This Guide . . . . . 1
  - What Your Dealer/System Administrator Can Tell You . . . . . 1
- Preparing Your Radio for Use** . . . . . 2
  - Charging the Battery . . . . . 2
  - Attaching the Battery . . . . . 2
  - Attaching the Antenna . . . . . 3
  - Attaching the Belt Clip . . . . . 3
  - Attaching the Universal Connector Cover . . . . . 3
  - Powering Up the Radio . . . . . 4
  - Adjusting the Volume . . . . . 4
- Identifying Radio Controls** . . . . . 5
  - Radio Controls You Will Be Using . . . . . 5

- Programmable Buttons . . . . . 6
  - Assignable Radio Functions . . . . . 6
  - Assignable Settings or Utility Functions . . . . . 6
- Push-To-Talk (PTT) Button . . . . . 7
- Switching Between Analog and Digital Mode . . . . . 7
- Identifying Status Indicators** . . . . . 8
  - LED Indicator . . . . . 8
  - Audio Tones . . . . . 8
  - Indicator Tones . . . . . 9
- Receiving and Making Calls** . . . . . 9
  - Selecting a Zone . . . . . 9
  - Selecting a Radio Channel, Subscriber ID, or Group ID . . . . . 10
  - Receiving and Responding to a Radio Call . . . . . 10
    - Receiving and Responding to a Group Call . . . . . 11
    - Receiving and Responding to a Private Call . . . . . 11
    - Receiving an All Call . . . . . 12
  - Making a Radio Call . . . . . 12
    - Making a Call with the Channel Selector Knob . . . . . 12
      - Making a Group Call . . . . . 12
      - Making a Private Call . . . . . 13
      - Making an All Call . . . . . 13
    - Making a Group or Private Call with the One Touch Call Button . . . . . 14
  - Talkaround . . . . . 14



Monitoring Features . . . . .	15	Text Messaging Features . . . . .	22
Monitoring a Channel . . . . .	15	Sending a Quick Text Message . . . . .	22
Permanent Monitor . . . . .	15	Privacy . . . . .	22
<b>Advanced Features . . . . .</b>	<b>16</b>	Utilities . . . . .	23
Scan Lists . . . . .	16	Setting the Squelch Level . . . . .	23
Scan . . . . .	16	Setting the Power Level . . . . .	23
Starting and Stopping Scan . . . . .	17	Turning the Option Board Feature(s) On or Off . . . . .	24
Responding to a Transmission During a Scan . . . . .	17	Turning Radio Tones/Alerts On or Off . . . . .	24
Deleting a Nuisance Channel . . . . .	17	Checking the Battery Strength . . . . .	24
Restoring a Nuisance Channel . . . . .	18	<b>Accessories . . . . .</b>	<b>25</b>
Call Indicator Settings . . . . .	18	Antennas . . . . .	25
Escalating Alarm Tone Volume . . . . .	18	Batteries . . . . .	26
Call Alert Operation . . . . .	18	Carry Devices . . . . .	26
Receiving and Acknowledging a Call Alert . . . . .	18	Chargers . . . . .	27
Making a Call Alert with the One Touch Call Button . . . . .	18	Earbuds and Earpieces . . . . .	27
Emergency Operation . . . . .	19	Headsets and Headset Accessories . . . . .	27
Sending an Emergency Alarm . . . . .	19	Remote Speaker Microphones . . . . .	28
Sending an Emergency Alarm with Call . . . . .	20	Surveillance Accessories . . . . .	28
Sending an Emergency Alarm with Voice to Follow . . . . .	20	Miscellaneous Accessories . . . . .	29
Reinitiating an Emergency Mode . . . . .	21	<b>Notes . . . . .</b>	<b>30</b>
Exiting an Emergency Mode . . . . .	21	<b>Batteries and Chargers Warranty . . . . .</b>	<b>31</b>
		<b>Limited Warranty . . . . .</b>	<b>32</b>

## Important Safety Information

### Product Safety and RF Exposure Compliance



Caution

Before using this product, read the operating instructions for safe usage contained in the Product Safety and RF Exposure booklet enclosed with your radio.

### ATTENTION!

**This radio is restricted to occupational use only to satisfy FCC RF energy exposure requirements.**

Before using this product, read the RF energy awareness information and operating instructions in the Product Safety and RF Exposure booklet enclosed with your radio (Motorola Publication part number 6881095C98) to ensure compliance with RF energy exposure limits.

For a list of Motorola-approved antennas, batteries, and other accessories, visit the following website:

<http://www.motorola.com/governmentandenterprise>

## Software Version

All the features described in the following sections are supported by the radio's software version **R01.02.01**.

Please check with your dealer or system administrator for more details of all the features supported.

## Computer Software Copyrights

The Motorola products described in this manual may include copyrighted Motorola computer programs stored in semiconductor memories or other media. Laws in the United States and other countries preserve for Motorola certain exclusive rights for copyrighted computer programs including, but not limited to, the exclusive right to copy or reproduce in any form the copyrighted computer program. Accordingly, any copyrighted Motorola computer programs contained in the Motorola products described in this manual may not be copied, reproduced, modified, reverse-engineered, or distributed in any manner without the express written permission of Motorola. Furthermore, the purchase of Motorola products shall not be deemed to grant either directly or by implication, estoppel, or otherwise, any license under the copyrights, patents or patent applications of Motorola, except for the normal non-exclusive license to use that arises by operation of law in the sale of a product.

The AMBE+2™ voice coding Technology embodied in this product is protected by intellectual property rights including patent rights, copyrights and trade secrets of Digital Voice Systems, Inc.

This voice coding Technology is licensed solely for use within this Communications Equipment. The user of this Technology is explicitly prohibited from attempting to decompile, reverse engineer, or disassemble the Object Code, or in any other way convert the Object Code into a human-readable form.

U.S. Pat. Nos. #5,870,405, #5,826,222, #5,754,974, #5,701,390, #5,715,365, #5,649,050, #5,630,011, #5,581,656, #5,517,511, #5,491,772, #5,247,579, #5,226,084 and #5,195,166.



---

## Getting Started

Take a moment to review the following:

How to Use This Guide . . . . . page 1

What Your Dealer/System Administrator Can Tell You . page 1

### ■ How to Use This Guide

---

This User Guide covers the basic operation of the MOTOTRBO Non-Display Portables.

However, your dealer or system administrator may have customized your radio for your specific needs. Check with your dealer or system administrator for more information.

Throughout this publication, two icons are used to differentiate Analog mode and Digital mode only features:



Indicates an Analog mode only feature.



Indicates a Digital mode only feature.

For features that are available in both Analog and Digital modes, no icon is shown.

### ■ What Your Dealer/System Administrator Can Tell You

---

You can consult your dealer or system administrator about the following:

- Is your radio programmed with any preset conventional channels?
- Which buttons have been programmed to access other features?
- What optional accessories may suit your needs?

## Preparing Your Radio for Use

Assemble your radio by following these steps:

Charging the Battery . . . . .	page 2
Attaching the Battery . . . . .	page 2
Attaching the Antenna . . . . .	page 3
Attaching the Belt Clip . . . . .	page 3
Attaching the Universal Connector Cover . . . . .	page 3
Powering Up the Radio . . . . .	page 4
Adjusting the Volume . . . . .	page 4

### ■ Charging the Battery

Your radio is powered by a Nickel Metal-Hydrate (NiMH) or Lithium-Ion (Li-Ion) battery. To avoid damage and comply with warranty terms, charge the battery using a Motorola charger *exactly* as described in the charger user guide.

Charge a new battery 14 to 16 hours before initial use for best performance.

**IMPORTANT:** **ALWAYS** charge your IMPRES battery with the IMPRES charger. Using a conventional charger causes irrecoverable loss of IMPRES battery data. As a result, the battery functions as a non-IMPRES battery and cannot display the data on your radio. Additionally, it voids your IMPRES battery warranty, although the standard battery warranty still applies.

### ■ Attaching the Battery

Align the battery with the rails on the back of the radio. Press the battery firmly, and slide upward until the latch snaps into place. Slide battery latch into lock position.

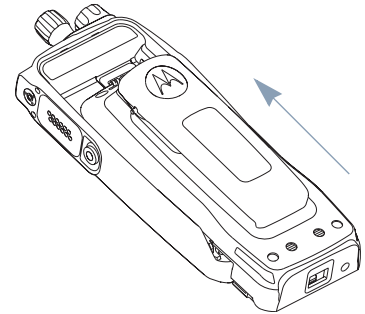

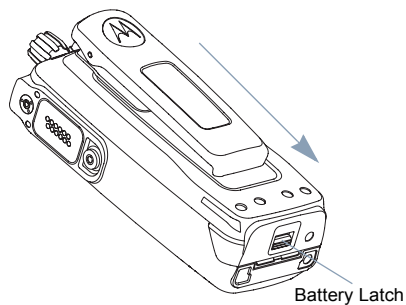

To remove the battery, turn the radio off. Move the battery latch into unlock position and hold, and slide the battery down and off the rails.

## ■ Attaching the Belt Clip



Align the grooves on the clip with those on the battery and press downward until you hear a click.

To remove the clip, press the belt clip tab away from the battery using a key. Then slide the clip upward and away from the radio.

## ■ Attaching the Antenna



With the radio turned off, set the antenna in its receptacle and turn clockwise.

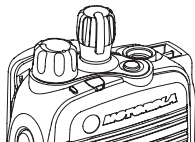

To remove the antenna, turn the antenna counterclockwise. Make sure you turn off the radio and remove the universal connector cover first.



Caution

If antenna needs to be replaced, ensure that only MOTOTRBO antennas are used. Neglecting this will damage your radio. See **Antennas** on page 25 for a list of available antennas.

## ■ Attaching the Universal Connector Cover

The universal connector is located on the antenna side of the radio. It is used to connect MOTOTRBO accessories to the radio.

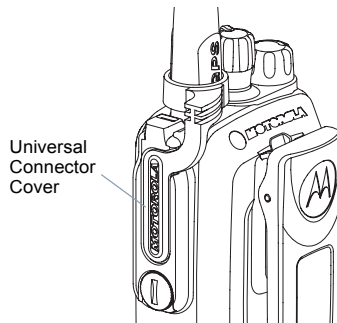

Place the universal connector cover loop over the attached antenna. Slide it all the way down to the base of the antenna.

Insert the hooked end of the cover into the slots above the universal connector.

Press downward on the cover to seat the lower tab properly into the RF connector.

Turn the thumbscrew clockwise to secure the connector cover to the radio.

*To remove the universal connector cover, press down on the cover and turn the thumbscrew counterclockwise. Lift the cover up, slide the connector cover loop upwards, and remove it from the attached antenna.*

## ■ Powering Up the Radio

Rotate the **On/Off/Volume Control Knob** clockwise until you hear a click. The LED blinks green.

A brief tone sounds, indicating that the power up test is successful.

**NOTE:** There is no power up tone if the radio tones/alerts function is disabled (see **Turning Radio Tones/ Alerts On or Off** on page 24).

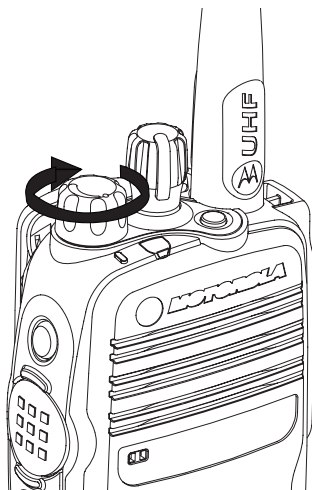

If your radio does not power up, check your battery. Make sure that it is charged and properly attached. If your radio still does not power up, contact your dealer.

*To turn off the radio, rotate this knob counterclockwise until you hear a click.*

## ■ Adjusting the Volume

To increase the volume, turn the **On/Off/Volume Control Knob** clockwise.

*To decrease the volume, turn this knob counterclockwise.*

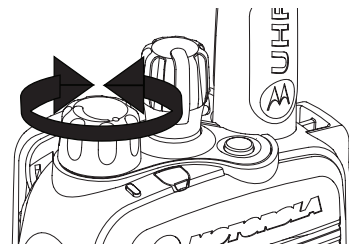

## Identifying Radio Controls

Take a moment to review the following:

Radio Controls You Will Be Using . . . . .	page 5
Programmable Buttons . . . . .	page 6
Push-To-Talk (PTT) Button . . . . .	page 7
Switching Between Analog and Digital Mode . . . . .	page 7

### ■ Radio Controls You Will Be Using

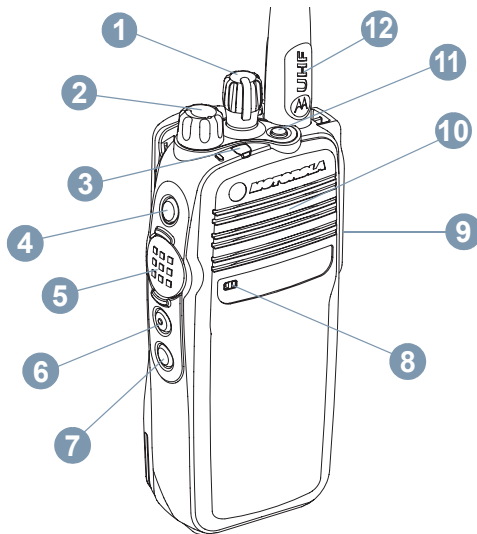

- 1 Channel Selector Knob
- 2 On/Off/Volume Control Knob
- 3 LED Indicator
- 4 Side Button 1\*
- 5 Push-to-Talk (PTT) Button
- 6 Side Button 2\*
- 7 Side Button 3\*
- 8 Microphone
- 9 Universal Connector for Accessories
- 10 Speaker
- 11 Emergency Button\*
- 12 Antenna

\* These buttons are programmable.

## ■ Programmable Buttons

---

Your dealer can program the programmable buttons as shortcuts to radio functions or preset channels/groups depending on the duration of a button press:

- Press – Pressing and releasing rapidly.
- Long press – Pressing and holding for the programmed duration (between 0.25 seconds and 3.75 seconds).
- Hold down – Keeping the button pressed.

### Assignable Radio Functions

**Emergency** – Depending on the programming, initiates or cancels an emergency alarm or call.

**Monitor** – Monitors a selected channel for activity.

**Nuisance Channel Delete** – Temporarily removes an unwanted channel, except for the Selected Channel, from the scan list. The Selected Channel refers to the user's selected zone/channel combination from which scan is initiated.

**One Touch Call**  – Directly initiates a predefined Private or Group Call, a Call Alert or a Quick Text message.

**Option Board Feature** – Toggles option board feature(s) on or off for option board-enabled channels.

**Permanent Monitor** – Monitors a selected channel for all radio traffic until function is disabled.

**Privacy**  – Toggles privacy on or off.

**Repeater/Talkaround** – Toggles between using a repeater and communicating directly with another radio.

**Scan** – Toggles scan on or off.

**Telemetry Control**  – Controls the Output Pin on a local or remote radio.

**Zone** – Allows selection from a list of zones.

**Battery Strength** – Indicates battery strength via the LED Indicator.

### Assignable Settings or Utility Functions

**All Tones/Alerts** – Toggles all tones and alerts on or off.

**Power Level** – Toggles transmit power level between high and low.

**Squelch**  – Toggles squelch level between tight and normal.

## ■ Push-To-Talk (PTT) Button

The **PTT** button on the side of the radio serves two basic purposes:

- While a call is in progress, the **PTT** button allows the radio to transmit to other radios in the call.

Press and hold down **PTT** button to talk. Release the **PTT** button to listen.

The microphone is activated when the **PTT** button is pressed.

- While a call is not in progress, the **PTT** button is used to make a new call (see **Making a Radio Call** on page 12).

*Depending on programming, if the Talk Permit Tone is enabled, wait until the short alert tone ends before talking.*

- 🔊 *During a call, if the Channel Free Indication feature is enabled on your radio (programmed by your dealer), you will hear a short alert tone the moment the target radio (the radio that is receiving your call) releases the **PTT** button, indicating the channel is free for you to respond.*

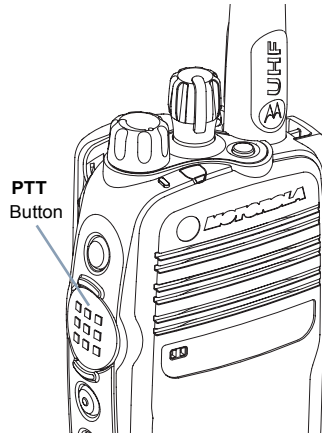

*You will also hear the Channel Free Indication tone if your call is interrupted, for example when the radio receives an Emergency Call.*

*You can turn off the Channel Free Indication tone by disabling all radio tones and alerts (see **Turning Radio Tones/Alerts On or Off** on page 24).*

## ■ Switching Between Analog and Digital Mode

Each channel in your radio can be configured as an analog channel or a digital channel. Use the Channel Selector Knob to switch between an analog or a digital channel.

When switching from digital to analog mode, certain features are unavailable.

Your radio also has features available in both analog and digital mode. However, the minor differences in the way each feature works does **NOT** affect the performance of your radio.

**NOTE:** Your radio also switches between digital and analog modes during a dual mode scan (see **Scan** on page 16).

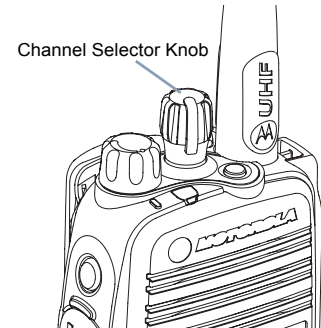

# Identifying Status Indicators

Your radio indicates its operational status through the following:

LED Indicator . . . . . page 8  
 Audio Tones . . . . . page 8  
 Indicator Tones . . . . . page 8

## ■ LED Indicator

The LED indicator shows the operational status of your radio.

**Blinking red** – Radio is transmitting at low battery condition, receiving an emergency transmission or has failed the self-test upon powering up.

**Solid yellow** – Radio is monitoring a channel. Also indicates fair battery charge when the programmed **Battery Strength** button is pressed.

**Blinking yellow** – Radio is scanning for activity or receiving a Call Alert.

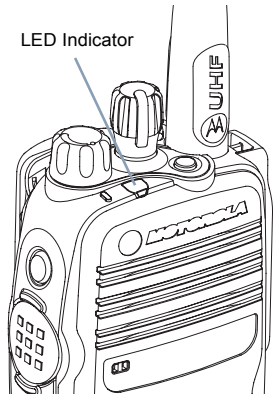

**Solid green** – Radio is transmitting. Also indicates full charge of the battery when the programmed **Battery Strength** button is pressed.

**Blinking green** – Radio is powering up, receiving a non-privacy-enabled call or data, or detecting activity over the air.

**Rapidly blinking green** – Radio is receiving a privacy-enabled call or data. 

**NOTE:** When the LED blinks green, it indicates the radio detects activity over the air. Due to the nature of the digital protocol, this activity may or may not affect the radio's programmed channel.

Upon a **PTT** button press, if the radio is programmed for polite operation, the radio automatically determines whether a transmission is permitted via a Talk Permit or a Talk Denial tone.

## ■ Audio Tones

Alert tones provide you with audible indications of the radio's status or the radio's response to data received.

**Continuous Tone** A monotone sound. Sounds continuously until termination.







**Periodic Tone** Sounds periodically depending on the duration set by the radio. Tone starts, stops, and repeats itself.



**Repetitive Tone** A single tone that repeats itself until it is terminated by the user.





**Momentary Tone** Sounds only once for a short period of time defined by the radio.



## ■ Indicator Tones

High pitched tone  Low pitched tone

 Positive Indicator Tone

 Negative Indicator Tone

## Receiving and Making Calls

Once you understand how your MOTOTRBO Portable is configured, you are ready to use your radio.

Use this navigation guide to familiarize yourself with the basic Call features:

Selecting a Zone .....	page 9
Selecting a Radio Channel, Subscriber ID, or Group ID .....	page 10
Receiving and Responding to a Radio Call .....	page 10
Making a Radio Call .....	page 12
Talkaround .....	page 14
Monitoring Features .....	page 15

## ■ Selecting a Zone

A zone is a group of channels. Your radio supports up to a maximum of 2 zones.

### Procedure:

- 1 Press the programmed **Zone** button.
- 2 You hear a positive indicator tone, indicating the radio has switched from Zone 1 to Zone 2.  
**OR**  
You hear a negative indicator tone, indicating the radio has switched from Zone 2 to Zone 1.

## ■ Selecting a Radio Channel, Subscriber ID, or Group ID

### Procedure:

Once the required zone is set (if you have multiple zones in your radio), turn the Channel Selector Knob to select the number that represents the channel, subscriber ID, or group ID.

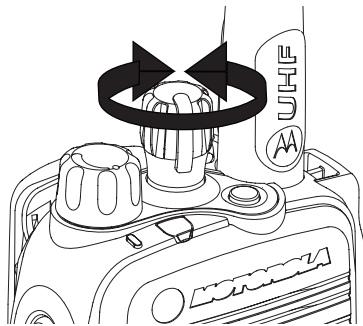

## ■ Receiving and Responding to a Radio Call

Once the channel, subscriber ID, or group ID is set, you can proceed to receive and respond to calls.

*The LED lights up solid green while the radio is transmitting and blinks when the radio is receiving.*

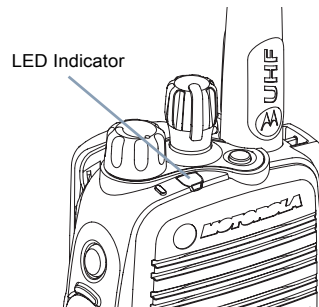

**NOTE:** The LED lights up solid green while the radio is transmitting and blinks green rapidly when the radio is receiving a privacy-enabled call.

To unscramble a privacy-enabled call, your radio must have the same Privacy Key (programmed by your dealer) as the transmitting radio (the radio you are receiving the call from). See **Privacy** on page 22 for more information. 

## Receiving and Responding to a Group Call

To receive a call from a group of users, your radio must be configured as part of that group.

- 1 The LED blinks green.

---

- 2 Hold the radio vertically 1 to 2 inches (2.5 to 5.0 cm) from your mouth.
  -  If the Channel Free Indication feature is enabled, you will hear a short alert tone the moment the transmitting radio releases the **PTT** button, indicating the channel is free for you to respond.

---

- 3 Press the **PTT** button to respond to the call. The LED lights up solid green.

---

- 4 Wait for the Talk Permit Tone to finish (if enabled) and speak clearly into the microphone.

---

- 5 Release the **PTT** button to listen.

---

- 6 If there is no voice activity for a predetermined period of time, the call ends.

---

See **Making a Group Call** on page 12 for details on making a Group Call.

## Receiving and Responding to a Private Call

A Private Call is a call from an individual radio to another individual radio.

There are two types of Private Calls. The first type, where a radio presence check is performed prior to setting up the call, while the other sets up the call immediately.

When your radio is checked, the LED blinks green.

Only one of these call types can be programmed to your radio by your dealer.

### Procedure:

When you receive a private call:

- 1 The LED blinks green.

---

- 2 Hold the radio vertically 1 to 2 inches (2.5 to 5.0 cm) from your mouth. If the Channel Free Indication feature is enabled, you will hear a short alert tone the moment the transmitting radio releases the **PTT** button, indicating the channel is free for you to respond.

---

- 3 Press the **PTT** button to respond to the call. The LED lights up solid green.

---

- 4 Wait for the Talk Permit Tone to finish (if enabled) and speak clearly into the microphone.

---

- 5 Release the **PTT** button to listen.

---

- 6 If there is no voice activity for a predetermined period of time, the call ends.
- 7 You hear a short tone.

See **Making a Private Call** on page 13 for details on making a Private Call.

### Receiving an All Call

An All Call is a call from an individual radio to every radio on the channel. It is used to make important announcements requiring the user's full attention.

#### Procedure:

When you receive an All Call:

- 1 A tone sounds and the LED blinks green.
- 2 If there is no voice activity for a predetermined period of time, the All Call ends.
  -  If the Channel Free Indication feature is enabled, you will hear a short alert tone the moment the transmitting radio releases the **PTT** button, indicating the channel is now available for use.

*You cannot respond to an All Call.*

**NOTE:** The radio stops receiving the All Call if you switch to a different channel while receiving the call. During an All Call, you will **not** be able to use any programmed button functions until the call ends.

## ■ Making a Radio Call

You can select a channel, subscriber ID or group ID by using:

- The Channel Selector Knob
- A programmed **One Touch Call** button 

**NOTE:** Your radio must have the Privacy feature enabled on the channel to send a privacy-enabled transmission. Only target radios with the same Privacy Key as your radio will be able to unscramble the transmission.

See **Privacy** on page 22 for more information. 

### Making a Call with the Channel Selector Knob

#### Making a Group Call

To make a call to a group of users, your radio must be configured as part of that group.

#### Procedure:

- 1 Turn the Channel Selector Knob to select the channel with the active group ID.
- 2 Hold the radio vertically 1 to 2 inches (2.5 to 5.0 cm) from your mouth.

- 3 Press the **PTT** button to make the call. The LED lights up solid green.
  - 4 Wait for the Talk Permit Tone to finish (if enabled) and speak clearly into the microphone.
  - 5 Release the **PTT** button to listen. When the target radio responds, the LED blinks green.
  - 6 If the Channel Free Indication feature is enabled, you will hear a short alert tone the moment the target radio releases the **PTT** button, indicating the channel is free for you to respond. Press the **PTT** button to respond. 
- OR**  
If there is no voice activity for a predetermined period of time, the call ends.

### **Making a Private Call**

#### **Procedure:**

- 1 Turn the Channel Selector Knob to select the channel with the active subscriber ID.
- 2 Hold the radio vertically 1 to 2 inches (2.5 to 5.0 cm) from your mouth.
- 3 Press the **PTT** button to make the call. The LED lights up solid green.
- 4 Wait for the Talk Permit Tone to finish (if enabled) and speak clearly into the microphone.

- 5 Release the **PTT** button to listen. When the target radio responds, the LED blinks green.
- 6 If the Channel Free Indication feature is enabled, you will hear a short alert tone the moment the target radio releases the **PTT** button, indicating the channel is free for you to respond. Press the **PTT** button to respond.  
**OR**  
If there is no voice activity for a predetermined period of time, the call ends.
- 7 You hear a short tone.

### **Making an All Call**

This feature allows you to transmit to all users on the channel. Your radio must be programmed to allow you to use this feature.

#### **Procedure:**

- 1 Turn the Channel Selector Knob to select the channel with the active All Call group ID.
- 2 Hold the radio vertically 1 to 2 inches (2.5 to 5.0 cm) from your mouth.
- 3 Press the **PTT** button to make the call. The LED lights up solid green.
- 4 Wait for the Talk Permit Tone to finish (if enabled) and speak clearly into the microphone.

*Users on the channel cannot respond to an All Call.*

## Making a Group or Private Call with the One Touch Call Button

The One Touch Call feature allows you to make a Group or Private Call to a predefined ID easily. This feature can be assigned to a short or long programmable button press.

You can **ONLY** have one ID assigned to a **One Touch Call** button. Your radio can have multiple **One Touch Call** buttons programmed.

### Procedure:

- 1 Press the programmed **One Touch Call** button to make a Group or Private Call to the predefined ID.
- 2 Hold the radio vertically 1 to 2 inches (2.5 to 5.0 cm) from your mouth.
- 3 Press the **PTT** button to make the call. The LED lights up solid green.
- 4 Wait for the Talk Permit Tone to finish (if enabled) and speak clearly into the microphone.
- 5 Release the **PTT** button to listen. When the target radio responds, the LED blinks green.

- 6 If the Channel Free Indication feature is enabled, you will hear a short alert tone the moment the target radio releases the **PTT** button, indicating the channel is free for you to respond. Press the **PTT** button to respond.

### OR

If there is no voice activity for a predetermined period of time, the call ends.

---

*For a Private Call, you hear a short tone when the call ends.*

## Talkaround

You can continue to communicate when your repeater is not operating, or when your radio is out of the repeater's range but within talking range of other radios. This is called "talkaround".

### Procedure:

- 1 Press the programmed **Repeater/Talkaround** button.
  - 2 You hear a positive indicator tone, indicating the radio is in Talkaround mode.
- OR**
- You hear a negative indicator tone, indicating the radio is in Repeater mode.

---

*The Talkaround setting is retained even after powering down.*

## ■ Monitoring Features

---

### Monitoring a Channel

Use the Monitor feature to make sure a channel is free before transmitting.

#### **Procedure:**

- 1** Press and hold the programmed **Monitor** button and listen for activity.
- 2** You hear radio activity or total silence, depending on how your radio is programmed.
- 3** When you hear “white noise” (that is, the channel is free), press the **PTT** button to talk and release it to listen. The LED lights up solid yellow.

### Permanent Monitor

Use the Permanent Monitor feature to continuously monitor a selected channel for activity.

#### **Procedure:**

- 1** Press the programmed **Permanent Monitor** button.
- 2** Radio sounds alert tone, and the LED lights up solid yellow.
- 3** Press the programmed **Permanent Monitor** button to remove the radio from permanent monitor mode.
- 4** Radio sounds an alert tone and the LED turns off.

## Advanced Features

Use this navigation guide to learn more about advanced features available with your radio:

Scan Lists . . . . .	page 16
Scan . . . . .	page 16
Call Indicator Settings . . . . .	page 18
Call Alert Operation . . . . .	page 18
Emergency Operation . . . . .	page 19
Text Messaging Features . . . . .	page 22
Privacy . . . . .	page 22
Utilities . . . . .	page 23

### ■ Scan Lists

Scan lists are created and assigned to individual channels/groups. Your radio scans for voice activity by cycling through the channel/group sequence specified in the scan list for the current channel.

Your radio supports up to 32 scan lists, with a maximum of 16 members in a list. Each scan list shall support a mixture of both analog and digital entries.

### ■ Scan

When you start a scan, your radio cycles through the programmed scan list for the current channel looking for voice activity.

The LED blinks yellow.

During a dual mode scan, if you are on a digital channel, and your radio locks onto an analog channel, it automatically switches from digital mode to analog mode for the duration of the call. This is also true for the reverse.

There are two types of scans:

- **Main Channel Scan (Manual):** Your radio scans all the channels/groups in your scan list. On entering scan, your radio may – depending on the settings – automatically start on the last scanned “active” channel/group or on the channel where scan was initiated.
- **Auto Scan (Automatic):** Your radio automatically starts scanning when you select a channel/group that has Auto Scan enabled.



## Starting and Stopping Scan

### Procedure:

- 1 Press the programmed **Scan** button.  
**OR**  
Use the Channel Selector Knob to select a channel with Auto Scan enabled.
- 2 When Scan is enabled, the LED blinks yellow and you hear a positive indicator tone.  
**OR**  
When Scan is disabled, the LED turns off and you hear a negative indicator tone.

## Responding to a Transmission During a Scan

During scanning, your radio stops on a channel/group where activity is detected. The radio stays on that channel for a programmed time period known as “hang time”.

### Procedure:

- 1 Hold the radio vertically 1 to 2 inches (2.5 to 5.0 cm) from your mouth.  
 If the Channel Free Indication feature is enabled, you will hear a short alert tone the moment the transmitting radio releases the **PTT** button, indicating the channel is free for you to respond.

- 2 Press the **PTT** button during hang time. The LED lights up solid green.
- 3 Wait for the Talk Permit Tone to finish (if enabled) and speak clearly into the microphone.
- 4 Release the **PTT** button to listen.
- 5 If you do not respond within the hang time, the radio returns to scanning other channels/groups.

## Deleting a Nuisance Channel

If a channel continually generates unwanted calls or noise (termed a “nuisance” channel), you can temporarily remove the unwanted channel from the scan list.

This capability does not apply to the channel designated as the Selected Channel.

### Procedure:

- 1 When your radio “locks on to” an unwanted or nuisance channel, press the programmed **Nuisance Channel Delete** button until you hear a tone.
- 2 Release the **Nuisance Channel Delete** button. The nuisance channel is deleted.

## Restoring a Nuisance Channel

### Procedure:

To restore the deleted nuisance channel, do **one** of the following:

- Power the radio off and powering it on again, **OR**
- Stop and restart a scan via the programmed **Scan** button, **OR**
- Change the channel via the Channel Selector Knob.

## ■ Call Indicator Settings

---

You can turn on or off the ringing tones for a received Private Call (see *Turning Radio Tones/Alerts On or Off* on page 24).

## Escalating Alarm Tone Volume

Your radio can be programmed by your dealer to continually alert you when a radio call remains unanswered. This is done by automatically increasing the alarm tone volume over time.

This feature is known as Escalart.

## ■ Call Alert Operation

---

Call Alert paging enables you to alert a specific radio user to call you back when they are able to do so. This feature is accessible via a programmed **One Touch Call** button.

## Receiving and Acknowledging a Call Alert

### Procedure:

When you receive a Call Alert page:

- 1 You hear a repetitive tone. The LED blinks yellow.
- 2 Press and release the **PTT** button to acknowledge the alert.

## Making a Call Alert with the One Touch Call Button

### Procedure:

- 1 Press the programmed **One Touch Call** button to make a Call Alert to the predefined ID.
- 2 The LED lights up solid green when your radio is sending the Call Alert.
- 3 If the Call Alert acknowledgement is received, two chirps sounds.  
**OR**  
If the Call Alert acknowledgement is not received, a low-pitch tone sounds.

## ■ Emergency Operation

---

An Emergency Alarm is used to indicate a critical situation. You are able to initiate an Emergency at any time, in any state, even when there is activity on the current channel.

Your radio supports 3 Emergency Alarms:

- Emergency Alarm
- Emergency Alarm with Call
- Emergency Alarm with Voice to Follow 

In addition, each alarm has the following types:

- Regular – Radio transmits an alarm signal and shows audio and/or visual indicators.
- Silent – Radio transmits an alarm signal without any audio or visual indicators. There will be no response (call) from the target radio until you press the **PTT** button to initiate the call.
- Silent with Voice – Radio transmits an alarm signal and is able to receive an incoming call, without any audio or visual indicators, until you press the **PTT** button to initiate, or respond to, the call.

Only **one** of the Emergency Alarms above can be assigned to the programmed **Emergency** button.

## Sending an Emergency Alarm

This feature allows you to send an Emergency Alarm, a non-voice signal, which triggers an alert indication on another radio.

### Procedure:

- 1 Press the programmed **Emergency** button.
- 2 The LED lights up solid green.
- 3 When an Emergency Alarm acknowledgment is received, the Emergency tone sounds. The LED blinks green.  
**OR**  
If your radio does not receive an Emergency Alarm acknowledgement, and after all retries have been exhausted, a low-pitch tone sounds.
- 4 Radio exits the Emergency Alarm mode.

*If your radio is set to Silent, it will not display any audio or visual indicators during Emergency mode.*

## Sending an Emergency Alarm with Call

This feature allows you send an Emergency Alarm to another radio. Upon acknowledgement, both radios can communicate over a programmed Emergency channel.

### Procedure:

- 1 Press the programmed **Emergency** button.
- 2 The LED lights up solid green.
- 3 When an Emergency Alarm acknowledgment is received, the Emergency tone sounds. The LED blinks green.
- 4 Hold the radio vertically 1 to 2 inches (2.5 to 5.0 cm) from your mouth.
- 5 Press the **PTT** button to make the call. The LED lights up solid green.
- 6 Wait for the Talk Permit Tone to finish (if enabled) and speak clearly into the microphone.
- 7 Release the **PTT** button to listen.
- 8 If the Channel Free Indication feature is enabled, you will hear a short alert tone the moment the target radio releases the **PTT** button, indicating the channel is free for you to respond. Press the **PTT** button to respond. 

### OR

Long press the programmed **Emergency** button to exit the Emergency mode.

*If your radio is set to Silent, it will not display any audio or visual indicators during Emergency mode, or receive any response (call) from the target radio, until you press the **PTT** button to initiate the call.*

*If your radio is set to Silent with Voice, it will not display any audio or visual indicators during Emergency mode, or when you are receiving a call from the target radio. The indicators will only appear once you press the **PTT** button to initiate, or respond to, the call.*

## Sending an Emergency Alarm with Voice to Follow

This feature allows you to send an Emergency Alarm to another radio. Upon acknowledgement, your radio's microphone is automatically activated, allowing you to communicate with the other radio without pressing the **PTT** button.

This activated microphone state is also known as "hot mic".

If you press the **PTT** button during the programmed hot mic transmission period, the radio ignores the **PTT** press and remains in Emergency mode.

**NOTE:** If you press the **PTT** button during hot mic, and continue to press it after the hot mic duration expires, the radio continues to transmit until you release the **PTT** button.

**Procedure:**

- 1 Press the programmed **Emergency** button.
- 2 The LED lights up solid green.
- 3 Once a tone sounds, speak clearly into the microphone. When hot mic has been enabled, the radio automatically transmits without a **PTT** press until the hot mic duration expires.
- 4 While transmitting, the LED lights up solid green.
- 5 Once the hot mic duration expires, the radio automatically stops transmitting. To transmit again, press the **PTT** button

*If your radio is set to Silent, it will not display any audio or visual indicators during Emergency mode, or receive any response from the target radio, until the programmed hot mic transmission period is over, and you press the **PTT** button.*

*If your radio is set to Silent with Voice, it will not display any audio or visual indicators during Emergency mode when you are making the call with hot mic, or when the target radio responds after the programmed hot mic transmission period is over. The indicators will only appear when you press the **PTT** button.*

 **Reinitiating an Emergency Mode**

There are two instances where this can happen:

- You change the channel while the radio is in Emergency mode. This exits the Emergency mode. If Emergency Alarm is enabled on this new channel, the radio reinitiates Emergency.
- You press the programmed **Emergency** button during an Emergency initiation/transmission state. This causes the radio to exit this state, and to reinitiate Emergency.

 **Exiting an Emergency Mode**

Your radio exits Emergency mode when **one** of the following occurs:

- Emergency Alarm acknowledgement is received (for **Emergency Alarm** only), **OR**
- All retries to send the alarm have been exhausted, **OR**
- The programmed **Emergency** button is long pressed.

**NOTE:** If your radio is powered off, it exits the Emergency mode. The radio will not reinitiate the Emergency mode automatically when it is turned on again.

## ■ Text Messaging Features

---

### Sending a Quick Text Message

You can send Quick Text messages, programmed by your dealer, via the programmable button.

#### Procedure:

- 1 Press the programmed **One Touch Call** button to send a predefined Quick Text message to a predefined ID.
  - 2 The LED lights up solid green.
  - 3 Two chirps indicate that the message is sent successfully.  
**OR**  
A low-pitch tone indicates that the message cannot be sent.
- 

## ■ Privacy

---

If enabled, this feature helps to prevent eavesdropping by unauthorized users on a channel by the use of a software-based scrambling solution. The signaling and user identification portions of a transmission are not scrambled.

Your radio must have privacy enabled on the channel to send a privacy-enabled transmission, although this is not a necessary requirement for receiving a transmission. While on a privacy-enabled channel, the radio is still able to receive clear (unscrambled) transmissions.

To unscramble a privacy-enabled call or data transmission, your radio must have the same Privacy Key (programmed by your dealer) as the transmitting radio. If your radio receives a scrambled call that is of a different Privacy Key, you will hear a garbled transmission.

The LED lights up solid green while the radio is transmitting and blinks green rapidly when the radio is receiving an ongoing privacy-enabled transmission.

**NOTE:** Some radio models may not offer this Privacy feature. Check with your dealer or system administrator for more information.

#### Procedure:

Press the programmed **Privacy** button to toggle privacy on or off.

## ■ Utilities

---

### **Setting the Squelch Level**

You can adjust your radio's squelch level to filter out unwanted calls with low signal strength or channels that have a higher than normal background noise.

**Settings:** **Normal** is the default. **Tight** filters out (unwanted) calls and/or background noise. However, calls from remote locations may also be filtered out.

#### **Procedure:**

- 1** Press the programmed **Squelch** button.
  - 2** You hear a positive indicator tone, indicating the radio is operating in tight squelch.  
**OR**  
You hear a negative indicator tone, indicating the radio is operating in normal squelch.
- 

### **Setting the Power Level**

You can toggle your radio's power setting between high or low for each channel.

**Settings:** **High** enables communication with radios located at a considerable distance from you. **Low** enables communication with radios in closer proximity.

#### **Procedure:**

- 1** Press the programmed **Power Level** button.
  - 2** You hear a positive indicator tone, indicating the radio is transmitting at low power.  
**OR**  
You hear a negative indicator tone, indicating the radio is transmitting at high power.
-

### Turning the Option Board Feature(s) On or Off

A channel can support up to 6 option board features. Refer to your dealer or system administrator for more information.

#### **Procedure:**

Press the programmed **Option Board Feature** button to toggle the feature on or off.

### Turning Radio Tones/Alerts On or Off

You can enable and disable all radio tones and alerts (except for the incoming Emergency alert tone) if needed.

#### **Procedure:**

- 1 Press the programmed **All Tones/Alerts** button.

---

  - 2 You hear a positive indicator tone, indicating all tones and alerts are on.  
**OR**  
You hear a negative indicator tone, indicating all tones and alerts are off.
- 

### Checking the Battery Strength

You can check how much battery power you have left.

**Settings:** The LED Indicator in solid yellow indicates fair battery charge while solid green indicates full charge of the battery.

#### **Procedure:**

Press the programmed **Battery Strength** button to view the battery strength via the LED Indicator.



## Accessories

Your radio is compatible with the accessories listed in this chapter. Contact your dealer for details.

Antennas . . . . .	page 25
Batteries . . . . .	page 26
Carry Devices . . . . .	page 26
Chargers . . . . .	page 27
Earbuds and Earpieces . . . . .	page 27
Headsets and Headset Accessories . . . . .	page 27
Remote Speaker Microphones . . . . .	page 28
Surveillance Accessories . . . . .	page 28
Miscellaneous Accessories . . . . .	page 29

### ■ Antennas

The diagram on the right shows the location of the color indicator for the following antennas. See the footnote at the end of the list for the colors.



- Combination VHF/GPS, 136 – 147 MHz, Helical Antenna<sup>4</sup> (PMAD4067\_)
- Combination VHF/GPS, 147 – 160 MHz, Helical Antenna<sup>3</sup> (PMAD4068\_)
- Combination VHF/GPS, 160 – 174 MHz, Helical Antenna<sup>5</sup> (PMAD4069\_)
- VHF Wideband, 136 – 174 MHz, Double Helical Antenna<sup>6</sup> (PMAD4088\_)
- Combination UHF/GPS, 403 – 433 MHz, Folded Monopole Antenna<sup>1</sup> (PMAE4018\_)
- Combination UHF/GPS, 403 – 433 MHz, Stubby Antenna<sup>1</sup> (PMAE4021\_)
- UHF, 403 – 470 MHz, Whip Antenna<sup>3</sup> (PMAE4022\_)
- Combination UHF/GPS, 430 – 470 MHz, Stubby Antenna<sup>2</sup> (PMAE4023\_)
- Combination UHF/GPS, 430 – 470 MHz, Folded Monopole Antenna<sup>2</sup> (PMAE4024\_)
- Public Safety Microphone UHF Stubby Antenna<sup>1</sup>, 403 – 433 MHz (PMAE4046\_)
- Public Safety Microphone UHF Stubby Antenna<sup>2</sup>, 430 – 470 MHz (PMAE4047\_)
- UHF2, 450 – 527 MHz, Whip Antenna<sup>7</sup> (PMAE4049\_)
- Combination UHF2/GPS, 450 – 495 MHz, Folded Monopole Antenna<sup>8</sup> (PMAE4050\_)

- Combination UHF2/GPS, 495 – 527 MHz, Folded Monopole Antenna<sup>6</sup> (PMAE4051\_)
- Public Safety Microphone VHF Antenna<sup>5</sup>, 150 – 174 MHz (PMAD4086\_)
- Public Safety Microphone VHF Antenna<sup>4</sup>, 136 – 153 MHz (PMAD4087\_)

---

**Color Code:**

1 Red	3 Black	5 Blue	7 Brown
2 Green	4 Yellow	6 White	8 Orange

---

## ■ Batteries

- IMPRES Li-Ion, 1500 mAh Submersible (IP57) Battery (PMNN4066\_)
- IMPRES Li-Ion, 1400 mAh Submersible (IP57) Battery, Intrinsically Safe (FM) (PMNN4069\_)
- IMPRES Li-Ion, 2200 mAh Submersible (IP57) Battery (PMNN4077\_)
- NiMH, 1300 mAh Submersible (IP57) Battery (PMNN4065\_)

---

## ■ Carry Devices

- Belt Clip for 2-Inch Belt Width (PMLN4651\_)
- Belt Clip for 2.5-Inch Belt Width (PMLN4652\_)
- 2.5-Inch Replacement Swivel Belt Loop (PMLN5022\_)
- 3-Inch Replacement Swivel Belt Loop (PMLN5023\_)
- Nylon Carry Case with 3-Inch Fixed Belt Loop for Non-Display Radio (PMLN5024\_)
- Soft Leather Carry Case with 2.5-Inch Swivel Belt Loop for Non-Display Radio (PMLN5025\_)
- Soft Leather Carry Case with 3-Inch Swivel Belt Loop for Non-Display Radio (PMLN5026\_)
- Soft Leather Carry Case with 3-Inch Fixed Belt Loop for Non-Display Radio (PMLN5027\_)
- Hard Leather Carry Case with 2.5-Inch Swivel Belt Loop for Non-Display Radio (PMLN5028\_)
- Hard Leather Carry Case with 3-Inch Swivel Belt Loop for Non-Display Radio (PMLN5029\_)
- Hard Leather Carry Case with 3-Inch Fixed Belt Loop for Non-Display Radio (PMLN5030\_)
- 1.75-Inch Black Leather Belt (4200865599)

## ■ Chargers

---

- IMPRES Multi-Unit Charger (WPLN4212\_)
- IMPRES Multi-Unit Charger with Displays (WPLN4219\_)
- IMPRES Single-Unit Charger (WPLN4232\_)

## ■ Earbuds and Earpieces

---

- Receive-Only Earbud (AARLN4885\_)
- D-Shell Receive-Only Earpiece (PMLN4620\_)
- Receive-Only Earpiece (RLN4941\_)
- Over-the-Ear Receiver for Remote Speaker Microphone (WADN4190\_)
- D-Shell Earset (PMLN5096\_)
- IMPRES Temple Transducer (PMLN5101\_)
- Small Custom Earpiece for Surveillance Kits, Right Ear (RLN4760\_)
- Medium Custom Earpiece for Surveillance Kits, Right Ear (RLN4761\_)
- Large Custom Earpiece for Surveillance Kits, Right Ear (RLN4762\_)

- Small Custom Earpiece for Surveillance Kits, Left Ear (RLN4763\_)
- Medium Custom Earpiece for Surveillance Kits, Left Ear (RLN4764\_)
- Large Custom Earpiece for Surveillance Kits, Left Ear (RLN4765\_)
- Standard Earpiece, Black (RLN6279\_)
- Standard Earpiece, Beige (RLN6280\_)
- Replacement Foam Ear Pad and Windscreen (RLN6283\_)
- Earpiece with Acoustic Tube Assembly, Beige (RLN6284\_)
- Earpiece with Acoustic Tube Assembly, Black (RLN6285\_)
- Earpiece with High Noise Kit, Beige (RLN6288\_)
- Earpiece with High Noise Kit, Black (RLN6289\_)

## ■ Headsets and Headset Accessories

---

- Ultra-Lite Headset (PMLN5102\_)
- Lightweight Headset (RMN5058\_)

## ■ Remote Speaker Microphones

---

- Remote Speaker Microphone (PMMN4024\_)
- IMPRES Remote Speaker Microphone (PMMN4025\_)
- Remote Speaker Microphone, Submersible (IP57) (PMMN4040\_)
- IMPRES Public Safety Microphone (PSM), 30-Inch Cable (PMMN4041\_)\*
- IMPRES Public Safety Microphone (PSM), 24-Inch Cable (PMMN4042\_)\*
- IMPRES Public Safety Microphone (PSM), 18-Inch Cable (PMMN4043\_)\*
- IMPRES Remote Speaker Microphone, with Volume, IP57 (PMMN4046\_)
- IMPRES Submersible Public Safety Microphone, 30-Inch Cable (PMMN4047\_)\*
- IMPRES Submersible Public Safety Microphone, 24-Inch Cable (PMMN4048\_)\*
- IMPRES Submersible Public Safety Microphone, 18-Inch Cable (PMMN4049\_)\*
- IMPRES Remote Speaker Microphone, Noise-Canceling (PMMN4050\_)

- Remote Speaker Microphone Replacement Coil Cord Kit (For Use with PMMN4024\_ and PMMN4040\_) (RLN6074\_)
- Remote Speaker Microphone Replacement Coil Cord Kit (For Use with PMMN4025) (RLN6075\_)

---

\*Only applicable to UHF B1 (403 – 470 MHz) and VHF (136 – 174 MHz) bands.

## ■ Surveillance Accessories

---

- IMPRES 3-Wire Surveillance, Black (PMLN5097\_)
- IMPRES 3-Wire Surveillance, Beige (PMLN5106\_)
- IMPRES 3-Wire Surveillance Kit with Clear, Comfortable Acoustic Tube, Black (PMLN5111\_)
- IMPRES 3-Wire Surveillance Kit with Clear, Comfortable Acoustic Tube, Beige (PMLN5112\_)
- Receive Only Surveillance Kit, Black (Single Wire) (RLN5878\_)
- Receive Only Surveillance Kit, Beige (Single Wire) (RLN5879\_)

- IMPRES 2-Wire Surveillance Kit, Black (RLN5880\_)
- IMPRES 2-Wire Surveillance Kit, Beige (RLN5881\_)
- IMPRES 2-Wire Surveillance Kit with Clear, Comfortable Acoustic Tube, Black (RLN5882\_)
- IMPRES 2-Wire Surveillance Kit with Clear, Comfortable Acoustic Tube, Beige (RLN5883\_)
- Surveillance Low Noise Kit (RLN5886\_)
- Surveillance High Noise Kit (RLN5887\_)
- Break-A-Way Chest Pack (RLN4570\_)
- Universal RadioPAK and Utility Case (Fanny Pack) (RLN4815\_)
- Replacement Ear Tips, Clear, Pack of 25 (For Use with RLN5886\_) (RLN6282\_)
- Replacement Strap for RLN4570\_ and HLN6602\_ Chest Packs (1505596Z02)
- Accessory Dust Cover (1571477L01)
- Replacement Foam Plugs, Pack of 50 (For Use with RLN5887\_) (5080384F72)
- Universal RadioPAK Extension Belt (4280384F89)

## ■ Miscellaneous Accessories

---

- Universal Chest Pack (HLN6602\_)
- Waterproof Bag, Includes Large Carry Strap (HLN9985\_)
- Shoulder Strap (Attaches to D-Rings on Carry Case) (NTN5243\_)
- Small Clip, Epaulet Strap (RLN4295\_)

---

## Notes

Notes

30

English

## Batteries and Chargers Warranty

### The Workmanship Warranty

The workmanship warranty guarantees against defects in workmanship under normal use and service.

All MOTOTRBO Batteries	Two (2) Years
IMPRES Chargers (Single-Unit and Multi-Unit, Non-Display)	Two (2) Years
IMPRES Chargers (Multi-Unit with Display)	One (1) Year

### The Capacity Warranty

The capacity warranty guarantees 80% of the rated capacity for the warranty duration.

Nickel Metal-Hydride (NiMH) or Lithium-Ion (Li-Ion) Batteries	12 Months
IMPRES Batteries, When Used Exclusively with IMPRES Chargers	18 Months

# Limited Warranty

## MOTOROLA COMMUNICATION PRODUCTS

### I. WHAT THIS WARRANTY COVERS AND FOR HOW LONG:

MOTOROLA INC. ("MOTOROLA") warrants the MOTOROLA manufactured Communication Products listed below ("Product") against defects in material and workmanship under normal use and service for a period of time from the date of purchase as scheduled below:

XPR Series Digital Portable Radios	Two (2) Years
Product Accessories (Excluding Batteries and Chargers)	One (1) Year

MOTOROLA, at its option, will at no charge either repair the Product (with new or reconditioned parts), replace it (with a new or reconditioned Product), or refund the purchase price of the Product during the warranty period provided it is returned in accordance with the terms of this warranty. Replaced parts or boards are warranted for the balance of the original applicable warranty period. All replaced parts of Product shall become the property of MOTOROLA.

This express limited warranty is extended by MOTOROLA to the original end user purchaser only and is not assignable or transferable to any other party. This is the complete warranty for the Product manufactured by MOTOROLA. MOTOROLA assumes no

obligations or liability for additions or modifications to this warranty unless made in writing and signed by an officer of MOTOROLA.

Unless made in a separate agreement between MOTOROLA and the original end user purchaser, MOTOROLA does not warrant the installation, maintenance or service of the Product.

MOTOROLA cannot be responsible in any way for any ancillary equipment not furnished by MOTOROLA which is attached to or used in connection with the Product, or for operation of the Product with any ancillary equipment, and all such equipment is expressly excluded from this warranty. Because each system which may use the Product is unique, MOTOROLA disclaims liability for range, coverage, or operation of the system as a whole under this warranty.

### II. GENERAL PROVISIONS:

This warranty sets forth the full extent of MOTOROLA'S responsibilities regarding the Product. Repair, replacement or refund of the purchase price, at MOTOROLA'S option, is the exclusive remedy. THIS WARRANTY IS GIVEN IN LIEU OF ALL OTHER EXPRESS WARRANTIES. IMPLIED WARRANTIES, INCLUDING WITHOUT LIMITATION, IMPLIED WARRANTIES OF MERCHANTABILITY AND FITNESS FOR A PARTICULAR PURPOSE, ARE LIMITED TO THE DURATION OF THIS LIMITED WARRANTY. IN NO EVENT SHALL MOTOROLA BE LIABLE FOR DAMAGES IN EXCESS OF THE PURCHASE PRICE OF THE PRODUCT, FOR ANY LOSS OF USE, LOSS OF TIME, INCONVENIENCE, COMMERCIAL LOSS, LOST PROFITS OR SAVINGS OR OTHER INCIDENTAL, SPECIAL OR CONSEQUENTIAL DAMAGES ARISING OUT OF THE USE OR



INABILITY TO USE SUCH PRODUCT, TO THE FULL EXTENT SUCH MAY BE DISCLAIMED BY LAW.

### III. STATE LAW RIGHTS:

SOME STATES DO NOT ALLOW THE EXCLUSION OR LIMITATION OF INCIDENTAL OR CONSEQUENTIAL DAMAGES OR LIMITATION ON HOW LONG AN IMPLIED WARRANTY LASTS, SO THE ABOVE LIMITATION OR EXCLUSIONS MAY NOT APPLY.

This warranty gives specific legal rights, and there may be other rights which may vary from state to state.

### IV. HOW TO GET WARRANTY SERVICE:

You must provide proof of purchase (bearing the date of purchase and Product item serial number) in order to receive warranty service and, also, deliver or send the Product item, transportation and insurance prepaid, to an authorized warranty service location. Warranty service will be provided by MOTOROLA through one of its authorized warranty service locations. If you first contact the company which sold you the Product (e.g., dealer or communication service provider), it can facilitate your obtaining warranty service. You can also call MOTOROLA at 1-800-927-2744 US/Canada.

### V. WHAT THIS WARRANTY DOES NOT COVER:

- A) Defects or damage resulting from use of the Product in other than its normal and customary manner.
- B) Defects or damage from misuse, accident, water, or neglect.

- C) Defects or damage from improper testing, operation, maintenance, installation, alteration, modification, or adjustment.
- D) Breakage or damage to antennas unless caused directly by defects in material workmanship.
- E) A Product subjected to unauthorized Product modifications, disassembles or repairs (including, without limitation, the addition to the Product of non-MOTOROLA supplied equipment) which adversely affect performance of the Product or interfere with MOTOROLA's normal warranty inspection and testing of the Product to verify any warranty claim.
- F) Product which has had the serial number removed or made illegible.
- G) Rechargeable batteries if:
  - (1) any of the seals on the battery enclosure of cells are broken or show evidence of tampering.
  - (2) the damage or defect is caused by charging or using the battery in equipment or service other than the Product for which it is specified.
- H) Freight costs to the repair depot.
- I) A Product which, due to illegal or unauthorized alteration of the software/firmware in the Product, does not function in accordance with MOTOROLA's published specifications or the FCC type acceptance labeling in effect for the Product at the time the Product was initially distributed from MOTOROLA.
- J) Scratches or other cosmetic damage to Product surfaces that does not affect the operation of the Product.
- K) Normal and customary wear and tear.

## VI. PATENT AND SOFTWARE PROVISIONS:

MOTOROLA will defend, at its own expense, any suit brought against the end user purchaser to the extent that it is based on a claim that the Product or parts infringe a United States patent, and MOTOROLA will pay those costs and damages finally awarded against the end user purchaser in any such suit which are attributable to any such claim, but such defense and payments are conditioned on the following:

- A) that MOTOROLA will be notified promptly in writing by such purchaser of any notice of such claim;
- B) that MOTOROLA will have sole control of the defense of such suit and all negotiations for its settlement or compromise; and
- C) should the Product or parts become, or in MOTOROLA's opinion be likely to become, the subject of a claim of infringement of a United States patent, that such purchaser will permit MOTOROLA, at its option and expense, either to procure for such purchaser the right to continue using the Product or parts or to replace or modify the same so that it becomes non-infringing or to grant such purchaser a credit for the Product or parts as depreciated and accept its return. The depreciation will be an equal amount per year over the lifetime of the Product or parts as established by MOTOROLA.

MOTOROLA will have no liability with respect to any claim of patent infringement which is based upon the combination of the Product or parts furnished hereunder with software, apparatus or devices not furnished by MOTOROLA, nor will MOTOROLA have any liability for the use of ancillary equipment or software not furnished by MOTOROLA which is attached to or used in connection with the Product. The foregoing states the entire liability of MOTOROLA with respect to infringement of patents by the Product or any parts thereof.

Laws in the United States and other countries preserve for MOTOROLA certain exclusive rights for copyrighted MOTOROLA software such as the exclusive rights to reproduce in copies and distribute copies of such MOTOROLA software. MOTOROLA software may be used in only the Product in which the software was originally embodied and such software in such Product may not be replaced, copied, distributed, modified in any way, or used to produce any derivative thereof. No other use including, without limitation, alteration, modification, reproduction, distribution, or reverse engineering of such MOTOROLA software or exercise of rights in such MOTOROLA software is permitted. No license is granted by implication, estoppel or otherwise under MOTOROLA patent rights or copyrights.

## VII. GOVERNING LAW:

This Warranty is governed by the laws of the State of Illinois, U.S.A.

**MOTOROLA**  
**XPR Series Digital  
Portable Radios  
Quick Reference Card**

■ **Radio Controls**

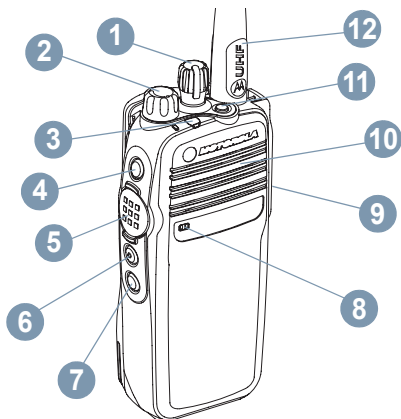

Record your radio's programmable button functions in the blanks provided. **SP** represents Short Press, **LP** represents Long Press.

- 1 Channel Selector Knob
- 2 On/Off/Volume Control Knob
- 3 LED Indicator

- 4 Side Button 1 (Programmable)  
SP: \_\_\_\_\_ LP: \_\_\_\_\_
- 5 Push-to-Talk (PTT) Button
- 6 Side Button 2 (Programmable)  
SP: \_\_\_\_\_ LP: \_\_\_\_\_
- 7 Side Button 3 (Programmable)  
SP: \_\_\_\_\_ LP: \_\_\_\_\_
- 8 Microphone
- 9 Universal Connector for Accessories
- 10 Speaker
- 11 Emergency Button (Programmable)  
SP: \_\_\_\_\_ LP: \_\_\_\_\_
- 12 Antenna

■ **Powering Up and Down the Radio**

Rotate the On/Off/Volume Control Knob clockwise until you hear a click to turn the radio on, and counterclockwise until you hear a click to turn it off.

■ **Adjusting the Volume**

Turn the On/Off/Volume Control Knob clockwise to increase volume or counterclockwise to decrease volume.

■ **LED Indicator**

**Blinking red** – Radio is transmitting at low battery condition, receiving an emergency transmission or has failed the self-test upon powering up.

**Solid yellow** – Radio is receiving a request for a Private Call, or monitoring a channel. Also indicates fair battery charge when programmable button is pressed.

**Blinking yellow** – Radio is scanning for activity or receiving a Call Alert.

**Solid green** – Radio is transmitting. Also indicates full charge of the battery when programmable button is pressed.

**Blinking green** – Radio is powering up, receiving a non-privacy-enabled call or data, or detecting activity over the air.

**Rapidly blinking green** – Radio is receiving a privacy-enabled call or data. 



**6880309T14-C**

## ■ Audio Indicators for Programmable Buttons

Some programmable buttons use audio indicators to indicate the change as they alternate between two different choices.

Programmable Button	Positive Indicator Tone	Negative Indicator Tone
Zone	Currently in Zone 2	Currently in Zone 1
Repeater/Talkaround	Currently in Talkaround mode	Currently in Repeater mode
Scan	Start Scan operation	Stop Scan operation
Squelch 	Operating in tight squelch	Operating in normal squelch
Power Level	Transmitting at low power	Transmitting at high power
Tones and Alerts	All tones and alerts are on	All tones and alerts are off

## ■ Selecting a Radio Channel, Subscriber ID, or Group ID

- 1 Turn the On/Off/Volume Control Knob to power up your radio.
- 2 Turn the Channel Selector Knob to select the required channel, subscriber ID, or group ID.

## ■ Making a Group or Private Call

Press the programmed **One Touch Call** button and proceed to step 2.

**OR**

Follow the procedure below.

- 1 Turn the Channel Selector Knob to select the channel with the active group ID.

**OR**

Turn the Channel Selector Knob to select the channel with the active subscriber ID. 

- 2 Hold the radio vertically 1 to 2 inches (2.5 to 5.0 cm) from your mouth.
- 3 Press the **PTT** button to make the call. The LED lights up solid green.
- 4 Wait for the Talk Permit Tone to finish (if enabled). Speak clearly into the microphone.
- 5 Release the **PTT** button to listen.

- 6 If the Channel Free Indication feature is enabled, you will hear a short alert tone the moment the target radio releases the **PTT** button, indicating the channel is free for you to respond. Press the **PTT** button to respond. 

**OR**

If there is no voice activity for a predetermined period of time, the call ends.

 *For a Private Call, you hear a short tone when the call ends.*

 *Your radio must have the Privacy feature enabled on the channel to send a privacy-enabled transmission. Only target radios with the same Privacy Key as your radio will be able to unscramble the transmission.*

## ■ Making an All Call

Your radio must be programmed to allow you to use this feature. Users on the channel cannot respond to an All Call.

- 1 Turn the Channel Selector Knob to select the channel with the active All Call group ID.
- 2 Hold the radio vertically 1 to 2 inches (2.5 to 5.0 cm) from your mouth.
- 3 Press the **PTT** button to make the call. The LED lights up solid green.
- 4 Wait for the Talk Permit Tone to finish (if enabled). Speak clearly into the microphone.
- 5 If there is no voice activity for a programmed period of time, the call ends.

*When you **receive** an All Call, you cannot use any programmed button functions until the call ends.*

## ■ Making a Call Alert

- 1 Press the programmed **One Touch Call** button to send the Call Alert to a predefined ID.
- 2 The LED lights up solid green.
- 3 Two chirps indicate that the Call Alert acknowledge is successfully received.

## ■ Sending a Quick Text Message

- 1 Press the programmed **One Touch Call** button send a predefined Quick Text Message to a predefined ID.
- 2 The LED lights up solid green.
- 3 Two chirps indicate that the message is sent successfully.  
**OR**  
A low-pitch tone indicates that the message cannot be sent.

## ■ Sending an Emergency Alarm

- 1 Press the programmed **Emergency** button.
- 2 The LED lights up solid green.
- 3 When an Emergency Alarm acknowledgment is received, the Emergency tone sounds. The LED blinks green.  
**OR**  
If your radio does not receive an Emergency Alarm acknowledgement, and after all retries have been exhausted, a low-pitch tone sounds.
- 4 Radio exits the Emergency Alarm mode.

*If your radio is set to Silent, it will not display any audio or visual indicators during Emergency mode.*

## ■ Privacy

Press the programmed **Privacy** button to toggle privacy on or off.







**MOTOROLA**

Motorola, Inc.  
1301 E. Algonquin Rd.  
Schaumburg, IL 60196-1078, U.S.A.

MOTOROLA and the Stylized M Logo are registered in the U.S. Patent and Trademark Office. All other product or service names are the property of their respective owners.

© 2006 – 2008 by Motorola, Inc.  
All rights reserved. Printed in the U.S.A.  
April 2008

[www.motorola.com/mototrbo](http://www.motorola.com/mototrbo)



6880309T27-D



## Free Manuals Download Website

<http://myh66.com>

<http://usermanuals.us>

<http://www.somanuals.com>

<http://www.4manuals.cc>

<http://www.manual-lib.com>

<http://www.404manual.com>

<http://www.luxmanual.com>

<http://aubethermostatmanual.com>

Golf course search by state

<http://golfingnear.com>

Email search by domain

<http://emailbydomain.com>

Auto manuals search

<http://auto.somanuals.com>

TV manuals search

<http://tv.somanuals.com>