

Motorola DSR-6000 Commercial Integrated Receiver/Decoder Operator Guide



WARNING

The unauthorized modification of any decoder and the sale and use of any such decoder is prohibited by law. Any such modification or alteration of this product or any unauthorized reception of television programming could subject the user and seller and party modifying the decoder to fines, imprisonment, and civil damages.

NOTE: This equipment has been tested and found to comply with the limits for a Class A digital device, pursuant to Part 15 of the FCC Rules. These limits are designed to provide reasonable protection against harmful interference when the equipment is operated in a commercial environment. This equipment generates, uses and can radiate radio frequency energy and, if not installed and used in accordance with the instruction manual, may cause harmful, interference to radio communications. Operation of this equipment in a residential area is likely to cause harmful interference in which case the user will be required to correct the interference at his own expense. This digital apparatus does not exceed the Class A limits of radio noise emissions from digital apparatus set out in the Radio Interference Regulations of the Canadian Department of Communications.

Repairs and Assistance

For assistance on return or repair see "Product Support" on page 55.

Note to CATV System Installer

This reminder is provided to call the CATV system installer's attention to Article 820-40 of the National Electric Code (NEC) that provides guidelines for proper grounding and, in particular, specifies that the cable ground shall be connected to the grounding system of the building, as close to the point of cable entry as practical.

Warning

To prevent electrical shock, do not use the decoder electrical power plug (polarized) with an extension cord, receptacle, or other outlet unless the blades can be fully inserted to prevent blade exposure. The mains disconnect device is the appliance plug and it shall remain readily accessible and operable.

The lithium battery is not field-replaceable for the life of the product.

General Instrument Corporation doing business as
Motorola, Inc.
6450 Sequence Dr.
San Diego, CA 92121

DOCUMENT No: 557526-001 REV A, 2/12/09

OPERATION PRECAUTIONS

WARNING: TO PREVENT FIRE OR SHOCK HAZARD, DO NOT EXPOSE THIS EQUIPMENT TO RAIN OR MOISTURE.

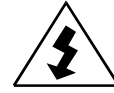

The lightning flash with the arrowhead symbol, within an equilateral triangle, is intended to alert the user to the presence of un-insulated "dangerous voltage" within the product's enclosure that may be of sufficient magnitude to constitute a risk of electric shock to persons.



The exclamation point within an equilateral triangle is intended to alert the user to the presence of important operating and maintenance (servicing) instructions in the literature accompanying the product.

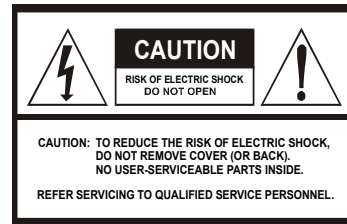

ATTENTION

This commercial unit is intended for the decoding of DigiCipher[®] II television signals for commercial use. Possession of this device does not enable or entitle the possessor to receive DigiCipher II television signals. Contact program providers to obtain appropriate authorizations.

Copyright © 2009 Motorola, Inc.
MOTOROLA and the Stylized M Logo are registered in the US Patent & Trademark Office. All other product or service names are the property of their respective owners. Dolby Digital is a registered trademark of Dolby Laboratories. Dolby Digital is manufactured under license from Dolby Laboratories.

© Motorola, Inc. 2009

Covered under one or more of the following General Instrument U.S. Patents: 4613901; 4634808; 4712238; 4792973; 4823399; 4864615; 4908859; 4933898; 5068724; 5083293; 5091782; 5093720; 5111504; 5144664; 5216295; 5216374; 5216503; 5235643; 5345408; 5376968; 5398237; 5406228; 5485577; 5517250; 5530400; 5537420; 5565922; 5566089; 5598415; 5606616; 5638128; 5675387; 5699124; 5703877; 5717461; 5742623; 5754659; 5771239; 5809538; 5844615; 5949795 and patents pending.

Important Safety Instructions

- Read these instructions.
- Keep these instructions.
- Heed all warnings.
- Follow all instructions.
- Do not use this apparatus near water.
- Clean only with dry cloth.
- Do not block any ventilation openings. Install in accordance with the manufacturer's instructions.
- Do not install near any heat sources such as radiators, heat registers, stoves, or other apparatus (including amplifiers) that produce heat.
- Do not defeat the safety purpose of the polarized or grounding-type plug. A polarized plug has two blades with one wider than the other. A grounding-type plug has two blades and a third grounding prong. The wide blade or the third prong is provided for your safety. If the provided plug does not fit into your outlet, consult an electrician for replacement of the obsolete outlet.
- Protect the power cord from being walked on or pinched, particularly at plugs, convenience receptacles, and the point where they exit from the apparatus.
- Use only attachments and accessories specified by the manufacturer.

- Unplug this apparatus during lightning storms or when unused for long periods of time.
- Refer all servicing to qualified service personnel. Servicing is required when the apparatus has been damaged in any way, such as when the power-supply cord or plug is damaged, liquid has been spilled, or objects have fallen into the apparatus, the apparatus has been exposed to rain or moisture, does not operate normally, or has been dropped.

Damage Requiring Service

Unplug this equipment from the power source, and contact a qualified service provider if any of the following situations occurs:

- If the power supply cord or plug is damaged.
- If liquid or objects have fallen into the unit.
- If the unit became wet from rain or water.
- If the unit was dropped or damaged.
- If the unit's performance changes.

Service

Do not try to service this product yourself. If you open or remove the cover, you may be exposed to dangerous voltage or other hazards and may void the unit's warranty. Contact a qualified service provider for all service.

Table of Contents

Chapter 1	Introducing the DSR-6000	1
	Key Features	1
Chapter 2	Connecting the DSR-6000	3
	Unpacking and Connecting the DSR-6000	3
	Unpacking	5
	Mounting	5
	Mechanical Loading	5
	Ambient Temperature	5
	Circuit Overloading	5
	Connecting the DSR-6000	6
Chapter 3	Operating the DSR-6000	7
	Using the Front Panel.....	8
	Navigating the Menus.....	9
	How to Use the Menus	10
	About Menu.....	10
	Main Menu	10
	Overview of The LCD Panel Menu Tree	11
	Installation Menus	14
	Manual Tune Menu	14
	Input Field	15
	Mode Field	15
	Xpndr Field.....	16
	LFreq Field.....	16
	Modulation Menu.....	17
	Mode Field	17
	Symbol/Code/Format Field	18
	Port Menu.....	18
	ID Field.....	19
	Mode Field	19
	Sat Field.....	19
	Polar Field.....	19
	Audio1, Audio2, and Audio 3 Menus	20
	DialNorm Field	20
	AudioMix Field	20
	Compress Field.....	21
	Audio1, Audio2, and Audio3 Gain Menus	22
	Mode Field	22
	Left and Right Fields	22
	Alarm Menu	23
	Trigger Field.....	23
	Test Field	23

ASI Output Menu	24
Enable Field	24
Pid Alias Field	24
Format Field	24
Reset Menu	25
Reset Type Field	25
Factory Defaults Option	25
Power Cycle Option	26
Core Menu	26
Contrast Field	26
Video Out Format Menu	27
525 Lines Field	27
625 Lines Field	27
Firmware Menu	28
Boot:FPGA:High Field	28
Upgrade Field	28
D/C Firmware Menu	28
Download Menu	29
File Field	29
Current Field	29
Rcvd Field	29
Total Field	29
DR Menu (Acquisition Recovery)	30
MODE Field	30
VCT (Virtual Channel Table) Field	30
VCN (Virtual Channel Network) Field	30
PORT Field	30
Channel Menus	31
Channel Menu	31
VCT Field	31
Channel Field	31
Xpndr Field	32
MPEG Select Menu	33
Program Field	33
Decrypt Setup Menu	34
MODE Field	34
NO (Number) Field	34
PGM (Program) Field	34
AS (Authorization State) Field	34
Aud1Lang, Aud2Lang, and Aud3Lang Menus	35
Dspl Field	35
Left and Right Fields	36
InputMode Field	37

Text Lang Menu	37
Display Field	37
IP Menus	38
MAC Address Menu	38
DHCP Menu	38
DHCP Field	38
Unit Name Field	38
IP Address Menu	39
Subnet Mask Menu	39
IP Gateway Menu	40
Port GigE MAC Address Menu	40
GigE IP Address Menu	40
GigE Subnet Mask Menu	41
GigE Default Gateway Menu	41
GigE Mode Menu	41
GigE MPTS Address Menu	42
MPTS Address Field	42
Port Field	42
AMS Address Menu	42
Status Display Menus	43
Status1 Menu	43
FrontPanel Field	43
Input Type Field	43
Status2 Menu	43
Source Field	43
Channel Field	44
Quality Field	44
Status3 Menu	44
Status4 Menu	44
Sat Field	44
Freq Field	44
Symb Field	45
Code Field	45
Format Field	45
Status5 Menu	45
Sync Field	45
Es/No Field	45
Authorization State Field	45
Status6 Menu	46
Memory Field	46
Flash Field	46
Hard Drive Field	46

Diagnostics Menus	46
Menus Field.....	47
Clear_Cntrs Field	47
KS Field	47
Unit Address Menu.....	47
TV Pass Card Menu	48
Audio Test Signal Menu	48
L1/R1, L2/R2, and L3/R3 Field.....	48
Video Test Signal Menu	49
Pattern Field.....	49
VITS Menu	50
Waveform Field	50
Field Field.....	51
Line Field	51
Ad Insertion Test Menu	51
Cue Tone Signal Field.....	51
Relay Field	51
Chapter 4 Troubleshooting	53
Chapter 5 Product Support.....	55
If You Need Help	55
Calling for Repairs.....	55
Chapter 6 Downlink/L-Band Frequency Conversion Tables.....	57
Chapter 7 Language Abbreviations	59
Chapter 8 Diagnostics	61
Introduction.....	61
Viewing the Fast Fact Diagnostic Screens.....	62
Fast Facts Screens	63
Fast Facts 1	64
Fast Facts 2	66
Fast Facts 3	67
Fast Facts 4 (Audio 1 and 2).....	69
Fast Facts 4 (Audio 3).....	70
Fast Facts 5 (10/100 Network).....	71
Fast Facts 5 (Gigabit Ethernet)	72
Chapter 9 DSR-6000 Specifications.....	73



Introducing the DSR-6000

The Motorola DSR-6000 is a commercial Integrated Receiver Decoder (IRD), or radio, designed for broadcasters and headend operators for receiving digital satellite services. The DSR-6000 unit will process both high-definition and standard-definition video services. After the DSR-6000 unit is properly configured, it is ready to receive authorization and control information from the satellite operator.

Key Features

- HD Transport Stream pass-through via ASI or Gig-E output.
- MPEG-2 HD to Composite Video Decoding – Single channel MPEG-2 HD video decoding to SD composite video output in the appropriate 4x3 format (center, left, right extract, and letterbox).
- DVB-S2 Demodulation.
- GigE Output – Accommodates current trend for distributing MPEG-2 transport streams over Gigabit Ethernet interfaces throughout cable headends.
- Control Interface – SNMP monitoring and trap generation for next generation control systems.
- Retune – Accommodates uplink controlled channel retune commands.
- PID Aliasing – Output PID values remain constant on ASI/GigE output.
- Web Browser Interface provides a status and control interface for an external web browser.
- A variable front-end allows the DSR-6000 to be used in either full or partial transponder mode.
- Eight L-band inputs or one ASI input Transport Stream input.
- Two mirrored ASI outputs.
- The DSR-6000 is capable of storing multiple Virtual Channel Tables (VCTs) and Network Information Tables (NITs). One VCT may be selected at a time.

- Once the IRD has acquired an MPEG signal, the user can select a program from a list of programs as defined in the Program Association Table (PAT).
- One video and one diagnostic (OSD) video output.
- Closed Caption support.
- Operational modes include: DC-II MAN, DVB-MAN, DCII-AUTO, 8PSK-TC, and DVBS2. Detailed modulator settings options will vary depending on the unit's operational mode setting.
- MPEG-2 video and Dolby® Digital/MPEG-2 Layer 1 audio are employed for video decode/decompression and audio compression respectively.
- DTMF output and relay control of tape machines and other ad insertion equipment.
- Three Form-C relays used for uplink control and one for fault alarm indication.
- Memory configuration is saved in nonvolatile memory.
- Security features include Motorola DigiCipher II security technology.
- A two-line, 40-character front panel with a Liquid Crystal Display (LCD).



Connecting the DSR-6000

Unpacking and Connecting the DSR-6000

Cable connections, described in this chapter, are made to the back panel of the DSR-6000.

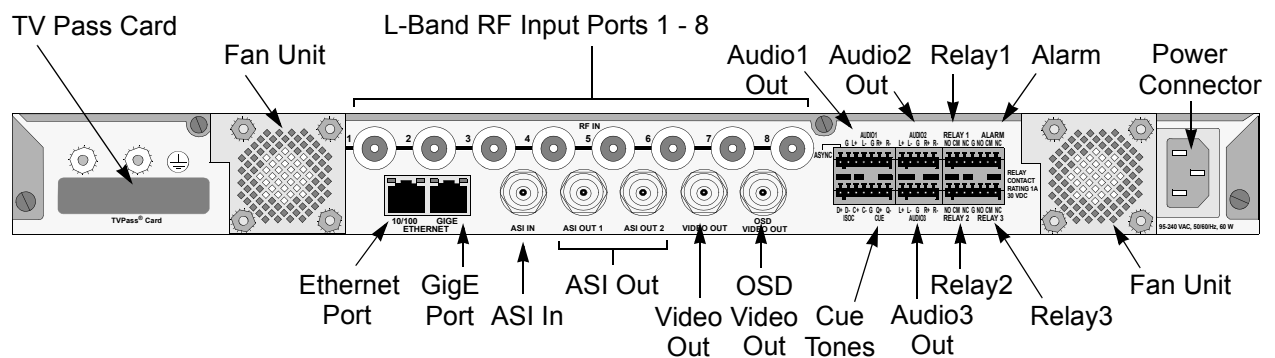

Figure 2-1: DSR-6000 Back Panel (Overview)

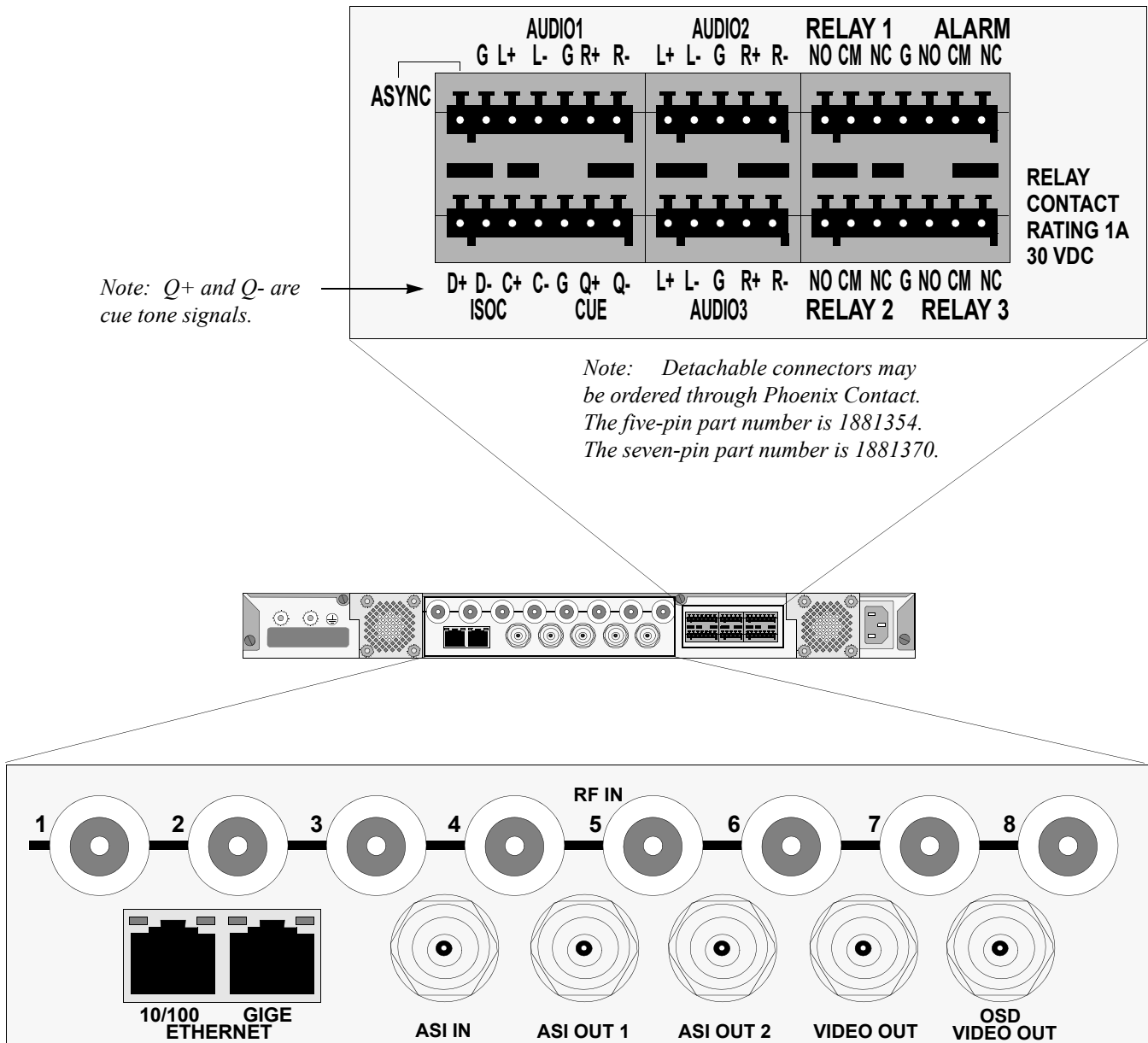

Figure 2-2: DSR-6000 Back Panel (Detailed)

Unpacking

The shipping carton contains the DSR-6000, quick disconnect terminals, a power cord, and this Operator Guide.

Mounting

The DSR-6000 should be installed in an Electronics Industry Association (EIA) compliant 19-inch (480 mm) rack. It is recommended that the IRDs have 1RU spacing, above and below, for airflow.

Mechanical Loading

The mounting rack location should be secure and level to avoid hazardous instability to the equipment due to uneven loading or weight distribution within the rack.

Ambient Temperature

When installing an encoder within a closed or multi-unit rack, the ambient temperature may be greater than the ambient temperature within the room. Therefore, verify that the amount of air flow required for safe operation is not compromised (maximum temperature for the equipment is 50° C). Consideration should be given to the maximum rated ambient temperature for the DSR-6000's location when planning for cooling and air circulation.

Circuit Overloading

If the DSR-6000 is connected to a power strip, rather than a branch circuit's direct connection, use special care to ensure that the unit is properly connected. Always consider the affect that overloading circuits might have on over-current protection and supply wiring. Check all equipment power/amperage ratings to ensure the mounting rack power rating is not exceeded.

Connecting the DSR-6000

To Connect a DSR-6000 for a New DigiCipher II Service

First determine which satellite, transponder, Virtual Channel Table (VCT) number, and virtual channel is to be used. Contact the programmer for this system information so that the desired services can be received.

Connect the desired L-Band (satellite antenna LNB or LNB signal splitter) source cable to any RF input Port 1 through 8.

An alternative input option is to connect an appropriate ASI source to the ASI input.

To view video and On-Screen Diagnostics (OSD) during installation, connect the OSD Video Output on the DSR-6000 to a 75-ohm video monitor or television with composite video input (standard definition).

DSR-6000 will generate time-specific ad insertion cue tones, using messages the programmer can include in the encoded signal. If these cue tones are needed and made available, connect the differential Cue Tone+, Cue Tone- and Ground terminals on the DSR-6000 to the 600-ohm device receiving the tones.

Note: The DSR-6000 provides an alarm relay that can be used to signal an alarm condition. To indicate an alarm, the DSR-6000 provides a short-circuit electrical connection between the NC and CM terminals and an open-circuit electrical connection between the NO and CM terminals. With this configuration, the DSR-6000 is able to signal an alarm for the loss of AC power.

Plug the DSR-6000 into a power source. Verify that the LCD screen is lit.

Proceed with the installation using the front panel menus.



Operating the DSR-6000

All operations described in this chapter require use of the front panel, as shown in Figure 3-1.

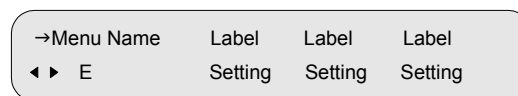

Figure 3-1: DSR-6000 Front Panel

Using the Front Panel

The front panel LCD screen displays a series of menus that can be used to configure and control the system. The name of the current menu is always in the upper left corner of the screen for easy identification.

- Beneath every menu name are symbols representing key presses that are possible from the current cursor position in the menu. Note that the available keypad moves may change during the navigation between menu fields.



- The top row, to the right of the menu name, displays the name of each field available within that menu. These are called field labels and its setting is displayed directly below.
- Beneath each label is the current setting for each field.
- Some fields may be changed by the user and others are for display purposes only. Fields that can be changed have an arrow indicator (→) just to the left of the field label. During left/right navigation, the cursor skips over the labels that cannot be changed.

In addition to the menus on the LCD screen, the LED indicators show the decoder's current status. The Signal LED is lit when the decoder recognizes a valid carrier signal. The authorized LED is lit when the DigiCipher II signal LED is lit and either (1) the programmer has transmitted the access messages to allow the decoder to decrypt the signal, or (2) the signal is unencrypted or fixed key.

If the IRD is in an alarm condition, the Alarm LED is lit.

Navigating the Menus

Even though the keypad options shown on the LCD screen may change for each menu and for each field, the control buttons basically do the same thing. The user may want to practice on a screen to become familiar with how the buttons work. Notice that:

- Pressing the ▲ ▼ buttons while the cursor is blinking next to the menu name (far left corner), causes the cursor to scroll to another menu.
- Pressing the ENTER button while the cursor is blinking next to the menu name (far left corner) causes the cursor to scroll to the Main, top-level menu.
- Pressing the ◀ ▶ buttons while in the top line of the menu causes the cursor to move between field labels (or the menu name and a field label). Pressing the ▶ button at the rightmost field label causes the cursor to wrap to the left side of the screen (to the menu name). Likewise, pressing the ◀ button when the cursor is at the menu name causes the cursor to wrap to the rightmost field label.
- When the cursor is blinking on a field label (top row), pressing the ENTER button causes the cursor to move below the label and enter into the field so the setting can be changed.
- When the cursor is below the label, the displayed directional controls in the left corner show what buttons can be pressed to change the setting in that field. When the ▲ ▼ symbol is left of the field, this indicates the ability to select from available or downloaded choices for that field. Placing the blinking cursor on those arrows and using those arrow buttons will reveal each of the available choices for that field, one at a time. To store changes in a field and move back up to the label line, press the ENTER button.

How to Use the Menu

About Menu

The front-panel LCD displays the About menu when the DSR-6000 is initially plugged in or after a factory reset. This menu identifies the model (MOTOROLA DSR-6000) and the second line displays the DSR-6000's actual firmware version instead of 0xXXXXXX, as shown below.

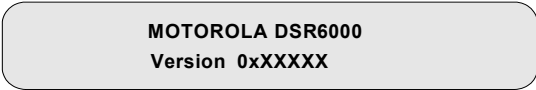

```
MOTOROLA DSR6000
Version 0xXXXXXX
```

This menu is displayed for 30 seconds, then the front-panel LCD displays the Main menu.

Main Menu

This menu is the top-level menu and can be navigated to from any other menu by pressing the ENTER button while the cursor is blinking next to the menu name. This menu allows the user to select any one of the five main menu groups: Installation menus, Channel menus, IP menus, Status menus, and Diagnostic menus.



```
DSR6000
< >E →Install →Channel →IP →Status →Diag
```

The DSR-6000 allows the user to scroll only to menus that are in the same group. To scroll to a menu that is in a different menu group, return to the main top-level menu and select the desired menu group.

Overview of The LCD Panel Menu Tree

Pressing the ENTER button when the cursor is on a menu name causes the cursor to return to the main, top level menu. The charts on the following pages show the menus organized into five main groups: Installation menus, Channel selection menus, IP menus, Status menus, and Diagnostic menus.

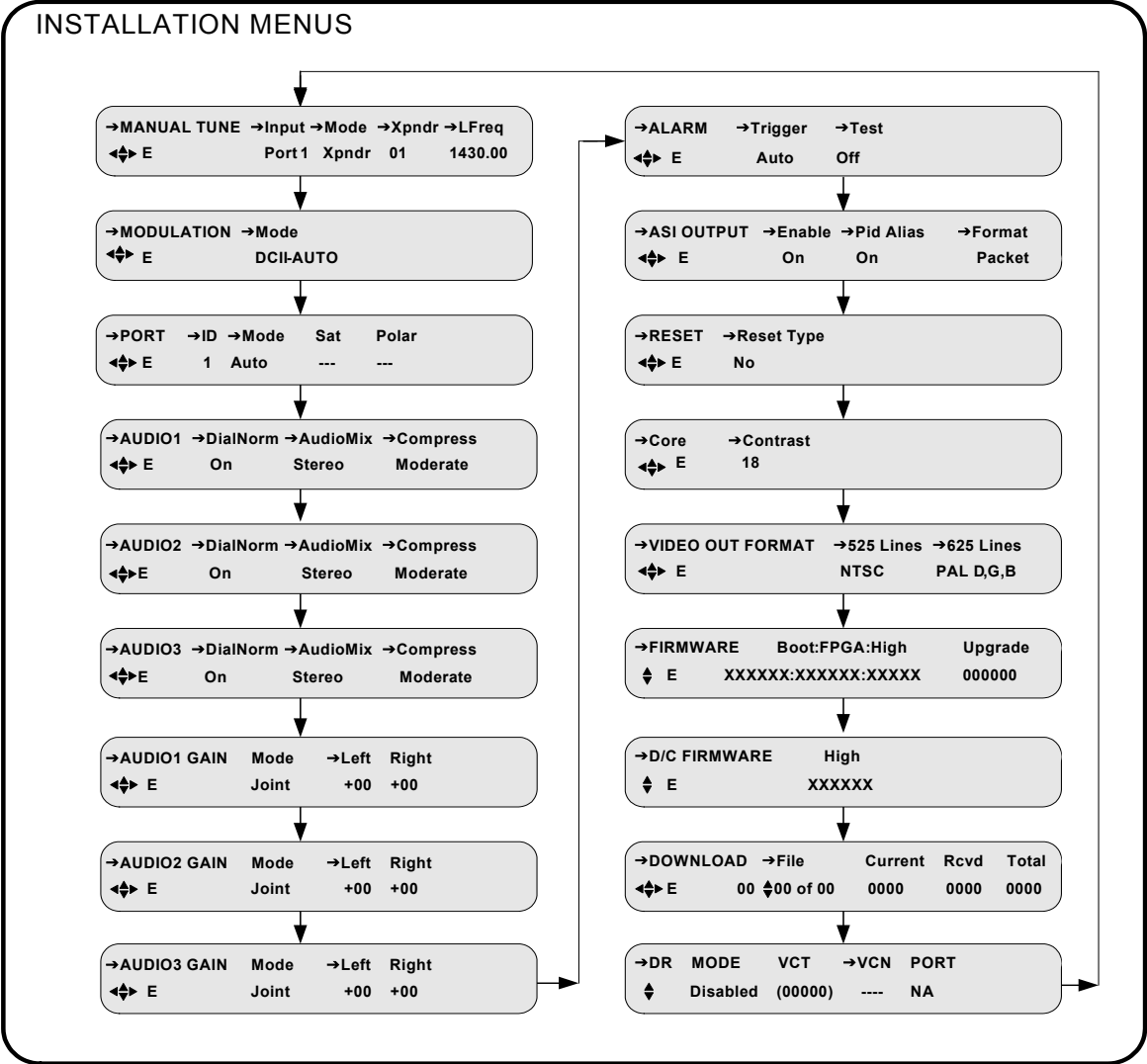

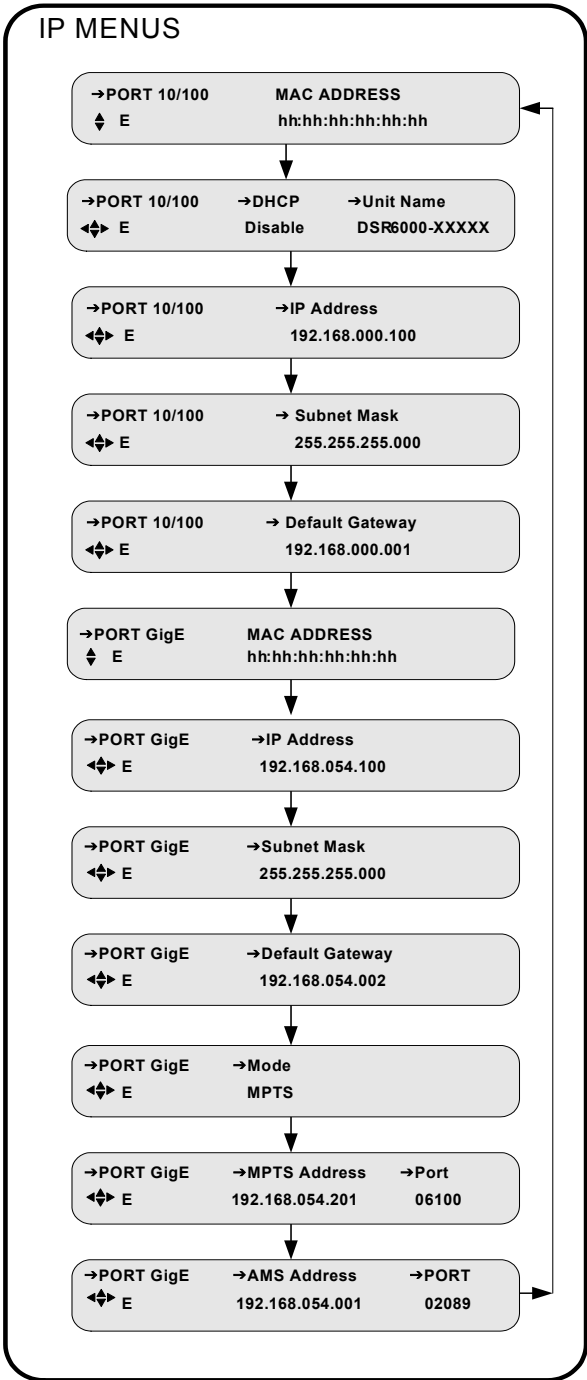
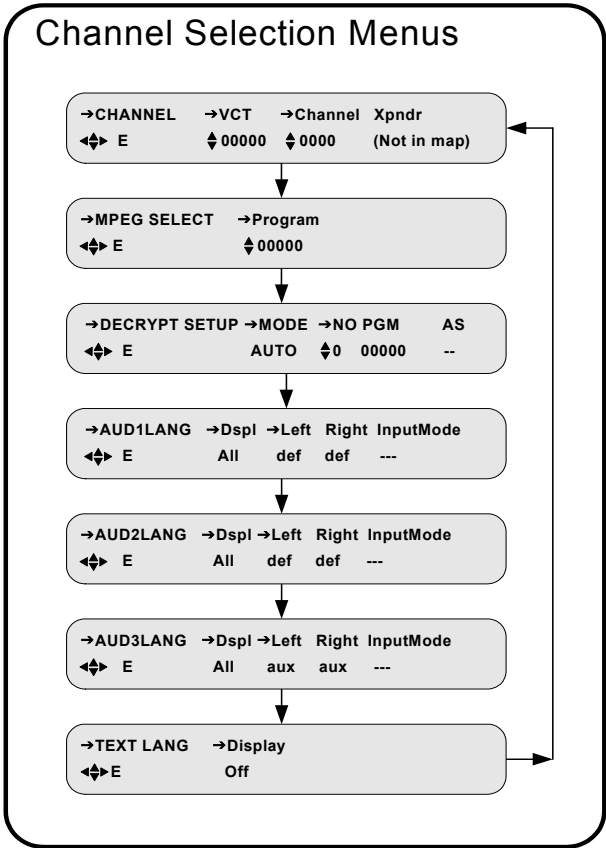

Status Menu

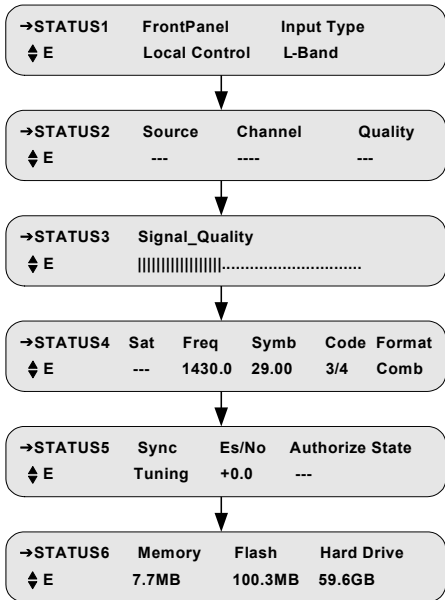

Diagnostic Menu

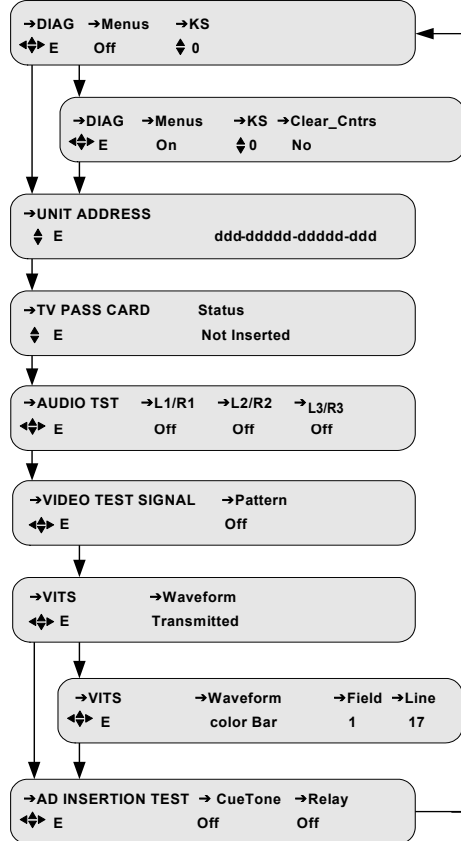

Installation Menus

The purpose of the installation menus is to configure the ports and choose settings that remain fixed over time. This section describes in detail each of the Installation menus, fields, and options displayed on the LCD panel.

Return to the main top-level menu and then select the installation menu group.

With the blinking cursor at the upper left, press ENTER button to return to the main top-level menu. Press the ◀ ▶ buttons until the cursor is at the Install label, and press the ENTER button. The DSR-6000 displays the previously selected sub-menu.

Manual Tune Menu

Use this menu to begin to acquire a DigiCipher II system signal, by selecting a transponder frequency for any of the eight L-Band inputs. In addition, this menu allows a user to select the ASI input, as an alternative to RF ports 1-8.

```
→MANUAL TUNE →Input →Mode →Xpnr →LFreq
◀▶ E          Port1 Xpndr 01 1430.00
```

```
→MANUAL TUNE →Input
◀▶ E          ASI In
```

Because many satellite broadcasters use standard C-band transponder center frequencies, selecting a transponder number is the default tuning mode. Use the Xpndr option in the Mode field and edit the Xpndr (transponder) field (described on page 16), for tuning such signals.

For offset-frequency C-band, fractional transponders, or Ku-band satellite broadcasts, use the LFreq option in the Mode field (described on page 16), and directly edit the L-band frequency field.

The DSR-6000 does not actually require any distinction between C-band and Ku-band satellite signals in order to tune and acquire a compatible signal. However, correct modulation information is necessary. For details on modulation, see "Modulation Menu" on page 17.

Input Field

Default: Port 1

The Input field displays the input to which the decoder is currently tuned. It allows manual selection of Port 1 through Port 8 or the ASI input so that the DSR-6000 can acquire the DigiCipher II system signal and automatically download network data required for operation. To select the input:

Press the **▶** button until the cursor is at the Input label and press the ENTER button.

Press the **▲ ▼** buttons to scroll to the input that is connected. Unless changed, the DSR-6000 displays values for Port 1. Press ENTER to confirm the selection and return to the top line of the menu. If Port 1 through Port 8 is selected, then move to the Mode field, Xpndr field, or Lfreq field. These three fields are not visible when ASI In is selected.

The following screen prompts the user to confirm the selection.

CAUTION: Service will be interrupted
Press E to continue or **◀▶** to stop

If you press any arrow button (**◀ ▶ ▲ ▼**) at this point, the Caution screen disappears and the MANUAL TUNE menu reappears without any changes. To set the port selection, press the ENTER button.

Mode Field

Default: Xpndr

The Mode field allows selection of the frequency plan type for the satellite signal to which the DSR-6000 is tuned. If the application is a North American C-band satellite center frequency, select the transponder number in the Xpndr field. Otherwise, use the L Freq option and the LFreq field. The L Freq option can be used for current satellite LNB signals, including C-band and Ku-band.

Press the **▶** button until the cursor is on the Mode label. Then press the ENTER button to move into the field. There are two choices: Xpndr and L Freq. Press the **▲ ▼** buttons to display the desired choice. Then press the ENTER button to confirm the selection.

If Xpndr is selected, choose a transponder in the Xpndr field. The frequency in the LFreq field is set automatically and cannot be edited.

If L Freq is selected, the Xpndr field no longer appears because the transponder/frequency relationship is not known. Select a transponder frequency between 950 and 2150 MHz in the LFreq field. This field is not available when the ASI In option in the Input field is selected.

Xpndr Field

This field is not available when the ASI In option in the Input field is selected.

This field allows selection of an initial satellite transponder number and can only be used if the Xpndr option in the Mode field is selected. The Xpndr field cannot be edited if L Freq in the Mode field is selected. Press the ► button until the cursor is at the Xpndr label. Then press the ENTER button to move into the field.

Then press the ▲ ▼ buttons to select the desired transponder number. Since the associated transponder/frequency tables are stored in the DSR-6000, scroll through the transponder numbers and notice that the associated frequency (shown in the L Freq field to the right) automatically changed with the selection (970-1430 MHz). There are 24 transponder options, and when the desired transponder selection is displayed, press the ENTER button to confirm selection and move the cursor back up to the field label.

L Freq Field

This field is not available when the ASI In option in the Input field is selected.

If the L Freq option in the Mode field is chosen, use this field, to directly tune the frequency. The L Freq field cannot be edited if Xpndr is chosen in the Mode field. Press the ► button until the cursor is at the L Freq label. Then press the ENTER button to move into the field.

Use the arrow buttons (◀ ▶ ▲ ▼) to select the desired frequency. Select a frequency between 950 MHz and 2150 MHz and press the ENTER button to confirm a selection and move the cursor back up to the field label.

For those satellite carriers which are offset (C-band or Ku-Band), use the L Freq option to enter the exact center frequency of a carrier, rather than using a nearby-but-not-exact C-band transponder center frequency. Long-term frequency tracking is best if the user enters a precise carrier center frequency.

Contact the programmer or network operator for details about the satellite, transponder, and frequencies being used. If one frequency is identified as the root transponder, using this frequency may expedite the download process during installation.

Modulation Menu

This menu is not available when the ASI In option is selected. That option is located in the Manual Tune menu (described on page 14).

This menu, together with the Manual Tune menu, allows the user to initially acquire a DigiCipher II signal. Press the ▲ ▼ buttons until the MODULATION menu appears. Press the ENTER button to continue.

```
→MODULATION →Mode
↔ E          DCII-AUTO
```

When either of the DCII-MAN, DVB-MAN, 8PSK-TC, or DVBS2 options in the Mode field are selected, the user must additionally specify a Symbol/Code/Format combination.

```
→MODULATION →Mode →Symbol Code Format
↔ E          DCII-MAN 19.51 3/4 Comb
```

```
→MODULATION →Mode →Symbol Code
↔ E          DVB-MAN 19.510000 3/4
```

```
→MODULATION →Mode →Symbol →Code
↔ E          8PSK-TC 01.000000 2.05
```

```
→MODULATION →Mode →Symbol
↔ E          DVBS2 01.000000
```

Mode Field

Press the ▶ button until the cursor is at the Mode label, and press the ENTER button to move into the field. Press the ▲ ▼ buttons to display the options: DCII-AUTO, DCII-MAN, DVB-MAN, 8PSK-TC, and DVBS2. Select a mode and press ENTER to exit the field.

Note: In DCII-MAN or DVB-MAN (both manual) modes, the DSR-6000 only searches for what is displayed in the Symbol and Code fields. In DVBS2 mode, the DSR-6000 only searches for what is displayed in the Symbol/Code/Format field for both 8PSK-DVBS2 and QPSK-DBVS2 to acquire a signal and then remains locked on that signal. If DCII-AUTO is selected, the DSR-6000 searches through all available combinations to acquire a signal and then remains locked on that signal.

Symbol/Code/Format Field

Press the **▶** button until the cursor is at the Symbol label and press the ENTER button to move into the field. Press the **▲ ▼** buttons to display the options. For DCII Manual, use the **▲ ▼** buttons to scroll through the Symbol/Code/Format combinations. Select the combination provided by your programmer and press ENTER to return to the top menu. This field is not available when the DCII-Auto option in the Mode field is selected. When using the 8PSK-TC and DVBS2 modes, the Symbol field can be edited to any value up to 33.0000. For each of these non-DCII modes, the Code field is independently selected from a list of supported values, by using the **▲ ▼** buttons.

Port Menu

This menu is not available when the ASI input option is selected. That option is described in the “Manual Tune” menu on page 14.

Because the DSR-6000 has eight RF input ports that can potentially be used to switch and tune signals from multiple satellite antenna LNBS, the DSR-6000 demands there be an accurate association of the port with the Satellite and Polarity designators programmed in the Uplink encoder system(s) to which we plan to downlink from on each port.

Because accuracy is critical, a default AUTO mode has been created for automatically populating the satellite and polarity fields for the one port that is currently being tuned. This automatic population of the fields occurs upon entry of acceptable Channel information.

Leaving this menu unchanged, in AUTO mode, ensures success in getting initial authorization, decryption and output.

→PORT	→ID	→Mode	Sat	Polar
↔ E	1	Auto	---	---

Using the Manual Port Mode setting and manually editing the Port Menu Satellite and Polarity fields should only be done when given detailed instructions by an Uplink Signal Provider. Any mismatch between what is entered into these fields and the Uplink encoder Satellite and Polarity designations for the services will prevent authorization decryption and service output. Satellite names and polarity designators for a given service do not necessarily reflect actual satellite names or even the correct polarity of the actual signal. These values are set within the provider’s encoder system.

ID Field**Default: 1**

Use this field to choose which port to configure. Press the ▶ button until the cursor is at the ID field, then use the ▲ ▼ buttons to choose a port (1-8). Press the ENTER button to confirm the selection and exit the field.

Mode Field**Default: AUTO**

Use the Mode field to select the mode for port setup. Press the ▶ button until the cursor is at the Mode label, and press the ENTER button to move into the field. Press the ▲ ▼ buttons to view the desired mode. There are two options: Manual and Auto. Press the ENTER button to exit.

Sat Field**Default: ---**

Use this field to select a satellite name, when the Manual option in the Mode field is selected.

Press the ▶ button until the cursor is at the Satellite label. Press the ENTER button to enter this field, use the ◀ ▶ buttons to select the character position to be changed. Then use the ▲ ▼ buttons to scroll through the character choices. Press the ENTER button to confirm selection and exit the field.

This field displays the satellite to which the port is related and is not editable when the AUTO option in the Mode field is selected. This field displays dashes (---) when the port is not related to a satellite.

Polar Field**Default: ---**

Use this field to select a polarity when the Manual option in the Mode field is selected. Press the ▶ button until the cursor is at the Polar label. Press the ENTER button to enter this field and press the ▲ ▼ buttons to display the options: H/LHP (Horizontal/Left-Hand Polarity) or V/RHP (Vertical/Right-Hand Polarity). Select a polarity and press ENTER to exit the field.

Audio1, Audio2, and Audio 3 Menus

These menus have three fields that allow the user to customize the audio output based on options provided by the digital audio compression. Press the ▲ ▼ buttons until the Audio1, Audio2, or Audio3 menu appears (shown below).

→AUDIO1 →DialNorm →AudioMix →Compress
 ⬅️ E On Stereo Moderate

→AUDIO2 →DialNorm →AudioMix →Compress
 ⬅️ E On Stereo Moderate

→AUDIO3 →DialNorm →AudioMix →Compress
 ⬅️ E On Stereo Moderate

DialNorm Field

Default: On

The DialNorm field allows the user to normalize speech levels to a constant level over all channels—raising or lowering the volume of the dialogue to a level that is appropriate for the background sound track.

Press the ▶ button until the cursor is at the DialNorm label. Press the ENTER button to move into the field. There are two options, On and Off. Press the ▲ ▼ buttons to change the setting. Press ENTER to confirm selection.

AudioMix Field

Default: Stereo

Note: If the audio input mode is stereo and you are connecting to a mono modulator, you must set this field to Mono.

This field allows selection of the audio processing options. Press the ▶ button until the cursor is at the AudioMix label, and press the ENTER button to move into the field. Press the ▲ ▼ buttons to display the options:

- Stereo Stereo output on both left and right channel
- Surround Enhanced stereo with surround pass-through
- Mono Mono output on left channel
- Dual Mono Mono output on both left and right channels

CAUTION MESSAGE: If Dual Mono is selected, a caution screen appears.

CAUTION: Check audio language selection
Press E to continue or ◀▶ to stop

This warning screen denotes possible conflicts between this menu and the language selection menus that could mute the audio. By pressing the ENTER button (ignoring the caution), the DSR-6000 changes to Dual Mono, and uses the language previously selected for Mono (or Stereo) for both left and right channels.

To select a single language for Mono, Dual Mono, or Stereo output, see "Aud1Lang, Aud2Lang, and Aud3Lang Menus" on page 35.

Compress Field

Default: Moderate

This field allows control of the degree of audio level compression. Press the ► button until the cursor is at the Compress label, and press the ENTER button to move into the field. Press the ▲ ▼ buttons to display the options:

- **Heavy** Reduces the louder audio signals and boosts the softer signals using tighter compression thresholds in order to eliminate dramatic fluctuations in the audio signal level and suppress dynamic range of the audio signal.
- **Moderate** Provides some reduction and amplification of the audio signal, but the thresholds are wider apart, providing moderate dynamic range of the audio signal.
- **Off** Compression is not used and provides full dynamic range of the audio signal.

Press the ENTER button to confirm the selection.

Audio1, Audio2, and Audio3 Gain Menus

These menus allow adjustment of the audio signal output level from 0 to -20 dB, in 1 dB increments. Press the ▲ ▼ buttons until the desired menu appears (either AUDIO1 GAIN, AUDIO2 GAIN, or AUDIO3 GAIN).

→AUDIO1 GAIN	Mode	→Left	Right
↔ E	Joint	+00	+00

→AUDIO2 GAIN	Mode	→Left	Right
↔ E	Joint	+00	+00

→AUDIO3 GAIN	Mode	→Left	Right
↔ E	Joint	+00	+00

The user may adjust the output levels of the left and right channels jointly. The output level of the right channel tracks the setting for the left channel when the output levels are adjusted jointly.

Mode Field

Default: Joint

Note: The Mode field is not editable.

This field is associated with the Audio Gain port and is always set to Joint. This means, both channels are configured jointly using the Left field settings as the control for both audio channels.

Left and Right Fields

Default: +00

Note: The Right field is not editable.

The Left field allows adjustment of the output level of the Left and Right audio signals. Press the ► button until the cursor is at the left label, and press the ENTER button to move into the field.

Use the ▲ ▼ buttons to simultaneously adjust the output level for the left and right audio signals from +0 to -20 dB, in 1 dB increments.

Press the ENTER button to confirm the selections.

Alarm Menu

Press the ▼ button until the ALARM menu is located. This menu allows the user to set up different trigger options for the DSR-6000 to go into an alarm condition. This option illuminates the front-panel Alarm LED and energizes the back-panel alarm relay.

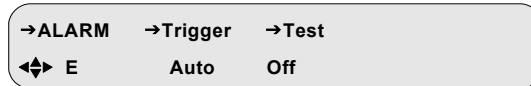

Trigger Field

Default: AUTO

Press the ▶ button until the cursor is at the Trigger label, and press the ENTER button to move into the field. Press the ▲ ▼ buttons to display the options. The Trigger field allows the user to select the trigger condition for which the alarm is activated. When the alarm is activated, the Alarm LED illuminates and the alarm relay indicates an alarm condition. With the AUTO (default) trigger setting, the alarm is activated for any of the following conditions:

- The tuner loses lock when the input is RF (Loss of the Signal LED).
- The DSR-6000 cannot lock to the ASI input when the specified input is ASI.
- The DSR-6000 is unable to render video.
- The DSR-6000 is not authorized to access the selected service.

There are six options: Auto, No Signal, No Video, No Auth (Authorization), AUTO+HDD, and Disabled. Use this option to select which of the above conditions activates the alarm.

Test Field

Default: Off

The Test field provides an alarm test. The alarm is activated when this field is set to On. The Test field returns to the default value (Off) when the field is exited.

ASI Output Menu

Press the ▲ ▼ buttons until the ASI Output menu appears. This menu allows the user to configure the digital ASI output. It is used to define the format of the ASI output and to enable PID aliasing.



```

→ASI OUTPUT →Enable →Pid Alias →Format
←↔ E          On      On          Packet
  
```

Note: The DSR-6000 has the ability to output an MPEG-2 transport multiplex stream at a data rate of either 54 Mbps or 81 Mbps, depending on whether PID aliasing is enabled or not. When PID aliasing is enabled, the DSR-6000 outputs an MPEG-2 transport stream that contains only one MPEG service and at a data rate of 54 Mbps. This MPEG service corresponds to the service content that is available at the analog video and audio outputs (the monitored service). Otherwise, when PID aliasing is disabled, the DSR-6000 outputs an MPEG-2 transport stream at a data rate of 81 Mbps, which contains all of the MPEG services that the DSR-6000 receives from the uplink. Up to four services are decrypted, as selected by the Decrypt Setup menu.

Enable Field

Default: On

Note: The ASI output can be disabled by control information from the Uplink Programmer (Broadcast Network Controller [BNC]).

When ASI output is disabled by the BNC, this field is not editable and displays Lock Off. Otherwise, if the BNC enables the ASI output, this field is editable with the default value (On). Press the ▲ ▼ buttons to display the options (On and Off).

Pid Alias Field

Default: On

When this field is set On, the DSR-6000 remaps all PIDs to a constantly-set of values and incorporates the remapped value in the output transport stream. If the Uplink Programmer (Broadcast Network Controller [BNC]) enforces PID aliasing, the PID Alias field becomes uneditable from the front-panel and the PID Alias field displays Lock On. When this field is set Off, the DSR-6000 does not remap PID values. Any incoming PIDs values are retained and sent to the output transport stream.

Format Field

Default: Packet

If the PID Alias field is set to OFF, the Format field is non-editable and it displays the default (Packet).

With PID Alias set to ON, use this field to specify the transport stream packet structure (either as a burst of contiguous bytes [Packet option], or as individual bytes [Byte option]).

Reset Menu

Press the ▲ ▼ buttons until the Reset menu appears. This menu allows the user to execute factory defaults or power cycle resets.

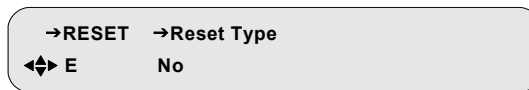

Reset Type Field

Default: No

Press the ▶ button until the cursor is at the Reset Type label, and press the ENTER button to move into the field. Press the ▲ ▼ buttons to display the options: No, Factory Defaults, or Power Cycle.

Factory Defaults Option

The Factory Defaults option allows the user to reset the system to the programming values originally set by the factory firmware.

Caution: Selecting this reset option deletes all defined setups and downloaded information. This operation interrupts service output, so use it carefully.

Press the ENTER button. A warning message reminding you that all programming will be lost if the action proceeds.

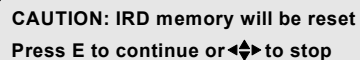
A screenshot of a warning message in a terminal window. The text reads: 'CAUTION: IRD memory will be reset' followed by 'Press E to continue or ▶ to stop' on the next line. The text is in a monospaced font on a light gray background.

Press any arrow button (◀ ▶ ▲ ▼) to back out of the field and leave it unchanged. Otherwise, press the ENTER button to proceed. The following message displays.

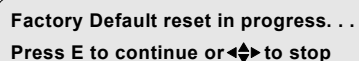
A screenshot of a message in a terminal window. The text reads: 'Factory Default reset in progress. . .' followed by 'Press E to continue or ▶ to stop' on the next line. The text is in a monospaced font on a light gray background.

Power Cycle Option

The Power Cycle option reboots the DSR-6000 without losing internal user setup information or downloaded network information. Pressing the ENTER button causes the following warning message to appear.

CAUTION: Reset will interrupt service
Press E to continue or ◀▶ to stop

Press any arrow button (◀ ▶ ▲ ▼) to back out of the field and leave it unchanged. Otherwise, press the ENTER button to proceed. The following message displays:

Power Cycle reset in progress. . .
Press E to continue or ◀▶ to stop

Core Menu

Press the ▲ ▼ buttons until the Core menu appears. This menu allows the user to change the front panel LCD contrast.

→Core →Contrast
◀▶ E 18

Contrast Field

Default: 18

To adjust the LCD contrast, press the ▶ button until the cursor is at the Contrast label, and press the ENTER button to move into the field. Use the arrow buttons (◀ ▶ ▲ ▼) to select a value between 1 and 30, with 1 representing the least contrast and 30 the most. Adjust the contrast so that the LCD panel can be read clearly. Press the ENTER button to confirm the selection.

Video Out Format Menu

Press the ▲ ▼ buttons until the Video Out Format menu appears. It has two fields that allow modification of the output format. The decoder does not convert 525-line video to 625-line video or convert 625-line video to 525-line video. When the input to the uplink encoder is 525-line, the field here selects the decoder output to be NTSC or PAL M, and the 625-line field has no impact. When the input to the uplink encoder is a 625-line, the field selects the type of PAL the decoder outputs, and the NTSC or PAL M selection has no impact.



525 Lines Field

Default: NTSC

Press the ▶ button until the cursor is at the 525 Lines label, and press the ENTER button to move into the field. This field allows selection of the output format for 525-line video as either NTSC or PAL M. Use the arrow buttons (◀ ▶ ▲ ▼) to specify the desired option and press the ENTER button to confirm the selection.

625 Lines Field

Default: PAL D G B

Press the ▶ button until the cursor is at the 625 Lines label, and press the ENTER button to move into the field. This field allows selection of the output format for 625-line video as either PAL D G B, PAL I, or PAL N. Press the ▲ ▼ buttons to display the options. Press the ENTER button to confirm the selection.

Note: The DSR-6000 does not support PAL.

Firmware Menu

Press the ▲ ▼ buttons until the Firmware menu appears. This menu displays the DSR-6000's firmware release information, which is equivalent to the product version number. This menu cannot be changed, but since the firmware is periodically updated, this menu confirms that the update was successful. This menu is used most commonly in troubleshooting. The High version value (shown below) is the current firmware version.



Boot:FPGA:High Field

This field displays the version of boot, FPGA, and the high code. The boot code is loaded at the factory. The FPGA and high codes may be upgraded to later versions by a download that is delivered over the satellite signal from either the L-band or ASI input. The code versions are represented by a six-digit hexadecimal number. This field is non-editable.

Upgrade Field

The Upgrade field displays the version of the upgrade code that is available. This field displays 000000 when no upgrade code is available. Available upgrades are installed the next time the DSR-6000 is rebooted. This field is non-editable.

D/C Firmware Menu

Press the ▲ ▼ buttons until the D/C Firmware menu appears. This menu displays the release decoder code number. This menu cannot be changed, but since the firmware is periodically updated, this menu confirms that the update was successful. This menu is used most commonly in troubleshooting.

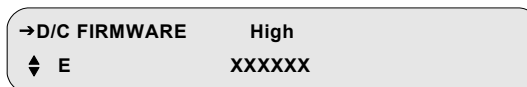

Download Menu

Press the ▲ ▼ buttons until the DOWNLOAD menu appears. This menu allows the user to monitor the status of the current code download. This menu is used most commonly in troubleshooting.

→DOWNLOAD	→File	Current	Rcvd	Total
↔ E	00 ↕00 of 00	0000	0000	0000

During a background code download, the DSR-6000 collects the upgrade code in the background while concurrently decoding video and audio services. The user can select this menu anytime before, during, and after a background code download.

File Field

The File field consists of two sub-fields; the first sub-field is editable and selects, by index, a download file for monitoring. The second sub-field is non-editable and indicates the total number of files that have been downloaded and/or are available to be downloaded.

Current Field

This non-editable field pertains to the file selected in the File field and indicates the ID for the current segment received by the DSR-6000 during the download of the file.

Rcvd Field

This non-editable field indicates the number of segments that the DSR-6000 has received for the file selected in the File field.

Total Field

This status-only field displays the ID for the last segment of the file selected in the File field.

DR Menu (Acquisition Recovery)

Use this menu to review the Acquisition Recovery map. This menu is used most commonly in troubleshooting. Press the ▲ ▼ buttons until the DR menu appears.

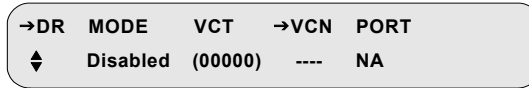

MODE Field

This non-editable field displays the DR mode (either Disabled or Channel).

VCT (Virtual Channel Table) Field

This non-editable field displays the Acquisition Recovery map's Virtual Channel Table (VCT) number (0 to 65535) that is currently specified by the Uplink Programmer (BNC). If the VCT is not available, the VCT number is enclosed in parenthesis.

VCN (Virtual Channel Network) Field

If this field displays ----, the field is non-editable, and no channels are available for selection.

Use this field only to view the configuration of each channel's port. If the PORT field displays Not Defined, this means the channel's port is not configured.

PORT Field

This non-editable field displays one of the following three messages:

- | | |
|-------------|--|
| NA | The VCT is either not available or set to (00000). |
| Not Defined | The DSR-6000 is not available to map a VCT or a configured port. This means the channel's port is not configured. |
| 1,X0(20),H | Input port number (1-8) that is associated with the specified channel (followed by a comma).
Satellite name.
Satellite ID within brackets (followed by a comma).
Polarity specified with either H (for Horizontal) or V (for Vertical). |

Channel Menus

Channel Menu

Press the ▲ ▼ buttons until the Channel menu appears. This menu allows the user to select an active VCT, select the virtual channel, and view the name of the current transponder.

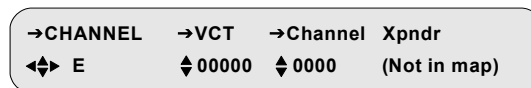

VCT Field

Use this to select a Virtual Channel Table (VCT) number. Contact the program provider for the correct VCT number to enter for that encoder system. Press the ▶ button until the cursor is at the VCT label, and press the ENTER button to move into the field. While ensuring that the cursor remains on the up/down symbol, press the ▲ ▼ buttons to scroll throughout the available VCTs. (If the network has four VCTs, then only four VCTs appear in this field.) Press the ENTER button to confirm the selection.

This field also provides a second method for selecting the VCT. To do this, use the ◀ ▶ buttons to select the digit to change and then, while the cursor is on that digit, press the ▲ ▼ buttons to display the required value. Repeat this process for each applicable digit.

Channel Field

The Channel field allows selection of the virtual channel for the output service. The DSR-6000 supports channel values from 0000 to 4095. Press the ▶ button until the cursor is at the Channel label, and press the ENTER button to move into the field. While ensuring that the cursor remains on the up/down symbol, press the ▲ ▼ buttons to scroll through the available virtual channels. (If the chosen VCT contains twenty-four virtual channels, then only twenty-four virtual channels appear in this field.) Press the ENTER button to confirm the selection.

This field also provides a second method for selecting the virtual channel. To do this, use the ◀ ▶ buttons to select the digit to change and then, while the cursor is on that digit, press the ▲ ▼ buttons to display the required value. Repeat this process for each applicable digit.

The DSR-6000 displays warning messages for the following conditions:

- A warning message is displayed when the user changes from a MPEG program number selection to a virtual channel.

CAUTION: Changing to DCII selection mode
Press E to continue or $\leftarrow\rightarrow$ to stop $\leftarrow\rightarrow$

Press any arrow button (\leftarrow \rightarrow \uparrow \downarrow) to back out of the field and leave it unchanged. Otherwise, press the ENTER button to proceed.

- If the user selects a virtual channel that is not in the chosen VCT, then a warning message, “Not in map” is displayed to the right of the virtual channel.

\rightarrow CHANNEL \rightarrow VCT \rightarrow Channel Xpndr
 $\leftarrow\rightarrow$ E \updownarrow 00000 \updownarrow 0000 (Not in map)

- Virtual channels identify satellite and polarity attributes. The RF input ports are set up with satellite and polarity attributes. For more details, see "Port Menu" on page 18. The DSR-6000 uses these satellite and polarity attributes to determine which RF port to use. However, if the user selects a virtual channel that does not match the satellite and polarity attributes of either port, then the DSR-6000 is unable to determine which port to use and the following warning message is displayed.

CAUTION: Channel dddd not present
Press E to continue or $\leftarrow\rightarrow$ to stop

Press any arrow button (\leftarrow \rightarrow \uparrow \downarrow) to back out of the field and leave it unchanged.

Note: The DSR-6000 cannot decode the chosen virtual channel until a port is set up with the applicable satellite and polarity information.

Xpndr Field

This non-editable field displays the current (Xpndr) transponder name (alpha/numeric) that is downloaded. If the user selects a virtual channel that is not in the chosen VCT, then a warning message, (Not in map) is displayed to the right of the virtual channel. This field serves as a label or identifier for the signal source. For more details, see "Port Menu" on page 18.

MPEG Select Menu

This menu allows the user to select which service is displayed at the video and audio outputs by specifying the MPEG program number. Press the ▲ ▼ buttons until the MPEG Select menu appears. The MPEG program number can be used instead of a virtual channel, but only if the DSR-6000 is already tuned to the appropriate L-band or ASI input signal.

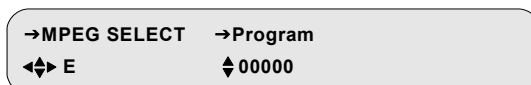

Program Field

Press the ▶ button until the cursor is at the Program label, and press the ENTER button to move into the field. While ensuring that the cursor remains on the up/down symbol, press the ▲ ▼ buttons to scroll throughout the available MPEG programs. (If the current L-band or ASI input signal contains four MPEG programs, then only four MPEG programs appear in this field.) Press the ENTER button to confirm the selection.

This field also provides a second method for selecting the MPEG program. Use the ◀ ▶ buttons to select the digit to change and then, while the cursor is on that digit, press the ▲ ▼ buttons to display the required value. Repeat this process for each applicable digit.

The DSR-6000 displays warning messages for the following conditions:

- A warning message is displayed when the user changes from a virtual channel to a MPEG program number. Press any arrow button (◀ ▶ ▲ ▼) to back out of the field and leave it unchanged. Otherwise, press the ENTER button to proceed.

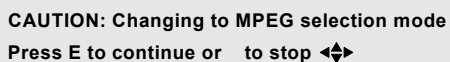

CAUTION: Changing to MPEG selection mode
Press E to continue or to stop

- A warning message displays when an MPEG program number is selected which does not exist.

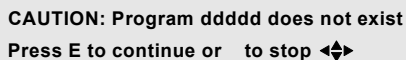

CAUTION: Program ddddd does not exist
Press E to continue or to stop

Press any arrow button (◀ ▶ ▲ ▼) to back out of the field and leave it unchanged. Otherwise, press the ENTER button to proceed.

Decrypt Setup Menu

Use this menu to specify up to four services in the transport stream to decrypt. This menu is operational when the transport stream output is not configured for PID aliasing. When the DSR-6000 is configured for PID aliasing, it decrypts the single service that is selected by the virtual channel or MPEG program number.



MODE Field

Default: AUTO

When this field is set to AUTO, the DSR-6000 decrypts the first four services by MPEG program number, in low-to-high order. When this field is set to Manual, use the NO field and PGM field to specify which services to decrypt.

NO (Number) Field

Default: 0

Use this field to select among the four service slots available for decryption. These decryption slots are numbered 0, 1, 2, and 3. The PGM field can have a unique value (or zeros) assigned to each slot.

PGM (Program) Field

Default: 00000

If the MODE field is set to AUTO, the PGM field is non-editable and it displays the assigned program.

With MODE set to Manual, use this field to specify the MPEG program number to decrypt for each slot numbered 0 - 3. If the MPEG program number is not available, the DSR-6000 inserts parentheses around the value. Use the ▲ ▼ buttons to scroll through all available known MPEG programs in the current transport stream. Use the CLEAR value to remove a program and thus clear the decryption slot. This field also provides a second method for selecting the MPEG program. Use the ◀ ▶ buttons to select the digit to change and then, while the cursor is on that digit, press the ▲ ▼ buttons to display the required value. Repeat this process for each applicable digit.

AS (Authorization State) Field

This non-editable field displays the authorization state of the service that is selected in the PGM field. This field displays one of the following states:

AU	Authorized
NA	Not Authorized
--	No authorization information is available for the specified service.

Aud1Lang, Aud2Lang, and Aud3Lang Menus

These menus (Audio1, Audio2, and Audio3 Language) have three fields that allow the user to modify and view the status of the language for the Audio1, Audio2, and Audio3 outputs. This menu also allows the user to view the mode of the audio signal as it is received from the programmer and before any subsequent down mixing that the DSR-6000 may perform. Press the ▲ ▼ buttons until the desired menu appears (either Aud1Lang, Aud2Lang, or Aud3Lang).

```
→AUD1LANG →Dspl →Left Right InputMode
↔ E      All  def  def  ---
```

```
→AUD2LANG →Dspl →Left Right InputMode
↔ E      All  def  def  ---
```

```
→AUD3LANG →Dspl →Left Right InputMode
↔ E      All  aux  aux  ---
```

Note: The two digits in the Left, Right fields indicate the occurrence of the specified language. The range is between 00 and 99. For example, use Eng13 for the 13th version of English. This feature is used when there are multiple dialects within a language.

Dspl Field

Default: def

Press the ▶ button until the cursor is at the Dspl (Display) label, and press the ENTER button to move into the field. This field allows the user to select the options that are displayed in the Left (channel) and Right (channel) fields. There are three options: All, Avail, and Status. Press the ▲ ▼ buttons to specify the desired option.

- The All option allows the user to use the arrow buttons to enter the three-letter code. You may wish to select languages that are not functional at this time but will be functional in the future. Press the ENTER button to confirm the selection.
- The Avail (Available) option allows the user to scroll through the languages supported by the system while the cursor is in the Left and Right fields. Furthermore, selection of this option allows the user to scroll through only the languages available for the active service. (If the active service has only three languages, as listed for the virtual channel or program, only three appear. If the user changes the service, the number of languages may also change.) Press the ENTER button to confirm the selection.

- The Status option allows the user to view the actual audio language. The actual language can differ from the chosen language when the user's choice for language is unavailable. The bullets in the next topic describe the rules that govern which language is used.

Left and Right Fields

Press the **▶** button until the cursor is at the Left label, and press the ENTER button to move into the field. If the user selects the Dual Mono at the AudioMix field (described on page 20), Left and Right will have separately editable fields. Otherwise, they are controlled together as a pair from the Left field alone. These fields allow the user to set the language through the following three options: (1) Any language if the language is set to All, (2) the currently available languages if the Dspl is set to Avail, or (3) def (default) if the Dspl field is set to either All or Avail. Press the **▲ ▼** buttons to specify the desired option. Press the ENTER button to confirm the selection.

The following bullets describe the rules that govern which language is used:

- If def (default) is selected, the Audio 1 and Audio 2 outputs default to the first and second language, respectively, that is listed for the service. It is suggested that programmers run their language listing so that this default is the language that matches the audio.
- If the AudioMix field (described on page 20) is set to Surround, Stereo, or Mono and the user's choice for language is not available, the audio output is the default language.
- If the AudioMix field (described on page 20) is set to Dual Mono and a language pair is not available that matches the user's choice for Left and Right languages, the DSR-6000 selects and outputs the first occurrence of the Left language choice. The system cannot take a Left from one audio pair and a Right from another. If there is no match for the Left language choice, the DSR-6000 uses the default language.
- There is an interaction between the Language (Lang) menu and the AudioMix field (described on page 20): If the user had previously selected Stereo or Mono in the AudioMix field and a specific language as the audio output in the Lang menu, but later changes the AudioMix menu setting to Dual Mono, the Dual Mono changes in this menu to the same language specified for both Dual Mono channels and a caution screen displays. After changing the AudioMix menu to Dual Mono, reselect the languages desired here, in this menu.
- If the user previously selected Dual Mono in the AudioMix field with two different languages as audio outputs in the Language menu, but later selects Stereo, Stereo Surround, or Mono in the AudioMix field, the output in this Language menu defaults to the first occurrence of a specified language (the one defined for the Left channel first, then for Right channel if there is no match for the Left). In this case, the same caution screen appears.

InputMode Field

This read-only field indicates the incoming audio mode of the active service.

Text Lang Menu

This Text Language menu has the Display field which allows the user to modify and view the status of the language for the subtitle display. Press the ▲ ▼ buttons until the Text Lang (Text Language) menu appears.

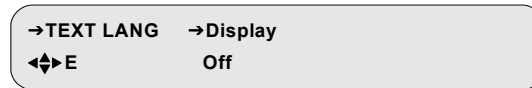

Display Field

Default: Off

This field has the following options:

- The All option allows the user to enter the desired language which may or may not be present in that service. You may wish to select languages that are not functional at this time but will be functional in the future. Press the ENTER button to confirm the selection.
- The Avail (Available) option allows the user to scroll through the languages supported by the system while the cursor is in the field. Furthermore, selection of this option allows the user to scroll through only the languages available for the active service. (If the active service has only three languages, as listed for the virtual channel or program, only three appear. If the user changes the service, the number of languages may also change.) Press the ENTER button to confirm the selection.
- The Status option allows the user to view the actual text language. The actual language can differ from the chosen language when the user's choice for language is unavailable. The bullets on page 36 describe the rules that govern which language is used.
- The Off option disables subtitles.

IP Menus

Use the IP menu is to configure the 10/100 port.

MAC Address Menu

Use the following procedure to view the MAC address for the left Ethernet port on the back panel of the DSR-6000. Press the ▲ ▼ buttons until the MAC Address menu appears. This menu displays the Ethernet port MAC address. The address is represented in a hexadecimal format and it is not editable.

→PORT 10/100	MAC ADDRESS
↕ E	hh:hh:hh:hh:hh:hh

DHCP Menu

Press the ▲ ▼ buttons until the Port 10/100 DHCP menu appears. The front panel screen displays the DHCP and Unit Name fields. DHCP (Dynamic Host Configuration Protocol) allows the Satellite Multiplex Decrypter to obtain a set of IP parameters from a DHCP server. The DHCP server ensures that all these IP addresses are unique. This automates and facilitates the Satellite Multiplex Decrypter's access to the network. The management of the IP address pool, in this case, is handled by the server, and not by a human administrator.

→PORT 10/100	→DHCP	→Unit Name
↔ E	Disable	DSR6000-XXXXX

DHCP Field

Default: Disable

Enter the field and choose either Enable or Disable.

Unit Name Field

Default: DSR6000-XXXXX

The Unit Name is fully editable. It is placed into the outgoing DHCP request and is used for registration. The Unit Name, in most cases, is only a suggestion to the DHCP server and may be updated with a different name upon receiving the DHCP registration reply. If an updated name is received from a DHCP server, the Unit Name will be adjusted to show this change and will replace the user-entered name. The default name is DSR6000-XXXXX. The XXXXX is the DSR-6000's IP address in decimal.

IP Address Menu

Default: 192.168.000.100

Use the following procedure to set and view the IP address for the left Ethernet port on the back panel of the DSR-6000. Press the ▲ ▼ buttons until the IP Address menu appears. This menu allows the user to enter an IP address for the Ethernet port. The address is represented in the common dotted-decimal format. Contact the network administrator for details about configuring the Ethernet port for operation on your local network.

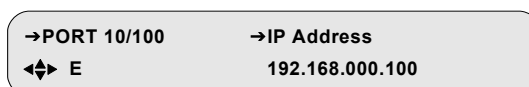

Press the ▶ button until the cursor is at the IP Address label, and press the ENTER button to move into the field. Press the ◀ ▶ and ▲ ▼ buttons to enter the desired address and then press ENTER to confirm the selection.

Subnet Mask Menu

Default: 255.255.255.000

Use the following procedure to set and view the Subnet Mask address for the left Ethernet port on the back panel of the DSR-6000. Press the ▲ ▼ buttons until the Subnet Mask menu appears. This menu allows the user to enter a subnet mask for the Ethernet port. The subnet mask is represented in the common dotted-decimal format. Contact the network administrator for details about configuring the Ethernet port for operation on your local network.

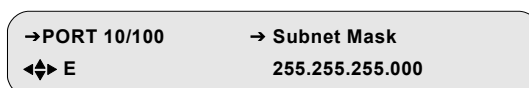

Press the ▶ button until the cursor is at the Subnet Mask label, and press the ENTER button to move into the field. Use the arrow button (◀ ▶ ▲ ▼) to enter the desired address and then press the ENTER button to confirm the selection.

IP Gateway Menu

Default: 192.168.000.001

Use the following procedure to set and view the Default Gateway address for the left (10/100) Ethernet port on the back panel. Press the ▲ ▼ buttons until the Default Gateway menu appears. This menu allows the user to enter an IP gateway address that the Ethernet port should use. The IP Gateway is an address that is represented in the common dotted-decimal format. Contact the network administrator for details about configuring the Ethernet port for operation on your local network.

→PORT 10/100 ↔ E	→ Default Gateway 192.168.000.001
---------------------	--------------------------------------

Press the ▶ button until the cursor is at the Default Gateway label, and press the ENTER button to move into the field. Use the arrow buttons (◀ ▶ ▲ ▼) to enter the desired address and then press the ENTER button to confirm the selection.

Port GigE MAC Address Menu

Default: hh:hh:hh:hh:hh

To view the GigE MAC address for the right Ethernet port on the back panel, press the ▲ ▼ buttons until the Port GigE menu appears. The address is represented in a hexadecimal format and it is not editable.

→PORT GigE ↕ E	MAC ADDRESS hh:hh:hh:hh:hh:hh
-------------------	----------------------------------

GigE IP Address Menu

Default: 192.168.054.100

Use the following procedure to set and view the GigE IP address for the right Ethernet port on the back panel of the DSR-6000. Press the ▲ ▼ buttons until the GigE IP Address menu appears. This menu allows the user to enter an IP address for the GigE port. The address is represented in the common dotted-decimal format. Contact the network administrator for details about configuring the GigE port for operation on your local network.

→PORT GigE ↔ E	→IP Address 192.168.054.100
-------------------	--------------------------------

Press the ▶ button until the cursor is at the IP Address field, and press the ENTER button to move into the field. Press the ◀ ▶ and ▲ ▼ buttons to enter the desired address and then press ENTER to confirm the selection.

GigE Subnet Mask Menu

Default: 255.255.255.000

Use the following procedure to set and view the GigE Subnet Mask for the right Ethernet port on the back panel of the DSR-6000. Press the ▲ ▼ buttons until the GigE Subnet Mask menu appears. The GigE subnet mask is represented in the common dotted-decimal format. Contact the network administrator for details about configuring the GigE port for operation on your local network.

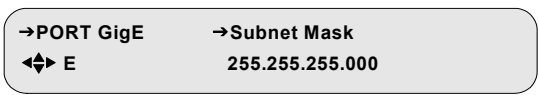

→PORT GigE →Subnet Mask
↔ E 255.255.255.000

Press the ▶ button until the cursor is at the Subnet Mask label, and press the ENTER button to move into the field. Use the arrow button (◀ ▶ ▲ ▼) to enter the desired address and then press the ENTER button to confirm the selection.

GigE Default Gateway Menu

Default: 192.168.054.002

Use the following procedure to set and view the GigE Default Gateway address for the Ethernet port on the back panel of the DSR-6000. Press the ▲ ▼ buttons until the GigE Default Gateway Address menu appears. This menu allows the user to enter the GigE Default gateway address that the Ethernet port should use. The GigE Default Gateway is an address that is represented in the common dotted-decimal format. Contact the network administrator for details about configuring the GigE port for operation on your local network.

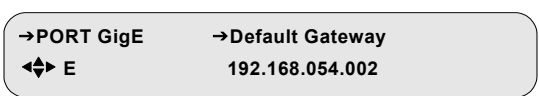

→PORT GigE →Default Gateway
↔ E 192.168.054.002

Press the ▶ button until the cursor is at the Default Gateway label, and press the ENTER button to move into the field. Use the arrow buttons (◀ ▶ ▲ ▼) to enter the desired address and then press the ENTER button to confirm the selection.

GigE Mode Menu

Default: MPTS

Press the ▲ ▼ buttons until the GigE Mode menu appears. This menu allows the user to select which multiple program transport stream (MPTS) is routed to the GigE port. The MPTS contains the output service.



→PORT GigE →Mode
↔ E MPTS

Press the ▶ button until the cursor is at the Mode label, and press the ENTER button to move into the field. Press the ▲ ▼ buttons to display the two options: MPTS and Off. Press ENTER to confirm the selection.

GigE MPTS Address Menu

Use the following procedure to set and view the MPTS address. Press the ▲ ▼ buttons until the GigE MPTS Address menu appears. The MPTS address is represented in the common dotted-decimal format. Contact the network administrator for details about configuring the MPTS address on your local network.

→PORT GigE	→MPTS Address	→Port
↔ E	192.168.054.201	06100

MPTS Address Field

Default: 192.168.054.201

Press the ▶ button until the cursor is at the MPTS Address label, and press the ENTER button to move into the field. Use the arrow button (◀ ▶ ▲ ▼) to enter the desired address and then press the ENTER button to confirm the selection.

Port Field

Default: 06100

Press the ▶ button until the cursor is at the Port label, and press the ENTER button to move into the field. Use the arrow button (◀ ▶ ▲ ▼) to enter the desired port ID (Range: 00000 to 65535) and then press the ENTER button to confirm the selection.

AMS Address Menu

The Asset Management System (AMS) menu option is reserved for future use.

Status Display Menus

Status display menus provide information regarding the current status of the DSR-6000. This menu lists important Satellite Multiplex Decrypter parameters. These fields are not editable, and the displayed information is either (1) the result of changes in an installation or channel selection menu, or (2) a parameter the DSR-6000 reports as part of its operation.

Status1 Menu

Press the ▲ ▼ buttons until the Status1 menu appears.

→STATUS1	FrontPanel	Input Type
◆ E	Local Control	L-Band

FrontPanel Field

This status-only field displays whether the user is able to control the Satellite Multiplex Decrypter completely from the front panel or whether some front panel functions are disabled.

Input Type Field

This status-only field displays the input connector on which the active signal is received.

Status2 Menu

This menu does not appear if the Input field (described on page 15) is set to ASI In. Press the ▲ ▼ buttons until the STATUS2 menu appears. This screen displays the source name, channel number, and the signal quality.

→STATUS2	Source	Channel	Quality
◆ E	---	----	---

Source Field

This status-only field displays the source name, which was entered by the programmer or network operator at the encoder/uplink to identify the source. Dashes are displayed when no information is available.

Channel Field

This status-only field displays the selected virtual channel number (from the Channel menu). Dashes are displayed when no information is available.

Quality Field

This status-only field displays a number from 1 to 100 so that the quality level of the signal can be judged. The signal quality is also displayed as a large bar graph in the Status3 menu. If the signal is 50 or less, it is marginal. If it is 35 or less, take action at your site to increase the dish size or improve the LNB to prevent occasional loss of output.

Status3 Menu

This menu does not appear if the Input field (described on page 15) is set to ASI In. Press the ▲ ▼ buttons until the STATUS3 menu appears. This screen displays the quality level of the signal as a large bar graph that expands to fill the entire LCD screen.



Status4 Menu

This menu does not appear if the Input field (described on page 15) is set to ASI In. Press the ▲ ▼ buttons until the STATUS4 menu appears. This screen displays the satellite name and signal tuning characteristics.



Sat Field

This status-only field displays the satellite name from the downloaded network information. Dashes are displayed when no information is available.

Freq Field

This status-only field displays the downlink frequency of the L-band signal. This may be different from the frequency that was initially set in the Manual Tune menu.

Symb Field

This status-only field displays the symbol rate (megasymbols per second) of the L-band signal. Dashes indicate that no information is available or when the ASI input is in use.

Code Field

This status-only field displays the code rate (error control coding for forward error correction) of the L-band signal.

Format Field

This status-only field displays the format (combined or split) of the L-band signal. Dashes are displayed when no information is available or when the ASI input is in use.

Status5 Menu

This menu does not appear if the Input field (described on page 15) is set to ASI In. Press the ▲ ▼ buttons until the STATUS5 menu appears. This screen displays the sync, Es/No and authorization state of the DSR-6000.

→STATUS5	Sync	Es/No	Authorize State
◆ E	Tuning	+0.0	---

Sync Field

This status-only field displays the acquisition Sync state. The Sync state can be either Locked or Tuning.

Es/No Field

This status-only field displays a value from 0.0 to 35.0 that designates a measurement of the signal to noise.

Authorization State Field

This status-only field displays the authorization state of the currently selected channel. Authorization State indicates how the Satellite Multiplex Decrypter is authorized. If the Authorization State is Not Authorized, the field will alternate, and display a reason why it is not authorized (e.g., Not in Sync).

Status6 Menu

Press the ▲ ▼ buttons until the STATUS6 menu appears. This screen displays the DSR-6000's Memory (free memory), Flash memory, and Hard Drive memory.

→STATUS6	Memory	Flash	Hard Drive
◆ E	7.7MB	100.3MB	59.6GB

Memory Field

This status-only field displays the amount of free volatile memory in MB units that is available for use by the operating system.

Flash Field

This status-only field displays the amount of free non-volatile memory in MB units that is available for use by the operating system.

Hard Drive Field

This status-only field displays the amount of free disk memory in GB units that is available for use by the operating system.

Diagnostics Menu

Use the DSR-6000's diagnostic menu to get additional information for troubleshooting. The menus also enable the user to test waveforms and use other diagnostic information displayed on an NTSC television monitor connected through the rear panel video output.

Caution: Turning on diagnostics changes the video or audio output, and these diagnostic screens or tones may be transmitted to the cable customers if the decoder is connected to the cable plant.

Press the ▲ ▼ buttons until the DIAG menu appears.

→DIAG	→Menus	→KS
◀▶ E	Off	◆ 0

Menus Field

Default: Off

The Menus field allows the user to enable or disable the on-screen diagnostics. Press the **▶** button until the cursor is at the Menus label, and press the ENTER button to move into the field. Press the **▲ ▼** buttons to scroll to the televised screen of choice. Press the ENTER button to exit this field.

Notice that if the Menus field is ON, the Clear_Cntrs (clear counters) field also appears.

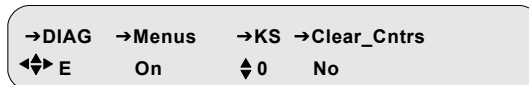

Clear_Cntrs Field

This field allows the user to reset selected counters to zero. This field is primarily for use with hotline troubleshooting, and it is recommended that it be used only when so directed and does not affect decoder operation, but it may give misleading troubleshooting results. To clear counters, press the **▶** button until the cursor is at the Clear_Cntrs label, and press the ENTER button to reset the counters to zero.

KS Field

Use this field to set the Key Stream (and associated service) which applies to Diagnostics B.

Unit Address Menu

This menu is for display only and displays the DSR-6000's 16-digit electronic address (range: 000-00000-00000-000 to 999-99999-99999-999). The program provider uses this address to identify a specific DSR-6000 for authorization and to retune messages. The display enables the user to view the address from the front panel rather than reading the label on the back panel.

Press the **▲ ▼** buttons until the Unit Address menu appears.

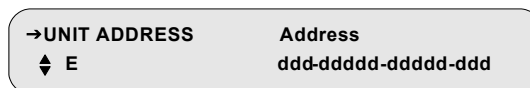

TV Pass Card Menu

The DSR-6000 does not initially require a TV Pass Card, but if one is required, the program provider typically supplies one. The program provider uses the TV Pass Card address and decoder address to identify a specific DSR-6000 for authorization messages.

Press the ▲ ▼ buttons until the TV Pass Card menu appears.



The display enables the user to view the TV Pass Card address from the front panel of the DSR-6000. There are three Status field options:

- Not Inserted
- xxx-xxxxx-xxxxx-xxx (a unique TV Pass Card address, range: 000-00000-00000-000 to 999-99999-99999-999)
- xxx-xxxxx-xxxxx-xxx Needs Mating.

Audio Test Signal Menu Default: Off

Use this menu to validate audio connection by transmitting internally-generated audible tones to the audio output ports.

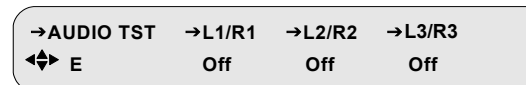

L1/R1, L2/R2, and L3/R3 Field

Use the appropriate field (either L1/R1, L2/R2, or L3/R3) to choose one of the following test tones: 1000, 3960, or 4040.

At the completion of the test, press the ENTER button to disable the test, exit the field, and return the field to the default setting (Off).

Video Test Signal Menu

Press the ▲ ▼ buttons until the Video Test Signal menu appears. A full-field video test signal is available and the user can display different test patterns by selecting the Pattern field.

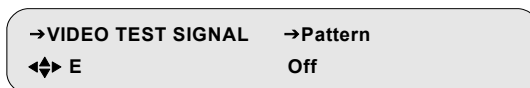

Pattern Field

Default: Off

Press the ▶ button until the cursor is at the Pattern label, and press the ENTER button to move into the field. Press the ▲ ▼ buttons to display the test patterns. Choose from the options listed below:

NTSC/PAL M Test Pattern Options
Color Bar
IRE 100 Ramp
NTSC 7 Comb
Red Field
NTSC 7 Comp
5 Step Stair
Unmod Y Ramp
Off (Default)

Press the ENTER button and a warning message appears saying that the current video display will be interrupted if the action proceeds.



Press any arrow button (◀ ▶ ▲ ▼) to back out of the field and leave it unchanged. Otherwise, press the ENTER button to proceed.

Test signals override any active service component, and the DSR-6000 displays diagnostics over the video test patterns if diagnostics are enabled. Disable the selected signals by displaying OFF or exiting the menu. Press the ENTER button to exit from the field.

VITS Menu

Press the ▲ ▼ buttons until the Vertical Interval Test Signal (VITS) menu appears. This menu allows the user to insert VITS on lines 17 or 18.



Waveform Field

Default: Transmitted

Note: Upon exiting this submenu, the Waveform field will revert back to the default value (Transmitted).

The Waveform field allows the user to insert a VITS from several internally stored patterns, from a pattern transmitted over the satellite link, or to turn off VITS insertion. Press the ▶ button until the cursor is at the Waveform label, and press the ENTER button to move into the field. Press the ▲ ▼ buttons to display the options. Choose from the options listed on the next page.

NTSC/PAL M VITS Pattern Field Options
Transmitted (Default)
Disabled
Color Bar
100 IRE Ramp
NTSC 7 Comb
Red Field
NTSC 7 Comp
5 Step Stair
Unmod Y Ramp

The Transmitted option (the default) indicates the signal is provided over the satellite link by the programmer, if one is present. Press the ENTER button to confirm the selection.

Note: If the Waveform option is neither Transmitted or Disabled, the Field and Line fields are displayed on the VITS menu.



Field Field**Default: 1**

This field allows the user to select the field on which the VITS is reinserted by the decoder. There are two choices, Field 1 or Field 2. Press the **▶** button until the cursor is at the Field label, and press the ENTER button to move into the field. Press the **▲ ▼** buttons to select the desired option and press the ENTER button to confirm the selection.

Line Field**Default: 17**

Press the **▶** button until the cursor is at the Line label, and press the ENTER button to move into the field. Press the **▲ ▼** buttons to display the options. The available line numbers are 17 or 18. Press the ENTER button to confirm the selection.

Ad Insertion Test Menu

Ad insertion signals are generated by the DSR-6000, but controlled by the uplink programmer. Local cable companies use ad insertion signals to control and to queue the insertion of commercials in cable headends. There are two ways to provide ad insertion. One is a dedicated digital DTMF differential output for cue tones. The other ad is a dedicated contact closure relay. The Ad Insertion Test menu allows the user to turn cue tones and the relays on and off.



Caution: Output to the customers may be interrupted. When turned on, the ad insertion signals can be sent to the local headed equipment.

Press the **▲ ▼** buttons until the Ad Insertion Test menu appears.

Cue Tone Signal Field**Default: Off**

Use this field to turn the cue tone test On and Off. Press the **▶** button until the cursor is at the Cue Tone label, and press the ENTER button to move into the field. Press the **▲ ▼** buttons to display the options. If On is selected, the DSR-6000 generates a DTMF code (0-9*#ABCD) on the cue tone output. This field returns to the default value (OFF) when the ENTER button is pressed to exit the field.

Relay Field**Default: Off**

Use the Relay field to individually turn ON and OFF each of the three ad insertion relays. Press the ENTER button to move into the field. Press the **▲ ▼** buttons to display the options. The available options are OFF, Relay 1 ON, Relay 2 ON, and Relay 3 ON. This field returns to the default value (OFF) when the ENTER button is pressed to exit the field.



Troubleshooting

Before contacting the Hotline (described on page 55), review Table 4-1 for problems and suggested solutions.

Table 4-1: Troubleshooting Solutions

Problem	Possible Cause	Solution	Reference
LCD blank and no LEDs lit.	No power to unit.	Plug in the unit.	
LEDs illuminate, but LCD is blank or too dark to read.	LCD contrast out of adjustment.	Adjust LCD contrast.	See IRD menu, Contrast field.
No picture and no signal LED indication.	No LNB signal port connection.	Connect LNB coax.	See "Connecting the DSR-6000" on page 3.
Poor audio quality or low audio level.	Audio levels incorrect.	Adjust audio levels.	
Will not acquire signal lock.	Port not configured.	Check port selection, modulation, and frequency setting.	
Incorrect output audio language.	Wrong language setting or audio port connection.	Confirm audio connection choice and related audio language setting.	



Product Support

If You Need Help

For assistance with Motorola products only, contact the Motorola Technical Response Center (TRC), 24 hours a day, 7 days a week:

- Inside the U.S.: 1-888-944-HELP (1-888-944-4357)
- Outside the U.S.: 1-215-323-0044
- Motorola Online: <http://businessonline.motorola.com>
This offers a searchable solutions database, technical documentation, and low-priority issue creation and tracking.

Calling for Repairs

If repair is necessary, call Motorola's authorized repair vendor, World Wide Digital (WWD) at 1-800-227-0450 or 1-956-541-0600 for a Return for Service Authorization (RSA) number before sending the unit for repair. The RSA number must be prominently displayed on all equipment cartons. WWD is open from 8:00 AM to 5:00 PM Central Time, Monday through Friday.

When shipping equipment for repair, follow these steps:

1. Pack the unit securely.
2. Enclose a note describing the exact problem.
3. Enclose a copy of the invoice to verify the warranty status.
4. Label all cartons with the RSA number.
5. Ship the unit PREPAID to:

World Wide Digital
c/o Loera Customs Brokerage, Inc.
Attn: RSA # ****
5845 E. 14th Street, Suite D
Brownsville, TX 78521



Downlink/L-Band Frequency Conversion Tables

A distributor or programmer can provide the latest C-band and Ku-band frequency plans at purchase time.

If desired, the following formulas have been provided to perform calculations for both C-band and Ku-band transponders, or if the user is installing for a new satellite.

Table 6-1: Calculation for C-Band Transponders

Formula for C-band Frequency	Example calculation if downlink frequency is 3,740 MHz
$5,150 \text{ MHz} <\text{minus}> \text{Frequency Downlink (DL)} <\text{equals}> \text{Frequency (C-band)}$	$\begin{array}{r} 5,150 \text{ MHz} \\ -3,740 \text{ MHz} \\ \hline 1,410 \text{ MHz} \end{array}$

Table 6-2: Calculation for Ku-Band Transponders

Formula for Ku-band Frequency	Example calculation if downlink frequency is 12,019 MHz
$\text{Frequency Downlink (DL)} <\text{minus}> 10,750 \text{ MHz} <\text{equals}> \text{Frequency (Ku-band)}$	$\begin{array}{r} 12,019 \text{ MHz} \\ -10,750 \text{ MHz} \\ \hline 1,269 \text{ MHz} \end{array}$



Language Abbreviations

Note: This list of languages was recommended to system operators as the appropriate identifiers for audio, subtitle, and text information. Refer to Language Menu operation.

Language	Abbreviation	Language	Abbreviation
Arabic	ara	Egyptian	egy
Armenian	arm	English	eng
Balinese	ban	Esperanto	epo
Basque	baq	Faroese	fao
Batak	btk	Finnish	fin
Bengali	ben	French	fre
Bhojpuri	bho	German	ger
Bulgarian	bul	Greek	gre
Burmese	bur	Gujarati	guj
Catalan	cat	Hebrew	heb
Chinese	chi	Hindi	hin
Croatian	scr	Hiri Motu	hmo
Cue (Tones)	cue	Hungarian	hun
Czech	cze	Indonesian	ind
Danish	dan	Interlingua	ina
Dutch	dut	Iranian	ira

Language	Abbreviation
Irish	iri
Italian	ita
Panjabi	pan
Japanese	jpn
Javanese	jav
Kashmiri	kas
Korean	kor
Kurdish	kur
Latin	lat
Malay	may
Mandar	mdr
Marathi	mar
Miscellaneous	mis
Mongolian	mon
Nepali	nep
Norwegian	nor
Otomian Lang.	oto
Pahlavi	pal
Persian	per

Language	Abbreviation
Philippine (Other)	phi
Polish	pol
Portuguese	por
Rajasthani	raj
Romanian	rum
Russian	rus
Samoan	smo
Scots	sco
Sindhi	snd
Spanish	spa
Swahili	swa
Swedish	swe
Tagalog	tgl
Tamil	tam
Thai	tha
Urdu	urd
Vietnamese	vie
Welsh	wel



Diagnostics

Introduction

The Fast Fact Diagnostic screens (1 through 5) are a part of the Decoder Firmware created during product development and based on the needs of the particular unit. All values and information shown on the Fast Fact Diagnostic screens update when displayed, unless otherwise noted. Information about these screens is described here for documentation purposes only.

Notes:

- 1. Hexadecimal numbers are displayed with none or more leading zeros (0) to pad to their individual field width.*
- 2. Decimal numbers are right-justified in their individual display rectangle and are not padded with leading zeros (0).*
- 3. Decimal numbers may be displayed with or without a trailing decimal point to distinguish them from hexadecimal numbers. The default is no trailing decimal point.*

Viewing the Fast Fact Diagnostic Screens

The diagnostic screens (Figure 8-1) are available via the On-Screen Display (OSD) video out using a video monitor connected to the OSD Video Out on the rear of the decoder.

To view the OSD diagnostic screens, press the \blacktriangle \blacktriangledown buttons on the front of the decoder until the Diagnostic menu appears, and press the ENTER button to access the Diagnostic menu on the decoder.

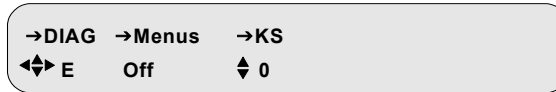

Press the \blacktriangle \blacktriangledown buttons, navigate to the DIAGNOSTIC Menu option, and press the \blacktriangleright button. Selecting ENTER while the cursor is on the Menu option allows access to the OSD diagnostic screens.

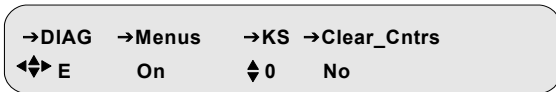

Use the \blacktriangle \blacktriangledown buttons on the front of the decoder to navigate between the Fast Fact Diagnostic screens while displaying the data to the OSD.

Note: Pressing the ENTER button on the front of the decoder while viewing a particular OSD diagnostic screen allows for the continued display of the OSD diagnostic information while allowing the user to navigate thru other front panel menus.

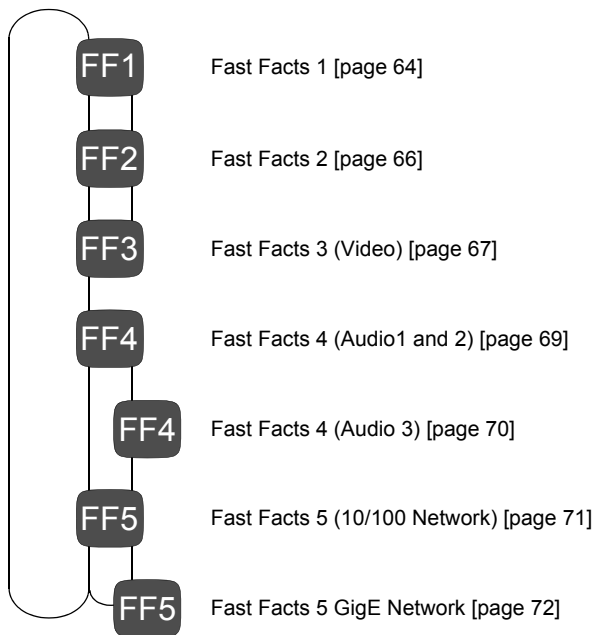

Figure 8-1: Fast Fact Diagnostic Screens

Fast Facts Screens

The Fast Facts screens are used as a method of viewing information and diagnostic data associated with the decoder than what is shown in the decoder's Diagnostic menu screens (refer to Diagnostic Menus).

The Fast Facts screens are composed of five screens: the first screen shows important general information as it relates to the decoder, the second screen shows the current port configuration, the third screen shows important video information, the fourth screen shows important audio information, and the fifth screens shows the Ethernet and GigeE configuration.

Fast Facts 1

The Fast Facts 1 screen displays general information relating to the basic functionality of the decoder.

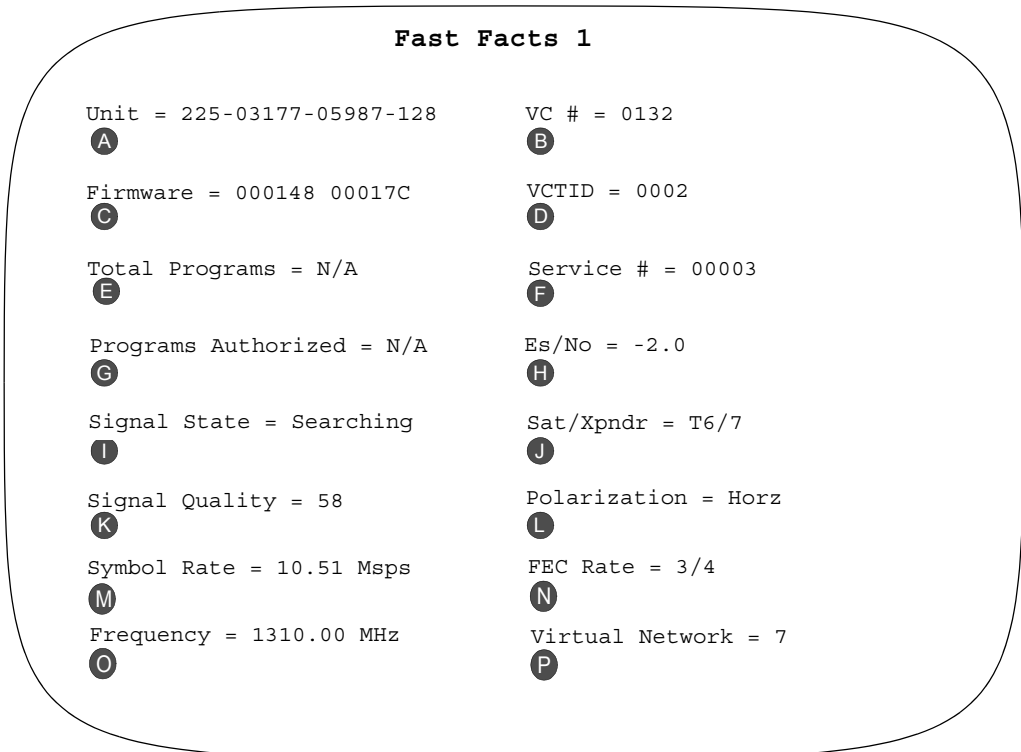

Field	Name	Definition
A	Unit	Displays the 16-digit Unit Address on the screen.
B	VC#	Shows the virtual channel number.
C	Firmware	Shows the firmware version in the boot sector of ROM and the application section.
D	VCT ID	Shows the current VCT ID.
E	Total Programs	Total number of programs on the current transport Service
F	Service	Displays the service number for the current program.
G	Programs Authorized	Total number of programs currently being decrypted
H	Es/No	Shows the Signal to Noise (Es/No) of the signal.
I	Signal State	Shows the received signal state. It can either be Locked or Searching depending on whether the IRD is locked to a signal, or not.

Field	Name	Definition
Ⓝ	Sat/Xpndr	Displays the satellite name and transponder number. If the satellite name is null, then the satellite number is used.
Ⓚ	Signal Strength/ Signal Quality	Puts up the Signal Quality if DCII; else, puts up the Signal Strength. Both values are normalized to be between 0 and 100%.
Ⓛ	Polarization	Shows the polarization for the currently tuned-to transponder, either: Horz Horizontal Vert Vertical
Ⓜ	Symbol Rate	Shows the current symbol rate.
Ⓝ	FEC Rate	Displays the Forward Error correction (FEC) coding rate.
Ⓞ	Frequency	Shows the current RF frequency.
Ⓟ	Virtual Network	Current virtual network that the DSR-6000 is tuned to.

Fast Facts 2

The Fast Facts 2 screen displays information relating to the port configuration of the decoder.

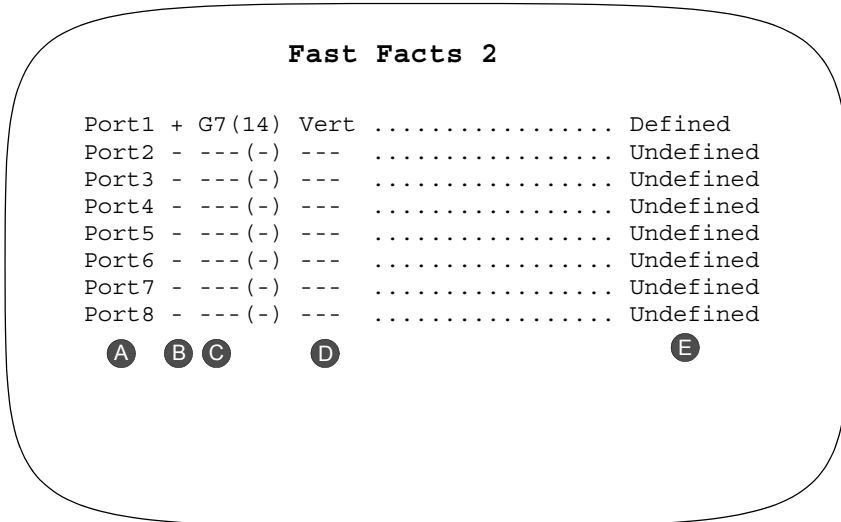

Field	Name	Definition
A	Port number	The port number being described (1 - 8).
B	Active Status	+ Indicates the port is active. - Indicates the port is inactive.
C	Satellite Name	The name of the current satellite.
D	Polarization	The polarity transponder associated with the port, either: Horz Horizontal Vert Vertical
E	Configuration Status	The configuration status of the port, either: Defined, Undefined or Not Supported.

Fast Facts 3

The Fast Facts 3 screen displays information relating to video information.

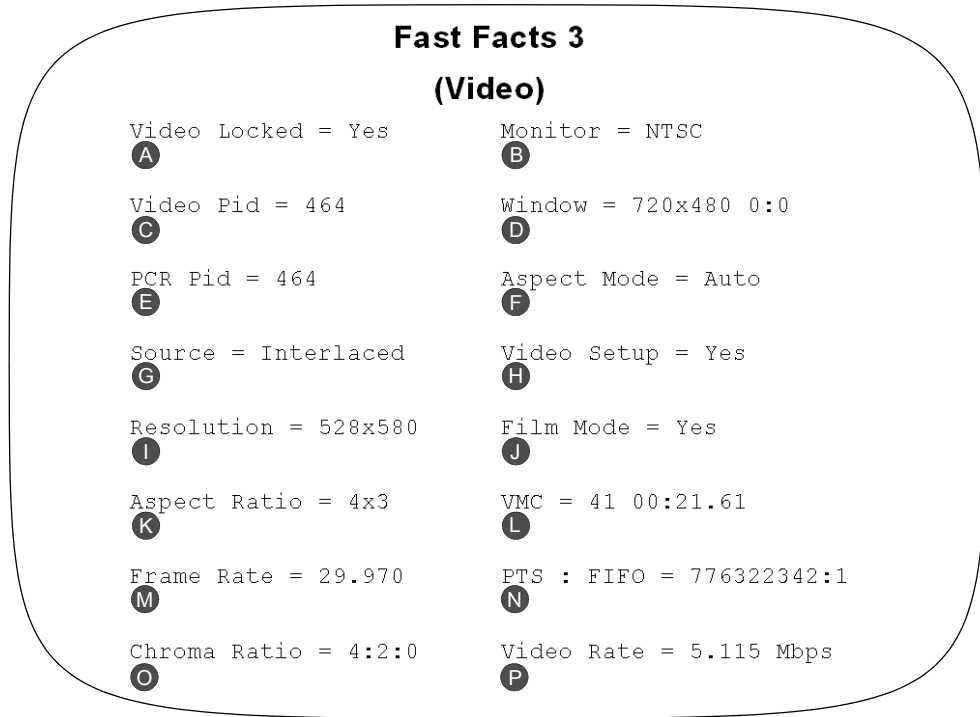

Field	Name	Definition
A	Video Locked	An indication of video lock status, if yes then the video for the decoder is being received and locked. If No is displayed, the video is not being received.
B	Monitor	The current output format of the video display.
C	Video PID	The current Program Identification (PID) number for the Video.
D	Window Dimensions	The current dimensions of the video display: Width x Height, Xpos : Ypos (or mute)
E	PCR Pid	The current Program Clock Reference (PCR) PID.
F	Aspect Mode	The current aspect mode for the incoming video.
G	Source Format	The source format: Interlaced or Progressive.
H	Video Setup	Indication if the video setup (pedestal) is active.

Field	Name	Definition
Ⓡ	Resolution	Displays the Horizontal Size X Vertical Size of the received video.
Ⓝ	Film Mode	Indication of if Film Mode is active or inactive.
Ⓚ	Aspect Ratio	The aspect ratio of the video within the transport stream.
Ⓛ	Video Mute Count (VMC)	The current video mute count.
Ⓜ	Frame Rate	The frame rate code of the stream.
Ⓝ	PTS : FIFO	The video Presentation Time Stamp (PTS) followed by the Picture FIFO Depth Count.
Ⓞ	Chroma Ratio	The Chrominance format for the video within the transport stream.
Ⓟ	Video Rate	The rate (in Mbps) of the video within the transport stream.

Fast Facts 4 (Audio 1 and 2)

The Fast Facts 4 screen displays information relating to audio information. There are two columns of information displayed, one column for the first audio program, and the other column for the second audio program.

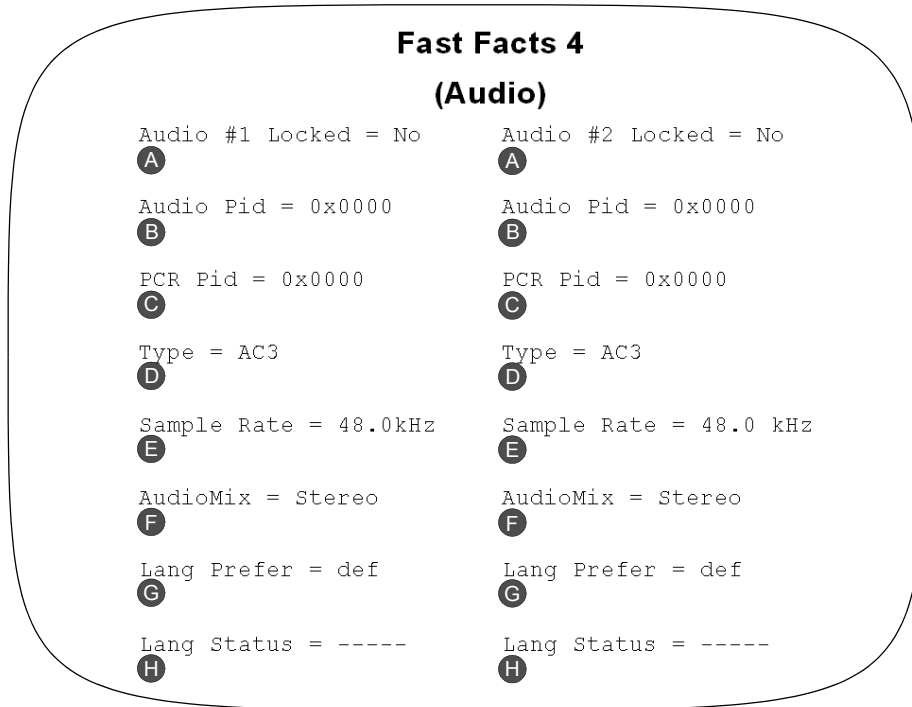

Field	Name	Definition
A	Audio Locked	An indication of audio lock status for both audio programs. If yes, then the audio for the decoder is being received and locked. If No, then the audio is not being received.
B	Audio Pid	The current Audio PID for both audio programs.
C	PCR Pid	The current PCR PID for both audio programs.
D	Type	The audio stream type: MPEG, AAC, AC3, etc.
E	Sample Rate	The sampling rate (in kHz) of both audio programs.
F	Audio Mix	The audio processing mode for both audio programs: Mono, Stereo, Surround, etc.
G	Language Preference	The preferred language setting for both audio programs.
H	Language Status	The language status for both audio programs.

Fast Facts 4 (Audio 3)

The Fast Facts 4 screen displays information relating to audio information. There are two columns of information displayed, one column for the first audio program, and the other column for the second audio program.

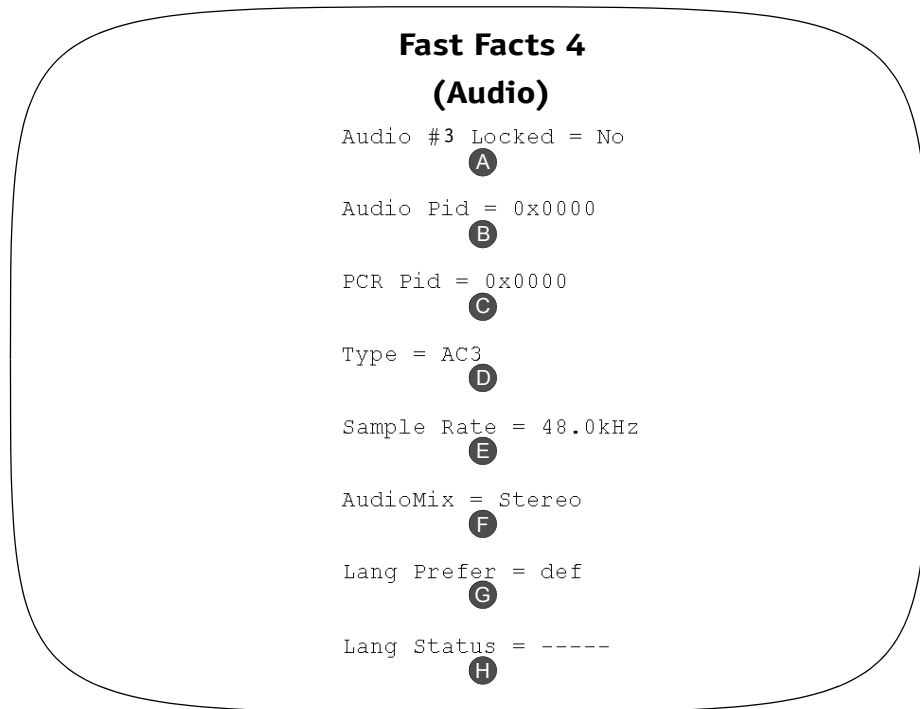

Field	Name	Definition
A	Audio Locked	An indication of audio lock status for both audio programs. If yes, then the audio for the decoder is being received and locked. If No, then the audio is not being received.
B	Audio Pid	The current Audio PID for both audio programs.
C	PCR Pid	The current PCR PID for both audio programs.
D	Type	The audio stream type: MPEG, AAC, AC3, etc.
E	Sample Rate	The sampling rate (in kHz) of both audio programs.
F	Audio Mix	The audio processing mode for both audio programs: Mono, Stereo, Surround, etc.
G	Language Preference	The preferred language setting for both audio programs.
H	Language Status	The language status for both audio programs.

Fast Facts 5 (10/100 Network)

The Fast Facts 5 screen displays information relating to the Ethernet port (left RJ45 port on rear of decoder) configuration.

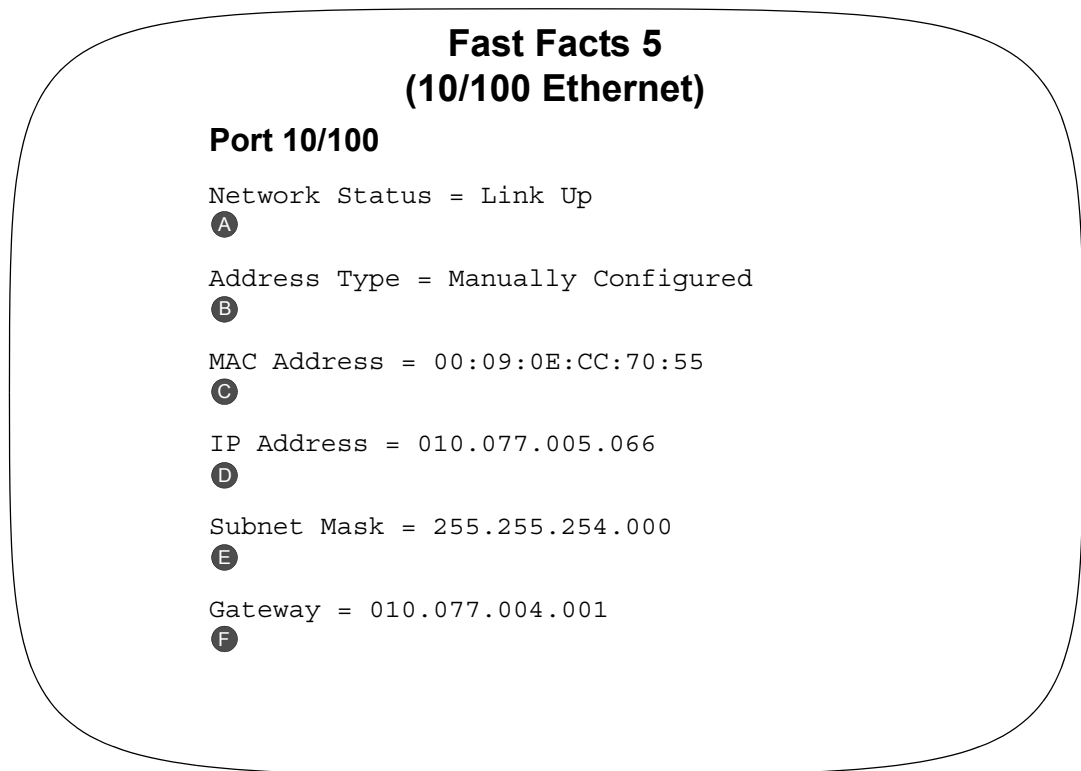

Field	Name	Definition
A	Network Status	Displays connectivity status (either Link Up or Link Down).
B	Address Type	Displays address type.
C	MAC Address	The MAC address of the unit.
D	IP Address	Gives the current IP address of the unit.
E	Subnet Mask	The current subnet mask of the unit.
F	Gateway	The current gateway of the unit.

Fast Facts 5 (Gigabit Ethernet)

The Fast Facts 5 (Gigabit Ethernet) screen displays information relating to Gigabit Ethernet port (right RJ45 port on rear of decoder) configuration.

Fast Facts 5 (GigE Network)

Port GigE

Status = Link Down
A

MAC Address = 00:09:0E:CC:70:55
B

IP Address = 010.077.005.066
C

Subnet Mask = 255.255.254.000
D

Gateway = 010.077.004.001
E

Dest IP Addr = 232.0.1.0
F

Dest Port = 12345
G

Output Mode = MPTS
H

Field	Name	Definition
A	Status	Displays connectivity status (either Link Up or Link Down).
B	MAC Address	MAC Address of the GiGE ethernet.
C	IP Address	IP address of the GiGE ethernet.
D	Subnet Mask	Subnet mask of the GiGE ethernet.
E	Gateway	Gateway of the GiGE ethernet.
F	Dest IP Address	Destination IP address.
G	Dest Port	Destination port.
H	Output Mode	Displays the output mode for the GIGE Ethernet Port.



DSR-6000 Specifications

RF	
Input Frequency Range	950 to 2150 MHz
Input RF Level	-25 to -65 dBm
RF Port Impedance	75 Ohms
RF Port Return Loss	17 dB minimum
Port-to-Port Isolation	40 dB minimum

Transmission Standard	
Transport Symbol Rates	1 to 33 Msps
DVB-S2 FEC Rates	8PSK: 3/5, 2/3, 3/4, 5/6, 8/9, 9/10 QPSK: 1/2, 3/5, 2/3, 3/4, 5/6, 8/9, 9/10

Video	
Video Level	1.0V p-p compliant with RS-250C
Video Output Impedance	75 Ohms
Chrominance-luminance Delay Inequality	± 26 nsec
Differential Gain	4%
Differential Phase	1.5 degrees

Audio	
Three pairs	Six channels
Peak Audio Level	+18 dBm analog (0 dBFS)
Analog Output Level	Adjustable over the range of 0/-18 dB in 1 dB steps
Frequency Response	± 1 dB, 20 Hz to 20 KHz
Total Harmonic Distortion	0.25% at 1 KHz

Connectors	
RF In	F-type (Qty 8)
Video Out	BNC (Qty 1)
OSD Video Out	BNC (Qty 1)
Alarm	Terminal block (Qty 1)
Cue Tone (Labeled: Q+ and Q-)	Terminal block (Qty 1)
Audio Out	Terminal block (Qty 3)
ISOC Data	Terminal block (Qty 1)
ASYNCR	(not implemented)
Contact Closure (Labeled: Relay 1, 2, and 3)	Terminal block (Qty 3)
ASI In	BNC connector (Qty 1)
ASI Out	BNC connector (Qty 2)

Electrical	
Power Requirements	95 to 240 VAC 50/60Hz, 60W

Mechanical		
Dimensions	20.5" x 19" x 1.75" 27" x 22" x 7.5"	(IRD without packaging) (IRD with packaging)
Weight	18 lbs. [8 kg] 12 lbs. [5.5 kg]	(Finished goods with packaging and accessory) (Without packaging)

Caring for the Environment by Recycling

When you see this symbol on a Motorola product, do not dispose of the product with residential or commercial waste.

For full details, see the following link:
www.Motorola.com/recycling

Beskyttelse af miljøet med genbrug

Når du ser dette symbol på et Motorola-produkt, må produktet ikke bortskaffes sammen med husholdningsaffald eller erhvervsaffald.

Umweltschutz durch Recycling

Wenn Sie dieses Zeichen auf einem Produkt von Motorola sehen, entsorgen Sie das Produkt bitte nicht als gewöhnlichen Haus- oder Büromüll.

Cuidar el medio ambiente mediante el reciclaje

Cuando vea este símbolo en un producto Motorola, no lo deseche junto con residuos residenciales o comerciales.

Recyclage pour le respect de l'environnement

Lorsque vous voyez ce symbole sur un produit Motorola, ne le jetez pas avec vos ordures ménagères ou vos rebuts d'entreprise.

Milieubewust recycleren

Als u dit symbool op een Motorola-product ziet, gooi het dan niet bij het huishoudelijk afval of het bedrijfsafval.

Dbałość o środowisko - recykling

Produktów Motorola oznaczonych tym symbolem nie należy wyrzucać do komunalnych pojemników na śmieci.

Cuidando do meio ambiente através da reciclagem

Quando você ver este símbolo em um produto Motorola, não descarte o produto junto com lixo residencial ou comercial.

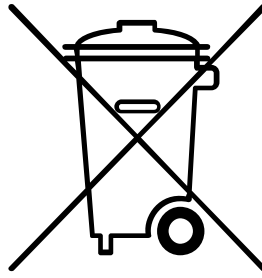

Recycling your Motorola Equipment

Please do not dispose of this product with your residential or commercial waste. Some countries or regions, such as the European Union, have set up systems to collect and recycle electrical and electronic waste items. Contact your local authorities for information about practices established for your region. If collection systems are not available, call Motorola Customer Service for assistance.

Genbrug af dit Motorola-udstyr

Dette produkt må ikke bortskaffes sammen med husholdningsaffald eller erhvervsaffald. Nogle lande eller områder, f.eks. EU, har oprettet systemer til indsamling og genbrug af elektriske og elektroniske affaldsprodukter. Kontakt de lokale myndigheder for oplysninger om gældende fremgangsmåder i dit område. Hvis der ikke findes tilgængelige indsamlingssystemer, kan du kontakte Motorola Kundeservice.

Recycling bei Geräten von Motorola

Bitte entsorgen Sie dieses Produkt nicht als gewöhnlichen Haus- oder Büromüll. In einigen Ländern und Gebieten, z. B. in der Europäischen Union, wurden Systeme für die Rücknahme und Wiederverwertung von Elektroschrott eingeführt. Erkundigen Sie sich bitte bei Ihrer Stadt- oder Kreisverwaltung nach der geltenden Entsorgungspraxis. Falls bei Ihnen noch kein Abfuhr- oder Rücknahmesystem besteht, wenden Sie sich bitte an den Kundendienst von Motorola.

Reciclaje de su equipo Motorola

No deseche este producto junto con sus residuos residenciales o comerciales. Algunos países o regiones, tales como la Unión Europea, han organizado sistemas para recoger y reciclar desechos eléctricos y electrónicos. Comuníquese con las autoridades locales para obtener información acerca de las prácticas vigentes en su región. Si no existen sistemas de recolección disponibles, solicite asistencia llamando al Servicio al Cliente de Motorola.

Recyclage de votre équipement Motorola

Veillez ne pas jeter ce produit avec vos ordures ménagères ou vos rebuts d'entreprise. Certains pays ou certaines régions comme l'Union Européenne ont mis en place des systèmes de collecte et de recyclage des produits électriques et électroniques mis au rebut. Veuillez contacter vos autorités locales pour vous informer des pratiques instaurées dans votre région. Si aucun système de collecte n'est disponible, veuillez appeler le Service clientèle de Motorola qui vous apportera son assistance.

Uw Motorola-materiaal recycleren.

Gooi dit product niet bij het huishoudelijk afval het of bedrijfsafval. In sommige landen of regio's zoals de Europese Unie, zijn er bepaalde systemen om elektrische of elektronische afvalproducten in te zamelen en te recycleren. Neem contact op met de plaatselijke overheid voor informatie over de geldende regels in uw regio. Indien er geen systemen bestaan, neemt u contact op met de klantendienst van Motorola.

Recykling posiadanego sprzętu Motorola

Produktu nie należy wyrzucać do komunalnych pojemników na śmieci. W niektórych krajach i regionach, np. w Unii Europejskiej, istnieją systemy zbierania i recyklingu sprzętu elektrycznego i elektronicznego. Informacje o utylizacji tego rodzaju odpadów należy uzyskać od władz lokalnych. Jeśli w danym regionie nie istnieją systemy zbierania odpadów elektrycznych i elektronicznych, informacje o utylizacji należy uzyskać od biura obsługi klienta firmy Motorola (Motorola Customer Service).

Reciclagem do seu equipamento Motorola

Não descarte este produto junto com o lixo residencial ou comercial. Alguns países ou regiões, tais como a União Européia, criaram sistemas para coletar e reciclar produtos eletro-eletrônicos. Para obter informações sobre as práticas estabelecidas para sua região, entre em contato com as autoridades locais. Se não houver sistemas de coleta disponíveis, entre em contato com o Serviço ao Cliente da Motorola para obter assistência.

Var rädd om miljön genom återvinning

När du ser den här symbolen på en av Motorolas produkter ska du inte kasta produkten tillsammans med det vanliga avfallet.

リサイクルによる環境保護

モトローラ製品にこの記号が表示されている場合、製品を家庭または商業廃棄物として処分しないでください。

재활용으로 환경 보호하기

Motorola 제품에 이 표시가 있는 경우, 해당제품을 가정용 또는 상업용 폐기물과 함께 버리지 마십시오.

重复利用，保护环境

如果 Motorola 产品上具有这个标识，请勿将产品丢弃到家庭或商业垃圾中。

注意環保問題

在你看到產品上有Motorola的標誌時，請勿以住家或商用的廢棄物方式處置。

Återvinning av din Motorola-utrustning

Kasta inte denna produkt tillsammans med det vanliga avfallet. Vissa länder eller regioner, som t.ex. EU, har satt upp ett system för insamling och återvinning av el- och elektronikavfall. Kontakta dina lokala myndigheter för information om vilka regler som gäller i din region. Om det inte finns något insamlingsystem ska du kontakta Motorolas kundtjänst för hjälp.

モトローラ装置のリサイクル

本製品を家庭または商業廃棄物として処分しないでください。欧州連合などの国または地域によっては、電氣的・電子的廢棄物を収集およびリサイクルするシステムがあります。お住まいの地域で決められている方法についての情報は、地方自治体にお問い合わせください。収集システムがない場合、モトローラ・カスタマーサービスまでお問い合わせください。

Motorola 기기의 재활용

이 제품을 가정용 또는 사업용 폐기물과 함께 버리지 마십시오. 유럽연합과 같은 일부 국가 또는 지역에서는 전기 및 전자 폐기물 용품을 수집하여 재활용하는 시스템이 구축되어 있습니다. 해당 지역에 구축되어 있는 절차에 관한 정보는 지역 관할당국에 연락하십시오. 수집 시스템이 존재하지 않는 경우, 도움을 받기 위해 Motorola 고객센터부로 연락하십시오.

Motorola 设备的重复利用

请勿将本产品丢弃到家庭或商业垃圾中。某些国家或地区，例如欧盟，已经建立起回收和重复利用电气与电子废弃物的体系。请与当地相关机构联系，获取有关所在地区相关规定的信息。如果当地尚未建立回收体系，请致电 Motorola 客户服务以寻求帮助。

Motorola 設備的回收

請勿以住家或商用的廢棄物方式處置。某些國家或地區，如歐盟，已對廢棄的電器和電子產品制訂回收以及再利用體制。請與您所在地的管理機構諮詢相關規定。若您所在的地區並未設置回收機制，請電Motorola客服部諮詢相關事宜。



6450 Sequence Dr.
San Diego, CA 92121
Document No: 557526-001, Rev. A

Free Manuals Download Website

<http://myh66.com>

<http://usermanuals.us>

<http://www.somanuals.com>

<http://www.4manuals.cc>

<http://www.manual-lib.com>

<http://www.404manual.com>

<http://www.luxmanual.com>

<http://aubethermostatmanual.com>

Golf course search by state

<http://golfingnear.com>

Email search by domain

<http://emailbydomain.com>

Auto manuals search

<http://auto.somanuals.com>

TV manuals search

<http://tv.somanuals.com>