



KIRBY'S DREAM COLLECTION SPECIAL EDITION

INSTRUCTION BOOKLET

**NEED HELP WITH INSTALLATION,
MAINTENANCE OR SERVICE?**

Nintendo Customer Service
SUPPORT.NINTENDO.COM
or call 1-800-255-3700

NEED HELP PLAYING A GAME?

For game play assistance, we recommend using your favorite Internet search engine to find tips for the game you are playing. Some helpful words to include in the search, along with the game's title, are: "walk through," "FAQ," "codes," and "tips."

**BESOIN D'AIDE POUR L'INSTALLATION,
L'ENTRETIEN OU LA RÉPARATION?**

Service à la clientèle de Nintendo
SUPPORT.NINTENDO.COM
ou composez le 1 800 255-3700

BESOIN D'AIDE DANS UN JEU?

Nous vous suggérons d'utiliser votre moteur de recherche préféré pour trouver des astuces sur Internet. Essayez quelques-uns de ces mots clés dans votre recherche : « solution complète », « FAQ », « codes », « trucs » et « astuces ».

**¿NECITAS AYUDA DE INSTALACIÓN,
MANTENIMIENTO O SERVICIO?**

Servicio al Cliente de Nintendo
SUPPORT.NINTENDO.COM
o llama al 1-800-255-3700

¿NECITAS AYUDA CON UN JUEGO?

Si necesitas ayuda para avanzar en los juegos, te recomendamos que uses el motor de búsqueda que prefieras para encontrar consejos para el juego. Algunas de las palabras que te ayudarán en tu búsqueda, además del título, son "instrucciones paso a paso", "preguntas frecuentes", "códigos" y "consejos".



Product recycling information:
visit recycle.nintendo.com

Information sur le recyclage des produits :
Visitez : recycle.nintendo.com

Información sobre reciclaje de productos:
Visita recycle.nintendo.com



The Official Seal is your assurance that this product is licensed or manufactured by Nintendo. Always look for this seal when buying video game systems, accessories, games and related products.

Ce sceau officiel est votre garantie que le présent produit est agréé ou manufacturé par Nintendo. Cherchez-le toujours sur les boîtes lorsque vous achetez des consoles de jeux vidéo, des accessoires, des jeux et d'autres produits apparentés.

El sello oficial es tu ratificación de que este producto está autorizado o ha sido fabricado por Nintendo. Busca siempre este sello al comprar sistemas de videojuegos, accesorios, juegos y otros productos relacionados.

Nintendo®

NINTENDO OF AMERICA INC.
P.O. BOX 957, REDMOND, WA
98073-0957 U.S.A.

77350A



PLEASE CAREFULLY READ THE Wii™ OPERATIONS MANUAL COMPLETELY BEFORE USING YOUR Wii HARDWARE SYSTEM, GAME DISC OR ACCESSORY. THIS MANUAL CONTAINS IMPORTANT HEALTH AND SAFETY INFORMATION.

IMPORTANT SAFETY INFORMATION: READ THE FOLLOWING WARNINGS BEFORE YOU OR YOUR CHILD PLAY VIDEO GAMES.

⚠ WARNING - Seizures

- Some people (about 1 in 4000) may have seizures or blackouts triggered by light flashes or patterns, and this may occur while they are watching TV or playing video games, even if they have never had a seizure before.
- Anyone who has had a seizure, loss of awareness, or other symptom linked to an epileptic condition should consult a doctor before playing a video game.
- Parents should watch their children play video games. Stop playing and consult a doctor if you or your child has any of the following symptoms:

Convulsions	Eye or muscle twitching	Altered vision
Loss of awareness	Involuntary movements	Disorientation

- To reduce the likelihood of a seizure when playing video games:
 1. Sit or stand as far from the screen as possible.
 2. Play video games on the smallest available television screen.
 3. Do not play if you are tired or need sleep.
 4. Play in a well-lit room.
 5. Take a 10 to 15 minute break every hour.

⚠ WARNING - Repetitive Motion Injuries and Eyestrain

Playing video games can make your muscles, joints, skin or eyes hurt. Follow these instructions to avoid problems such as tendinitis, carpal tunnel syndrome, skin irritation or eyestrain:

- Avoid excessive play. Parents should monitor their children for appropriate play.
- Take a 10 to 15 minute break every hour, even if you don't think you need it.
- If your hands, wrists, arms or eyes become tired or sore while playing, or if you feel symptoms such as tingling, numbness, burning or stiffness, stop and rest for several hours before playing again.
- If you continue to have any of the above symptoms or other discomfort during or after play, stop playing and see a doctor.

⚠ CAUTION - Motion Sickness

Playing video games can cause motion sickness in some players. If you or your child feel dizzy or nauseous when playing video games, stop playing and rest. Do not drive or engage in other demanding activity until you feel better.

IMPORTANT LEGAL INFORMATION

This Nintendo game is not designed for use with any unauthorized device. Use of any such device will invalidate your Nintendo product warranty. Copying of any Nintendo game is illegal and is strictly prohibited by domestic and international intellectual property laws. "Back-up" or "archival" copies are not authorized and are not necessary to protect your software. Violators will be prosecuted.

WARRANTY & SERVICE INFORMATION

You may need only simple instructions to correct a problem with your product. Try our website at support.nintendo.com or call our Consumer Assistance Hotline at 1-800-255-3700, rather than going to your retailer. Hours of operation are 6 a.m. to 7 p.m., Pacific Time, Monday - Sunday (times subject to change). If the problem cannot be solved with the troubleshooting information available online or over the telephone, you will be offered express factory service through Nintendo. Please do not send any products to Nintendo without contacting us first.

HARDWARE WARRANTY

Nintendo of America Inc. ("Nintendo") warrants to the original purchaser that the hardware product shall be free from defects in material and workmanship for twelve (12) months from the date of purchase. If a defect covered by this warranty occurs during this warranty period, Nintendo will repair or replace the defective hardware product or component, free of charge.* The original purchaser is entitled to this warranty only if the date of purchase is registered at point of sale or the consumer can demonstrate, to Nintendo's satisfaction, that the product was purchased within the last 12 months.

GAME & ACCESSORY WARRANTY

Nintendo warrants to the original purchaser that the product (games and accessories) shall be free from defects in material and workmanship for a period of three (3) months from the date of purchase. If a defect covered by this warranty occurs during this three (3) month warranty period, Nintendo will repair or replace the defective product, free of charge.*

SERVICE AFTER EXPIRATION OF WARRANTY

Please try our website at support.nintendo.com or call the Consumer Assistance Hotline at 1-800-255-3700 for troubleshooting information and repair or replacement options and pricing.*

*In some instances, it may be necessary for you to ship the complete product, FREIGHT PREPAID AND INSURED FOR LOSS OR DAMAGE, to Nintendo. Please do not send any products to Nintendo without contacting us first.

WARRANTY LIMITATIONS

THIS WARRANTY SHALL NOT APPLY IF THIS PRODUCT: (a) IS USED WITH PRODUCTS NOT SOLD OR LICENSED BY NINTENDO (INCLUDING, BUT NOT LIMITED TO, NON-LICENSED GAME ENHANCEMENT AND COPIER DEVICES, ADAPTERS, SOFTWARE, AND POWER SUPPLIES); (b) IS USED FOR COMMERCIAL PURPOSES (INCLUDING RENTAL); (c) IS MODIFIED OR TAMPERED WITH; (d) IS DAMAGED BY NEGLIGENCE, ACCIDENT, UNREASONABLE USE, OR BY OTHER CAUSES UNRELATED TO DEFECTIVE MATERIALS OR WORKMANSHIP; OR (e) HAS HAD THE SERIAL NUMBER ALTERED, DEFACED OR REMOVED.

ANY APPLICABLE IMPLIED WARRANTIES, INCLUDING WARRANTIES OF MERCHANTABILITY AND FITNESS FOR A PARTICULAR PURPOSE, ARE HEREBY LIMITED IN DURATION TO THE WARRANTY PERIODS DESCRIBED ABOVE (12 MONTHS OR 3 MONTHS, AS APPLICABLE). IN NO EVENT SHALL NINTENDO BE LIABLE FOR CONSEQUENTIAL OR INCIDENTAL DAMAGES RESULTING FROM THE BREACH OF ANY IMPLIED OR EXPRESS WARRANTIES. SOME STATES DO NOT ALLOW LIMITATIONS ON HOW LONG AN IMPLIED WARRANTY LASTS OR EXCLUSION OF CONSEQUENTIAL OR INCIDENTAL DAMAGES, SO THE ABOVE LIMITATIONS MAY NOT APPLY TO YOU.

This warranty gives you specific legal rights. You may also have other rights which vary from state to state or province to province.

Nintendo's address is: Nintendo of America Inc., P.O. Box 957, Redmond, WA 98073-0957 U.S.A.

This warranty is only valid in the United States and Canada.

©1992-2012 HAL Laboratory, Inc. / Nintendo.™, ® and the Wii logo are trademarks of Nintendo. © 2012 Nintendo.

Powered by 

⚠ CAUTION: WRIST STRAP USE

Please use the wrist strap to help prevent injury to other people or damage to surrounding objects or the Wii Remote in case you accidentally let go of the Wii Remote during gameplay.

Also remember the following:

- Make sure all players put on the wrist strap properly when it is their turn.
- Do not let go of the Wii Remote during gameplay.
- Dry your hands if they become moist.
- Allow adequate room around you during gameplay and make sure that all areas you might move into are clear of other people and objects.
- Stay at least three feet from the television.
- Use the Wii Remote Jacket.

SYSTEM MENU UPDATE

Please note that when first loading the Game Disc into the Wii console, the system will check if you have the latest version of the system menu, and if necessary, a Wii System Update Confirmation screen will appear. Select OK to proceed with the update. Please note that the Wii console must have the latest version of the Wii system menu in order to play the Game Disc.

When the system menu is updated, unauthorized hardware and/or software modifications may be detected and unauthorized content may be removed causing the immediate or delayed inoperability of your console. Failure to accept the update may render this game, and future games, unplayable. Please note that Nintendo cannot guarantee that unauthorized software or accessories will continue to function with the Wii console after this or future updates of the Wii system menu.



Starting the Game



1. Insert the Kirby's Dream Collection Special Edition Game Disc into the Wii console's disc slot, point at the Disc Channel, and press **A**.
*If the game title is not displayed, a Wii system menu update is needed.
2. When the Channel Preview screen is displayed, point at Start and press **A**.
3. The title screen will be displayed. Press **2** to go to the mode-selection screen.



Channel Preview Screen



How to Play



Select a mode to play from the following.

New Challenge Stages	In this mode, control Kirby as you set high scores with a single Copy Ability and attempt to reach the goal. Each level has multiple stages to clear before you can advance!
Classic Titles	Enjoy the following six classic Kirby titles, just as they appeared when released.      
Kirby's History	Follow the footsteps of the Kirby series year by year. You can view the gameplay videos and packages for all titles, as well as anime TV episodes.

For Wii Remote™ controls, please see pages 7-22. For details on the controls for each game of Classic Titles, please read the electronic manual. Electronic manuals can be accessed from the HOME Menu after selecting the game.

★ ★ Saving and Suspend Feature ★ ★

In the New Challenge Stages, your game is saved automatically as you clear each stage. In all Classic Titles games, your game progress is saved either with Suspend Points or the game's save function. In The Great Cave Offensive, one of the Kirby Super Star game modes, you need to save the game progress at one of the save points.

Note: Saving will require 31 open blocks in the Wii system memory.

Note: The save data for New Challenge Stages and Classic Titles can be erased individually. The erased data cannot be recovered, so please be careful.

Note: For more information on how to delete files from your Wii system memory or copy files to an SD Card, please see the Wii Settings and Data Management section of your Wii Operations Manual.

When you quit the game in Classic Titles, a Suspend Point is created and the game will continue from that point the next time you play. The Suspend Point will be deleted once the game has restarted.

Note: Kirby's Dream Land only has the suspend function and does not have the save function.

Note: Kirby 64: The Crystal Shards only has the save function and does not have the suspend function.

★ ★ Frame ★ ★

When you are playing Kirby's Dream Collection Special Edition with the screen aspect ratio set to 16:9, frames will be displayed around the game screen. You can remove these frames by holding down \oplus and \ominus at the same time on the Wii Remote or Classic Controller™.



Frame

Note: When playing Kirby's Dream Land and Kirby's Dream Land 2, frames will be displayed even in the 4:3 aspect ratio.

Return to the Title Screen

You can go back to the mode-selection screen by selecting Reset on the HOME Menu or by pressing the RESET Button on the Wii console. When playing a Classic Titles game, simultaneously hold down $\textcircled{1}$ + $\textcircled{2}$ + \textcircled{A} + \textcircled{B} on the Wii Remote or \textcircled{a} + \textcircled{b} + \textcircled{L} + \textcircled{R} on the Classic Controller to return to the title screen of the game you are playing.

★ ★ Controls for New Challenge Stages ★ ★

For the Wii Remote controls, please see pages 19-20.

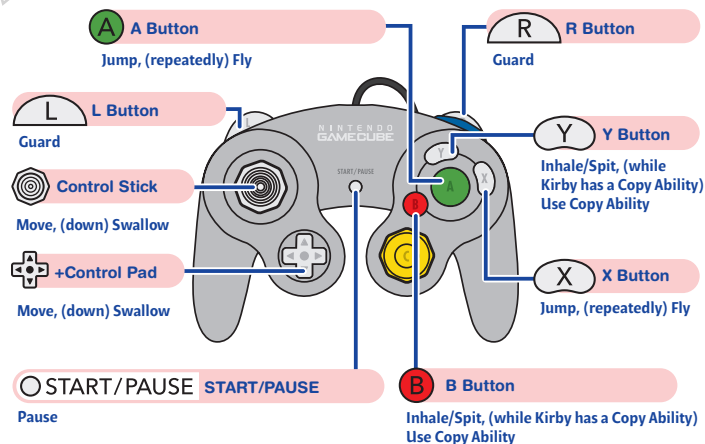
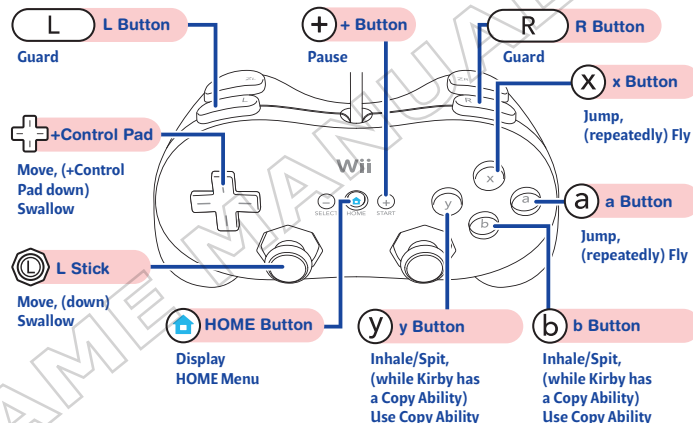

New Challenge Stages support the rumble feature of the GameCube Controller.

KIRBY'S DREAM LAND

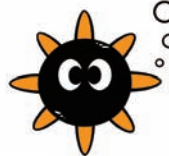

Basic Actions



MOVE



Hover



Duck

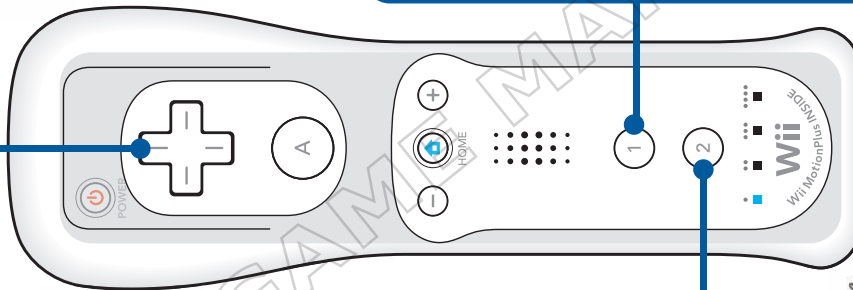

1

INHALE

After inhaling: Swallow
① Spit

In midair: Shoot air

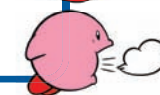
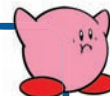

START GAME
PAUSE

2

JUMP



Inhale an Enemy and Spit It Out to Attack Another!

Press ① near an enemy to inhale it into your mouth.



After inhaling, press ① again to spit out a star-shaped bullet.



Items That Will Help on Your Adventure



Invincible Candy

It turns Kirby invincible for a certain time.



Pep Brew

It recovers Kirby's health by two bars.



Maxim Tomato

It fully recovers Kirby's health.



1-Up

It increases the number of remaining Kirbys by one.



Microphone

It deals damage to all enemies on the screen.

There are more items available.

Return to the main menu

On the HOME Menu, select Reset to go back to Kirby's Dream Collection.

Return to the title screen

Hold down **A** + **B** + **1** + **2** simultaneously to return to the title screen without creating a Suspend Point.

KIRBY'S ADVENTURE



MOVE (press twice to dash)



Duck



Hover



+ ① / ② Slide

1

INHALE

After inhaling:



Swallow

①

Spit

USE COPY ABILITY



Basic Actions

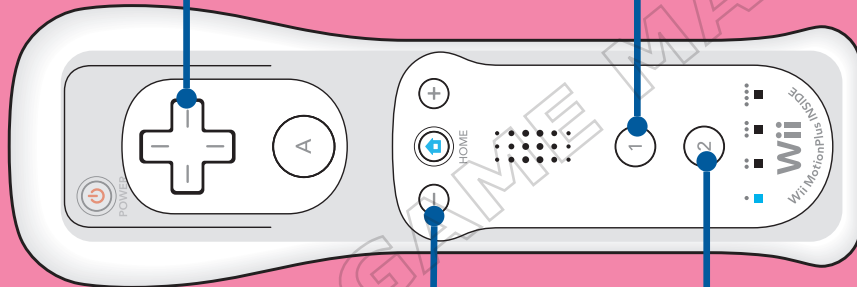

-

DISCARD COPY ABILITY

+

START GAME PAUSE

2

JUMP

Acquire Copy Abilities

Kirby can inhale certain enemies and copy their abilities.

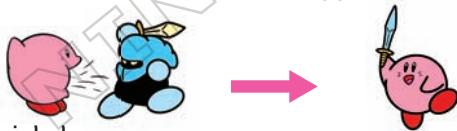

Press ① to inhale an enemy, and press + to swallow it!

Kirby gets the enemy's ability!

Various Abilities

There are many types of abilities Kirby can copy. Try them all out by swallowing different enemies.



Beam



Microphone



Ice

Return to the main menu

On the HOME Menu, select Reset to go back to Kirby's Dream Collection.

Return to the title screen

Hold down A + B + ① + ② simultaneously to return to the title screen without creating a Suspend Point.

KIRBY'S DREAM LAND 2

Basic Actions

+ MOVE

- + Hover
- + Duck



1 INHALE

After inhaling:

- + Swallow
- ① Spit

USE COPY ABILITY

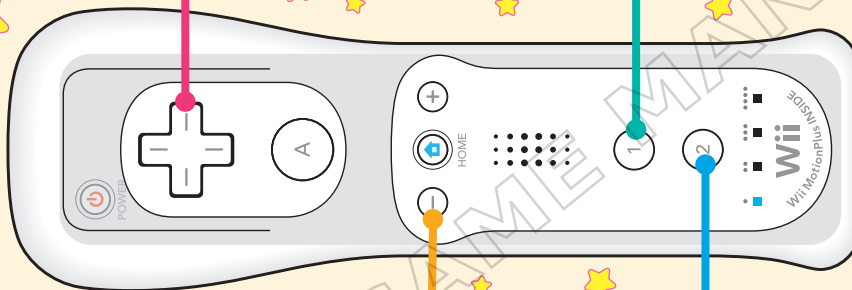
- DISCARD COPY ABILITY

PART WITH FRIEND



+ START GAME

PAUSE

2 JUMP



Three Friends You Can Depend On: ★★★★★



★★★★ **Rick** ★★★★★
A stable pal who doesn't lose control on ice.



★★★★ **Kine** ★★★★★
A master swimmer who can move around in the strongest currents.



★★★★ **Coo** ★★★★★
The free bird who can fly against mighty winds.

Friends and Copy Abilities ★★★★★



Press ⊖.



Detach from the friend.

Try all of the combinations!

Swallow an enemy.



The Copy Ability will change depending on the friend!

Press ⊖.



Only the Copy Ability is discarded.

Return to the main menu

On the HOME Menu, select Reset to go back to Kirby's Dream Collection.

Return to the title screen

Hold down **A** + **B** + **1** + **2** simultaneously to return to the title screen without creating a Suspend Point.



Basic Actions

+ MOVE (press twice to dash)

- +** Duck
- +** Open treasure box
- +** + ② Slide



1 INHALE

After inhaling:

- +** Swallow
- 1** Spit

USE COPY ABILITY



B GUARD



A WHEN USING A COPY ABILITY:
Bring out Helper Normal Beam

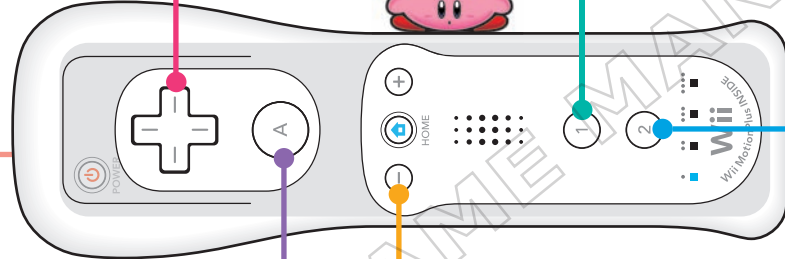



+ START GAME PAUSE

- CHECK TREASURE
(The Great Cave Offensive)

EASY SELECT
(Milky Way Wishes)

2 JUMP FLY
(press repeatedly)



★ Together With a Helper! ★

While Kirby has a Copy Ability, press **A** to bring out a Helper.

When Kirby has an ability, press **A** to...

Make a Helper appear!

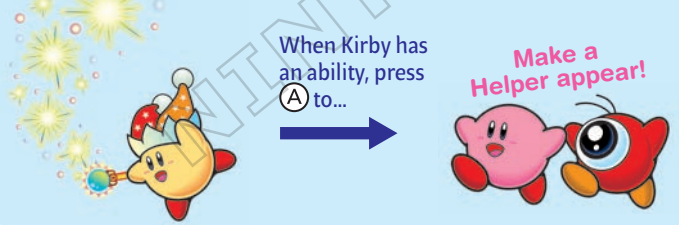

★ Play Together With Another Player! ★

If you press any button on a second controller, Player 2 can control the Helper.

Infinite Jump
Press **2** multiple times to float in the air.

Use Copy Ability
Press **1** to allow a Helper and Kirby to share a Copy Ability.

Press **A** multiple times to release the Helper.



Return to the main menu On the HOME Menu, select Reset to go back to Kirby's Dream Collection.

Return to the title screen Hold down **A** + **B** + **1** + **2** simultaneously to return to the title screen without creating a Suspend Point.

KIRBY'S DREAM LAND 3

Basic Actions

+ MOVE (press twice to dash)
+ Duck
+ + **2** Slide

1 INHALE
 After inhaling:
+ Swallow
1 Spit

USE COPY ABILITY

B TEAM UP WITH FRIEND
 DETACH

A CALL UP GOOEY

+ START GAME
 PAUSE

- DISCARD COPY ABILITY

2 JUMP
 FLY (press repeatedly)

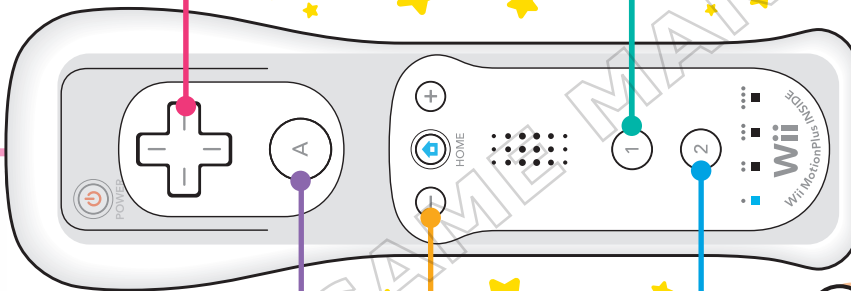

Take Goopy Along on Your Adventure!

Press **A** to bring out Goopy.

If you press **A** on a second controller, Player 2 will be able to control Goopy.

★ In one-player mode: press **A** to bring out Goopy.

★ For two-player mode: press **A** on a second controller to enable Player 2 to control Goopy.



You can release Goopy by pressing **A** multiple times (in two-player mode, press **A** on Controller 2).

Goopy can also use Copy Abilities... and team up with a friend!



Team Up With a Friend!

Rick

Can move on ice without slipping.



Kine

Can swim against the strongest currents.



Coo

Can fly against strong winds.



Nago

Can perform a triple jump.



Pitch

Can do surprising attacks using Copy Abilities.



ChuChu

Can attach to and move along the ceiling.



Return to the main menu

On the HOME Menu, select Reset to go back to Kirby's Dream Collection.

Return to the title screen

Hold down **A** + **B** + **1** + **2** simultaneously to return to the title screen without creating a Suspend Point.

KIRBY™

The Crystal Shards

A DISCARD COPY ABILITY
 After inhaling, lift up
 After lifting, throw upward

1 INHALE
 After inhaling:
 + Swallow
 ① Spit

USE COPY ABILITY
 After lifting,
 throws object

Basic Actions

+ MOVE
 (press twice to dash)

- + Duck
- + ② Slide

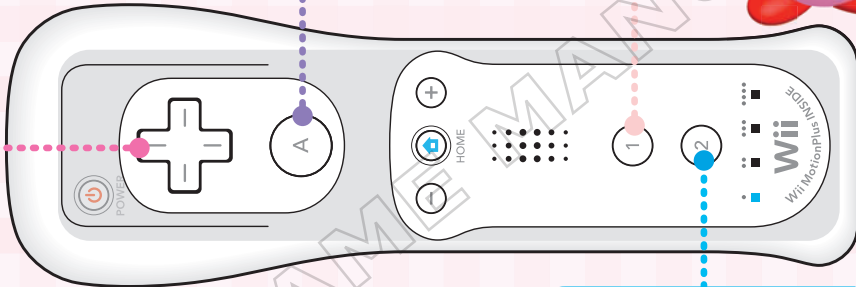

**+ Start game
 Pause**

**2 JUMP
 FLY (press repeatedly)**

Mixing Copy Abilities!

If you mix two Copy Abilities at the same time, the Copy Abilities will change according to the combination. There are three different mixing methods.

Method 1
 Swallow two enemies with abilities at the same time.

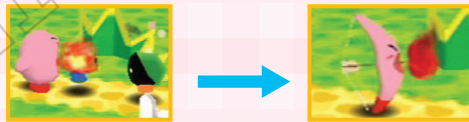

If you inhale two enemies and swallow them...the Copy Abilities are mixed!

Method 2
 Throw an ability enemy at another ability enemy.



Lift up or inhale an ability enemy and throw or spit it at another ability enemy.



Swallow the resulting Ability Star.

Method 3
 Throw an Ability Star at an ability enemy.



Throw an Ability Star at an ability enemy.



Swallow the resulting Ability Star.

Return to the main menu

On the HOME Menu, select Reset to go back to Kirby's Dream Collection.

Return to the title screen

Hold down **A** + **B** + **1** + **2** simultaneously to return to the title screen.





Basic Actions

A GUARD 

1 INHALE 
 After inhaling:
 + Swallow
 ① Spit

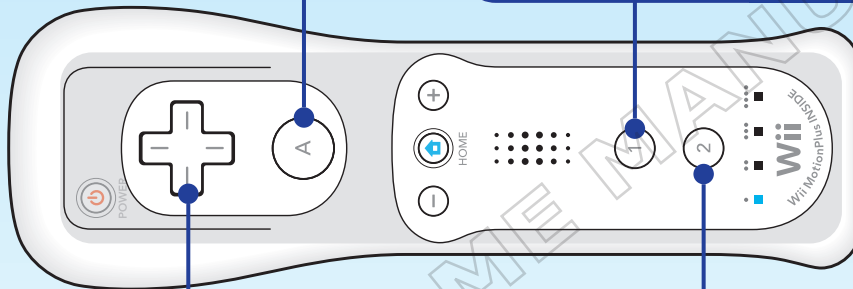
USE COPY ABILITY 



+ MOVE (press twice to dash) 
 + Duck
 + + ② Slide

+ START GAME PAUSE

2 JUMP 
FLY (press repeatedly)

★ Increase Your Score by Collecting Coins and Defeating Enemies!

★ Master the Copy Abilities

When you collect coins and defeat enemies, you earn points. However, you will lose points as well as health each time you are hit.

You can practice your Copy Abilities in the Training Room. You can also view the ability guide from the pause menu.

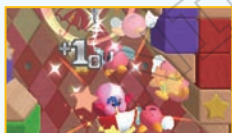

Defeat enemies, and travel quickly with the right moves!

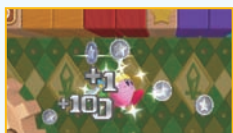

Time your jumps to collect all the coins!



Check out how to use moves.



Select the Copy Ability and practice, practice, practice!

Return to the main menu

On the HOME Menu, select Reset to go back to Kirby's Dream Collection.



Control Overview



SELECT HISTORY

Rotate the game packages



1

CLOSE

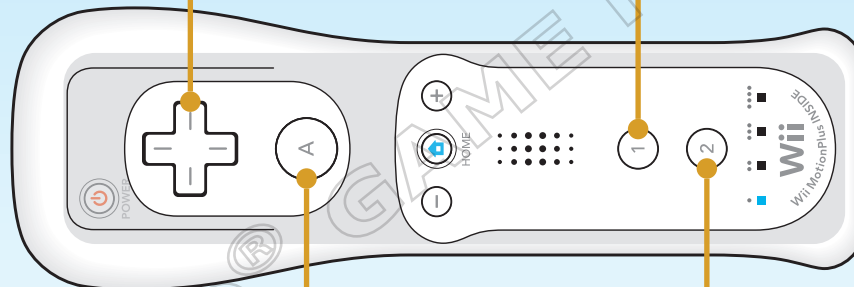

A

SHOW FRONT IMAGE OF A GAME PACKAGE



2

CONFIRM

While viewing game package, zoom in/out



Preview the Kirby Anime

You can watch three of the 100 episodes of the TV series *Kirby: Right Back at Ya!*



Look for the TV anime in 2002.



Select the episode you want to watch.

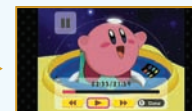

You can rewind or fast-forward.

Free Manuals Download Website

<http://myh66.com>

<http://usermanuals.us>

<http://www.somanuals.com>

<http://www.4manuals.cc>

<http://www.manual-lib.com>

<http://www.404manual.com>

<http://www.luxmanual.com>

<http://aubethermostatmanual.com>

Golf course search by state

<http://golfingnear.com>

Email search by domain

<http://emailbydomain.com>

Auto manuals search

<http://auto.somanuals.com>

TV manuals search

<http://tv.somanuals.com>