

Digital Surround System

HTX-22HDX

Instruction Manual

Thank you for purchasing this Onkyo product. Please read this manual thoroughly before making any connections or plugging in your new Onkyo product. Following the instructions in this manual will enable you to obtain optimum performance and listening enjoyment from your new Onkyo product. Please retain this manual for future reference.

Contents

Introduction.....	2
Connections.....	14
Turning On	27
Playing Your AV Components	28
Using the Listening Modes.....	32
Setup.....	37
Troubleshooting.....	46
HDMI	49
Specifications	51
Using RHD	53

WARNING:

TO REDUCE THE RISK OF FIRE OR ELECTRIC SHOCK, DO NOT EXPOSE THIS APPARATUS TO RAIN OR MOISTURE.

CAUTION:

TO REDUCE THE RISK OF ELECTRIC SHOCK, DO NOT REMOVE COVER (OR BACK). NO USER-SERVICEABLE PARTS INSIDE. REFER SERVICING TO QUALIFIED SERVICE PERSONNEL.



WARNING
RISK OF ELECTRIC SHOCK
DO NOT OPEN

AVIS
RISQUE DE CHOC ELECTRIQUE
NE PAS OUVRIR



The lightning flash with arrowhead symbol, within an equilateral triangle, is intended to alert the user to the presence of uninsulated “dangerous voltage” within the product’s enclosure that may be of sufficient magnitude to constitute a risk of electric shock to persons.



The exclamation point within an equilateral triangle is intended to alert the user to the presence of important operating and maintenance (servicing) instructions in the literature accompanying the appliance.

Important Safety Instructions

1. Read these instructions.
2. Keep these instructions.
3. Heed all warnings.
4. Follow all instructions.
5. Do not use this apparatus near water.
6. Clean only with dry cloth.
7. Do not block any ventilation openings. Install in accordance with the manufacturer’s instructions.
8. Do not install near any heat sources such as radiators, heat registers, stoves, or other apparatus (including amplifiers) that produce heat.
9. Do not defeat the safety purpose of the polarized or grounding-type plug. A polarized plug has two blades with one wider than the other. A grounding type plug has two blades and a third grounding prong. The wide blade or the third prong are provided for your safety. If the provided plug does not fit into your outlet, consult an electrician for replacement of the obsolete outlet.
10. Protect the power cord from being walked on or pinched particularly at plugs, convenience receptacles, and the point where they exit from the apparatus.
11. Only use attachments/accessories specified by the manufacturer.
12. Use only with the cart, stand, tripod, bracket, or table specified by the manufacturer, or sold with the apparatus. When a cart is used, use caution when moving the cart/apparatus combination to avoid injury from tip-over.

PORTABLE CART WARNING
S3125A
13. Unplug this apparatus during lightning storms or when unused for long periods of time.
14. Refer all servicing to qualified service personnel. Servicing is required when the apparatus has been damaged in any way, such as power-supply cord or plug is damaged, liquid has been spilled or objects have fallen into the apparatus, the apparatus has been exposed to rain or moisture, does not operate normally, or has been dropped.

15. Damage Requiring Service

Unplug the apparatus from the wall outlet and refer servicing to qualified service personnel under the following conditions:

- A. When the power-supply cord or plug is damaged,
- B. If liquid has been spilled, or objects have fallen into the apparatus,
- C. If the apparatus has been exposed to rain or water,
- D. If the apparatus does not operate normally by following the operating instructions. Adjust only those controls that are covered by the operating instructions as an improper adjustment of other controls may result in damage and will often require extensive work by a qualified technician to restore the apparatus to its normal operation,
- E. If the apparatus has been dropped or damaged in any way, and
- F. When the apparatus exhibits a distinct change in performance this indicates a need for service.

16. Object and Liquid Entry

Never push objects of any kind into the apparatus through openings as they may touch dangerous voltage points or short-out parts that could result in a fire or electric shock.

The apparatus shall not be exposed to dripping or splashing and no objects filled with liquids, such as vases shall be placed on the apparatus.

Don't put candles or other burning objects on top of this unit.

17. Batteries

Always consider the environmental issues and follow local regulations when disposing of batteries.

18. If you install the apparatus in a built-in installation, such as a bookcase or rack, ensure that there is adequate ventilation.

Leave at least 20 cm (8") of free space above, behind, and at the sides. The rear edge of the shelf or board above the apparatus should be set 20 cm (8") away from the back or wall, creating a flue-like gap for warm air to escape.

Precautions

1. **Recording Copyright**—Unless it's for personal use only, recording copyrighted material is illegal without the permission of the copyright holder.
2. **AC Fuse**—The AC fuse inside the unit is not user-serviceable. If you cannot turn on the unit, contact your Onkyo dealer.
3. **Care**—Occasionally you should dust the unit all over with a soft cloth. For stubborn stains, use a soft cloth dampened with a weak solution of mild detergent and water. Dry the unit immediately afterwards with a clean cloth. Don't use abrasive cloths, thinners, alcohol, or other chemical solvents, because they may damage the finish or remove the panel lettering.

4. Power

WARNING

BEFORE PLUGGING IN THE UNIT FOR THE FIRST TIME, READ THE FOLLOWING SECTION CAREFULLY.

AC outlet voltages vary from country to country. Make sure that the voltage in your area meets the voltage requirements printed on the unit's rear panel (e.g., AC 230 V, 50 Hz or AC 120 V, 60 Hz).

The power cord plug is used to disconnect this unit from the AC power source. Make sure that the plug is readily operable (easily accessible) at all times.

Pressing the [ON/STANDBY] button to select Standby mode does not fully shutdown the unit. If you do not intend to use the unit for an extended period, remove the power cord from the AC outlet.

5. Preventing Hearing Loss

Caution

Excessive sound pressure from earphones and headphones can cause hearing loss.

6. Batteries and Heat Exposure

Warning

Batteries (battery packs or installed batteries) must not be exposed to excessive heat from sunshine, fire, or the like.

7. Never Touch this Unit with Wet Hands

—Never handle this unit or its power cord while your hands are wet or damp. If water or any other liquid gets inside this unit, have it checked by your Onkyo dealer.

8. Handling Notes

- If you need to transport this unit, use the original packaging to pack it how it was when you originally bought it.
- Do not leave rubber or plastic items on this unit for a long time, because they may leave marks on the case.

- This unit's top and rear panels may get warm after prolonged use. This is normal.
- If you do not use this unit for a long time, it may not work properly the next time you turn it on, so be sure to use it occasionally.

For U.S. models

FCC Information for User

CAUTION:

The user changes or modifications not expressly approved by the party responsible for compliance could void the user's authority to operate the equipment.

NOTE:

This equipment has been tested and found to comply with the limits for a Class B digital device, pursuant to Part 15 of the FCC Rules. These limits are designed to provide reasonable protection against harmful interference in a residential installation.

This equipment generates, uses and can radiate radio frequency energy and, if not installed and used in accordance with the instructions, may cause harmful interference to radio communications. However, there is no guarantee that interference will not occur in a particular installation. If this equipment does cause harmful interference to radio or television reception, which can be determined by turning the equipment off and on, the user is encouraged to try to correct the interference by one or more of the following measures:

- Reorient or relocate the receiving antenna.
- Increase the separation between the equipment and receiver.
- Connect the equipment into an outlet on a circuit different from that to which the receiver is connected.
- Consult the dealer or an experienced radio/TV technician for help.

For Canadian Models

NOTE: THIS CLASS B DIGITAL APPARATUS COMPLIES WITH CANADIAN ICES-003.

For models having a power cord with a polarized plug:

CAUTION: TO PREVENT ELECTRIC SHOCK, MATCH WIDE BLADE OF PLUG TO WIDE SLOT, FULLY INSERT.

Modèle pour les Canadien

REMARQUE: CET APPAREIL NUMÉRIQUE DE LA CLASSE B EST CONFORME À LA NORME NMB-003 DU CANADA.

Sur les modèles dont la fiche est polarisée:

Precautions—Continued

ATTENTION: POUR ÉVITER LES CHOCS ÉLECTRIQUES, INTRODUIRE LA LAME LA PLUS LARGE DE LA FICHE DANS LA BORNE CORRESPONDANTE DE LA PRISE ET POUSSER JUSQU'AU FOND.

For British models

Replacement and mounting of an AC plug on the power supply cord of this unit should be performed only by qualified service personnel.

IMPORTANT

The wires in the mains lead are coloured in accordance with the following code:

Blue: Neutral
Brown: Live

As the colours of the wires in the mains lead of this apparatus may not correspond with the coloured markings identifying the terminals in your plug, proceed as follows:

The wire which is coloured blue must be connected to the terminal which is marked with the letter N or coloured black.

The wire which is coloured brown must be connected to the terminal which is marked with the letter L or coloured red.

IMPORTANT

The plug is fitted with an appropriate fuse. If the fuse needs to be replaced, the replacement fuse must be approved by ASTA or BSI to BS1362 and have the same ampere rating as that indicated on the plug. Check for the ASTA mark or the BSI mark on the body of the fuse.

If the power cord's plug is not suitable for your socket outlets, cut it off and fit a suitable plug. Fit a suitable fuse in the plug.

For European Models

Declaration of Conformity

We, ONKYO EUROPE
ELECTRONICS GmbH
LIEGNITZERSTRASSE 6,
82194 GROEBENZELL,
GERMANY



declare in own responsibility, that the ONKYO product described in this instruction manual is in compliance with the corresponding technical standards such as EN60065, EN55013, EN55020 and EN61000-3-2, -3-3.

GROEBENZELL, GERMANY

K. MIYAGI

ONKYO EUROPE ELECTRONICS GmbH

Package Contents

Make sure you have the following items:

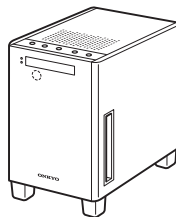

HTX-22HDXPAW Amp/Subwoofer

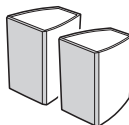

HTX-22HDXST Front Speakers

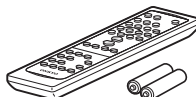

Remote controller and two batteries (AA/R6)



Cables with red line for the front speakers
(11.5 ft., 3.5 m)

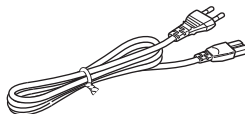

Power cord
(Power cord varies from country to country.)



Rubber feet for the Amp/Subwoofer (x4)

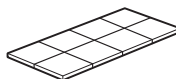

Rubber feet for the front speakers (x8)

* In catalogs and on packaging, the letter at the end of the product name indicates the color. Specifications and operation are the same regardless of color.

Speaker Precautions

Placement

- The subwoofer cabinet is made out of wood and is therefore sensitive to extreme temperatures and humidity. Do not put it in locations subject to direct sunlight or in humid places, such as near an air conditioner, humidifier, bathroom, or kitchen.
- Do not put water or other liquids close to the speakers. If liquid is spilled over the speakers, the drive units may be damaged.
- Speakers should only be placed on sturdy, flat surfaces that are free from vibration. Putting them on uneven or unstable surfaces, where they may fall and cause damage, will affect the sound quality.
- The HTX-22HDXPAW Amp/Subwoofer is designed to be used in the upright vertical position only. Do not use it in the horizontal or tilted position.
- If the subwoofer is used near a turntable, CD/Blu-ray/DVD player/recorder, howling or skipping may occur. To prevent this, position the subwoofer away from such components, or turn down the volume.
- The HTX-22HDXPAW Amp/Subwoofer generates heat and has vents at the top and rear to allow this heat to escape. When installing, leave at least 20 cm (8") of free space above and behind. Also, leave at least 20 cm (8") of free space at the sides, otherwise, the performance of the bass-reflex port may be compromised. The HTX-22HDXPAW Amp/Subwoofer uses a non-shielded design. If you're using a CRT-type TV, to prevent picture interference, position it at least 40 cm (15-3/4") away from your TV.

Bass-reflex port

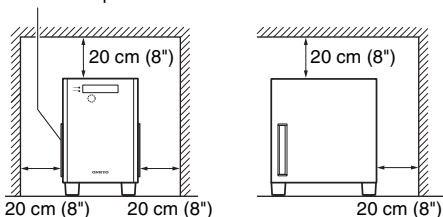

Using Close to a TV or Computer

TVs and computer monitors are magnetically sensitive devices and as such are likely to suffer discoloration or picture distortion when conventional speakers are placed nearby. To prevent this, the HTX-22HDXST speakers feature internal magnetic shielding. In some situations, however, discoloration may still be an issue, in which case you should turn off your TV or monitor, wait 15 to 30 minutes, and then turn it back on again. This normally activates the degaussing function, which neutralizes the magnetic field, thereby removing any discoloration effects. If discoloration problems persist, try moving the speakers away from your TV or monitor. Note that discoloration can also be caused by a magnet or demagnetizing tool that's too close to your TV or monitor.

Input Signal Warning

The speakers can handle the specified input power when used for normal music reproduction. If any of the following signals are fed to them, even if the input power is within the specified rating, excessive current may flow in the speaker coils, causing burning or wire breakage:

1. Interstation noise from an untuned FM radio.
2. Sound from fast-forwarding a cassette tape.
3. High-pitched sounds generated by an oscillator, electronic musical instrument, and so on.
4. Amplifier oscillation.
5. Special test tones from audio test CDs and so on.
6. Thumps and clicks caused by connecting or disconnecting audio cables. (Always turn off the HTX-22HDXPAW Amp/Subwoofer before connecting or disconnecting cables.)
7. Microphone feedback.

Contents

Important Safety Instructions	2	Turning On the HTX-22HDX	27
Precautions	3	Connecting the Power Cord	27
Package Contents	4	Turning On and Standby	27
Speaker Precautions	5	Playing Your Components	28
Features	7	Basic HTX-22HDX Operation	28
Getting to Know the HTX-22HDX	9	Setting the Display Brightness	29
Top Panel and Front.....	9	Muting the HTX-22HDX	29
Display.....	10	Using the Sleep Timer	29
Rear Panel	11	Displaying Source Information	30
Remote Controller	12	Changing the Input Display	30
Installing the Batteries	12	Using the Listening Modes	32
Aiming the Remote Controller	12	Selecting the Listening Modes	32
Using the Remote Controller	13	About the Listening Modes	33
Connecting the Speakers	14	Late Night Function.....	36
Enjoying Home Theater.....	14	Adjusting Speaker Levels	36
Affixing the Rubber Feet.....	15	Setup	37
Speaker Connection Precautions.....	16	Setup Menus.....	37
Making the Connections.....	16	Changing Settings.....	38
Connecting only the Front Speakers	17	Specifying the Digital Signal Format	45
Connecting 5.1 Speakers	17	Troubleshooting	46
Connecting AV Components	18	HDMI (High-Definition Multimedia	
About AV Connections	18	Interface)	49
Making HDMI Connections.....	19	Specifications	51
Connecting Components with		Using an RHD-compatible TV,	
Digital Outputs	21	Player, or Recorder	53
Connecting Components with			
Analog Outputs	22		
Connecting Onkyo RI Components	23		

* To reset the HTX-22HDX to its factory defaults, turn it on and, while holding down the [LISTENING MODE] button, press the [ON/STANDBY] button (see page 46).

Features

HTX-22HDXPAW: 5.1-channel Amp/Subwoofer

5.1-channel power amplifier with built-in subwoofer

- 25 W/CH (FL, FR, C, SL, SR), 6 Ω , 1 kHz (European and North American models)
- 50 W (SB), 3 Ω , 100 Hz (European model); 47 W (SB), 3 Ω , 100 Hz (North American model)
- 3 HDMI^{*1} inputs, 1 output (HDMI Version 1.4, with 3D Over HDMI and Audio Return Channel, plus support for up to 1080p, Deep Color, x.v.Color, Lip Sync, DTS-HD Master Audio^{*2}, DTS-HD High Resolution Audio, Dolby TrueHD^{*3}, Dolby Digital Plus, SACD, and multi-channel PCM)
- HD audio decoding: Dolby TrueHD and DTS-HD Master Audio
- Easy setup with onscreen display (OSD) via HDMI
- VLSC^{*4} (Vector Linear Shaping Circuitry)
- EX. Bass for a deeper, more dynamic bass
- 4 DSP modes especially for gaming (Rock, Sports, Action, and RPG)
- Music Optimizer^{*5} for use with compressed digital music
- Onkyo **RHD** system control over HDMI
- 2 optical inputs, 1 coaxial input
- 2 analog inputs
- Auto Power Down (on/off)
- Theater-Dimensional^{*6} virtual surround
- Remote controller
- 16 cm cone

HTX-22HDXST: Front Speakers

Full range, bass-reflex speakers

- 8 cm full-range cone
- 70 Hz–20 kHz frequency response
- 40 W maximum power
- 6 Ω impedance
- Gloss finish

Designed especially for use with the HTX-22HDX, the optional Onkyo SKS-22X speaker package consists of a center speaker and two surround speakers that can be connected directly to the HTX-22HDX.

Features—Continued



“HDMI, the HDMI Logo, and High-Definition Multimedia Interface are trademarks or registered trademarks of HDMI Licensing LLC in the United States and other countries.”



Manufactured under license under U.S. Patent #'s: 5,451,942; 5,956,674; 5,974,380; 5,978,762; 6,226,616; 6,487,535; 7,212,872; 7,333,929; 7,392,195; 7,272,567 & other U.S. and worldwide patents issued & pending. DTS is a registered trademark and the DTS logos, Symbol are trademarks of DTS, Inc. © 1996-2008 DTS, Inc. All Rights Reserved.



Manufactured under license from Dolby Laboratories. Dolby, Pro Logic, and the double-D symbol are trademarks of Dolby Laboratories.

*4. VLSC is a registered trademark of Onkyo Corporation.

*5. Music Optimizer[™] is a trademark of Onkyo Corporation.



Theater-Dimensional

Theater-Dimensional is a trademark of Onkyo Corporation.

* Apple and iPod are trademarks of Apple Inc., registered in the U.S. and other countries.

* “x.v.Color” is a trademark of Sony Corporation.

Getting to Know the HTX-22HDX

Top Panel and Front

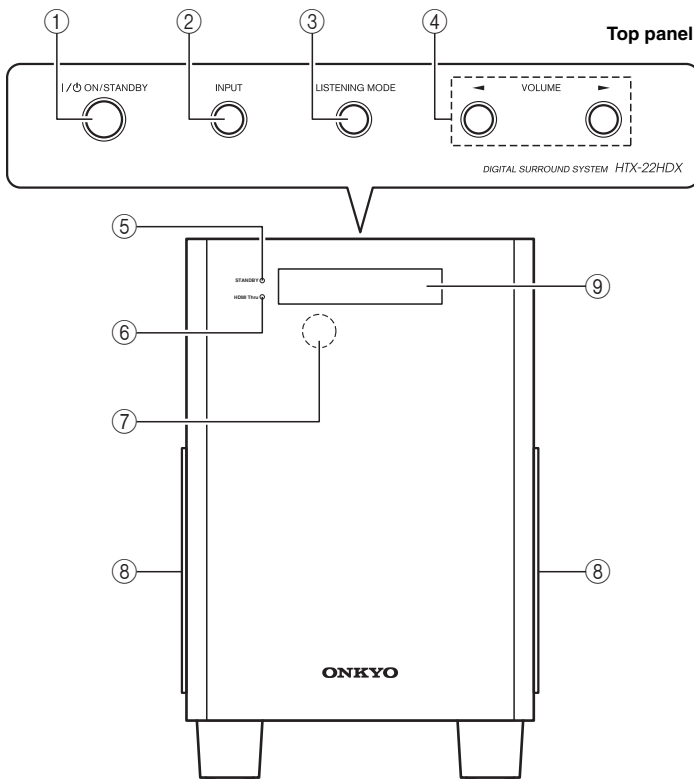

For detailed information, see the pages in parentheses.

- ① **ON/STANDBY button (27)**
- ② **INPUT button (28)**
- ③ **LISTENING MODE button (32)**
- ④ **VOLUME [◀]/[▶] buttons (28)**
- ⑤ **STANDBY indicator (red) (27)**
- ⑥ **HDMI Thru indicator (orange) (44)**
- ⑦ **Remote-control sensor (12)**
- ⑧ **Bass-reflex port**
- ⑨ **Display**

Display

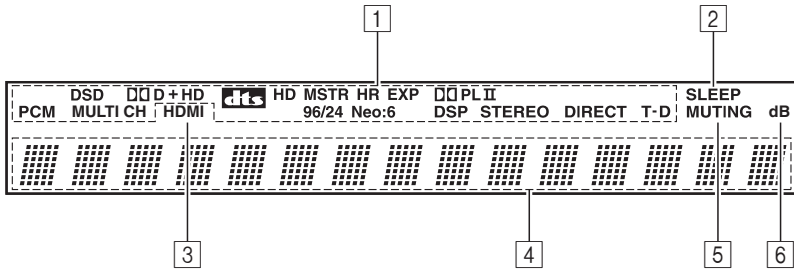

For detailed information, see the pages in parentheses.

1 Listening mode and format indicators

Indicator	Listening mode/input format
PCM	PCM
D D	Dolby Digital
DTS	DTS
D+ D+	Dolby Digital Plus
HD HD	Dolby TrueHD
DTS EXP	DTS Express Audio
HD HR	DTS-HD High Resolution Audio
HD MSTR	DTS-HD Master Audio
DSD	Direct Stream Digital
T-D	Theater-Dimensional
MULTI CH	PCM multichannel

2 SLEEP indicator (29)

3 HDMI indicator (19)

4 Message area (34)

5 MUTING indicator (29)

6 dB indicator (42)

Rear Panel

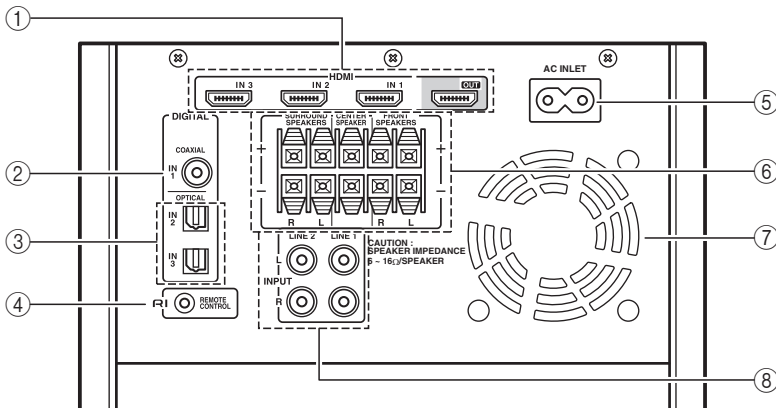

For detailed information, see the pages in parentheses.

- ① **HDMI IN 1, IN 2, IN 3, and OUT (49)**
- ② **COAXIAL DIGITAL IN 1 (21)**
- ③ **OPTICAL DIGITAL IN 2 and IN 3 (21)**
- ④ **RI REMOTE CONTROL (23)**
- ⑤ **AC INLET (27)**
- ⑥ **FRONT SPEAKERS, CENTER SPEAKER, and SURROUND SPEAKERS (17)**
- ⑦ **Cooling fan**
- ⑧ **LINE 1 and LINE 2 INPUT (22)**

See pages 14–24 for hookup information.

Remote Controller

Installing the Batteries

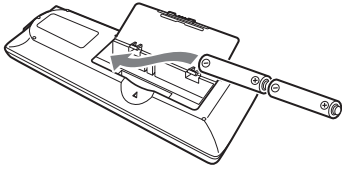

Notes:

- If the remote controller doesn't work reliably, try replacing the batteries.
- Don't mix new and old batteries or different types of batteries.
- If you intend not to use the remote controller for a long time, remove the batteries to prevent damage from leakage or corrosion.
- Expired batteries should be removed as soon as possible to prevent damage from leakage or corrosion.

Aiming the Remote Controller

When using the remote controller, point it toward the HTX-22HDX's remote control sensor, as shown below.

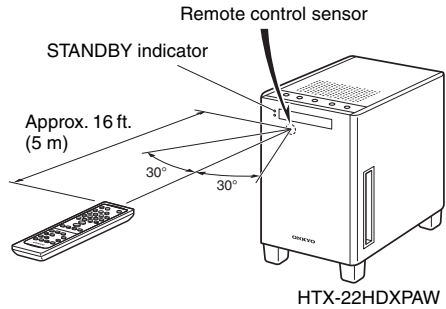

Using the Remote Controller

These buttons are used to control the HTX-22HDX.

For detailed information, see the pages in parentheses.

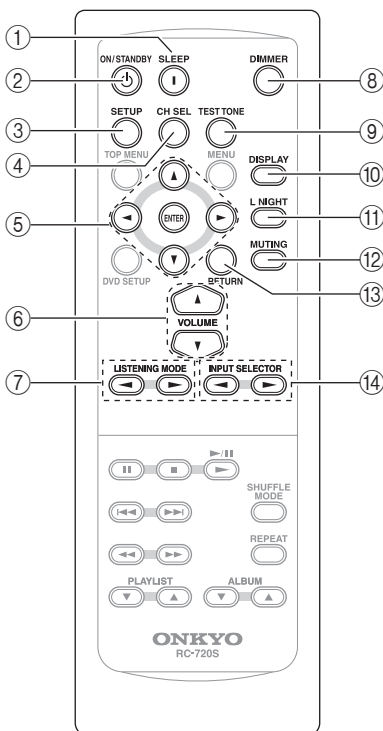

- ① **SLEEP button (29)**
- ② **ON/STANDBY button (27)**
- ③ **SETUP button (38)**
- ④ **CH SEL button (36)**
- ⑤ **Arrow [▲]/[▼]/[◀]/[▶] and ENTER buttons (38)**
- ⑥ **VOLUME [▲]/[▼] buttons (28)**
- ⑦ **LISTENING MODE [◀]/[▶] buttons (32)**
- ⑧ **DIMMER button (29)**
- ⑨ **TEST TONE button (36)**
- ⑩ **DISPLAY button (30)**
- ⑪ **L NIGHT button (36)**
- ⑫ **MUTING button (29)**
- ⑬ **RETURN button (38)**
- ⑭ **INPUT SELECTOR [◀]/[▶] buttons (28)**

Buttons that are not explained here are intended for use with an Onkyo Blu-ray/DVD player/recorder or RI Dock with iPod (see pages 25 and 26).

Connecting the Speakers

Enjoying Home Theater

Thanks to the HTX-22HDX's superb capabilities, you can enjoy surround sound with a real sense of movement in your own home—just like being in a movie theater or concert hall. You can enjoy DVDs featuring Dolby Digital or DTS. With analog or digital TV, you can enjoy Dolby Pro Logic II, DTS, or Onkyo's original DSP listening modes.

Speaker positions for a 5.1-channel system are shown below.

Front left and right speakers (HTX-22HDXST)

These output the main sound. Their role in a home theater is to provide a solid anchor for the sound image. They should be positioned facing the listener at about ear level, and equally spaced from the TV. Angle them inward slightly so as to create a triangle, with the listener at the apex.

Center speaker (optional SKS-22X)

This speaker enhances the front left and right speakers, making sound movements distinct and providing a full sound image. For movies it's used mainly for dialog.

Position it close to your TV (preferably on top) facing forward at about ear level, or at the same height as the front left and right speakers.

Subwoofer (HTX-22HDXPAW Amp/Subwoofer)

The subwoofer handles the bass sounds of the LFE (Low-Frequency Effects) channel. The volume and quality of the bass output from your subwoofer will depend on its position, the shape of your listening room, and your listening position. In general, a good bass sound can be obtained by installing the subwoofer in a front corner, or at one-third the way along the front wall, as shown.

Tip: To find the best position for your subwoofer, while playing a movie or some music with good bass, experiment by placing your subwoofer at various positions within the room and choose the one that provides the most satisfying results.

Surround left and right speakers (optional SKS-22X)

These speakers are used for precise sound positioning and to add realistic ambience. Position them at the sides of the listener, or slightly behind, about 2–3 feet (60–100 cm) above ear level. Ideally they should be equally spaced from the listener.

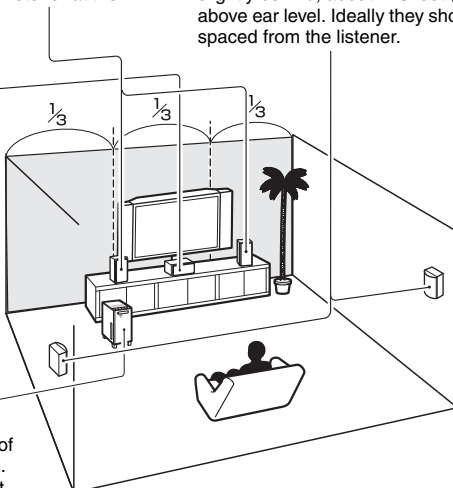

Tip:

Theater-Dimensional listening mode

With this mode, you can enjoy a virtual 5.1 surround sound even with only two or three speakers. Good results may not be possible if there's too much reverb, so we recommend that you use this mode in an environment with little or no natural reverb (see pages 35, 42).

Notes:

The HTX-22HDX Digital Surround System consists of an Amp/Subwoofer and two front speakers.

Designed especially for use with the HTX-22HDX, the optional Onkyo SKS-22X speaker package consists of a center speaker and two surround speakers that can be connected directly to the HTX-22HDX.

Be sure to make the necessary Speaker Configuration settings when you connect additional speakers (see page 39).

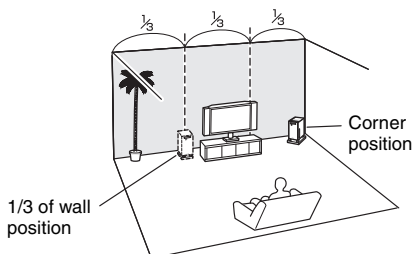

Affixing the Rubber Feet

You can improve the sound quality by affixing the included rubber feet to raise the speakers off the mounting surface thereby reducing the contact area. The feet also make the speakers stable and prevent them from moving around.

■ Rubber Feet for the Amp/Subwoofer

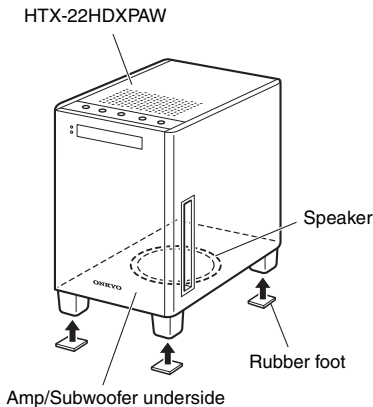

Note:

- When you pick up the Amp/Subwoofer to affix the rubber feet, place your hands away from the speaker underneath.

■ Rubber Feet for the Front Speakers

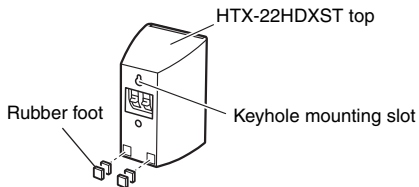
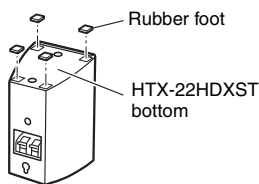

If you intend to wall-mount the front speakers using their keyhole slots, affix two rubber feet to the rear of each speaker for added stability.

Note:

- Before you wall-mount the front speakers, check the strength of the wall. The supporting strength of the screws depends on the wall material and the position of the studs. Use screws as thick and long as possible, with a head diameter of 10 mm (3/8") or less and a thread diameter of 4 mm (5/32") or less. (We recommend that you consult a professional home electronics installer.)

Connecting the Speakers—Continued

Speaker Connection Precautions

Read the following before connecting your speakers:

- Disconnect the power cord from the wall outlet before making any connections.
- Connect only speakers with an impedance of 6 ohms or higher.
- Read the instructions supplied with your speakers.
- Pay close attention to speaker wiring polarity. Connect positive (+) terminals to only positive (+) terminals, and negative (–) terminals to only negative (–) terminals. If you get them the wrong way around, the sound will be out of phase and will sound unnatural.
- Unnecessarily long or very thin speaker cables may affect the sound quality and should be avoided.
- Be careful not to short the positive and negative wires. Doing so may damage the HTX-22HDX.
- Don't connect more than one cable to each speaker terminal. Doing so may damage the HTX-22HDX.
- Don't connect a speaker to several terminals.

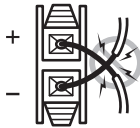

Making the Connections

- 1** Remove the pre-cut insulation from the ends of the speaker cables, and twist the bare wires tightly.

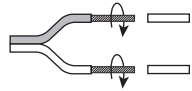

- 2** Push the lever to open the hole, insert the bare wire into the hole, and then release the lever.

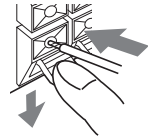

Make sure that the speaker terminals are gripping the bare wires, not the insulation.

Connecting the Speakers—Continued

Connecting only the Front Speakers

The following hookup diagram shows how to connect the included front speakers for 2.1-channel operation.

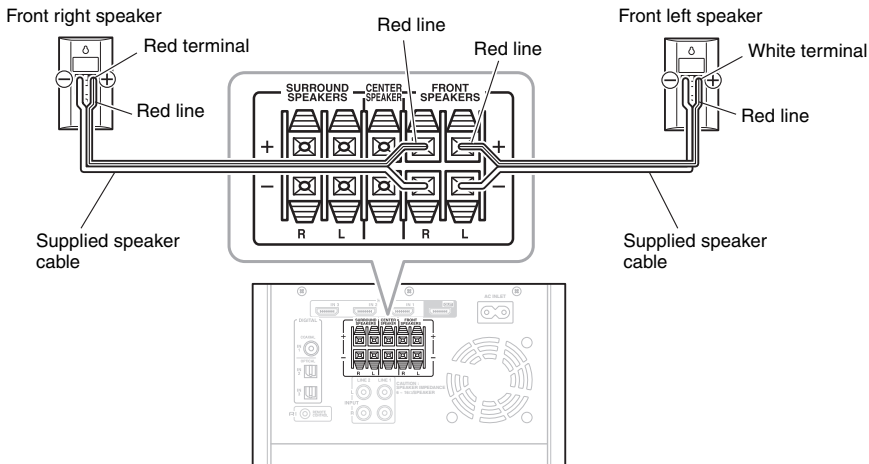

Connecting 5.1 Speakers

With additional speakers, such as the optional Onkyo SKS-22X speaker package, you can enjoy 5.1-channel surround sound. The following hookup diagram shows how to connect the included front speakers, a center speaker, and left and right surround speakers.

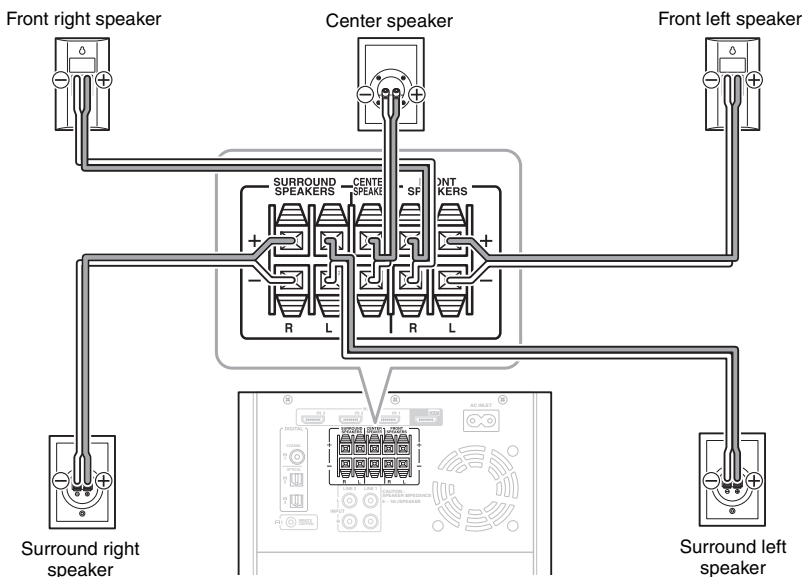

Connecting AV Components

About AV Connections

- Before making any AV connections, read the manuals supplied with your other AV components.
- Don't connect the power cord until you've completed and double-checked all AV connections.

Optical Digital Jacks

The HTX-22HDX's optical digital jacks have shutter-type covers that open when an optical plug is inserted and close when it's removed. Push plugs in all the way.

Caution: To prevent shutter damage, hold the optical plug straight when inserting and removing.

RCA Connection Color Coding

RCA connections are usually color coded: red and white. Use red plugs to connect right-channel audio inputs and outputs (typically labeled "R"). Use white plugs to connect left-channel audio inputs and outputs (typically labeled "L").

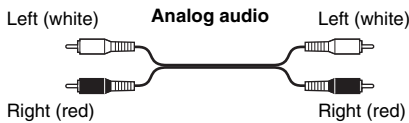

- Push plugs in all the way to make good connections (loose connections can cause noise or malfunctions).

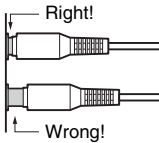

- To prevent interference, keep audio and video cables away from power cords and speaker cables.

Making HDMI Connections

You can connect components with HDMI outputs to the HTX-22HDX's HDMI IN 1, IN 2, and IN 3 inputs and connect your HDMI TV to the HTX-22HDX's HDMI OUT. You need HDMI cables to make HDMI connections.

When you connect a component to an HDMI jack, the HDMI indicator on the display lights up.

■ Video Signals

Digital video signals received by the HDMI IN jacks are output by the HDMI OUT for display on your TV.

■ Audio Signals

Digital audio signals received by the HDMI IN jacks are output by the speakers connected to the HTX-22HDX. Normally, they are not output by the HDMI OUT.



To listen to audio received by the HDMI IN jacks through your TV's speakers:

- If your TV is **RIHD**-compatible, set the TV Control setting to On (page 44).
- If your TV is not **RIHD**-compatible, set the Audio TV Out setting to On (page 43) or the TV Control setting to Off (page 44).
- Set your Blu-ray/DVD player/recorder's HDMI audio output setting to PCM.

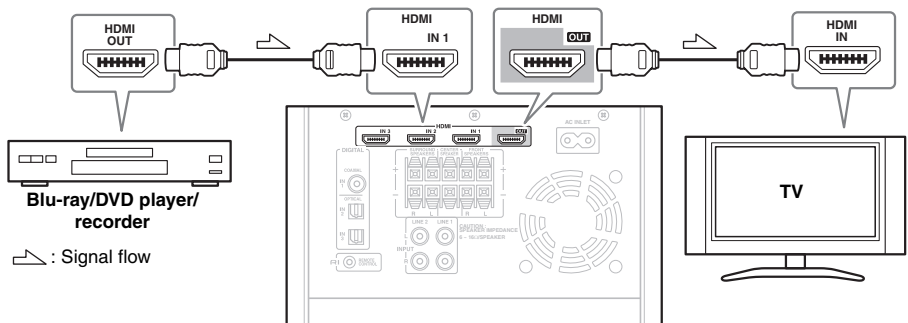

Notes:

- If your TV supports the Audio Return Channel in HDMI Version 1.4, you can listen to the sound from your TV through the HTX-22HDX (see "ARC" on page 44).
- Set the output resolution of your Blu-ray/DVD player/recorder so that it matches the resolution of your TV before starting playback.
- The HDMI video stream is compatible with DVI (Digital Visual Interface), so TVs and displays with a DVI input can be connected by using an HDMI-to-DVI adapter cable. (Note that DVI connections only carry video, so you'll need to make a separate connection for audio.) However, reliable operation with such an adapter is not guaranteed. In addition, video signals from a PC are not supported.

Connecting AV Components—Continued

- To listen to an HDMI source component through the HTX-22HDX, you must configure your system so that video from the HDMI source component can be displayed on your TV (i.e., on your TV, select the HDMI input that's connected to the HTX-22HDX's HDMI OUT). This is necessary because a component identification check has to be performed on your TV before an HDMI source component can output any signals. If your TV is off or set to a different input source, the HTX-22HDX may produce no sound or the sound may be distorted.
- The HDMI audio signal (sampling rate, bit length, etc.) may be restricted by the connected source component. If the picture is poor or there's no sound from a component connected via HDMI, check its setup. Refer to the connected component's instruction manual for details.
- If you set the Audio TV Out setting to On (page 43) to listen through your TV's speakers, if you adjust the volume on the HTX-22HDX, the HTX-22HDX's speakers will also output sound. Also, if you set the TV Control setting to On (page 44) to listen through the speakers of an **RHD**-compatible TV, if you adjust the volume on the HTX-22HDX, the HTX-22HDX's speakers will output sound when the TV's speakers are muted. To stop the HTX-22HDX's speakers producing sound, change the settings, change your TV's settings, or turn down the HTX-22HDX's volume.
- See page 49 for more information about HDMI.

Connecting AV Components—Continued

Connecting Components with Digital Outputs

You can connect components with digital audio outputs to the HTX-22HDX's DIGITAL COAXIAL IN 1, OPTICAL IN 2, and OPTICAL IN 3 inputs. Choose a digital input (coaxial or optical) that matches the digital audio output on your source component. To enjoy Dolby Digital and DTS, you must connect your Blu-ray/DVD player/recorder with an optical or coaxial digital audio cable. If your Blu-ray/DVD player/recorder supports HDMI, you can use an HDMI connection instead (see page 49).

Notes:

- If your TV supports the Audio Return Channel in HDMI Version 1.4, and your TV is connected to the HTX-22HDX via HDMI, a digital audio connection (coaxial or optical) from your TV to the HTX-22HDX is not necessary (see page 49).
- On some source components, Dolby Digital and DTS output may be turned off by default, in which case you'll need to turn it on.
- If one of your source components is noticeably louder or quieter than your others, use the IntelliVolume function to adjust its input level (see page 42).

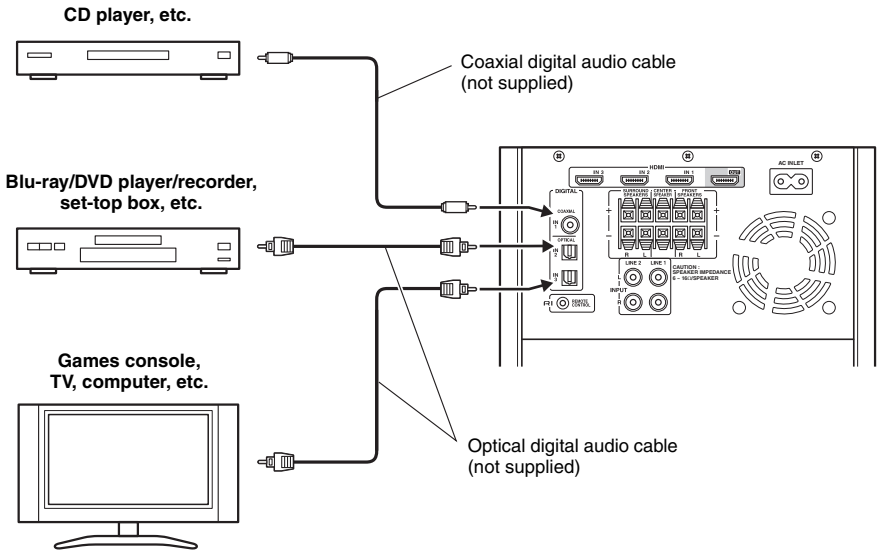

Connecting Components with Analog Outputs

You can connect components with analog audio outputs to the HTX-22HDX's LINE 1 and LINE 2 inputs and enjoy surround sound with Dolby Pro Logic II, DTS, and Onkyo's original DSP listening modes.

Notes:

- If your TV supports the Audio Return Channel in HDMI Version 1.4, and your TV is connected to the HTX-22HDX via HDMI, an analog audio connection from your TV to the HTX-22HDX is not necessary (see page 49).
- When listening to compressed music files, such as MP3, you can use the HTX-22HDX's Music Optimizer function to enhance the sound quality (see page 42).

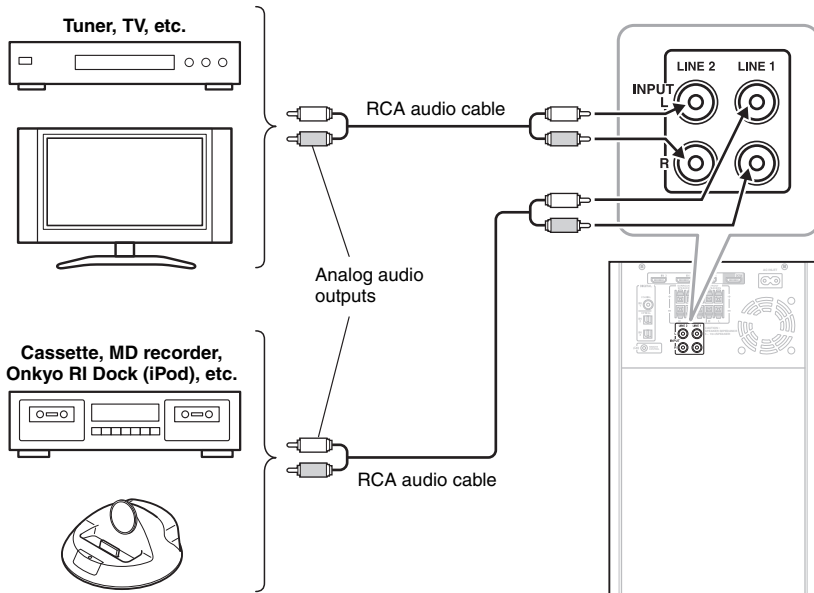

If your TV has no audio outputs, connect an audio output from your VCR or set-top box to the HTX-22HDX and use its tuner to listen to TV programs through the HTX-22HDX.

Connecting Onkyo RI Components

Connecting an Onkyo RI-capable component or Onkyo Dock with iPod to the HTX-22HDX with an **RI** cable and RCA audio cable will allow you to use the following system control functions. An **RI** cable is a special cable for use with Onkyo's **RI** (Remote Interactive) control system.

Auto Power On/Standby

If you turn on or start playback on the Onkyo RI-capable component or Onkyo Dock with iPod, the HTX-22HDX will automatically turn on and select the RI-capable component or iPod as the input source. Similarly, when the HTX-22HDX is set to Standby, the Onkyo RI-capable component or Onkyo Dock with iPod will also go on Standby.

Direct Change

When playback is started on the Onkyo RI-capable component or Onkyo Dock with iPod, the HTX-22HDX automatically selects the RI-capable component or iPod as the input source.

Remote Controller Operation

In addition to controlling the HTX-22HDX, you can also use the HTX-22HDX's remote controller to control an Onkyo RI-capable component or Onkyo Dock with iPod. When doing so, remember to point the remote controller at the HTX-22HDX and not at the RI-capable component or Onkyo Dock. Hookup information is shown below. The remote controller buttons that you can use to control an Onkyo RI-capable component or Onkyo Dock with iPod are explained on pages 25 and 26.

RI Hookup

The following diagram shows how to connect an Onkyo RI-capable component and RI Dock with iPod to the HTX-22HDX for **RI** operation. Use the **RI** cables supplied with the RI-capable component and RI Dock. An **RI** cable is not supplied with the HTX-22HDX.

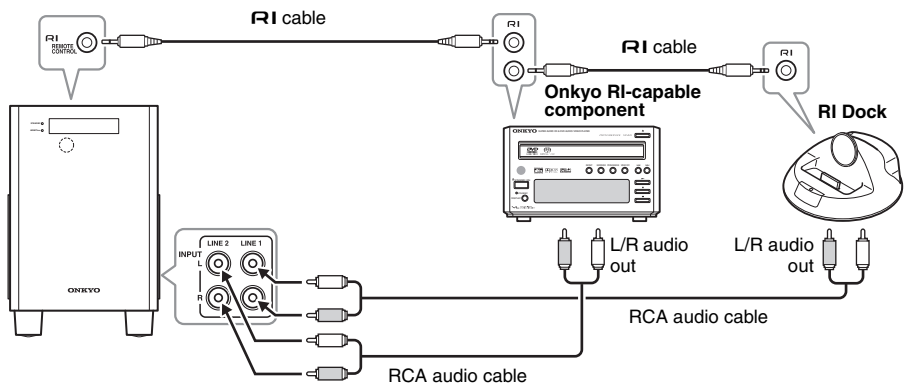

Connecting AV Components—Continued

Notes:

- If you connect both an Onkyo ND-S1 Digital Media Transport and RI Dock to the HTX-22HDX, since only one input at a time can be set to the “DOCK” input display, connect the ND-S1 to an OPTICAL DIGITAL input, and set that input to the “DOCK” input display, and connect the RI Dock to a LINE input, and set that input to the “TAPE,” “MD,” or another input display. The RI Dock will function properly even though the input display does not match the type of device.
- Use only **RI** cables for **RI** connections. **RI** cables are supplied with Onkyo players (DVD, CD, etc.).
- Some components have two **RI** jacks. You can connect either one to the HTX-22HDX. The other jack is for connecting additional **RI**-capable components.
- Connect only Onkyo components to **RI** jacks. Connecting other manufacturer’s components may cause a malfunction.
- Some components may not support all **RI** functions. Refer to the manuals supplied with your other Onkyo components.

■ ND-S1/Onkyo Dock Linked Functions

See page 26 for linked system control functions.

■ iPod Alarm Function

If you use the Alarm function on your iPod to start playback, the HTX-22HDX will turn on at the specified time and select the input to which the ND-S1 or Onkyo Dock is connected automatically.

Notes:

- Linked functions do not work with video playback, or when the alarm on your iPod is set to play a sound.
- While your iPod is inserted in an ND-S1 or Onkyo Dock, its volume control is disabled.

■ Operating Notes

- Use the volume controls on the HTX-22HDX to adjust the volume.
- If you use your iPod with any other accessories connected, playback detection may not work.
- If you adjust the volume control on your iPod while it’s inserted in an ND-S1 or Onkyo Dock, make sure it’s set to a suitable level before plugging in your earphones.
- If you use a 5th Generation iPod or iPod nano in an ND-S1, during playback the click wheel will not work, so to control functions other than play and pause, use the HTX-22HDX’s remote controller.

Connecting AV Components—Continued

Controlling Other Components

The following buttons can be used to control Onkyo components (Blu-ray/DVD player/recorder, MD recorder, CD/CD-R player, etc.) connected with **RI**. See page 23 for hookup and setting information.

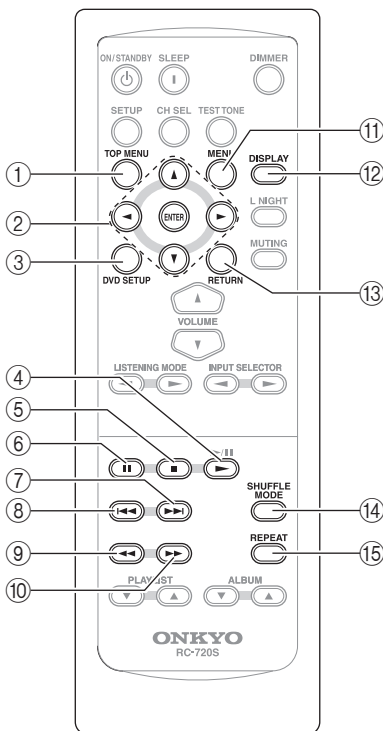

Note:

- With some components, certain buttons may not work as expected, and some may not work at all.

Component		Blu-ray/DVD player	MD recorder	CD/CD-R player	Cassette recorder
		Button			
①	TOP MENU	✓ ¹ *2			
②	Arrow [▲]/[▼]/[◀]/[▶] and ENTER	✓ ²			
③	DVD SETUP	✓ ²			
④	Play [▶]	✓	✓	✓	▶
⑤	Stop [■]	✓	✓	✓	■
⑥	Pause [⏸]	✓	✓	✓	⏸
⑦	Next [▶▶]	✓	✓	✓	▶▶
⑧	Previous [◀◀]	✓	✓	✓	◀◀
⑨	Rewind [◀◀]	✓	✓	✓	
⑩	Fast Forward [▶▶]	✓	✓	✓	
⑪	MENU	✓ ²			
⑫	DISPLAY	✓ ³	✓	✓	
⑬	RETURN	✓ ² *4			
⑭	SHUFFLE MODE	✓	✓	✓	
⑮	REPEAT	✓	✓	✓	

✓: Button active.

- *1. Displays a DVD's top menu or a DVD's title.
- *2. When changing settings, adjusting the levels of individual speakers, or outputting the test tone, the Arrow, [ENTER], and [RETURN] buttons operate the HTX-22HDX, and the [TOP MENU], [MENU], and [DVD SETUP] buttons are disabled.
- *3. Press and hold down for 3 seconds to switch to display. Displays information about the current disc, title, chapter, or track, including elapsed time, remaining time, total time, and so on.
- *4. Exits the DVD player's setup menu or returns to the previous menu.

Note:

- When you connect an Onkyo RI-capable component to LINE 1 or LINE 2, change the input display for that input to match the type of component that you connect (see page 30).

Controlling an Onkyo Dock (iPod)

The following buttons can be used to control an Onkyo Dock with iPod that's connected with **RI**. See page 23 for hookup and setting information.

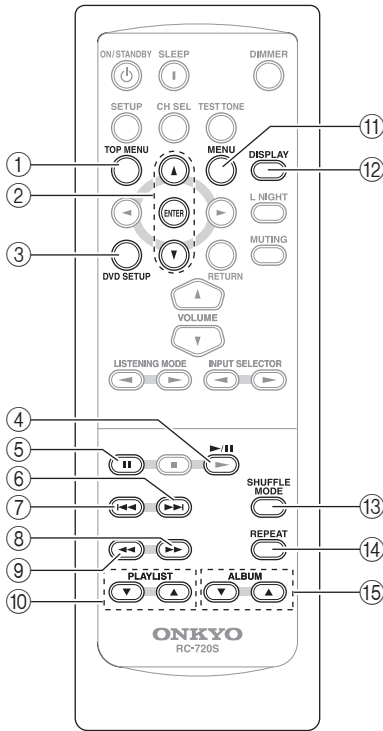

- ① **TOP MENU button*1**
Works the same as the ND-S1's [iPod/PC] button. Press repeatedly to select your iPod or PC.
- ② **Arrow [▲]/[▼] and ENTER buttons**
Used to navigate menus and select items.
- ③ **DVD SETUP button*1**
Works the same as the ND-S1's [SYNC/UNSYNC] button. Press this button to sync your iPod. To cancel sync, press and hold this button for at least 2 seconds.

- ④ **Play [▶/||] button**
Works as a Play/Pause button.
- ⑤ **Pause [||] button**
Pauses playback.
- ⑥ **Next [▶▶] button**
Selects the next song.
- ⑦ **Previous [◀◀] button**
Restarts the current song. Press it twice to restart the previous song.
- ⑧ **Fast Forward [▶▶▶] button**
Press and hold to fast forward.
- ⑨ **Rewind [◀◀◀] button**
Press and hold to rewind.
- ⑩ **PLAYLIST [▲]/[▼] buttons**
Selects the previous or next iPod playlist.
- ⑪ **MENU button**
Displays a menu.
- ⑫ **DISPLAY button**
Press and hold down for 3 seconds to switch to iPod display. Turns on the back-light.
- ⑬ **SHUFFLE MODE button**
Used with the shuffle function.
- ⑭ **REPEAT button**
Used with the repeat function.
- ⑮ **ALBUM [▲]/[▼] button**
Selects the next or previous iPod album.

Notes:

- *1: These buttons work only with the Onkyo ND-S1.
- If you're using an ND-S1, set it to iPod mode (iPod button/ indicator lit).
- Set the RI Dock's RI MODE switch to HDD or HDD/DOCK.
- See the Onkyo Dock's instruction manual for more details.

Turning On the HTX-22HDX

Connecting the Power Cord

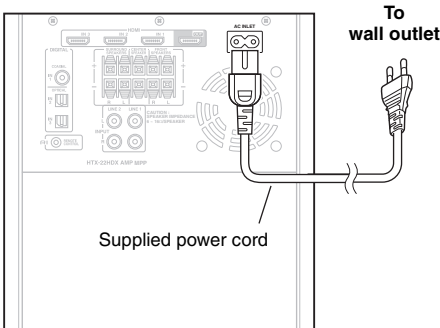

Before connecting the power cord, connect all of your speakers and other components.

1 Connect the supplied power cord to the HTX-22HDX's AC INLET.

2 Plug the other end of the power cord into a suitable wall outlet.

The STANDBY indicator lights up.

Notes:

- Turning on the HTX-22HDX may cause a momentary power surge that might interfere with other electrical equipment on the same circuit. If this is a problem, plug the HTX-22HDX into a different branch circuit.
- Do not use a power cord other than the one supplied with the HTX-22HDX. The supplied power cord is designed exclusively for use with the HTX-22HDX and should not be used with any other equipment.
- Never disconnect the power cord from the HTX-22HDX while the other end is still plugged into a wall outlet. Doing so may cause an electric shock. Always disconnect the power cord from the wall outlet first, and then the HTX-22HDX.

Turning On and Standby

ON/STANDBY



STANDBY indicator

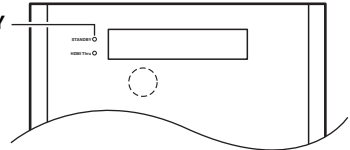

ON/STANDBY

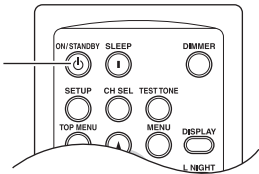

On the HTX-22HDX, press the [ON/STANDBY] button.

On the remote controller, press the [ON/STANDBY] button.

The HTX-22HDX comes on, the display lights up, and the STANDBY indicator goes off.

To turn off the HTX-22HDX, press the [ON/STANDBY] button, or press the remote controller's [ON/STANDBY] button. The HTX-22HDX will enter Standby mode. To prevent any loud surprises the next time you turn on the HTX-22HDX, turn down the volume before you turn it off.

Playing Your Components

Basic HTX-22HDX Operation

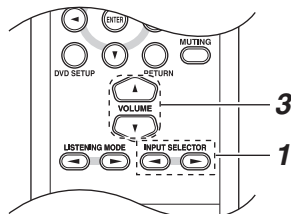
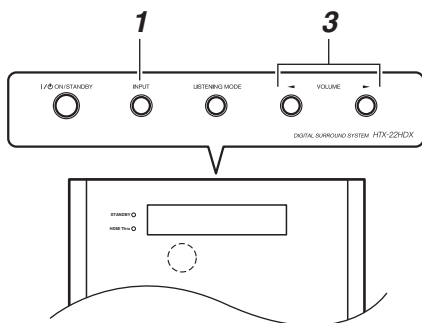

1 Press the HTX-22HDX's [INPUT] button repeatedly to select an input source.

To select an input source with the remote controller, use its [INPUT SELECTOR] buttons.

The input source will change 1 second after you release the [INPUT] or [INPUT SELECTOR] button.

2 Start playback on the source component.

To watch a video source that's connected to an HDMI IN, on your TV, select the video input that's connected to the HTX-22HDX's HDMI OUT.

On some Blu-ray/DVD player/recorders, you may need to change the digital or HDMI audio output settings.

3 To adjust the volume, use the HTX-22HDX's VOLUME [◀/▶] buttons, or the remote controller's [VOLUME] buttons.

Since the HTX-22HDX is designed for home theaters, it has a wide volume range for precise adjustment. The volume can be adjusted from Min, 1 through 79, or Max.

You can limit the maximum volume with the MaxVolume setting (see page 43).

4 Select a listening mode and enjoy!
See "Using the Listening Modes" on page 32.

Note:

- You can change various settings in Setup (see page 37).

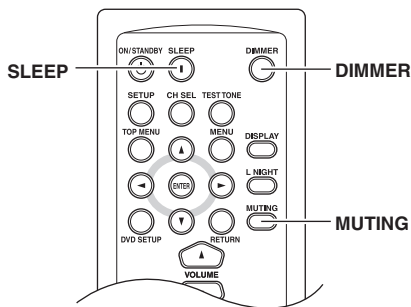

Setting the Display Brightness

You can adjust the brightness of the display.

Press the remote controller's [DIMMER] button repeatedly to select dim, dimmer, or normal brightness.

Muting the HTX-22HDX

You can temporarily mute the output of the HTX-22HDX.

Press the remote controller's [MUTING] button.

The output is muted and the MUTING indicator flashes on the display.



To unmute the HTX-22HDX, press the remote controller's [MUTING] button again, or adjust the volume. The output is unmuted and the MUTING indicator goes off.

Muting is cancelled when the HTX-22HDX is set to Standby.

Using the Sleep Timer

With the sleep timer, you can set the HTX-22HDX so that it turns off automatically after a specified period.

Press the remote controller's [SLEEP] button repeatedly to select the required sleep time.

The sleep time can be set from 90 to 10 minutes in 10 minute steps.

When the sleep timer has been set, the SLEEP indicator appears on the display, as shown. The selected sleep time appears on the display for about 5 seconds, then the previous display appears.

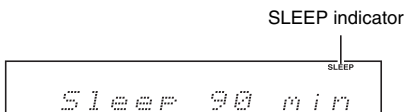

To cancel the sleep timer, press the [SLEEP] button repeatedly until the SLEEP indicator disappears.

To check the remaining sleep time, press the [SLEEP] button. Note that if you press the [SLEEP] button while the sleep time is being displayed, you'll shorten the sleep time by 10 minutes.

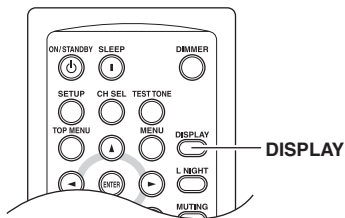

Displaying Source Information

You can display various information about the current input source as follows.

Press the remote controller's [DISPLAY] button repeatedly to cycle through the available information.

The following information can typically be displayed:

Input source & volume

DIG1 48



Signal format*1 or sampling frequency

Dolby D 51



Input source & listening mode

DIG1 Dolby D

*1. If the input signal is analog, no format information is displayed. If the input signal is PCM, the sampling frequency is displayed. If the input signal is digital but not PCM, the signal format is displayed. Information is displayed for about 3 seconds, then the previous display reappears.

Changing the Input Display

You can change the input display so that it shows the type of component connected to an input when that input is selected. The input display can be changed for the following inputs: DIGITAL IN 1 (DIG1), DIGITAL IN 2 (DIG2), DIGITAL IN 3 (DIG3), LINE 1, and LINE 2.

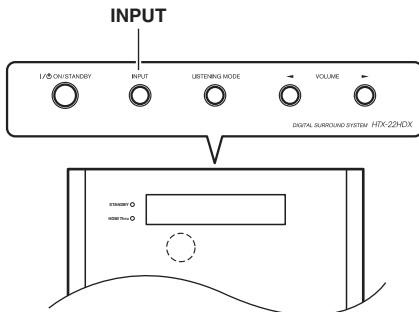

1 Use HTX-22HDX's [INPUT] button to select the input whose input display you want to change.

2 Press and hold down the [INPUT] button (about 3 seconds) to change the setting.

Below are the input display options for each input:

DIG1: DIG1, DIG1(DOCK)

DIG2: DIG2, DIG2(DOCK), DIG2(TV)

DIG3: DIG3(TV), DIG3, DIG3(DOCK)

LINE1: LINE1, LINE1(DOCK),

LINE1(DVD), LINE1(CD),

LINE1(TAPE), LINE1(MD),

LINE1(CDR), LINE1(TV).

LINE2: LINE2, LINE2(DOCK),

LINE2(DVD), LINE2(CD),

LINE2(TAPE), LINE2(MD),

LINE2(CDR), LINE2(TV).

Example displays are shown below.

DIG2

DIG2(DOCK)

DIG3(TV)

LINE1

LINE1(DOCK)

LINE1(DVD)

LINE1(CD)

LINE1(TAPE)

LINE1(MD)

LINE1(CDR)

LINE1(TV)

Notes:

- To listen to the TV's audio by using the ARC (Audio Return Channel), in HDMI Setup, HDMI Control must be set to On and ARC must be set to Auto (see page 44).
- DIGITAL IN 1 (DIG1), DIGITAL IN 2 (DIG2), or DIGITAL IN 3 (DIG3) cannot be set the same. Likewise for LINE 1 and LINE 2.

Using the Listening Modes

Selecting the Listening Modes

For a description of each listening mode, see “About the Listening Modes” on page 33.

- The Dolby Digital and DTS listening modes can only be selected if your Blu-ray/DVD player/recorder is connected to the HTX-22HDX with a digital audio connection (coaxial, optical, or HDMI).
- The listening modes that you can select depends on the format of the input signal. To check the format, see “Displaying Source Information” on page 30.

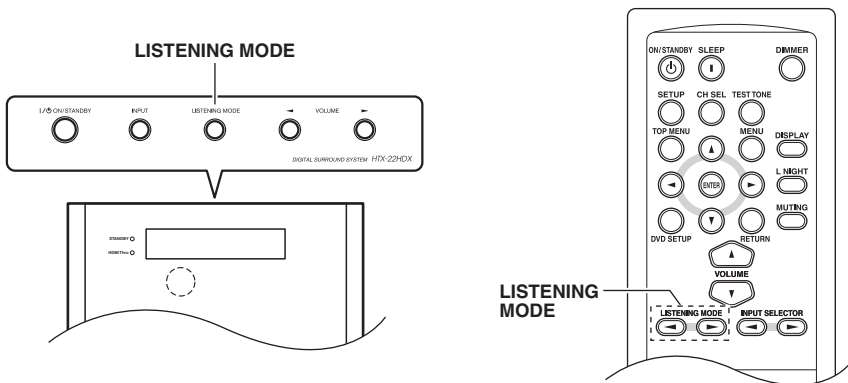

To select the listening modes, repeatedly press the [LISTENING MODE] buttons on the HTX-22HDX or remote controller.

The name of the selected listening mode is shown on the display.

Using the Listening Modes—Continued

About the Listening Modes

The HTX-22HDX's listening modes can transform your listening room into a movie theater or concert hall, with high fidelity and stunning surround sound.

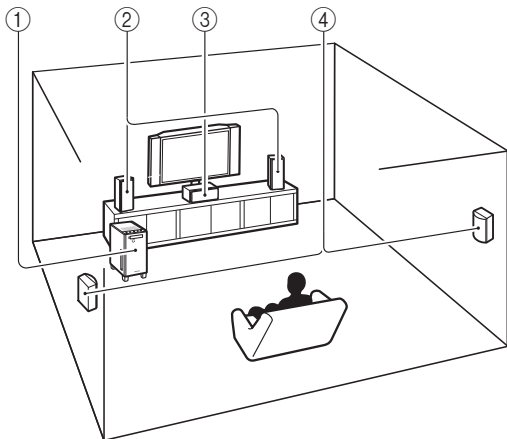

- ① **Subwoofer**
- ② **Front speakers**
- ③ **Center speaker (optional)**
- ④ **Surround speakers (optional)**

Speaker Layout

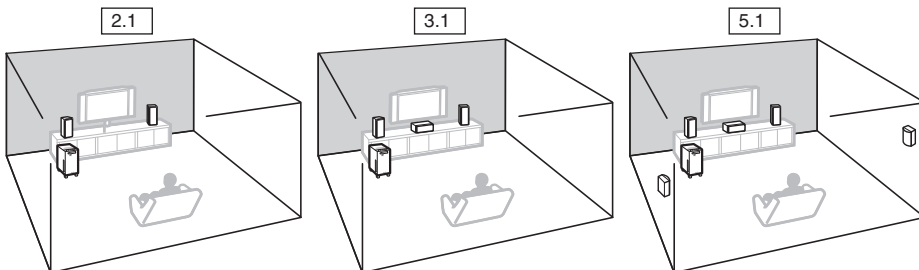

Input Sources

The following audio formats are supported by the listening modes.

MONO	This is mono (monophonic) sound.
STEREO	This is stereo (stereophonic) sound. Two independent audio signal channels are reproduced through two speakers.
5.1ch	This is 5.1-channel surround sound. This surround system has five main channels of sound and a sixth subwoofer channel (called the point-one channel).
7.1ch *1	This is 7.1-channel surround sound. This is a further sound enhancement to 5.1 channel sound with two additional speakers that provide greater sound envelopment and more accurate positioning of sounds.

*1. The HTX-22HDX outputs this source as 5.1-channel surround sound.

Using the Listening Modes—Continued

Listening Modes

Listening Mode	Description	Input Source	Speaker Layout
Direct	In this mode, audio from the input source is output without surround-sound processing. The Sp Config and Sp Distance settings are active, but much of the processing set via Audio Adjust is disabled. See “Setup” on page 37 for more details. Note: • When you play source material that contains no information in the LFE (Low Frequency Effects) channel, the subwoofer will produce no sound.	MONO STEREO 5.1ch 7.1ch	2.1 3.1 5.1
	Stereo	Sound is output by the front left and right speakers and subwoofer.	
Mono	Use this mode when watching an old movie with a mono soundtrack, or use it with the foreign language soundtracks recorded in the left and right channels of some movies. It can also be used with DVDs or other sources containing multiplexed audio, such as karaoke DVDs.		
Multichannel	This mode is for use with PCM multichannel sources. The MULTI CH indicator lights up when a PCM multichannel signal is input.	5.1ch	3.1 5.1
Dolby Pro Logic II	This mode expands any 2-channel source for 5.1-channel playback. It provides a very natural and seamless surround-sound experience that fully envelops the listener. As well as music and movies, video games can also benefit from the dramatic spatial effects and vivid imaging. • Dolby PLII Movie Use this mode with DVDs and videos that bear the Dolby Surround logo or TV shows that feature Dolby Surround. You can also use this mode with stereo movies or TV shows and the HTX-22HDX will create a 5.1 surround mix from the 2-channel stereo. • Dolby PLII Music Use this mode to add 5.1 surround to stereo sources such as music CDs and DVDs. • Dolby PLII Game Use this mode when playing game discs.	STEREO	3.1 5.1
Dolby Digital	In this mode, audio from the input source is output without surround-sound processing. Sp Config, Sp Distance, and much of the processing set via Audio Adjust is active. See “Setup” on page 37 for more details.	5.1ch 7.1ch	3.1 5.1
Dolby Digital Plus*2			
Dolby TrueHD			
DTS		5.1ch	3.1 5.1
DTS-HD High Resolution Audio		5.1ch 7.1ch	3.1 5.1
DTS-HD Master Audio			
DTS Express		STEREO 5.1ch	3.1 5.1
DSD*3		5.1ch	3.1 5.1
DTS 96/24*4		This mode is for use with DTS 96/24 sources. This is high-resolution DTS with a 96 kHz sampling rate and 24-bit resolution, providing superior fidelity. Use it with DVDs that bear the DTS 96/24 logo.	5.1ch

Using the Listening Modes—Continued

Listening Mode	Description	Input Source	Speaker Layout
DTS Neo:6	<p>This mode expands any 2-channel source for up to 5.1-channel playback. It uses seven full-bandwidth channels of matrix decoding for matrix-encoded material, providing a very natural and seamless surround sound experience that fully envelops the listener.</p> <ul style="list-style-type: none"> • Neo:6 Cinema Use this mode with stereo movies (e.g., TV, DVD, VHS). • Neo:6 Music Use this mode with stereo music sources (e.g., CD, radio, cassette, TV, VHS, DVD). 	STEREO	[3.1] [5.1]

Onkyo Original DSP Modes

Listening Mode	Description	Input Source	Speaker Layout
Mono Movie	This mode is suitable for old movies and other mono sources. The center speaker outputs the sound as it is, while reverb is applied to the sound output by the other speakers, giving presence to even mono material.	MONO STEREO 5.1 ch	[5.1]
Orchestra	Suitable for classical or operatic music, this mode emphasizes the surround channels in order to widen the stereo image, and simulates the natural reverberation of a large hall.		
Unplugged	Suitable for acoustic instruments, vocals, and jazz, this mode emphasizes the front stereo image, giving the impression of being right in front of the stage.		
Studio-Mix	Suitable for rock or pop music, listening to music in this mode creates a lively sound field with a powerful acoustic image, like being at a club or rock concert.		
TV Logic	This mode adds realistic acoustics to TV shows produced in a TV studio, surround effects to the entire sound, and clarity to voices.		
Game-RPG	Use this mode when playing role playing game discs.	MONO	[5.1]
Game-Action	Use this mode when playing action game discs.	STEREO	
Game-Rock	Use this mode when playing rock game discs.	5.1 ch	
Game-Sports	Use this mode when playing sports game discs.	7.1 ch	
All Ch Stereo	Ideal for background music, this mode fills the entire listening area with stereo sound from the front, surround, and surround back speakers.	MONO STEREO 5.1 ch 7.1 ch	[3.1] [5.1]
Full Mono	In this mode, all speakers output the same sound in mono, so the sound you hear is the same regardless of where you are within the listening room.		
T-D (Theater-Dimensional)	With this mode, you can enjoy virtual surround sound even with only two or three speakers. This works by controlling how sounds reach the listener's left and right ears. Good results may not be possible if there's too much reverb, so we recommend that you use this mode in an environment with little or no natural reverb. See "Front 5.1ch" on page 42 to get the best result from this mode.		[2.1] [3.1] [5.1]

Notes:

- *2. For Blu-ray discs, Dolby Digital is used.
- *3. The HTX-22HDX accepts DSD signals via its HDMI inputs. Depending on your player, setting your player to output PCM may produce a better sound. If this is the case, set your player to output PCM.
- *4. Depending on the input source, DTS will be used.
- The listening modes cannot be selected with some source formats.

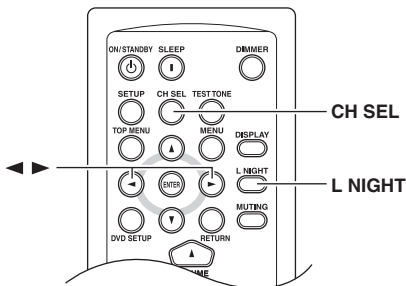

Late Night Function

With the Late Night function, you can reduce the dynamic range of Dolby Digital material so that you can still hear quiet parts even when listening at low volume levels—ideal for watching movies late at night when you don't want to disturb anyone.

Press the remote controller's [L NIGHT] button repeatedly to select the following options:

For **Dolby Digital** and **Dolby Digital Plus** sources, the options are:

Off: Late Night function off (default).

Low: Small reduction in dynamic range.

High: Large reduction in dynamic range.

For **Dolby TrueHD** sources, the options are:

Auto: The Late Night function is set to On or Off automatically (default).

Off: Late Night function off.

On: Late Night function on.

Notes:

- The Late Night function can be used only when the input source is Dolby Digital, Dolby Digital Plus, or Dolby TrueHD.
- The effect of the Late Night function depends on the material that you are playing and the intention of the original sound designer, and with some material there will be little or no effect when you select the different options.
- The Late Night function is set to Off when the HTX-22HDX is set to Standby.

Adjusting Speaker Levels

You can adjust the volume of each speaker while listening to an input source. These temporary adjustments are cancelled when the HTX-22HDX is set to Standby.

Use the remote controller's [CH SEL] button to select each speaker, and use the Left and Right [◀]/[▶] buttons to adjust the volume. You can adjust the volume of each speaker from -12 dB to +12 dB (-15 dB to +12 dB for the subwoofer).

Notes:

- To save these adjustments, press the [TEST TONE] button.
- You cannot use this function while the HTX-22HDX is muted.

Setup

Setup Menus

The setup menus appear on the display and provide a convenient way to change settings. From the main menu, settings are organized into eight submenus.

Main menu	Submenu	Item	Page
1. Sp Config	1. Subwoofer	No, Yes	39
	2. Front	Small, Large	39
	3. Center	None, Small, Large	39
	4. Surround	None, Small, Large	39
	5. Crossover	40, 50, 60, 80, 100, 120, 150, 200 Hz	39
	6. Double Bass	Off, On	39
2. Sp Distance	1. Unit	Meters, feet	40
	2. Left	0.3–9.0 m in 0.3 m steps (1–30 ft. in 1-foot steps)	40
	3. Center	0.3–9.0 m in 0.3 m steps (1–30 ft. in 1-foot steps)	40
	4. Right	0.3–9.0 m in 0.3 m steps (1–30 ft. in 1-foot steps)	40
	5. SurrRight	0.3–9.0 m in 0.3 m steps (1–30 ft. in 1-foot steps)	40
	6. SurrLef	0.3–9.0 m in 0.3 m steps (1–30 ft. in 1-foot steps)	40
	7. Subwoofer	0.3–9.0 m in 0.3 m steps (1–30 ft. in 1-foot steps)	40
3. Level Cal	1. Left	–12 dB to +12 dB in 1 dB steps	40
	2. Center	–12 dB to +12 dB in 1 dB steps	40
	3. Right	–12 dB to +12 dB in 1 dB steps	40
	4. SurrRight	–12 dB to +12 dB in 1 dB steps	40
	5. SurrLef	–12 dB to +12 dB in 1 dB steps	40
	6. Subwoofer	–15 dB to +12 dB in 1 dB steps	40
4. Audio Adjust	1. Input(Mux)	Main, Sub, M/S	40
	2. Input(Mono)	L, R, L+R	40
	3. Panorama	Off, On	41
	4. Dimension	–3 to +3	41
	5. Center Width	0–7	41
	6. Center Image	0–5	41
	7. EX.BASS	Off, On	41
	8. LstnAngl	Narrow, Middle, Wide	41
	9. Front 5.1ch	No, Yes	42
5. Source Setup	1. IntelliVol	–12 dB to +12 dB in 1 dB steps	42
	2. A/V Sync	0, 10 to 100 ms	42
	3. M.Optimizer	Off, On	42
6. Volume Setup	1. Max Volume	30 to 79, Off	43
	2. Pon Volume	Last, 1 to 79, Max	43
7. HDMI Setup	1. AudioTV Out	Off, On, Auto	43
	2. LipSync	Disable, Enable	43
	3. HDMIControl	Off, On	43
	4. ARC	Off, Auto	44
	5. Pow Control	Off, On	44
	6. TV Ctrl	Off, On	44
8. AutoPowerDown	1. AutoPowDown	Off, On	45

On-screen Setup Menus

The onscreen setup menus appear on the TV connected to the HDMI OUT.

Note:

- The onscreen setup menus can be displayed only when the video input signal is 480p, 576p, 720p, 1080i, or 1080p, or when no video signal present.

Setup Menu		
1. Sp Config	Subwoofer	Yes
2. Sp Distance	Front	Small
3. Level Cal	Center	None
4. Audio Adjust	Surround	None
5. Source Setup	Crossover	150Hz
6. Volume Setup	Double Bass	On
7. HDMI Setup		
8. AutoPowerDown		

Changing Settings

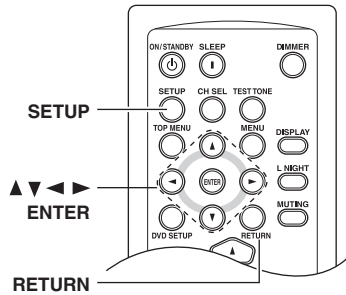

Use the following procedure to change the settings explained below.

1 Press the [SETUP] button.

2 Use the Up [▲] and Down [▼] buttons to select an item on the main menu, then press [ENTER].

3 Use the Up [▲] and Down [▼] buttons to select a setting on the submenu, then press [ENTER].

4 Use the Left [◀] and Right [▶] buttons to adjust the setting. Use the Up [▲] and Down [▼] buttons to select other settings. Press the [RETURN] button to return to the main menu.

5 When you've finished, press the [SETUP] button to quit setup.

Sp Config (Speaker Configuration)

With the Speaker Configuration, you can specify how many speakers you're using.

Note:

- Before you change this setting, turn down the volume.

■ Subwoofer

► Yes:

Select if a subwoofer is used (default).

► No:

Select if no subwoofer is used.

■ Front

► Small:

Select if the front speakers are small (default).

► Large:

Select if the front speakers are large.

Note:

- If the Subwoofer setting is set to No, this setting is fixed at Large and does not appear.

■ Center

► Small:

Select if the center speaker is small.

► Large:

Select if the center speaker is large.

► None:

Select if no center speaker is connected (default).

Note:

- If the Front setting is set to Small, the Large option cannot be selected.

■ Surround

► Small:

Select if the surround speakers are small.

► Large:

Select if the surround speakers are large.

► None:

Select if no surround speakers are connected (default).

Note:

- If the Front setting is set to Small, the Large option cannot be selected.

■ Crossover

This setting only applies to the speakers that you specified as **Small**.

To get the best bass performance from your speaker system, you need to set the crossover frequency according to the size and frequency response of your speakers.

Use the diameter of the smallest speaker in your system when choosing the crossover frequency.

Speaker cone diameter	Crossover frequency
Over 8 in. (20 cm)	40/50/60Hz*
6-1/2 to 8 in. (16–20 cm)	80Hz
5-1/4 to 6-1/2 in. (13–16 cm)	100Hz
3-1/2 to 5-1/4 in. (9–13 cm)	120Hz
Under 3-1/2 in. (9 cm)	150Hz (default)/200Hz*

* Choose the setting suitable for the speaker.

Notes:

- For a more accurate setting, look up the frequency response in the manuals supplied with your speakers and set accordingly.
- Choose a higher crossover frequency if you want more sound from your subwoofer.

■ Double Bass

With the Double Bass function, you can boost bass output by feeding bass sounds from the front left, right, and center channels to the subwoofer.

► On:

Double Bass function on. Bass from the front left and right channels is also fed to the subwoofer (default).

► Off:

Double Bass function off.

Note:

- If the Subwoofer setting is set to No, or the Front setting is set to Small, this setting does not appear.

Sp Distance (Speaker Distance)

With the Speaker Distance settings, you can specify the distances from the speakers to your listening position.

■ Unit

► feet:

Distances can be set in feet. Range: 1 to 30 feet in 1-foot steps.

► meters:

Distances can be set in meters. Range: 0.3 to 9 meters in 0.3-meter steps.

On North American models, the default setting is feet. On other models, it's meters.

■ Front, Center, SurrRight (Surround Right), SurrLef (Surround Left), Subwoofer

Speakers set to No or None in the Speaker Configuration on page 39 cannot be selected. The default value is 0.

Notes:

- The Center and Subwoofer distances can be set up to 5 ft. (1.5 m) more or less than the Front distance. For example, if the Front distance is set to 20 ft. (6 m), the Center and Subwoofer distances can be set between 15 and 25 ft. (4.5 and 7.5 m).
- The Surround distance can be set up to 5 ft. (1.5 m) more or 15 ft. (4.5 m) less than the Front distance. For example, if the Front distance is set to 20 ft. (6 m), the Surround distance can be set between 5 and 25 ft. (1.5 and 7.5 m), and if the Front distance is set to 10 ft. (3 m), they can be set between 1 and 15 ft. (0.3 and 4.5 m).

Level Cal (Level Calibration)

With the Level Calibration settings, you can adjust the volume of each speaker so that all speakers can be heard equally at your listening position.

■ Left, Center, Right, SurrRight (Surround Right), SurrLef (Surround Left), Subwoofer

The levels can be adjusted from -12 to +12 dB in 1 dB steps (-15 to +12 dB for the subwoofer). The default value is 0.

Notes:

- Speakers set to No or None in the Speaker Configuration on page 39 cannot be selected.
- When you play source material that contains no information in the LFE (Low Frequency Effects) channel, the subwoofer will produce no sound.
- These levels can also be adjusted by using the [TEST TONE] button on the remote controller. Press the [TEST TONE] button to output the test tone. Use the [CH SEL] button to select each speaker, and use the Left and Right [◀]/[▶] buttons to adjust the level. The dB indicator flashes while the levels are being adjusted.

Audio Adjust

With the Audio Adjust settings, you can adjust the sound and listening modes as you like.

■ Input (Mux)

This setting determines which channel of a stereo multiplex source is output. Use it to select audio channels or languages with multiplex sources, multilingual TV broadcasts, and so on.

► Main:

The main channel is output (default).

► Sub:

The sub channel is output.

► M/S:

Both the main and sub channels are output.

■ Input (Mono)

This setting determines which channel is output when the Mono listening mode is used with a stereo source.

► L+R:

Both the left and right channels are output (default).

► L:

Only the left channel is output.

► R:

Only the right channel is output.

■ Panorama

With this setting, you can broaden the width of the front stereo image when using the Dolby Pro Logic II listening mode.

▶ **On:**

Panorama function on.

▶ **Off:**

Panorama function off (default).

■ Dimension

With this setting, you can move the sound field forward or backward when using the Dolby Pro Logic II listening mode. It can be adjusted from -3 to +3. The default value is 0. Higher settings move the sound field backward. Lower settings move it forward.

If the stereo image feels too wide, or there's too much surround sound, move the sound field forward to improve the balance. Conversely, if the stereo image feels like it's in mono, or there's not enough surround sound, move it backward.

■ Center Width

With this setting, you can adjust the width of the sound from the center speaker when using the Dolby Pro Logic II listening mode. Normally, if you're using a center speaker, the center channel sound is output by only the center speaker. (If you're not using a center speaker, the center channel sound will be distributed to the front left and right speakers to create a phantom center). This setting controls the front left, right, and center mix, allowing you to adjust the weight of the center channel sound. It can be adjusted from 0 to 7. The default value is 3.

■ Center Image

With this setting, you can specify by how much the front left and right channel output is attenuated in order to create the pseudo center channel.

A setting of 0 produces the strongest sense of a center channel, which can be useful when your listening position is not central. Higher settings produce a more faithful stereo image. The default value is 2.

■ EX. BASS

Through experiment and listening tests, EX. BASS technology was developed to provide a more natural and deeper bass. It offers a more dynamic and deeper presence with movies and music.

▶ **Off:**

EX. BASS off.

▶ **On:**

EX. BASS on (default).

■ LstnAngl (Listening Angle)

With this setting, you can optimize the Theater-Dimensional listening mode by specifying the angle of the front left and right speakers relative to your listening position. Ideally, the front left and right speakers should be equidistant from your listening position and at an angle close to one of the two available settings.

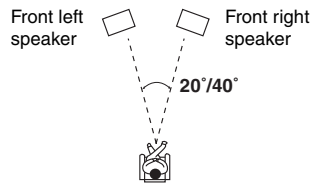

▶ **Narrow:**

Select if the listening angle is 20 degrees.

▶ **Middle:**

Select if the listening angle is 30 degrees (default).

▶ **Wide:**

Select if the listening angle is 40 degrees.

■ Front 5.1ch

With this setting, you can specify how your five surround speakers (front L/R, center, and surround L/R) are arranged to get the best effect from the Theater-Dimensional listening mode.

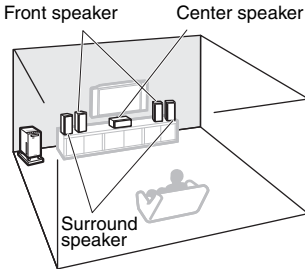

► Yes:

Select this if you've arranged your five speakers so that they are all at the front.

► No:

Select this if you're using the normal arrangement for five surround sound speakers (default).

Note:

- This setting is available only when the Speaker Configuration settings Center and Surround are set to None (see page 39).

Source Setup

This section explains items on the Source Setup menu. Items can be set individually for each input selector.

■ IntelliVol (IntelliVolume)

With IntelliVolume, you can set the input level for each input selector individually. This is useful if one of your source components is louder or quieter than the others.

Use the Left and Right [◀]/[▶] buttons to set the level.

If a component is noticeably louder than the others, use the Left [◀] button to reduce its input level. If it's noticeably quieter, use the Right [▶] button to increase its input level. The input level can be adjusted from -12 dB to +12 dB in 1 dB steps. The default value is 0.

Note:

- The dB indicator flashes while the level is being adjusted.

■ A/V Sync

When using your Blu-ray/DVD player/recorder's progressive scanning function, you may find that the picture and sound are out of sync. With the A/V Sync setting, you can correct this by applying a delay to the audio signal. The delay can be set from 0 to 100 milliseconds (msec) in 10 millisecond steps. The default value is 0.

Use the Left and Right [◀]/[▶] buttons to set the delay.

For components that support Lip Sync, a corrective delay time is applied by the Lip Sync function (see page 43).

Note:

- A/V Sync is disabled when the Direct listening mode is used with an analog input source.

■ M.Optimizer (Music Optimizer)

The Music Optimizer function enhances the sound quality of compressed music files. Use it with music files that use "lossy" compression, such as MP3.

► Off:

Music Optimizer off (default).

► On:

Music Optimizer on.

Note:

- The Music Optimizer function only works with PCM digital audio input signals with a sampling rate below 48 kHz and analog audio input signals. The Music Optimizer is disabled when the Direct listening mode is selected.

Volume Setup

This section explains items on the Volume Setup menu.

■ MaxVolume

With this setting, you can limit the maximum volume.

The Maximum Volume range is Off, 79 to 30. The default value is Off.

■ Pon Vol (Power on Volume)

This setting determines what the volume will be each time the HTX-22HDX is turned on. The range is Last, Min, 1 to 79, Max. The default value is Last.

To use the same volume level as when the HTX-22HDX was last turned off, select Last.

Note:

- The Power On Volume setting cannot be set higher than the Maximum Volume setting.

HDMI Setup

This section explains items on the HDMI Setup menu.

■ Audio TV Out

This setting determines whether audio received by an HDMI input is output by the HDMI OUT. You may want to change this setting to On if your TV is connected to the HDMI OUT and you want to listen to audio from an HDMI component through your TV's speakers instead of the HTX-22HDX's speakers. Normally, this should be set to Off.

▶ Off:

HDMI audio is not output (default).

▶ On:

HDMI audio is output.

Notes:

- If On is selected and the signal can be output by the TV, the HTX-22HDX's speakers will output no sound.
- When TV Control is set to On, this setting is set to Auto.
- With some TVs and input signals, no sound may be output even if On is selected.

- When the Audio TV Out setting is set to On, or TV Control is set to On, and you're listening through your TV's speakers (see page 19), if you turn up the volume on the HTX-22HDX, the sound will be output by the HTX-22HDX's speakers. To stop the HTX-22HDX's speakers producing sound, change the settings, change your TV's settings, or turn down the HTX-22HDX's volume.

■ Lip Sync

The Lip Sync function can automatically synchronize HDMI audio and video that's gotten out of sync due to the complex digital video processing being performed by your HDMI-compatible TV. With HDMI Lip Sync, the audio delay required to synchronize the audio and video is calculated and applied automatically by the HTX-22HDX.

▶ Disable:

HDMI lip sync disabled (default).

▶ Enable:

HDMI lip sync enabled.

Notes:

- This function works only if your HDMI-compatible TV supports HDMI Lip Sync.
- You can check the amount of delay being applied by the HDMI Lip Sync function on the A/V Sync screen (see page 43).

■ HDMI control

This function allows **RIHD**-compatible components connected via **RIHD** to be controlled with the HTX-22HDX.

▶ Off:

RIHD disabled (default).

▶ On:

RIHD enabled.

Notes:

- When you change this setting to On and close the Setup menu, the names of connected **RIHD**-compatible components and "RIHD On" are displayed on the HTX-22HDX.

“Search...” → “(name)” → “RIHD On”

If the HTX-22HDX cannot receive the name of a component, it will be displayed as “Player*” or “Recorder*”, etc (“*” will be a number when there’s two or more components).

- Select Off if a connected component is incompatible or you’re not sure about its compatibility.
- If operation is unreliable when set to On, select Off instead.
- When the Audio TV Out setting is set to On, or TV Control is set to On, and you’re listening through your TV’s speakers (see page 19), if you turn up the volume on the HTX-22HDX, the sound will be output by the HTX-22HDX’s speakers. To stop the HTX-22HDX’s speakers producing sound, change the settings, change your TV’s settings, or turn down the HTX-22HDX’s volume.
- See “Using an **RIHD**-compatible TV, Player, or Recorder” on page 53.

■ ARC (Audio Return Channel)

With the Audio Return Channel (ARC), the audio output from an HDMI (version 1.4) TV can be sent to the HTX-22HDX via its HDMI OUT. To use ARC, your TV must support ARC, and you must select the ARC (TV) input on the HTX-22HDX.

► Off:

ARC off. Select this if your TV doesn’t support ARC.

► Auto:

Your TV’s audio output can be sent digitally to HTX-22HDX via its HDMI OUT (default).

The ARC (TV) input source is available only if your TV supports ARC and Auto is selected.

When using ARC, to listen to the audio from your TV through the HTX-22HDX, use the input selector to select ARC (TV). If your TV is set to an input other than HDMI, ARC (TV) will be selected automatically.

Notes:

- This setting can be changed only when the HDMI Control setting is set to On.
- Auto is selected automatically when the HDMI Control setting is set to On.

■ Pow Control (Power Control)

To link the power functions of **RIHD**-compatible components connected via HDMI, select Enable.

► Off:

Power Control disabled.

► On:

Power Control enabled (default).

Notes:

- The Power Control setting can be set only when the HDMI control setting is set to On.
- HDMI power control only works with **RIHD**-compatible components that support it and may not work properly with some components due to their settings or compatibility.
- When set to On, the HTX-22HDX consumes more power when on Standby.
- When set to On, and the HTX-22HDX is on Standby, the HDMI Thru indicator lights up orange when audio and video received by an HDMI input is being output as it is by the HDMI OUT.
- Standby power consumption will increase during HDMI pass through. However, power consumption is reduced in the following cases:
 1. When your TV is on Standby.
 2. When you’re watching TV.

■ TV Ctrl (TV Control)

Select On to control the HTX-22HDX from an **RIHD**-compatible TV connected via HDMI.

► Off:

TV Control disabled.

► On:

TV Control enabled (default).

Notes:

- Select Off if your TV is incompatible or you're not sure about its compatibility.
- The TV Control setting can be set only when the above Control and Power Control settings are both set to On.

Note:

- After changing the Control, Power Control, or TV Control setting, be sure to turn all of your components off and then back on again. Refer to the instruction manuals for your other components.

Auto Power Down

With Auto Power Down, you can set the HTX-22HDX so that it automatically switches to Standby if there's no input signal or operation for about 2 hours.

► Off:

Auto Power Down off.

► On:

Auto Power Down on.

On North American models, the default setting is Off. On other models, it's On.

Note:

- When Auto Power Down is set to On, even if an input signal is present, if the level of that input signal is very low, the HTX-22HDX may switch to Standby after about 2 hours.

Specifying the Digital Signal Format

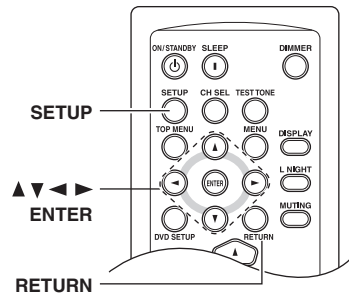

Normally, the HTX-22HDX detects the format of digital input signals automatically. However, if you experience either of the following issues when playing PCM or DTS sources, you can specify the signal format manually.

- If the beginnings of tracks from a PCM source are cut off, try the PCM setting.
- If noise is produced when fast forwarding or rewinding a DTS CD, try the DTS setting.

1 With a PCM or DTS input source selected, press and hold the [SETUP] button for 3 seconds until "Fixed Mode: Auto" appears on the display.

2 While "Fixed Mode: Auto" is displayed (about 3 seconds), press the Left or Right [◀]/[▶] button repeatedly to select: PCM, DTS, or Auto.

PCM: Only 2-channel PCM format input signals will be heard. If the input signal is not PCM, the PCM indicator will flash and there will be no sound.

DTS: Only DTS format input signals (excluding DTS-HD) will be heard. If the input signal is not DTS, the DTS indicator will flash and there will be no sound.

Auto (default):

All digital input signals can be heard.

Troubleshooting

If you have any trouble using the HTX-22HDX, look for a solution in this section. If you can't resolve the issue yourself, contact your Onkyo dealer.

Before you contact your Onkyo dealer, try resetting the HTX-22HDX, as follows:

To reset the HTX-22HDX to its factory defaults, turn it on and, while holding down the [LISTENING MODE] button, press the [ON/STANDBY] button. "Clear" will appear on the display and the HTX-22HDX will enter Standby mode.

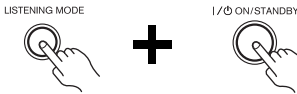

Note that resetting the HTX-22HDX will delete all of your custom settings.

Power

Can't turn on the HTX-22HDX

- Make sure that the power cord is plugged into the wall outlet properly.
- Unplug the power cord from the wall outlet, wait 5 seconds or more, then plug it back in again.

Audio

There's no sound or it's very quiet

- Make sure you've selected the appropriate input (page 28).
- Check the volume (page 28). The HTX-22HDX is designed for home theater enjoyment and has a wide volume range for precise adjustment.
- Make sure that all audio connecting plugs are pushed in all the way (page 18).
- Make sure that the cables are properly connected to the output jacks on the source component.
- Make sure that the polarity of the speaker cables is correct, and that the bare wire is in contact with the metal part of each speaker terminal (page 16).

- Make sure that the speaker cables are not shorting.
- Check the digital audio output settings on the source component. On some game consoles, such as those that can play DVDs, the default setting is off.
- With some DVD-Video discs, you need to select an audio format from a menu or with the AUDIO button on your Blu-ray/DVD player/recorder's remote controller.
- If your turntable doesn't have a phono preamp built-in, you must connect one between it and the HTX-22HDX.
- If your turntable uses an MC cartridge, you must connect an MC head amp, or an MC transformer and a phono preamp.
- Check the speaker configuration (page 39).
- If there's no sound from a Blu-ray/DVD player/recorder connected to an HDMI IN, check its output settings, and be sure to select a compatible audio format.

Only the front speakers produce sound

- When the Stereo or Mono listening mode is selected, only the front speakers and sub-woofer produce sound.
- Check the Speaker Configuration (page 39).

Only the center speaker produces sound

- If you use the Dolby Pro Logic II listening mode with a mono source, such as an AM radio station or mono TV program, the sound will be concentrated in the center speaker.
- Check the Speaker Configuration (page 39).

The center speaker produces no sound

- When the Stereo or Mono listening mode is selected, the center speaker produces no sound.
- Check the Speaker Configuration (page 39).

The surround speakers produce no sound

- When the Stereo or Mono listening mode is selected, the surround speakers produce no sound.
- Depending on the source and the current listening mode, not much sound may be produced by the surround speakers. Try another listening mode (page 32).
- Check the Speaker Configuration (page 39).

The subwoofer produces no sound

- If the source material contains no audio in the LFE channel, the subwoofer produces no sound.
- Check the Speaker Configuration (page 39).

There's no sound with a certain signal format

- Check the digital audio output setting on the source component. On some game consoles, such as those that can play DVDs, the default setting is off.
- With some DVD-Video discs, you need to select an audio format from a menu or with the AUDIO button on your Blu-ray/DVD player/recorder's remote controller.

The volume cannot be set to 79

- Check to see if a maximum volume has been set (page 43).
- When the levels of each speaker have been adjusted (page 40), the maximum possible volume may be reduced.

Noise can be heard

- Using cable ties to bundle audio cables with power cords, speaker cables, and so on can degrade audio performance, so don't use them.
- An audio cable may be picking up interference. Try repositioning your cables.

The Late Night function doesn't work

- Make sure that the source is Dolby Digital or Dolby TrueHD (page 36).

About DTS signals

- When playing DTS program material, using the pause, fast forward, or fast reverse function on your player may produce a short audible noise. This is not a malfunction.
- When DTS program material ends and the DTS bitstream stops, the HTX-22HDX remains in DTS listening mode and the DTS indicator remains on. This is to prevent noise when you use the pause, fast forward, or fast reverse function on your player. If you switch your player from DTS to PCM, as the HTX-22HDX does not switch formats immediately, you may not hear anything, in which

case you should stop your player for about 3 seconds, and then resume playback.

- With some CD players, you won't be able to playback DTS material properly even though your player is connected to a digital input on the HTX-22HDX. This is usually because the DTS bitstream has been processed (e.g., output level, sampling rate, or frequency response changed) and the HTX-22HDX doesn't recognize it as a genuine DTS signal. In such cases, you may hear noise.

The beginning of audio received by an HDMI IN can't be heard

- Since it takes longer to identify the format of an HDMI signal than it does for other digital audio signals, sound may not be output immediately.

Remote Controller

The remote controller doesn't work

- Make sure that the batteries are installed with the correct polarity (page 12).
- Make sure that the remote controller is not too far away from the HTX-22HDX and there's no obstruction between the remote controller and the HTX-22HDX's remote control sensor (page 12).

Can't control other components

- To control an Onkyo RI-capable component or RI Dock with iPod that's connected with **RI**, remember to point the remote controller at the HTX-22HDX, not the other device.

Others

How do I change the language of a multiplex source?

- On the Audio Adjust menu, change the Input (Mux) setting to Main or Sub (page 40).

The RI functions don't work

- To use **RI**, you must make an **RI** connection and an analog audio connection (RCA) between the component and HTX-22HDX, even if they are connected digitally (page 23).

Troubleshooting—Continued

The HTX-22HDX contains a microcomputer for signal processing and control functions. In very rare situations, severe interference, noise from an external source, or static electricity may cause it to lockup. In the unlikely event that this happens, unplug the power cord from the wall outlet, wait at least 5 seconds, and then plug it back in again.

Onkyo is not responsible for damages (such as CD rental fees) due to unsuccessful recordings caused by this unit's malfunction. Before you record important data, make sure that the material will be recorded correctly.

Before disconnecting the power cord from the wall outlet, set the HTX-22HDX to Standby.

HDMI (High-Definition Multimedia Interface)

About HDMI

Designed to meet the increased demands of digital TV, HDMI (High Definition Multimedia Interface) is a new digital interface standard for connecting TVs, projectors, Blu-ray/DVD player/recorder, set-top boxes, and other video components. Until now, several separate video and audio cables have been required to connect AV components. With HDMI, a single cable can carry control signals, digital video, and up to eight channels of digital audio (2-channel PCM, multichannel digital audio, or multichannel PCM).

The HDMI video stream (i.e., video signal) is compatible with DVI (Digital Visual Interface),*¹ so TVs and displays with a DVI input can be connected by using an HDMI-to-DVI adapter cable. (This may not work with some TVs and displays, resulting in no picture.)

The HTX-22HDX uses HDCP (High-bandwidth Digital Content Protection), so only HDCP-compatible components will display a picture.

The HTX-22HDX's HDMI interface is based on the following:

Audio Return Channel, 3D, x.v.Color, Deep Color, Lip Sync, DTS-HD Master Audio, DTS-HD High Resolution Audio, Dolby TrueHD, Dolby Digital Plus, DSD, and Multichannel PCM.

Supported Audio Functionality

- Audio Return Channel in HDMI Version 1.4
- 2-channel linear PCM (32–192 kHz, 16/20/24 bit)
- Multichannel linear PCM (up to 7.1 ch, 32–192 kHz, 16/20/24 bit)
- Bitstream (DSD, Dolby Digital, Dolby Digital Plus, Dolby TrueHD, DTS, DTS-HD High Resolution Audio, DTS-HD Master Audio)

Your Blu-ray/DVD player must support HDMI output of these audio formats to use them.

About Copyright Protection

The HTX-22HDX supports HDCP (High-bandwidth Digital Content Protection),*² a copy-protection system for digital video signals. Other devices connected to the HTX-22HDX via HDMI must also support HDCP.

Use a commercially available HDMI cable (supplied with some components) to connect the HTX-22HDX's HDMI OUT to the HDMI input on your TV or projector.

*¹ DVI (Digital Visual Interface): The digital display interface standard set by the DDWG*³ in 1999.

*² HDCP (High-bandwidth Digital Content Protection): The video encryption technology developed by Intel for HDMI/DVI. It's designed to protect video content and requires a HDCP-compatible device to display the encrypted video.

*³ DDWG (Digital Display Working Group): Led by Intel, Compaq, Fujitsu, Hewlett Packard, IBM, NEC, and Silicon Image, this open industry group's objective is to address the industry's requirements for a digital connectivity specification for high-performance PCs and digital displays.

Audio Return Channel (ARC)

With the Audio Return Channel (ARC), the audio output from an HDMI (1.4) TV can be sent to the HTX-22HDX via its HDMI OUT, so you can listen to the audio from your TV through the HTX-22HDX. You'll need to select the ARC (TV) input on the HTX-22HDX to do this. To use ARC, your TV must support ARC. If it doesn't, the ARC setting will be fixed at Off (see page 44).

HDMI (High-Definition Multimedia Interface)—*Continued*

Notes:

- The HDMI video stream is compatible with DVI (Digital Visual Interface), so TVs and displays with a DVI input can be connected by using an HDMI-to-DVI adapter cable. (Note that DVI connections only carry video, so you'll need to make a separate connection for audio.) However, reliable operation with such an adapter is not guaranteed. In addition, video signals from a PC are not supported.
- The HDMI audio signal (sampling rate, bit length, etc.) may be restricted by the connected source component. If the picture is poor or there's no sound from a component connected via HDMI, check its setup. Refer to the connected component's instruction manual for details.

Specifications

Subwoofer System with Built-in Amplifier (HTX-22HDXPAAW)

Type:	Bass-reflex with built-in amplifier
Rated Output Power (FTC):	5 ch (FL/FR/C/SL/SR) × 25 W at 6 ohms, 1 kHz, 1ch driven, THD 1% 1 ch (SW) × 47 W at 3 ohms, 100 Hz, 1ch driven, THD 1%
(IEC):	5 ch (FL/FR/C/SL/SR) × 25 W at 6 ohms, 1 kHz, 1ch driven, THD 1% 1 ch (SW) × 50 W at 3 ohms, 100 Hz, 1ch driven, THD 1%
Subwoofer Frequency Response:	35 Hz–200 Hz
Amp Frequency Response:	FL/FR: 10 Hz–100 kHz (Direct mode) FL/FR/C/SL/SR: 150 Hz–20 kHz, +1 dB–3dB SW: 20 Hz–150 Hz, +1 dB–3dB (Crossover at 150 Hz)
Input Sensitivity and Impedance:	150 mV/ 47 kΩ (FL/FR)
Signal to Noise Ratio:	105 dB (LINE1/LINE2, Direct mode, IHF-A)
Cabinet Capacity:	8.4 L (0.3 cubic feet)
Power Supply: North American	AC 120 V, 60 Hz
European	AC 230 V, 50 Hz
Power Consumption:	140 W
Standby Power Consumption:	
North American	0.2 W
Others	0.3 W
Dimensions (W × H × D):	217 × 337 × 310 mm (incl. grille and projections) 8-9/16" × 13-1/4" × 12-3/16"
Weight:	9.5 kg (21.0 lbs.)
Driver Unit:	16 cm (6-5/16") cone

■ HDMI

Input:	IN1, IN2, IN3
Output:	OUT
Video Resolution:	1080p
Audio Format:	Dolby TrueHD, DTS Master Audio, DVD-Audio, DSD
Supported:	3D, Audio Return Channel, Deep Color, x.v.Color, LipSync, CEC

■ Audio Inputs

Digital:	Optical: 2 Coaxial: 1
Analog:	LINE 1, LINE 2

■ Audio Outputs

Speaker Outputs:	FL, FR, C, SL, SR
------------------	-------------------

■ Others

RI:	1
-----	---

Specifications—Continued

Front Speaker (HTX-22HDXST)

Type:	Full range bass-reflex
Input Sensitivity/Impedance:	6 Ω
Maximum Input Power:	40 W
Output Sound Pressure Level:	80 dB/W/m
Frequency Response:	70 Hz–20 kHz
Cabinet Capacity:	1 L (0.036 cubic feet)
Dimensions (W \times H \times D):	101 \times 161 \times 111 mm (incl. grille and projections) 4" \times 6-5/16" \times 4-3/8"
Weight:	0.8 kg (1.76 lbs.)
Driver Unit:	8 cm (3-1/4") cone
Terminal:	Spring type
Other:	Magnetic shielding

Specifications and features are subject to change without notice.

Using an **RIHD**-compatible TV, Player, or Recorder

RIHD, which stands for Remote Interactive over HDMI, is the name of the system control function found on Onkyo components. The HTX-22HDX can be used with CEC (Consumer Electronics Control), which allows system control over HDMI and is part of the HDMI standard. CEC provides interoperability between various components, however, operation with components other than **RIHD**-compatible components cannot be guaranteed.

■ About **RIHD**-compatible components

The following components are **RIHD**-compatible. (As of February 2010) See the Onkyo web site for latest information.

TV

- Panasonic VIERA Link compatible TV
- Toshiba REGZA-LINK compatible TV
- Sharp TV (See Onkyo web site for latest information on compatible models.)

Players/Recorders

- Onkyo and Integra **RIHD**-compatible players
- Panasonic VIERA Link compatible players and recorders (only when used together with Panasonic VIERA Link compatible TV)
- Toshiba REGZA-LINK compatible players and recorders (only when used together with Toshiba REGZALINK compatible TV)
- Sharp players and recorders (only when used together with Sharp TV)

* Models other than those mentioned above may have some interoperability if compatible with CEC which is part of the HDMI Standard, but operation cannot be guaranteed.

Note:

- Do not connect the HTX-22HDX to the other AV receiver/AV amplifier via HDMI.

■ Operations that can be performed with **RIHD** connection

For **RIHD**-compatible TV

The following linked operation is possible by connecting the HTX-22HDX to an **RIHD**-compatible TV.

- The HTX-22HDX will enter Standby mode when the power of the TV is turned to Standby.
- You can set on the menu screen of the TV to either output the audio from the speakers connected to the HTX-22HDX, or from the speakers of the TV.
- It is possible to output the video/audio from the antenna or from the input jack of the TV from the speakers connected to the HTX-22HDX. (A connection such as optical digital cable or similar is required above the HDMI cable.)
- Input to the HTX-22HDX can be selected with the remote controller of the TV.
- Operations such as volume adjustment or similar for the HTX-22HDX can be performed from the remote controller of the TV.

For **RIHD**-compatible players/recorders

The following link operation is possible by connecting the HTX-22HDX to an **RIHD**-compatible player/recorder.

- When the playback is started on the player/recorder, input of the HTX-22HDX will switch to the HDMI input of the player/recorder that is playing back.
- Operation of the player/recorder is possible with the remote controller supplied with the HTX-22HDX.

* Not all functions may operate depending on the model.

■ Connections and Set Up

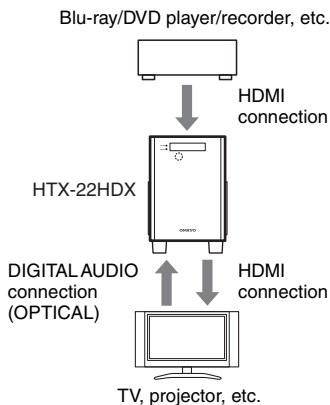

1 Connect the **HDMI OUT** jack to the **HDMI input** jack of the TV.

2 Connect the audio output from the TV to the **DIGITAL OPTICAL IN 3** jack of the HTX-22HDX using an optical digital cable.

Note:

- If you're using a TV that supports Audio Return Channel (ARC), ignore this step.

3 Connect the **HDMI output** of the Blu-ray/DVD player/recorder to the **HDMI IN 1** jack of the HTX-22HDX.

4 Set the following settings in **HDMI Setup**:

- **HDMI Control**: On (page 43)
- **ARC (Audio Return Channel)**: Auto (page 44)
- **Pow Control (Power Control)**: On (page 44)
- **TV Ctrl (TV Control)**: On (page 44)

5 Confirm the settings.

1. Turn on the power for all connected components.
2. Turn off the power of the TV, and confirm that the power of the con-

nected components is turned off automatically with the link operation.

3. Turn on the power of the Blu-ray/DVD player recorder.
4. Start playback of the Blu-ray/DVD player/recorder, and confirm the following.
 - The power of the HTX-22HDX is turned on automatically, and input with the Blu-ray/DVD player/recorder connected is selected.
 - The power of the TV is turned on automatically, and input with the HTX-22HDX connected is selected.
5. Following the operating instructions of the TV, select "Use the TV speakers" from the menu screen of the TV, and confirm that the audio is output from the speakers of the TV, and not from the speakers connected to the HTX-22HDX.
6. Select "Use the speakers connected to the HTX-22HDX" from the menu screen of the TV, and confirm that the audio is output from the speakers connected to the HTX-22HDX, and not from the TV speakers.

Note:

- Perform the above operations when you initially use the HTX-22HDX, when the settings of each component are changed, when the main power of each component is turned off, when the power cable is disconnected from the power supply, or when there has been a power outage.

6 Operate with the remote controller.

See page 25 for buttons that can be used.

Notes:

- Audio from DVD-Audio or Super Audio CD may not output from the TV speakers. You will be able to output the audio from the TV speakers by setting the audio output of the DVD player to 2ch PCM. (It may not be possible depending on the player models.)

Using an **RIHD**-compatible TV, Player, or Recorder—Continued

- Even if you set to output audio on the TV speakers, audio will be output from the speakers connected to the HTX-22HDX when you adjust the volume or switch the input on the HTX-22HDX. To output audio from the TV speakers, re-do the operations on the TV.
- Do not connect the **RI** cable when connecting to the **RIHD**-capable components.
- When you select anything other than the HDMI jack where the HTX-22HDX is connected as the input on the TV, the HTX-22HDX will switch to the input that's assigned to the TV input display, for example, "DIG3 (TV)."
- The HTX-22HDX will automatically power on in conjunction when it determines it to be necessary. Even if the HTX-22HDX is connected to an **RIHD** compatible TV or player/recorder, it will not power on if it is not necessary. It may not power on in conjunction when the TV is set to output audio from the TV.
- Linked functions with the HTX-22HDX may not work depending on the model. Operate the HTX-22HDX directly in such cases.
- If you cannot control a player or recorder over **RIHD** with the HTX-22HDX's remote controller, it may be that the component does not support remote control over **RIHD** or CEC.

ONKYO CORPORATION

Sales & Product Planning Div. : 2-1, Nisshin-cho, Neyagawa-shi, OSAKA 572-8540, JAPAN
Tel: 072-831-8023 Fax: 072-831-8163

ONKYO U.S.A. CORPORATION

18 Park Way, Upper Saddle River, N.J. 07458, U.S.A.
Tel: 800-229-1687, 201-785-2600 Fax: 201-785-2650 <http://www.us.onkyo.com/>

ONKYO EUROPE ELECTRONICS GmbH

Liegnitzerstrasse 6, 82194 Groebenzell, GERMANY
Tel: +49-8142-4401-0 Fax: +49-8142-4401-555 <http://www.eu.onkyo.com/>

ONKYO EUROPE ELECTRONICS GmbH (UK BRANCH)

The Coach House 81A High Street, Marlow, Buckinghamshire, SL7 1AB, UK
Tel: +44-(0)1628-473-350 Fax: +44(0)-1628-401-700

ONKYO CHINA LIMITED

Unit 1&12, 9/F, Ever Gain Plaza, Tower 1, 88, Container Port Road, Kwai Chung,
N.T., HONG KONG Tel: 852-2429-3118 Fax: 852-2428-9039
<http://www.ch.onkyo.com/>

11003-1

SN 29400185

(C) Copyright 2010 ONKYO CORPORATION Japan. All rights reserved.



* 2 9 4 0 0 1 8 5 *

Free Manuals Download Website

<http://myh66.com>

<http://usermanuals.us>

<http://www.somanuals.com>

<http://www.4manuals.cc>

<http://www.manual-lib.com>

<http://www.404manual.com>

<http://www.luxmanual.com>

<http://aubethermostatmanual.com>

Golf course search by state

<http://golfingnear.com>

Email search by domain

<http://emailbydomain.com>

Auto manuals search

<http://auto.somanuals.com>

TV manuals search

<http://tv.somanuals.com>