

Operating Instructions

Stereo Radio Cassette Player

MODEL NO. **RQ-V460/V520**



GN

Panasonic

Before connection, operating or adjusting this product, please read these instructions completely.

A

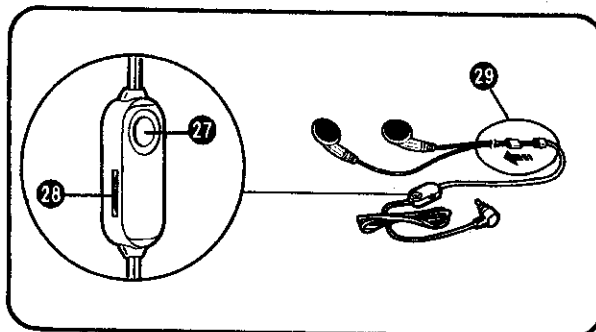
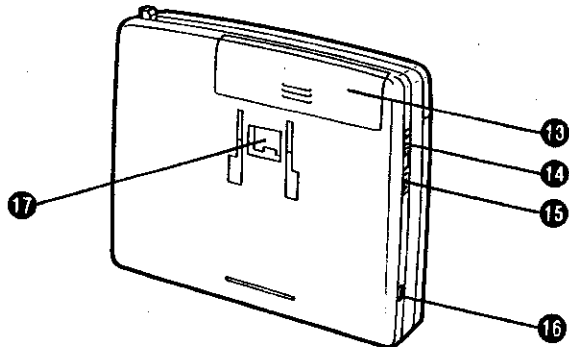
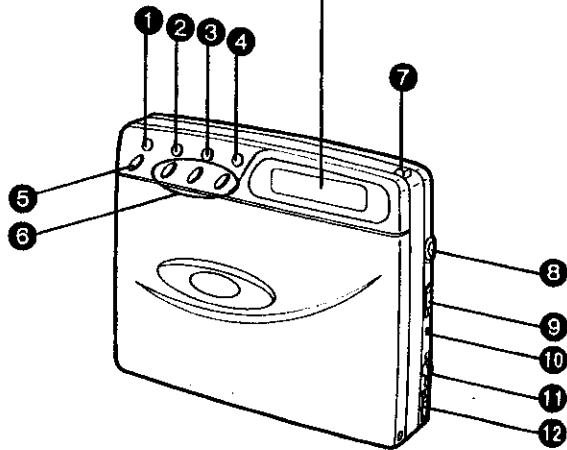
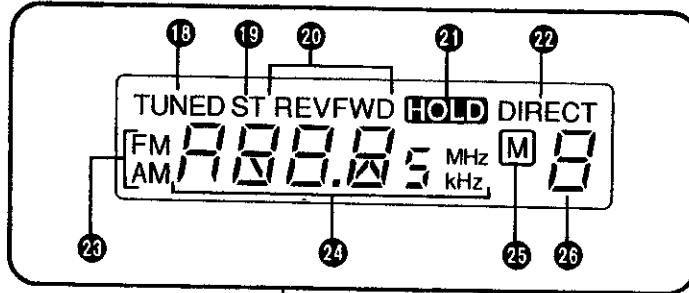

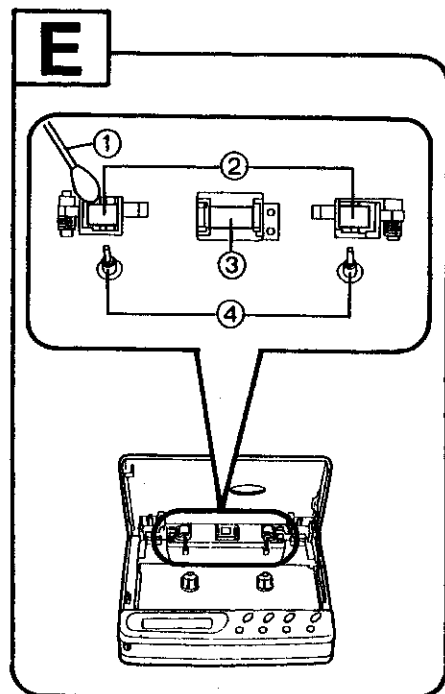
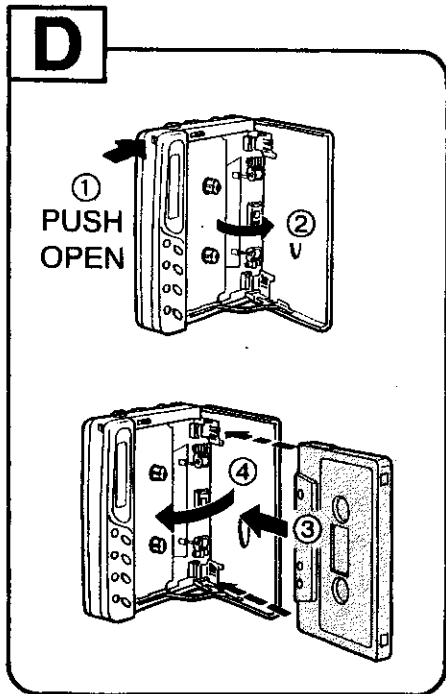
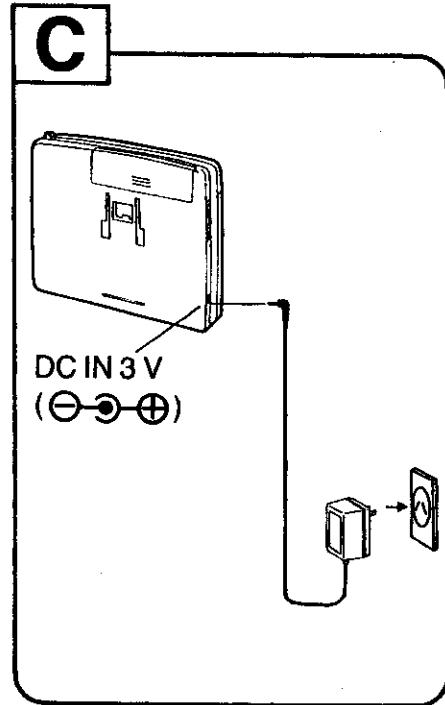
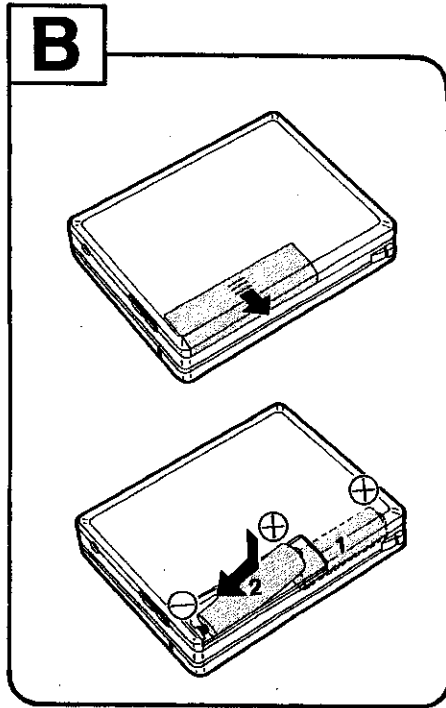

Thank you for purchasing this unit.
For optimum performance, follow these
operating instructions carefully.
(Please refer to the illustrations on page
2 to 3.)

Precautions

- Avoid using or placing this unit near sources of heat. Do not leave it in an automobile exposed to direct sunlight for a long period of time with the doors and windows closed, as this may deform the cabinet.
- When not in use, disconnect the AC adaptor from the AC mains supply.

Precautions for listening with the headphones

- Do not play your headset at a high volume. Hearing experts advise against continuous extended play.
- If you experience a ringing in your ears, reduce volume or discontinue use.
- Do not use while operating a motorized vehicle. It may create a traffic hazard and is illegal in many areas.
- You should use extreme caution or temporarily discontinue use in potentially hazardous situations.
- Even if your headset is an open-air type designed to let you hear outside sounds, don't turn up the volume so high that you can't hear what's around you.

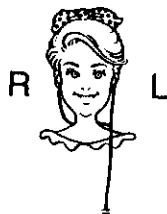

Stereo earphones (included)
The right earphone cord is longer than the left and is adjustable for your convenience.



Location of Controls

(Refer to )

The feature of RQ-V460 is different.

※Dolby noise reduction function and XBS switch are not provided for RQ-V460.

Tape operation

- ① Rewind button (REW)
- ② Fast forward button (FF)
- ③ Stop button (STOP ■)
- ④ Playback/direction button (PLAY/DIR ◀ ▶)
- ⑦ Push open button (PUSH OPEN)
- ⑧ Headphones jack ()
- ⑨* Dolby* noise reduction switch (DOLBY NR)
- ⑩ Operation/battery check indicator (OPR/BATT)
- ⑪ Volume control (VOLUME)
- ⑫* XBS switch (XBS)
- ⑬ Battery compartment cover
- ⑭ Reverse mode selector (REV MODE)
- ⑮ Hold switch (HOLD)
- ⑯ DC input jack (DC IN 3 V )
- ⑰ Belt clip receptacle

*Dolby noise reduction manufactured under license from Dolby Laboratories Licensing Corporation.

"DOLBY" and the double-D symbol  are trademarks of Dolby Laboratories Licensing Corporation.

Radio operation

- ① ② Tuning buttons (TUNING -, TUNING +)
- ③ Memory button (MEMORY)
- ④ Memory select/memory scan button
(•M. SELECT/-M. SCAN)
- ⑤ Radio on/off • band select button
(-OFF • ON RADIO, AM/FM BAND)
- ⑥ Direct tuning buttons (1, 2, 3)
- ⑭ FM mode selector (FM MODE)

Display section

- ⑱ Tuning indicator (TUNED)
- ⑲ Stereo indicator (ST)
- ⑳ Direction indicator (REV/FWD)
- ㉑ Hold indicator (HOLD)
- ㉒ Direct tuning indicator (DIRECT)
- ㉓ Band indicators (FM/AM)
- ㉔ Multi indicator
- ㉕ Memory indicator (M)
- ㉖ Memory channel indicator

Stereo earphones section

- ㉗ Remote control button
- ㉘ Volume control
- ㉙ Slider

When not in use, slide to prevent entanglement of the cord.

Power Source

Battery operation (Refer to [B].)

Install the two R6/LR6 size batteries (Panasonic UM-3 or equivalent not included) as shown in the figure.

To prevent possible damage to this unit

- Load new batteries with their polarities (\oplus and \ominus) aligned correctly.
- Do not apply heat to batteries, or internal short-circuit may occur.
- If this unit is not to be used for a long period of time, or used on AC power source, remove all batteries and store them in a cool and dry place.
- Remove used batteries immediately.
- Do not use old and new batteries together. Also never use an alkaline battery with a manganese battery.

Battery removal

Press battery "2" toward the \ominus battery terminal and remove it.

Battery life

When the batteries are weak, the OPR/BATT (operation/battery check) indicator will become dim or turn off during operation, and this unit will turn off to protecting the memorized contents.

Replace with new batteries. When replacing the batteries, replace them within 30 seconds. (If not, memorized contents will cancelled.)

When the power is turned off soon after increasing the volume, pressing the operation button or turning on the radio, replace the batteries.

AC Power operation (Refer to [C].)

Connect the AC adaptor (Use only Panasonic AC adaptor, RP-AC33, optional) as shown in the figure.

Note:

To operate on battery power, unplug the AC adaptor unit from the household AC power outlet and the DC input jack on the unit.

- If you leave the AC adaptor jack connected to the DC input jack while disconnecting the AC adaptor unit from the AC power outlet, the memorized contents for radio will be cleared.

When the battery indicator flashes and you wish to use the AC adaptor, be sure to connect the AC adaptor before removing the spent batteries.

Cassette Tapes

This unit is equipped with an auto tape select function, so you can use normal, CrO₂ or metal types of tape.

Notes:

- Cassette tapes, both recorded and unrecorded, should not be stored in locations with high temperature, high humidity or direct sunlight. Never place a recorded cassette near a magnetic source, such as a magnet or a TV set as this may affect tape performance.
- Do not use C-120 tapes with this unit because these tapes can easily become broken or stretched if not used with extreme care and may get tangled with the capstan and pressure roller.

Hold Operation

Setting the hold switch to "HOLD" position will hold the present condition, and reject the operation of the front panel buttons.

This is useful to prevent unexpected operation.

(The hold indicator will appear on the display.)

Before operating the front panel button, be sure to release the hold condition. (The hold indicator will disappear.)

Tape Playback

- 1. Press the push open button to open the cover.**
- 2. Insert the cassette.** (Refer to [D].)
After closing the cover, the tape slack will be wound automatically.
- 3. Release the hold state.**
The hold indication will disappear.
- 4. Press the playback/direction button and adjust the volume.**
The operation/battery indicator will light.
The play indication will come up on the display.
The direction indicator shows the direction of the running tape.
FWD=forward REV=reverse

To stop playback

Press the stop button.

Fast forward and rewind

This unit allows the tape to fast forward or rewind by simply pressing the fast forward or rewind button.

To fast forward the tape, press the fast forward button.

To rewind the tape, press the rewind button.

●When the tape reaches its end, the tape will automatically stop.

Auto play

Skip reverse

During playback, if you press the fast forward button, the tape is forwarded and the reverse playback will start from the beginning automatically.

Rewind auto play

During playback, if you press the rewind button, the tape is rewound and the playback will start from the beginning automatically.

Manual reverse

Select the playback side by pressing the playback/direction button during playback.

Auto reverse

When the tape comes to its end, the auto reverse system functions and the tape direction changes automatically to start playing the opposite side of the tape.

Set the reverse mode selector to the desired mode.

 : For playback of both sides of the cassette tape once.

Notes:

- Playback will stop when the end of reverse side is reached.

- If playback starts from the reverse side, only that side will be played.

 : For continuous playback of both sides of the cassette tape.

Note:

When the cassette compartment cover is opened or after the batteries are replaced, the playback will always start from the forward side.

XBS switch (RQ-V520)

XBS boosts the low frequency range.

You can enjoy the dynamic low sound.

Dolby noise reduction switch (RQ-V520)

This unit includes Dolby noise reduction which reduces the noise.

Set the Dolby noise reduction switch to "ON" to playback a tape recorded with Dolby noise reduction.

For other tapes, set the switch to "OFF".

Radio Reception

1. Release the hold state.

The hold indication will disappear.

2. Press the radio on/off • band select button to turn on the radio.

The frequency display will come up.

3. Press the radio on/off • band select button again to select the desired band.

The "AM" and "FM" will appear alternately.

4. Press the tuning button to tune in your favorite station.

Pressing either of the tuning buttons one by one makes the frequency display change. (AM step by 9 kHz, FM step by 0.05 MHz)

Repeat the pressing until the frequency of the desired station appears.

To turn off the radio

Press the radio on/off • band select button for more than 1 second.

Antenna

FM:

The earphones cord serves as the FM antenna, hence be sure to use it extended, not coiled.

AM:

The sensitive ferrite core antenna inside the set will provide excellent AM reception in most areas. For optimum reception, turn the set in the direction which gives the best results, since the ferrite core antenna is directional.

FM mode selector

To receive FM stereo broadcasts, set the FM mode selector to "STEREO". If reception is poor (excessive noise), set to "MONO". This will reduce the noise and provide clear reception; however, the broadcast will not be heard in stereo.

•When receiving the FM stereo broadcasts, the stereo indicator will appear.

**How to memorize the broadcasting station
To memorize into direct tuning buttons
(for direct tuning)**

6 stations FM and AM can be memorized.
(3 FM and 3 AM stations)

1. **Receive the station to be memorized.**
2. **Press the memory button.**
The memory indicator will flash on and off for 10 seconds.
3. **During flashing (for 10 seconds), press one of the direct tuning (1, 2 or 3) buttons to be memorized.**
(Three beeps will be emitted.)
The direct indicator and memory channel number will appear, and the memory indicator will light.

**To memorize into memory channels from 1 to 6
(For memory channel tuning)**

12 stations can be memorized (6 AM and 6 FM stations).

1. **Receive the station to be memorized.**
2. **Press the memory button.**
The memory indicator will flash on and off for 10 seconds.
3. **During flashing (for 10 seconds), press the memory select button to select the memory channel (1-6) to be memorized.**
The memory channel number will appear and each time the memory select button is pressed, the memory channel number will change from 1 to 6 and return.
4. **During flashing (for 10 seconds), press the memory button again to enter the memory.**
(Three beeps will be emitted.)
The memory indicator will light.

Note:

The previous memory will be cleared when the new memory is entered into the same memory channel.

How to tune in the memorized station

Direct tuning using the direct tuning buttons

1. Release the hold state.
2. Press the radio on/off-band select button.
3. Press the radio on/off-band select button to select the desired band.
4. Press one of the direct tuning buttons (1, 2 or 3) to receive your desired station.

Memory channel tuning

1. Release the hold state.
2. Press the radio on/off-band select button.
3. Select the desired radio band using the radio on/off-band select button.
4. Press the memory select button until the desired memory channel number appears.

Double beeps will be emitted when returns (1).

Memory scan

Once the stations have been preset into the memory buttons for channels 1 through 6, the programs of each of those stations can be heard for several seconds in turn simply by pressing the Memory Scan Button. This function comes in handy for checking out what kind of broadcasts are now being beamed by the preset stations.

1. Press the memory scan button for more than 1 second.
The channel will change in order 1→2→3→4→5→6→1→to each broadcasting for about a few seconds.
2. When your desired memory channel is displayed, press the memory scan button once again.

Last station recall

This memory functions when the radio is off. When the radio is turned on, the frequency received before it was turned off is tuned in again.

How to clear the unnecessary memory channels

You can clear the unnecessary memory channels for your convenience. (EX. 1→2→3→4→5→6)

cleared

1. Turn on the radio and recall the memory channel to be cleared.
2. Press the memory button.
The memory indicator will flash on and off for 10 seconds.
3. While the memory indicator flashes on and off, press both of the tuning buttons at one time.
The frequency display will disappear and "---" will appear instead.
4. Press the memory button.
The three beeps will be emitted.

Notes:

The "---" display cannot be memorized into the direct tuning buttons. If you press one of the direct tuning buttons after the "---" is displayed, five beeps will be emitted.

The cleared channels can be reset to a new station by performing the memorization procedure above.

Remote Control Operation

The operation can be changed, depending on how and how many times the remote control button is pressed in sequence.

Tape operation

In stop condition

Press once

...The playback will start.

In playback condition

To stop

...Press the button once.

To change the tape direction

...Press and hold the button for more than 1 second.

To fast forward*

...Press the button twice.

To rewind**

...Press the button three times.

In fast forward or rewind

To stop the operation and start playback

...Press the button once.

*If the tape is forwarded to the end of the tape, the playback will start from the reverse side automatically. (Skip reverse function)

**If the tape is rewound to the beginning of the tape, the playback will start from the same side automatically. (Rewind auto play function)

Notes:

- For volume adjustment, first set the volume control of the main unit to 5-7.
- When pressing the button twice or three times in succession, press it within one second and at equal intervals.

Radio operation

In stop condition

Press and hold for more than 1 second

...The radio will be turned on.

In radio operation

To turn off

...Press and hold for more than 1 second.

To change the memory channel

...Press once by once

(1→2→3→4→5→6)

↑

To change the receiving band

...Press twice by twice. (AM→FM)

↑

Remote Control Operation and Beeps

The beep (Pi) will be emitted each time the remote control button is pressed.

Also, confirmation beeps will be emitted after pressing to confirm the proper operation.

In tape operation

Operation	Beep	Confirmation beep	Function
Press once	Pi	—	Play
(during playback) Press twice	PIPI	PIPI	Fast forward (Skip reverse)
(during playback) Press three times	PIPIPI	PIPIPI	Rewind (Rewind auto play)
(during playback) Press and hold for more than one second	Pi	Pi	Change tape direction
(during playback) Press once	Pi	Pi...	Stop

In radio operation

The single beep (Pi) will be emitted when the power is turned on or off and the memory channel or the receiving band is changed. The double beeps (Pi Pi) will be emitted when the memory channel returns to first step (1) or the receiving band returns to "AM".

Maintenance (Refer to [E.] XXXXXXXXXX)

- | | |
|--------------------|------------|
| ① Cotton swab | ③ Head |
| ② Pressure rollers | ④ Capstans |

The head assembly, capstans, and pressure rollers are in constant contact with the tape. If these parts are dirty, the sound quality will be impaired. Periodically, clean these parts.

1. **Open the cassette compartment cover.**
2. **The playback head, capstans and the pressure rollers can be seen. Clean them with a cotton swab.**

Notes:

- If the head assembly is extremely dirty, clean it with a soft cloth dampened with a little alcohol.
- Do not bring metal articles or magnetic material, such as a screwdriver, near the head assembly.
- Do not clean the plastic cabinet with benzine or thinner. Clean it with a cloth, dampened in a mild solution of soap and water. Avoid excessive moisture.
- Avoid spray-type insecticides. Some insecticides contain chemicals that could cause cabinet deformation.

Belt Clip

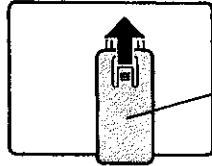

Belt clip
(included)

● To remove

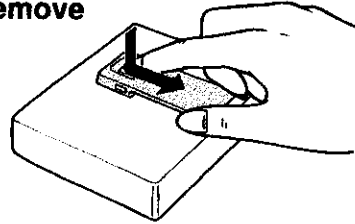

● Attaching
clip to
your belt

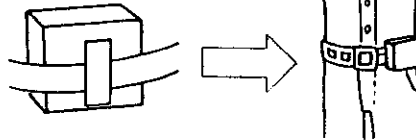

Specifications

Radio Frequency

Range: FM; 87.5–108 MHz
AM; 522–1611 kHz

Power Requirement: Battery; 3 V (two R6/LR6, UM-3 batteries)

AC; 240 V, 50 Hz with optional AC adaptor RP-AC33

Power Output: 30 mW (15 mW×2)...RMS (max.)

Frequency

Response: 30–18000 Hz (Normal, CrO₂/Metal)

Tape Speed: 4.8 cm/s

Jack:

Input; DC IN; 3 V

Output; HEADPHONES

Dimensions:

(W×H×D) 114×89.8×25.5 mm

Weight: 200 g without batteries

Design and specifications are subject to change without notice.

Matsushita Electric Industrial Co., Ltd.
Central P.O. Box 288, Osaka 530-91, Japan

RQT1125-L F0491D0

Printed in Japan

Free Manuals Download Website

<http://myh66.com>

<http://usermanuals.us>

<http://www.somanuals.com>

<http://www.4manuals.cc>

<http://www.manual-lib.com>

<http://www.404manual.com>

<http://www.luxmanual.com>

<http://aubethermostatmanual.com>

Golf course search by state

<http://golfingnear.com>

Email search by domain

<http://emailbydomain.com>

Auto manuals search

<http://auto.somanuals.com>

TV manuals search

<http://tv.somanuals.com>