

AV Control Receiver Operating Instructions

Model No. **SA-XR45**
SA-XR25



SA-XR45

Dear customer

Thank you for purchasing this product.
Before connecting, operating or adjusting this product, please read these instructions completely.
Please keep this manual for future reference.

SA-XR45 is used in the illustrations unless otherwise mentioned.



For U.S.A.

As an ENERGY STAR® Partner, Panasonic has determined that this product meets the ENERGY STAR® guidelines for energy efficiency.

Table of contents

Before use

IMPORTANT SAFETY INSTRUCTIONS	2
Listening caution	3
Supplied accessories	3
The remote control	4

Step 1

Speaker connections

4

Step 2

Equipment connections

6

Step 3

Settings

10

Step 4

Basic operations

14

Others

Control guide	16
The radio	19
Other settings	20
Other functions	21
Making a recording	21
Sleep timer	21

Reference

Troubleshooting guide	22
The RESET function	22
Maintenance	22
Warranty (U.S.A.)	23
Customer Services Directory (U.S.A.)	23
Specifications	Back cover
Product Service	Back cover

IMPORTANT SAFETY INSTRUCTIONS

Read these operating instructions carefully before using the unit. Follow the safety instructions on the unit and the applicable safety instructions listed below. Keep these operating instructions handy for future reference.

- 1) Read these instructions.
- 2) Keep these instructions.
- 3) Heed all warnings.
- 4) Follow all instructions.
- 5) Do not use this apparatus near water.
- 6) Clean only with dry cloth.
- 7) Do not block any ventilation openings. Install in accordance with the manufacturer's instructions.
- 8) Do not install near any heat sources such as radiators, heat registers, stoves, or other apparatus (including amplifiers) that produce heat.
- 9) Do not defeat the safety purpose of the polarized or grounding-type plug. A polarized plug has two blades with one wider than the other. A grounding-type plug has two blades and a third grounding prong. The wide blade or the third prong are provided for your safety. If the provided plug does not fit into your outlet, consult an electrician for replacement of the obsolete outlet.
- 10) Protect the power cord from being walked on or pinched particularly at plugs, convenience receptacles, and the point where they exit from the apparatus.
- 11) Only use attachments/accessories specified by the manufacturer.
- 12) Use only with the cart, stand, tripod, bracket, or table specified by the manufacturer, or sold with the apparatus. When a cart is used, use caution when moving the cart/apparatus combination to avoid injury from tip-over.
- 13) Unplug this apparatus during lightning storms or when unused for long periods of time.
- 14) Refer all servicing to qualified service personnel. Servicing is required when the apparatus has been damaged in any way, such as power-supply cord or plug is damaged, liquid has been spilled or objects have fallen into the apparatus, the apparatus has been exposed to rain or moisture, does not operate normally, or has been dropped.



	CAUTION RISK OF ELECTRIC SHOCK DO NOT OPEN	
<p>CAUTION: TO REDUCE THE RISK OF ELECTRIC SHOCK, DO NOT REMOVE SCREWS. NO USER-SERVICEABLE PARTS INSIDE. REFER SERVICING TO QUALIFIED SERVICE PERSONNEL.</p>		



The lightning flash with arrowhead symbol, within an equilateral triangle, is intended to alert the user to the presence of uninsulated "dangerous voltage" within the product's enclosure that may be of sufficient magnitude to constitute a risk of electric shock to persons.



The exclamation point within an equilateral triangle is intended to alert the user to the presence of important operating and maintenance (servicing) instructions in the literature accompanying the appliance.

THE FOLLOWING APPLIES ONLY IN THE U.S.A.

CAUTION:

This equipment has been tested and found to comply with the limits for a Class B digital device, pursuant to Part 15 of the FCC Rules.

These limits are designed to provide reasonable protection against harmful interference in a residential installation. This equipment generates, uses and can radiate radio frequency energy and, if not installed and used in accordance with the instructions, may cause harmful interference to radio communications. However, there is no guarantee that interference will not occur in a particular installation. If this equipment does cause harmful interference to radio or television reception, which can be determined by turning the equipment off and on, the user is encouraged to try to correct the interference by one or more of the following measures:

- Reorient or relocate the receiving antenna.
- Increase the separation between the equipment and receiver.
- Connect the equipment into an outlet on a circuit different from that to which the receiver is connected.
- Consult the dealer or an experienced radio/TV technician for help.

Any unauthorized changes or modifications to this equipment would void the user's authority to operate this device.

This device complies with Part 15 of the FCC Rules. Operation is subject to the following two conditions: (1) This device may not cause harmful interference, and (2) this device must accept any interference received, including interference that may cause undesired operation.



Selecting fine audio equipment such as the unit you've just purchased is only the start of your musical enjoyment. Now it's time to consider how you can maximize the fun and excitement your equipment offers. This manufacturer and the Electronic Industries Association's Consumer Electronics Group want you to get the most out of your equipment by playing it at a safe level. One that lets the sound come through loud and clear without annoying blaring or distortion—and, most importantly, without affecting your sensitive hearing.

We recommend that you avoid prolonged exposure to excessive noise.

Sound can be deceiving. Over time your hearing "comfort level" adapts to higher volumes of sound. So what sounds "normal" can actually be loud and harmful to your hearing.

Guard against this by setting your equipment at a safe level BEFORE your hearing adapts.

To establish a safe level:

- Start your volume control at a low setting.
- Slowly increase the sound until you can hear it comfortably and clearly, and without distortion.

Once you have established a comfortable sound level:

- Set the dial and leave it there.

Taking a minute to do this now will help to prevent hearing damage or loss in the future. After all, we want you listening for a lifetime.

WARNING:

TO REDUCE THE RISK OF FIRE, ELECTRIC SHOCK OR PRODUCT DAMAGE, DO NOT EXPOSE THIS APPARATUS TO RAIN, MOISTURE, DRIPPING OR SPLASHING AND THAT NO OBJECTS FILLED WITH LIQUIDS, SUCH AS VASES, SHALL BE PLACED ON THE APPARATUS.

CAUTION!

DO NOT INSTALL OR PLACE THIS UNIT IN A BOOKCASE, BUILT-IN CABINET OR IN ANOTHER CONFINED SPACE. ENSURE THE UNIT IS WELL VENTILATED. TO PREVENT RISK OF ELECTRIC SHOCK OR FIRE HAZARD DUE TO OVERHEATING, ENSURE THAT CURTAINS AND ANY OTHER MATERIALS DO NOT OBSTRUCT THE VENTILATION VENTS.

User memo:

DATE OF PURCHASE _____
 DEALER NAME _____
 DEALER ADDRESS _____

 TELEPHONE NUMBER _____

The model number and serial number of this product can be found on either the back or the bottom of the unit. Please note them in the space provided below and keep for future reference.

MODEL NUMBER _____
 SERIAL NUMBER _____

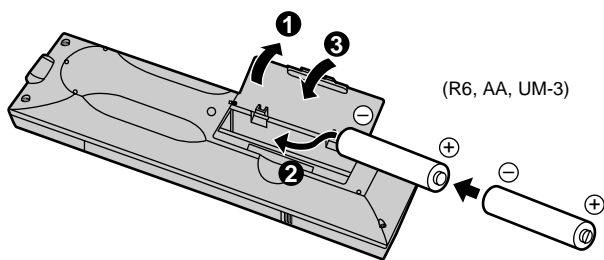

- Insert so the poles (+ and –) match those in the remote control.
- Do not use rechargeable type batteries.

- Keep the transmission window and the unit's sensor free from dust.
- Operation can be affected by strong light sources, such as direct sunlight, and the glass doors on cabinets.

■ How to open the remote control

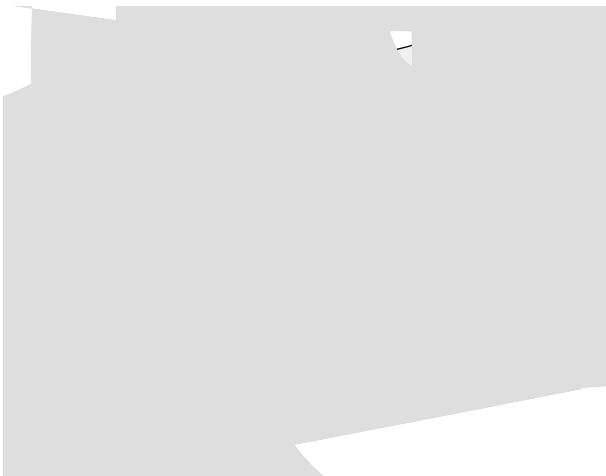

Step 1 2 3 4

Equipment connections

Stereo connection cable

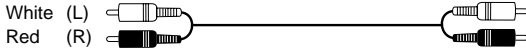

Video connection cable



Optical fiber cable

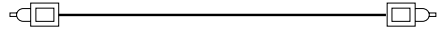

Coaxial cable



Turn off all components before making any connections. To connect equipment, refer to the appropriate operating instructions.

Note

- Do not bend the optical fiber cable.
- Use digital connection to enjoy Dolby Digital or DTS (→ page 14).
- Use analog connection to enjoy sources that cannot be decoded on this unit, to record analog sources and to output through SECOND AUDIO OUT (SA-XR45) (→ pages 8, 14, 20 and 21).

Changing the digital input settings

You can change the input settings for the digital terminals if necessary. Note the equipment you have connected to the terminals, then change the settings (→ page 11 or 13).

TV and DVD player

Step 2

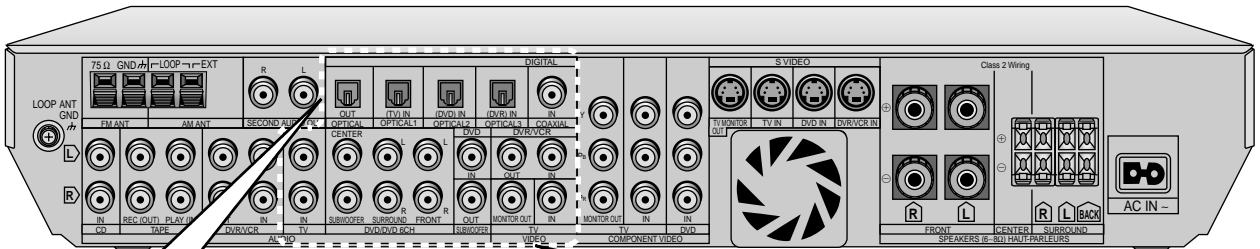

Satellite receiver etc.

SA-XR45

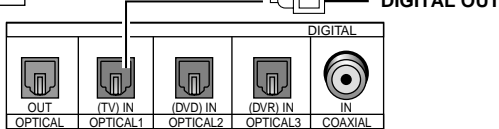

SA-XR25

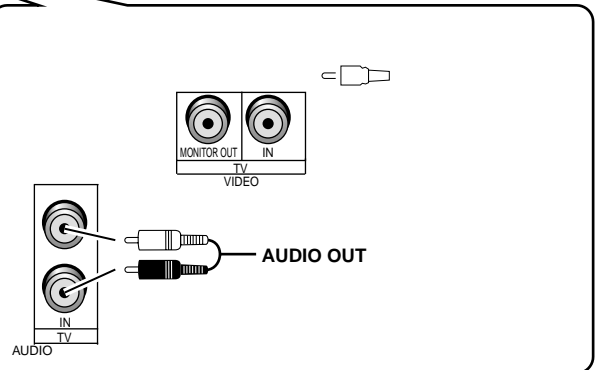
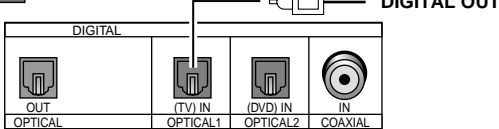

Other audio visual equipment

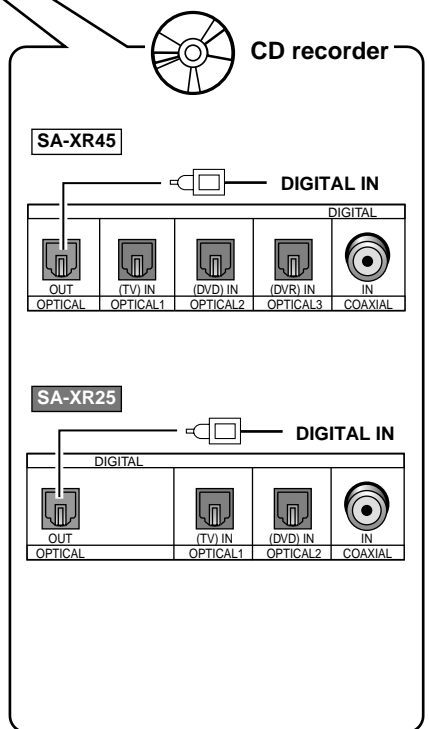
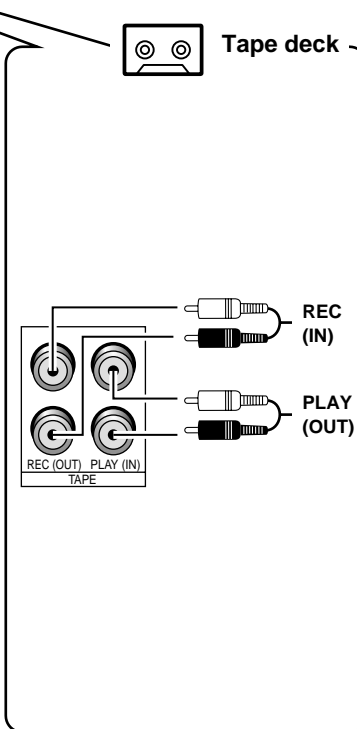
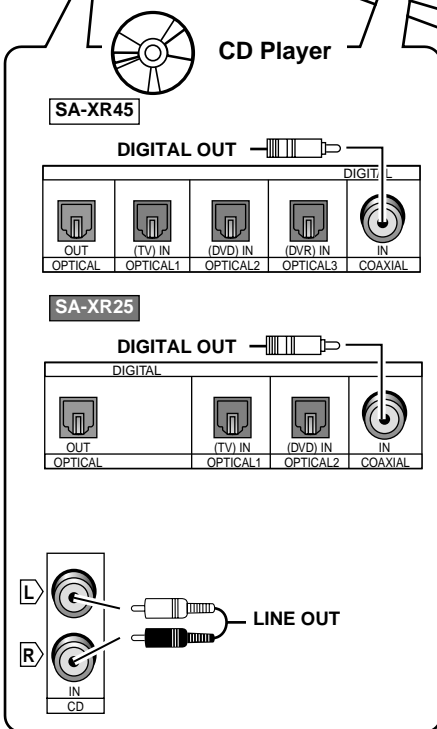
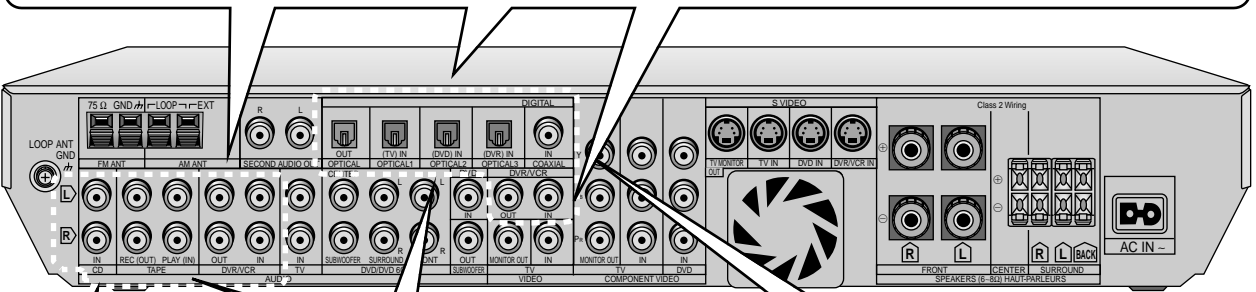
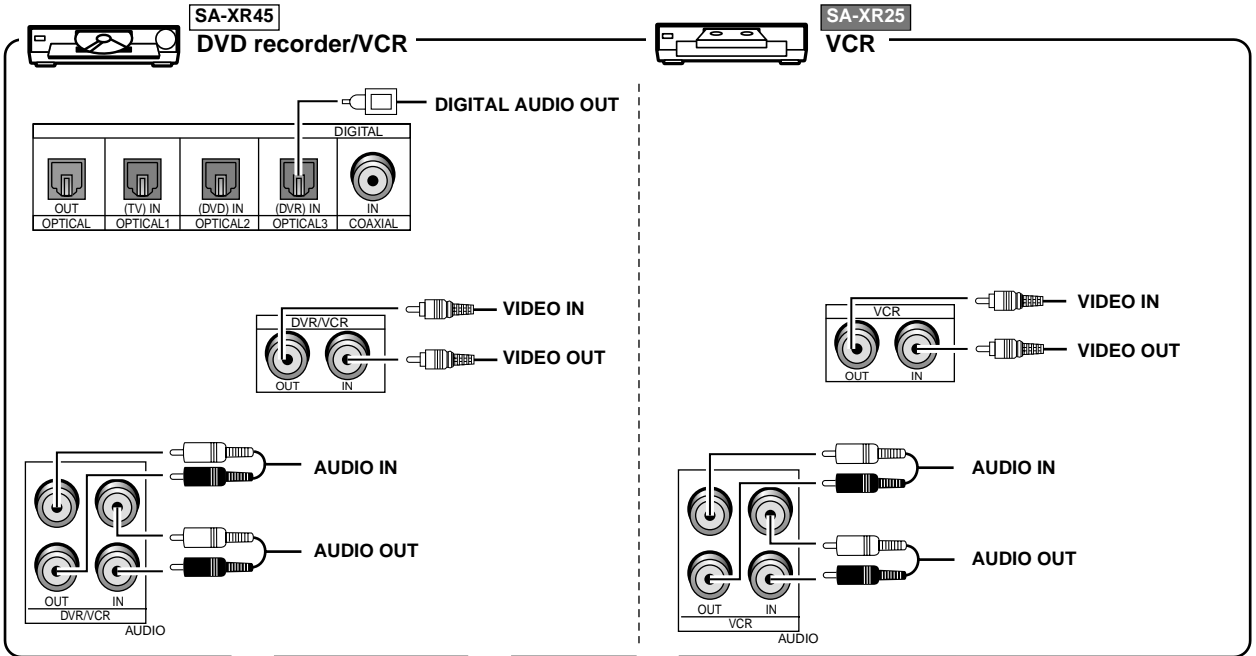

Antennas

FM indoor antenna (included)

Fix the other end of the antenna where reception is best.

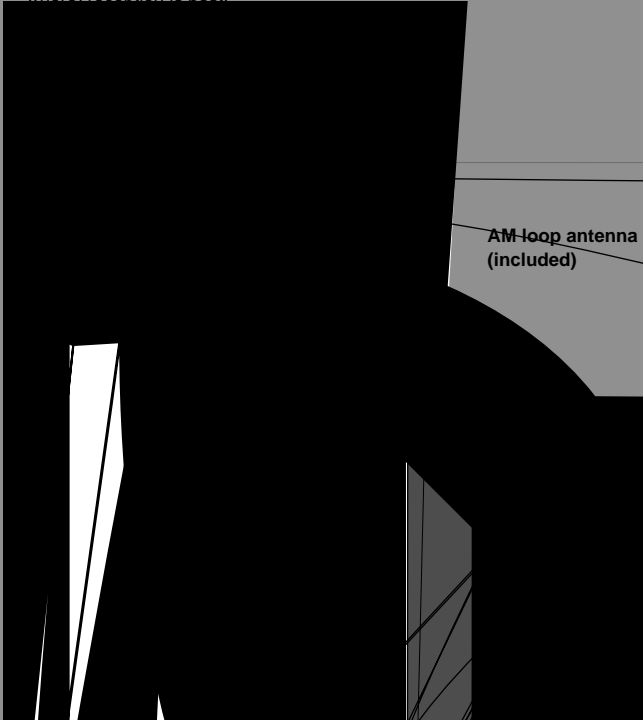

Keep the antenna cord away from tape decks, DVD players, and other cords.

FM outdoor antenna

- Disconnect the FM indoor antenna.
- The antenna should be installed by a competent technician.
- Twist the coaxial cable's shield braid firmly and connect it to the GND terminal.

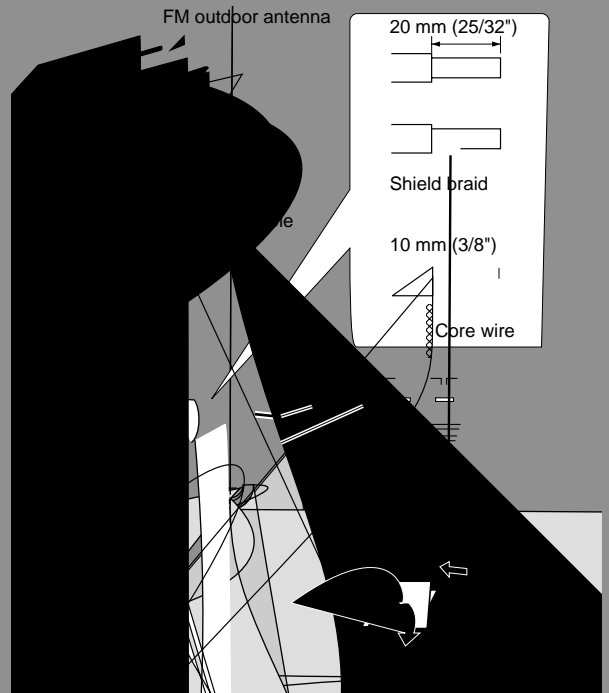

Note

- Connect the source to analog terminals. You cannot output sources connected only to the digital terminals.
- When you connect DVD 6CH input, only sound from the front left and right channels is output.

Step 1 2 3 4

Settings

SA-XR45 also has an On Screen Display Mode for settings ❶ to ❹ (→ pages 12 and 13).

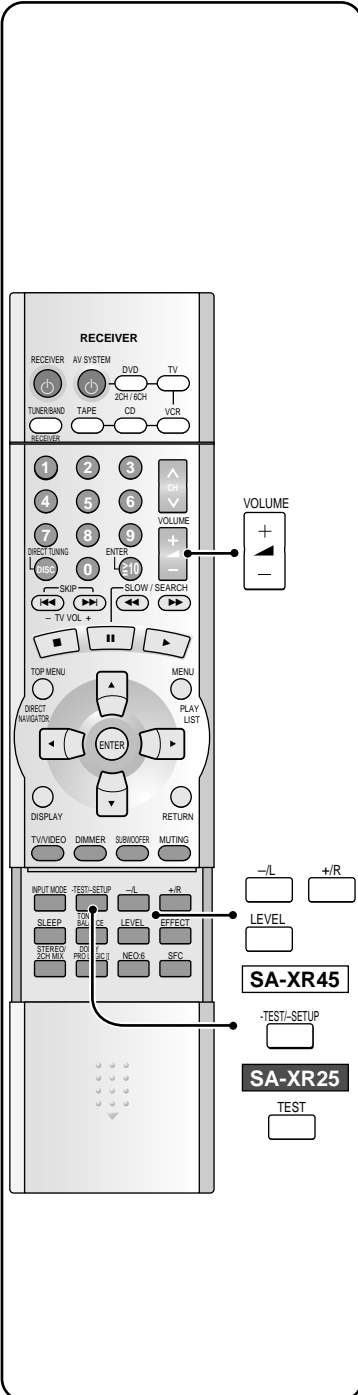
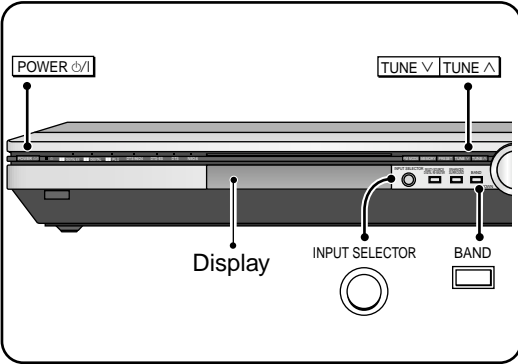

❶ SPEAKERS

Set the size to suit your speakers

LARGE: For speakers that can reproduce a full sound range, particularly the bass range below 100 Hz.

SMALL: For speakers that cannot adequately reproduce the bass range. This setting is sufficient for most speakers if you are using a subwoofer.

NONE: For speakers you haven't connected (center or surround). The factory settings are: **SMALL**

For the surround back (SUR BACK) and subwoofer (SUB-WFR), select YES if you have connected one (factory setting), or NO if you have not.

❷ DISTANCE

Enter the distance of the front, center and surround speakers from the seating position

Change the distance so that the sound from all the speakers (except for the subwoofer) reaches you at the same time.

You can select distances between 3 and 30 feet at one-foot intervals.

The factory settings are:
FRONT and CENTER: 10 FEET
SURROUND and SUR BACK: 5 FEET

POWER Switch on

INPUT SELECTOR
 BAND
 Press at the same time

INPUT SELECTOR
 Select "SPEAKERS".

BAND
 Select the speaker.

TUNE TUNE Change the setting.

INPUT SELECTOR
 BAND
 Press at the same time

Enter the setting mode.

Select "SPEAKERS".
SPEAKERS

Select the speaker.
FRONT
 FRONT, CENTER, SURROUND, SUR BACK, SUB-WFR

Repeat.
 Change the setting.
SMALL
 NONE, SMALL, LARGE
 NO, YES

Exit the setting mode.

Select "DISTANCE".
DISTANCE

Select the speaker.
FRONT
 FRONT, CENTER, SURROUND, SUR BACK

Repeat.
 Change the setting.
10 FEET
 3 FEET 30 FEET

3 FILTER

4 D-INPUT Digital input

5 Adjusting speaker output level

Change these settings to suit the connections you have made to the optical (OPT) and coaxial (COAX) digital input terminals, so that the correct source is selected when you press [INPUT SELECTOR].
The factory settings are:

SETUP

Select "FILTER".

FILTER

Select "D-INPUT".

D-INPUT

Select the input position.

OPT 1
TV, DVD, DVR, CD

Change the setting.

100

100, 150, 200

COMPLETE

SA-XR45

-TEST/-SETUP

SA-XR25

TEST

Output the signal.

TEST L

Two seconds each.

L → C → R → RS → SB → LS → SW

Adjust the main volume.

VOLUME
+
-

Select the speaker channel.

C 0dB
C, RS, SB, LS, SW

Repeat.

Adjust the level.

C +4dB
-10 dB +10 dB
---, MIN, 1 19, MAX

SA-XR45

-TEST/-SETUP

SA-XR25

TEST

Stop the test signal.

- Use the on screen display to change the settings to suit your equipment to the environment in which you are using it.
Turn on the television and select the video input for this unit.
- Before making any changes, read the descriptions of the settings, note the factory settings and ranges, and refer to the equipment's instructions.

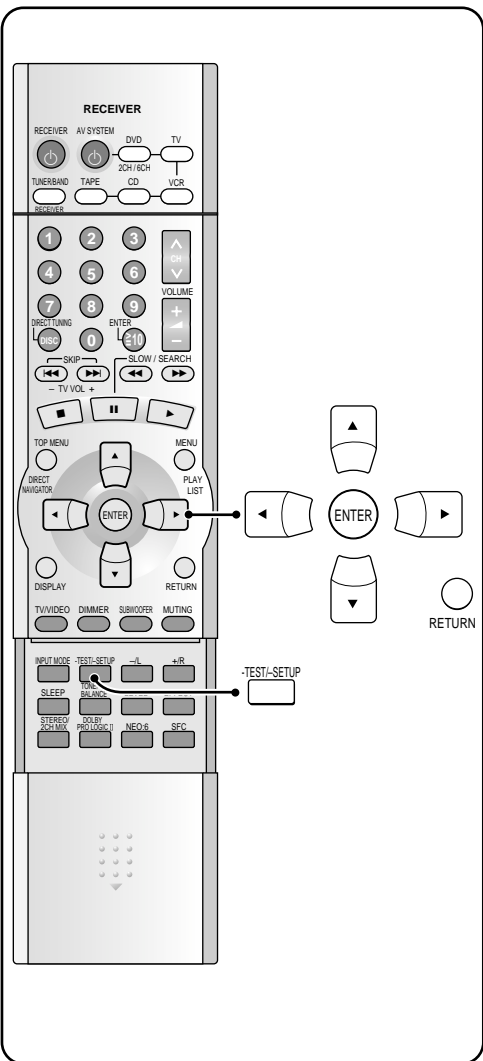

Step 3

To exit On Screen Display mode

Select "Exit from SETUP" in the main menu.

Or



Press [RETURN] until the setup menu disappears.

For your reference

- **To return to the main menu**
Select "Return"
Or
Press [RETURN].
- **Do 5 on page 11 to adjust speaker output level.**

1 Speaker Size

Set the size to suit your speakers

- LARGE:** For speakers that can reproduce a full sound range, particularly the bass range below 100 Hz.
- SMALL:** For speakers that cannot adequately reproduce the bass range. This setting is sufficient for most speakers if you are using a subwoofer.
- NONE:** For speakers you haven't connected (center or surround).

The factory settings are: **SMALL**

For the surround back (Surr Back) and subwoofer (Subwoofer), select YES if you have connected one (factory setting), or NO if you have not.

Enter the setup menu.



Press and hold

Select the speaker.

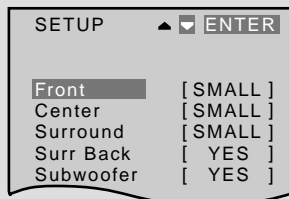

Repeat.

Change the setting.

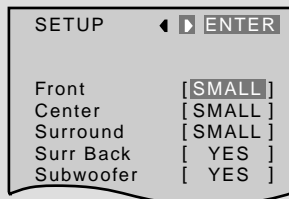

Exit the setup menu.



Or



Or

Continue making other settings.

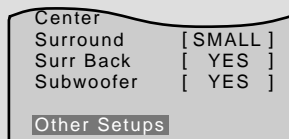

2 Speaker Distance

Enter the distance of the front, center and surround speakers from the seating position

Change the distance so that the sound from all the speakers (except for the subwoofer) reaches you at the same time. You can select distances between 3 and 30 feet at one-foot intervals.

The factory settings are:

Front and Center: 10 FEET
Surround and Surr Back: 5 FEET

3 Filter Frequency

Change the cut-off for bass output from the front speakers

If you set the front speakers to "SMALL", the filter is set to 100 Hz. Raise the cut-off if the bass from the front speakers is unsatisfactory so bass is output through the subwoofer.

You can raise the cut-off from 100 Hz to either 150 Hz or 200 Hz.

4 Digital Input

Change these settings to suit the connections you have made to the optical (OPT) and coaxial (COAX) digital input terminals, so that the correct source is selected when you press [INPUT SELECTOR].

The factory settings are:

CD: COAX
TV: OPT 1
DVD: OPT 2
DVR: OPT 3

 Press and hold

Enter the setup menu.

SETUP  ENTER

 ENTER

Select "Other Setups".

Center [SMALL]
Surround [YES]
Surr Back [YES]
Subwoofer [YES]

Other Setups

 ENTER

Select "Speaker Distance".

SETUP  ENTER
Speaker Size
Speaker Distance
Filter Frequency
D-Range Compression
Digital Input

Select "Filter Frequency".

SETUP  ENTER
Speaker Size
Speaker Distance
Filter Frequency
D-Range Compression
Digital Input

Select "Digital Input".

SETUP  ENTER
Speaker Size
Speaker Distance
Filter Frequency
D-Range Compression
Digital Input



Select the speaker.

SPEAKER  ENTER
DISTANCE
Front [10] feet
Center [10] feet
Surround [5] feet
Surr Back [5] feet

Repeat.

Change the setting.

SPEAKER  ENTER
DISTANCE
Front [10] feet
Center [10] feet
Surround [5] feet
Surr Back [5] feet

Change the setting.

FILTER  ENTER
FREQUENCY
[100] [150] [200]

Returns to the main menu.

Select the input position.

DIGITAL  ENTER
INPUT
CD [COAX]
TV [OPT1]
DVD [OPT2]
DVR [OPT3]

Repeat.

Change the setting.

DIGITAL  ENTER
INPUT
CD [COAX]
TV [OPT1]
DVD [OPT2]
DVR [OPT3]

Return to the main menu.

Return

 ENTER

Return to the main menu.

Return

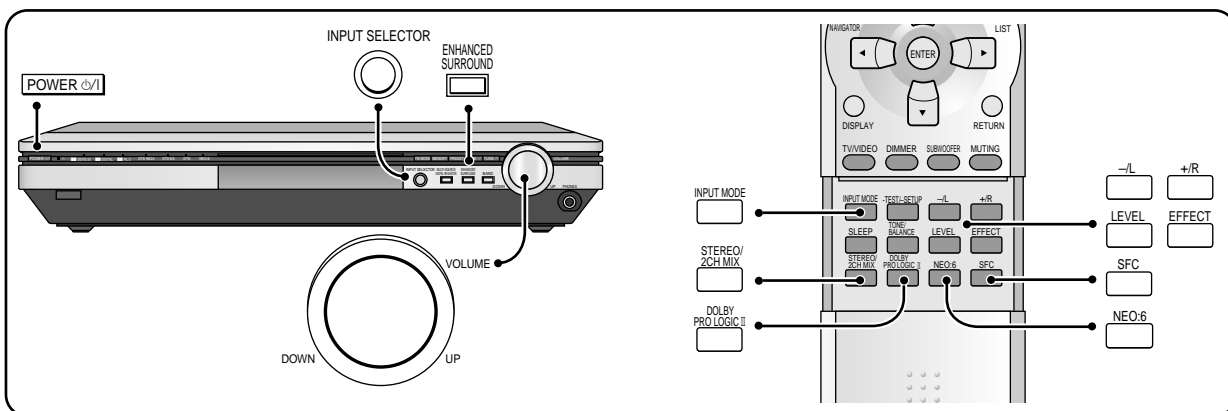

1 Switch on.



2 Select input.

INPUT SELECTOR



SA-XR45 TUNER → CD → TV → DVD
 ↑ TAPE ← DVR/VCR ↓

SA-XR25 TUNER → CD → TV → DVD
 ↑ TAPE ← VCR ↓

3 Start play of the source.

The unit sets the sound mode to suit the input signal.

4 Adjust the volume.



When you finish listening

Be sure to reduce the volume and press [POWER] to switch the unit to standby.

Notes on digital input

This unit can decode the following signals:

- Dolby Digital, including Dolby Digital Surround EX
- DTS, including DTS-ES or DTS 96/24 (SA-XR45)
- PCM, including PCM with sampling frequencies of 192, 176.4 (SA-XR45, OPTICAL2), 96 or 88.2 kHz

It cannot decode:

- Other digital signals, such as MPEG
- Dolby Digital RF signals from a laser disc player

Notes on sound modes

When input is Dolby Digital or DTS:

- You cannot use SFC.

When input is PCM with sampling frequencies of 192, 176.4 (SA-XR45, OPTICAL2), 96, or 88.2 kHz:

- You cannot add surround effects with Dolby Pro Logic II, NEO:6 or SFC.

When you have selected "NONE" for both the center and surround speakers:

- You cannot use Dolby Pro Logic II, NEO:6, or SFC.

Sound modes

The unit sets the sound mode to suit the signal.

Adding surround effects to stereo sources

■ Using Dolby Pro Logic II

Dolby Pro Logic II processor works not only on sources recorded with Dolby Surround, but also on any stereo source.

The following modes are available when using Dolby Pro Logic II.



■ Using NEO:6

Use NEO:6 to play 2-channel sources through multi-channels.

The following modes are available when playing 2-channel sources.



■ Using the Sound Field Control (SFC)

Enjoy an enhanced sound experience with greater presence and spread by using these SFC modes with PCM or analog stereo sources.

Choose from the following modes.



Dolby Pro Logic II, NEO:6 and SFC modes remain in effect until you change them.

• To return to stereo sound

Press [STEREO/2CH MIX].

ENHANCED SURROUND mode

This mode uses the surround back speaker to create a realistic sound field. It is especially effective when playing DTS-ES and Dolby Digital Surround EX, but can be used with other DTS and Dolby Digital sources, as well as Dolby Pro Logic II and NEO:6. This mode engages automatically if the disc has a recognition signal for DTS-ES or Dolby Digital Surround EX (you can still turn the mode off).



Listening to multi-channel sources in stereo

When surround sources are played in this mode, the sounds intended for the other speaker channels are played through the front speakers.



The 2CH MIX mode remains in effect until you change input mode or turn off the unit.

• To return to surround sound

Press [STEREO/2CH MIX].

If the unit does not automatically recognize Dolby Digital Surround EX or DTS-ES and output is 5.1 channels:

- Press [ENHANCED SURROUND] to switch the mode on manually. Sound will now come from the surround back speaker.

MOVIE

Use this mode when playing movie software, especially videotapes, recorded in Dolby Surround.

MUSIC

Adds surround effects to stereo sources.

PANORAMA

Sound is spread out more so you feel like you are surrounded by music.

You can adjust the effect of MUSIC and PANORAMA with the center width and dimension controls.

Center Width Control – C-WDTH

This adjustment helps you realize a more natural sound image when listening to music. Move sound out into the front speakers to improve the overall front image, or add sound to the center speaker to fix the center image.

You can choose a level between 0 (the center speaker is dominant) and 7 (center sound is spread out).

The default level is 3.

1. Press [EFFECT] to select “C-WDTH”.
2. Press [–/L] or [+R] to adjust the effect.

Dimension Control – DIMEN

You can make up for differences in the output level of the front and surround speakers.

You can choose a level between –3 and +3 – Increase the level to move sound to the front speakers, decrease to move it to the surround speakers.

The default is level 0.

1. Press [EFFECT] to select “DIMEN”.
2. Press [–/L] or [+R] to adjust the effect.

CINEMA

Use this mode when playing movie software.

MUSIC

Adds surround effects to stereo sources.

Notes on using NEO:6

You cannot select the above modes when the “DTS” or “DIGITAL” indicator is on.

You can adjust the effect of MUSIC with the center image control.

Center Image Control – C-IMG

This adjustment helps you realize a more natural sound image when listening to music. Move sound out into the front speakers to improve the overall front image, or add sound to the center speaker to fix the center image.

You can choose a level between 0 (the center speaker is dominant) and 5 (center sound is spread out).

The default level is 3.

1. Press [EFFECT] to select “C-IMG”.
2. Press [–/L] or [+R] to adjust the effect.

HALL

Imparts the reflection and spread of a large concert hall.

CLUB

Conveys the exciting and intimate atmosphere of a jazz club.

LIVE

Brings you up close for “live” stage performance and smoother vocals.

THEATER

Recreates natural sound ambience and direction.

SIM SURR (Simulated Surround)

Heightens the sensation of expanded space with stereo sources, and augments monaural sources.

PARTY

This mode uses the front and surround speakers so that sound is in stereo regardless of the direction you are facing.

You can adjust the sound field by adjusting the level of the speakers and the delay time of the surround speakers. These adjustments can be made for each SFC mode.

To adjust the speaker level

1. Press [LEVEL] to select the speaker channel.

Each time you press the button:

C → RS → LS → SW

↑

Sound does not come from the surround back speaker.

Speakers set as “NONE” or “NO” are skipped.

2. Press [–/L] or [+R] to adjust the level.

C, RS, and LS: –10 dB to +10 dB

SW: --- (off) ↔ MIN ↔ 1 – 19 ↔ MAX

To adjust the delay time

1. Press [EFFECT].
2. Press [–/L] or [+R] to change the delay time.

Delay time can be set at 10-millisecond (ms) intervals between 10 and 100 ms.

The factory setting is 50 ms for each mode.

For your reference

In rare cases, the unit may have trouble recognizing the digital signals on discs.

- With the PCM signals on CDs, this may cause the beginning of a track to be cut off. Engage the PCM FIX mode if this occurs.
- With DTS, the signals may not be recognized at all. Engage the DTS FIX mode if this occurs.

While the input source is selected:

1. Press [INPUT MODE] to select “DIGITAL”
2. Press and hold [INPUT MODE] for four seconds.

The current mode is displayed. Press again to change the mode.

Each time you press the button:

AUTO → PCM FIX → DTS FIX

When a FIX mode is on, the unit cannot process other signals. This may cause noise to be output. Select “AUTO” if this occurs.

The mode returns to AUTO when you switch the unit to standby.

• When DTS FIX mode is on

You cannot use ENHANCED SURROUND.

DTS-ES and DTS 96/24 (SA-XR45) are played as normal DTS (i.e., there is no output from the surround back speaker).

Control guide

Main unit

[■ ■ DIGITAL EX, ■ ■ DIGITAL, ■ ■ PL II, DTS 96/24, DTS-ES, DTS, NEO:6] (SA-XR45)
 [■ ■ DIGITAL EX, ■ ■ DIGITAL, ■ ■ PL II, DTS-ES, DTS, NEO:6] (SA-XR25)

Light to indicate the source's input signal and decoding format used.

■ ■ DIGITAL EX: Dolby Digital Surround EX sources

■ ■ DIGITAL: Dolby Digital sources

■ ■ PL II: Dolby Pro Logic II decoder is being used

DTS 96/24: DTS 96/24 sources (SA-XR45)

DTS-ES: DTS-ES discrete or matrix sources

DTS: DTS sources

NEO:6: NEO:6 matrix decoder is being used

[POWER ϕ /I]

Press to switch the unit from on to standby mode or vice versa.

In standby mode, the unit is still consuming a small amount of power.

Standby indicator [ϕ]

When the unit is connected to the AC mains supply, this indicator lights up in standby mode and goes out when the unit is turned on.

Remote control signal sensor

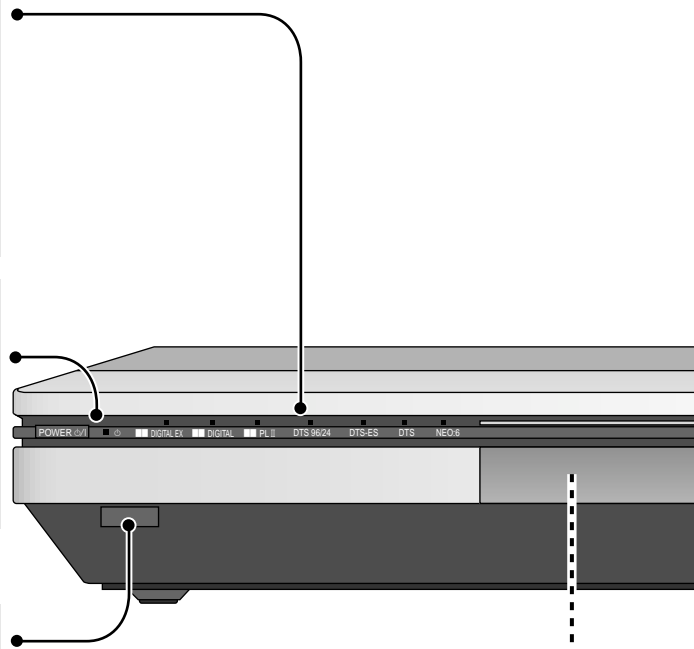

Display

[SLEEP]

Sleep timer indicator.

[M, TUNED, ST, MONO]

Radio indicators

M: Flashes or lights during presetting.

TUNED: A station is tuned.

ST: A stereo FM broadcast is tuned.

MONO: You have switched to monaural mode with [FM MODE] to improve reception.

General display

Shows the input mode, radio frequency, and other general information.

[kHz, MHz]

Frequency unit indicators

kHz: AM, or PCM sampling frequency

MHz: FM

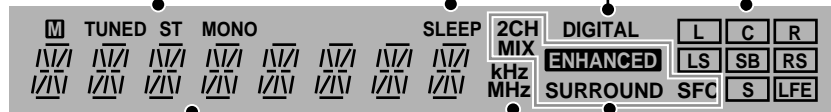

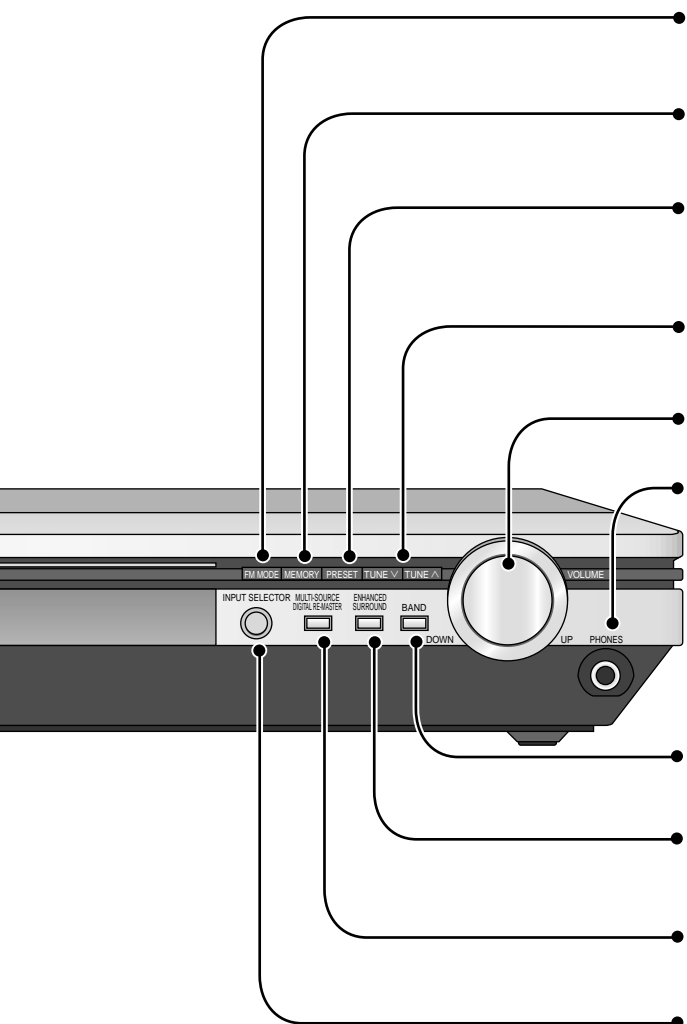

[FM MODE]
If reception is poor in FM, press so "MONO" appears to switch to monaural mode.

[MEMORY]
For presetting radio stations.

[PRESET]
Press to allow preset station selection with [TUNE, ∇, ▲].

[TUNE, ∇, ▲]
For tuning the radio and selecting preset stations. Press and hold until the frequency starts scrolling to start automatic tuning. Tuning stops when a station is found.

[VOLUME]
Volume control.

[PHONES]
Headphone jack
Plug type: 6.3 mm (1/4") stereo

- Avoid listening for prolonged periods of time to prevent hearing damage.
- The STEREO/2CH MIX mode is engaged when you connect headphones and you cannot select any of the other sound modes.

[BAND]
For switching between FM and AM.

[ENHANCED SURROUND]
For turning on the enhanced surround mode.

[MULTI-SOURCE DIGITAL RE-MASTER] (SA-XR45)
For selecting a re-master mode. The button lights while a re-master mode is on.

[INPUT SELECTOR]
For selecting input.

[DIGITAL]
Lights when digital input is selected.

[L, C, R, LS, SB, RS, S, LFE]
Program format indicators
Show the channels contained in the digital input signal. They do not light when input is analog.
 L: Front left channel
 C: Center channel
 R: Front right channel
 LS: Surround left channel
 SB: Surround back channel
 RS: Surround right channel
 S: If the surround channel is monaural.
 LFE (Low Frequency Effects): Deep-bass effect.

[2CH MIX, ENHANCED, SURROUND, SFC]
2CH MIX: Appears when you are playing a multi-channel source in 2CH MIX mode
ENHANCED: Appears when enhanced surround mode is on
SURROUND: Appears when you are using Dolby Pro Logic II, NEO:6 or enhanced surround mode
SFC: Appears when you are using an SFC mode

For your reference

- **When playing video sources connected to DVR/VCR (SA-XR45) or VCR (SA-XR25)**
The picture remains on the screen even if you select TAPE, CD or TUNER.

Manufactured under license from Dolby Laboratories.
 "Dolby", "Pro Logic" and the double-D symbol are trademarks of Dolby Laboratories.

Manufactured under license from Digital Theater Systems, Inc.
 US Pat. No. 5,451,942, 5,956,674, 5,974,380, 5,978,762 and other world-wide patents issued and pending.
 "DTS", "DTS-ES Extended Surround" and "Neo:6" are trademarks of Digital Theater Systems, Inc. Copyright 1996, 2000 Digital Theater Systems, Inc. All rights reserved.

Remote control

Buttons not explained on this page are used only to operate other equipment. Refer to the separate Remote Control Operation Guide for details.

[⏻, RECEIVER]
Standby/on button.

[1, 2, 3, 4, 5, 6, 7, 8, 9, 0]
To enter radio frequencies and channels.
[≥10, ENTER]
To enter two digit channels.

[DISC, DIRECT TUNING]
To enable selection of radio stations by frequency.

[▲, ▼, ◀, ▶, ENTER, RETURN]
To operate the on screen menus. (SA-XR45)

[DIMMER]
For dimming the unit's display and turning off the panel light.

[INPUT MODE]
For selecting AUTO, ANALOG or DIGITAL.

[SLEEP]
To start the sleep timer.

[STEREO/2CH MIX]
For selecting STEREO or 2CH MIX mode.

[DOLBY PRO LOGIC II]
For selecting a Dolby Pro Logic II mode: MOVIE, MUSIC or PANORAMA.

[NEO:6]
For selecting a NEO:6 mode: CINEMA or MUSIC.

[SFC]
For selecting SFC modes.

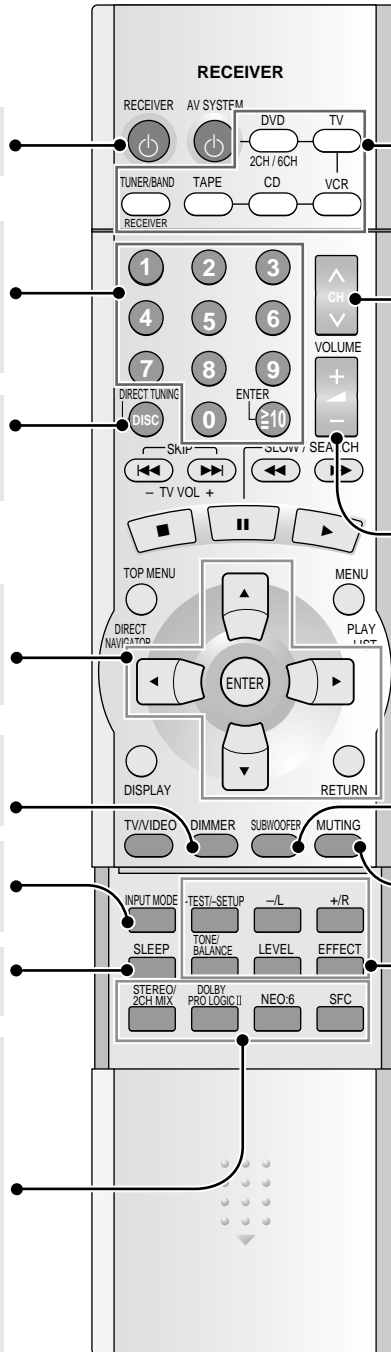

[DVD 2CH/6CH, TV, TUNER/BAND RECEIVER, TAPE, CD, VCR] (SA-XR45)
[DVD 2CH/6CH, TV, TUNER/BAND, TAPE, CD, VCR] (SA-XR25)
Input mode and remote control mode buttons.

DVD 2CH/6CH:For switching between 6-channel and 2-channel DVD input.

These buttons light when you press other buttons to indicate the current remote control mode. (SA-XR45)

[^, CH, v]
For selecting preset radio channels.

[+, -, VOLUME]
To adjust the volume.

[SUBWOOFER]
For selecting subwoofer level. Adjust the level in 5 steps: SW MIN, SW 5, SW 10, SW 15, and SW MAX. Select SW --- to stop output.

[MUTING]
To mute the volume.

[-TEST/-SETUP] (SA-XR45)
To start the speaker test signal or enter the setup menu.

[TEST] (SA-XR25)
To start the speaker test signal.

[TONE/BALANCE]
To adjust the bass, treble and front speaker balance.

[LEVEL]
Use when adjusting speaker level.

[EFFECT]
Use when adjusting Dolby Pro Logic II, NEO:6 or SFC effects.

[-L, +R]
First select SLEEP, EFFECT, LEVEL, TONE or BALANCE, then press [-L] or [+R] to adjust.

For your reference

- **When DVD 6CH input is on**
Speaker settings are ineffective. Change the settings on the DVD player if necessary.
- **When using the subwoofer**
You cannot adjust subwoofer level if DVD 6CH INPUT is selected. Sound can be distorted if you raise the volume while subwoofer level is high. Reduce subwoofer level if this occurs.
- **When muting is on**
Muting is also canceled when the unit is turned off.

The radio

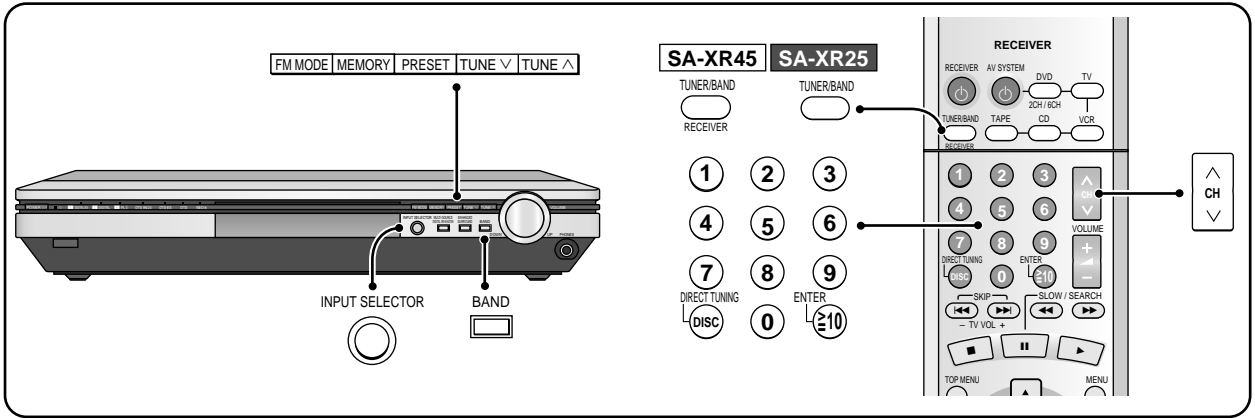

Manual tuning

You can tune radio stations manually by selecting the station's frequency.

1. Press [INPUT SELECTOR] to select "TUNER".
2. Press [BAND] to select "FM" or "AM".
3. Press [TUNE ∨ or ∧] to select the frequency.

Tuning intervals: FM – 0.2 MHz
AM – 10 kHz

Improving reception

- **FM mode**
You can improve FM reception by switching reception to monaural. Press [FM MODE]. "MONO" lights. Press [FM MODE] again to cancel.
- **For your reference**
DVD players can interfere with radio reception. Turn the DVD player off or move it further away from the antennas if this occurs.

Direct tuning (on the remote control)

1. Press [TUNER/BAND RECEIVER]. ([SA-XR45])
Press [TUNER/BAND]. ([SA-XR25])
The band changes each time you press the button.
2. Press [DISC, DIRECT TUNING].
3. Press the numbered buttons to enter the frequency.

e.g. To select 107.9 MHz, press [1] → [0] → [7] → [9]

Tuning intervals: FM – 0.1 MHz
AM – 10 kHz

- If you do not press a button while the cursor is flashing, the display returns to the frequency being received.
- If the frequency has not been input correctly, "ERROR" will be displayed.

Automatic presetting

1. Tune to "FM 87.9 MHz".
2. Press and hold [MEMORY].
The FM stations the unit can receive are preset in channels 1 to 30.
3. Tune to "AM 530 kHz".
4. Press and hold [MEMORY].
The AM stations the unit can receive are preset in channels 21 to 30. (FM stations are replaced if any were preset in these channels.)

During automatic presetting, the memory indicator (M) flashes and the frequency scrolls. The memory indicator and channel numbers are displayed for a second when a station is preset. The last station to be preset is displayed when presetting finishes.

For your reference

Even if the power supply cord is disconnected from the household AC outlet, the stations remain in memory for approximately two weeks.

Manual presetting

Preset the stations one at a time.

1. Tune to the station.
2. Press [MEMORY].
3. Press [TUNE ∨ or ∧] to select a channel.
4. Press [MEMORY].

For your reference

FM stations can also be preset in the MONO mode.

Selecting channels

1. Press [PRESET].
The channel number flashes for about 5 seconds.
2. Press [TUNE ∨ or ∧].
Hold down the buttons to change channels faster.

On the remote control

Press [∧, CH, ∨].

or

Press the numbered buttons.

For channels 1 to 9, press the corresponding number.

For channels 10 or over, press [≥10, ENTER], then the two digits.

e.g. To select channel 21: [≥10, ENTER] → [2] → [1]

Other settings

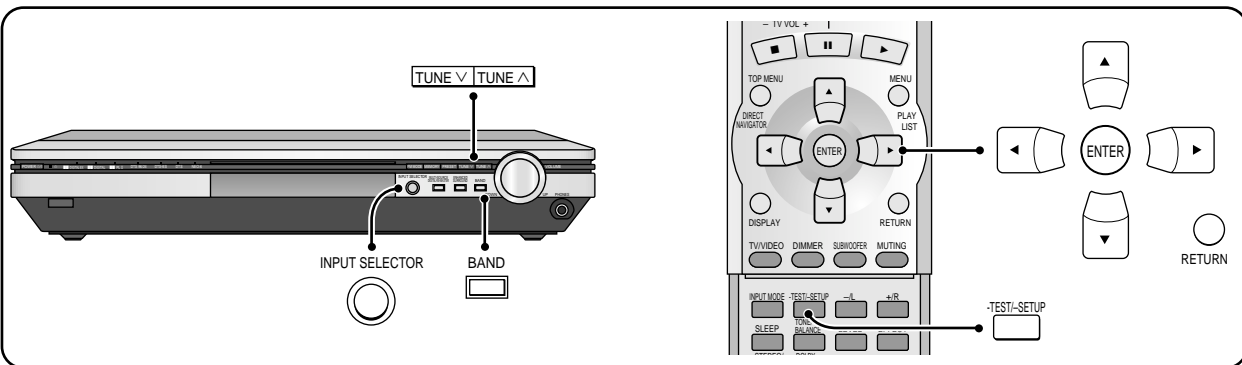

On the main unit

A DR COMP - Dynamic range compression

Change this setting to listen to software recorded with Dolby Digital at low volume (such as late at night) and maintain audio clarity. It reduces the peak level in loud scenes without affecting the sound field.

OFF: The software is played with the original dynamic range (factory setting).

STANDARD: The level recommended by the producer of the software for household viewing.

MAX: The maximum allowable compression (recommended for night viewing).

B A/D ATT - A/D attenuator

Turn the A/D attenuator on if "OVERFLOW" lights frequently when using 2-channel analog input or DVD 6CH input.

The factory setting is OFF.

C SECOND-A - Second Audio output (SA-XR45)

Select the source to output from SECOND AUDIO OUT.

The factory setting is SOURCE (the source playing on this unit is output).

Changing the settings

1. Press [INPUT SELECTOR] and [BAND] at the same time to enter the setting mode.

2. Press [INPUT SELECTOR] to select the item you want to change.

3. Change the settings.

A DR COMP

Press [TUNE ∨ or ∧] to select "OFF", "STANDARD" or "MAX".

B A/D ATT

Press [TUNE ∨ or ∧] to select "OFF" or "ON".

C SECOND-A (SA-XR45)

Press [TUNE ∨ or ∧] to select "SOURCE", "CD", "TV", "DVD", "DVR/VCR" or "TAPE".

• To listen to the radio, select SOURCE and tune to the station.

4. Press [INPUT SELECTOR] and [BAND] at the same time to exit the setting mode.

On Screen Display mode SA-XR45

A D-Range Compression - Dynamic range compression

Change this setting to listen to software recorded with Dolby Digital at low volume (such as late at night) and maintain audio clarity. It reduces the peak level in loud scenes without affecting the sound field.

OFF: The software is played with the original dynamic range (factory setting).

STANDARD: The level recommended by the producer of the software for household viewing.

MAX: The maximum allowable compression (recommended for night viewing).

B A/D attenuation

Turn the A/D attenuator on if "OVERFLOW" lights frequently when using 2-channel analog input or DVD 6CH input.

The factory setting is OFF.

C Second Audio Output

Select the source to output from SECOND AUDIO OUT.

The factory setting is SOURCE (the source playing on this unit is output).

Changing the settings

1. Press and hold [-TEST/-SETUP] to enter the setup menu.

2. Press [▲] or [▼] to select "Other Setups".

3. Press [ENTER].

4. Press [▲] or [▼] to select the item you want to change.

5. Press [ENTER].

6. Change the settings.

A D-Range Compression

Press [◀] or [▶] to select "OFF", "STANDARD" or "MAX".

B A/D attenuation

Press [◀] or [▶] to select "OFF" or "ON".

C Second Audio Output

Press [◀] or [▶] to select the "SOURCE", "CD", "TV", "DVD", "DVR/VCR" or "TAPE".

• To listen to the radio, select SOURCE and tune to the station.

7. Press [ENTER].

8. Press [▲] or [▼] to select "Exit from SETUP".

9. Press [ENTER].

For your reference

• To exit On Screen Display mode

Press [RETURN] until the setup menu disappears.

• To return to the main menu

Press [RETURN].

Other functions

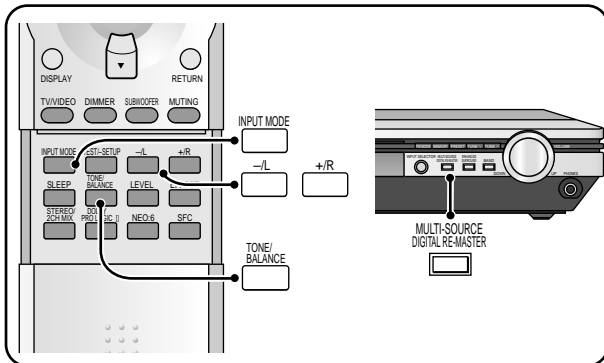

Input mode

This unit automatically detects whether input is digital or analog, but you can fix the input mode.

Press **[INPUT MODE]** to select “AUTO”, “ANALOG” or “DIGITAL”.

Balance

You can adjust the balance of the front speakers.

1. Press **[TONE/BALANCE]** to select “BALANCE”.
2. Press **[-/L]** or **[+/R]** to adjust.

Tone

You can adjust the level of the bass and treble.

1. Press **[TONE/BALANCE]** to select “BASS” or “TREBLE”.
2. Press **[-/L]** or **[+/R]** to adjust bass/treble.

For your reference

• To adjust the tone

The STEREO mode must be on and input must be either analog or PCM signals. You cannot adjust the tone if DVD 6CH is selected.

Re-master SA-XR45

This original Panasonic feature boosts the frequencies of the higher harmonics that are lost during recording due to compression.

Press **[MULTI-SOURCE DIGITAL RE-MASTER]** to select “EFFECT 1”, “EFFECT 2”, “EFFECT 3” or “EFFECT 4”.

When Re-master is on, the current level appears, then each time you press the button:

- EFFECT 1: for fast tracks (pop and rock)
- EFFECT 2: for tracks with a variety of tempos (jazz)
- EFFECT 3: for slow tracks (classical)
- EFFECT 4: for compressed audio signals
- OFF: the re-master processing is off.

Making a recording

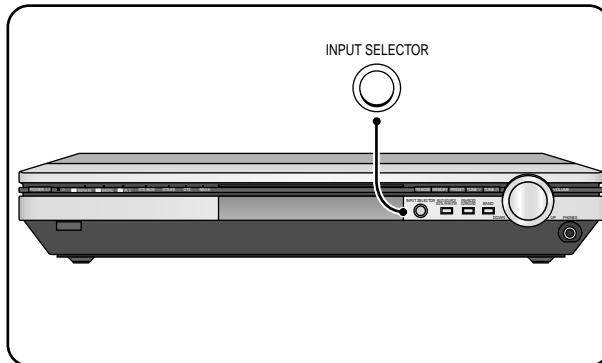

Recording on other equipment

You can record to a tape deck connected to TAPE REC (OUT), a VCR connected to VCR OUT (SA-XR25), a DVD recorder/VCR connected to DVR/VCR OUT (SA-XR45), or digital recording equipment connected to DIGITAL OPTICAL OUT.

See the recording unit's operating instructions for details on how to prepare it for recording.

1. Press **[INPUT SELECTOR]** to select the source to be recorded.
2. Begin recording.
Follow your recording unit's operating instructions.
3. Start the source to be recorded.
Follow your equipment's operating instructions.

- With a tape deck, you can record any analog source except TAPE.
- With a VCR, you can record any analog source except VCR (SA-XR25).
- With a DVD recorder/VCR, you can record any analog source except DVR/VCR (SA-XR45).
- With digital recording equipment, you can record any digital source without copy protection.
- When you select DVD 6CH INPUT mode, only sound from the front left and right channels is recorded.
- Some sources do not allow digital recording. Connect through the analog terminals and select “ANALOG” input.

Sleep timer

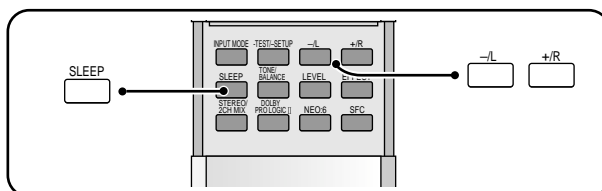

The SLEEP timer can turn the unit off after a set time. It does not control any other components.

1. Press **[SLEEP]**.
SLEEP → OFF
2. Within 5 seconds
Press **[-/L]** or **[+/R]** to select the required time.
The display changes as follows:
30 ↔ 60 ↔ 90 ↔ 120 (in minutes)

To check the setting

Press [SLEEP] once.

- The time remaining appears.

To change a setting

Repeat the procedure from the beginning.

Troubleshooting guide

Before requesting service, make the below checks. If you are in doubt about some of the check points, or if the remedies indicated in the chart do not solve the problem:

In the U.S.A., contact the Panasonic Customer Call Center at 1-800-211-7262, or e-mail consumerproducts@panasonic.com, or web site (<http://www.panasonic.com>).

In Canada, contact Panasonic Canada Inc. Customer Care Centre at 905-624-5505, or web site (www.panasonic.ca), or an authorized Servicentre close to you.

Common problems		Pages
No power.	▶	• Ensure the power cord is connected. 9
	▶	• Turn the volume up. 14
No sound.	▶	• Check connections to speakers and other equipment. 4-9
	▶	• Select the correct source. 14
Sound stops. "F 76", "OVERLOAD" or "FAN LOCK" appears on the display for about a second, and the unit turns off.	▶	• Change the D-INPUT (or Digital Input) setting to suit the type of connection you have made. 11,13
	▶	• Check that the digital signals can be decoded by this unit. 14
"F 70" appears on the display.	▶	• Turn PCM FIX or DTS FIX off. 15
	▶	• Determine and correct the cause, then switch the unit on. Causes include: -Shorting (bare wires touching) of positive and negative speaker wires. 4 -Using speakers with an impedance lower than that rated for this unit. 5 -Straining of the speakers through excessive volume or power. - -Using the unit in a hot environment without proper ventilation. - Consult your dealer if the problem occurs again after switching the unit on.

Sound modes		Pages
Sound is not heard from the center, surround, or subwoofer speakers.	▶	• Ensure the SPEAKERS (or Speaker Size) settings for your speakers are correct. 10,12
	▶	• Turn 2CH MIX off. 14
Sound is not heard from the surround back speaker.	▶	• The source may be stereo. Change the sound mode. 14
	▶	• Ensure the SPEAKERS (or Speaker Size) settings for your speakers are correct. 10,12
Cannot use Dolby Pro Logic II, NEO:6 or SFC.	▶	• Turn ENHANCED SURROUND on. 14
	▶	• Turn DVD 6CH INPUT off. 18
	▶	• You cannot use Dolby Pro Logic II, NEO:6 or SFC when input is PCM with sampling frequencies of 192, 176.4 (SA-XR45, OPTICAL2), 96, or 88.2 kHz. 14

Radio		Pages
The radio cannot be tuned in or there is a lot of noise and interference.	▶	• Connect the appropriate antenna. (You may need an outdoor antenna or one with more elements.) 8
	▶	• Adjust the position of the FM or AM antenna. 8
There is a lot of noise when listening to AM.	▶	• Reduce the treble. 21
	▶	• Turn off nearby televisions, video decks, DVD players, and satellite receivers. -
	▶	• Separate the antenna from other cables, cords, and appliances. -
	▶	• Try changing the A/D ATT (or A/D attenuation) setting. This may change the volume, but noise will also reduce. 20

The RESET function

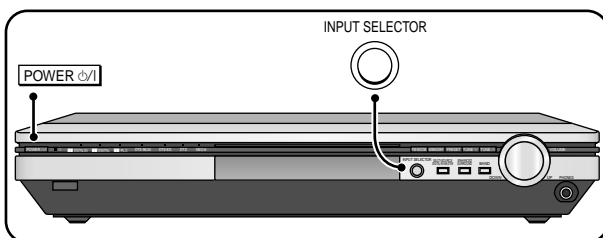

While the unit is on

While pressing and holding [INPUT SELECTOR], press [POWER ].

"RESET" appears on the display.

The operation settings for the unit will be initialized to the settings made at the time of shipment.

However, any preset radio stations will not be erased.

Maintenance

If the surfaces are dirty

To clean this unit, wipe with a soft, dry cloth.

- Never use alcohol, paint thinner or benzine to clean this unit.
- Before using chemically treated cloth, read the instructions that came with the cloth carefully.

Warranty (U.S.A.)

Panasonic Consumer Electronics Company,
Division of Matsushita Electric Corporation of America
One Panasonic Way Secaucus, New Jersey 07094

Panasonic Sales Company, Division of Matsushita Electric
of Puerto Rico, Inc.
Ave. 65 de Infantería, Km. 9.5
San Gabriel Industrial Park, Carolina, Puerto Rico 00985

Panasonic/Technics Audio Products Limited Warranty

Limited Warranty Coverage

If your product does not work properly because of a defect in materials or workmanship, Panasonic Consumer Electronics Company or Panasonic Sales Company (collectively referred to as "the warrantor") will, for the length of the period indicated on the chart below, which starts with the date of original purchase ("warranty period"), at its option either (a) repair your product with new or refurbished parts, or (b) replace it with a new or a refurbished product. The decision to repair or replace will be made by the warrantor.

Product or Part Name	Parts	Labor
Audio Products (except items listed below)	One (1) year	One (1) year
All Audio Racks (cabinets)	Thirty (30) days	Not Applicable
Technics Stand Alone Speakers, Subwoofer Speakers	Three (3) years	Three (3) years
USB Reader-Writer, Personal Computer Card Adapters (in exchange for defective item)	One (1) year	Not Applicable
Accessories: Headphones, Cartridges, Microphones, Adapters	Ninety (90) days	Ninety (90) days
Rechargeable Batteries (in exchange for defective item)	Ten (10) days	Not Applicable
SD Memory Cards, Rechargeable Battery Packs (in exchange for defective item)	Ninety (90) days	Not Applicable

During the "Labor" warranty period there will be no charge for labor. During the "Parts" warranty period, there will be no charge for parts. You must carry-in or mail-in your product during the warranty period. If non-rechargeable batteries are included, they are not warranted. This warranty only applies to products purchased and serviced in the United States or Puerto Rico. This warranty is extended only to the original purchaser of a new product which was not sold "as is". A purchase receipt or other proof of the original purchase date is required for warranty service.

Carry-In or Mail-In Service

This warranty In or Mail-In Service in the United States call 1-800-211-PANA (1-800-211-7262) or visit Panasonic web site: <http://www.panasonic.com>
For assistance in Puerto Rico call Panasonic Sales Company (787)-750-4300 or fax (787)-768-2910.

Limited Warranty Limits And Exclusions

This warranty ONLY COVERS failures due to defects in materials or workmanship, and DOES NOT COVER normal wear and tear or cosmetic damage. The warranty ALSO DOES NOT COVER damages which occurred in shipment, or failures which are caused by products not supplied by the warrantor, or failures which result from accidents, misuse, abuse, neglect, mishandling, misapplication, alteration, faulty installation, set-up adjustments, misadjustment of consumer controls, improper maintenance, power line surge, lightning damage, modification, or commercial use (such as in a hotel, office, restaurant, or other business), rental use of the product, service by anyone other than a Factory Servicenter or other Authorized Servicer, or damage that is attributable to acts of God.

THERE ARE NO EXPRESS WARRANTIES EXCEPT AS LISTED UNDER "LIMITED WARRANTY COVERAGE". THE WARRANTOR IS NOT LIABLE FOR INCIDENTAL OR CONSEQUENTIAL DAMAGES RESULTING FROM THE USE OF THIS PRODUCT, OR ARISING OUT OF ANY BREACH OF THIS WARRANTY. (As examples, this excludes damages for lost time, travel to and from the servicer, loss of media or images, data or other memory content. The items listed are not exclusive, but are for illustration only.) **ALL EXPRESS AND IMPLIED WARRANTIES, INCLUDING THE WARRANTY OF MERCHANTABILITY, ARE LIMITED TO THE PERIOD OF THE LIMITED WARRANTY.**

Some states do not allow the exclusion or limitation of incidental or consequential damages, or limitations on how long an implied warranty lasts, so the exclusions may not apply to you. This warranty gives you specific legal rights and you may also have others rights which vary from state to state. If a problem with this product develops during or after the warranty period, you may contact your dealer or Servicenter. If the problem is not handled to your satisfaction, then write to the warrantor's Consumer Affairs Department at the addresses listed for the warrantor.

PARTS AND SERVICE WHICH ARE NOT COVERED BY THIS LIMITED WARRANTY ARE YOUR RESPONSIBILITY.

Customer Services Directory (U.S.A.)

For Product Information, Operating Assistance, Literature Request, Dealer Locations, and all Customer Service inquiries please contact:

1-800-211-PANA (7262), Monday-Friday 9 am-9 pm; Saturday-Sunday 9 am-7 pm, EST.

or send e-mail:

consumerproducts@panasonic.com

For hearing or speech impaired TTY users, TTY: 1-877-833-8855

**Web Site: <http://www.panasonic.com>
You can purchase parts, accessories or locate your nearest servicenter by visiting our Web Site.**

Accessory Purchases:

1-800-332-5368 (Customer Orders Only)

For hearing or speech impaired TTY users, TTY: 1-866-605-1277

Panasonic Services Company 20421 84th Avenue South, Kent, WA 98032

(6 am to 5 pm Monday-Friday; 6 am to 10:30 am Saturday; PST)

(Visa, MasterCard, Discover Card, American Express, Check)

Service in Puerto Rico

**Matsushita Electric of Puerto Rico, Inc. Panasonic Sales Company/Factory Servicenter:
Ave. 65 de Infantería, Km. 9.5, San Gabriel Industrial Park, Carolina, Puerto Rico 00985
Phone (787) 750-4300 Fax (787) 768-2910**

Specifications (IHF'78)

■ AMPLIFIER SECTION

Rated minimum sine wave RMS power output	
20 Hz–20 kHz both channels driven	
0.3 % total harmonic distortion	100 W per channel (6 Ω)
1 kHz continuous power output both channels driven	
0.3 % total harmonic distortion	105 W per channel (6 Ω)
Total harmonic distortion	
rated power at 20 Hz–20 kHz	0.3 % (6 Ω)
Power output each channel driven	
0.9 % total harmonic distortion at 1kHz	
Front (L/R)	100 W (6 Ω)
Center	100 W (6 Ω)
Surround (L/R/BACK)	100 W (6 Ω)
Load impedance	
Front (L/R)	6–8 Ω
Center	6–8 Ω
Surround (L/R/BACK)	6–8 Ω
Frequency response	

SA-XR45 CD, TV, DVD/DVD 6CH, DVR/VCR, TAPE
10 Hz–44 kHz, ±3 dB

SA-XR25 CD, TV, DVD/DVD 6CH, VCR, TAPE 10 Hz–44 kHz, ±3 dB

Input sensitivity

SA-XR45 CD, TV, DVD/DVD 6CH, DVR/VCR, TAPE
27 mV (200 mV, IHF '66)

SA-XR25 CD, TV, DVD/DVD 6CH, VCR, TAPE
27 mV (200 mV, IHF '66)

Input impedance

SA-XR45 CD, TV, DVD/DVD 6CH, DVR/VCR, TAPE 22 kΩ

SA-XR25 CD, TV, DVD/DVD 6CH, VCR, TAPE 22 kΩ

S/N (IHF A)

SA-XR45 TV, DVD, DVR/VCR (Digital Input) 85 dB (98 dB, IHF '66)

SA-XR25 TV, DVD (Digital Input) 85 dB (98 dB, IHF '66)

Tone controls

BASS 50 Hz, +10 to –10 dB
TREBLE 20 kHz, +10 to –10 dB

Subwoofer frequency response (–6 dB) 7 Hz–200 Hz

Digital input (OPTICAL)		
SA-XR45 (DVD: Fs 192 kHz Ready)		3
SA-XR25		2
(COAXIAL)		1
Digital output (OPTICAL)		1

■ FM TUNER SECTION

Frequency range	87.9–107.9 MHz
Sensitivity	11.2 dBf (2 μV, IHF '58)
50 dB quieting sensitivity	
MONO	18.3 dBf (4.5 μV, IHF '58)
STEREO	38.3 dBf (45 μV, IHF '58)
Total harmonic distortion	
MONO	0.2 %
STEREO	0.3 %
S/N	
MONO	73 dB
STEREO	67 dB
Frequency response	20 Hz–15 kHz, +1 dB, –2 dB
Alternate channel selectivity	65 dB
Capture ratio	1.5 dB
Image rejection at 98 MHz	40 dB
Spurious response rejection at 98 MHz	75 dB
AM suppression	50 dB
Stereo separation	
1 kHz	40 dB
10 kHz	30 dB
Antenna terminal	75 Ω (unbalanced)

■ AM TUNER SECTION

Frequency range	530–1710 kHz
Sensitivity	20 μV, 330 μV/m
Selectivity	55 dB
IF rejection at 1000 kHz	50 dB

■ VIDEO SECTION

Output voltage at 1 V input (unbalanced)	1±0.1 Vp-p
Maximum input voltage	1.5 Vp-p
Input/output impedance	75 Ω

S-Video	Input	SA-XR45 TV, DVD, DVR/VCR
		SA-XR25 TV, DVD, VCR
	Output	TV MONITOR
Component Video	Input	TV, DVD
	Output	TV MONITOR

■ GENERAL

Power supply	AC 120 V, 60 Hz
Power consumption	130 W
Dimensions (W x H x D)	430 x 74 x 375 mm (16-15/16" x 2-29/32" x 14-3/4")

Mass	SA-XR45 4.2 kg (9.2 lb.)
	SA-XR25 4 kg (8.8 lb.)

■ DIN POWER

1 kHz, T. H. D 1 %	2 x 100 W (6 Ω)
---------------------------	-----------------

Power consumption in standby mode:	1 W
---	------------

Notes:

- Specifications are subject to change without notice. Mass and dimensions are approximate.
- Total harmonic distortion is measured by the digital spectrum analyzer.

Product Service

- Damage requiring service** — The unit should be serviced by qualified service personnel if:
 - The AC power supply cord or the plug has been damaged; or
 - Objects or liquids have gotten into the unit; or
 - The unit has been exposed to rain; or
 - The unit does not operate normally or exhibits a marked change in performance; or
 - The unit has been dropped or the cabinet damaged.
- Servicing** — Do not attempt to service the unit beyond that described in these operating instructions. Refer all other servicing to authorized servicing personnel.
- Replacement parts** — When parts need replacing ensure the servicer uses parts specified by the manufacturer or parts that have the same characteristics as the original parts. Unauthorized substitutes may result in fire, electric shock, or other hazards.

- Safety check** — After repairs or service, ask the servicer to perform safety checks to confirm that the unit is in proper working condition.

Product information

For product information or assistance with product operation: In the U.S.A., contact the Panasonic Customer Call Center at 1-800-211-7262, or e-mail consumerproducts@panasonic.com, or web site (<http://www.panasonic.com>). In Canada, contact Panasonic Canada Inc. Customer Care Centre at 905-624-5505, web site (www.panasonic.ca), or an authorized Servicentre closest to you.

Panasonic Consumer Electronics Company, Division of Matsushita Electric Corporation of America
One Panasonic Way Secaucus, New Jersey 07094
<http://www.panasonic.com>

Panasonic Sales Company, Division of Matsushita Electric of Puerto Rico, Inc. ("PSC")
Ave. 65 de Infantería, Km. 9.5 San Gabriel Industrial Park, Carolina, Puerto Rico 00985

Panasonic Canada Inc.
5770 Ambler Drive Mississauga, Ontario L4W 2T3
www.panasonic.ca



Free Manuals Download Website

<http://myh66.com>

<http://usermanuals.us>

<http://www.somanuals.com>

<http://www.4manuals.cc>

<http://www.manual-lib.com>

<http://www.404manual.com>

<http://www.luxmanual.com>

<http://aubethermostatmanual.com>

Golf course search by state

<http://golfingnear.com>

Email search by domain

<http://emailbydomain.com>

Auto manuals search

<http://auto.somanuals.com>

TV manuals search

<http://tv.somanuals.com>