

Panasonic®

Operating Instructions CD Stereo System



The illustrations show SC-AK340.

Model No. **SC-AK340**
SC-AK343
SC-AK240

For U.S.A.



As an ENERGY STAR® Partner, Panasonic has determined that this product meets the ENERGY STAR® guidelines for energy efficiency.



SC-AK343 is available in the U.S.A. only.

Table of contents

Listening caution	2
IMPORTANT SAFETY INSTRUCTIONS ..	3
Getting started	4
Placement of speakers	5
Overview of controls	6
Discs	7
Cassette tape – Play and record	10
Radio	12
Timer	13
Sound adjustment	14
External unit	15
Product Service	15
Maintenance	15
When moving the unit	15
Troubleshooting guide	16
Specifications	17
Limited Warranty (ONLY FOR U.S.A.)	18
Limited Warranty (ONLY FOR CANADA)	19

Español

Preparativos iniciales	20
Colocación de los altavoces	21
Controles	22
Discos	23
Cintas de casete – reproducción y grabación	24
Radio	25
Temporizador	26

Before connecting, operating or adjusting this product, please read the instructions completely.
Please keep this manual for future reference.

SUPPLIED ACCESSORIES

Please check and identify the supplied accessories. Use numbers indicated in parentheses when asking for replacement parts. (As of October 2005)
In the U.S.A. to order accessories, refer to “Accessory Purchases” on page 18.

1 x AC power supply cord

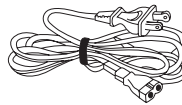

(K2CB2CB00018)

2 x Remote control batteries



1 x FM indoor antenna



(RSA0006-L)

1 x AM loop antenna



(N1DAAAA00001)

1 x Remote Control

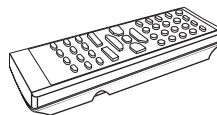

AK340 AK343

• Silver (N2QAHB000065)

For U.S.A. only

• Black (N2QAYB000028)

AK240

• Silver (N2QAHB000065)

Operations in these instructions are described mainly using remote control, but you can do the operations on the main unit if the controls are the same.

Unless otherwise indicated, illustrations in the operating instructions are of SC-AK340 for the U.S.A. and Canada.

Your unit may not look exactly the same as illustrated.

La guía rápida en español se encuentra en la página 20 - 27.

Dear customer

Thank you for purchasing this product. For optimum performance and safety, please read these instructions carefully.

These operating instructions are applicable to the following systems.

AK340 : indicates features applicable to SC-AK340 only.

AK343 : SC-AK343 only.

AK240 : SC-AK240 only.

System	SC-AK340	SC-AK343	SC-AK240
Main unit	SA-AK340	SA-AK343	SA-AK240
Speakers	SB-AK340	SB-AK340	SB-AK240

CAUTION!

THIS PRODUCT UTILIZES A LASER.

USE OF CONTROLS OR ADJUSTMENTS OR PERFORMANCE OF PROCEDURES OTHER THAN THOSE SPECIFIED HEREIN MAY RESULT IN HAZARDOUS RADIATION EXPOSURE.

DO NOT OPEN COVERS AND DO NOT REPAIR YOURSELF. REFER SERVICING TO QUALIFIED PERSONNEL.

WARNING:

TO REDUCE THE RISK OF FIRE, ELECTRIC SHOCK OR PRODUCT DAMAGE, DO NOT EXPOSE THIS APPARATUS TO RAIN, MOISTURE, DRIPPING OR SPLASHING AND THAT NO OBJECTS FILLED WITH LIQUIDS, SUCH AS VASES, SHALL BE PLACED ON THE APPARATUS.

CAUTION!

DO NOT INSTALL OR PLACE THIS UNIT IN A BOOKCASE, BUILT-IN CABINET OR IN ANOTHER CONFINED SPACE. ENSURE THE UNIT IS WELL VENTILATED. TO PREVENT RISK OF ELECTRIC SHOCK OR FIRE HAZARD DUE TO OVERHEATING, ENSURE THAT CURTAINS AND ANY OTHER MATERIALS DO NOT OBSTRUCT THE VENTILATION VENTS.

The socket outlet shall be installed near the equipment and easily accessible or the mains plug or an appliance coupler shall remain readily operable.

The model number and serial number of this product can be found on either the back or the bottom of the unit. Please note them in the space provided below and keep for future reference.

MODEL NUMBER _____

SERIAL NUMBER _____

User memo:

DATE OF PURCHASE _____

DEALER NAME _____

DEALER ADDRESS _____

TELEPHONE NUMBER _____

Listening caution



Selecting fine audio equipment such as the unit you've just purchased is only the start of your musical enjoyment. Now it's time to consider how you can maximize the fun and excitement your equipment offers. This manufacturer and the Electronic Industries Association's Consumer Electronics Group want you to get the most out of your equipment by playing it at a safe level. One that lets the sound come through loud and clear without annoying blaring or distortion - and, most importantly, without affecting your sensitive hearing.

We recommend that you avoid prolonged exposure to excessive noise.

Sound can be deceiving. Over time your hearing "comfort level" adapts to higher volumes of sound. So what sounds "normal" can actually be loud and harmful to your hearing.

Guard against this by setting your equipment at a safe level BEFORE your hearing adapts.

To establish a safe level:

- Start your volume control at a low setting.
- Slowly increase the sound until you can hear it comfortably and clearly, and without distortion.

Once you have established a comfortable sound level:

- Set the dial and leave it there.

Taking a minute to do this now will help to prevent hearing damage or loss in the future. After all, we want you listening for a lifetime.

THE FOLLOWING APPLIES ONLY IN THE U.S.A.

FCC Note:

This equipment has been tested and found to comply with the limits for a Class B digital device, pursuant to Part 15 of the FCC Rules.

These limits are designed to provide reasonable protection against harmful interference in a residential installation. This equipment generates, uses and can radiate radio frequency energy and, if not installed and used in accordance with the instructions, may cause harmful interference to radio communications. However, there is no guarantee that interference will not occur in a particular installation. If this equipment does cause harmful interference to radio or television reception, which can be determined by turning the equipment off and on, the user is encouraged to try to correct the interference by one or more of the following measures:

- Reorient or relocate the receiving antenna.
- Increase the separation between the equipment and receiver.
- Connect the equipment into an outlet on a circuit different from that to which the receiver is connected.
- Consult the dealer or an experienced radio/TV technician for help.

Any unauthorized changes or modifications to this equipment would void the user's authority to operate this device.

This device complies with Part 15 of the FCC Rules.

Operation is subject to the following two conditions:

- (1) This device may not cause harmful interference, and
- (2) this device must accept any interference received, including interference that may cause undesired operation.

Responsible Party:

Panasonic Corporation of North America

One Panasonic Way

Secaucus, NJ 07094

Telephone No.: 1-800-211-7262

IMPORTANT SAFETY INSTRUCTIONS

Read these operating instructions carefully before using the unit. Follow the safety instructions on the unit and the applicable safety instructions listed below. Keep these operating instructions handy for future reference.

- 1) Read these instructions.
- 2) Keep these instructions.
- 3) Heed all warnings.
- 4) Follow all instructions.
- 5) Do not use this apparatus near water.
- 6) Clean only with dry cloth.
- 7) Do not block any ventilation openings. Install in accordance with the manufacturer's instructions.
- 8) Do not install near any heat sources such as radiators, heat registers, stoves, or other apparatus (including amplifiers) that produce heat.
- 9) Do not defeat the safety purpose of the polarized or grounding-type plug. A polarized plug has two blades with one wider than the other. A grounding-type plug has two blades and a third grounding prong. The wide blade or the third prong are provided for your safety. If the provided plug does not fit into your outlet, consult an electrician for replacement of the obsolete outlet.
- 10) Protect the power cord from being walked on or pinched particularly at plugs, convenience receptacles, and the point where they exit from the apparatus.
- 11) Only use attachments/accessories specified by the manufacturer.
- 12) Use only with the cart, stand, tripod, bracket, or table specified by the manufacturer, or sold with the apparatus. When a cart is used, use caution when moving the cart/apparatus combination to avoid injury from tip-over.
- 13) Unplug this apparatus during lightning storms or when unused for long periods of time.
- 14) Refer all servicing to qualified service personnel. Servicing is required when the apparatus has been damaged in any way, such as power-supply cord or plug is damaged, liquid has been spilled or objects have fallen into the apparatus, the apparatus has been exposed to rain or moisture, does not operate normally, or has been dropped.



CAUTION

RISK OF ELECTRIC SHOCK
DO NOT OPEN

CAUTION: TO REDUCE THE RISK OF ELECTRIC SHOCK, DO NOT REMOVE SCREWS. NO USER-SERVICEABLE PARTS INSIDE. REFER SERVICING TO QUALIFIED SERVICE PERSONNEL.



The lightning flash with arrowhead symbol, within an equilateral triangle, is intended to alert the user to the presence of uninsulated "dangerous voltage" within the product's enclosure that may be of sufficient magnitude to constitute a risk of electric shock to persons.



The exclamation point within an equilateral triangle is intended to alert the user to the presence of important operating and maintenance (servicing) instructions in the literature accompanying the appliance.

– If you see this symbol –

Information on Disposal in other Countries outside the European Union



This symbol is only valid in the European Union.

If you wish to discard this product, please contact your local authorities or dealer and ask for the correct method of disposal.

Except for U.S.A.

CAUTION	– CLASS 1M INVISIBLE LASER RADIATION WHEN OPEN. DO NOT VIEW DIRECTLY WITH OPTICAL INSTRUMENTS. IEC60825-1+2:2001 Class 1M
WARNING	– KLASS 1M OSYNLIG LASERSTRÅLING NÅR DENNA DEL ÄR ÖPPNAD. BETRÄKTA EJ STRÅLEN DIREKT GENOM OPTISKT INSTRUMENT.
FORSIGTIG	– USYNLIG LASERSTRÅLING KLASSE 1M. NÅR LÅGET ER ÅBENT. UNDGÅ AT SE LIGE PÅ MED OPTISKE INSTRUMENTER.
VARO!	– AVATTRESSA OLET ALTIINLA LUKKAN 1M NÄR KÄÄNTÖNÄ LASERSÄTELYÄ. ÄLÄ KATSO OPTISKILÄITTELLÄ SUORAAN SÄTEESEEN.
VORSICHT	– UNSICHTBARE LASERSTRALUNG KLASSE 1M. WENN ABECKUNG GEÖFFNET, NICHT DIREKT MIT OPTISCHEN INSTRUMENTEN BETRACHTEN.
ATTENTION	– RAYONNEMENT LASER INVISIBLE. CLASSE 1M. EN CAS D'OUVERTURE, NE PAS REGARDER DIRECTEMENT À L'AIDE D'INSTRUMENTS D'OPTIQUE.
注意	– ここを開くと不可視レーザー光が出ます。ビームを見たり、触れたりしないでください。
注意	– 打开时有不可见激光辐射。避免光束照射。 GB7247.1-2001/38 类 RQLXS071

Inside of product

Getting started

Step 1 - Making the connections

Connect the AC power supply cord only after all other connections have been made.

1 Connect the speaker cords.

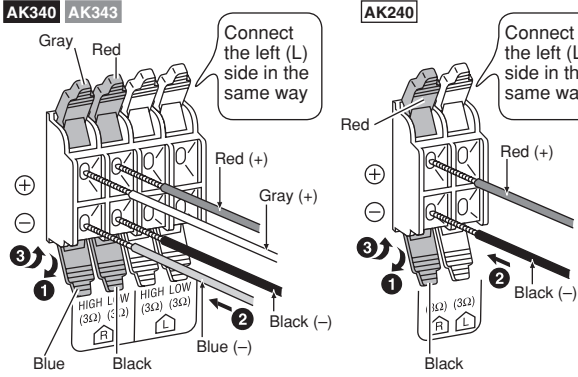

2 Connect the AM loop antenna.

Stand the antenna up on its base.

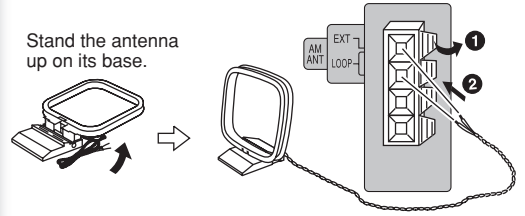

3 Connect the FM indoor antenna.

Tape the antenna where reception is best.

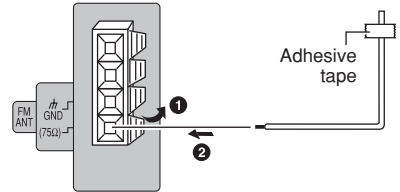

4 Connect the AC power supply cord.

For your reference

To save power when the unit is not to be used for a long time, unplug it from the household AC outlet. You will need to reset some memory items after plugging in the unit.

Note:

The included AC power supply cord is for use with this unit only. Do not use it with other equipment.

Optional antenna connections

Use outdoor antenna if radio reception is poor.

Note:

Disconnect the outdoor antenna when the unit is not in use. Do not use the outdoor antenna during a lightning storm.

FM outdoor antenna

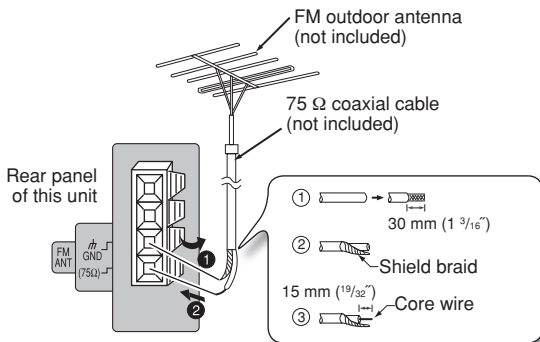

AM outdoor antenna

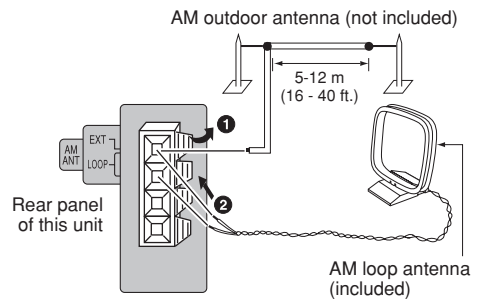

- Disconnect the FM indoor antenna.
- The antenna should be installed by a competent technician.

- Run a piece of vinyl wire horizontally across a window or other convenient location.
- Leave the loop antenna connected.

Step 2 - Inserting batteries into the remote control

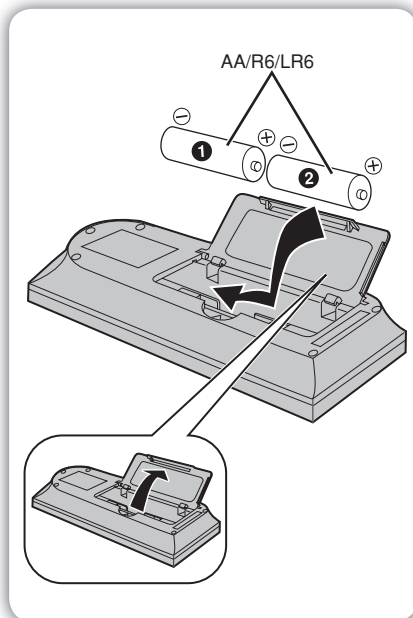

■ Batteries

- Insert so the poles (+ and –) match those in the remote control.
- Remove if the remote control is not going to be used for a long period of time. Store in a cool, dark place.
- Replace if the unit does not respond to the remote control even when held close to the front panel.
- Do not use rechargeable type batteries.
- Mishandling of batteries in the remote control can cause electrolyte leakage, which may cause a fire.
- If electrolyte leaks from the batteries, consult your dealer. Wash thoroughly with water if electrolyte comes in contact with any part of your body.

Do not:

- mix old and new batteries.
- use different types at the same time.
- heat or expose to flame.
- take apart or short circuit.
- attempt to recharge alkaline or manganese batteries.
- use batteries if the covering has been peeled off.
- put heavy objects on the remote control.
- spill liquids onto the remote control.

■ Use

Aim at the remote control sensor, avoiding obstacles, at a maximum range of 7 m (23 feet) directly in front of the unit. Refer to page 6 for the remote control sensor position.

Step 3 - DEMO function



When the unit is first plugged in, a demonstration of its functions may be shown on the display.

If the demo setting is off, you can show a demonstration by selecting "DEMO ON".

Press and hold [DISPLAY, –DEMO].

The display changes each time the button is held down.

NO DEMO (off) ↔ DEMO ON (on)

While in standby mode, select "NO DEMO" to reduce power consumption.

Note:

DEMO function cannot be turned on when DIMMER is on.

Placement of speakers

AK340 AK343

Place the front speakers so that the tweeter is on the inside.

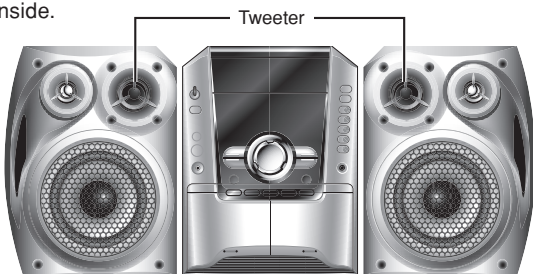

AK240

Speakers are designed identically so that no left or right channel orientation is necessary.



You cannot take the front net off the speakers.

Use only the supplied speakers.

The combination of the main unit and speakers provide the best sound. Using other speakers can damage the unit and sound quality will be negatively affected.

Note:

- Keep your speakers at least 10mm ($13/32$ ") away from the system for proper ventilation.
- These speakers do not have magnetic shielding. Do not place them near televisions, personal computers or other devices easily influenced by magnetism.
- You can damage your speakers and shorten their useful life if you play sound at high levels over extended periods.
- Reduce the volume in the following cases to avoid damage.
 - When playing distorted sound.
 - When adjusting the sound quality.



Caution

- Use the speakers only with the recommended system. Failure to do so can damage the amplifier and speakers, and can cause fire. Consult a qualified service person if damage occurs or if a sudden change in performance is apparent.
- Do not attach these speakers to walls or ceilings.

Overview of controls

Main unit

Refer to the numbers in parentheses for page reference.

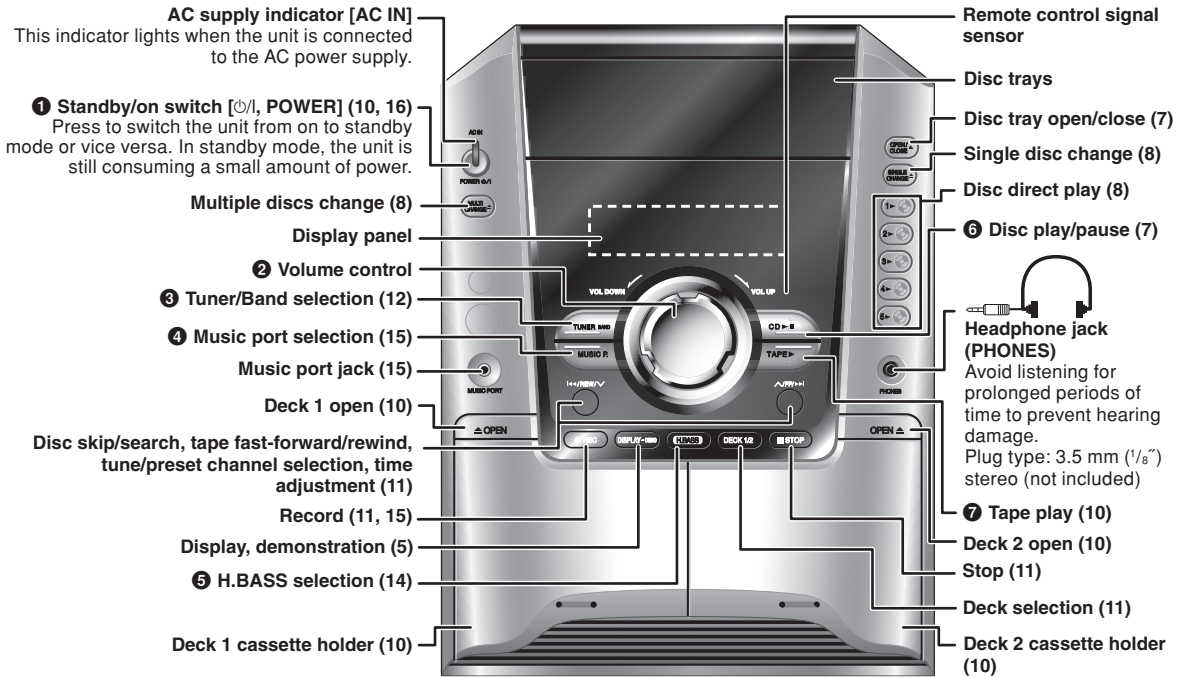

AK340 To select the desired display during play mode.
Each time you press the button: Normal → Reflection → (off)

Remote control

Buttons such as **1** function the same as the controls on the main unit.

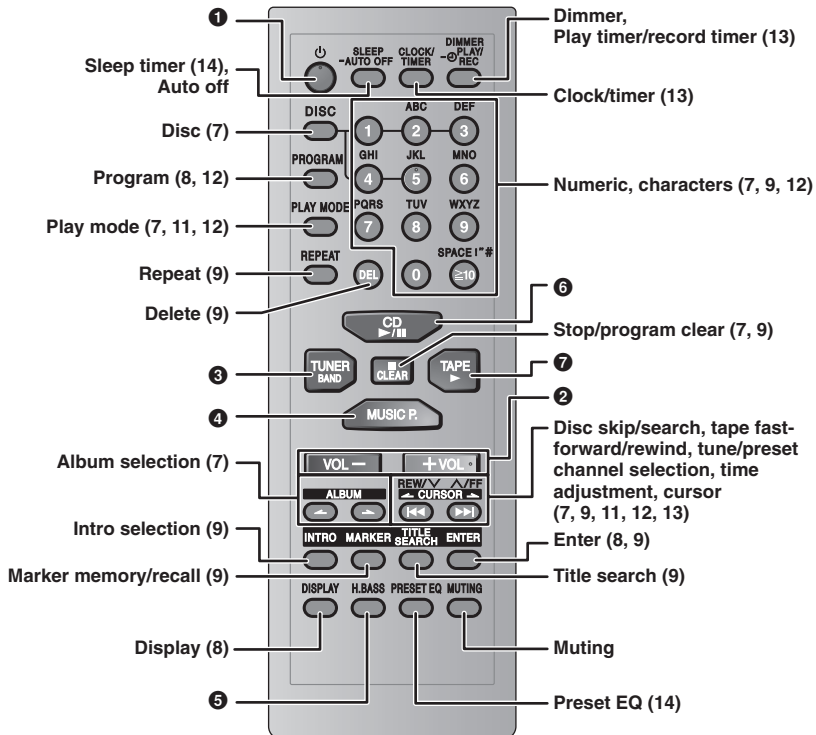

SLEEP -AUTO OFF
This auto off function allows you to turn off the unit in **disc or tape** mode only after left unused for 10 minutes.

- Press and hold [-AUTO OFF] to activate the function.
- Press and hold [-AUTO OFF] again to cancel.
- The setting is maintained even if the unit is turned off.

DIMMER -PLAY/REC
To dim the display panel.

MUTING
To mute the sound.

- Press the button to activate.
- Press again to cancel.

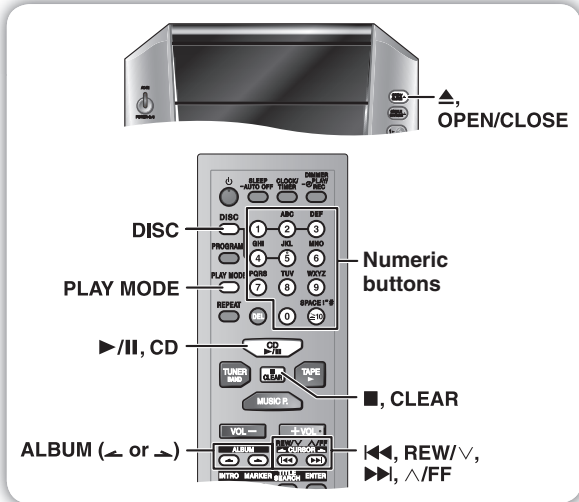

Basic play

- Press [**▲**, OPEN/CLOSE] on the main unit to open the tray.
The unit turns on, load a disc in the current tray with the label facing up.
Press [**▲**, OPEN/CLOSE] to close the tray.
- Press [**▶/II, CD**] to start play.
You can also press [DISC] and then [1] ~ [5] to select and play the other loaded discs.

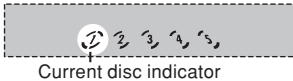

To	Action
stop play	Press [■ , CLEAR] during play. <div style="border: 1px solid black; padding: 2px; display: inline-block;">MP3 WMA</div> Display when in the stop mode: Example: "MP3" indicates the disc contains MP3 files. <div style="border: 1px solid black; padding: 5px; margin: 5px 0;"> MP3 0003 -- 1 129 1 DISC </div> Total number of albums Total number of tracks

pause play Press [**▶/II, CD**] during play.
Press again to resume play.

skip album

MP3 WMA

Press [ALBUM (← or →)] to select the desired album during play or when in stop mode.
Display when selecting in stop mode (example):

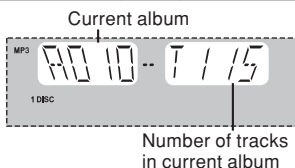

- This function does not work during 1-DISC RANDOM and ALL-DISC RANDOM mode. It is applicable only during program stop mode.

skip tracks Press [**◀◀**, REW/∨] or [**▶▶**, ∨/FF].
 • During random play (⇒ see below, "Play Mode function"), you cannot skip to tracks which have been played.

MP3

WMA

During 1-ALBUM and 1-ALBUM RANDOM mode, track skipping can only be done within the current album.

search through tracks

CD

Press and hold [**◀◀**, REW/∨] or [**▶▶**, ∨/FF] during play or pause to search.
 • During program play (⇒ page 8), or random play (⇒ see below, "Play Mode function"), you can search only within the track.

Play Mode function

CD

MP3

WMA

You can listen to specific discs and tracks.

Preparation

Select and play your desired disc.

Press [PLAY MODE] to select the desired mode.

Mode	To play
1-DISC 1 DISC	one selected disc.
1-DISC RANDOM 1 DISC RND	one selected disc randomly.
ALL-DISC ALL DISC	all loaded discs in succession from the selected disc to the final disc. Example: 4→5→1→2→3.
ALL-DISC RANDOM ALL DISC RND	all loaded discs randomly.
1-SONG 1 SONG	one selected track on the selected disc.
<div style="border: 1px solid black; padding: 2px; display: inline-block;">CD</div>	Press the numeric buttons to select the track in the current disc. Play starts from the selected track.
<div style="border: 1px solid black; padding: 2px; display: inline-block;">MP3</div> <div style="border: 1px solid black; padding: 2px; display: inline-block;">WMA</div>	Press [ALBUM (← or →)] to select the album. Press the numeric buttons to select the track in the current album. Play starts from the selected track.
1-ALBUM 1-ALBUM	one selected album on the selected disc. Press [ALBUM (← or →)] to select the album.
<div style="border: 1px solid black; padding: 2px; display: inline-block;">MP3</div> <div style="border: 1px solid black; padding: 2px; display: inline-block;">WMA</div>	
1-ALBUM RANDOM 1-ALBUM RND	all tracks in one selected album randomly. Press [ALBUM (← or →)] to select the album.
<div style="border: 1px solid black; padding: 2px; display: inline-block;">MP3</div> <div style="border: 1px solid black; padding: 2px; display: inline-block;">WMA</div>	

When playback ends

The current play mode will be retained in memory until it is changed even if the unit is turned off.

Note:

You cannot use program mode together with "Play Mode function".

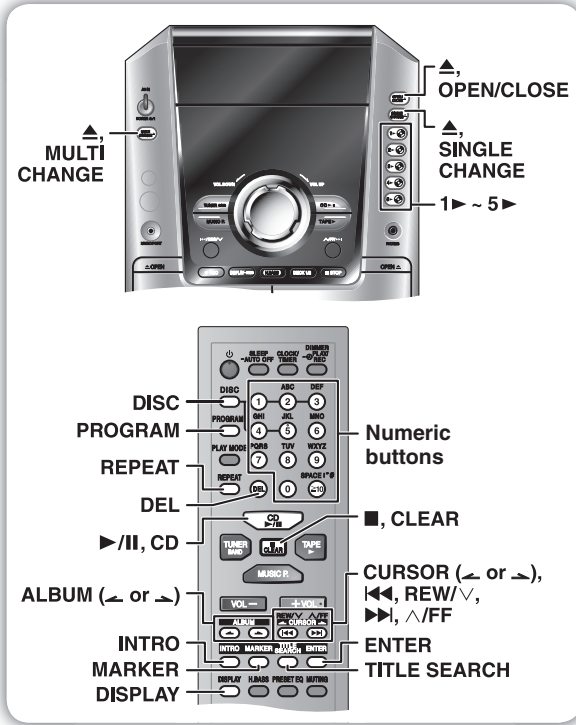

Note:

CD

- When track number 25 or greater is playing, remaining play time display shows “--:--”.

MP3 WMA

- When a title is longer than 9 characters, it will scroll across the display. The scrolling will start after every 3 seconds.
- “NO TAG” is displayed if titles with tags have not been entered.
- Maximum number of displayable characters: approximately 32
- This unit can display album, track and artist name with WMA tags and MP3 ID3 tags (version 1.0 and 1.1).
- Titles containing text data that the unit does not support cannot be displayed.
- ID3 is a tag embedded in MP3 track to provide information about the track.
- Titles entered with 2-byte code cannot be displayed correctly on this unit.

Advanced play

Program play

CD MP3 WMA

This function allows you to program up to 24 tracks.

CD

- 1 Press [**>||**, **CD**] and then [**■**, **CLEAR**].
- 2 Press [**PROGRAM**].
“PGM” appears.
- 3 Press [**DISC**] and then [**1**] ~ [**5**] to select the disc.
- 4 Press the numeric buttons to select your desired track.
Repeat steps 3 to 4 to program other tracks.
- 5 Press [**>||**, **CD**] to start play.

MP3 WMA

- 1 Press [**DISC**] and then [**1**] ~ [**5**] to select the disc.
- 2 Press [**■**, **CLEAR**].
- 3 Press [**PROGRAM**].
- 4 Press [**ALBUM** (**<** or **>**)] to select your desired album.
To select an album directly, press the numeric buttons after pressing [**ALBUM** (**<** or **>**)].
- 5 Press [**<<<**, **REW**/**√**] or [**>>>**, **^**/**FF**] to select the track.
To select a track directly, press the numeric buttons after pressing [**<<<**, **REW**/**√**] or [**>>>**, **^**/**FF**].
- 6 Press [**ENTER**].
Repeat steps 4 to 6 to program other tracks.
- 7 Press [**>||**, **CD**] to start play.

For two-digit track, press [**≥10**] once then the two digits.
For three-digit track, press [**≥10**] twice then the three digits.

Changing multiple discs (MULTI CHANGE)

By main unit only

- 1 Press [**▲**, **MULTI CHANGE**] to open the trays.
- 2 Press the button repeatedly to check and change multiple discs.

Note:

- The tray with a disc being played will not open.
- If the player is stopped, all trays will open. To close the remaining trays simultaneously, press [**▲**, **OPEN/CLOSE**].

Changing a single disc (SINGLE CHANGE)

By main unit only

While one disc is playing, you can change the discs in other trays.

- 1 Press [**▲**, **SINGLE CHANGE**].
- 2 Press [**1**] ~ [**5**] to select the desired tray.
- 3 Change the disc.
- 4 Press [**▲**, **SINGLE CHANGE**] again to close the tray.

Checking the track information **CD MP3 WMA**

You can select a desired disc display mode.

AK340 AK343 AK240

Press [**DISPLAY**] during play or pause.

AK240

Press [**DISPLAY**, **-DEMO**] on the main unit during play or pause.

CD

Elapsed play time ↔ Remaining play time

MP3 WMA

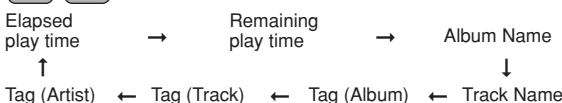

To	Action
cancel program mode	Press [PROGRAM] in the stop mode.
reply the program	Press [PROGRAM] then [> , CD] in the stop mode.
add to the program	CD Repeat steps 3 to 4 in the stop mode. MP3 WMA Repeat steps 4 to 6 in the stop mode.

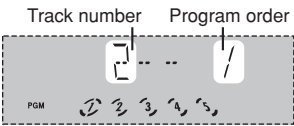
To	Action
check program contents	Press [◀◀ , REW/∨] or [▶▶ , ∨/FF] when "PGM" is displayed in the stop mode. CD The track number, program order and disc number are displayed: 
clear the last track	Press [DEL] in the stop mode.
clear all programmed tracks	Press [■ , CLEAR] in the stop mode. "CLEAR ALL" is displayed. Within 5 seconds, press the button again to clear all tracks.

Note:

- You cannot program CD-DA together with MP3 or WMA tracks.

MP3 WMA

- The program memory is cleared when you change a disc or open the disc tray.
- You cannot program more than one disc for MP3 or WMA.

Repeat play **CD MP3 WMA**

You can repeat program play or other selected play mode. Press [**REPEAT**]. "◻" is displayed. **To cancel** Press [**REPEAT**] again. "◻" is cleared.

Note: You can use repeat mode with "Program play" (→ page 8) and "Play Mode function" (→ page 7).

Marking a track **CD MP3 WMA**

Enables you to mark one track for each loaded disc so that you can directly play the track later. **During play, press and hold the [MARKER] until "STORING" blinks on the display to mark your favorite track.** Press [**MARKER**] during play or stop mode to recall and play a marked track.

Note:

- "NO MARKER" indicates that the marker in the current disc is empty.
- The marker memory is cleared when you open the disc trays except for the current disc which is in play or pause mode.
- This function does not work during any random/program mode.

Advanced function ((MP3 WMA only)

Album scan

This function allows you to find an album by listening to the first track of all albums in the current disc for 10 seconds each.

- Press [**▶/II**, CD] and then [**■**, CLEAR].
- Press [**INTRO**] to start the intro function.
- While your desired album is playing, press [**▶/II**, CD]. Intro mode is canceled and the playback continues.

INTRO function is canceled after playing the first track in the last album. To stop during the process, press [**INTRO**] or [**■**, CLEAR].

Note: This function does not work during any random/program mode.

Album/Track title search

This function enables you to search your desired album or track.

- Press [**▶/II**, CD] and then [**■**, CLEAR].
- For album title search, press [**TITLE SEARCH**] once. For track title search, press [**TITLE SEARCH**] twice.
- Press the numeric buttons repeatedly to select your desired character then press [**CURSOR →**] to key in the next character.
 - You can enter up to 8 characters.
 - To edit, press [**CURSOR (← or →)**] to revise any characters.
 - To delete, move the cursor over the character and then press [**DEL**].

Numbered buttons	Characters	Numbered buttons	Characters
1	1	6	M N O 6
2	A B C 2	7	P Q R S 7
3	D E F 3	8	T U V 8
4	G H I 4	9	W X Y Z 9
5	J K L 5	0	0
≥10	space ! " # \$ % & ' () * + , - . / : ; = ? _ `		

You can search for "<" or ">" by entering "(" or ")". The special characters will be displayed as below:

Characters	Main unit display	Characters	Main unit display
!	∇	,	,
"	∥	-	--
#	∥∥	.	.
\$	∥∥	/	/
%	∥∥	:	:
&	∥∥	;	;
'	'	=	==
((?	?
))	-	-
*	*	`	∥∥
+	+		

Some characters may not be displayed correctly due to the recording format/software used.

- Press [**ENTER**]. Press [**◀◀**, REW/∨] or [**▶▶**, ∨/FF] to search for previous or next match. The match title is displayed.

Album title search
 Blinks to indicate album title search mode

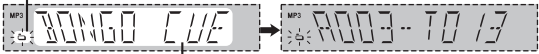

Matched album title

Track title search
 Blinks to indicate track title search mode

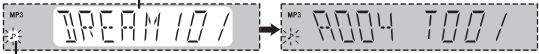

Matched track title

- Press [**▶/II**, CD] to start play from the album/track found.

Note: This function does not work during any random/program mode.

NOTE on CDs

- This unit can access up to 99 tracks.
- Choose disc with this mark.



- This unit can play MP3 or WMA files and CD-DA format audio CD-R/RW that have been finalized.
- It may not be able to play some CD-R/RW due to the condition of the recording.
- Do not use irregularly shaped disc.
- Do not use disc with labels and stickers that are coming off or with adhesive exuding from under labels and stickers.
- Do not attach extra labels or stickers on the disc.
- Do not write anything on the disc.

Using DualDiscs

The "CD" sides of DualDiscs do not meet the CD-DA standard so it may not be possible to play them on this unit.

Not doing the following will cause damage to the unit.

Removing the power plug

- Press [⏻/I, POWER] to turn off the unit and then remove the power plug only after all the displays have disappeared.

Tray caution



- Always press [▲, OPEN/CLOSE] to insert or remove a disc.
- Do not push or pull out the tray by hand as this will cause an accident.

Inserting a disc



- Place the disc correctly label-up as shown in the diagram.
- Insert one disc into the tray.

NOTE on MP3 or WMA

- Files are treated as tracks and folders are treated as albums.
- This unit can access up to 999 tracks, 255 albums and 20 sessions.
- Disc must conform to ISO9660 level 1 or 2 (except for extended formats).
- To play in a certain order, prefix the folder and file names with 3-digits numbers in the order you want to play them.

MP3

When "NOT MP3/ERROR1" appears on the display, an unsupported MP3 format is being played. The unit will skip that track and play the next one.

WMA

- Noise may occur when playing WMA files.
- This unit cannot play WMA files that are copy protected.

Limitations on MP3 or WMA play

- If you have recorded MP3 or WMA on the same disc as CD-DA, only the format recorded in the first session can be played.
- Some MP3 or WMA may not be played due to the condition of the disc or recording.
- Due to differences and variations of WMA tags, some files may not play or display the tags' information properly.
- Recordings will not necessarily be played in the order you recorded them.

MPEG Layer-3 audio decoding technology licensed from Fraunhofer IIS and Thomson multimedia.

Windows Media, and the Windows logo are trademarks, or registered trademarks of Microsoft Corporation in the United States and/or other countries.



WMA is a compression format developed by Microsoft Corporation. It achieves the same sound quality as MP3 with a file size that is smaller than that of MP3.

Cassette tape – Play and record

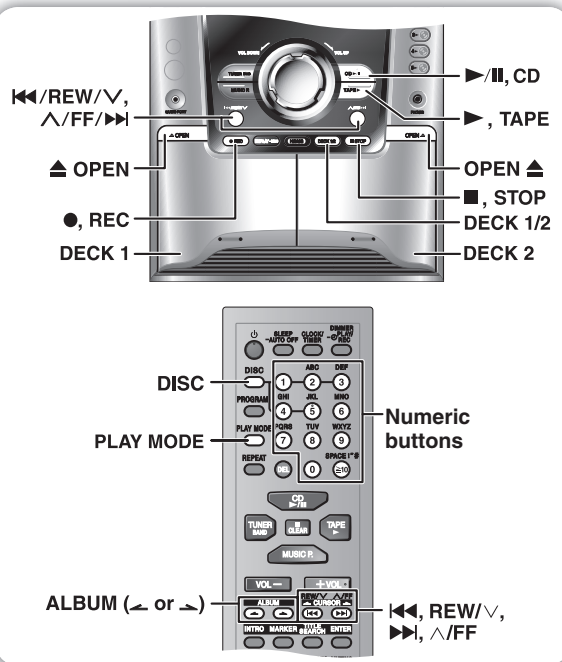

The buttons described for "Cassette tape – Play and record" are mainly for the main unit unless indicated otherwise.

Basic play

You can use either DECK 1 or DECK 2 for tape playback. Use normal position tapes. High position and metal position tapes can be played, but the unit will not be able to do full justice to the characteristics of these tapes.

1 Press [▶, TAPE].

The unit turns on. If a cassette was loaded, play starts automatically (One touch play).

2 Press [▲ OPEN] for DECK 1 or [OPEN ▲] for DECK 2 and insert the cassette.

Insert with the side to be played facing towards you and the exposed tape facing down. Close the holder by hand.

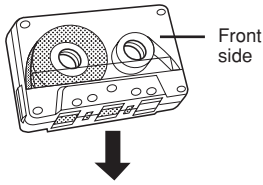

3 Press [▶, TAPE] to start play.

To	Action
stop tape playback	Press [■, STOP].
fast-forward and rewind	Press [◀◀/REW/∨] or [∧/FF/▶▶].
select between loaded decks	Press [DECK 1/2] (remote control : [PLAY MODE]).

Note:

- Tape playback is momentarily interrupted if you open the other deck.
- Tapes exceeding 100 minutes are thin and can break or get caught in the mechanism.
- Tape slack can get caught up in the mechanism and should be wound up before the tape is played.
- Endless tapes can get caught up in the deck's moving parts if used incorrectly.

Recording

Selection of tapes for recording

Use normal position tapes. High position and metal position tapes can be used, but this unit will not be able to record or erase them correctly.

Preparation

Wind up the leader tape so recording can begin immediately.

1 Press [OPEN ▲] for DECK 2 and insert the cassette to be recorded.

Insert with the side to be recorded facing towards you and the exposed tape facing down.

2 Select the source to be recorded.

Radio recording:

Tune in the station. (→ page 12)

Disc recording:

- 1 Insert the disc(s) you want to record. Press [▶/II, CD] and then [■, STOP].
- 2 Prepare the desired disc recording mode.

To	Action
record programmed tracks	<p>[CD]</p> <p>Perform steps 2 to 4 in "Program play" (→ page 8).</p> <p>[MP3] [WMA]</p> <p>Perform steps 3 to 6 in "Program play" (→ page 8).</p>

By remote control only

- record specific discs/tracks
- 1 Press [DISC] and then [1] ~ [5] to select the disc. Ensure disc is stopped.
 - 2 Press [PLAY MODE] to select the desired mode (→ page 7).
 - 3 [MP3] [WMA]
 - For 1-ALBUM mode and 1-SONG mode: Press [ALBUM (◀ or ▶)] to select the album.
 - [CD] [MP3] [WMA]
 - For 1-SONG mode: Press [◀◀, REW/∨] or [▶▶, ∧/FF] to select the track.

Tape-to-tape recording:

- 1 Press [▶, TAPE] and then [■, STOP].
- 2 Press [▲ OPEN] for DECK 1 and insert the cassette to record.

3 Press [●, REC] to start recording.

Other basic operations

To	Action
stop recording	Press [■, STOP].
record on the other side of the tape	Turn the cassette over and press [●, REC].
erase a recorded sound	<ol style="list-style-type: none"> 1) Press [▶, TAPE] and then [■, STOP]. 2) Insert the recorded cassette into DECK 2. Ensure there is no cassette in DECK 1. 3) Press [●, REC].

Note:

- Changes to volume and sound adjustments quality do not affect recording.
- You cannot open DECK 1 while recording.
- You cannot fast-forward or rewind one deck while recording with the other.

Erasure prevention

The illustration shows how to remove the tabs to prevent recording. To record on the tape again, cover as shown.

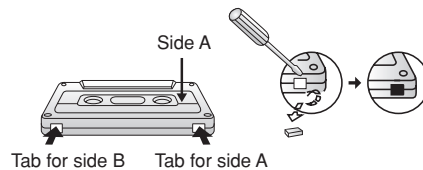

To re-record Normal cassette



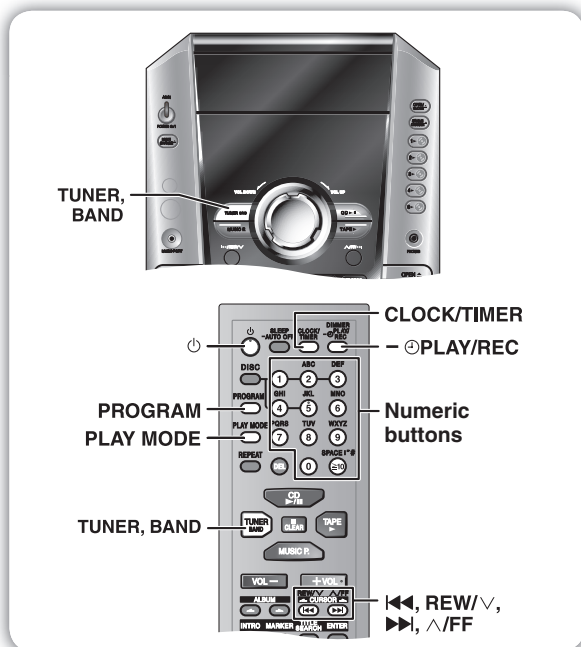

Manual tuning

- 1 Press [TUNER, BAND] to select "FM" or "AM".
- 2 Press [PLAY MODE] to select "MANUAL".
- 3 Press [◀, REW/√] or [▶, ^/FF] to select the frequency of the required station.
 - "ST" is displayed when a stereo FM broadcast is being received.
 - "TUNED" is displayed when a radio station is tuned.

To tune automatically

Press and hold [◀, REW/√] or [▶, ^/FF] until the frequency starts changing rapidly. The unit begins auto tuning, stopping when it finds a station.

- Auto tuning may be interrupted when there is excessive interference.
- To cancel auto tuning, press [◀, REW/√] or [▶, ^/FF] once again.

To improve FM sound quality

Press and hold [PLAY MODE] to display "MONO".

To cancel

Press and hold [PLAY MODE] again until "MONO" disappear.

- MONO is also canceled if the frequency is changed.
- Turn off "MONO" for normal listening.

FM allocation setting

By main unit only

This system can also receive FM broadcasts allocated in 0.1 MHz steps.

To change the step to 0.1 MHz

- 1 Press and hold [TUNER, BAND]. After a few seconds the display changes to a flashing display of the current minimum frequency.
- 2 Continue to hold down [TUNER, BAND].
 - When the minimum frequency changes, release the button. To return to the original step, repeat the above steps.
 - After changing the setting, previously preset frequency will be cleared.

Memory preset

Up to 15 stations each can be set in the FM and AM bands.

Preparation

Press [TUNER, BAND] to select "FM" or "AM".

Automatic presetting

- 1 Tune to the frequency where pre-setting is to begin.
- 2 Press and hold [PROGRAM] to start presetting.

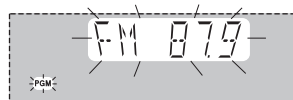

The tuner presets all the stations it can receive into the channels in ascending order. When finished, the last station memorized is tuned in.

Manual presetting

- 1 Press [PLAY MODE] to select "MANUAL".
- 2 Press [◀, REW/√] or [▶, ^/FF] to tune to the required station.
- 3 Press [PROGRAM].
- 4 Press the numeric buttons to select a channel. For channels 10 to 15 press [≥10], then the two digits. The station occupying a channel is erased if another station is preset in that channel.

Selecting a preset station

Press the numeric buttons to select the channel.



OR

- 1 Press [PLAY MODE] to select "PRESET".
- 2 Press [◀, REW/√] or [▶, ^/FF] to select the channel.

Setting the clock

This is a 12-hour clock.

1 Press [CLOCK/TIMER] to select "CLOCK".

Each time you press the button:



2 (Within 8 seconds or so)

Press [◀, REW/↶] or [▶, ⏭/FF] to set the time.

3 Press [CLOCK/TIMER] to finish setting the time.

Displaying the clock

Press [CLOCK/TIMER] once when the unit is on or in standby mode.

The time is displayed for a few seconds.

Note:

Reset the clock regularly to maintain accuracy.

Using the play or record timer

You can set the timer to come on at a certain time to wake you up (play timer) or to record from the radio or music port source (record timer).

Play timer and record timer cannot be used together.

Turn the unit on and set the clock.

Timer	Action
Play timer	Prepare the music source you want to listen to; cassette (DECK 2 has the priority), disc number (1~5), radio or music port source, and set the volume.
Record timer	Check the cassette's erasure prevention tabs (➡ page 11), insert the cassette in DECK 2 and tune to the radio station (➡ page 12) or select the music port source (➡ page 15).

1 Press [CLOCK/TIMER] to select the timer function

Each time you press the button:



ⓄPLAY : to set the play timer

ⓄREC : to set the record timer

(Proceed to the next step **within 8 seconds**)

2 Press [◀, REW/↶] or [▶, ⏭/FF] to set the starting time.

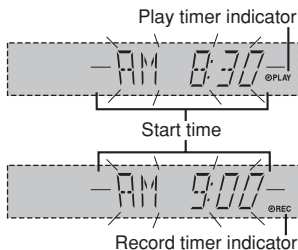

3 Press [CLOCK/TIMER] to confirm.

4 Repeat steps 2 to 3 to set the finishing time.

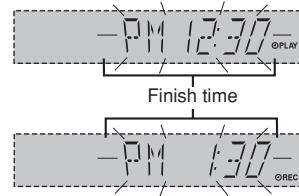

To activate the timer

5 Press and hold [-ⓄPLAY/REC] to turn on your desired timer.



6 Press [Ⓞ] to turn off the unit.

The unit must be off for the timers to operate.

Other basic operations

To	Action
change the settings	Repeat steps 1 to 4 and 6 (➡ see left and above).
change the source or volume	1) Press and hold [-ⓄPLAY/REC] to clear the timer indicator from the display. 2) Make changes to the source or volume. 3) Do steps 5 to 6 (➡ see above).
check the settings	Press [CLOCK/TIMER] repeatedly to select ⓄPLAY or ⓄREC.
cancel	Press and hold [-ⓄPLAY/REC] to clear the timer indicators from the display.

If you use the unit after the timers are set

After using, check that the correct tape/disc are loaded before turning the unit off.

Note:

- The play timer will start at the preset time with volume increasing gradually to preset level.
- The record timer will start 30 seconds before the set time with the volume muted.
- The timer comes on at the set time everyday if the timer is on.
- The unit must be in the standby mode for the timer to function.
- If you turn the unit off and on again while a timer is functioning, the finish time setting will not be activated.
- If MUSIC PORT is selected as the source when the timer comes on, the system turns on and engages MUSIC PORT as the source. If you wish to playback or record from the portable audio equipment, just activate the equipment's play mode and increase the volume. (See the portable audio equipment's instruction manual.)

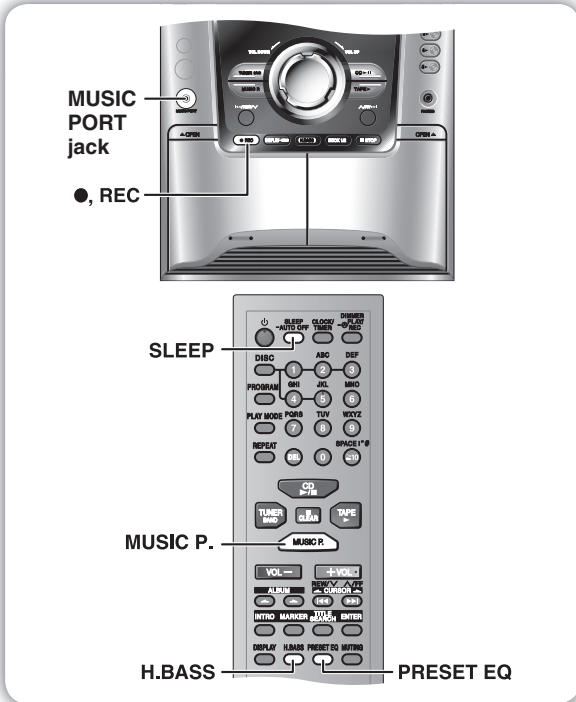

Using the sleep timer

This function enables you to turn off the unit automatically after the set time.

Press [SLEEP] to select your desired time.

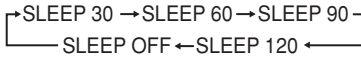

Sleep timer indicator

To cancel

Press [SLEEP] to select "SLEEP OFF".

Changing the remaining time

Press [SLEEP] to show the remaining time and press [SLEEP] again to select your desired time.

Note:

- The play and sleep timer or the record and sleep timer can be used together.
- The sleep timer always has priority. Be sure not to overlap timer settings.
- The sleep timer turns off when you perform the record function.

Sound adjustment

Selecting sound effects

Preset EQ

Press [PRESET EQ] repeatedly to select your desired setting.

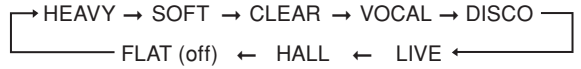

Setting	Effect
HEAVY	Adds punch to rock
SOFT	For background music
CLEAR	Clarifies higher frequencies
VOCAL	Adds gloss to vocal
DISCO	Produces sound with the same kind of lengthy reverberations heard at a disco
LIVE	Makes vocals more alive
HALL	Adds an expansiveness to the sound to produce the atmosphere of a great concert hall
FLAT	No effect

Enhancing the bass sound

You can enhance low-frequency sound so that heavy bass sound can be heard clearly, even if the acoustics of your room are not optimal.

To activate

Press [H.BASS].

To cancel

Press [H.BASS] again.

Note:

The actual effect depends on the disc.

External unit

Connecting to a portable audio equipment

This feature enables you to enjoy music from a portable audio equipment.



Playing from a portable audio equipment

Switch off the equalizer function (if there is any) of the portable audio equipment before you plug into the MUSIC PORT jack. Otherwise, sound from the speaker may be distorted.

- 1 Plug the audio cord into the MUSIC PORT jack and press [MUSIC P.].
- 2 Play the portable audio equipment. (See the portable audio equipment's instruction manual.)

Note:

All peripheral components and cables are sold separately.

Recording from a portable audio equipment

- 1 Press [MUSIC P.].
- 2 Play the portable audio equipment.
- 3 Press [●, REC] on the main unit to start recording.

Product Service

1. **Damage requiring service** - The unit should be serviced by qualified service personnel if:
 - (a) The AC power supply cord or the plug has been damaged; or
 - (b) Objects or liquids have gotten into the unit; or
 - (c) The unit has been exposed to rain; or
 - (d) The unit does not operate normally or exhibits a marked change in performance; or
 - (e) The unit has been dropped or the cabinet damaged.
2. **Servicing** - Do not attempt to service the unit beyond that described in these operating instructions. Refer all other servicing to authorized servicing personnel.
3. **Replacement parts** - When parts need replacing ensure the servicer uses parts specified by the manufacturer or parts that have the same characteristics as the original parts. Unauthorized substitutes may result in fire, electric shock, or other hazards.

4. **Safety check** - After repairs or service, ask the servicer to perform safety checks to confirm that the unit is in proper working condition.

The servicer will require all components to service your system.

Therefore, should service ever be necessary, be sure to bring the entire system.

Product information

For product information or assistance with product operation:

In the U.S.A., refer to "Customer Services Directory" on page 18.

In Canada, contact the Panasonic Canada Inc. Customer Care Centre at 905-624-5505, or visit the website (www.panasonic.ca), or an authorized Servicentre closest to you.

Maintenance

If the surfaces are dirty

To clean this unit, wipe with a soft, dry cloth.

- Never use alcohol, paint thinner or benzine to clean this unit.
- Before using chemically treated cloth, read the instructions that came with the cloth carefully.

For a cleaner crisper sound (cassette deck)

Clean the heads regularly to assure good quality playback and recording. Use a cleaning tape (not included).

When moving the unit

- 1 Remove all discs.
- 2 Press [⏻/I, POWER] to turn the unit off.
- 3 Disconnect the AC power supply cord.

Troubleshooting guide

Before requesting service, make the following checks. If you are in doubt about some of the check points, or if the remedies indicated in the chart do not solve the problem, refer to the “Customer Services Directory” on page 18 if you reside in the U.S.A., or refer to the “Product information” on page 15 if you reside in Canada.

Reference pages are shown as black circled numbers ④.

Common problems

Although the unit is in standby mode, the display lights up and changes continuously.	Turn off the demo function. ⑤ If you set the clock, demo function will be turned off automatically. ⑫
No sound. Sound stops.	Turn the volume up. Switch off the unit, determine and correct the cause, then switch the unit on. Causes include shorting of the positive and negative speaker wires, straining of the speakers through excessive volume or power, and using the unit in a hot environment.
Sound is unfixed, reversed or comes from one speaker only.	Check the speaker connections. ④
Humming heard during play.	An AC power supply cord or fluorescent light is near the cables. Keep other appliances and cords away from this unit's cables.
“ERROR” is displayed.	Incorrect operation performed. Read the instructions and try again.
“-- --” appears on the display at standby mode.	You plugged the AC power supply cord in for the first time or there was a power failure recently. Set the time. ⑫
“F61” is displayed.	Check and correct the speaker cords connection. ④ If this does not fix the problem, there is a power supply problem. Consult the dealer.

Listening to the radio

Noise is heard. The stereo indicator flickers or doesn't light. Sound is distorted.	Use an outdoor antenna. ④
A beat sound is heard.	Turn the TV off or separate it from the unit.
A low hum is heard during AM broadcast.	Separate the antenna from other cables and cords.

When there is a television set nearby

The picture on the TV disappears or stripes appear on the screen.	The location and orientation of the antenna are incorrect. If you are using an indoor antenna, change to an outdoor antenna. The TV antenna wire is too close to the unit. Separate the antenna wire of the TV set from the unit.
---	--

Using the cassette deck

Poor quality sound.	Clean the heads. ⑫
Recording is not possible.	If the erasure prevention tabs have been removed, cover the holes with adhesive tape. ①

Playing discs

The display is wrong or play won't start.	The disc may be upside down. ⑩ Wipe the disc. Replace the disc if it is scratched, warped, or non-standard. Condensation may have formed inside the unit due to a sudden change in temperature. Wait for about an hour for it to clear and try again.
The total number of tracks displayed differs each time the same disc is inserted. Unusual sound is heard.	The disc may be scratched, or its data may be defective. Replace the disc.
CD-RW cannot be read.	The disc was incompletely formatted. Use the recording equipment to fully format the disc before recording.
“VBR--” is displayed instead of the remaining play time.	The unit cannot display the remaining play time for variable bit rate (VBR) tracks.

Disc trays

Disc tray(s) cannot open. “CHGR ERR” is displayed.	Press [⏏/I, POWER] to release the jammed tray(s) as the unit will switch off. Switch it on again and the tray(s) will initialize to the previous tray(s) condition. If this still does not fix the problem, please consult the dealer.
---	---

Remote control

Remote control doesn't work.	Check that the batteries are inserted correctly. ⑤ Replace the batteries if they are worn.
------------------------------	---

Memory reset (Initialization)

When the following situations occur, refer to the instructions below to reset the memory:

- There is no response when buttons are pressed.
- You want to clear and reset the memory contents.

To reset memory

- 1 Disconnect the AC power supply cord. (Wait at least 3 minutes before proceeding to step 2)
- 2 While pressing and holding down [⏏/I, POWER] on the main unit, reconnect the AC power supply cord.
“-----” appears on the display.
- 3 Release [⏏/I, POWER].
All the settings are returned to the factory preset.
You will need to reset the memory items.

Specifications

AMPLIFIER SECTION **AK340** **AK343**

FTC Output power

THD 10%, both channels driven

50 Hz to 3 kHz

(Low channel)

AK340 : 81 W per channel (3 Ω)

AK343 : 77 W per channel (3 Ω)

3 kHz to 12 kHz

(High channel)

AK340 : 81 W per channel (3 Ω)

AK343 : 77 W per channel (3 Ω)

Total FTC Bi-Amp power

AK340 : 324 W

AK343 : 308 W

RMS output power

THD 10%, both channels driven

1 kHz

(Low channel)

AK340 : 105 W per channel (3 Ω)

AK343 : 100 W per channel (3 Ω)

10 kHz

(High channel)

AK340 : 105 W per channel (3 Ω)

AK343 : 100 W per channel (3 Ω)

Total Bi-Amp power

AK340 : 420 W

AK343 : 400 W

AMPLIFIER SECTION **AK240**

FTC Output power

THD 10%, both channels driven

100 Hz to 10 kHz

90 W per channel (3 Ω)

Total FTC power

180 W

RMS Output power

THD 10%, both channels driven

1 kHz

115 W per channel (3 Ω)

Total output power

230 W

FM/AM TUNER, TERMINALS

SECTION

Preset station

FM 15 stations

AM 15 stations

Frequency Modulation (FM)

Frequency range

87.9 to 107.9 MHz (200 kHz step)

87.5 to 108.0 MHz (100 kHz step)

Sensitivity

4.0 μV (IHF)

S/N 26 dB

2.2 μV

Antenna terminal(s) 75 Ω (unbalanced)

Amplitude Modulation (AM)

Frequency range

520 to 1710 kHz (10 kHz step)

Sensitivity

S/N 20 dB (at 1000 kHz) 560 μV/m

Music Port input jack

Terminal Stereo, 3.5 mm (1/8") jack

Sensitivity 100 mV, 4.7 kΩ

Phone jack

Terminal Stereo, 3.5 mm (1/8") jack

CASSETTE DECK SECTION

Track system

4 track, 2 channel

Heads

Record/playback Solid permalloy head

Erasure Double gap ferrite head

Motor

DC servo motor

Recording system

AC bias 100 kHz

Erase system

AC erase 100 kHz

Tape speed

4.8 cm/s (1 7/8 ips)

Overall frequency response (+3 dB, -6 dB)

at DECK OUT

NORMAL 35 Hz to 14 kHz

S/N Ratio

50 dB (A weighted)

Wow and flutter

0.18% (WRMS)

Fast forward and rewind time

Approx. 120 seconds with

C-60 cassette tape

DISC SECTION

Disc played [8 cm (3") or 12 cm (5")]

(1) CD-Audio (CD-DA)

(2) CD-R/RW

(CD-DA, MP3, WMA formatted disc)

(3) MP3/WMA

Bit rate

MP3, WMA 32 kbps to 320 kbps

Sampling frequency

MP3/WMA 32 kHz, 44.1 kHz, 48 kHz

CD-DA 44.1 kHz

D/A converter

16 bit linear

Digital filter

8 fs

D/A converter

MASH (1 bit DAC)

Pick up

Wavelength 780 nm

Beam Source Semiconductor laser

Audio output (Disc)

Number of channels 2(Stereo) (FL, FR)

SPEAKER SECTION **AK340** **AK343**

Type

3 way, 3 speaker system (Bass reflex)

Speaker(s)

Woofer 16 cm (6 1/2") cone type

Tweeter 6 cm (2 3/8") cone type

Super tweeter Piezo type

Impedance

HIGH 3 Ω

LOW 3 Ω

Input power (IEC)

HIGH 110 W (Max)

LOW 110 W (Max)

Output sound pressure level

83 dB/W (1.0 m)

Cross over frequency

2.6 kHz, 10 kHz

Frequency range 37 Hz to 23 kHz (-16 dB)

44 Hz to 22 kHz (-10 dB)

Dimensions (WxHxD)

247 x 330 x 221 mm

(9 23/32" x 13" x 8 11/16")

Mass

3.0 kg (6.6 lb.)

SPEAKER SECTION **AK240**

Type

2 way, 2 speaker system (Bass reflex)

Speaker(s)

Woofer 16 cm (6 1/2") cone type

Tweeter 6 cm (2 3/8") cone type

Impedance

3 Ω

Input power (IEC)

115 W (Max)

Output sound pressure level

83 dB/W (1.0 m)

Cross over frequency

4 kHz

Frequency range 38 Hz to 28 kHz (-16 dB)

55 Hz to 26 kHz (-10 dB)

Dimensions (WxHxD) 220 x 330 x 208 mm

(8 21/32" x 13" x 8 3/16")

Mass

2.8 kg (6.2 lb.)

GENERAL

Power supply

AC 120 V, 60 Hz

Power consumption **AK340** **AK343** :

125 W

AK240 : 100 W

Dimensions (WxHxD)

250 x 330 x 343 mm

(9 27/32" x 13" x 13 1/2")

Mass

6.6 kg (14.6 lb.)

Operating temperature range

+5 to +35 °C (+41 to +95°F)

Operating humidity range

5 to 90 % RH (no condensation)

Power consumption in standby mode: 0.28 W

Note:

- Specifications are subject to change without notice.
- Mass and dimensions are approximate. Total harmonic distortion is measured by the digital spectrum analyzer.
- AK340** **AK343** The labels "HIGH" and "LOW" on the rear of the speakers refer to High frequency and Low frequency.

Limited Warranty (ONLY FOR U.S.A.)

Panasonic Consumer Electronics Company,
Division of Panasonic Corporation of North America
One Panasonic Way Secaucus, New Jersey 07094

Panasonic Puerto Rico, Inc.
Ave. 65 de Infantería, Km. 9.5
San Gabriel Industrial Park, Carolina, Puerto Rico 00985

Panasonic Audio Products Limited Warranty

Limited Warranty Coverage

If your product does not work properly because of a defect in materials or workmanship, Panasonic Consumer Electronics Company or Panasonic Puerto Rico, Inc. (collectively referred to as "the warrantor") will, for the length of the period indicated on the chart below, which starts with the date of original purchase ("warranty period"), at its option either (a) repair your product with new or refurbished parts, or (b) replace it with a new or a refurbished product. The decision to repair or replace will be made by the warrantor.

Product of Part Name	Parts	Labor
Audio Products (except items listed below)	One (1) year	One (1) year
USB Reader-Writer, Personal Computer Card Adapters (in exchange for defective item)	One (1) year	Not Applicable
Accessories: Headphones, Cartridges, Microphones, Adapters	Ninety (90) days	Ninety (90) days
Rechargeable Batteries, DVD-R/-RAM Discs (in exchange for defective item)	Ten (10) days	Not Applicable
SD Memory Cards, Rechargeable Battery Packs (in exchange for defective item)	Ninety (90) days	Not Applicable

During the "Labor" warranty period there will be no charge for labor. During the "Parts" warranty period, there will be no charge for parts. You must carry-in or mail-in your product during the warranty period. If non-rechargeable batteries are included, they are not warranted. This warranty only applies to products purchased and serviced in the United States or Puerto Rico. This warranty is extended only to the original purchaser of a new product which was not sold "as is". A purchase receipt or other proof of the original purchase date is required for warranty service.

Carry-In or Mail-In Service

For Carry-In or Mail-In Service in the United States call 1-800-211-PANA (1-800-211-7262) or visit Panasonic web site: <http://www.panasonic.com>. For assistance in Puerto Rico call Panasonic Puerto Rico, Inc. (787)-750-4300 or fax (787)-768-2910.

Limited Warranty Limits And Exclusions

This warranty ONLY COVERS failures due to defects in materials or workmanship, and DOES NOT COVER normal wear and tear or cosmetic damage. The warranty ALSO DOES NOT COVER damages which occurred in shipment, or failures which are caused by products not supplied by the warrantor, or failures which result from accidents, misuse, abuse, neglect, mishandling, misapplication, alteration, faulty installation, set-up adjustments, misadjustment of consumer controls, improper maintenance, power line surge, lightning damage, modification, or commercial use (such as in a hotel, office, restaurant, or other business), rental use of the product, service by anyone other than a Factory Servicenter or other Authorized Servicer, or damage that is attributable to acts of God.

THERE ARE NO EXPRESS WARRANTIES EXCEPT AS LISTED UNDER "LIMITED WARRANTY COVERAGE". THE WARRANTOR IS NOT LIABLE FOR INCIDENTAL OR CONSEQUENTIAL DAMAGES RESULTING FROM THE USE OF THIS PRODUCT, OR ARISING OUT OF ANY BREACH OF THIS WARRANTY. (As examples, this excludes damages for lost time, travel to and from the servicer, loss of media or images, data or other memory content. The items listed are not exclusive, but are for illustration only.) **ALL EXPRESS AND IMPLIED WARRANTIES, INCLUDING THE WARRANTY OF MERCHANTABILITY, ARE LIMITED TO THE PERIOD OF THE LIMITED WARRANTY.**

Some states do not allow the exclusion or limitation of incidental or consequential damages, or limitations on how long an implied warranty lasts, so the exclusions may not apply to you.

This warranty gives you specific legal rights and you may also have other rights which vary from state to state. If a problem with this product develops during or after the warranty period, you may contact your dealer or Servicenter. If the problem is not handled to your satisfaction, then write to the warrantor's Consumer Affairs Department at the addresses listed for the warrantor.

PARTS AND SERVICE WHICH ARE NOT COVERED BY THIS LIMITED WARRANTY ARE YOUR RESPONSIBILITY.

Customer Services Directory

Obtain Product Information and Operating Assistance; locate your nearest Dealer or Servicenter; purchase Parts and Accessories; or make Customer Service and Literature requests by visiting our Web Site at:

<http://www.panasonic.com/consumersupport>

or, contact us via the web at:

<http://www.panasonic.com/contactinfo>

You may also contact us directly at:

1-800-211-PANA (7262),

Monday-Friday 9 am-9 pm; Saturday-Sunday 10 am-7 pm, EST.

For hearing or speech impaired TTY users, TTY: 1-877-833-8855

Accessory Purchases

Purchase Parts, Accessories and Instruction Books online for all Panasonic Products by visiting our Web Site at:

<http://www.pasc.panasonic.com>

or, send your request by E-mail to:

npcparts@us.panasonic.com

You may also contact us directly at:

1-800-332-5368 (Phone) 1-800-237-9080 (Fax Only) (Monday-Friday 9 am to 8 pm, EST.)

Panasonic Services Company

20421 84th Avenue South, Kent, WA 98032

(We Accept Visa, MasterCard, Discover Card, American Express, and Personal Checks)

For hearing or speech impaired TTY users, TTY: 1-866-605-1277

Service in Puerto Rico

Panasonic Puerto Rico, Inc.

Ave. 65 de Infantería, Km. 9.5, San Gabriel Industrial Park, Carolina, Puerto Rico 00985

Phone (787)750-4300, Fax (787)768-2910

Panasonic Canada Inc.

PANASONIC PRODUCT – LIMITED WARRANTY

Panasonic Canada Inc. warrants this product to be free from defects in material and workmanship and agrees to remedy any such defect for a period as stated below from the date of original purchase.

Technics Audio Product	One (1) year, parts and labour
Panasonic Portable / Clock Radio (without Tape, CD, MD)	One (1) year, parts and labour
Panasonic Audio / SD Audio Product	One (1) year, parts and labour
Panasonic DVD Product	One (1) year, parts and labour
Panasonic Combination DVD Player / VCR	One (1) year, parts and labour
Panasonic Combination DVD Recorder / VCR	One (1) year, parts and labour
Accessories including rechargeable batteries	Ninety (90) days

LIMITATIONS AND EXCLUSIONS

This warranty does not apply to products purchased outside Canada or to any product which has been improperly installed, subjected to usage for which the product was not designed, misused or abused, damaged during shipping, or which has been altered or repaired in any way that affects the reliability or detracts from the performance, nor does it cover any product which is used commercially. Dry cell batteries are also excluded from coverage under this warranty.

This warranty is extended to the original end user purchaser only. A purchase receipt or other proof of date of original purchase is required before warranty service is performed.

THIS EXPRESS, LIMITED WARRANTY IS IN LIEU OF ALL OTHER WARRANTIES, EXPRESS OR IMPLIED, INCLUDING ANY IMPLIED WARRANTIES OF MERCHANTABILITY AND FITNESS FOR A PARTICULAR PURPOSE.

IN NO EVENT WILL PANASONIC CANADA INC. BE LIABLE FOR ANY SPECIAL, INDIRECT OR CONSEQUENTIAL DAMAGES.

In certain instances, some jurisdictions do not allow the exclusion or limitation of incidental or consequential damages, or the exclusion of implied warranties, so the above limitations and exclusions may not be applicable.

WARRANTY SERVICE

FOR PRODUCT OPERATION ASSISTANCE, please contact:

Our Customer Care Centre:	Telephone #:	(905) 624-5505
	1-800 #:	1-800-561-5505
	Fax #:	(905) 238-2360
	Email link:	"Customer support" on www.panasonic.ca

FOR PRODUCT REPAIRS, please locate your nearest Authorized Servicentre at www.panasonic.ca:

Link : "Servicentres™ locator" under "Customer support"

IF YOU SHIP THE PRODUCT TO A SERVICENTRE

Carefully pack and send prepaid, adequately insured and preferably in the original carton. Include details of the defect claimed, and proof of date of original purchase.

Paso 3 - Función de demostración



Cuando el aparato se enchufe por primera vez puede aparecer en el visualizador una demostración de sus funciones.

Si el ajuste de demostración está desactivado, usted podrá activarlo seleccionando "DEMO ON".

Mantenga pulsado [DISPLAY, -DEMO].

La visualización cambia cada vez que se pulsa el botón.

NO DEMO (desactivación) ↔ DEMO ON (activación)

Durante el modo de espera, seleccione "NO DEMO" para reducir el consumo de energía.

Nota:

La función DEMO no se puede activar cuando la función DIMMER está activada.

Colocación de los altavoces

AK340 AK343

Coloque los altavoces delanteros de forma que el altavoz de agudos quede en la parte interior.



No quite la red frontal de los altavoces.

Utilice solamente los altavoces suministrados.

La combinación de la unidad principal y los altavoces proporciona el mejor sonido. Utilizando otros altavoces se puede estropear la unidad y el sonido quedará afectado negativamente.

Nota:

- Mantenga sus altavoces alejados un mínimo de 10mm ($13/32$ "") del sistema para disponer de una ventilación apropiada.
- Estos altavoces no disponen de blindaje magnético. No los ponga cerca de televisores, ordenadores personales y otros dispositivos a los que afecte fácilmente el magnetismo.
- Si reproduce el sonido con niveles altos durante largos periodos de tiempo podrá dañar los altavoces y reducir su duración.
- Reduzca el volumen para evitar daños en los casos siguientes.
 - Cuando reproduzca sonido distorsionado.
 - Cuando ajuste la calidad del sonido.

AK240

Los altavoces han sido diseñados idénticamente por lo que no es necesario orientar el canal derecho o izquierdo.



Precaución

- Use los altavoces sólo con el sistema recomendado. De lo contrario, se podrían dañar el amplificador y los altavoces, y se podría ocasionar un incendio. Consulte a un técnico de servicio especializado si se ha producido algún daño o si se ha producido un cambio repentino en su funcionamiento.
- No instale estos altavoces en paredes ni techos.



Controles

Aparato principal

Los números entre paréntesis indican la página de referencia.

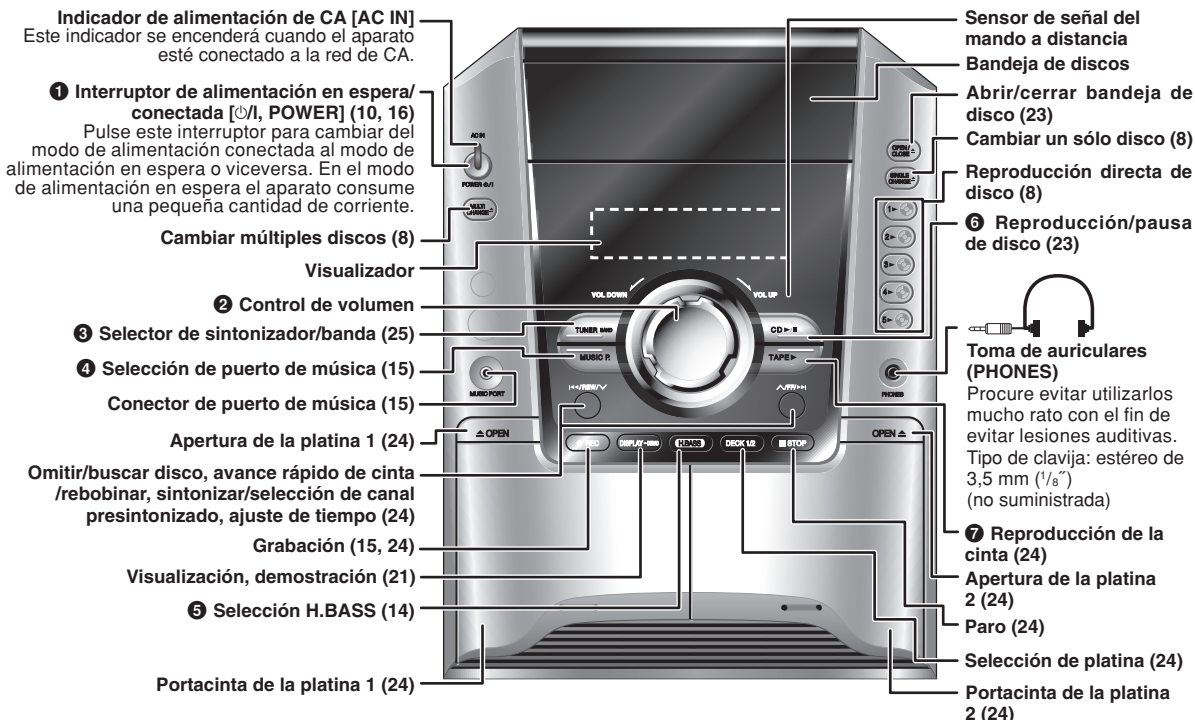

Mando a distancia

Los botones como el 1 funcionan del mismo modo que los botones del aparato principal.

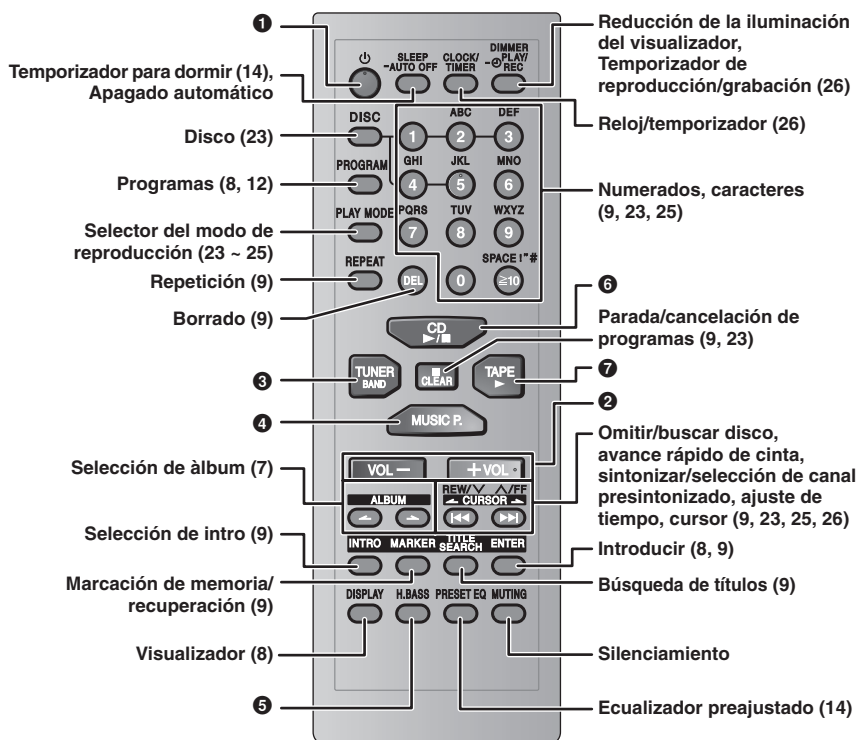

SLEEP -AUTO OFF

Esta función de apagado automático le permite apagar el aparato en modo **disco o cinta**, sólo después de 10 minutos sin utilizarlo.

- Mantenga pulsado [-AUTO OFF] para activar esta función.
- Mantenga pulsado [-AUTO OFF] de nuevo para cancelar.
- El ajuste se mantiene aunque el aparato esté apagado.

DIMMER -PLAY/REC

Para reducir la iluminación del visualizador.

MUTING

Para silenciar el sonido.

- Pulse el botón para activarlo.
- Vuélvalo a pulsar para cancelar.

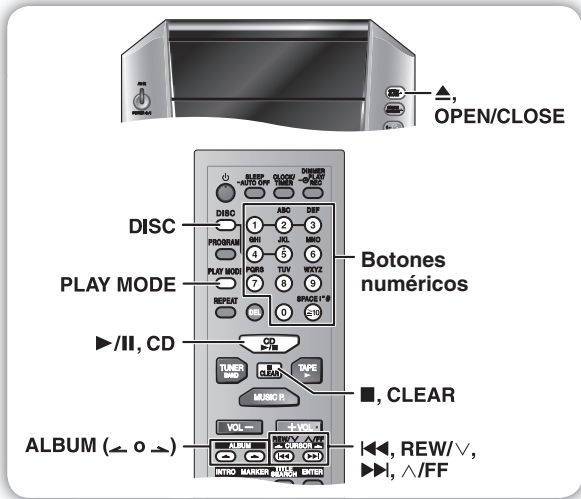

salutar pistas Pulse [**◀◀**, REW/∨] o [**▶▶**, ∨/FF].

- Durante la reproducción aleatoria (⇒ ver abajo, "Función de modo de reproducción"), no se puede saltar a pistas que ya han sido reproducidas.

MP3 **WMA**

Durante el modo 1-ALBUM y 1-ALBUM RANDOM, el salto de pista sólo puede realizarse dentro del álbum actual.

buscar por pistas

CD

Mantenga pulsado [**◀◀**, REW/∨] o [**▶▶**, ∨/FF] durante la reproducción o la pausa para buscar.

- Durante la reproducción programada (⇒ página 8), o la reproducción aleatoria (⇒ ver abajo, "Función de modo de reproducción"), usted sólo puede buscar dentro de la pista.

Función de modo de reproducción **CD** **MP3** **WMA**

Puede escuchar discos específicos y pistas.

Preparación

Seleccione y reproduzca sus discos deseados.

Pulse [**PLAY MODE**] para seleccionar el modo deseado.

Modo	Para reproducir
1-DISC 1 DISC	un disco seleccionado.
1-DISC RANDOM 1 DISC RND	un disco seleccionado aleatoriamente.
ALL-DISC ALL DISC	todos los discos cargados en sucesión del disco seleccionado al último disco. Ejemplo: 4→5→1→2→3.
ALL-DISC RANDOM ALL-DISC RND	todos los discos cargados en orden aleatorio.
1-SONG 1-SONG	una melodía seleccionada del disco seleccionado.

CD

Pulse los botones numéricos para seleccionar la pista en el disco actual. La reproducción empieza desde la pista seleccionada.

MP3

WMA

Pulse [**ALBUM** (◀ o ▶)] para seleccionar el álbum. Pulse los botones numéricos para seleccionar la pista en el álbum actual. La reproducción empieza desde la pista seleccionada.

1-ALBUM

1-ALBUM

MP3

WMA

un álbum seleccionado del disco seleccionado.

Pulse [**ALBUM** (◀ o ▶)] para seleccionar el álbum.

1-ALBUM RANDOM

1-ALBUM RND

MP3

WMA

todas las pistas de un álbum seleccionado aleatoriamente.

Pulse [**ALBUM** (◀ o ▶)] para seleccionar el álbum.

Cuando termine la reproducción

El modo de reproducción actual se retendrá en la memoria, aunque se apague el aparato, hasta que se cambie.

Reproducción básica

- 1 Pulse [**▲**, OPEN/CLOSE] en la unidad principal para abrir la bandeja. El aparato se enciende, carga un disco en la bandeja actual con la etiqueta hacia arriba. Pulse [**▲**, OPEN/CLOSE] para cerrar la bandeja.
- 2 Pulse [**▶/II**, CD] para iniciar la reproducción. También puede pulsar [DISC] y a continuación [1] ~ [5] para seleccionar y reproducir los otros discos cargados.



Indicador del disco actual

Para	Acción
parar reproducción	Pulse [■ , CLEAR] durante la reproducción. MP3 WMA Visualización en el modo de parada: Ejemplo: "MP3" indica que el disco contiene archivos MP3.
interrumpir la reproducción	Pulse [▶/II , CD] durante la reproducción. Vuelva a pulsar para reanudar la reproducción.
salutar álbum	MP3 WMA Pulsar [ALBUM (◀ o ▶)] para seleccionar el álbum deseado durante la reproducción o en el modo de paro. Mostrar al seleccionarlo en modo de paro (ejemplo):



Número total de álbumes Número total de pistas

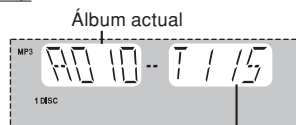

Álbum actual
Número de pistas del álbum actual

- Esta función no funciona en modo 1-DISC RANDOM y ALL-DISC RANDOM. Es aplicable únicamente durante el modo paro del programa.

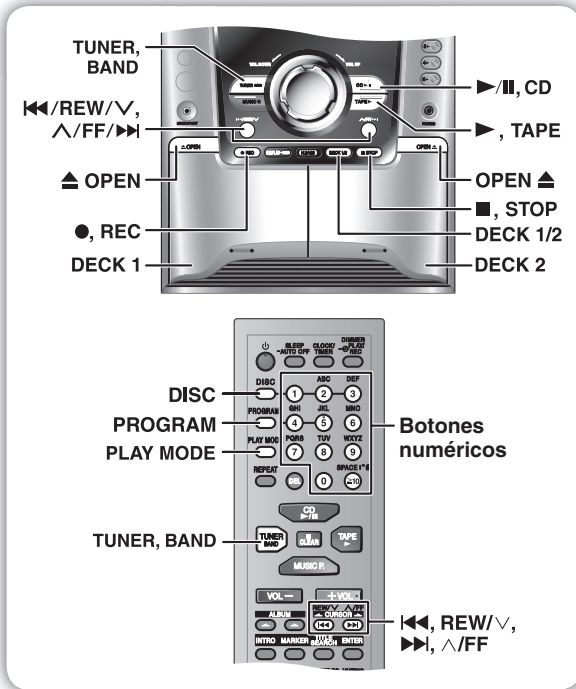

Los botones descritos para “Cintas de casete – reproducción y grabación” son principalmente para la unidad a no ser que se indique lo contrario.

Reproducción básica

Puede utilizar la platina 1 (DECK 1) o platina 2 (DECK 2) para reproducir cintas.

Use cintas de posición normal.

Las cintas de posición alta y de posición metal pueden reproducirse, pero el aparato no podrá reproducir perfectamente las características de estas cintas.

- 1 Pulse [▶, TAPE].**
El aparato se enciende.
Si ya se introdujo una cinta de casete, la reproducción empezará automáticamente (Reproducción de un toque).
- 2 Pulse [▲ OPEN] para la platina 1 (DECK 1) o [OPEN ▲] para la platina 2 (DECK 2) e insertar la cinta.**
Inserte con el lado que va a reproducirse hacia usted y con la cinta expuesta hacia abajo. Cierre el portacasete con la mano.

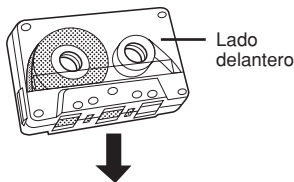

- 3 Pulse [▶, TAPE] para iniciar la reproducción.**

Para	Acción
detener la reproducción	Pulse [■, STOP].
avanzar rápidamente o rebobinar	Pulse [◀◀/REW/V] o [▲/FF/▶▶].
seleccionar entre las platinas cargadas	Pulse [DECK 1/2] (mando a distancia : [PLAY MODE]).

Grabación

Selección de las cintas para la grabación

Use cintas de posición normal. Pueden usarse cintas de posición alta y de metal, pero el aparato no las grabará ni las borrará correctamente.

Preparación

Rebobine la cinta original para que la grabación pueda comenzar de inmediato.

- 1 Pulse [OPEN ▲] para la platina 2 (DECK 2) e inserte la cinta que hay que grabar.**
Inserte con el lado que va a grabar hacia usted y con la cinta expuesta hacia abajo.
- 2 Seleccione la fuente que va a grabar.**
Grabación de disco:
① Inserte el(los) CD(s) que desee grabar.
Pulse [▶/||, CD] y luego [■, STOP].
② Prepare el modo de grabación del disco deseado.

Para	Acción
Mando a distancia solamente	
grabación 1-DISC/ ALL-DISC	1) Pulse [DISC] y luego [1]~[5] para seleccionar el disco. Asegúrese de que el disco esté parado.
	2) Pulse [PLAY MODE] para seleccionar el modo deseado (→ página 23).

- 3 Pulse [●, REC] para iniciar la grabación.**

Otras operaciones básicas

Para	Acción
detener la grabación	Pulse [■, STOP].
grabar en la otra cara de la cinta	Dé la vuelta a la cinta de casete y pulse [●, REC].

Sintonización manual

- 1 Pulse [TUNER, BAND] para seleccionar "FM" o "AM".
- 2 Pulse [PLAY MODE] para seleccionar "MANUAL".
- 3 Pulse [◀◀, REW/∨] o [▶▶, ∧/FF] para seleccionar la frecuencia de la emisora requerida.
 - Se visualizará "ST" cuando esté siendo recibida una emisora estéreo por FM.
 - Se visualizará "TUNED" cuando se sintonice con precisión una emisora de radio.

Para sintonizar automáticamente

Mantenga pulsado [◀◀, REW/∨] o [▶▶, ∧/FF] hasta que la frecuencia empiece a cambiar rápidamente. El aparato inicia la sintonización automática y se detendrá cuando encuentre una emisora.

- La sintonización automática tal vez se interrumpa cuando las interferencias sean excesivas.
- Para cancelar la sintonización automática, pulse una vez más [◀◀, REW/∨] o [▶▶, ∧/FF].

Para mejorar la calidad del sonido de FM

Mantenga pulsado [PLAY MODE] para visualizar "MONO".

Para cancelar

Pulse y mantenga pulsado [PLAY MODE] otra vez hasta que "MONO" desaparezca.

- MONO también se cancelará si se cambia la frecuencia.
- Deje "MONO" apagado para la escucha normal.

Ajuste de la asignación de FM

Aparato principal solamente

Este sistema le permite recibir emisiones de FM asignadas en pasos de 0,1 MHz.

Para cambiar el paso a 0,1 MHz

- 1 Mantenga pulsado [TUNER, BAND]. Después de unos segundos, la visualización cambiará a una visualización parpadeante de la frecuencia mínima actual.
- 2 Continúe pulsando [TUNER, BAND].
 - Si la frecuencia mínima cambia, suelte el botón. Para volver al paso original, repita los pasos anteriores.
 - Después de cambiar el ajuste de "asignación", las frecuencias previamente preajustadas en la memoria se borrarán.

Grabación de emisoras en memoria

Se puede presintonizar un máximo de 15 emisoras en cada banda, FM y AM.

Preparación

Pulse [TUNER, BAND] para seleccionar "FM" o "AM".

Presintonización automática

- 1 Sintonice la frecuencia desde la que quiere comenzar a presintonizar.
- 2 Mantenga pulsado [PROGRAM] para iniciar la presintonización.



El sintonizador presintonizará en los canales, en orden ascendente, todas las emisoras que pueda recibir. Cuando termine, se sintonizará la última emisora memorizada.

Presintonización manual

- 1 Pulse [PLAY MODE] para seleccionar "MANUAL".
- 2 Pulse [◀◀, REW/∨] o [▶▶, ∧/FF] para seleccionar la emisora deseada.
- 3 Pulse [PROGRAM].
- 4 Pulse los botones numéricos para seleccionar el canal. Para los canales 10 a 15 pulse [≥10] y luego los dos dígitos. La emisora que ocupa un canal se borrará si se presintoniza otra emisora en ese canal.

Selección de una emisora presintonizada

Pulse los botones numéricos para seleccionar el canal.



- 0
- 1 Pulse [PLAY MODE] para seleccionar "PRESET".
- 2 Pulse [◀◀, REW/∨] o [▶▶, ∧/FF] para seleccionar el canal.

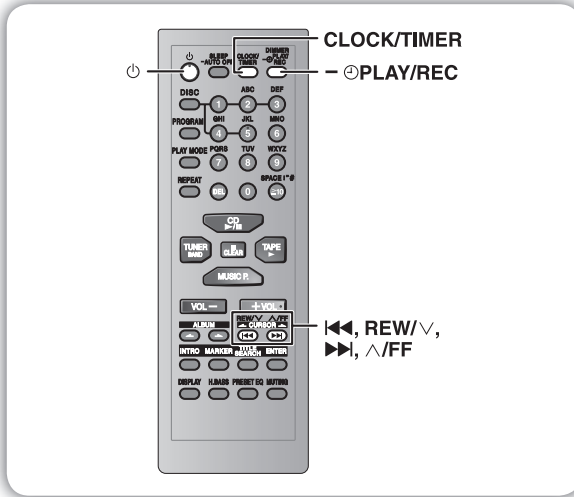

Puesta en hora

Éste es un reloj de sistema de 12 horas.

- 1 Pulse **[CLOCK/TIMER]** para seleccionar "CLOCK". Cada vez que pulse el botón:



- 2 **(Entre 8 segundos después)**

Pulse **[<<, REW/^]** o **[>>, ^/FF]** para ajustar la hora.

- 3 Pulse **[CLOCK/TIMER]** para terminar de poner la hora.

Visualización del reloj

Pulse una vez **[CLOCK/TIMER]** cuando el aparato esté encendido o en el modo de espera. La hora se muestra durante unos pocos segundos.

Nota:

Vuelva a poner en hora el reloj con frecuencia para mantener su precisión.

Utilización del temporizador de reproducción/grabación

Puede ajustar el temporizador para que se encienda a una hora determinada para despertarle (temporizador de reproducción) o para grabar la radio o fuente de puerto de música (temporizador de grabación).

El temporizador de reproducción no puede utilizarse en combinación con el temporizador de grabación.

Encienda el aparato y ponga en hora el reloj.

Temporizador	Acción
Temporizador de reproducción	Prepare la fuente de música que desea escuchar (la platina 2 [DECK 2] tiene prioridad), número de disco (1-5), radio o fuente de puerto de música y ajuste el volumen.
Temporizador de grabación	Compruebe las lengüetas de prevención de borrado del casete (➔ página 11), inserte el casete en la platina 2 (DECK 2) y sintonice la emisora de radio (➔ página 12) o seleccione la fuente del puerto de música (➔ página 15).

- 1 Pulse **[CLOCK/TIMER]** para seleccionar el temporizador deseado.

Cada vez que pulse el botón:



PLAY : para ajustar el temporizador de reproducción
REC : para ajustar el temporizador de grabación
 (Vaya al paso siguiente **antes de que pasen 8 segundos**)

- 2 Pulse **[<<, REW/^]** o **[>>, ^/FF]** para ajustar la hora de inicio.

Indicador del temporizador de reproducción



Hora de inicio



Indicador del temporizador de grabación

- 3 Pulse **[CLOCK/TIMER]** para confirmar.

- 4 Repita los pasos 2 a 3 para ajustar la hora de finalización.



Hora de finalización



Para activar el temporizador

- 5 Mantenga pulsado **[PLAY/REC]** para encender el temporizador deseado.



- 6 Pulse **[OFF]** para apagar el aparato.

El aparato debe estar apagado para que funcionen los temporizadores.

Otras operaciones básicas

Para	Acción
cambiar la configuración	Repetir los pasos de 1 a 4 y 6 (➔ página 26).
cambiar la fuente o el volumen	1) Mantenga pulsado [-⊖PLAY/REC] para cancelar el temporizador indicador del visualizador. 2) Cambie la fuente o el volumen. 3) Realice los pasos 5 a 6 (➔ página 26).
compruebe la configuración	Pulse [CLOCK/TIMER] repetidamente seleccione ⊕PLAY o ⊕REC.
cancelar	Mantenga pulsado [-⊖PLAY/REC] para cancelar el temporizador indicadores del visualizador.

Si utiliza el aparato después de haber ajustado los temporizadores

Tras la utilización del aparato, compruebe que la cinta/disco correcto esté introducido antes de apagar el aparato.

Nota:

- El temporizador de reproducción se pondrá en marcha a la hora programada y el volumen aumentará gradualmente hasta el nivel seleccionado.
- El temporizador de grabación de registro comenzará 30 segundos antes del tiempo del sistema con el volumen silenciado.
- Si el temporizador está activo, se encenderá todos los días a la hora fijada.
- El aparato debe estar en modo de espera para que el temporizador funcione.
- Si apaga el aparato y lo vuelve a encender mientras esté funcionando un temporizador, no se activará el ajuste de tiempo de terminación.
- Si se selecciona el puerto música (MUSIC PORT) como fuente cuando el temporizador avance, el sistema se enciende y utilice el puerto de música (MUSIC PORT) como fuente. Si desea reproducir o grabar desde el equipo reproductor portátil de audio, solo ha de activar el modo reproducir del equipo reproductor y aumentar el volumen. (Ver el manual de instrucciones del reproductor portátil de audio.)

**Panasonic Consumer Electronics
Company, Division of Panasonic
Corporation of North America**
One Panasonic Way Secaucus,
New Jersey 07094
<http://www.panasonic.com>

Panasonic Puerto Rico, Inc.
Ave. 65 de Infantería, Km. 9.5
San Gabriel Industrial Park, Carolina,
Puerto Rico 00985

Panasonic Canada Inc.
5770 Ambler Drive
Mississauga, Ontario
L4W 2T3
www.panasonic.ca

En Sp

Free Manuals Download Website

<http://myh66.com>

<http://usermanuals.us>

<http://www.somanuals.com>

<http://www.4manuals.cc>

<http://www.manual-lib.com>

<http://www.404manual.com>

<http://www.luxmanual.com>

<http://aubethermostatmanual.com>

Golf course search by state

<http://golfingnear.com>

Email search by domain

<http://emailbydomain.com>

Auto manuals search

<http://auto.somanuals.com>

TV manuals search

<http://tv.somanuals.com>