

Panasonic®

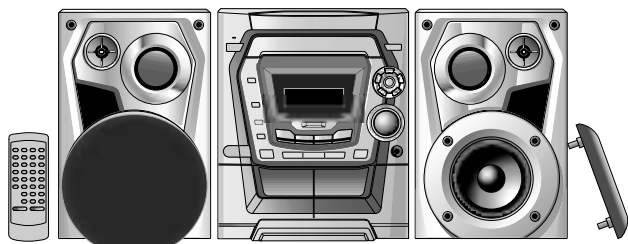

The illustrations show SC-AK500.

CD Stereo System

Operating Instructions

Model No. **SC-AK500**
SC-AK490
SC-AK300
SC-AK200



COMPACT
disc
DIGITAL AUDIO

Before connecting, operating or adjusting this product, please read these instructions completely.
Please keep this manual for future reference.

Dear customer

Thank you for purchasing this product.
For optimum performance and safety, please read these instructions carefully.

These operating instructions are applicable to the following system.
These operating instructions, however, fundamentally explain the operation of system SC-AK500.

System	SC-AK500	SC-AK490	SC-AK300	SC-AK200
Main unit	SA-AK500	SA-AK490	SA-AK300	SA-AK200
Speakers	SB-AK500	SB-AK500	SB-AK300	SB-AK200

The model number and serial number of this product can be found on either the back or the bottom of the unit. Please note them in the space provided below and keep for future reference.

MODEL NUMBER _____

SERIAL NUMBER _____

User memo:

DATE OF PURCHASE _____

DEALER NAME _____

DEALER ADDRESS _____

TELEPHONE NUMBER _____

CAUTION!

**THIS PRODUCT UTILIZES A LASER.
USE OF CONTROLS OR ADJUSTMENTS OR PERFORMANCE OF PROCEDURES OTHER THAN THOSE SPECIFIED HEREIN MAY RESULT IN HAZARDOUS RADIATION EXPOSURE.
DO NOT OPEN COVERS AND DO NOT REPAIR YOURSELF.
REFER SERVICING TO QUALIFIED PERSONNEL.**

WARNING:

TO REDUCE THE RISK OF FIRE, ELECTRIC SHOCK OR PRODUCT DAMAGE, DO NOT EXPOSE THIS APPARATUS TO RAIN, MOISTURE, DRIPPING OR SPLASHING AND THAT NO OBJECTS FILLED WITH LIQUIDS, SUCH AS VASES, SHALL BE PLACED ON THE APPARATUS.

CAUTION:

TO PREVENT ELECTRIC SHOCK MATCH WIDE BLADE OF PLUG TO WIDE SLOT, FULLY INSERT.

CAUTION!

DO NOT INSTALL, OR PLACE THIS UNIT, IN A BOOKCASE, BUILT-IN CABINET OR IN ANOTHER CONFINED SPACE. ENSURE THE UNIT IS WELL VENTILATED. TO PREVENT RISK OF ELECTRIC SHOCK OR FIRE HAZARD DUE TO OVERHEATING, ENSURE THAT CURTAINS AND ANY OTHER MATERIALS DO NOT OBSTRUCT THE VENTILATION VENTS.

Table of contents

Before using

Supplied accessories	2
IMPORTANT SAFETY INSTRUCTIONS	4
Listening caution	5
Placement of speakers	5
About the remote control	5
Battery installation	5
Correct method of use	5
Connections	6
Basic connections (for supplied accessories)	6
Optional antenna connections	7
External unit connection	7
Front panel controls	8
Turning the demo function off	10
Convenient functions	10
Auto-off function	11
Setting the time	11

Radio operations

Listening to radio broadcasts	12
Presetting radio broadcasts	13

Compact disc operations

About compact discs	14
Listening to compact discs	15
Playing MP3 (SC-AK500 and SC-AK490 only)	15
Program play	17
To listen to specific CDs and tracks (CD Play Mode function)	18
Direct access play	19
Repeat play	19
CD display	19

Cassette deck operations

Listening to tapes	20
--------------------------	----

Supplied accessories



Please check and identify the supplied accessories.
Use numbers indicated in parentheses when asking for replacement parts.

(Only for U.S.A.)

To order accessories contact 1-800-332-5368 or web site (<http://www.panasonic.com>).

- AC power supply cord 1 pc.
(RJA0065-1D)

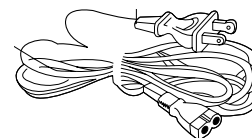

- FM indoor antenna (RSA0006-J) 1 pc.



Recording operations

Before recording (Deck 2 only) 21
Recording from compact discs 22
Tape-to-tape recording 22
Recording from radio broadcasts 23

Sound quality operations

Using the built-in sound quality settings 24
Enhancing the sound quality 24

Timer operations

Using the timer 25
 Using the play/record timer 25
 Using the sleep timer 27

Reference

Using an external unit 27
Troubleshooting guide 28
Servicenter List (ONLY FOR U.S.A.) 29
Warranty (ONLY FOR U.S.A.) 30
Specifications 31
Maintenance Back Cover
Product Service Back Cover

THE FOLLOWING APPLIES ONLY IN THE U.S.A.:

CAUTION:

This equipment has been tested and found to comply with the limits for a Class B digital device, pursuant to Part 15 of the FCC Rules.

These limits are designed to provide reasonable protection against harmful interference in a residential installation. This equipment generates, uses and can radiate radio frequency energy and, if not installed and used in accordance with the instructions, may cause harmful interference to radio communications. However, there is no guarantee that interference will not occur in a particular installation. If this equipment does cause harmful interference to radio or television reception, which can be determined by turning the equipment off and on, the user is encouraged to try to correct the interference by one or more of the following measures:

- Reorient or relocate the receiving antenna.
- Increase the separation between the equipment and receiver.
- Connect the equipment into an outlet on a circuit different from that to which the receiver is connected.
- Consult the dealer or an experienced radio/TV technician for help.

Any unauthorized changes or modifications to this equipment would void the user's authority to operate this device.

This device complies with Part 15 of the FCC Rules. Operation is subject to the following two conditions: (1) This device may not cause harmful interference, and (2) this device must accept any interference received, including interference that may cause undesired operation.



CAUTION

RISK OF ELECTRIC SHOCK
DO NOT OPEN



CAUTION: TO REDUCE THE RISK OF ELECTRIC SHOCK, DO NOT REMOVE SCREWS. NO USER-SERVICEABLE PARTS INSIDE. REFER SERVICING TO QUALIFIED SERVICE PERSONNEL.

- AM loop antenna (N1DADYY00002) 1 pc. Batteries 2 pcs.
 R6, AA, UM-3

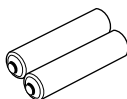
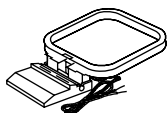

- Remote control transmitter 1 pc.
- SC-AK500 and SC-AK490: (N2QAGB000015)
 - SC-AK300: (Silver: N2QAGB000013) (Black: N2QAGB000017)

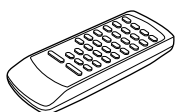

- SC-AK200: (N2QAGB000013)

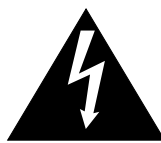

The lightning flash with arrowhead symbol, within an equilateral triangle, is intended to alert the user to the presence of uninsulated "dangerous voltage" within the product's enclosure that may be of sufficient magnitude to constitute a risk of electric shock to persons.



The exclamation point within an equilateral triangle is intended to alert the user to the presence of important operating and maintenance (servicing) instructions in the literature accompanying the appliance.

IMPORTANT SAFETY INSTRUCTIONS

Read these operating instructions carefully before using the unit. Follow the safety instructions on the unit and the safety precautions listed below. Keep these operating instructions handy for future reference.

Safety

- 1. Power source**—Connect the unit to a power source of the type described in these instructions or as marked on the unit.
- 2. Polarization**—The unit is equipped with a polarized power plug where one blade is wider than the other. This safety feature ensures that the plug fits into your household AC outlet only one way. If the plug doesn't fit one way, try reversing it. If the plug still doesn't fit, contact an electrician to replace the obsolete outlet. Do not attempt to defeat the safety purpose of the plug.
- 3. Power cord protection**—Route the AC power supply cord so that it will not be walked on or pinched by items placed on or against it. Never take hold of the plug or cord with wet hands. Always grasp the plug body firmly when connecting and disconnecting it.
- 4. Overloading**—When connecting the AC power supply cord, be careful not to overload the household AC outlet, extension cord, or outlet from any other device as this can result in fire or electric shock.
- 5. Nonuse periods**—Turn the unit off when it is not in use. Unplug the unit from the household AC outlet if it is not to be used for a long time. Unplug the unit during lightning storms.
- 6. Attachments and accessories**—Use only the attachments and accessories recommended in these operating instructions.

Installation

Placement

- 1. Ventilation**—Situate the unit so that it receives proper ventilation. Do not install in a confined space such as a bookcase or cabinet. Allow at least 10 cm (4 inches) clearance from the rear of the unit. To prevent the risk of electric shock or fire due to overheating ensure curtains and other materials do not obstruct the unit's ventilation.
- 2. Foreign material**—Ensure objects and liquids do not get into the unit. Avoid exposing the unit to excessive smoke, dust, mechanical vibration, and shock.
- 3. Magnetism**—Situate the unit away from equipment and devices that generate strong magnetic fields.
- 4. Stacking**—Do not place heavy objects on top of this unit.
- 5. Surface**—Place the unit on a flat, level surface.
- 6. Carts and stands**—Use the unit only with carts and stands recommended by the manufacturer. Move carts with care. Sudden stops, excessive force, and uneven surfaces can cause carts to overturn. 
- 7. Wall and ceiling mounting**—Do not mount the unit on walls or ceilings unless specified in the instructions.

Environment

- 1. Water and moisture**—Do not use the unit near water, such as near a bathtub or swimming pool. Avoid damp basements.
- 2. Heat**—Situate the unit away from heat sources, such as radiators. Do not situate where temperatures fall below 5°C (41°F) or rise above 35°C (95°F).
- 3. Power lines**—Take care when setting up an outdoor antenna that it is not near overhead power lines, electric lights, or electrical circuits, and that there is no danger of the antenna falling on power lines, electric lights, or electrical circuits. When installing an outdoor antenna, take extreme care not to touch such power lines or circuits, as contact with them can be fatal.

- 4. Outdoor antenna grounding**—If you connect an outdoor antenna, ground the antenna system to protect against voltage surges and built-up static charges. Section 810 of the National Electrical Code, ANSI/NFPA No. 70-1990, provides information about grounding of the mast and supporting structure, grounding of the lead-in wire to an antenna discharge unit, size of grounding conductors, location of antenna-discharge unit, connection to grounding electrodes, and requirements for the grounding electrode. Refer to this diagram.

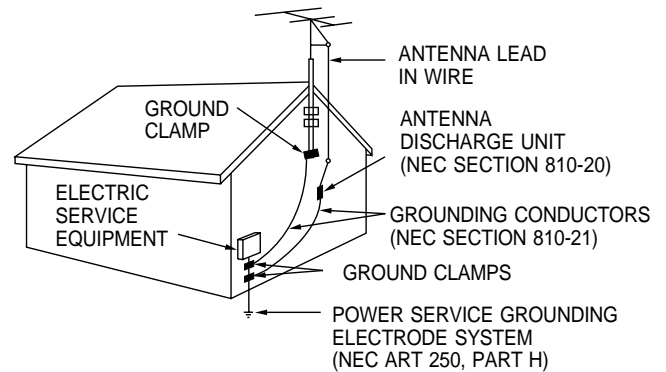

NEC—NATIONAL ELECTRICAL CODE

Maintenance

(See back cover for details.)

Unplug the unit from the household AC outlet before cleaning. Clean with a damp cloth. Do not use abrasive pads, scouring powders, or solvents.

Service

- 1. Damage requiring service**—The unit should be serviced by qualified service personnel if:
 - (a) The AC power supply cord or the plug has been damaged; or
 - (b) Objects or liquids have gotten into the unit; or
 - (c) The unit has been exposed to rain; or
 - (d) The unit does not operate normally or exhibits a marked change in performance; or
 - (e) The unit has been dropped or the cabinet damaged.
- 2. Servicing**—Do not attempt to service the unit beyond that described in these operating instructions. Refer all other servicing to authorized servicing personnel.
- 3. Replacement parts**—When parts need replacing ensure the servicer uses parts specified by the manufacturer or parts that have the same characteristics as the original parts. Unauthorized substitutes may result in fire, electric shock, or other hazards.
- 4. Safety check**—After repairs or service, ask the servicer to perform safety checks to confirm that the unit is in proper working condition.



Selecting fine audio equipment such as the unit you've just purchased is only the start of your musical enjoyment. Now it's time to consider how you can maximize the fun and excitement your equipment offers. This manufacturer and the Electronic Industries Association's Consumer Electronics Group want you to get the most out of your equipment by playing it at a safe level. One that lets the sound come through loud and clear without annoying blaring or distortion—and, most importantly, without affecting your sensitive hearing.

We recommend you to avoid prolonged exposure to excessive noise.

Sound can be deceiving. Over time your hearing "comfort level" adapts to higher volumes of sound. So what sounds "normal" can actually be loud and harmful to your hearing.

Guard against this by setting your equipment at a safe level BEFORE your hearing adapts.

To establish a safe level:

- Start your volume control at a low setting.
- Slowly increase the sound until you can hear it comfortably and clearly, and without distortion.

Once you have established a comfortable sound level:

- Set the dial and leave it there.

Taking a minute to do this now will help to prevent hearing damage or loss in the future. After all, we want you listening for a lifetime.

Placement of speakers

Place the speakers so that the super tweeter is on the outside.

Super tweeter

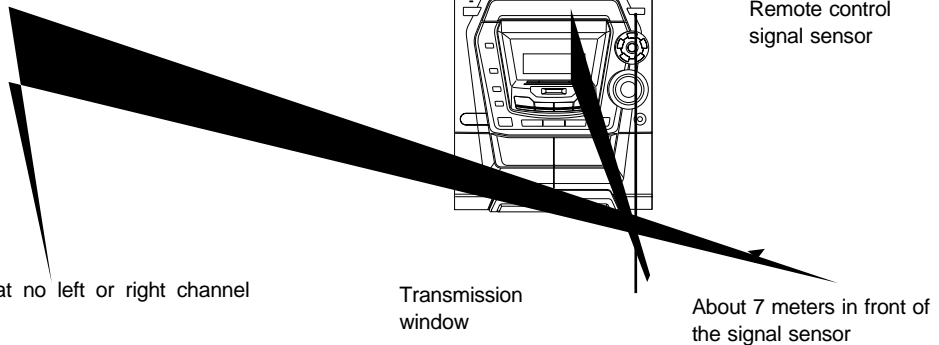

Speakers are designed identically so that no left or right channel orientation is necessary.

About the remote control

Battery installation

R6, AA, UM-3

Use of batteries

- Align the poles (+ and -) properly when inserting the batteries.
- Do not mix old and new batteries or different types of batteries.
- Do not recharge ordinary dry cell batteries.
- Do not heat or disassemble the batteries. Do not allow them to contact flame or water.
- Remove the batteries if the unit is not to be used for a long time.
- Do not keep together with metallic objects such as necklaces.
- Do not use rechargeable type batteries.
- Do not use batteries if the covering has been peeled off.

Mishandling of batteries can cause electrolyte leakage which can damage items the fluid contacts and may cause a fire.

If electrolyte leaks from the batteries, consult your dealer.

Wash thoroughly with water if electrolyte comes in contact with any part of your body.

Correct method of use

Operation notes

- Do not place obstacles between the remote control signal sensor and remote control unit.
- Do not expose the remote control signal sensor to direct sunlight or to the bright light of a fluorescent light.
- Take care to keep the remote control signal sensor and end of the remote control unit free from dust.
- If this system is installed in a rack with glass doors, the glass doors' thickness or color might make it necessary to use the remote control a shorter distance from the system.

To prevent damage

- Never place heavy items on top of the unit.
- Do not disassemble or reconstruct the unit.
- Do not spill water or other liquids into the unit.

Notes

- Keep your speakers at least 10mm (¹³/₃₂") away from the system for proper ventilation.
- These speakers do not have magnetic shielding. Do not place them near televisions, personal computers or other devices easily influenced by magnetism.
- To avoid damage to the speakers, do not touch the speaker cones if you have taken the nets off.

Connections

Optional antenna connections

You may need an outdoor antenna if you use this system in a mountainous region or inside a reinforced concrete building, etc.

A FM outdoor antenna

Disconnect the FM indoor antenna if an FM outdoor antenna is installed.

- ① Remove a piece of the outer vinyl insulator.
- ② Twist the shield braid.
- ③ Expose the core wire.

Note

An outdoor antenna should be installed by a qualified technician only.

B AM outdoor antenna

Connect the outdoor antenna without removing the AM loop antenna. Run 5 to 12 m of vinyl-covered wire horizontally along a window or other convenient location.

Note

When the unit is not in use, disconnect the outdoor antenna to prevent possible damage that may be caused by lightning. Never use an outdoor antenna during an electrical storm.

C External unit connection

- An analog player with a built-in phono equalizer can be connected.
- For details, refer to the instruction manual of the units which are to be connected.
- When units other than those described above are to be connected, please consult with your audio dealer.

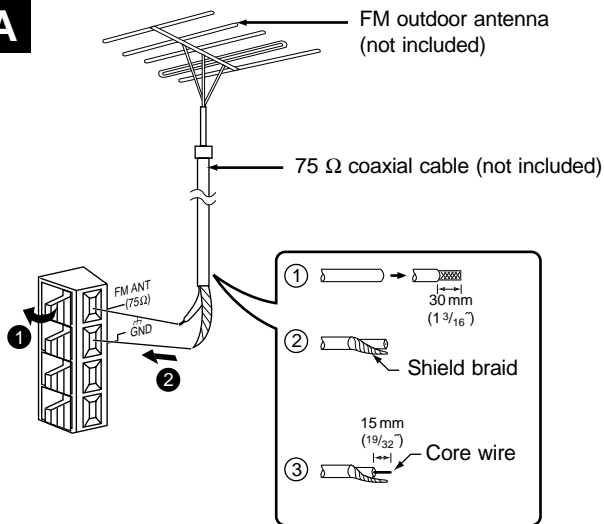
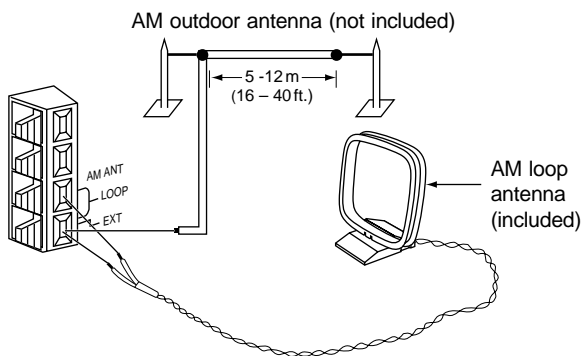
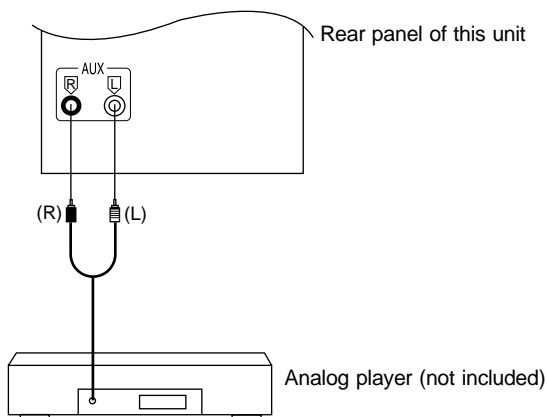
A**B****C**

A

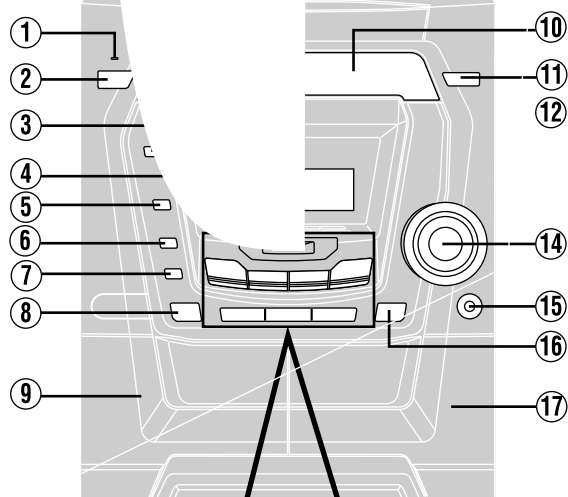

B

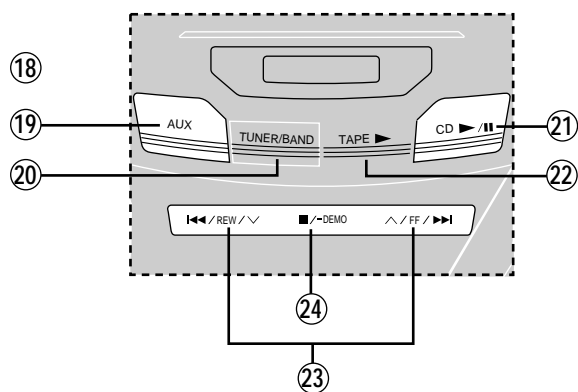

Front panel controls

A Main unit

No.	Name	Ref. page
①	AC supply indicator (AC IN) This indicator lights when the unit is connected to the AC power supply.	
②	Standby/on switch (⏻/⏻, POWER) Press to switch the unit from on to standby mode or vice versa. In standby mode, the unit is still consuming a small amount of power.	
③	Display button (DISPLAY)	15, 19
④	Display	
⑤	Preset EQ select button (PRESET EQ)	24
⑥	Record button (● REC)	22
⑦	Deck select button (DECK 1/2)	20
⑧	Deck 1 open button (⏏ DECK 1 OPEN)	20
⑨	Deck 1 cassette holder	20
⑩	Disc tray Remote control signal sensor (SENSOR)	5
⑫	Disc direct play buttons (1 ~ 5)	16
⑬	CD tray open/close button (⏏)	16
⑭	Volume control (VOL DOWN, UP)	12
⑮	Headphone jack (PHONES)	27
⑯	Deck 2 open button (⏏ DECK 2 OPEN)	20
⑰	Deck 2 cassette holder	20

Center console

⑱	Super sound EQ button (SUPER SOUND EQ)	24
⑲	AUX button (AUX)	27
⑳	Tuner/band select button (TUNER/BAND)	12
㉑	CD play/pause button (CD ▶/⏻)	16
㉒	Tape play button (TAPE ▶)	20
㉓	CD skip/search, tape fast-forward/rewind, tune/preset channel select, time adjust buttons (⏏/REW/⏏, ⏏/FF/⏏)	11, 12, 13, 16, 20
㉔	Stop/program clear and demonstration button (■/-DEMO)	10, 16, 17, 20

Front panel controls

Remote control

Buttons such as ② function in exactly the same way as the buttons on the main unit.

No.	Name	Ref. page
-----	------	-----------

②	Standby/on button (⏻)	11
②⑤	Sleep timer/auto off button (SLEEP, -AUTO OFF)	11, 27
②⑥	Numeric buttons (≥10, 1-9, 0)	13, 15, 17
③	Display button (DISPLAY)	15, 19
②⑦	Dimmer button (DIMMER)	10
①⑨	AUX button (AUX)	27
②⑦	Tuner/band select button (TUNER)	12
②⑩	CD skip/search, tape fast-forward/rewind, tune/preset channel select, time adjust buttons (⏮/REW/⏪, ⏩/FF/⏭)	11, 12, 13, 16, 20
①⑧	Super sound EQ button (S.SOUND EQ)	24
①④	Volume buttons (- VOLUME +)	12
②⑧	Play timer/record timer button (⌚PLAY/REC)	25
②⑨	Clock/timer button (CLOCK/TIMER)	11, 25, 26
③①	Disc button (DISC)	17
③①	Program button (PROGRAM)	13, 17
③②	Play mode select button (PLAY MODE)	12, 18, 19, 20, 23
②①	CD play/pause button (CD ▶/⏸)	16
②②	Tape play button (TAPE ▶)	20
③③	Stop/program clear button (■)	16, 17, 20
③④	Muting button (MUTING)	10
⑤	Preset EQ select button (PRESET EQ)	24

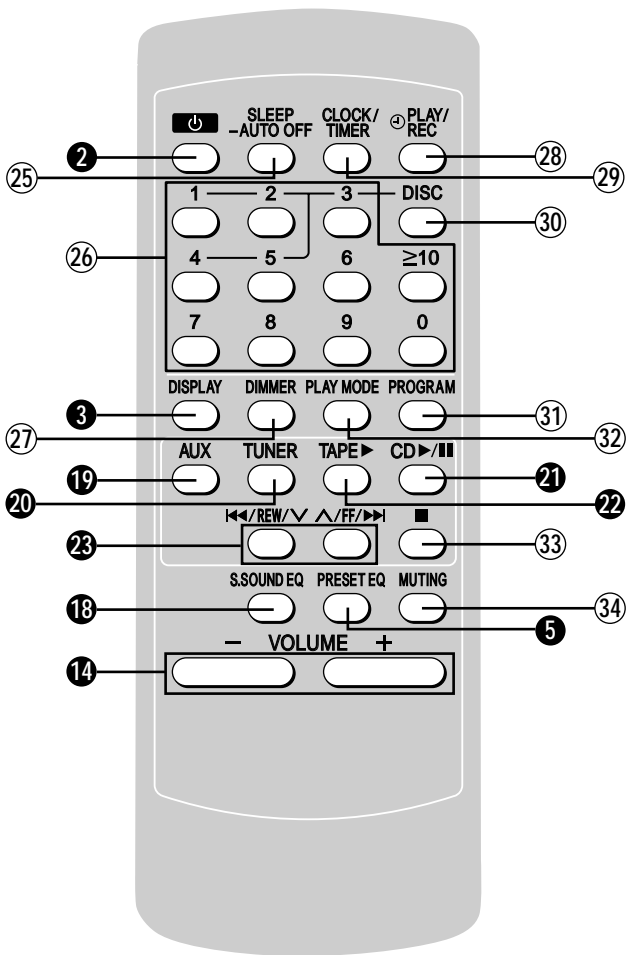

A

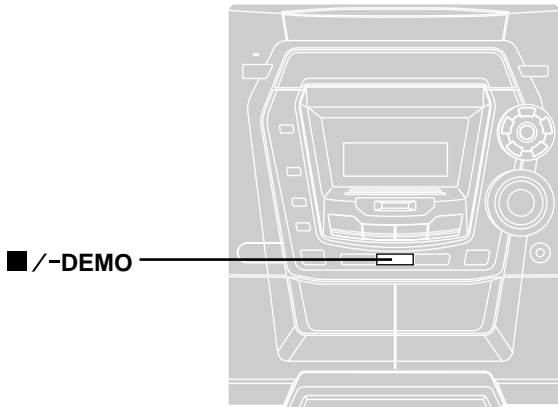

[-/DEMO]



NO DEMO



DEMO ON

DIMMER

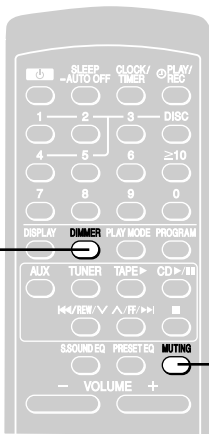

MUTING

B

DIMMER



C

MUTING



MUTING

A Turning the demo function off

If the clock has not been set, a demonstration of the display is shown when the unit is switched to standby mode. This function is set to on at the time of purchase.

During standby mode

Press and hold **[-/DEMO] until “NO DEMO” is displayed.**

The display changes each time the button is held down. NO DEMO (off) ↔ DEMO ON (on)

To show a demonstration of the display

Press and hold **[-/DEMO]** until “DEMO ON” is displayed.

Note

- You cannot turn demo function off when the unit is on.
- (SC-AK500) (SC-AK300)
DEMO function cannot be turned on in Full-Dim mode.
- (SC-AK490) (SC-AK200)
DEMO function cannot be turned on when Dimmer is on.

Convenient functions

B To dim the display panel

Remote control only

Use this for better television viewing.

SC-AK500 SC-AK300

Press [DIMMER].

Every time you press the button:

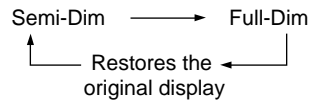

Semi-Dim: The backlights of the display are turned off.

Full-Dim: The display is dimmed and the backlights of the display and the indicator, except for the AC supply indicator, are turned off.

SC-AK490 SC-AK200

Press [DIMMER].

The display is dimmed and the indicator is turned off.

(The AC supply indicator remains on.)

Press [DIMMER] again to restore the display.

C To mute the volume

Remote control only

This feature is convenient when you have a telephone call, etc.

Press [MUTING].

Press the button again to cancel.

“MUTING” goes out.

Muting can also be cancelled by lowering the volume all the way (--dB).

When the system is turned off, the muting operation will be automatically cancelled.

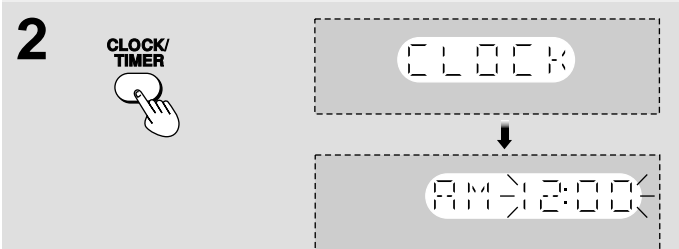
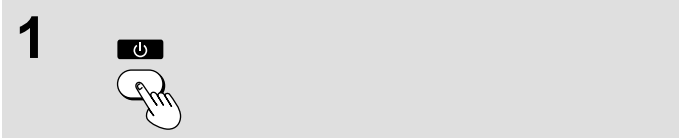
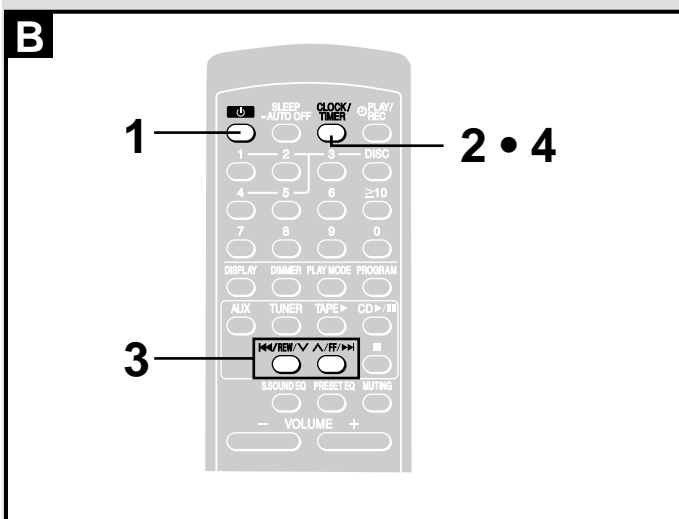
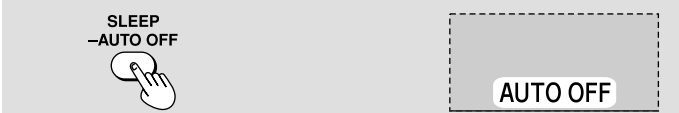
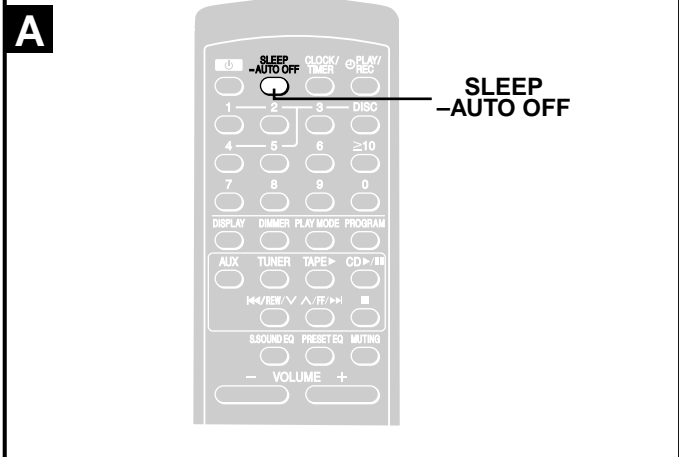

A Auto-off function

Remote control only

When CD or tape is selected as the source
To save power, the unit turns off if it is left unused for ten minutes.

Note

This function does not work if the source is tuner or AUX.

Press and hold [-AUTO OFF].

"AUTO OFF" is shown on the display.

To cancel

Press and hold [-AUTO OFF] again to clear "AUTO OFF" from the display.

For your reference

The setting is maintained even if the unit is turned off. When the unit is turned on again, "AUTO OFF" is displayed and the unit functions as described above.

"AUTO OFF" disappears from the display if either tuner or AUX is selected as the source but continues to function normally.

"AUTO OFF" remains displayed if CD or tape is selected as the source.

B Setting the time

Remote control only

This is a 12-hour display clock.

This example in the figure shows how to set the time for 4:25 p.m..

- 1 Switch on the power.
- 2 Press [CLOCK/TIMER] to select "CLOCK".
Every time you press the button:
CLOCK → ○PLAY → ○REC
↑ Previous display ↓
- 3 (within 7 seconds or so)
Press [REW/FF] or [FF/REW] to set the present time.
- 4 Press [CLOCK/TIMER] to finish setting the time.
The display will return to whatever was displayed before you set the time.

To display the time when system is ON

Press [CLOCK/TIMER] to select "CLOCK".

To display the time when system is OFF

Press [CLOCK/TIMER].

The time will be displayed for about 5 seconds and then the display will return to whatever was previously displayed.

Note

The clock may lose or gain some time over a period. Readjust if necessary.

Listening to radio broadcasts

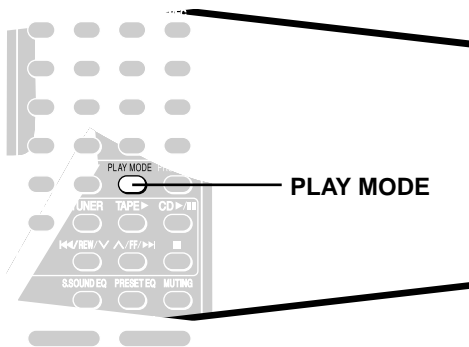
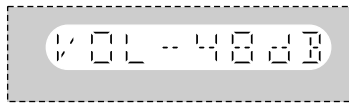
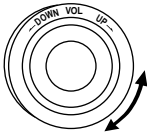
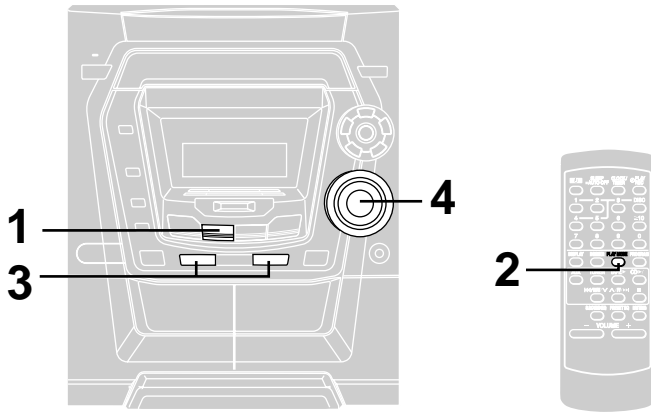

1 Press [TUNER/BAND] to select band.

The unit comes on automatically.
Every time you press the button:
FM ↔ AM

2 Press [PLAY MODE] on the remote control to select "MANUAL".

Every time you press the button:
MANUAL ↔ PRESET.

3 Press [REW/FF] or [FF/REW] to select the frequency of the required station.

"TUNED" is displayed when a radio station is tuned.
"ST" is displayed when a stereo FM broadcast is being received.

4 Adjust the volume.

Auto tuning

Press and hold [REW/FF] or [FF/REW] for a moment until the frequency starts changing rapidly. The unit begins auto tuning, stopping when it finds a station.

- Auto tuning may not function when there is excessive interference.
- To cancel auto tuning, press [REW/FF] or [FF/REW] once again.

A If noise is excessive in FM

Remote control only

Press and hold [PLAY MODE] to display "MONO".

This mode improves sound quality if reception is weak, but broadcasts will be heard in monaural.

Press and hold [PLAY MODE] again to cancel the mode.

"MONO" goes out. MONO is also cancelled if the frequency is changed.

Turn off "MONO" for normal listening. Stereo and monaural broadcasts are automatically played as they are received.

FM allocation setting

Main unit only

By adjusting the allocation, you can enable this tuner to receive FM broadcasts allocated in 0.1 MHz steps.

Press and hold [TUNER / BAND]. After a few seconds, the display will change to a flashing display of the current minimum FM frequency.

If you continue to hold the button down, the minimum frequency will change. Release the button at this time.

To return to the original frequency indication, repeat above.

Notes

- After changing the "allocation" setting, the frequencies you previously preset in the memory will be cleared.
- Sound is momentarily interrupted if you load/unload tapes while listening to an AM broadcast.

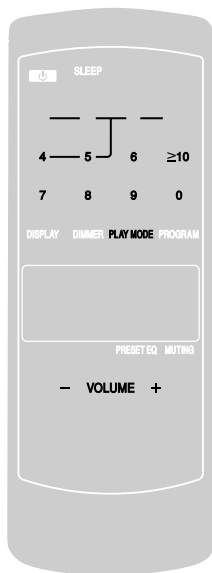
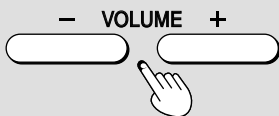
A**B****1****1****2**

Presetting radio broadcasts

Remote control only

There are two methods of presetting stations.

Automatic presetting : All the stations the tuner can receive are preset.

Manual presetting : You can select the stations to preset and the order they are preset in.

Up to 15 stations each can be set in the FM and AM bands.

Preparation:

Press [TUNER] to select "FM" or "AM".

Automatic presetting

Do the following once each for FM and AM.

Preparation:

Tune to the frequency where presetting is to begin (→ page 12).

Press and hold [PROGRAM].

Release the button when frequency begins to change.

The tuner presets all the stations it can receive into the channels in ascending order. When finished, the last station memorized is tuned in.

Manual presetting

Preset the stations one at a time.

- ① Press [PROGRAM] then press [◀◀/REW/∨] or [∨/FF/▶▶] to tune to the required station.
- ② Press [PROGRAM] then press [◀◀/REW/∨] or [∨/FF/▶▶] to select a channel.
- ③ Press [PROGRAM].

The station occupying a channel is erased if another station is preset in that channel.

Selecting channels

1 Press the numbered buttons to select the channel.

- To enter channel 10 or over.
Press [≥10], then the two digits.

OR

- ① Press [PLAY MODE] to select "PRESET".
- ② Press [◀◀/REW/∨] or [∨/FF/▶▶] to select the channel.

2 Adjust the volume.

A**B****How to hold CDs**

Do not touch the recorded surface.

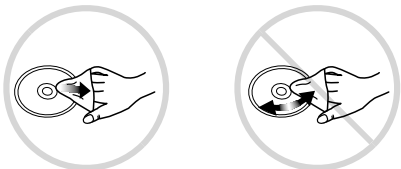
C**How to clean CDs**

Wipe from inside outward.

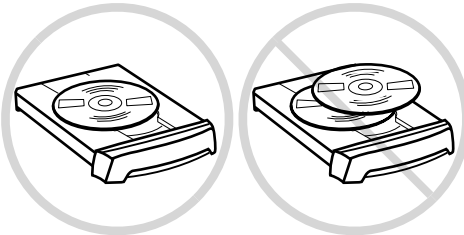
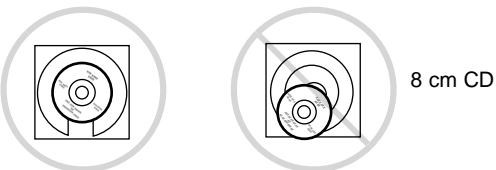
D**E****F**

8 cm CD



12 cm CD

About compact discs

With this system, you can only play compact discs having this mark.

- A** However, do not use irregular shaped CDs. CDs of the sort can damage the unit.

**B ~ D Handling precautions**

- If you are taking the disc from a cold to a warm environment, moisture may form on the disc. Wipe this off with a soft, dry, lint-free cloth before using the disc.
- Do not write on the label side with a ball-point pen or other writing instrument.
- Do not use record cleaning sprays, benzene, thinner, static electricity prevention liquids or any other solvent.
- Do not attach labels or stickers to CDs. (Do not use CDs with exposed adhesive from tape or left over peeled off stickers.)
- Do not use scratch-proof protectors or covers other than those specified for use with this system.
- Do not use CDs printed with label printers available on the market.

Storage precautions

Be sure to store discs in their cases to protect them from dust, scratches, and warping.

Do not place or store discs in the following places

- Locations exposed to direct sunlight
- Humid or dusty locations
- Locations directly exposed to a heat vent or heating appliance
- In the glove compartment or on the rear deck of an automobile

To prevent damage

Always observe the following points.

- **E** Load only 1 CD on the tray.
- **F** Load CDs as shown in the figure. The adapter is not needed with 8 cm CDs (singles).
- Set the system on a flat, level surface. Do not set it on top of magazines, inclined surfaces, etc.
- Do not move the system while tray is opening/closing, or when loaded. Always unload all CDs before moving the system.
- Do not put anything except a CD in the tray.
- Do not use cleaning CDs or CDs which are badly warped or cracked.
- Do not disconnect the power cord from the household AC outlet during disc changing operation.

ends scrolling: The display will be shown again.

To display album names

During play or

Press and [DISPLAY].

The album name will scroll across the display from the higher level of the hierarchy to the lowest (max. 8 levels), then followed by the track name.

("ROOT" is the highest hierarchical level.)

The previous display returns thereafter.

- compatible with packet-write format.
do not use ID tags.
If CD-DA data is recorded on the disc, only the data from the first session is played.
The number of displayable characters in the album and track names is limited to 32 characters.
The 1-Disc Random, All-Disc Random, program and track repeat, and repeat functions may not be played due to the condition of the disc or the disc may not be played in the order you recorded.

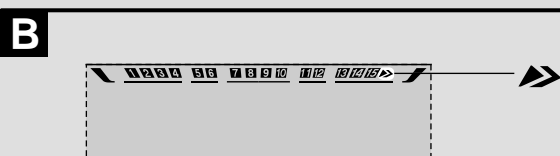
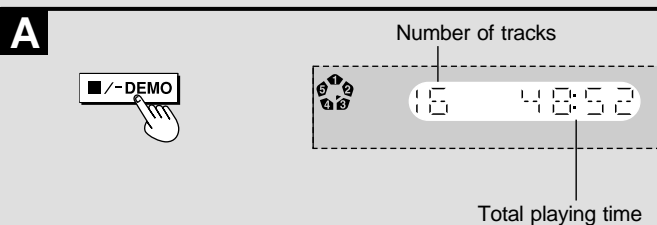
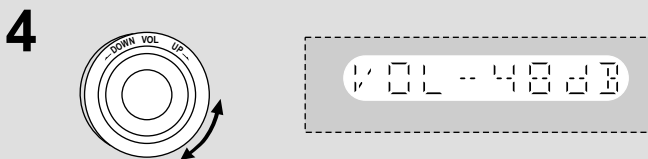
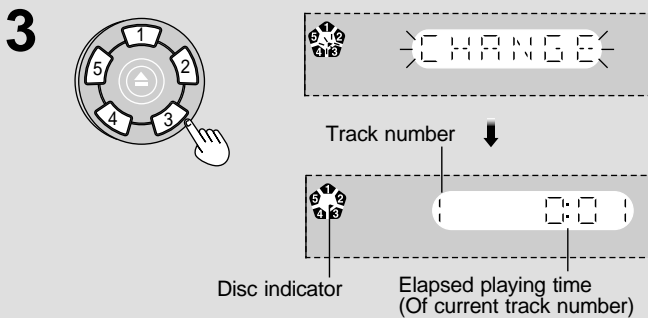
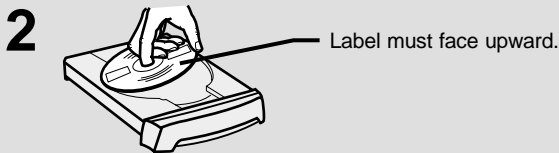
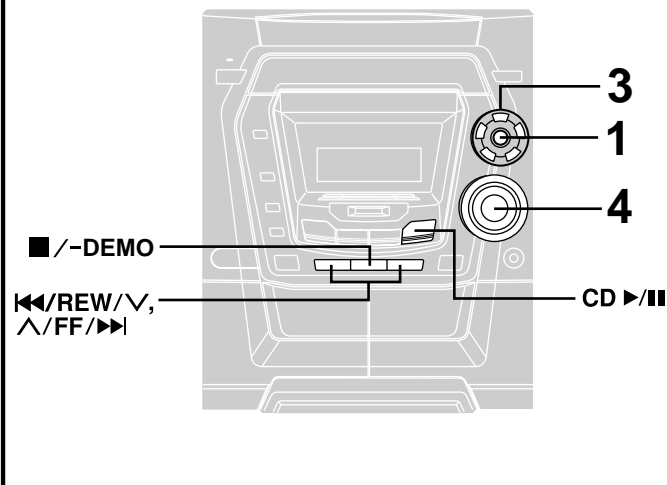

Listening to compact discs

This unit can play CD-DA (digital audio) format audio CD-R and CD-RW that have been finalized (a process that enables CD-R/CD-RW players to play audio CD-R and CD-RW) upon completion of recording.

It may not be able to play some CD-R or CD-RW due to the condition of the recording.

1 Press [▲] button.

The unit will come on automatically and the tray opens.

2 Set CD in the tray.

To continue loading CDs in the other trays

Press another [(1) ~ (5)] to select the required tray and press [▲] to open the tray.

The current tray closes and the selected tray automatically opens.

Press [▲] to close the tray.

3 Press [(1) ~ (5)] to play your desired disc.

(If the desired CD is indicated on the display panel, the same operation can be accomplished by pressing [CD ▶/||].)

The selected disc is played.

Use the CD Play Mode function's ALL-DISC mode to play CD in succession. (→ page 18).

4 Adjust the volume.

A To stop the disc play

Press [■/-DEMO].

B When “>>” appears on the display

It indicates there are 16 or more tracks on the disc in the playing position.

Disc indicator

The disc indicator on the display light whenever the tray is in the playing position whether it is loaded or not.

One touch play

If the unit is in standby mode and a CD is loaded, press [CD ▶/||] or [(1) ~ (5)].

The unit will come on automatically and play will start.

To pause	Press [CD ▶/] during playback. To resume playback, press [CD ▶/].
To search forward/backward (Search)	Hold down [◀◀/REW/VOL-] (backward) or [▶▶/FF/VOL+] (forward) during playback or pause mode.
To skip forward/backward	Press [◀◀/REW/VOL-] (backward) or [▶▶/FF/VOL+] (forward) during playback or pause mode.

Notes

- During 1-Disc Random play or All-Disc Random play (→ page 18), you cannot skip to tracks which have already been played.
- During program play (→ page 17), 1-Disc Random play or All-Disc Random play, you can search forward or backward only within the current track.
- During program play, skipping is always in the programmed order, whether forward or backward.
- Always stop the changer before loading or changing CDs. You cannot change CDs while a disc is playing.

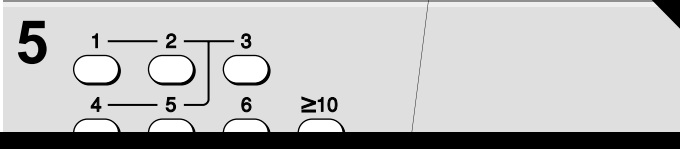
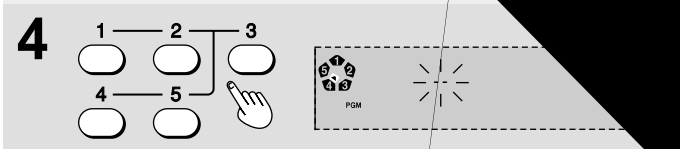
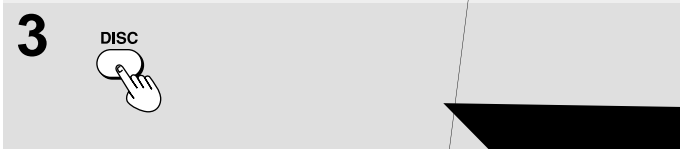
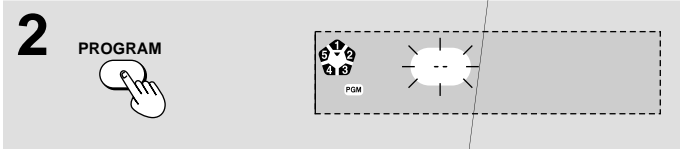
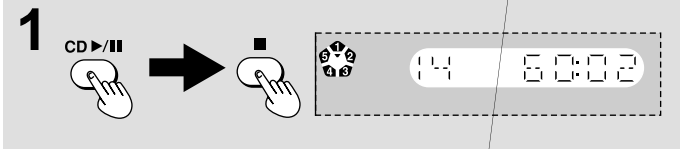
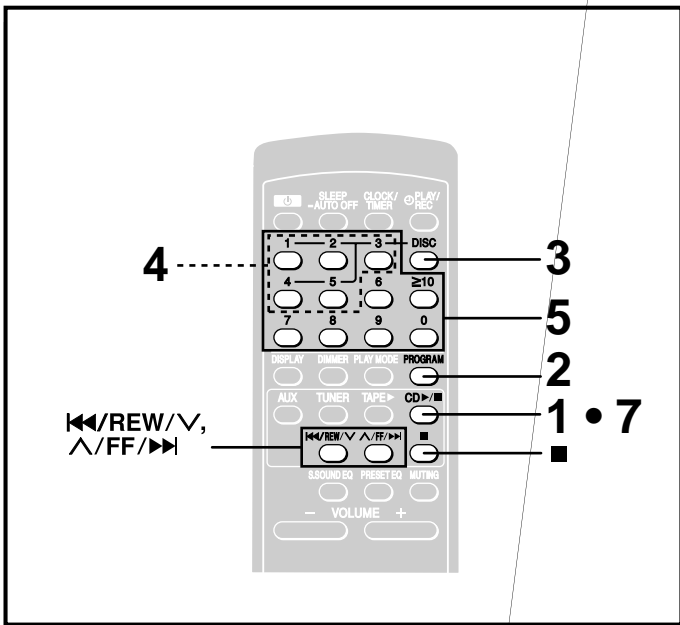

compact disc operations



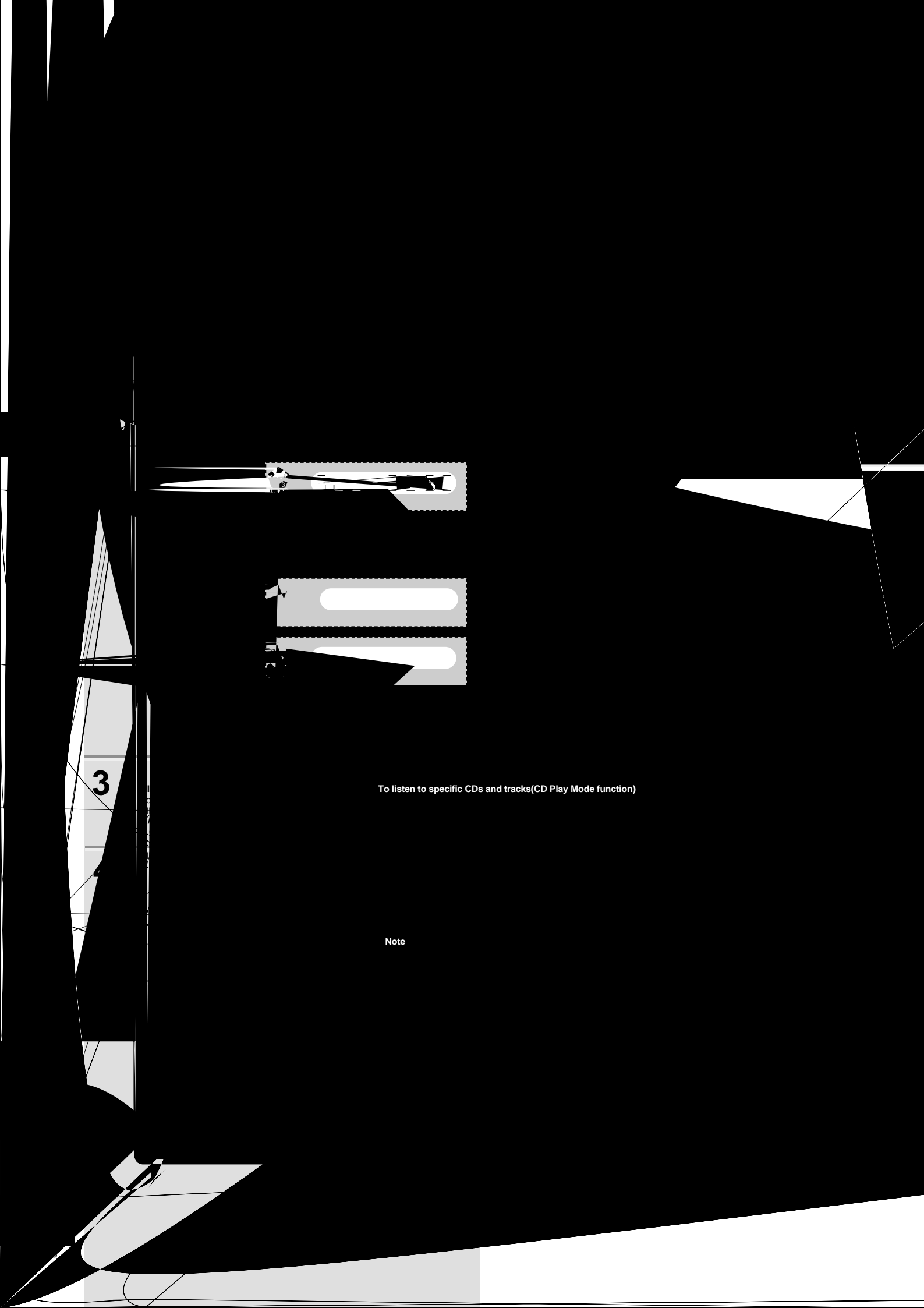

3

To listen to specific CDs and tracks(CD Play Mode function)

Note

Listening to compact discs

Direct access play

Remote control only

- 1** Press [DISC].
- 2** (within 10 seconds or so)
Press [1] – [5] to select the disc you want.
- 3** Press the numeric button to select the desired track number.

The CD will be played from the selected track to the last track of the disc.

To select a two-digit track

Press ≥ 10 and then the two numbers you want within 10 seconds or so.

For example

Track no. 20: ≥ 10 → [2] → [0]

Track no. 35: ≥ 10 → [3] → [5]

Note

You cannot use direct access play with 1-SONG, 1-RANDOM or A-RANDOM mode.

Repeat play

Remote control only

- A** Press and hold [PLAY MODE] before or during play.

“REPEAT ON” and “” are displayed.

To cancel repeat play

Press and hold [PLAY MODE] once again. “REPEAT OFF” is displayed and “” is cleared.

To repeat your favorite tracks

1. Program the tracks you want (perform steps 1 ~ 6 on page 17).
2. Press and hold [PLAY MODE] and make sure “REPEAT ON” and “” are displayed.
3. Press [CD ▶/||]. Playback will start.

To use repeat play with CD Play Mode function

Set the desired mode (→ page 18), press and hold [PLAY MODE] before or during playback, and make sure “REPEAT ON” and “” are displayed.

B CD display

This function allows you to display the remaining play time of the current track.

During play or pause mode

Press [DISPLAY].

Every time you press the button:

Elapsed play time ↔ Remaining play time

Note

When track number 25 or greater is playing, remaining play time display shows “- -: -”.

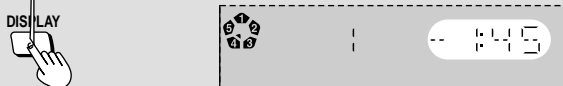
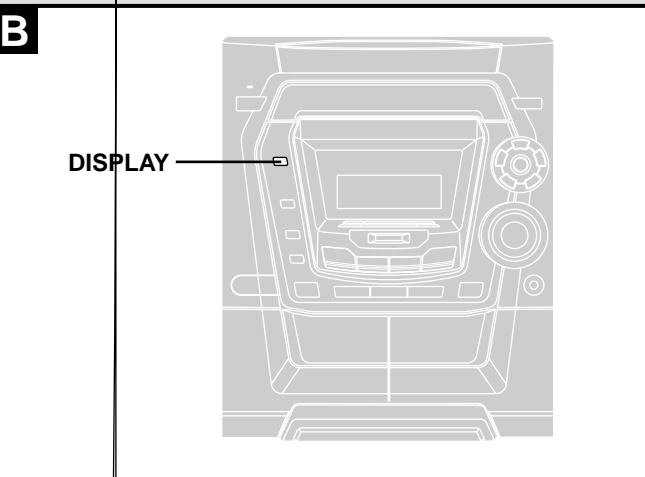
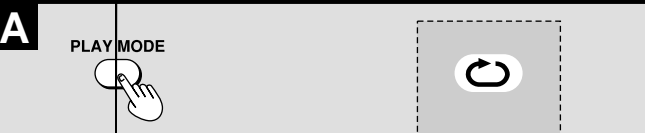
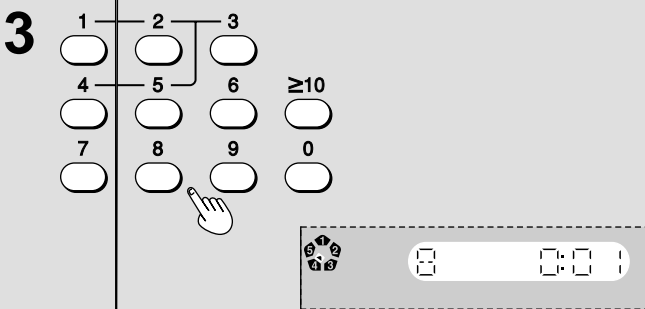
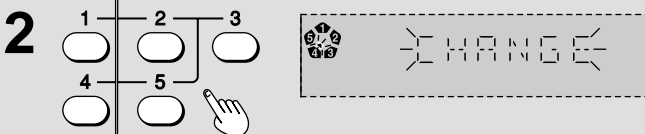
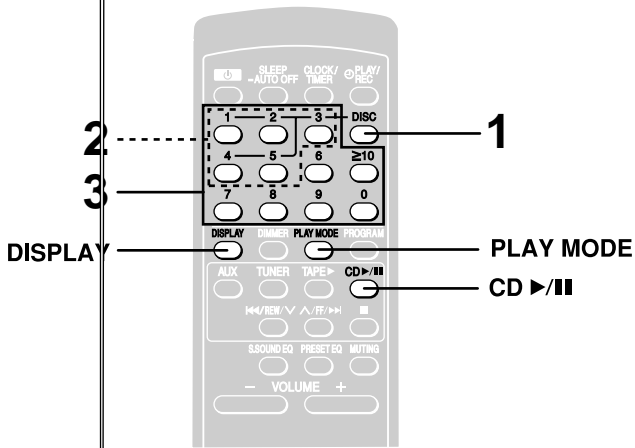

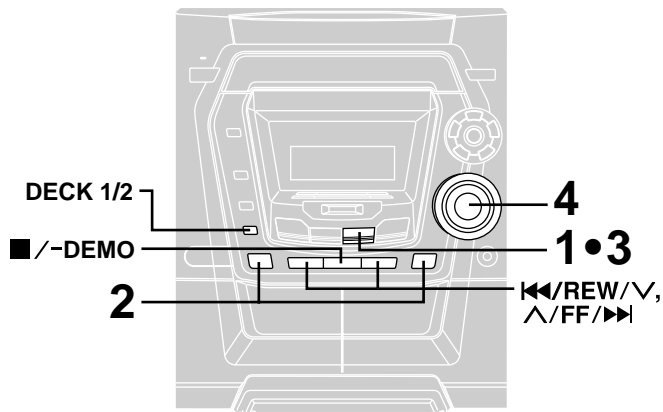

1



2

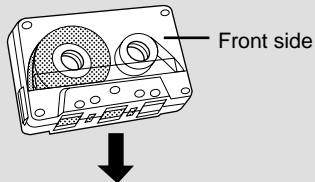

3



VOL 48.00

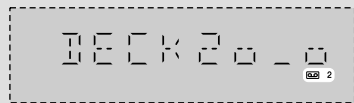

Listening to tapes

You can use either deck 1 or deck 2 for tape playback.

Use normal position tapes.

High position and metal position tapes can be played, but the unit will not be able to do full justice to the characteristics of these tapes.

1 Press [TAPE ▶].

The unit will come on automatically.

If the unit was off and a cassette was loaded, play will start automatically (One touch play function).

2 Press [▲ DECK 1 OPEN] or [▲ DECK 2 OPEN] and insert the tape.

Insert the tape with the exposed tape facing down.
Close the holder by hand.

3 Press [TAPE ▶] to start playback.

One side is played, then playback stops automatically.

To play on the other side of the tape, turn the tape over and press [TAPE ▶].

4 Adjust the volume.

To stop tape playback

Press [■/-DEMO].

Fast-forward and rewind

Press [◀◀/REW/∨] (rewind) or [∧/FF/▶▶] (fast-forward).

▲ To change the deck to be used

Press [DECK 1/2] to select the deck you want to use when you load cassettes into both decks.

You can also use remote control to perform by pressing [PLAY MODE].

Notes

- Playback is momentarily interrupted while playing back tapes, if you open the other deck.
- Tapes exceeding 100 minutes are thin and can break or get caught in the mechanism.
- Tape slack can get caught up in the mechanism and should be taken up before the tape is played.
- Failure to operate endless tapes correctly may cause the tape to wind around the revolving parts. Always read the instructions provided with your tapes.

A

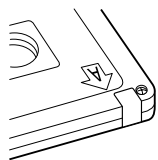
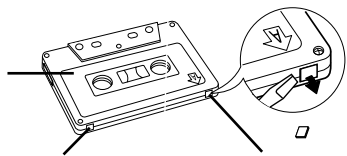

B

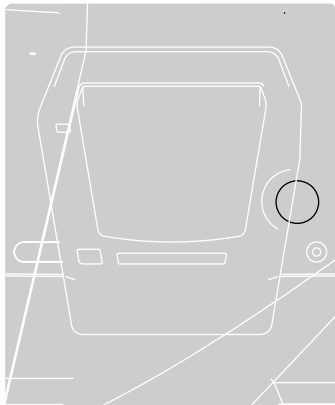

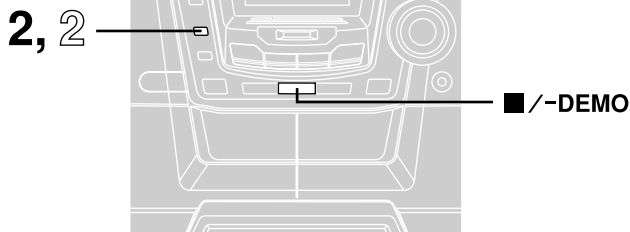
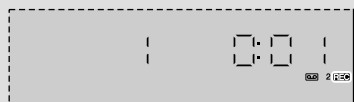
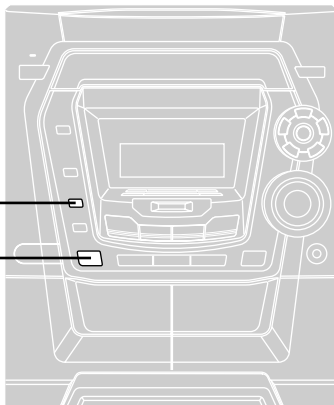
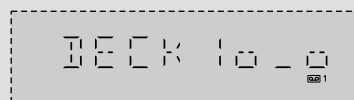
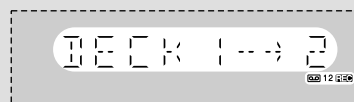
A**2**
2**B****2**
1**1****2****A Recording from compact discs**

You can use 1-DISC/ALL-DISC/1-SONG mode (→ page 18) to make recordings.

Preparation:

- Do the preparatory steps (→ page 21).
- Insert the disc(s) you want to record (→ page 16).

1-DISC/ALL-DISC recording**1 Do steps 1 to 4 on page 18.**

Ensure CD is stopped.

2 Press [● REC] to start recording.

The CD starts.

1-SONG recording**1 Do steps 1 to 5 on page 18.****2 Press [● REC] to start recording.**

The CD starts.

To stop recording

Press [■/-DEMO].

Disc play stops automatically.

If the tape finishes before the disc

The disc continues playing. Press [■/-DEMO] to stop it.

To record programmed tracks

- ① Program the tracks (→ page 17).
- ② Press [● REC] to start recording.

Play starts.

To stop recording, press [■/-DEMO].

Disc play stops automatically.

B Tape-to-tape recording

The recording level will be recorded as it is on the tape being played back.

Preparation :

- Do the preparatory steps (→ page 21).
- Press [TAPE ►] then [■/-DEMO] to select tape as the source.

1 Press [▲ DECK 1 OPEN] and insert the tape you want to record.**2 Press [● REC] to start recording.****To stop recording**

Press [■/-DEMO].

Both decks will stop.

To record from a specific point on a tape

Before recording, advance the tape to the point from where you want to start recording.

2

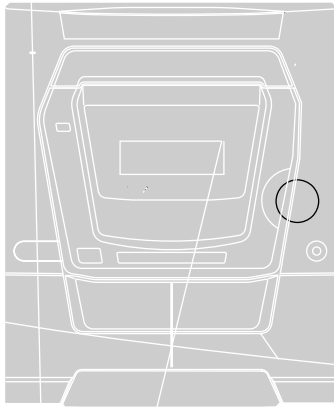

2



A

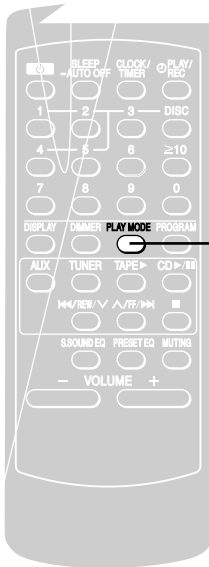

PLAY MODE

PLAY MODE

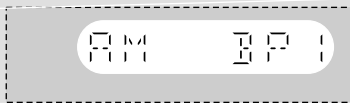

A

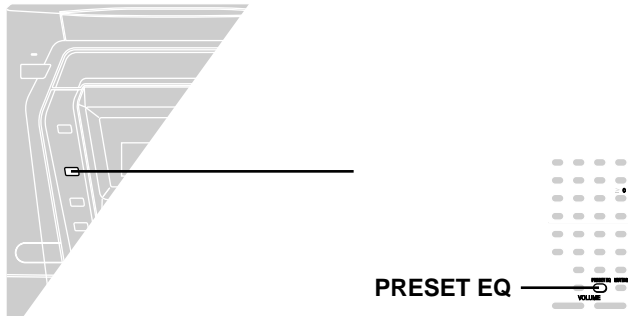

A Using the built-in sound quality settings

Press **[PRESET EQ]** to select the sound quality.

Every time you press the button:

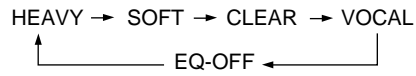

HEAVY : Select this when playing rock or other kinds of music that sounds better with an added punch.

SOFT : Select this when listening to background music.

CLEAR : Select this for jazz or other kinds of music for which clarity in the treble range is desired.

VOCAL : Select this to add gloss to vocals.

The original display is restored on the display panel in about 4 seconds.

Notes

- Preset EQ cannot be used together with Super Sound EQ.
- All recordings are performed at “EQ-OFF” setting even if an alternative sound quality setting has been selected.

B

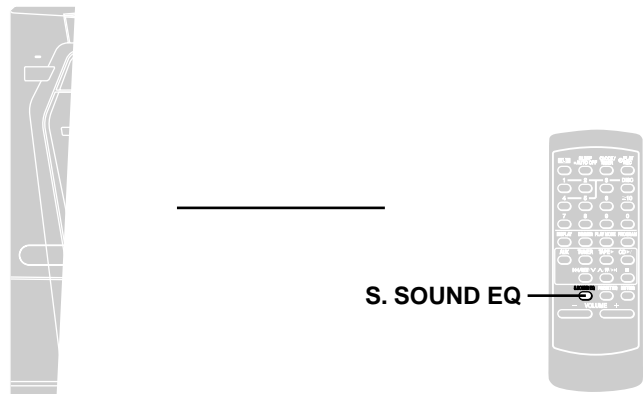

B Enhancing the sound quality

This feature enhances the bass and treble effect of the sound.

Press **[SUPER SOUND EQ]**.

Remote control: Press [S.SOUND EQ].

Press the button again to cancel.

The button light goes out.

Using the timer

Using the play/record timer

Remote control only

The timer has two functions. It can be set to on at a certain time to wake you up, or it can be set to record the radio or from the aux source.

The play timer cannot be used in combination with the record timer.

Preparations

- Turn the unit on and set the clock (→ page 11).
- **For the play timer**, prepare the music source you want to listen to; tape, CD, radio or aux, and set the volume.
- **For the record timer**, check the cassette's erasure prevention tabs (→ page 21: **A**), insert the tape in deck 2 (→ page 21) and tune to the radio station (→ page 12) or select the aux source (→ page 27).

1 Press [CLOCK/TIMER] to select the timer function.

Every time you press the button:

CLOCK → PLAY → REC
 ↑ Previous display ↓

PLAY : to set the play timer

REC : to set the record timer

2 ON time setting

① (Within 8 seconds or so)

Press [] to select the starting time.

② Press [CLOCK/TIMER].

3 OFF time setting

① Press [] to select the finishing time.

② Press [CLOCK/TIMER].

The start and finish times are now set.

4 Press [PLAY/REC] to display the timer indicator.

Every time you press the button:

PLAY → REC
 ↑ (OFF) ↓

PLAY : to turn the play timer on

REC : to turn the record timer on

(The indicator doesn't appear if the start and finish times or the clock hasn't been set.)

5 Press [] to turn the unit off.

The unit must be off for the timers to operate.

• For play timer

The timer play will start at the preset time with volume increasing gradually up to the volume level you pre-set.

• For record timer

The record timer comes on about 30 seconds earlier than the set time.

To cancel the timer

Press [PLAY/REC] to clear the timer indicators from the display. (The timer comes on at the set time everyday if the timer is on.)

To change the settings (when unit is on)

• To change the play/record times

Do steps 1, 2, 3 and 5.

• To change the source or volume

1. Press [PLAY/REC] to clear the timer indicator from the display.

2. Make changes to the source or volume.

3. Do steps 4 to 5.

(Continued on next page)

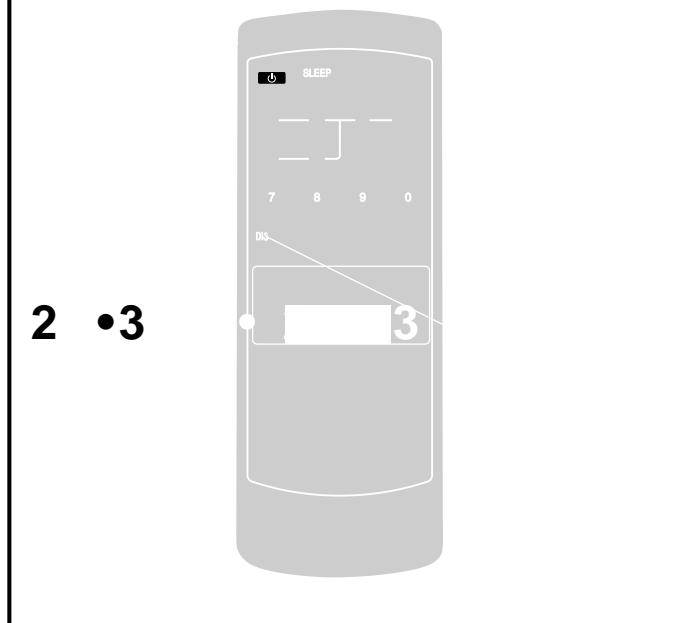

1 **CLOCK/TIMER**



2 ①

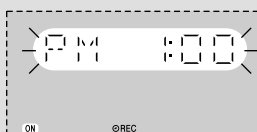

② **CLOCK/TIMER**



3 ①

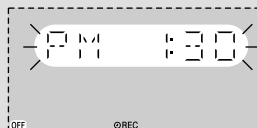
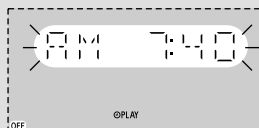

CLOCK/TIMER



4 **PLAY/REC**

PLAY

REC

5



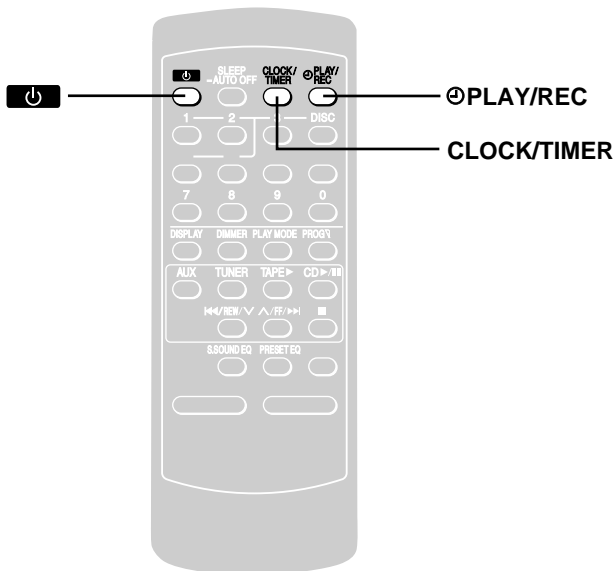

Using the timer

Using the play/record timer

Remote control only

To change the timer

Press [PLAY/REC] to select the desired timer.

Every time the button is pressed the setting changes as follows.

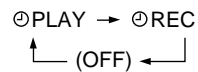

To check settings

While the unit is on and the "PLAY" (or "REC") indicator is on, press [CLOCK/TIMER] so "PLAY" (or "REC") appears on the display.

Two seconds after "PLAY" (or "REC") appear, the settings are displayed in the following order:

- For play timer
 - ① Play start time
 - ② Play finish time
 - ③ Play source
 - ④ Playback volume
- For record timer
 - ① Recording start time
 - ② Recording finish time
 - ③ Recording source

You can check the settings even when the system is OFF by pressing [CLOCK/TIMER] twice.

To enjoy the desired source after the timer setting is completed

The volume level (for play timer) and music source are stored in the timer memory and the timer will start in these preset conditions. However, the Disc numbers do not get stored in the timer memory.

1. After step 4, start playing the desired source.
2. Reset the Disc numbers if you have changed any of them, confirm that a Disc or cassette is inserted, then press [POWER] to put the unit on standby.

Notes

- If you switch the system to the standby mode while the play/record timer is functioning, the OFF time setting will not be activated.
- If AUX is selected as the source, when the timer comes ON, the system will turn ON and will engage "AUX" as the source. If you want to playback or record from a connected component, set the component's timer to the same time. (See the instruction manual that came with the component.)

A

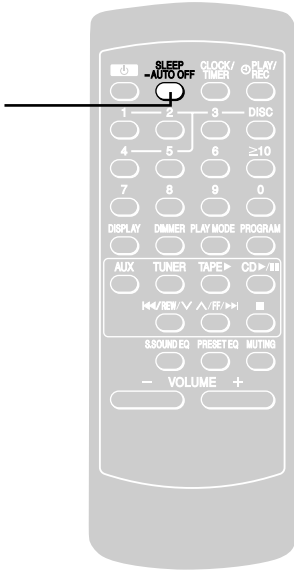

B

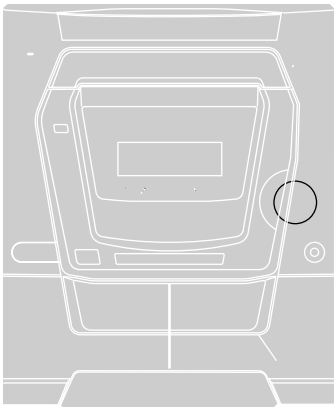

C

Troubleshooting guide

Before requesting service, make the below checks. If you are in doubt about some of the check points, or if the remedies indicated in the chart do not solve the problem:

In the U.S.A., contact the Panasonic Customer Call Center at 1-800-211-7262, or e-mail consumerproducts@panasonic.com, or web site (<http://www.panasonic.com>).

In Canada, contact Panasonic Canada Inc. Customer Care Centre at 905-624-5505, web site (www.panasonic.ca), or an authorized Servicentre closest to you.

Reference pages are shown as black circled numbers ⑥.

Common Problems

No sound. Sound stops.	Turn the volume up. Switch off the unit, determine and correct the cause, then switch the unit on. Causes include shorting of the positive and negative speaker wires, straining of the speakers through excessive volume or power, and using the unit in a hot environment.
Sound is unfixed, reversed or comes from one speaker only.	Check the speaker connections. ⑥
Humming heard during play.	An AC power supply cord or fluorescent light is near the cables. Keep other appliances and cords away from this unit's cables.
"ERROR" is displayed.	Incorrect operation performed. Read the instructions and try again.
"- -: -" appears on the display at standby mode.	You plugged the AC power supply cord in for the first time or there was a power failure recently. Set the time. ①
"F61" is displayed.	Check and correct the speaker cords connection. ⑥ If this does not fix the problem, there is a power supply problem. Consult the dealer.

Listening to the radio

Noise is heard. The stereo indicator flickers or doesn't light. Sound is distorted.	Use an outdoor antenna. ⑦
A beat sound is heard.	Turn the TV off or separate it from the unit.
A low hum is heard during AM broadcasts.	Separate the antenna from other cables and cords.

When there is a television set nearby

The picture on the TV disappears or stripes appear on the screen.	The location and orientation of the antenna are incorrect. If you are using an indoor antenna, change to an outdoor antenna. The TV antenna wire is too close to the unit. Separate the antenna wire of the TV set from the unit.
---	--

Using the cassette deck

Poor quality sound. Recording is not possible.	Clean the heads. back cover If the erasure prevention tabs have been removed, cover the holes with adhesive tape. ②
---	---

Playing discs

The display is wrong or play won't start.	The disc may be upside down. ⑩ Wipe the disc. Replace the disc if it is scratched, warped, or non-standard. Condensation may have formed inside the unit due to a sudden change in temperature. Wait about an hour for it to clear and try again.
The total number of tracks displayed differs each time the same disc is inserted. Unusual sound is heard.	The disc may be scratched, or its data may be defective. Replace the disc.
CD-RW cannot be read.	The disc was incompletely formatted. Use the recording equipment to fully format the disc before recording.
"VBR-" is displayed instead of the remaining play time.	The unit cannot display the remaining play time for variable bit rate (VBR) tracks.
"TAKE OUT/DISC" appears on the display.	There is a problem with the disc mechanism. (A power failure may have occurred.) The tray will open automatically. Remove the disc from the tray, and after ensuring there is no disc in the tray, close it. The unit will make the disc changing noises for a few moments and then it should operate normally.
The changer cannot change to the selected disc or play won't start.	Press [PLAY MODE] on the remote control to clear 1-SONG mode and try again.

Remote control

Remote control doesn't work.	Check the batteries are inserted correctly. ⑤ Replace the batteries if they are worn.
------------------------------	--

Servicenter List (ONLY FOR U.S.A.)

*For Product Information, Operating Assistance, Literature Request, Dealer Locations, and all Customer Service inquiries please contact:
1-800-211-PANA (7262), Monday–Friday 9 am–9*

Warranty (ONLY FOR U.S.A.)

Panasonic Consumer Electronics Company,
Division of Matsushita Electric Corporation of America
One Panasonic Way Secaucus, New Jersey 07094

Panasonic Sales Company, Division of Matsushita Electric
of Puerto Rico, Inc.
Ave. 65 de Infantería, Km. 9.5
San Gabriel Industrial Park, Carolina, Puerto Rico 00985

Panasonic/Technics Audio Products Limited Warranty

Panasonic Consumer Electronics Company or Panasonic Sales Company (collectively referred to as "the Warrantor") will repair or replace this product with new or refurbished parts or equivalent product, free of charge in the U.S.A. or Puerto Rico, in the event of a defect in materials or workmanship as follows (all time periods commence from the date of original purchase):

AUDIO PRODUCTS—labor and parts for one (1) year.

ALL AUDIO RACKS (cabinets)—parts only 30 days.

TECHNICS STAND ALONE SPEAKERS, SUBWOOFER SPEAKERS—labor and parts for three (3) years.

USB READER-WRITER, PERSONAL COMPUTER CARD ADAPTERS—

(when applicable)—exchange defective unit with a new or refurbished one for one (1) year.

ACCESSORIES—HEADPHONES, CARTRIDGES, MICROPHONES, ADAPTERS—labor and parts for ninety (90) days.

RECHARGEABLE BATTERIES—(when applicable)—exchange defective item for new one for ten (10) days. Non-rechargeable batteries are not warranted.

SD MEMORY CARDS, RECHARGEABLE BATTERY PACKS—(when applicable)—exchange defective item for new one for ninety (90) days. Non-rechargeable battery packs are not warranted.

Carry-in or mail-in service in the U.S.A. can be obtained during the warranty period by contacting a Panasonic Services Company (PASC) Factory Servicenter listed in the Servicenter Directory. Or call toll free, 1-800-211-7262 to locate a PASC authorized Servicenter. Carry-in or mail-in service in Puerto Rico can be obtained during the warranty period by calling the Panasonic Sales Company telephone number listed in the Servicenter Directory.

This warranty is extended only to the original purchaser. A purchase receipt or other proof of date of original purchase will be required before warranty service is rendered.

This warranty only covers failures due to defects in materials and workmanship which occur during normal use and does not cover normal wear to the stylus (when applicable) or a dealer installed cartridge or stylus. The warranty does not cover damages which occur in shipment or failures which are caused by products not supplied by the warrantor, or failures which result from accident, misuse, abuse, neglect, mishandling, faulty installation, misapplication, set-up adjustments, maladjustment of consumer controls, improper operation or maintenance, improper antenna, inadequate signal reception or pick-up, alteration, modification, power line surge, improper voltage supply, lightning damage, commercial use, such as; hotel, office, restaurant, or other business or rental use of the product, or service by anyone other than a PASC Factory Servicenter or a PASC authorized Servicenter, or damage that is attributable to acts of God.

LIMITS AND EXCLUSIONS

There are no express warranties except as listed above.

THE WARRANTOR SHALL NOT BE LIABLE FOR INCIDENTAL OR CONSEQUENTIAL DAMAGES RESULTING FROM THE USE OF THIS PRODUCT, OR ARISING OUT OF ANY BREACH OF THIS WARRANTY, INCLUDING WITHOUT LIMITATION, DAMAGE TO TAPES, RECORDS OR DISCS. ALL EXPRESS AND IMPLIED WARRANTIES, INCLUDING THE WARRANTIES OF MERCHANTABILITY, AND FITNESS FOR A PARTICULAR PURPOSE, ARE LIMITED TO THE APPLICABLE WARRANTY PERIOD SET FORTH ABOVE. Some states do not allow the exclusion or limitation of incidental or consequential damages, or limitations on how long an implied warranty lasts, so the above exclusions or limitations may not apply to you.

This warranty gives you specific legal rights and you may also have other rights which vary from state to state.

If a problem with this product develops during or after the warranty period, you may contact your dealer or Servicenter. If the problem is not handled to your satisfaction, then write to the Consumer Affairs Department at the company address indicated above.

If you ship the product

Carefully pack and send it prepaid, adequately insured and preferably in the original carton.

Attach a postage-affixed letter, detailing the complaint, to the outside of the carton.

Do NOT send the product to the Executive or Regional Sales offices. They are NOT equipped to make repairs.

Specifications

AMPLIFIER SECTION **SC-AK500**

Power output
10% Total harmonic distortion
60 Hz–3 kHz, both channels driven
 (Low channel) 60 W per channel (6 Ω)
3 kHz–16 kHz, both channels driven
 (High channel) 50 W per channel (6 Ω)
Total Bi-Amp power 110 W per channel

Power output
10% Total harmonic distortion
1 kHz, both channels driven
 (Low channel) 77 W per channel (6 Ω)
8 kHz, both channels driven
 (High channel) 73 W per channel (6 Ω)
Total Bi-Amp power 150 W per channel

Input sensitivity
AUX 250 mV
Input Impedance
AUX 13.3 kΩ

AMPLIFIER SECTION **SC-AK490**

Power output
10% Total harmonic distortion
60 Hz–3 kHz, both channels driven
 (Low channel) 45 W per channel (6 Ω)
3 kHz–16 kHz, both channels driven
 (High channel) 45 W per channel (6 Ω)
Total Bi-Amp power 90 W per channel

Power output
10% Total harmonic distortion
1 kHz, both channels driven
 (Low channel) 56 W per channel (6 Ω)
8 kHz, both channels driven
 (High channel) 54 W per channel (6 Ω)
Total Bi-Amp power 110 W per channel

Input sensitivity
AUX 250 mV
Input Impedance
AUX 13.3 kΩ

AMPLIFIER SECTION **SC-AK300**

Power output
10% Total harmonic distortion
60 Hz–3 kHz, both channels driven
 (Low channel) 45 W per channel (6 Ω)
3 kHz–16 kHz, both channels driven
 (High channel) 45 W per channel (6 Ω)
Total Bi-Amp power 90 W per channel

Power output
10% Total harmonic distortion
1 kHz, both channels driven
 (Low channel) 56 W per channel (6 Ω)
10 kHz, both channels driven
 (High channel) 54 W per channel (6 Ω)
Total Bi-Amp power 110 W per channel

Input sensitivity
AUX 250 mV
Input Impedance
AUX 13.3 kΩ

AMPLIFIER SECTION **SC-AK200**

Power output
10% Total harmonic distortion
60 Hz–3 kHz, both channels driven
 (Low channel) 30 W per channel (6 Ω)
3 kHz–16 kHz, both channels driven
 (High channel) 30 W per channel (6 Ω)
Total Bi-Amp power 60 W per channel

Power output
10% Total harmonic distortion
1 kHz, both channels driven
 (Low channel) 42 W per channel (6 Ω)
10 kHz, both channels driven
 (High channel) 38 W per channel (6 Ω)
Total Bi-Amp power 80 W per channel

Input sensitivity
AUX 250 mV
Input Impedance
AUX 13.3 kΩ

FM TUNER SECTION

Frequency range
 87.9 – 107.9 MHz (200 kHz steps)
 87.5 – 108.0 MHz (100 kHz steps)
Sensitivity 2.5 μV (IHF)
S/N 26 dB 2.2 μV
Antenna terminal(s) 75 Ω (unbalanced)

AM TUNER SECTION

Frequency range
 520 – 1710 kHz (10 kHz steps)
Sensitivity
S/N 20 dB (at 1000 kHz) 560 μV/m

CASSETTE DECK SECTION

Track system 4 track, 2 channel
Heads
Record/playback Solid permalloy head
Erasure Double gap ferrite head
Motor DC servo motor
Recording system AC bias 100 kHz
Erasing system AC erase 100 kHz
Tape speed 4.8 cm/s (1⁷/₈ ips)
Overall frequency response
(+3 dB, –6 dB at DECK OUT)
NORMAL (TYPE I) 35 Hz – 14 kHz
S/N 50 dB (A weighted)
Wow and flutter 0.18% (WRMS)
Fast forward and rewind time
 Approx. 120 seconds with
 C-60 cassette tape

CD SECTION

Sampling frequency 44.1 kHz
Decoding 16 bit linear
Beam source/wavelength
 Semiconductor laser/780 nm
Number of channels Stereo
Frequency response
 20 Hz–20 kHz (+1, –2 dB)

Wow and flutter Below measurable limit
Digital filter 8 fs
D/A converter MASH (1 bit DAC)

MP3 (**SC-AK500** and **SC-AK490** only)

MP3 decode Base on MPEG 1 Layer 3
Bitrate 32 kbps–320 kbps
Sampling frequency
 32 kHz, 44.1 kHz, 48 kHz

SPEAKER SECTION **SB-AK500**

Type 3 way speaker system
Speaker(s)
Woofers 12 cm (4³/₄" cone type
Tweeters 6 cm (2³/₈" cone type
Super tweeter Piezo type
Impedance
HIGH 6 Ω
LOW 6 Ω

Input power
HIGH 130 W (Music)
LOW 130 W (Music)

Output sound pressure level
 85 dB/W (1.0 m)

Cross over frequency 3.5 kHz
Frequency range 45 Hz–22 kHz (–16 dB)
 55 Hz–20 kHz (–10 dB)

Dimensions (WxHxD) 210 x 315 x 251 mm
 (8⁹/₃₂" x 12¹³/₃₂" x 9²³/₃₂"

Mass 2.8 kg (6.3 lb.)

SPEAKER SECTION **SB-AK300**

Type 3 way speaker system
Speaker(s)
Woofers 12 cm (4³/₄" cone type
Tweeters 6 cm (2³/₈" cone type
Super tweeter Piezo type

Impedance
HIGH 6 Ω
LOW 6 Ω

Input power
HIGH 100 W (Music)
LOW 100 W (Music)

Output sound pressure level
 85 dB/W (1.0 m)

Cross over frequency 3.5 kHz
Frequency range 45 Hz–22 kHz (–16 dB)
 55 Hz–20 kHz (–10 dB)

Dimensions (WxHxD) 210 x 315 x 251 mm
 (8⁹/₃₂" x 12¹³/₃₂" x 9²³/₃₂"

Mass 2.8 kg (6.3 lb.)

SPEAKER SECTION **SB-AK200**

Type 2 way speaker system
Speaker(s)
Woofers 12 cm (4³/₄" cone type
Tweeters 6 cm (2³/₈" cone type

Impedance
HIGH 6 Ω
LOW 6 Ω

Input power
HIGH 80 W (Music)
LOW 80 W (Music)

Output sound pressure level
 85 dB/W (1.0 m)

Cross over frequency 3.5 kHz
Frequency range 45 Hz–22 kHz (–16 dB)
 55 Hz–20 kHz (–10 dB)

Dimensions (WxHxD) 210 x 315 x 228 mm
 (8⁹/₃₂" x 12¹³/₃₂" x 8³¹/₃₂"

Mass 2.6 kg (5.7 lb.)

GENERAL

Power supply AC 120 V, 60 Hz

Power consumption

SC-AK500 (250 VA) 215 W

SC-AK300 165 W

SC-AK200 150 W

Standby Approx. 0.34 W

Dimensions (WxHxD) 250 x 315 x 345 mm
 (9²⁷/₃₂" x 12¹³/₃₂" x 13¹⁹/₃₂"

Mass
SC-AK500 (For U.S.A.) 7.8 kg (17.2 lb.)

SC-AK500 (For Canada) 7.5 kg (16.5 lb.)

SC-AK300 7.4 kg (16.3 lb.)

SC-AK200 6.9 kg (15.2 lb.)

Notes:

- Specifications are subject to change without notice.
Mass and dimensions are approximate.
- Total harmonic distortion is measured by the digital spectrum analyzer.
- The labels "HIGH" and "LOW" on the rear of the speakers refer to High frequency and Low frequency.

Maintenance

If the surfaces are dirty

To clean this unit, wipe with a soft, dry cloth.

- Never use alcohol, paint thinner or benzine to clean this unit.
- Before using a chemically treated cloth, read the instructions that came with the cloth carefully.

For a cleaner, crisper sound

Clean the heads regularly to assure good quality playback and recording.

Use a cleaning tape (not included).

Product Service

1. **Damage requiring service**—The unit should be serviced by qualified service personnel if:
 - (a) The AC power supply cord or AC adaptor has been damaged; or
 - (b) Objects or liquids have gotten into the unit; or
 - (c) The unit has been exposed to rain; or
 - (d) The unit does not operate normally or exhibits a marked change in performance; or
 - (e) The unit has been dropped or the cabinet damaged.
2. **Servicing**—Do not attempt to service the unit beyond that described in these operating instructions. Refer all other servicing to authorized servicing personnel.
3. **Replacement parts**—When parts need replacing ensure the servicer uses parts specified by the manufacturer or parts that have the same characteristics as the original parts. Unauthorized substitutes may result in fire, electric shock, or other hazards.
4. **Safety check**—After repairs or service, ask the servicer to perform safety checks to confirm that the unit is in proper working condition.

Product information

For product information or assistance with product operation:
In the U.S.A., contact the Panasonic Customer Call Center at 1-800-211-7262, or e-mail consumerproducts@panasonic.com, or web site (<http://www.panasonic.com>).

In Canada, contact Panasonic Canada Inc. Customer Care Centre at 905-624-5505, web site (www.panasonic.ca), or an authorized Servicentre closest to you.



As an ENERGY STAR® Partner, Panasonic has determined that this product meets the ENERGY STAR® guidelines for energy efficiency.

Panasonic Consumer Electronics Company, Division of Matsushita Electric Corporation of America
One Panasonic Way Secaucus,
New Jersey 07094
<http://www.panasonic.com>

Panasonic Sales Company, Division of Matsushita Electric of Puerto Rico, Inc. ("PSC")
Ave. 65 de Infantería, Km. 9.5
San Gabriel Industrial Park, Carolina,
Puerto Rico 00985

Panasonic Canada Inc.
5770 Ambler Drive
Mississauga, Ontario
L4W 2T3
www.panasonic.ca



Free Manuals Download Website

<http://myh66.com>

<http://usermanuals.us>

<http://www.somanuals.com>

<http://www.4manuals.cc>

<http://www.manual-lib.com>

<http://www.404manual.com>

<http://www.luxmanual.com>

<http://aubethermostatmanual.com>

Golf course search by state

<http://golfingnear.com>

Email search by domain

<http://emailbydomain.com>

Auto manuals search

<http://auto.somanuals.com>

TV manuals search

<http://tv.somanuals.com>