

Panasonic®

Operating Instructions Home Theater Audio System

Model No. **SC-HTB10**



Dear customer

Thank you for purchasing this product.

For optimum performance and safety, please read these instructions carefully.

Before connecting, operating or adjusting this product, please read the instructions completely.

Please keep this manual for future reference.

The illustrations shown may differ from your unit.

Included Installation Instructions

The installation should never be done by any other than a qualified installation specialist.

Before commencing work, carefully read these installation instructions and the operating instructions to ensure that installation is performed correctly.

(Please keep these instructions. You may need them when maintaining or moving this unit.)

If you have any questions contact

For U.S.A. and Puerto Rico: 1-800-211-PANA(7262)

For Canada: 1-800-561-5505

For U.S.A. and Puerto Rico: The warranty can be found on page 18.

For Canada: The warranty can be found on page 20.

HDMI

VIERA Link™



As an ENERGY STAR® Partner,*
Panasonic has determined that
this product meets the ENERGY STAR®
guidelines for energy efficiency.

* For Canada only: The word "Participant" is used in place of the word "Partner".

WARNING:

TO REDUCE THE RISK OF FIRE, ELECTRIC SHOCK OR PRODUCT DAMAGE,

- DO NOT EXPOSE THIS APPARATUS TO RAIN, MOISTURE, DRIPPING OR SPLASHING AND THAT NO OBJECTS FILLED WITH LIQUIDS, SUCH AS VASES, SHALL BE PLACED ON THE APPARATUS.
- USE ONLY THE RECOMMENDED ACCESSORIES.
- DO NOT REMOVE THE COVER (OR BACK); THERE ARE NO USER SERVICEABLE PARTS INSIDE. REFER SERVICING TO QUALIFIED SERVICE PERSONNEL.

CAUTION!

DO NOT INSTALL OR PLACE THIS UNIT IN A BOOKCASE, BUILT-IN CABINET OR IN ANOTHER CONFINED SPACE. ENSURE THE UNIT IS WELL VENTILATED. TO PREVENT RISK OF ELECTRIC SHOCK OR FIRE HAZARD DUE TO OVERHEATING, ENSURE THAT CURTAINS AND ANY OTHER MATERIALS DO NOT OBSTRUCT THE VENTILATION VENTS.

Button-type battery (Lithium battery)

- Insert with poles aligned.
- Do not touch the terminals (+ and -) with metal objects.
- Do not recharge, disassemble, remodel, heat or throw into fire.
- Keep out of reach of children

If any electrolyte should come into contact with your hands or clothes, wash it off thoroughly with water. If any electrolyte should come into contact with your eyes, never rub the eyes. Rinse eyes thoroughly with water, and then consult a doctor.

Warning

Risk of fire, explosion and burns. Do not disassemble, heat above **60 °C (140 °F)** or incinerate.

The unit should be installed near an accessible AC power outlet, with the power cord connected directly to it.

To completely disconnect power from the unit, unplug the power cord from the AC power outlet.

<For USA-California only>

This product contains a CR Coin Cell Lithium Battery which contains Perchlorate Material — special handling may apply.

See www.dtsc.ca.gov/hazardouswaste/perchlorate.



CAUTION: TO REDUCE THE RISK OF ELECTRIC SHOCK, DO NOT REMOVE SCREWS. NO USER-SERVICEABLE PARTS INSIDE. REFER SERVICING TO QUALIFIED SERVICE PERSONNEL.



The lightning flash with arrowhead symbol, within an equilateral triangle, is intended to alert the user to the presence of uninsulated "dangerous voltage" within the product's enclosure that may be of sufficient magnitude to constitute a risk of electric shock to persons.



The exclamation point within an equilateral triangle is intended to alert the user to the presence of important operating and maintenance (servicing) instructions in the literature accompanying the appliance.

IMPORTANT SAFETY INSTRUCTIONS

Read these operating instructions carefully before using the unit. Follow the safety instructions on the unit and the applicable safety instructions listed below. Keep these operating instructions handy for future reference.

- 1 Read these instructions.
- 2 Keep these instructions.
- 3 Heed all warnings.
- 4 Follow all instructions.
- 5 Do not use this apparatus near water.
- 6 Clean only with dry cloth.
- 7 Do not block any ventilation openings. Install in accordance with the manufacturer's instructions.
- 8 Do not install near any heat sources such as radiators, heat registers, stoves, or other apparatus (including amplifiers) that produce heat.
- 9 Do not defeat the safety purpose of the polarized or grounding-type plug. A polarized plug has two blades with one wider than the other.

A grounding-type plug has two blades and a third grounding prong. The wide blade or the third prong are provided for your safety. If the provided plug does not fit into your outlet, consult an electrician for replacement of the obsolete outlet.

- 10 Protect the power cord from being walked on or pinched particularly at plugs, convenience receptacles, and the point where they exit from the apparatus.
- 11 Only use attachments/accessories specified by the manufacturer.
- 12 Use only with the cart, stand, tripod, bracket, or table specified by the manufacturer, or sold with the apparatus. When a cart is used, use caution when moving the cart/apparatus combination to avoid injury from tip-over.
- 13 Unplug this apparatus during lightning storms or when unused for long periods of time.
- 14 Refer all servicing to qualified service personnel. Servicing is required when the apparatus has been damaged in any way, such as power-supply cord or plug is damaged, liquid has been spilled or objects have fallen into the apparatus, the apparatus has been exposed to rain or moisture, does not operate normally, or has been dropped.



The model number and serial number of this product can be found on either the back or the bottom of the unit.

Please note them in the space provided below and keep for future reference.

MODEL NUMBER SC-HTB10

SERIAL NUMBER _____

User memo:

DATE OF PURCHASE _____

DEALER NAME _____

DEALER ADDRESS _____

TELEPHONE NUMBER _____

Licenses

Manufactured under license from Dolby Laboratories. Dolby, Pro Logic, and the double-D symbol are trademarks of Dolby Laboratories.

Manufactured under license under U.S. Patent #'s: 5,451,942; 5,956,674; 5,974,380; 5,978,762; 6,487,535 & other U.S. and worldwide patents issued & pending. DTS and the Symbol are registered trademarks & DTS Digital Surround and the DTS logos are trademarks of DTS, Inc. Product includes software.
© DTS, Inc. All Rights Reserved.

HDMI, the HDMI Logo, and High-Definition Multimedia Interface are trademarks or registered trademarks of HDMI Licensing LLC in the United States and other countries.

HDAVI Control™ is a trademark of Panasonic Corporation.

VIERA Link™ is a trademark of Panasonic Corporation.

EZ Sync™ is a trademark of Panasonic Corporation.

Table of Contents

Operating Instructions

IMPORTANT SAFETY INSTRUCTIONS	3
Licenses	3
Accessories	5
Unit care	5
Control reference guide	6
Main unit (Front)	6
Main unit (Rear)	6
Remote control	7
Placement	8
Assembling the unit	9
Connections	10
Connection to a TV	10
Connection from an HDMI compatible device	11
AC power supply cord connection	11
Using this unit	12
Audio effects	13
The various audio effects	13
Changing the audio effects	13
Linked operations with the TV (VIERA Link™ "HDMI Control™")	14
Specifications	15
Audio information	15
Troubleshooting	16
Remote control code	17
Limited Warranty (ONLY FOR U.S.A. AND PUERTO RICO)	18
Product Service	19
Limited Warranty (ONLY FOR CANADA)	20



Installation Instructions

Safety Precautions	21
Components	23
Installation procedure	23
Attaching the wall mount brackets	23
Connections	24
Placement	24
Attaching this unit to a wall	25

- Operations in these instructions are described mainly with the remote control, but you can perform the operations on the main unit if the controls are the same.
- Some accessories and external devices mentioned in these operating instructions that are not supplied with this product may not be for sale in certain regions.

Accessories

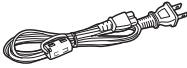
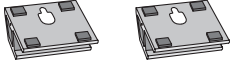
Check the supplied accessories before using this unit.

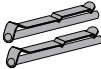
<input type="checkbox"/> 1 Remote control (Built-in battery) (N2QAYC000027) 	<input type="checkbox"/> 1 AC power supply cord (RFAX1027) 	<input type="checkbox"/> 2 Wall mount brackets (RYQX1034-K) 
<input type="checkbox"/> 2 Screws (RYQX1042-1) 	<input type="checkbox"/> 2 Lock pins (RYQX1048) 	

(ONLY FOR CANADA)

The enclosed Canadian French label sheet corresponds to the English display on the remote control and the front and rear of the unit.



- Product numbers correct as of April 2010. These may be subject to change.
- Only for U.S.A. and Puerto Rico:
To order accessories, refer to "Accessory Purchases (United States and Puerto Rico)" on page 19.
For Canada: To order accessories, call the dealer from whom you made your purchase.

Unit care

■ Clean this unit with a soft, dry cloth

- Never use alcohol, paint thinner or benzine to clean this unit.
- Before using chemically treated cloth, carefully read the instructions that came with the cloth.

■ To dispose or transfer this unit

If you discard this unit either by disposal or transfer, then follow the procedure to return all the settings to the factory presets to delete the user settings. (⇒ 16, "To return to the factory preset.")

Control reference guide

Main unit (Front)

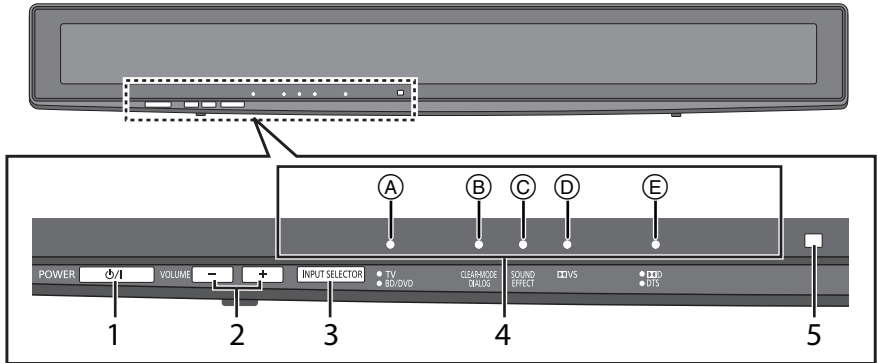

- 1 **Standby/on switch (POWER ϕ /I)**
Press to switch the unit from on to standby mode or vice versa. In standby mode, the unit is still consuming a small amount of power.
- 2 Adjust the Volume of this unit
- 3 Select the source
"TV" \leftrightarrow "BD/DVD"
- 4 LED status indicators (\Rightarrow 12, 13)
 - (A) Audio source indicator
 - (B) Clear-mode Dialog indicator

- (C) Sound Effect indicator
- (D) Dolby Virtual Speaker indicator
- (E) Audio format indicator

5 Remote control signal sensor

Remote control operation range

Distance:

Within approx. 7 m (23 ft.)

Angle:

Approx. 10° up and 30° down, 30° left and right

Main unit (Rear)

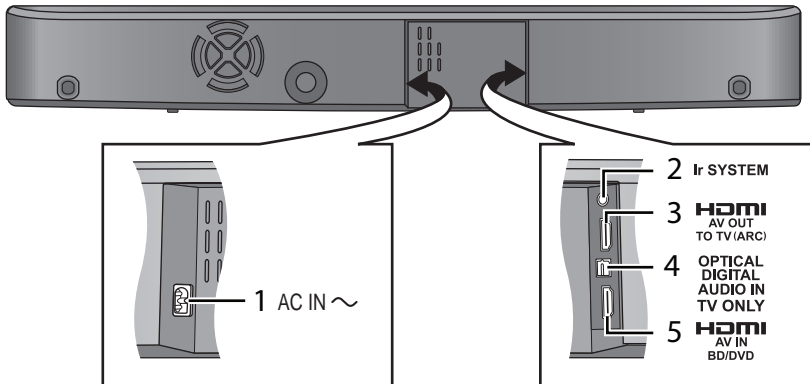

- 1 AC IN terminal (\Rightarrow 11)
- 2 Ir SYSTEM terminal
(Only for use with the optional IR Blaster. (\Rightarrow 8))
- 3 HDMI AV OUT terminal (\Rightarrow 10)

- 4 OPTICAL DIGITAL AUDIO IN terminal (\Rightarrow 10)
- 5 HDMI AV IN terminal (\Rightarrow 11)

Remote control

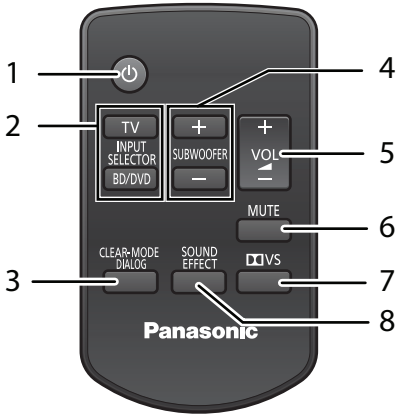

- 1 Turn this unit on or off (⇒ 12)
- 2 Select the source (⇒ 12)
[TV]:
Select the TV as the source
[BD/DVD]:
Select the device connected to the HDMI AV IN terminal as the source
- 3 Turn Clear-mode Dialog on or off (⇒ 13)
- 4 Adjust the Subwoofer level of this unit
- 5 Adjust the Volume of this unit
- 6 Mute the sound
- 7 Turn Dolby Virtual Speaker on or off (⇒ 13)
- 8 Turn Sound Effect on or off (⇒ 13)

CAUTION

Danger of explosion if battery is incorrectly replaced. Replace only with the same or equivalent type recommended by the manufacturer. Dispose of used batteries according to the manufacturer's instructions.

Remove the insulation sheet **A** before using.

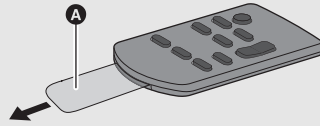

To replace a button-type battery

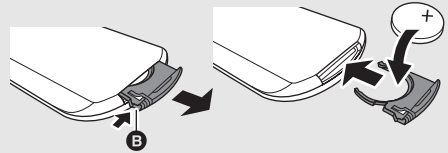

- ① While pressing the stopper **B**, pull out the battery holder.
 - ② Set the button-type battery with its (+) mark facing upward and then put the battery holder back in place.
- When the button-type battery runs down, replace it with a new battery (part number: CR2025). The battery should normally last about 1 year, however this depends on how frequently the unit is used.
 - Keep the button-type battery out of reach of children to prevent swallowing.
 - Do not heat or expose to flame.
 - Do not leave the battery(ies) in an automobile exposed to direct sunlight for a long period of time with doors and windows closed.

Replace battery with Panasonic part No. CR2025 only. Use of another battery may present a risk of fire or explosion. Caution: Battery may explode if mistreated. Dispose of used battery promptly. Keep away from children. Do not recharge, disassemble or dispose of in fire.

Placement

Caution



- This unit and the supplied wall mount brackets are to be used only as indicated in these operating instructions or the installation instructions. Failure to do so may lead to damage to the amplifier and/or the speakers, and may result in the risk of fire. Consult a qualified service person if damage has occurred or if you experience a sudden change in performance.
- Do not attempt to attach this unit to a wall using methods other than those described in this manual.

How you place this unit can affect the bass and the sound field.

Place this unit near the TV.

This unit should be placed parallel to the seating position.

E.g.,



On the wall

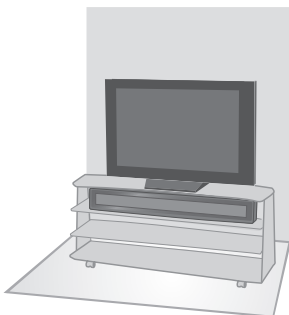

In a rack^{*1, 2, 3}

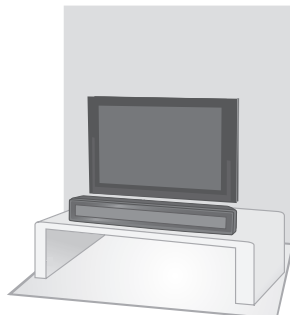

On a table^{*1, 2, 3, 4, 5}

**To attach this unit to the wall, refer to the installation instructions. (⇒ 21)
Installation work should never be done by any other than a qualified installation specialist.**

- ※1 Place this unit on a flat secure base. (Do not place this unit on the TV's pedestal.)
- ※2 To allow for proper ventilation and to allow for proper air flow around this unit, position it with at least 5 mm ($\frac{3}{16}$ ") of space on all sides of this unit.
- ※3 Secure the unit to prevent it from falling. (⇒ 9)
- ※4 **Do not place this unit in front of a 3D compatible TV. This unit may block the transmitter for the 3D eyewear.**
- ※5 Do not place this unit too close to the TV. This unit may interfere with the TV's various sensors (ambient light, etc.).



- You can damage the speakers and shorten their useful life if you play sound at high levels over extended periods.
- Placing this unit too close to the floor, walls, and corners can result in excessive bass. Cover walls and windows with thick curtains.

■ If the TV's remote control sensor is blocked by this unit.

Try using the TV's remote control from a different angle. If the problem persists, you can use the optional Panasonic IR Blaster (SH-WR10) to relay the signal to the TV.

- The optional Panasonic IR Blaster (SH-WR10) is only compatible with Panasonic TVs. Purchase SH-WR10 (Accessory IR Blaster) at selected dealers or online by visiting our Web Site at: <http://www.panasonic.com> or in Canada: <http://www.panasonic.ca>

For details, please refer to the operating instructions for the optional Panasonic IR Blaster.

- Do not use the IR Blaster if the TV's remote control sensor is not blocked by this unit.

■ If irregular coloring occurs on your TV, turn the TV off for about 30 minutes.

If it persists, move this unit further away from the TV.

Assembling the unit

Refer to the following when placing this unit on a table or in a rack. For wall mount, refer to the installation instructions. (⇒ 21)

Professional installation is required.

The installation should never be done by any other than a qualified installation specialist.

Preparation

- To prevent damage or scratches, lay down a soft cloth and perform the assembly on it.
- Keep the screws out of reach of children to prevent swallowing.



- Do not hold this unit in one hand to avoid injury by dropping this unit when carrying.

To prevent the unit from falling

- 1** On the rear of the unit:
Place the wall mount bracket by aligning the holes in the wall mount bracket with the projecting parts **A.**

- 2** **Screw the wall mount bracket firmly into place.**

- Screw tightening torque: 80 N•cm (17.98 lbf-ft) to 120 N•cm (26.98 lbf-ft).
- Repeat the steps above when installing the second wall mount bracket.

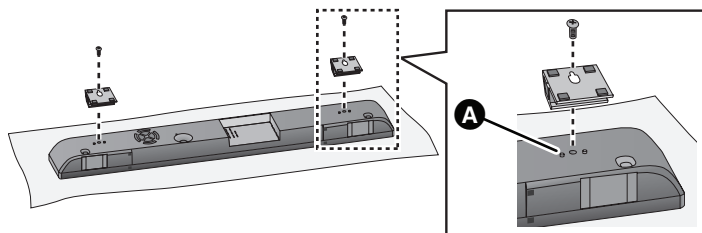

- 3** **Thread a cord (not supplied) through each wall mount bracket.**

- Make sure to use a cord which is capable of supporting over 20 kg (44.1 lbs).

A Rear of this unit

B Fall prevention cord (not supplied)

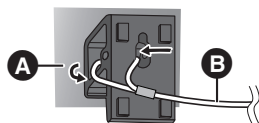

- 4** After all the necessary connections are finished (⇒ 10)

Place the unit in the desired position and attach each cord onto the rack or table.

- Attach each cord to a different screw eye.
- Make sure that there is no more than a 3 cm (1³/₁₆") slack.

A This unit

B Fall prevention cord (not supplied)

C Rack or table

D Screw eye (not supplied)

- Attach at a position capable of supporting over 20 kg (44.1 lbs).

e.g.

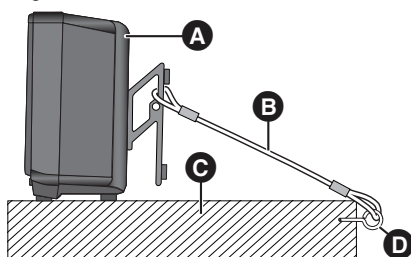

Connections

Turn off all equipment before connection and read the appropriate operating instructions.

Do not connect the AC power supply cord until all other connections are complete.



Compatible with FULL HD 3D TV and Blu-ray Player

- This unit can pass through the 3D signal from a 3D compatible Blu-ray Player to a FULL HD 3D TV.

Connection to a TV

■ HDMI

The HDMI connection supports VIERA Link "HDAVI Control" (⇒ 14) when used with a compatible Panasonic TV.

- Use High Speed HDMI Cables that have the HDMI logo (as shown on the cover). It is recommended that you use Panasonic's HDMI cable.
Recommended part number:
RP-CDHS15 (1.5 m/4.9 ft), RP-CDHS30 (3.0 m/ 9.8 ft), RP-CDHS50 (5.0 m/16.4 ft), etc.
- Non-HDMI-compliant cables cannot be utilized.

■ OPTICAL IN

Connect the optical digital audio cable if the TV is not ARC compatible (⇒ below).

Basic connection (with an ARC compatible TV)

ARC (Audio Return Channel)

(Available only when using an ARC compatible TV)

With this function it is possible to receive the digital audio signal from the TV without connecting any other audio cable.

- Refer to the operating instructions of the TV for the settings to output digital audio.

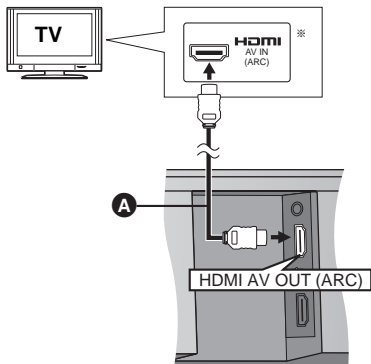

A HDMI cable (not supplied)

※ Be sure to connect to the TV's ARC compatible terminal. (Refer to the operating instructions for the TV.)



- If the connected TV is ARC compatible, but audio is not output to this unit, connect using the optical digital audio cable. (⇒ right, "Basic connection (with an optical digital audio cable compatible TV)")

Basic connection (with an optical digital audio cable compatible TV)

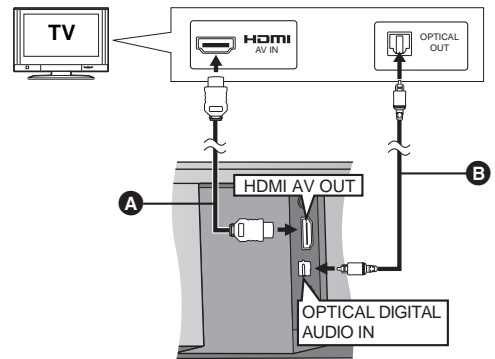

A HDMI cable (not supplied)

B Optical digital audio cable (not supplied)

- When connected to an ARC compatible TV, set "TV Audio" to "ARC Off" to output the audio signal from the optical digital audio cable. (⇒ 17, "TV Audio")



Connection from an HDMI compatible device

You can output the audio signal from the connected HDMI compatible Blu-ray player, DVD player, etc. with this unit and pass the signal through to your TV.

Preparation

- Connect this unit to the TV. (⇒ 10)

E.g., Blu-ray Disc Player

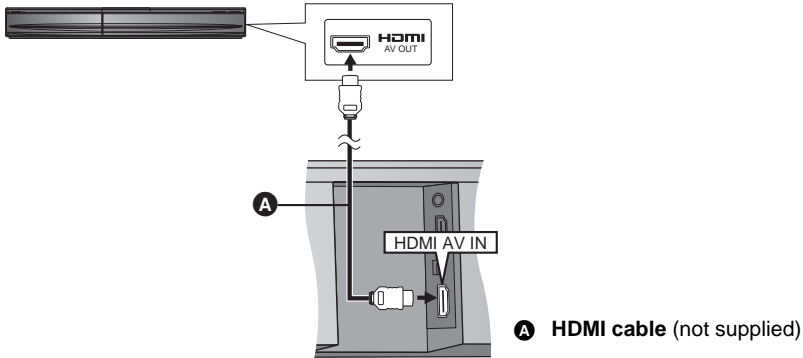

- Refer to the operating instructions of the connected HDMI compatible device for the necessary setting, to output the video and audio signals.

AC power supply cord connection

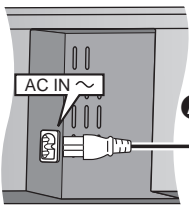

Saving energy

This unit is designed to conserve its power consumption and save energy.

- This unit will automatically turn to standby mode after 30 min if it is inactive.

- A** AC power supply cord (supplied)
- B** To a household AC outlet

- **Connect only after all other connections are complete.**

This unit consumes a small amount of AC power, even when it is in standby mode (approx. 0.1 W). In the interest of power conservation, if you will not be using this unit for a long time, unplug it from the household AC outlet.

- The supplied AC power supply cord is for use with the main unit only.

Do not use it with other equipment. Also, do not use cords for other equipment with the main unit.

Using this unit

Preparation

- Turn on the TV.
- If VIERA Link is activated on both the connected TV and this unit, make sure to change the TV's settings for this unit. (⇒ 14, "Linked operations with the TV (VIERA Link™ "HDAVI Control™")")
- If VIERA Link is not activated or if the TV is not compatible with VIERA Link, reduce the volume of the TV to its minimum.

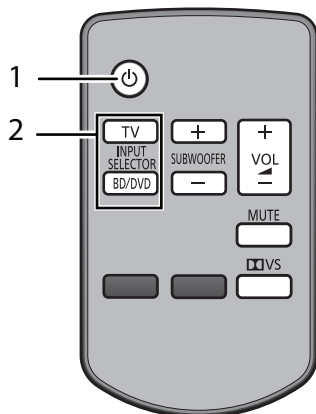

1 Press [⏻] to turn on this unit.

- The current status (audio source, active audio effects and audio format) is displayed. The audio effects and audio format indicator will turn off after 4 sec.

2 Press [TV] or [BD/DVD] to select the audio source. (⇒ right)

- If you have selected [BD/DVD], make sure to select the TV's input channel for this unit and start the playback.



- Before turning off this unit, be sure to reduce the volume.
- Even if this unit is turned off, the device connected to the HDMI AV IN terminal will continue to output audio or video to the TV.

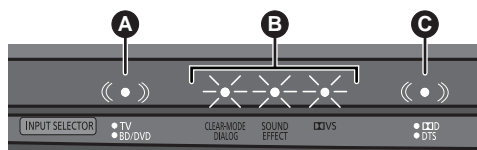

Audio source indicator

- A** The selected audio source is indicated

Green:

When the TV is the audio source

Red:

When the device connected to the HDMI AV IN terminal is the audio source

To adjust the volume/ subwoofer level

Press [+ VOL -] to adjust the volume of the speakers.

Press [+ SUBWOOFER -] to adjust the subwoofer level.

- B** The indicators blink from left to right (+) or from right to left (-).
- The indicators will not blink when it has reached the maximum or minimum.

To mute the sound

Press [MUTE].

- C** The indicators blink simultaneously while muting.
- To cancel, press the button again or adjust the volume.
 - Muting is canceled if this unit is turned off.

Audio format indicator

Press [DOLBY DIGITAL] to indicate the audio format.

- C** The current audio format is indicated for 4 sec.

Green: Dolby Digital

Red: DTS

Off: PCM or LPCM



- The audio format status is also indicated for 4 sec if the audio format on the selected source (TV, Blu-ray Disc/DVD Player, etc.) is changed.
- The Dolby Virtual Speaker (DOLBY DIGITAL) audio effect status is also indicated. (⇒ 13)

Audio effects

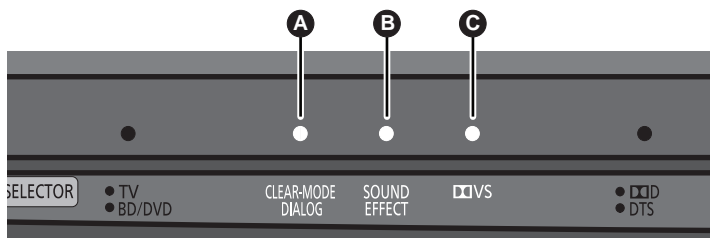
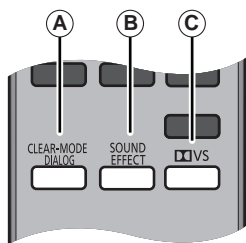

The various audio effects

Clear-mode Dialog

You can make the dialogue stand out from the background noise and also hear sound as if it is coming from the center of the TV.

Sound Effect

You can enjoy a dynamic sound with a natural expansion.

Dolby Virtual Speaker

You can enjoy a surround sound effect similar to 5.1 ch (Dolby Digital or DTS) with any audio source.

Changing the audio effects

1 Press the button for the respective effect on the remote control.

- Ⓐ: Clear-mode Dialog
- Ⓑ: Sound Effect
- Ⓒ: Dolby Virtual Speaker (Dolby VS)

2 The status of the selected effect is indicated for 4 sec.

- Ⓐ: Clear-mode Dialog
- Ⓑ: Sound Effect
- Ⓒ: Dolby Virtual Speaker (Dolby VS)

On:

The indicator lights

Off:

The indicator blinks

3 While the indicator is lit or blinking, press the same button again to change the setting.



- When turning the audio effects on or off, there might be a slight pause in the audio. This is normal.
- Dolby Virtual Speaker (Dolby VS) is also turned on when Sound Effect is turned on. (It will remain on even after Sound Effect is turned off.)
- If Dolby Virtual Speaker (Dolby VS) is turned off while Sound Effect is on, the Sound Effect will also be turned off.
- The audio format is also indicated when [Dolby VS] is pressed. (⇒ 12)

Linked operations with the TV

(VIERA Link™ “HDAVI Control™”)

What is VIERA Link “HDAVI Control”?

VIERA Link™ is a new name for EZ Sync™. VIERA Link “HDAVI Control” is a convenient function that offers linked operations of this unit, and a Panasonic TV (VIERA) under “HDAVI Control”.

You can use this function by connecting the equipment with an HDMI cable. See the operating instructions for connected equipment for operational details.

Preparation

- ① Set “VIERA Link” to “On”.
(The default setting is “On”.)
- ② Set the “HDAVI Control” operations on the connected equipment (e.g., TV).
- ③ For the optimal “HDAVI Control” operations change the following settings on the connected TV*1.
 - Set the default speaker settings to this unit.*2
 - Set the speaker selection settings to this unit.
 - Set the digital audio output settings to be compatible with this unit. (⇒ 15)
- ④ Turn on all “HDAVI Control” compatible equipment and select this unit’s input channel on the connected TV so that the “HDAVI Control” function works properly.
- ⑤ Start playback on the device connected to the HDMI AV IN terminal and check that the image is displayed correctly.

When the connection or settings are changed, repeat this procedure.

※1 The availability and function of the settings may vary depending on the TV. Refer to the operating instructions for the TV for details.

※2 If the TV has a default speaker setting within the VIERA Link setting items, choosing this unit as the default speaker will automatically change the speaker selection to this unit.



- VIERA Link “HDAVI Control”, based on the control functions provided by HDMI which is an industry standard known as HDMI CEC (Consumer Electronics Control), is a unique function that we have developed and added. As such, its operation with other manufacturers’ equipment that supports HDMI CEC cannot be guaranteed.
- This unit supports “HDAVI Control 5” function. “HDAVI Control 5” is the newest standard (current as of December, 2009) for Panasonic’s HDAVI Control compatible equipment. This standard is compatible with Panasonic’s conventional HDAVI equipment.
- Please refer to individual manuals for other manufacturers’ equipment supporting VIERA Link function.

Speaker Selection

You can select whether audio output is from this unit or the TV speakers by using the TV menu settings.

Home theater

This unit’s speakers are active.

- When this unit is in standby mode, changing the TV speakers to this unit in the TV menu will automatically turn this unit on and select “TV” as the source.
- You can control the volume setting using the Volume or Mute button on the TV remote control.
- If you turn off this unit, TV speakers will be automatically activated.

TV

TV speakers are active.

- The volume of this unit is set to its minimum.



- When switching between this unit’s speakers and TV speakers, the TV screen may be blank for several seconds.

Automatic input switching

When the following operations are performed, this unit will automatically turn on* and change the input channel to the corresponding source.

- When play starts on an HDMI connected device.
- When the input channel on the TV is changed.

※ Only when speaker output is set to this unit.



- If “Power off link” is activated on the TV, this unit will turn off when the TV is turned off.

Automatic lip-sync function

(for HDAVI Control 3 or later)

Delay between audio and video is automatically adjusted, enabling you to enjoy smooth audio for the picture.



- The delay information is automatically set if the TV is compatible to VIERA Link “HDAVI Control 3 or later” and the VIERA Link is set to “On”. When the delay information cannot be retrieved, the audio delay is set to 40 ms.

Specifications

GENERAL

Power consumption:	25 W
Power consumption in standby mode:	Approx. 0.1 W
Power supply:	AC 120 V, 60 Hz

Dimensions (W×H×D):

(Without wall mount bracket)
800 mm×108 mm×58 mm
(31¹/₂"×4¹/₄"×2⁹/₃₂"

(With wall mount bracket)
800 mm×108 mm×80 mm
(31¹/₂"×4¹/₄"×3⁵/₃₂"

Mass (Weight):

(Without wall mount bracket)
Approx. 3.2 kg (7.1 lbs)

(With wall mount bracket)
Approx. 3.3 kg (7.3 lbs)

Operating temperature range:

0 °C to +40 °C (+32 °F to +104 °F)

Operating humidity range:

20 % to 80 % RH (no condensation)

AMPLIFIER SECTION

RMS Output Power

Front ch:

30 W per channel (4 Ω), 1 kHz, 10 % THD

Subwoofer ch:

30 W per channel (4 Ω), 100 Hz, 10 % THD

Total RMS Dolby Digital mode power: 120 W

FTC Output Power

Front ch:

20 W per channel (4 Ω),
120 Hz to 20 kHz, 1 % THD

Subwoofer ch:

20 W per channel (4 Ω),
40 Hz to 120 Hz, 1 % THD

Total FTC Dolby Digital mode power: 80 W

SPEAKER SECTION

FRONT SPEAKERS (BUILT-IN)

Type: 1 way 1 speaker system (Bass Reflex)

Full range: 6.5 cm (2¹/₂") Cone type×2

SUBWOOFER (BUILT-IN)

Type: 1 way 1 speaker system (Bass Reflex)×2

Woofer: 8 cm (3¹/₈") Cone type×2

TERMINAL SECTION

HDMI

This unit supports "HDAVI Control 5" function.

HDMI input

Input connector: Type A (19 pin)

HDMI AV output

Output connector: Type A (19 pin)

Digital Audio Input (TV only)

Optical digital input: Optical terminal

Sampling frequency: 32 kHz, 44.1 kHz, 48 kHz

Audio Format: LPCM, Dolby Digital

IR Blaster

Terminal 1: 3.5 mm (1¹/₈") jack



1 Specifications are subject to change without notice.
Mass and dimensions are approximate.

2 Total harmonic distortion is measured by a digital spectrum analyzer.

Audio information

■ Compatible audio formats

This unit is compatible with the following formats:

Dolby Digital, DTS Digital Surround, 2-channel LPCM and multi-channel LPCM.

- When using the optical digital audio cable, this system is not able to play audio with a sampling frequency greater than 48 kHz.

(Sound Effect and Dolby Virtual Speaker will be automatically canceled if the audio signal's sampling frequency is greater than 48 kHz.)

Troubleshooting

Before requesting service, make the following checks. If you are in doubt about some of the check points, or if the solutions indicated in the following guide do not solve the problem, refer to “Customer Services Directory (United States and Puerto Rico)” on page 19 if you reside in the U.S.A. or Puerto Rico, or refer to “Product information” on page 19 if you reside in Canada.

General operation

To return to the factory preset.

- While this unit is on, press [POWER ⏻/I] on this unit for more than 4 sec.
(All the indicators will blink twice when the unit is reset.)

The remote control doesn't work properly.

- It is possible that the insulation sheet has not been removed. Remove the insulation sheet. (⇒ 7)
- The remote control and main unit are using different codes. Change the code on the remote control. (⇒ 17)
- It may be necessary to set the code of the remote control again after changing the battery of the remote control. (⇒ 17)

This unit does not operate correctly.

- If the HDMI cable is connected to the wrong terminal (HDMI AV IN or HDMI AV OUT), this unit will not operate correctly. Turn this unit off, disconnect the AC power supply cord and reconnect the HDMI cable(s). (⇒ 10)

When operating the connected device, this unit reacts in an unwanted manner.

- HDAVI Control commands may use a different signal depending on the make of the device. In this case, set “VIERA Link” to “Off”. (⇒ 17, “VIERA Link”)

VIERA Link related operations no longer function properly.

- Check the “VIERA Link” setting on the connected devices.
- When the HDMI connections are changed, after a power failure or after the AC power supply cord has been removed, VIERA Link operations may not function properly.

Power

No power.

- Insert the AC power supply cord securely. (⇒ 11)
- After turning this unit on, if the “TV, BD/DVD” indicator or the “D/DTS” indicator blinks and this unit immediately turns off, unplug the AC power supply cord and consult your dealer.

The unit is automatically switched to standby mode.

- This unit will automatically turn to standby mode after 30 min if it is inactive. (⇒ 11)

Power of this unit is turned off when the input for the TV is changed.

- This is a normal feature when using VIERA Link (HDAVI Control 4 or later). For details please read the operating instructions for the TV.

Sound

No sound (or image).

- Turn muting off. (⇒ 12)
- Check the connections to the other devices. (⇒ 10)
- Check the audio output settings on the connected device.
- Turn this unit off and then on again.
- When connected to an ARC compatible TV, check if the TV's connected terminal is ARC compatible.
- If the connections are correct, there might be a problem with the cables. Reconnect the unit with different cables.
- When using the optical digital audio cable, this system is not able to play audio with a sampling frequency greater than 48 kHz.

Sound is not heard when playing DVD-Audio

- This may occur due to digital copyright protection of the disc when using the optical digital audio cable. This system is not able to play audio with a sampling frequency greater than 48 kHz.

If the “**DD/DTS**” indicator is blinking, unplug the AC power supply cord and consult your dealer.

If the “**TV, BD/DVD**” indicator is blinking, try the following to correct the problem. Consult your dealer if the problem persists.

- Turn the connected device off and on again.
- Turn this unit off and reconnect the HDMI cables and then turn this unit on again.

If this unit is connected to a non-Panasonic ARC compatible TV, connect using an optical digital audio cable. (⇒ 10)

- After connecting the optical digital audio cable, the setting of this unit must be changed to specify the audio input terminal. (⇒ right, “TV Audio”)

Audio is output from the TV speakers and not this unit's.

- When connected to a VIERA Link (HDAVI Control) compatible TV, change the audio output settings to this unit. (⇒ 14)

Changing this unit's settings

Refer to “**Troubleshooting**” (⇒ 16) before changing any of the following settings.

The settings remain intact even if you switch the unit to standby mode.



A will blink green once when the setting is changed.

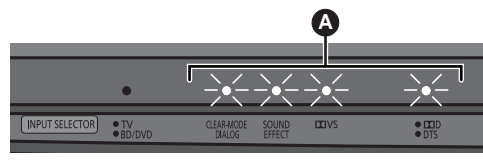

■ VIERA Link

Changes to this setting become effective after turning off and on all the connected devices.

Set “**VIERA Link**” to “**Off**”.

Set “VIERA Link” to “Off” when you do not want to use “HDAVI Control”. (⇒ 16, “General operation”)

Press and hold [INPUT SELECTOR] on this unit and [BD/DVD] on the remote control for more than 2 sec.

- When set to “Off”, the ARC function is not available. Be sure to connect using the optical digital audio cable. (⇒ 10)

Set “**VIERA Link**” to “**On**”.

Press and hold [INPUT SELECTOR] on this unit and [SOUND EFFECT] on the remote control for more than 2 sec.

■ TV Audio

Set “**TV Audio**” to “**ARC Off**”.

Set “TV Audio” to “ARC Off” only when using an optical digital audio cable with an ARC compatible TV. (⇒ 16, “Sound”)

Press and hold [INPUT SELECTOR] on this unit and [TV] on the remote control for more than 2 sec.

Set “**TV Audio**” to “**Auto**”.

Press and hold [INPUT SELECTOR] on this unit and [CLEAR-MODE DIALOG] on the remote control for more than 2 sec.

Remote control code

When other Panasonic products respond to this unit's remote control, change the remote control code on this unit and the remote control.

Preparation

- Turn off all other Panasonic products.
- Turn on this unit.

Change the remote control to code 2:

- ① Aim the remote control at this unit's remote control sensor.
- ② Press and hold [CLEAR-MODE DIALOG] and [BD/DVD] on the remote control for more than 4 sec.

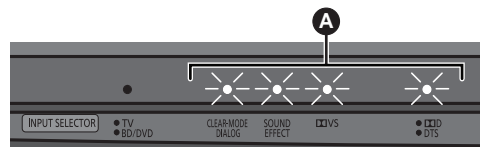

A will blink green once when the code of this unit is changed.



- If the unit does not operate after changing the code, repeat steps ① and ②.
- To change the remote control to code 1, repeat the steps above, but replace [BD/DVD] with [TV].

Limited Warranty (ONLY FOR U.S.A. AND PUERTO RICO)

Panasonic Consumer Electronics Company,
Division of Panasonic Corporation of North America
One Panasonic Way, Secaucus, New Jersey 07094

Panasonic Home Audio Products Limited Warranty

Limited Warranty Coverage (For USA and Puerto Rico Only)

If your product does not work properly because of a defect in materials or workmanship, Panasonic Consumer Electronics Company (referred to as "the warrantor") will, for the length of the period indicated on the chart below, which starts with the date of original purchase ("warranty period"), at its option either (a) repair your product with new or refurbished parts, (b) replace it with a new or a refurbished equivalent value product, or (c) refund your purchase price. The decision to repair, replace or refund will be made by the warrantor.

Product or Part Name	Parts	Labor
Audio Products (except items below)	1 year	1 year
DVD Home Theater System	1 year	1 year
Home Theater Audio System	1 year	1 year
USB Reader-writer, PC Card Adapters (defective exchange)	1 year	Not Applicable
Accessories: Headphones, cartridges, Microphones, Adapters	90 days	90 days
Rechargeable Batteries, DVD-RAM Disc (defective exchange)	10 days	Not Applicable
SD Memory Cards, Rechargeable Battery Packs (defective exchange)	90 days	Not Applicable

During the "Labor" warranty period there will be no charge for labor. During the "Parts" warranty period, there will be no charge for parts. This Limited Warranty excludes both parts and labor for non-rechargeable batteries, antennas, and cosmetic parts (cabinet). This warranty only applies to products purchased and serviced in the United States or Puerto Rico. This warranty is extended only to the original purchaser of a new product which was not sold "as is".

Carry-In or Mail-In Service

To find a service center please visit <http://www.panasonic.com/help> or call 1-800-211-PANA (7262).

When shipping the unit, carefully pack, include all accessories, and send it prepaid, adequately insured and preferably in the original carton. If Lithium Ion batteries are shipped by air the package must be labeled "Contains Lithium Ion Battery (No lithium metal)". Damaged batteries are prohibited from shipment by US Mail. Batteries must be securely packed in a manner to prevent short-circuiting and a package cannot contain more than 3 Lithium Ion batteries. Include a letter detailing the complaint, a return address and provide a daytime phone number where you can be reached. A valid registered receipt is required under the Limited Warranty.

IF REPAIR IS NEEDED DURING THE WARRANTY PERIOD, THE PURCHASER WILL BE REQUIRED TO FURNISH A SALES RECEIPT/PROOF OF PURCHASE INDICATING DATE OF PURCHASE, AMOUNT PAID AND PLACE OF PURCHASE. CUSTOMER WILL BE CHARGED FOR THE REPAIR OF ANY UNIT RECEIVED WITHOUT SUCH PROOF OF PURCHASE.

Limited Warranty Limits And Exclusions

This warranty ONLY COVERS failures due to defects in materials or workmanship, and DOES NOT COVER normal wear and tear or cosmetic damage. The warranty ALSO DOES NOT COVER damages which occurred in shipment, or failures which are caused by products not supplied by the warrantor, or failures which result from accidents, misuse, abuse, neglect, mishandling, misapplication, alteration, faulty installation, set-up adjustments, misadjustment of consumer controls, improper maintenance, power line surge, lightning damage, modification, introduction of sand, humidity or liquids, commercial use such as hotel, office, restaurant, or other business or rental use of the product, or service by anyone other than a Factory Service Center or other Authorized Servicer, or damage that is attributable to acts of God.

THERE ARE NO EXPRESS WARRANTIES EXCEPT AS LISTED UNDER "LIMITED WARRANTY COVERAGE". THE WARRANTOR IS NOT LIABLE FOR INCIDENTAL OR CONSEQUENTIAL DAMAGES RESULTING FROM THE USE OF THIS PRODUCT, OR ARISING OUT OF ANY BREACH OF THIS WARRANTY.

(As examples, this excludes damages for lost time, travel to and from the servicer, loss of or damage to media or images, data or other memory or recorded content. The items listed are not exclusive, but for illustration only.)

ALL EXPRESS AND IMPLIED WARRANTIES, INCLUDING THE WARRANTY OF MERCHANTABILITY, ARE LIMITED TO THE PERIOD OF THE LIMITED WARRANTY.

Some states do not allow the exclusion or limitation of incidental or consequential damages, or limitations on how long an implied warranty lasts, so the exclusions may not apply to you. This warranty gives you specific legal rights and you may also have other rights which vary from state to state. If a problem with this product develops during or after the warranty period, you may contact your dealer or Service Center. If the problem is not handled to your satisfaction, then write to the warrantor's Consumer Affairs Department at the addresses listed for the warrantor.

PARTS AND SERVICE, WHICH ARE NOT COVERED BY THIS LIMITED WARRANTY, ARE YOUR RESPONSIBILITY.

Customer Services Directory (United States and Puerto Rico)

Obtain Product Information and Operating Assistance; locate your nearest Dealer or Service Center; purchase Parts and Accessories; or make Customer Service and Literature requests by visiting our Web Site at:

<http://www.panasonic.com/help>

or, contact us via the web at:

<http://www.panasonic.com/contactinfo>

You may also contact us directly at:

1-800-211-PANA (7262)

Monday-Friday 9am-9pm,

Saturday-Sunday 10am-7pm EST

For hearing or speech impaired TTY users, TTY: 1-877-833-8855

Accessory Purchases (United States and Puerto Rico)

Purchase Parts, Accessories and Instruction Books online for all Panasonic Products by visiting our Web Site at:

<http://www.pstc.panasonic.com>

Or, send your request by E-mail to:

npcparts@us.panasonic.com

You may also contact us directly at:

1-800-332-5368 (Phone) 1-800-237-9080 (Fax Only)

(Monday-Friday 9am-9pm EST)

Panasonic Service and Technology Company

20421 84th Avenue South, Kent, WA 98032

(We accept Visa, MasterCard, Discover Card, American Express, and Personal Checks)

For hearing or speech impaired TTY users, TTY: 1-866-605-1277

As of November 2009

Product Service

1. Damage requiring service—The unit should be serviced by qualified service personnel if:

- The AC power supply cord or AC adaptor has been damaged; or
- Objects or liquids have gotten into the unit; or
- The unit has been exposed to rain; or
- The unit does not operate normally or exhibits a marked change in performance; or
- The unit has been dropped or the cabinet damaged.

2. Servicing—Do not attempt to service the unit beyond that described in these operating instructions. Refer all other servicing to authorized servicing personnel.

3. Replacement parts—When parts need replacing ensure the servicer uses parts specified by the manufacturer or parts that have the same characteristics as the original parts. Unauthorized substitutes may result in fire, electric shock, or other hazards.

4. Safety check—After repairs or service, ask the servicer to perform safety checks to confirm that the unit is in proper working condition.

The servicer will require all components to service your system.

Therefore, should service ever be necessary, be sure to bring the entire system.

Product information

For product information or assistance with product operation:

In the U.S.A. and Puerto Rico, refer to "Customer Services Directory (United States and Puerto Rico)" above.

In Canada, contact the Panasonic Canada Inc. Customer Care Centre at 1-800-561-5505, or visit the website (www.panasonic.ca), or an authorized Servicentre closest to you.

Limited Warranty (ONLY FOR CANADA)

Panasonic Canada Inc.

PANASONIC PRODUCT—LIMITED WARRANTY

Panasonic Canada Inc. warrants this product to be free from defects in material and workmanship and agrees to remedy any such defect for a period as stated below from the date of original purchase.

Technics Audio Product	One (1) year, parts and labour
Panasonic Portable/Clock Radio (without Tape, CD, MD)	One (1) year, parts and labour
Panasonic Audio/SD Audio Product	One (1) year, parts and labour
Panasonic BD/DVD Product	One (1) year, parts and labour
Panasonic Combination DVD Player/VCR	One (1) year, parts and labour
Panasonic Combination DVD Recorder/VCR	One (1) year, parts and labour
Accessories including rechargeable batteries	Ninety (90) days

LIMITATIONS AND EXCLUSIONS

This warranty does not apply to products purchased outside Canada or to any product which has been improperly installed, subjected to usage for which the product was not designed, misused or abused, damaged during shipping, or which has been altered or repaired in any way that affects the reliability or detracts from the performance, nor does it cover any product which is used commercially. Dry cell batteries are also excluded from coverage under this warranty.

This warranty is extended to the original end user purchaser only. A purchase receipt or other proof of date of original purchase is required before warranty service is performed.

THIS EXPRESS, LIMITED WARRANTY IS IN LIEU OF ALL OTHER WARRANTIES, EXPRESS OR IMPLIED, INCLUDING ANY IMPLIED WARRANTIES OF MERCHANTABILITY AND FITNESS FOR A PARTICULAR PURPOSE.

IN NO EVENT WILL PANASONIC CANADA INC. BE LIABLE FOR ANY SPECIAL, INDIRECT OR CONSEQUENTIAL DAMAGES.

In certain instances, some jurisdictions do not allow the exclusion or limitation of incidental or consequential damages, or the exclusion of implied warranties, so the above limitations and exclusions may not be applicable.

WARRANTY SERVICE

FOR PRODUCT OPERATION ASSISTANCE, please contact:

Our Customer Care Centre:	Telephone #:	(905) 624-5505
	1-800 #:	1-800-561-5505
	Fax #:	(905) 238-2360
	Email link:	"Customer support" on www.panasonic.ca

FOR PRODUCT REPAIRS, please locate your nearest Authorized Servicentre at www.panasonic.ca :

Link : "Servicentres™ locator" under "Customer support"

IF YOU SHIP THE PRODUCT TO A SERVICENTRE

Carefully pack and send prepaid, adequately insured and preferably in the original carton. Include details of the defect claimed, and proof of date of original purchase.

Installation Instructions

Home Theater Audio System

Model No. **SC-HTB10**

Safety Precautions

WARNING

Ensure that the installation location is strong enough to support long-term use.

- If its strength becomes insufficient over the course of long-term use, the unit may drop, possibly causing injury.

The installation work should never be done by any other than a qualified installation specialist.

- Incorrect installation may cause equipment to fall, and personal injury may result.

Include a safety factor when considering the strength of the proposed installation location (approx. 10 times the product weight).

- If strength is not sufficient the equipment may fall, and personal injury may result.

Do not install at a location that cannot bear the load.

- If the installation location lacks sufficient strength, the equipment may fall.

Do not modify the wall mount brackets.

- Otherwise the unit may fall and become damaged, and personal injury may result.

Install the unit by taking only the steps which are specified in these instructions: Do not install it in any other way.

- Otherwise the unit may drop and become damaged, and personal injury may result.

Do not install at a location other than a vertical wall.

- Otherwise the unit may drop and become damaged, and personal injury may result.

CAUTION

Do not install at any locations subject to humidity, dust, smoke, steam or heat or under an air conditioner where water may drip onto the unit.

- This may have an adverse effect on the unit and cause fire or electric shock.

Leave a clearance between the rear panel and the wall.

- The unit has air ventilation holes at the front and rear. Covering these may result in a fire.

Install the mounting screws and power cable in such a way that they will not make contact with metal objects or wiring inside the wall.

- Electric shocks may result from contact with any metal objects inside the wall.

For installation, use the special-purpose constituent parts.

- Otherwise, the unit may fall off the wall, and personal injury may result.

When removing this unit, remove the wall mounting screws as well.

- Otherwise the mounting screws may get caught and personal injury may result.

To operate this unit safely, install it at an appropriate height.

- Otherwise the unit may fall, and personal injury may result.

WARNING:**PROFESSIONAL INSTALLATION IS REQUIRED.****PANASONIC DISCLAIMS ANY PROPERTY DAMAGE AND/OR SERIOUS INJURY, INCLUDING DEATH RESULTING FROM IMPROPER INSTALLATION OR INCORRECT HANDLING.****Requests regarding handling:**

- ① Exercise care when selecting the location for the unit because it may discolor or deform due to light or heat if it is placed where it is exposed to direct sunlight, or near a heater.
- ② Clean the wall mount brackets by wiping them with a soft, dry cloth (such as cotton or flannel). If the wall mount brackets are very dirty, remove the dirt using a neutral detergent diluted in water, and then wipe them clean with a dry cloth.
Do not use benzene, thinner, or furniture wax as this may cause the coating to peel.
(For information on cleaning the unit, see the unit's instruction manual (⇒ 5). If using a chemically treated cloth, follow the instructions supplied with the cloth.)



Precautions for wall mount bracket installation

- The wall mount brackets are for use in attaching the unit to a vertical wall. Do not attach to any surface other than a vertical wall.
- To ensure correct unit performance and prevent trouble, do not install at any of the following locations:
 - Near sprinklers or fire/smoke detectors
 - Where there is a risk of exposure to vibration or impact
 - Near high-voltage wires or dynamic power supplies
 - Near sources of magnetism, heat, water vapour or soot
 - Locations exposed to air blown from heating equipment
 - Where droplets of condensation from an air conditioner or other unit may form.
- Attach using techniques suited to the structure and materials of the installation location.
- Spread a soft blanket or cloth over the floor so that the unit and floor will not be marked or scratched during the assembly and installation work.
- When screwing down the parts, ensure that the screws are neither insufficiently tightened nor over tightened.
- Take sufficient care to ensure safety around you when performing the assembly and installation work or while moving about during the course of the work.
- Do not install the unit underneath ceiling lamps (spotlights, halogen lamps, etc.). Otherwise, the cabinet may be bent or damaged by high heat.

Do not connect this unit to the household AC power supply socket while installing.**When screwing down the parts, ensure that the screws are not insufficiently tightened or over tightened.**

Components

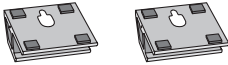
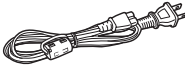
The images shown in this installation instructions are for illustrative purpose only.
Check the supplied components before starting.

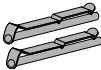
<input type="checkbox"/> 2 Wall mount brackets (RYQX1034-K) 	<input type="checkbox"/> 1 AC power supply cord (RFAX1027) 	<input type="checkbox"/> 2 Screws (RYQX1042-1) 
<input type="checkbox"/> 2 Lock pins (RYQX1048) 		

Commercially available components (not supplied)

- Screws for wall mounting
- Fall prevention cord
- Screws to attach fall prevention cord to wall



- Use commercially available screws with a nominal diameter of 4.0 mm ($5/32''$) that are suited to the wall material (wood, steel frame, concrete etc.) you are attaching the wall mount brackets to.
- Product numbers correct as of April 2010. These may be subject to change.

Installation procedure

Never use any other method than specified to install

Attaching the wall mount brackets

Preparation

- To prevent damage or scratches, lay down a soft cloth and perform the assembly on it.
- Keep the screws out of reach of children to prevent swallowing.



- Do not hold this unit in one hand to avoid injury by dropping this unit when carrying.

- 1** On the rear of the unit:
Place the wall mount bracket by aligning the holes in the wall mount bracket with the projecting parts **A.**
- 2** **Screw the wall mount bracket firmly into place.**

- Screw tightening torque: 80 N•cm (17.98 lbf-ft) to 120 N•cm (26.98 lbf-ft).
- Repeat the steps above when installing the second wall mount bracket.

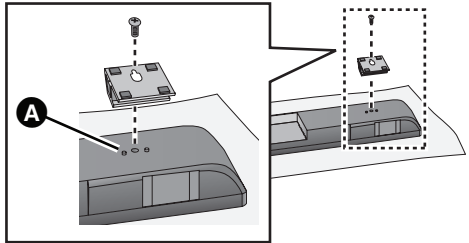

Connections

3 Complete all the necessary connections to this unit. (⇒ 10)

- Connect the AC power supply cord to this unit, but do not connect it to the household AC outlet until the installation is completed.



- For details, refer to the operating instructions for this unit.

Placement

4 Use the measurements indicated below to identify the screwing positions on the wall.

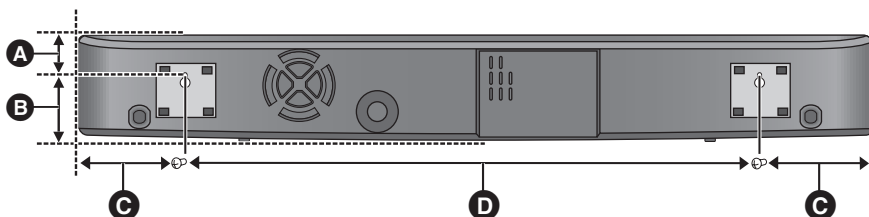

A 36 mm ($1\frac{13}{32}$ "')

B 72 mm ($2\frac{27}{32}$ "')

C 108.5 mm ($4\frac{9}{32}$ "')

D 583 mm ($22\frac{15}{16}$ "')



- Position the unit with at least 20 mm ($\frac{25}{32}$ "') of space above the unit and 100 mm ($3\frac{15}{16}$ "') on either side of the unit. If not, it will not be possible to attach the unit to the wall.
- Be sure that there is enough space above the unit and that the screw hole positions are level with each other before drilling into the wall.
- Be sure to use a spirit level to ensure that both screwing positions are horizontal to each other.

5 Checking the strength of the installation location.

- Check the wall strength at the 2 screwing positions. If the strength at any of these positions is lacking, provide sufficient reinforcement.
 - The position in the wall where the screw is to be attached should be capable of supporting over 20 kg (44.1 lbs).

Attaching this unit to a wall

6 Thread a cord (not supplied) through the wall mount bracket.

- Use a cord which is capable of supporting over 20 kg (44.1 lbs).

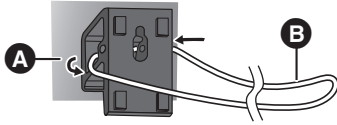

- A** Rear of this unit
- B** Fall prevention cord (not supplied)

7 Attach the lock pins into the wall mount bracket.

- The lock pins are designed to lock the wall mount brackets to the screws that this unit is attached to. Hence, preventing this unit from falling off the screws.
- Keep the lock pins out of reach of children to prevent swallowing.
- Insert the lock pins as illustrated in the image below.
- Make sure that the lock pin does not get caught on the fall prevention cord.

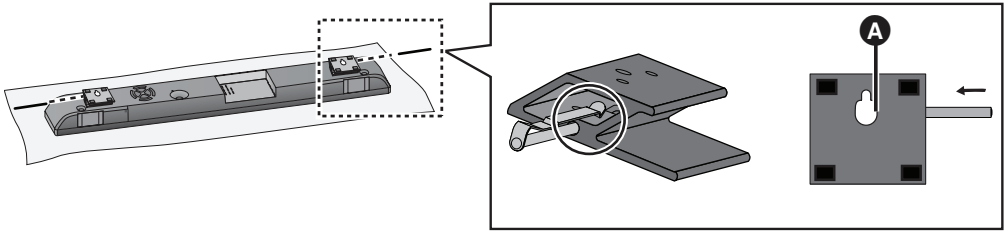

- A** Do not insert the lock pin farther than this point.

8 Drive 2 screws (not supplied) into the screwing positions identified in step 4.

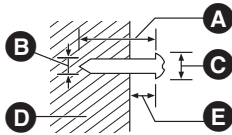

- A** At least 30 mm ($1\frac{3}{16}$ "
- B** $\varnothing 4.0$ mm ($\frac{5}{32}$ "
- C** $\varnothing 7.8$ mm to $\varnothing 9.4$ mm ($\frac{5}{16}$ " to $1\frac{3}{32}$ "
- D** Wall
- E** 5.0 mm to 6.0 mm ($\frac{3}{16}$ " to $\frac{1}{4}$ "

- Take care when fixing this unit to the wall. Always ensure that there are no electrical cables or pipes in the wall before hanging this unit.
- Keep the screws out of reach of children to prevent swallowing.



- Be sure to use commercially available screws with nominal diameter of $\varnothing 4.0$ mm ($\frac{5}{32}$ " suited to the wall surface material (wood, steel frame, concrete, etc.) and also capable of supporting over 20 kg (44.1 lbs) each for attaching this unit to the wall.
- The position in the wall where the screw is to be attached should be capable of supporting over 20 kg (44.1 lbs).
- Improper attachment may result in damage to the wall and this unit.

9 Mount the unit securely onto the screws.

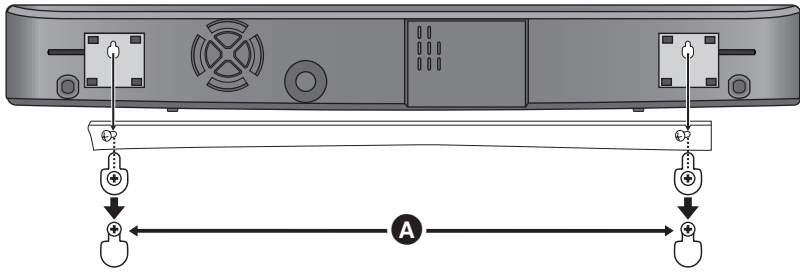

- A** Move this unit so that the screw is in this position.



- Be sure that both the wall mount brackets are securely attached to the screws.
- If this unit is tilting forward, remove this unit from the screws and adjust by tightening the screws.

10 Push the lock pins fully into place.

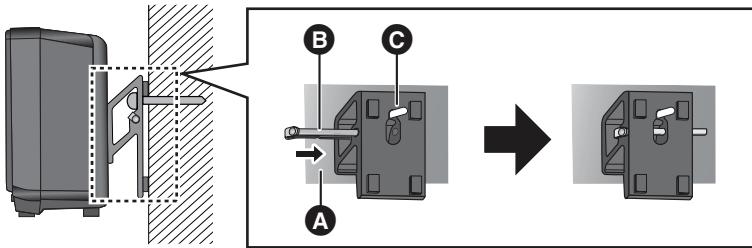

- A** Rear of this unit
B Lock pin (supplied)
C Screw (not supplied)



- Be sure to attach both lock pins correctly.

11 Attach the cord to a wall with a screw (not supplied).

- Keep the screws out of reach of children to prevent swallowing.
- Check the strength of the installation location. The position in the wall where the screw is to be attached should be capable of supporting over 20 kg (44.1 lbs). If the strength at any of these positions is lacking, provide sufficient reinforcement.

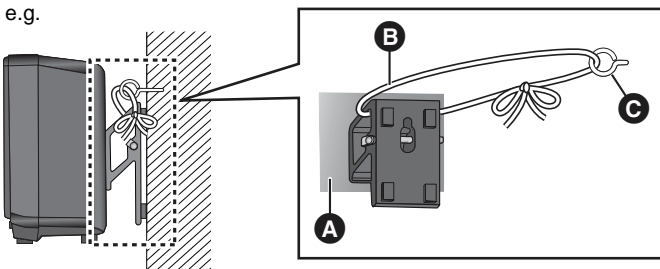

- A** Rear of this unit
B Fall prevention cord (not supplied)
C Screw eye (not supplied)

A series of 20 horizontal lines for writing, spaced evenly down the page.

A large empty rectangular box for additional notes or diagrams.

THE FOLLOWING APPLIES ONLY IN THE U.S.A.

FCC Note:

This equipment has been tested and found to comply with the limits for a Class B digital device, pursuant to Part 15 of the FCC Rules. These limits are designed to provide reasonable protection against harmful interference in a residential installation. This equipment generates, uses, and can radiate radio frequency energy and, if not installed and used in accordance with the instructions, may cause harmful interference to radio communications.

However, there is no guarantee that interference will not occur in a particular installation. If this equipment does cause harmful interference to radio or television reception, which can be determined by turning the equipment off and on, the user is encouraged to try to correct the interference by one or more of the following measures:

- Reorient or relocate the receiving antenna.
- Increase the separation between the equipment and receiver.
- Connect the equipment into an outlet on a circuit different from that to which the receiver is connected.
- Consult the dealer or an experienced radio/TV technician for help.

FCC Caution: To assure continued compliance, follow the attached installation instructions and use only shielded interface cables when connecting to peripheral devices. Any changes or modifications not expressly approved by the party responsible for compliance could void the user's authority to operate this equipment.

This device complies with Part 15 of the FCC Rules.

Operation is subject to the following two conditions:

- (1) This device may not cause harmful interference, and
- (2) this device must accept any interference received, including interference that may cause undesired operation.

Responsible Party:

Panasonic Corporation of North America
One Panasonic Way
Secaucus, NJ 07094

Support Contact:

Panasonic Consumer Electronics Company
Telephone No.: 1-800-211-PANA (7262)

-If you see this symbol-

Information on Disposal in other Countries outside the European Union



This symbol is only valid in the European Union.

If you wish to discard this product, please contact your local authorities or dealer and ask for the correct method of disposal.

Panasonic Consumer Electronics Company,
Division of Panasonic Corporation of North America

One Panasonic Way, Secaucus,
New Jersey 07094

<http://www.panasonic.com>

Panasonic Canada Inc.

5770 Ambler Drive,
Mississauga, Ontario
L4W 2T3

www.panasonic.ca

En

Free Manuals Download Website

<http://myh66.com>

<http://usermanuals.us>

<http://www.somanuals.com>

<http://www.4manuals.cc>

<http://www.manual-lib.com>

<http://www.404manual.com>

<http://www.luxmanual.com>

<http://aubethermostatmanual.com>

Golf course search by state

<http://golfingnear.com>

Email search by domain

<http://emailbydomain.com>

Auto manuals search

<http://auto.somanuals.com>

TV manuals search

<http://tv.somanuals.com>