

Panasonic

Integrated Telephone System

Operating Instructions

Model No. **KX-TS105B**
KX-TS105W

Pulse-or-tone dialing capability



KX-TS105W

PLEASE READ BEFORE USE AND SAVE.

Panasonic World Wide Web address: <http://www.panasonic.com>
for customers in the USA or Puerto Rico

Preparation

Basic Operation

Advanced Operation

Useful Information

Before Initial Use

Please read **IMPORTANT SAFETY INSTRUCTIONS** on page 27 before use.
Read and understand all instructions.

Thank you for purchasing your new Panasonic integrated telephone.

Attach your purchase receipt here.

For your future reference

Serial No. _____
(found on the bottom of the unit)

Date of purchase _____

Name and address of dealer _____

Accessories (included)

For extra orders, call 1-800-332-5368.

- Handset (p. 5)
Order No. PQJXC0301Z (Black)
PQJXC0102Z (White)

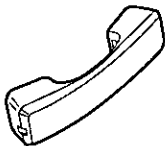

one

- Handset Cord (p. 5)
Order No. PQJA212V (Black)
PQJA212M (White)

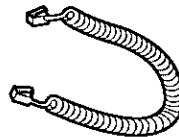

one

- Telephone Line Cord (p. 5)

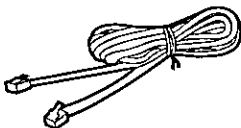

one

- Wall Mounting Adaptor (p. 9)
Order No. PQKL10038Y3 (Black)
PQKL10038Y1 (White)



one

Contents

Preparation

Location of Controls	4
Settings	5
Installing the Batteries	5
Connecting the Handset/Telephone Line Cord	5
Connecting a Communication Device	6
Programming Summary	7
Dialing Mode	8
Ringer Volume	8
Wall Mounting	9

Preparation

Basic Operation

Making Calls	10
Answering Calls	11

Basic Operation

Advanced Operation

Speed Dialer	12
Storing Phone Numbers	12
Dialing a Stored Number	13
One-Touch Dialer	14
Storing Phone Numbers	14
Dialing a Stored Number	16
Special Features	17
For Call Waiting Service Users	17
Temporary Tone Dialing (For Rotary or Pulse Service Users)	17
How to Use the PAUSE Button (For Analog PBX Line/Long Distance Service Users)	17
Muting Your Conversation	18
FLASH Button	18
PIN Code	19
Dial Lock	20
Call Restriction	21

Advanced Operation

Useful Information

Optional Headset	22
Battery Replacement	24
Troubleshooting	25
Important Safety Instructions	27
FCC and Other Information	29
Index	31

Useful Information

Settings



Installing the Batteries

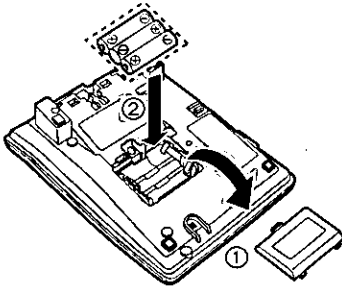

1. Press down in the direction of the arrow and remove the cover.
2. Install the batteries in the proper order as shown, matching the correct polarity.
3. Close the battery cover.

- Batteries are not included in the unit.
- Install three high quality "AA" Alkaline or Manganese batteries. We recommend to use Alkaline batteries.
Battery life is: —about six months in use of Alkaline batteries.
—about three months in use of Manganese batteries.
Battery life may depend on usage conditions and ambient temperature.
- Make sure to install the batteries for the following features to operate properly:
 - Buttons' function when the handset is on the cradle
 - Speakerphone (p. 10, 11)
 - Programming (p. 7)

Connecting the Handset/Telephone Line Cord

After connection, lift the handset to check for a dial tone.

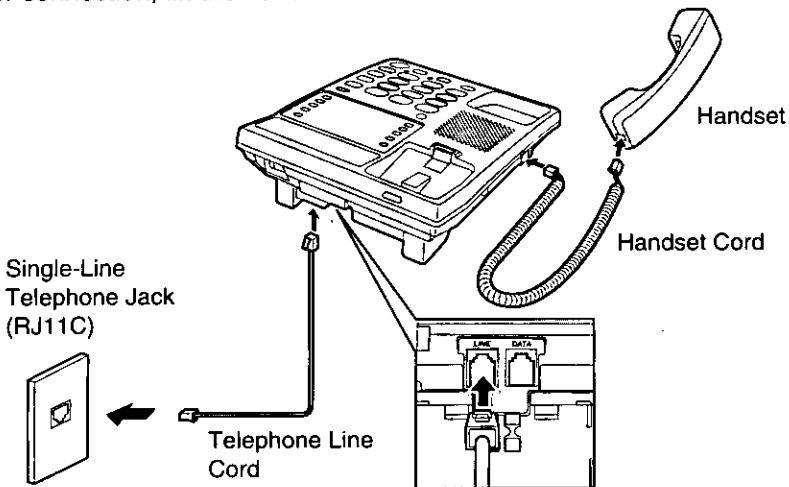

- Use only a Panasonic Handset for the KX-TS105B or KX-TS105W.

► Settings

Connecting a Communication Device

If you connect a communication device (computer, modem, fax, answering machine, etc.) to the telephone line, you can connect it through this unit using the DATA jack.

After connecting the handset and telephone line cord (p. 5), connect the communication device telephone line cord to the DATA jack.

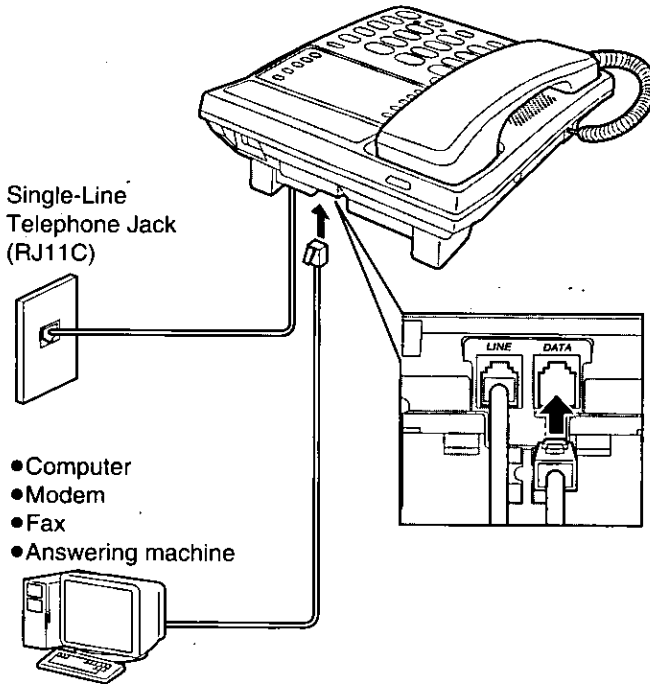

- Make sure the communication device is not in use before using this unit (making calls, storing phone numbers in memory etc.) or the communication device may not operate properly.

Programming Summary

You can program the following functions. See the corresponding pages for function details.

Make sure that a call is not put on hold.

Press **PROGRAM**.



Press **MUTE**.



- To set the call restriction, press **1**. (page 21)
- To change the flash time, press **2**. (page 18)
- To select the dialing mode, press **3**. (page 8)
- To change the PIN code for the dial lock and call restriction, press **5**. (page 19)



Press **PROGRAM** to store the setting.

- You can exit the programming mode any time by pressing **PROGRAM**.
- If you do not press any buttons for 60 seconds, the unit will return to the standby mode.

► Settings

Dialing Mode

You can select the dialing mode by programming. If you have touch tone service, set to "Tone". If rotary or pulse service is used, set to "Pulse". Your phone comes from the factory set to "Tone".

Make sure that a call is not put on hold.

- 1 Press **PROGRAM**.
 - The MUTE indicator flashes.
- 2 Press **MUTE**.
- 3 Press **3**.
- 4 To select "Pulse", press **2**.
or
To select "Tone", press **1**.
- 5 Press **PROGRAM**.
 - A long beep sounds.
 - The MUTE indicator light goes out.
 - The unit will return to the standby mode.

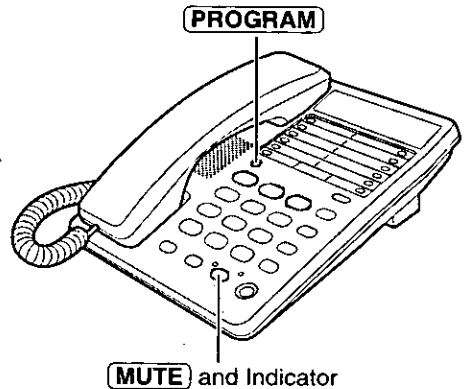

Ringer Volume

You can select the ringer volume to HIGH, LOW or OFF. Your phone comes from the factory set to HIGH.

RINGER Selector:

Set to HIGH, LOW or OFF.

- When set to OFF, the unit will not ring.

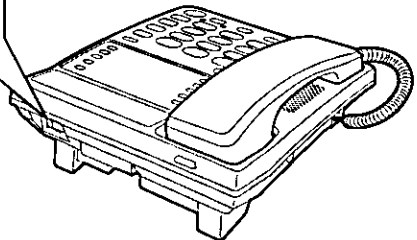
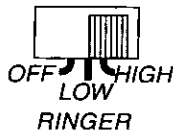

Wall Mounting

The unit can be mounted on a wall phone plate.

- 1 Pull down the handset hook until it locks, so the tab holds the handset.

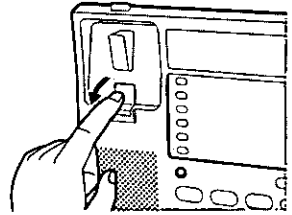

- 2 Tuck the telephone line cord inside the wall mounting adaptor, and push it in the direction of the arrow.
 - "UP" should be facing upward.

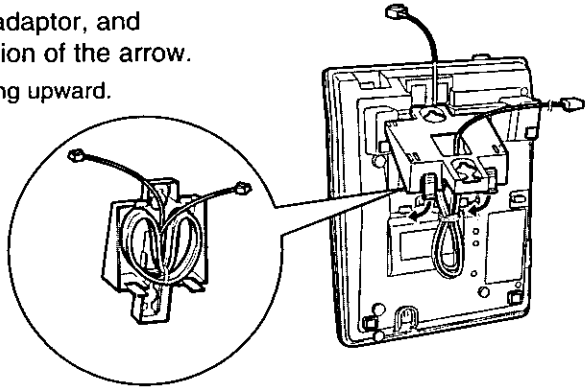

- 3 Connect the telephone line cord. Mount the unit, and slide down.

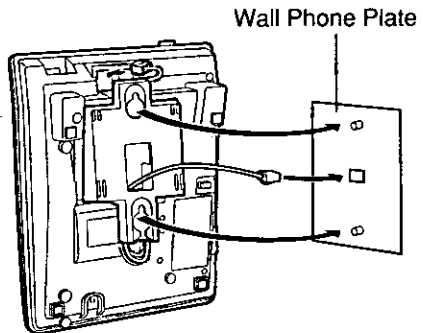
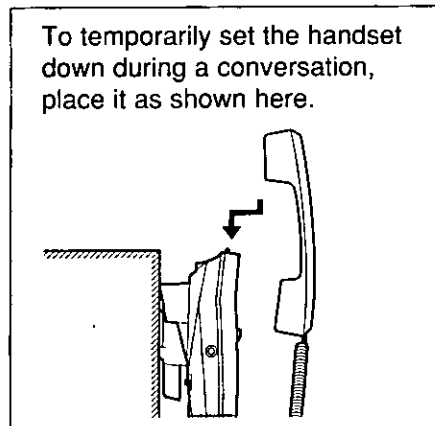

Making Calls

You can make a call by simply lifting the handset. To hang up, place the handset on the cradle.

Using the speakerphone

- 1 Press **SP-PHONE/HEADSET**.
 - The indicator lights.
- 2 Dial a phone number.
 - If you misdial, press **SP-PHONE/HEADSET** and start again from step 1.
- 3 When the other party answers, talk into the **MIC** (microphone).
- 4 To hang up, press **SP-PHONE/HEADSET**.
 - The indicator light goes out.

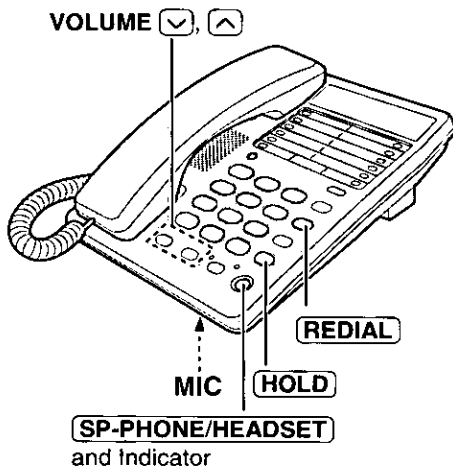

To redial the last number dialed

Using the handset: Lift the handset → press **REDIAL**.

Using the speakerphone: Press **SP-PHONE/HEADSET** → press **REDIAL**.

To adjust the handset volume (4 levels) or the speaker volume (8 levels) while talking

To increase, press **VOLUME** .

To decrease, press **VOLUME** .

During speakerphone operation

For best performance, please note the following:

- Talk alternately with the other party in a quiet room.
- If the other party has difficulty hearing you, press **VOLUME**  to decrease the speaker volume.
- You can switch to the handset by lifting it up. To switch back to the speakerphone, press **SP-PHONE/HEADSET**.

To put a call on hold

Press **HOLD**.

- The SP-PHONE/HEADSET indicator light flashes.
- If using the handset, you can place it on the cradle.

To release the hold

If the handset is on the cradle, lift the handset.

If the handset is off the cradle, press **HOLD**.

If using the speakerphone, press **SP-PHONE/HEADSET**.

- If another phone is connected on the same line, you can also release the hold by lifting its handset.

Answering Calls

While a call is being received, the unit rings and the ringer indicator flashes. You can answer it by simply lifting the handset.

Using the speakerphone

- 1 Press **SP-PHONE/HEADSET**.
 - The indicator lights.
- 2 Talk into the **MIC** (microphone).
- 3 To hang up, press **SP-PHONE/HEADSET**.
 - The indicator light goes out.

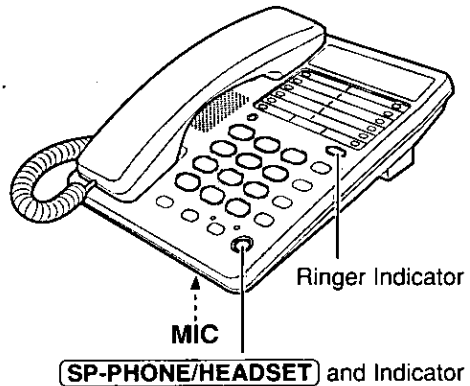

- When the ringer volume is set to OFF (p. 8), the unit will not ring.
- The Ringer indicator will flash when
 - a telephone number is dialed in PULSE mode, or
 - someone picks up or hangs up another phone connected to the same phone line.

This is normal.

Speed Dialer

Storing Phone Numbers

You can store up to 10 phone numbers in memory. The dialing buttons (0 to 9) function as memory stations. Do not press any memory stations before storing to prevent misoperation.

Make sure that a call is not put on hold.

- 1 Press **PROGRAM**.
 - The MUTE indicator flashes.
- 2 Enter a phone number, up to 22 digits.
 - If you enter a wrong number, press **PROGRAM** and start again from step 1.
- 3 Press **AUTO/LOWER**.
- 4 Press a memory station number (0 to 9).
 - A long beep sounds.
 - The MUTE indicator light goes out.
 - The unit will return to the standby mode.
 - If 3 beeps sound, the number entered in step 2 may be over 22 digits. Lift the handset and place it on the cradle to return to the standby mode, and start again from step 1.

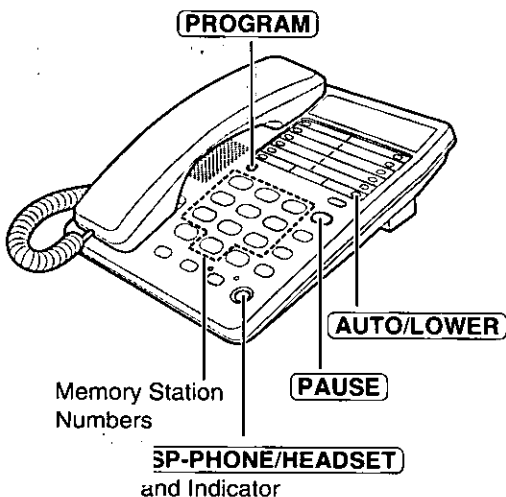

- You can exit the programming mode in step 1 and 2 by pressing **PROGRAM**.
- If a pause is required for dialing, press **PAUSE** where needed. Pressing **PAUSE** counts as one digit (p. 17).

To erase a stored number

- 1 Press **PROGRAM**.
 - The MUTE indicator flashes.
- 2 Press **AUTO/LOWER**.
- 3 Press a memory station number (**0** to **9**) for the phone number to be erased.
 - A long beep sounds.
 - The MUTE indicator light goes out.
 - The unit will return to the standby mode.

Dialing a Stored Number

- 1 Lift the handset or press **SP-PHONE/HEADSET**.
- 2 Press **AUTO/LOWER**.
- 3 Press the memory station number (**0** to **9**).
 - The stored number is dialed.

One-Touch Dialer

Storing Phone Numbers

You can store up to 20 phone numbers in the one-touch auto dial buttons (10 numbers in UPPER memory locations, 10 numbers in LOWER memory locations).

Do not press any one-touch auto dial buttons before storing to prevent misoperation.

To store in an UPPER memory location

It is recommended that you program an emergency number in the EMERGENCY button.

Make sure that a call is not put on hold.

- 1 Press **PROGRAM**.
 - The MUTE indicator flashes.
- 2 Enter a phone number, up to 22 digits.
 - If you enter a wrong number, press **PROGRAM** and start again from step 1.
- 3 Press one of the one-touch auto dial buttons.
 - A long beep sounds.
 - The MUTE indicator light goes out.
 - The unit will return to the standby mode.
 - If 3 beeps sound, the number entered in step 2 may be over 22 digits. Press **PROGRAM** to return to the standby mode and start again from step 1.

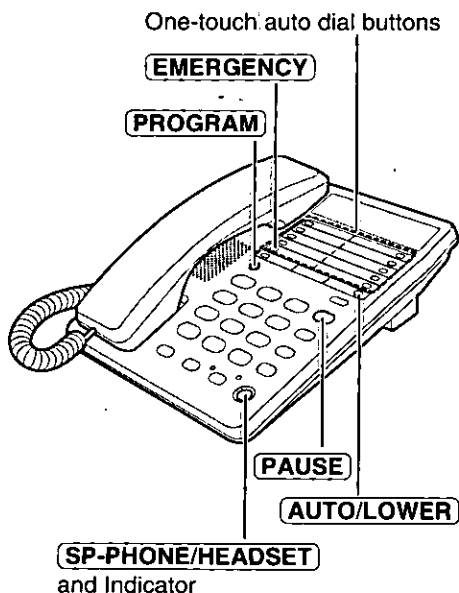

- If a pause is required for dialing, press **PAUSE** where needed. Pressing **PAUSE** counts as one digit (p. 17).
- When using the Dial Lock (p. 20) or Call Restriction feature (p. 21), you cannot store a phone number in the EMERGENCY button.



To store in a LOWER memory location

Make sure that a call is not put on hold.

- 1 Press **PROGRAM**.
 - The MUTE indicator flashes.
 - 2 Enter a phone number, up to 22 digits.
 - If you enter a wrong number, press **PROGRAM** and start again from step 1.
 - 3 Press **AUTO/LOWER**.
 - 4 Press one of the one-touch auto dial buttons.
 - A long beep sounds.
 - The MUTE indicator light goes out.
 - The unit will return to the standby mode.
 - If 3 beeps sound, the number entered in step 2 may be over 22 digits. Lift the handset and place it on the cradle to return to the standby mode, and start again from step 1.
- If a pause is required for dialing, press **PAUSE** where needed. Pressing **PAUSE** counts as one digit (p. 17).

To erase a stored number

- 1 Press **PROGRAM**.
 - The MUTE indicator flashes.
 - 2 If the phone number is in an UPPER memory location, press the one-touch auto dial button for the phone number to be erased.
OR
If the phone number is in a LOWER memory location, press **AUTO/LOWER**, then press the one-touch auto dial button for the phone number to be erased.
 - A long beep sounds.
 - The MUTE indicator light goes out.
 - The unit will return to the standby mode.
- When using the Dial Lock (p. 20) or Call Restriction feature (p. 21), you cannot erase a phone number in the EMERGENCY button.

► One-Touch Dialer

Dialing a Stored Number

From an **UPPER** memory location:

- 1 Lift the handset or press **SP-PHONE/HEADSET**.
- 2 Press the required one-touch auto dial button.
 - The stored number is dialed.

OR

From a **LOWER** memory location:

- 1 Lift the handset or press **SP-PHONE/HEADSET**.
- 2 Press **AUTO/LOWER**.
- 3 Press the required one-touch auto dial button.
 - The stored number is dialed.

Memory card

Remove the memory card and use it as a name or phone number index for the stored numbers.

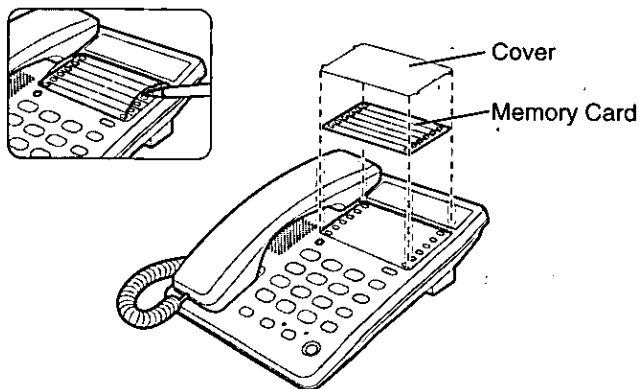

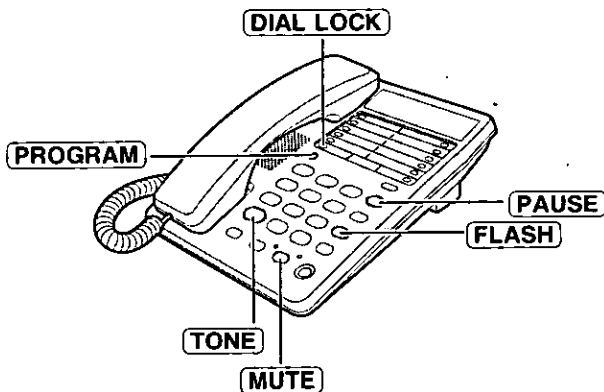

For Call Waiting Service Users

Press **FLASH** if you hear a call-waiting tone while talking.

- The first call is put on hold and you can answer the second call.
- To return to the first caller, press **FLASH** again.
- If this function does not operate properly, consult your telephone company.

Temporary Tone Dialing (For Rotary or Pulse Service Users)

Press **TONE** before entering access numbers which require tone dialing.

- The dialing mode changes to tone. You can enter numbers to access an answering service, electronic banking service, etc. When you hang up, the mode will return to pulse.

How to Use the PAUSE Button (For Analog PBX Line/Long Distance Service Users)

We recommend you press **PAUSE** if a pause is required for dialing with a PBX or to access a long distance service.

Ex. Line access number **9** (PBX)

9 → **PAUSE** → Phone number

- Pressing **PAUSE** once creates a few seconds pause. This prevents misdialing when you redial or dial a stored number.
- Pressing **PAUSE** more than once increases the length of the pause between numbers.

► Special Features

Muting Your Conversation

Press **MUTE** while talking.

- The MUTE indicator lights.
- The other party cannot hear you but you can hear them.
- To resume the conversation, press **MUTE** again.

FLASH Button

Pressing **FLASH** allows you to use special features of your host PBX such as transferring an extension call or accessing special telephone services (optional) such as call waiting.

Selecting the flash time

The flash time depends on your telephone exchange or host PBX. You can select the following flash times: "80, 90, 100, 110, 200, 250, 300, 400, 600, 700 ms (milliseconds)". Your phone comes from the factory set to "600 ms".

Make sure that a call is not put on hold.

- 1 Press **PROGRAM**.
- The MUTE indicator flashes.

- 2 Press **MUTE**.

- 3 Press **2**.

- 4 Press a dialing button (**1** to **0**).

1 : 80 ms	2 : 90 ms	3 : 100 ms	4 : 110 ms
5 : 200 ms	6 : 250 ms	7 : 300 ms	8 : 400 ms
9 : 600 ms	0 : 700 ms		

- 5 Press **PROGRAM**.

- A long beep sounds.
- The MUTE indicator light goes out.
- The unit will return to the standby mode.

- If you are connected via a PBX, a longer flash time may be necessary to use PBX functions (transferring a call, etc.). Consult your PBX installer for the correct setting.

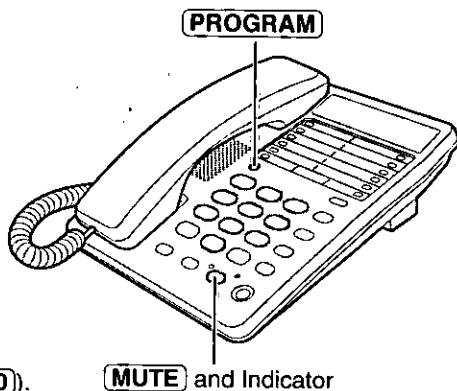



PIN Code

A 4-digit PIN Code (Personal Identification Number) prevents unauthorized persons from using your unit. The PIN Code is required for the dial lock and call restriction to be set or canceled. The factory preset PIN code is "1111".

Make sure that a call is not put on hold.

- 1 Press **PROGRAM**.
 - The MUTE indicator flashes.
- 2 Press **MUTE**.
- 3 Press **5**.
- 4 Enter the current PIN code.
- 5 Press **PROGRAM**.
 - If a correct PIN code is entered, a beep will sound.
 - If a wrong PIN code is entered, 3 beeps will sound. Enter the correct PIN code and press **PROGRAM**.
 - To return to the standby mode, lift the handset and hang up.
- 6 Enter a new PIN code using a 4-digit number.
- 7 Press **PROGRAM**.
 - A long beep sounds.
 - The MUTE indicator light goes out.
 - The unit will return to the standby mode.

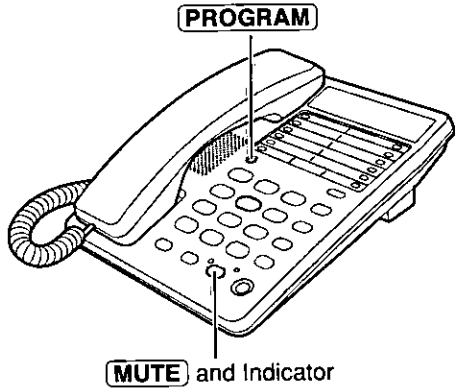

Please write down your PIN code. If you forget your PIN code, call our customer call center at 1-800-211-PANA(7262).

► Special Features

Dial Lock

You can prevent others from making a call to any number except the one pre-programmed in the memory of the EMERGENCY button. Once you locked the dialing buttons, even emergency numbers cannot be dialed. Only incoming calls are accepted until the dial lock is canceled.

Before using this feature, we recommend storing an emergency number in the memory of the EMERGENCY button (p. 14). Even if the dialing buttons are locked, the number stored in the button can be dialed.

- If you choose not to program emergency numbers, but plan to use the dial lock, any number programmed into the EMERGENCY button can be accessed.

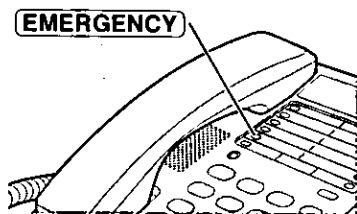

To set the dial lock

- 1 Press **DIAL LOCK**.
 - The MUTE indicator flashes.
- 2 Enter the PIN code (p. 19).
- 3 Press **PROGRAM**.
 - A long beep sounds.
 - If a wrong PIN code is entered, 3 beeps will sound. Enter a correct PIN code and press **PROGRAM**.
 - The MUTE indicator light goes out.
 - The unit will return to the standby mode.

You can use the following features while the dialing buttons are locked.

- Dialing a number you programmed into the memory of the EMERGENCY button (p. 16)
- Adjusting the handset and speakerphone volumes (p. 10)
- Muting the conversation (p. 18)
- Answering the second call by pressing **FLASH** (p. 17)

To cancel the dial lock

Follow steps 1 through 3 above again.

Call Restriction

You can prevent the unit from dialing phone numbers beginning with specified digit(s) (1 digit or 2 digits). Phone numbers with the restricted leading digits cannot be dialed out.

To set the call restriction

Make sure that a call is not put on hold.

- 1 Press **PROGRAM**.
 - The MUTE indicator flashes.
- 2 Press **MUTE**.
- 3 Press **1**.
 - If you use "1111" as a PIN code (factory set), there is no need to enter a PIN code. Go to step 6.
- 4 Enter the PIN code (p. 19).
- 5 Press **PROGRAM**.
 - If a wrong PIN code is entered, 3 beeps will sound. Enter a correct PIN code and press **PROGRAM**.
- 6 Enter the number(s) (1 digit or 2 digits) you want to restrict (**0** to **9**).
 - If you enter a wrong number, enter a correct number.
 - To change restricted digits from 2 digits to 1 digit, press ***** and enter 1 digit.
- 7 Press **PROGRAM**.
 - A long beep sounds.
 - The MUTE indicator light goes out.
 - The unit will return to the standby mode.

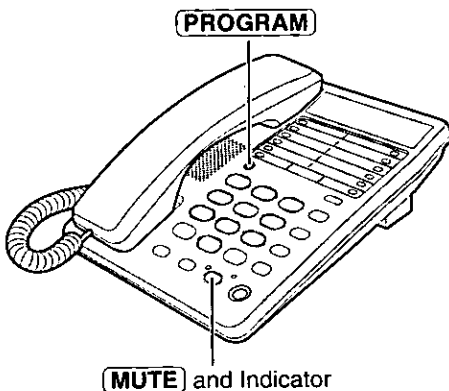

Advanced Operation

- If your unit is connected to a PBX, this function may not operate. Contact your PBX supplier for more information.

To cancel the call restriction

Follow steps 1 through 5. In step 6, press ***** to cancel call restriction and press **PROGRAM**.

- A long beep will sound and the unit will return to the standby mode.

For assistance, please call: 1-800-211-PANA(7262)

Optional Headset

Plugging an optional headset into the unit allows a hands-free phone conversation. Please use only a Panasonic KX-TCA87 or KX-TCA90 headset. To order, call the accessories telephone number on page 2.

Connecting an Optional Headset to the Unit

Connect an optional headset to the headset jack as shown below.

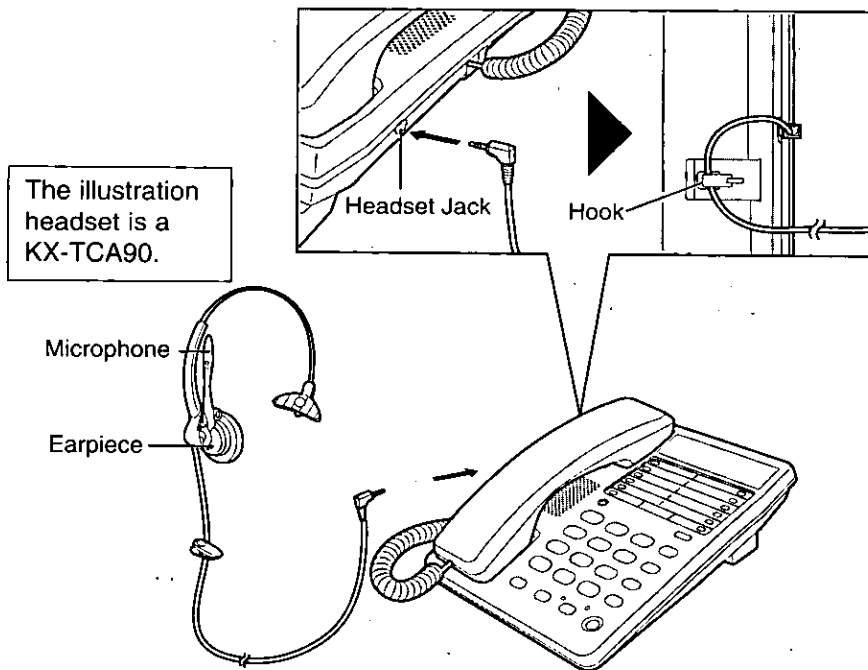

If you want to have a normal conversation, disconnect the headset.

Making/Answering Calls

Make sure to install the batteries.

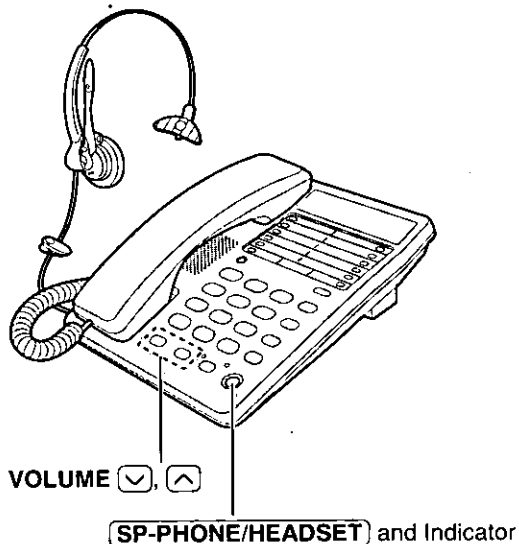

- 1 Press **SP-PHONE/HEADSET** to make or answer a call.
 - The SP-PHONE/HEADSET indicator flashes.
 - If you misdial when making a call, press **SP-PHONE/HEADSET** twice and dial again.
- 2 To hang up, press **SP-PHONE/HEADSET**.
 - The indicator light goes out.

To adjust the headset receiver volume (4 levels):

While using the headset, press **VOLUME** or .

- During a conversation using the headset, you cannot switch the call to the handset by lifting it off the cradle.
- If you disconnect the optional headset during a conversation with the handset on the cradle, the call will be switched to the speakerphone.
- During a conversation using the speakerphone, you can switch the call to the headset by connecting the headset.

Battery Replacement

If the speakerphone does not work, it may be the time to replace the batteries. Replace the batteries within 1 minute to keep the programmed settings.

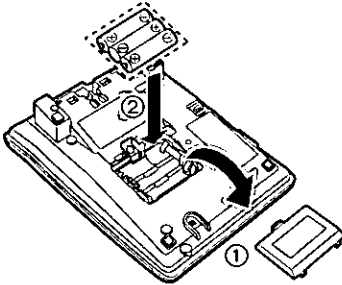

- 1 Disconnect the telephone line cord from the unit.
- 2 Press down in the direction of the arrow and remove the cover.
- 3 Replace the batteries with new ones using correct polarity (+, -), and close the cover.
- 4 Connect the telephone line cord to the unit.

Battery Precautions:

The batteries should be used correctly, otherwise the unit may be damaged by battery leakage.

- Do not mix different types of batteries.
- Do not charge, short-circuit, disassemble, heat or dispose of in fire.
- Remove all the batteries when replacing.

Note:

- Replace all the batteries once a half year in use of Alkaline batteries, or misoperation may occur. (When you use Manganese batteries, replace all of them once in three months.)
- Do not use nickel-cadmium batteries.

Troubleshooting



Problem	Remedy
The unit does not work.	<ul style="list-style-type: none">● Check the settings (p. 5–9).● Remove the batteries and reinstall them to reset the unit.
The unit does not ring.	<ul style="list-style-type: none">● The RINGER selector is set to OFF. Set to HIGH or LOW (p. 8).
You cannot dial.	<ul style="list-style-type: none">● Check that the dialing mode selection is correct (p. 8).● Dial lock mode is set. To cancel the mode, see page 20.● The dialed number is restricted. To cancel, see page 21.
The other party suddenly cannot hear your voice during a conversation.	<ul style="list-style-type: none">● MUTE may have been pressed during the conversation. Press MUTE.
You cannot program items such as the dialing mode.	<ul style="list-style-type: none">● Programming is not possible when a call is put on hold.● Do not pause for over 60 seconds while programming.
You cannot store a phone number in memory.	<ul style="list-style-type: none">● Programming is not possible when a call is put on hold.● Check that the batteries are installed in the unit and that the battery power is not low.● Do not enter a phone number more than 22 digits long.● When using the Dial Lock (p. 20) or Call Restriction feature (p. 21), you cannot store a phone number in the EMERGENCY button.
While programming, the unit starts to ring and stops the program.	<ul style="list-style-type: none">● To answer the call, lift the handset or press SP-PHONE/HEADSET. Start again from the beginning after hanging up.
You cannot redial by pressing REDIAL .	<ul style="list-style-type: none">● If the last number dialed was more than 32 digits long, the number will not be redialed correctly.

► Troubleshooting

Problem	Remedy
Previously programmed information is erased.	<ul style="list-style-type: none">● If the batteries installed in the unit expire, programmed information may be erased. After the batteries are replaced, reprogram if necessary.
If you cannot solve your problem	<ul style="list-style-type: none">● Call our customer call center at 1-800-211-PANA(7262).● Panasonic's e-mail address for customer inquiries: consumerproducts@panasonic.com for customers in the USA or Puerto Rico ONLY

Important Safety Instructions



When using this unit, basic safety precautions should always be followed to reduce the risk of fire, electric shock, or personal injury.

1. Read and understand all instructions.
2. Follow all warnings and instructions marked on this unit.
3. Unplug this unit from wall outlets before cleaning. Do not use liquid or aerosol cleaners. Use a damp cloth for cleaning.
4. Do not use this unit near water, for example, near a bathtub, washbowl, kitchen sink, or the like.
5. Place this unit securely on a stable surface. Serious damage and/or injury may result if the unit falls.
6. Do not cover slots and openings on the unit. They are provided for ventilation and protection against overheating. Never place the unit near radiators, or in a place where proper ventilation is not provided.
7. Do not place objects on the power cord. Install the unit where no one can step or trip on the cord.
8. Do not overload wall outlets and extension cord. This can result in the risk of fire or electric shock.
9. Never push any objects through slots in this unit. This may result in the risk of fire or electric shock. Never spill any liquid on the unit.
10. To reduce the risk of electric shock, do not disassemble this unit. Take the unit to an authorized servicer when service is required. Opening or removing covers may expose you to dangerous voltages or other risks. Incorrect reassembly can cause electric shock when the unit is subsequently used.
11. Unplug this unit from the wall outlet and refer servicing to an authorized servicer when the following conditions occur:
 - A. When the power supply cord or plug is damaged or frayed.
 - B. If liquid has been spilled into the unit.
 - C. If the unit has been exposed to rain or water.
 - D. If the unit does not work normally by following the operating instructions. Adjust only controls covered by the operating instructions. Improper adjustment may require extensive work by an authorized servicer.
 - E. If the unit has been dropped or physically damaged.
 - F. If the unit exhibits a distinct change in performance.
12. During thunderstorms, avoid using telephones except cordless types. There may be a remote risk of an electric shock from lightning.
13. Do not use this unit to report a gas leak, when in the vicinity of the leak.

SAVE THESE INSTRUCTIONS

► Important Safety Instructions

WARNING:

TO PREVENT FIRE OR SHOCK HAZARD, DO NOT EXPOSE THIS PRODUCT TO RAIN OR ANY TYPE OF MOISTURE.

CAUTION:

To reduce the risk of fire or injury to persons, read and follow these instructions.

1. Use only the battery(ies) specified.
2. Do not dispose of the battery(ies) in a fire. It (they) may explode. Check with local waste management codes for special disposal instructions.
3. Do not open or mutilate the battery(ies). Released electrolyte is corrosive and may cause burns or injury to the eyes or skin. The electrolyte may be toxic if swallowed.
4. Exercise care in handling the battery(ies) in order not to short the battery(ies) to conductive materials such as rings, bracelets, and keys. The battery(ies) and/or conductor may overheat and cause burns.
5. Do not recharge the battery(ies) provided with or identified for use with this product. The battery(ies) may leak corrosive electrolyte or explode.
6. Do not attempt to rejuvenate the battery(ies) provided with or identified for use with this product by heating. Sudden release of battery electrolyte may occur causing burns or irritation to the eyes or skin.
7. Replace all batteries at the same time. Mixing fresh and discharged batteries could increase internal cell pressure and rupture the discharged batteries. (Applies to products employing more than one separately replaceable primary battery.)
8. When installing batteries observe the proper polarity or direction. Incorrect installation can cause charging, and may result in leakage or explosion. (Applies to products employing more than one separately replaceable primary battery.)
9. Remove the battery(ies) from this product if the product will not be used for a long period of time (several months or more). During this time the battery(ies) could leak in the product.
10. Discard the "dead" battery(ies) as soon as possible. The "dead" battery(ies) may leak in the product.
11. Do not store this product, or the battery(ies) provided with or identified for use with this product, in high temperature areas. Batteries that are stored in a freezer or refrigerator for the purpose of extending shelf life should be protected from condensation during storage and defrosting. Batteries should be stabilized at room temperature prior to use after cold storage.

FCC and Other Information



If requested by the telephone company, inform them as follows:

FCC Registration No.(found on the bottom of the unit)
Ringer Equivalence1.0B
The particular telephone line to which the equipment is connected.

This unit must not be connected to a coin operated line.

If you are on a party line, check with your local telephone company.

Ringer Equivalence No. (REN):

The REN is useful in determining the quantity of devices you may connect to your telephone line and still have all of those devices ring when your telephone number is called. In most, but not all areas, the sum of the REN's of all devices connected to one line should not exceed five (5.0). To be certain of the number of devices you may connect to your line, as determined by the REN, you should contact your local telephone company to determine the maximum REN for your calling area.

In the event terminal equipment causes harm to the telephone network, the telephone company should notify the customer, if possible, that service may be stopped.

However, where prior notice is impractical, the company may temporarily cease service providing that they:

- (a) Promptly notify the customer.
- (b) Give the customer an opportunity to correct the problem with their equipment.
- (c) Inform the customer of the right to bring a complaint to the Federal Communication Commission pursuant to procedures set out in FCC Rules and Regulations Subpart E of Part 68.

The Telephone Company may make changes in its communications facilities, equipment, operations or procedures, where such action is reasonably required in the operation of its business and is not inconsistent with the rules and regulations in FCC Part 68.

If such changes can be reasonably expected to render any customer terminal equipment incompatible with telephone company communications facilities, or require modification or alteration of such terminal equipment, or otherwise materially affect its use or performance, the customer shall be given adequate notice in writing, to allow the customer an opportunity to maintain uninterrupted service.

When programming emergency numbers and/or making test calls to emergency numbers:

1. Remain on the line and briefly explain to the dispatcher the reason for the call before hanging up.
2. Perform such activities in the off-peak hours, such as early morning hours or late evenings.

► FCC and Other Information

This device complies with Part 15 of the FCC Rules. Operation is subject to the following two conditions:

(1) This device may not cause harmful interference, and (2) this device must accept any interference received, including interference that may cause undesired operation.

CAUTION:

Any changes or modifications not expressly approved by the party responsible for compliance could void the user's authority to operate this device.

Note:

This equipment has been tested and found to comply with the limits for a Class B digital device, pursuant to Part 15 of the FCC Rules. These limits are designed to provide reasonable protection against harmful interference in a residential installation. This equipment generates, uses, and can radiate radio frequency energy and, if not installed and used in accordance with the instructions, may cause harmful interference to radio communications. However, there is no guarantee that interference will not occur in a particular installation. If this equipment does cause harmful interference to radio or television reception, which can be determined by turning the equipment off and on, the user is encouraged to try to correct the interference by one or more of the following measures:

- Reorient or relocate the receiving antenna.
- Increase the separation between the equipment and receiver.
- Connect the equipment into an outlet on a circuit different from that to which the receiver is connected.
- Consult the dealer or an experienced radio/TV technician for help.

A FCC compliant telephone cord and modular plug is provided with this equipment. This equipment is designed to be connected to the telephone network or premises wiring using a compatible modular jack that is Part 68 compliant.

- **Environment**—do not place the unit in a room where the temperature is less than 5°C (41°F) or greater than 40°C (104°F). Allow 10 cm (4") clearance around the unit for proper ventilation. Avoid excessive smoke, dust, mechanical vibration, shock, or direct sunlight.
- **Routine care**—wipe the unit with a soft cloth. Do not use benzine, thinner, or any abrasive powder.
- **If there is any trouble**—disconnect the unit from the telephone line and connect a known working phone. If the known working phone operates properly, have your unit repaired by one of the authorized Panasonic Factory Service Centers. If the known working phone does not operate properly, consult your telephone company.

Index

A		M	
Accessories	2	Making Calls	10
Answering calls	11	Mute	18
B		O	
Battery, Installing	5	One-Touch Dialer	14
Battery life	5	One-Touch Dialer, dialing	16
Battery replacement	24	storing	14
C		P	
Call on hold	11	PAUSE	17
Call Restriction	21	PIN code	19
Call waiting tone	17	Pulse service	17
D		R	
Dial lock	20	Redial	10
Dialing mode	8	Ringer Off	8
F		Ringer Volume	8
FCC and other information	29	Rotary service, tone dialing	17
FLASH button	18	S	
Flash time	18	Safety Instructions	27
H		Shipping Product for Service back cover	
Headset, optional	22	Speed Dialer	12
I		Speed Dialer, dialing	13
Installation, Battery	5	storing	12
Communication Device	6	T	
Handset	5	Troubleshooting	25
Telephone line cord	5	V	
L		Volume control	10
Location of controls	4		

For product service

- Call 1-800-211-PANA(7262) or 1-800-833-9626 for the location of an authorized servicer.
- Panasonic's e-mail address for customer inquiries:
consumerproducts@panasonic.com
for customers in the USA or Puerto Rico ONLY

When you ship the product

- Carefully pack your unit, preferably in the original carton.
- Attach a letter, detailing the symptom, to the outside of the carton.

Symptom _____

- Send the unit to an authorized servicer, prepaid and adequately insured.
- Do not send your unit to the Panasonic Consumer Electronics Company listed below or to executive or regional sales offices. These locations do not repair consumer products.

**If you need assistance with the set-up or operation,
please call 1-800-211-PANA(7262)**

**Panasonic Consumer Electronics Company,
Division of Matsushita Electric Corporation of America
One Panasonic Way, Secaucus, New Jersey 07094**

**Panasonic Sales Company,
Division of Matsushita Electric of Puerto Rico, Inc.
Ave. 65 de Infantería, Km. 9.5, San Gabriel Industrial Park
Carolina, Puerto Rico 00985**

Free Manuals Download Website

<http://myh66.com>

<http://usermanuals.us>

<http://www.somanuals.com>

<http://www.4manuals.cc>

<http://www.manual-lib.com>

<http://www.404manual.com>

<http://www.luxmanual.com>

<http://aubethermostatmanual.com>

Golf course search by state

<http://golfingnear.com>

Email search by domain

<http://emailbydomain.com>

Auto manuals search

<http://auto.somanuals.com>

TV manuals search

<http://tv.somanuals.com>