

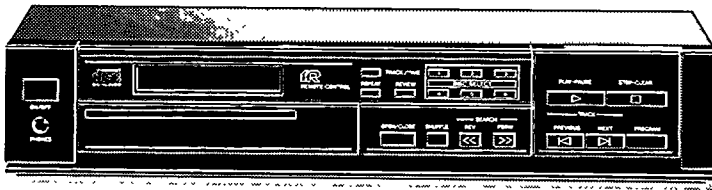

CONSUMER ELECTRONICS

**PHILIPS**



**CDC 486**

**(GB)**

Compact Disc Changer

**(F)**

Changeur de Disques Compacts

**(D)**

Compact Disc-Wechsler

**(NL)**

Compact Disc-Wisselaar

**(E)**

Cambiador 'Compact Disc'

**(I)**

CambiaCompact Disc

**(DK)**

Compact Disc-Skifter

**(S)**

Compact Disc-Växlare

**(SF)**

Compact Disc -Levynvaihdin

## INTRODUCTION

The Compact Disc system is a major step forward in the sphere of audio technology. By employing the most sophisticated digital and optical technologies, Compact Disc not only produces the ultimate in sound reproduction, it also offers unprecedented ease of operation, with rapid access to every track on the disc and the possibility of programming.

## CONTENTS

	Page
INSTALLATION	2
OPERATION	3-5
PROGRAMMING	5-6
ADDITIONAL INFORMATION	6-7
FAULTS AND THEIR LIKELY CAUSES	7
ILLUSTRATIONS	60-61

## INSTALLATION

### UNPACKING

The following accessories are supplied with this Compact Disc changer:

- a power supply lead;
- a connecting cable;
- a remote control;
- batteries for the remote control;
- a cartridge for six Compact Discs.
- Remove all packaging materials from the changer and the accessories.
- Peel the transparent protective foil off the display.

### CHECKING THE POWER SUPPLY

- Check that the type plate on the rear of your changer indicates the correct supply voltage.
- If your mains supply voltage is different, consult your dealer or our Service Organisation.

### REMOVING THE TRANSIT CLAMPS (Fig. 1-2)

The three red transit clamps on the bottom lock the play mechanism to protect it during transportation.

- Turn the changer upside down.
- Turn the clamps anti-clockwise and remove them from the changer.
- Store them in the recesses provided on the back of the changer.

If you want to transport the changer, reinsert the clamps and rotate them clockwise until they lock in position.

## INSERTING AND REPLACING THE BATTERIES IN THE REMOTE CONTROL (Fig. 3)

- Open the battery compartment.
- Insert the two batteries according to the diagram in the compartment.
- Replace the cover.

The life of the batteries is around one year. Remove them when they are exhausted or when you are not intending to use the remote control for some time. In this way you will prevent damage to the remote control by possible battery leakage.

For replacement only use batteries of the type R03, UM4 or AAA.

## SITING THE COMPACT DISC CHANGER

### Free-standing

- Always position the changer horizontally on a flat, firm surface.
- Allow a free space of at least 3 cm above the changer so as not to interfere with the cooling of the changer.

### In an audio rack

- The changer can be sited in any desired position.

### Stacked

- Site the changer preferably at the bottom or at the top.
- Never position the changer directly on top of a high-power amplifier, because such an amplifier gives off a substantial amount of heat.

### Warning!

Never allow the changer to stand for long periods in direct sunlight or near any heat source.

## CONNECTIONS (Fig. 4)

a **RC5 IN/OUT**: for a remote control system.

Use this connection for:

- Connecting up the equipment when you are incorporating the changer in a PHILIPS HiFi-system with its own remote control system.
- Connecting the remote control receiver EM 2200, available as an accessory, if the siting of the changer prevents its REMOTE CONTROL eye from receiving the signals from the remote control directly.

b **LINE OUT L/R**: for the connecting cable to the amplifier.

- Insert a red plug into the 'R' socket (right-hand channel) and the other plug into the 'L' socket (left-hand channel).

- Insert the two other plugs into the corresponding sockets of the CD or AUX input of your amplifier. You can also use the TUNER or TAPE IN connection, but *never* the PHONO input. This is not suitable for Compact Disc reproduction.

c **MAINS**: connection for the mains lead.

## OPERATION

### EXPLANATION OF KEYS ETC. (Fig. 5)

#### 1 ON/OFF

- › For switching on and off.

#### 2 DISPLAY

- › Informs you on the functioning of the changer.
- › Displays details from the disc contents list. See also: 'The indications on the display'.

#### 3 REMOTE CONTROL

- › Receives the signals from the remote control.

#### 4 REPEAT

- › For repeating play.

#### 5 TRACK/TIME

- › For selecting between track/index number and playing time indication.

#### 6 REVIEW

- › For checking a programme.

#### 7 DISC SELECT

- › For selecting another disc during play.
- › For selecting a disc to start play with.
- › For selecting discs during programming. The — DISC + buttons on the remote control have the same function ('—' from high to low and '+' from low to high).

#### 8 PLAY-PAUSE

- › For starting play (PLAY).
- › For briefly interrupting play (PAUSE).
- › For holding play at the start of a disc, track or passage (PAUSE).

#### 9 STOP-CLEAR

- › For stopping play (STOP).
- › For erasing a programme (CLEAR).

#### 10 PHONES

- › For connection of headphones. See also: 'Listening with headphones'.

#### 11 OPEN/CLOSE

- › For opening and closing the cartridge compartment.
- › For sliding the cartridge out of the changer.

#### 12 SHUFFLE

- › For playing in random order.

#### 13 REV SEARCH FORW

- › For fast search to a particular passage during play (REV backwards and FORW forwards).

#### 14 PREVIOUS TRACK NEXT

- › For returning to the beginning of a track.
- › For selecting another track during play.
- › For selecting the track number you want play to begin with.
- › For selecting track numbers when compiling a programme. (PREVIOUS from high to low and NEXT from low to high).

#### 15 PROGRAM

- › For storing disc and track numbers in a programme.
- › For erasing track numbers from a programme.

The keys of the remote control have the same function as the corresponding ones on the changer (STOP-CLEAR = STOP CM).

For the best reception of its signals you should aim the remote control as directly as possible at the REMOTE CONTROL eye.

### THE INDICATIONS ON THE DISPLAY (Fig. 6)

Each Compact Disc has, along with the music, a list of contents detailing the numbers of the tracks and the playing time of each track.

The changer always scans this first and stores it in its memory in order, for instance, to provide information via the display.

#### PROGRAM

- › Lights up when a programme is stored in the changer's memory and when it is played.

#### SHUFFLE

- › Lights up when the tracks on the discs or in a programme are played in random order.

#### REVIEW

- › Lights up when you check a programme.

#### REPEAT

- › Lights up when play is repeated.

#### PAUSE

- › Lights up when the changer is in the pause mode.

#### '1-6'

- › Light up when the changer has been switched on.

#### DISC

- › Indicates what disc is being played.

#### '>'

- › Lights up during playback.

#### TRACK

- › Indicates what track is being played.

#### INDEX

- › The numbers only change if the parts of a track have index numbers.

#### TIME

- › Lights up when you press TRACK/TIME. The display then shows the elapsed playing time of the track playing.

#### '(((O'

- › Lights up briefly when the REMOTE CONTROL eye receives a command from the remote control.

#### Err

- › Lights up briefly when you make a mistake in operating the changer.
- › Lights up briefly if you try to start playback when the disc is inserted with the printed side up, is not inserted at all or if it is damaged. If so, the number of the disc on the number indicator '1-6' goes out.

#### dISC

- › Lights up when the changer has been switched on.
- › Lights up when you press OPEN/CLOSE to open the cartridge compartment.

## SWITCHING ON AND OFF (ON/OFF)

### Switching on

- Press ON/OFF.
- *dISC* and '1-6' light up.
- › When there is a cartridge in the changer the number of the first disc appears above *DISC* and the number of the first track on it appears above *TRACK*. Play then starts automatically after 2 seconds.

### Switching off

- Press ON/OFF again.
- › All lights are extinguished.

### Warning!

Do not switch off the changer *until* the cartridge compartment has been closed!

---

## INSERTING DISCS INTO THE CARTRIDGE

(Fig. 7-10)

- Open *one tray at a time*.
- Place the disc in the tray *with the printed side facing downwards*.
- Close each tray *before* opening another one.

### Warning!

- This cartridge is *only for home use*.
  - *Only 12-cm discs* should be inserted.
  - Should you wish to insert 8-cm discs (CD-singles), they should *first* be adapted by means of adapter rings (Fig. 11). For this purpose *only* use adapter rings of the type SBC 3580. A separate cartridge for 8-cm discs is also available.
- 

## PLAYBACK (PLAY-PAUSE)

- Press OPEN/CLOSE to open the cartridge compartment.
  - Insert the cartridge into the changer (Fig. 12).
    - › The number of the first disc appears above *DISC* and the number of the first track on it appears above *TRACK*.
    - › The cartridge compartment closes automatically after 2 seconds, the '>' indication lights up and a few moments later playback starts. You can also start play with PLAY-PAUSE.
    - › Above *DISC* and *TRACK* can always be seen what disc and what track on it is being played.
    - › After the last disc play stops.
    - › The '>' indication goes out and above *DISC* and *TRACK* you will again see the number of the first disc and the number of the first track on it.
  - Press OPEN/CLOSE to open the cartridge compartment.
    - › The *DISC* indication lights up.
  - Remove the cartridge from the changer.
    - › The cartridge compartment closes automatically after 2 seconds. You can also close it by pressing OPEN/CLOSE.
- 

## CHANGING TO PLAYING TIME INDICATION (TRACK/TIME)

- Press TRACK/TIME.
    - › The *TIME* indication lights up.
    - › The display now shows the elapsed playing time of the track being played in minutes and seconds.
    - › At each subsequent track the track number first appears briefly, immediately followed by the elapsed playing time.
  - Press TRACK/TIME again to return to track number indication.
- 

## GOING BACK TO THE BEGINNING OF A TRACK (PREVIOUS)

- Press PREVIOUS.
    - › The track starts again from the beginning.
- 

## SELECTING ANOTHER TRACK DURING PLAY (PREVIOUS TRACK NEXT)

### A following track

- Press NEXT until the desired track number appears above *TRACK*.
  - › The music stops and a moment later the selected track begins to play.
- If you press NEXT while playing the last track, the first one will be played.

### A previous track

- Keep PREVIOUS pressed in until the required track number appears above *TRACK*.
    - › The music stops and a moment later the selected track begins to play.
  - If you press PREVIOUS while playing the first track, the last one will be played.
- 

## SELECTING ANOTHER DISC DURING PLAY (DISC SELECT or — DISC +)

- Key in the number of the required disc or press '–' or '+' until the number appears above *DISC*.
    - › The music stops and a few moments later the selected disc begins to play.
  - If you press '+' while playing the last disc, the first one will be played. If you press '–' while playing the first disc, the last one will be played.
- 

## SEARCHING FOR A PARTICULAR PASSAGE DURING PLAY (REV SEARCH FORW)

- Hold REV down to search backwards to the beginning.
  - Hold FORW down to search forwards to the end. As soon as the key is released play restarts. When you reach the beginning of the first track, 'Err' appears. Play will resume there as soon as you release the key. If you reach the end of the last track, 'Err' will also appear. If you then release the key, play will resume a few seconds before the end of the disc. If you have pressed PLAY-PAUSE before you started to search, the sound will be switched off.
-

### **BEGINNING WITH A DISC OTHER THAN THE FIRST (DISC SELECT or - DISC + and PLAY-PAUSE)**

- Key in the number of the required disc or press '-' or '+' until the number appears above *DISC*.
  - Press PLAY-PAUSE.
  - › The '>' indication lights up and play begins with the selected disc.
- 

### **BEGINNING WITH A TRACK NUMBER OTHER THAN THE FIRST**

#### **(PREVIOUS TRACK NEXT and PLAY-PAUSE)**

- Key in the number of the required disc or press '-' or '+' until the number appears above *DISC*.
  - Press NEXT or PREVIOUS until the required track number appears above *TRACK*.
  - Press PLAY-PAUSE.
  - › The '>' indication lights up and play will start from the selected track.
- 

### **RANDOM PLAYBACK (SHUFFLE)**

- Press SHUFFLE before or during play.
- › The *SHUFFLE* indication lights up.
- › All tracks are now played in random order.

If you also press REPEAT then play is repeated in a different order each time.

If you press NEXT then play continues with any other track.

If you press PREVIOUS then the track playing is restarted.

Searching for a particular passage is limited to within the track being played.

- Press SHUFFLE again if you wish to return to normal play.
  - › The *SHUFFLE* indication goes out.
- 

### **BRIEFLY INTERRUPTING PLAYBACK/HOLDING PLAY AT THE START OF A DISC, TRACK OR PASSAGE (PLAY-PAUSE)**

#### **To briefly interrupt playback**

- Press PLAY-PAUSE.
- › The *PAUSE* indication lights up.
- › The sound stops but the disc continues to spin.
- Press PLAY-PAUSE again to restart.
- › The *PAUSE* indication goes out.
- › Play restarts at the point where it was interrupted.

#### **Holding play at the start of a disc, track or passage**

You can go to any place on a disc and hold it by pressing PLAY-PAUSE before:

- starting to play a disc;
  - going back to the beginning of a track;
  - selecting another disc or track;
  - searching for a particular passage;
  - beginning with a disc or track other than the first.
- Press PLAY-PAUSE again to start play at the chosen place.
- 

### **REPEATING PLAY (REPEAT)**

- Press REPEAT before or during playback.
  - › The *REPEAT* indication lights up.
  - › All discs are repeated over and over.
  - Press REPEAT again to stop repeating.
  - › The *REPEAT* indication goes out.
  - › Play will continue as normal.
- Repeating can also be stopped by pressing STOP-CLEAR or OPEN/CLOSE.
- 

### **STOPPING PLAYBACK**

#### **(STOP-CLEAR or OPEN/CLOSE)**

- Press STOP-CLEAR if you merely wish to stop.
  - › The '>' indication goes out and you will see again the number of the first disc above *DISC* and the number of the first track on it above *TRACK*.
  - Press OPEN/CLOSE if you wish to stop and take out the cartridge.
  - › The '>' indication goes out and the *DISC* indication lights up.
- 

## **PROGRAMMING**

By programming the changer you can play up to 30 tracks in any required sequence. If you exceed the maximum of 30 tracks, 'Err' appears.

---

### **STORING A PROGRAMME**

#### **Before playback**

- Key in the number of the required disc or press '-' or '+' until the number appears above *DISC*.
- Press NEXT or PREVIOUS until the first track number you wish to programme appears above *TRACK*.
- Press PROGRAM.
- › The *PROGRAM* indication lights up and 'P 1' appears; the track number has now been stored in the changer's memory.
- Select the remaining required track numbers of the disc and store each number by pressing PROGRAM.
- › Each time you store a track 'P' will appear, followed by the number of tracks stored.
- If you wish to store tracks from another disc, you should first enter the number of the disc.

#### **During playback**

- Press PROGRAM for every track number you wish to include in the programme.
  - › Each time you record a track number 'P' will appear, followed by the number of tracks stored.
-

## CHECKING THE PROGRAMME

- Press REVIEW.
  - › The *REVIEW* indication lights up.
  - › All the disc and track numbers appear in the programmed sequence on the display.
- If 'Err' appears, this means that nothing has yet been stored.
- 

## ERASING A TRACK NUMBER FROM THE PROGRAMME OR THE ENTIRE PROGRAMME

- Press REVIEW.
  - › The *REVIEW* indication lights up.
  - › All the disc and track numbers appear in the programmed sequence on the display.
  - Press PROGRAM as soon as the track number appears that you wish to erase.
  - Press STOP-CLEAR if you wish to erase the entire programme.
- 

## PLAYING THE PROGRAMME

- Press PLAY-PAUSE.
- › The '>' indication lights up and play begins with the first item on the programme.
- › As play continues the following numbers in the sequence appear.
- › The entire program can be displayed by pressing REVIEW. The *REVIEW* indication will meanwhile be lit.

All keys (apart from DISC SELECT and — DISC +) can be used during the playing of a programme. Searching for a particular passage is limited to within the track being played.

When STOP-CLEAR is pressed or when all the tracks of the programme have been played, the disc stops, but the programme remains stored.

The programme will be erased when you press OPEN/CLOSE. It will also be erased if you press STOP-CLEAR twice in succession *during playback*.

---

## ADDITIONAL INFORMATION

### LISTENING WITH HEADPHONES (PHONES)

Connect headphones with a 6.3 mm jack plug and an impedance between 8 and 1000 ohms to the PHONES socket.

The sound level you hear is dependent on the impedance of the headphones and the signal level on the disc itself.

---

### ATTACHING THE STICKERS TO THE CARTRIDGE (fig. 13-14)

The stickers can be used for:

- Noting disc titles, names of artists etc. on the storage case ('A' and 'C') and the cartridge itself ('B' and 'C').
- Numbering, alphabetising and classifying different cartridges ('D', 'E', 'F' and 'G').

- Attach the stickers at the places indicated. Should you attach them elsewhere this may hamper the functioning of the changer or the cartridge. Do not place stickers on top of each other. Only the stickers 'D', 'E', 'F' and 'G' can be placed on top of the 'C' stickers.

---

### CARE OF THE DISCS

Although both sides of a disc are protected by a special coating, it is still advisable to treat the discs with care:

- Never leave discs lying around, put them back in their holders immediately after use.
- Never write on the printed side!
- Do not attach any stickers on that side.
- Keep the shiny surface of the disc clean. Use a soft lint-free cloth and always wipe the disc in a straight line from centre to edge. You may breathe lightly on the disc first.

The cleaning set SBC 3540, available separately, is a useful accessory for cleaning your discs. It contains a protective support, a special disc cleaning cloth and a bottle of cleaning fluid.

### **Warning!**

Cleaning agents for conventional records are not suitable for cleaning a Compact Disc. Nor may detergents or abrasive cleaning agents be used.

---

### CHANGER MAINTENANCE

A chamois leather slightly moistened with water is sufficient for cleaning the changer. Do not use cleaning agents containing alcohol, spirits, ammonia or abrasives.

The disc trays should be kept free of dust with a dry cloth.

---

## TECHNICAL DATA

### Typical Audio Performance

Frequency range: 2 Hz-20 kHz  
Amplitude linearity:  $\pm 0.1$  dB (20 Hz-20 kHz)  
Phase linearity:  $\pm 0.7^\circ$  (20 Hz-20 kHz)  
Dynamic range:  $> 86$  dB (20 Hz-20 kHz)  
Signal-to-noise ratio:  $> 93$  dB (20 Hz-20 kHz)  
Channel separation: 94 dB (1 kHz)  
Total harmonic distortion: 0.016% (1 kHz)  
Wow and flutter: quartz crystal precision  
D/A conversion: quadruple oversampling (176.4 kHz) with digital filter and two 16 bit D/A converters  
Audio output level:  $2 V_{\text{rms}}$   
Impedance PHONES jack: 8-1000 ohms

### Power supply

Supply voltage and -frequency: see the type plate at the rear of the changer  
Power consumption: 15 W approx.  
Safety requirements: IEC

### Cabinet

Material/finish: metal and polystyrene with decorative trim  
Dimensions (w x h x d): 420 x 87 x 310 mm  
Weight: 4.8 kg approx.

### Subject to modification

***This Compact Disc changer complies with radio interference requirements as laid down in EC regulations.***

---

## FAULTS AND THEIR LIKELY CAUSES

Insufficient familiarity with the combination of a new product and new discs may lead to faults arising during use. These are generally caused by simple errors in operation or external factors.

It is perhaps useful to check the points listed below and where possible remedy these before taking your changer for repair.

- The transit clamps have not been removed.
- Condensation has formed on the lens of the laser due to a dramatic change in temperature. This will disappear automatically after some time.
- There is a foreign object in the disc tray.
- The disc has not been inserted with the printed side facing downwards or there is no disc in the tray.
- The disc is dirty, badly scratched or warped.
- The changer has been connected to the PHONO input of the amplifier.

If the fault remains, try to clear it by switching the changer off and on.

If this also fails to help, do not continue experimenting, but remove the mains plug from the wall socket and consult your dealer.

Certain faults may be caused by a disc. In order to help determine the precise cause, take the disc with which the fault occurred with you when you take the changer for repair.

***Under no circumstances should you repair the changer yourself, as this will invalidate the guarantee!***

---

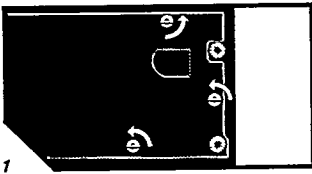

1

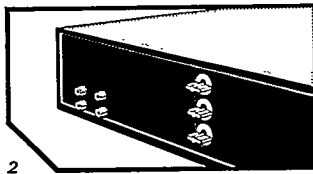

2

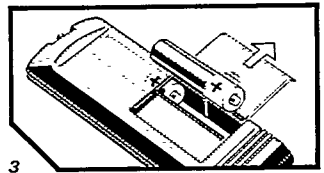

3

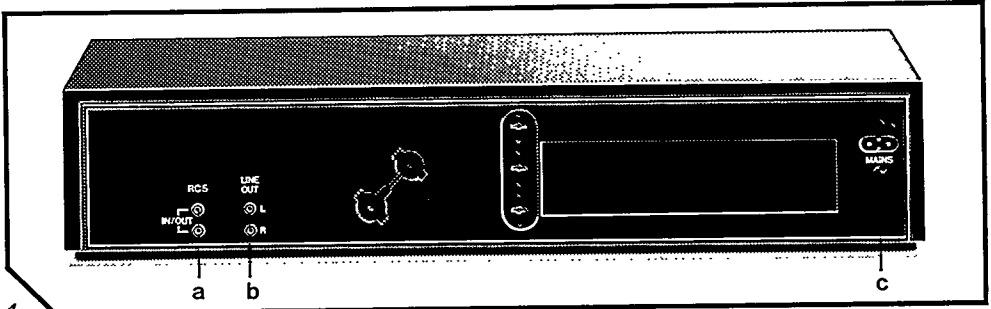

4

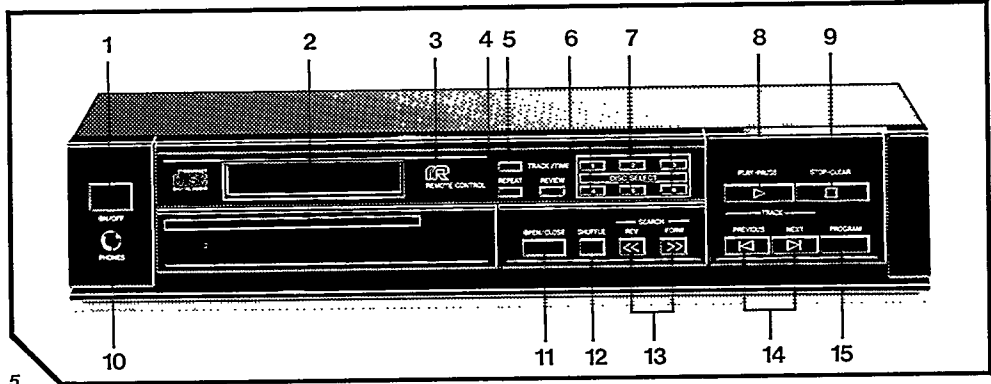

5



6

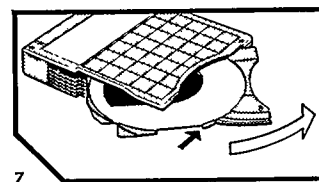

7

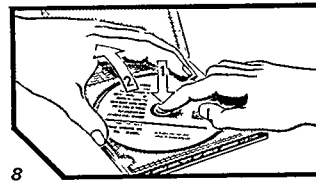

8

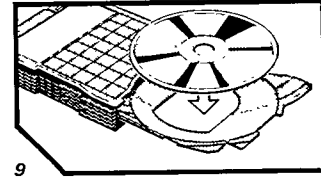

9

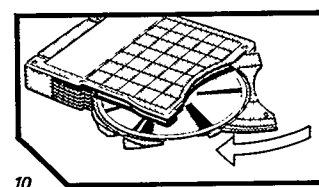

10

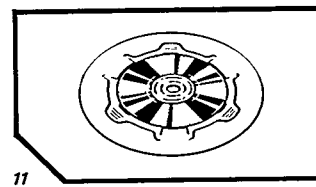

11

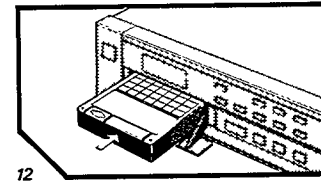

12



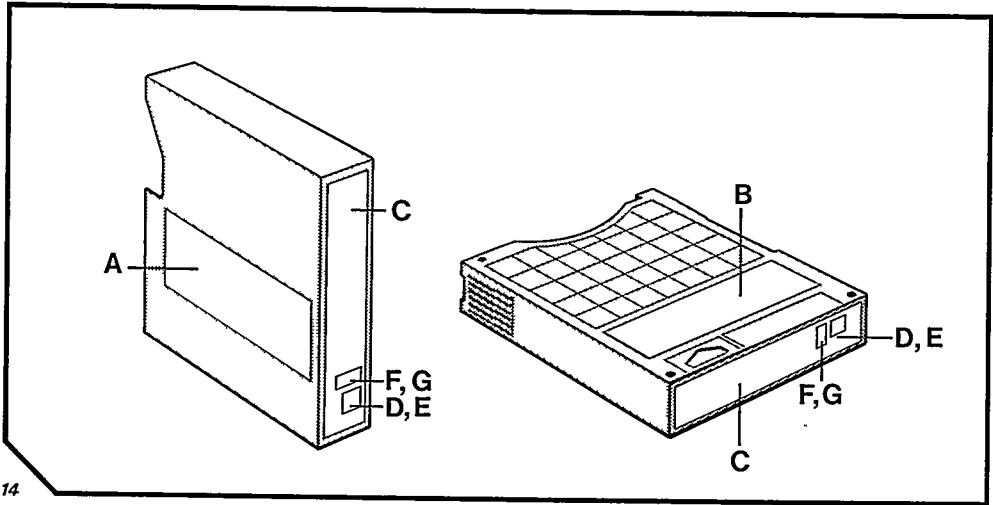
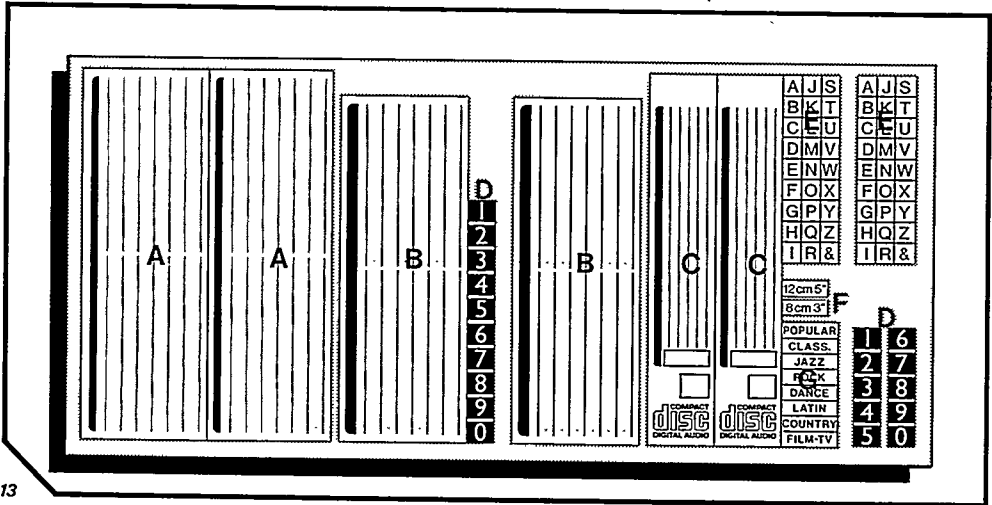



## Free Manuals Download Website

<http://myh66.com>

<http://usermanuals.us>

<http://www.somanuals.com>

<http://www.4manuals.cc>

<http://www.manual-lib.com>

<http://www.404manual.com>

<http://www.luxmanual.com>

<http://aubethermostatmanual.com>

Golf course search by state

<http://golfingnear.com>

Email search by domain

<http://emailbydomain.com>

Auto manuals search

<http://auto.somanuals.com>

TV manuals search

<http://tv.somanuals.com>