



CONSUMER ELECTRONICS

**PHILIPS**



0 0 0 0 0 0 0 0 0 0 1 5 0 6

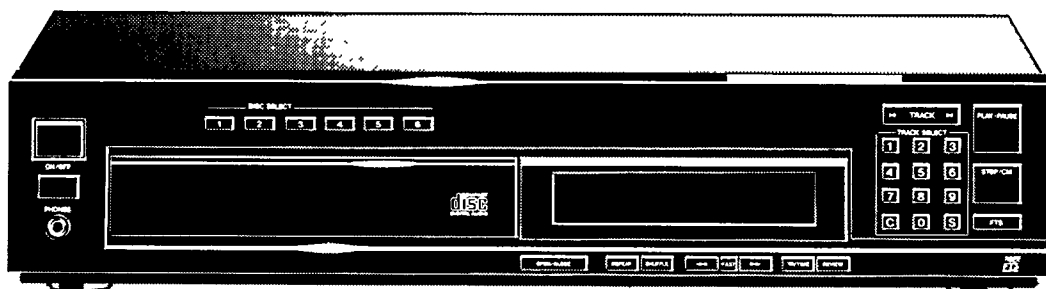

**CDC 586**

GB

Compact Disc Changer

F

Changeur de Disques Compacts

D

Compact Disc-Wechsler

NL

Compact Disc-Wisselaar

E

Cambiador 'Compact Disc'

I

CambiaCompact Disc

DK

Compact Disc-Skifter

S

Compact Disc-Växlare

SF

Compact Disc -Levynvaihdin

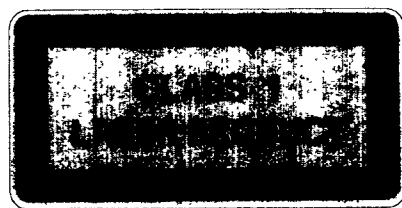

These numbered stickers are to identify the Compact Discs which you have stored in the FTS memory of your Compact Disc player. This makes it easier to identify the discs in your collection.

Be careful that you use the sticker with the correct ranking number. You can easily check this in the display when you insert the disc.

For further details, please refer to the Operating Instructions.

Ces autocollants numérotés sont destinés à vous aider à repérer les 'Compact Discs' que vous avez programmés dans la mémoire 'FTS' de votre lecteur 'Compact Disc'. Ainsi, vous retrouverez plus facilement ces disques dans votre collection. Veillez à coller l'autocollant portant le bon numéro de classement 'FTS'. Le numéro de classement correspondant à un disque donné apparaît sur l'afficheur du lecteur. Pour plus de détails, voyez le mode d'emploi.

Mit diesen nummerierten Aufklebern können Sie die Compact Discs kennzeichnen, die Sie im 'FTS'-Speicher Ihres Compact-Disc-Spielers gespeichert haben. Dies erleichtert Ihnen das Wiederauffinden der Platten in Ihrer Sammlung.

Achten Sie darauf, daß Sie den Aufkleber mit der richtigen 'FTS'-Ordnungsnummer verwenden. Die zu der betreffenden Platte gehörende Ordnungsnummer finden Sie im Anzeige-Display des Spielers, wenn Sie die Platte einlegen.

Weitere Hinweise gibt Ihnen die Bedienungsanleitung.

Deze genummerde stickers dienen om de Compact Discs te merken die u in het 'FTS'-geheugen van uw Compact Disc-speler hebt opgeslagen. Dit vergemakkelijkt de herkenning van deze platen in uw collectie.

Let erop dat u de sticker met het juiste volgnummer gebruikt. Het bij de plaat behorende volgnummer vindt u op de display van de speler.

Raadpleeg voor verdere bijzonderheden de gebruiksaanwijzing.

Estas pegatinas numeradas sirven para marcar los discos compactos que Ud. ha puesto en la memoria 'FTS' de su reproductor 'Compact Disc', lo cual le permite reconocer fácilmente los discos en su colección.

Procure utilizar la pegatina con el número de orden 'FTS' correcto. En el presentador del reproductor puede Ud. ver el número de orden que al disco corresponde. Para más detalles, consulte las instrucciones de manejo.

Questi adesivi numerati servono per contrassegnare i dischi che sono stati trasferiti nella memoria 'FTS' del vostro lettore Compact Disc onde distinguerli nella vostra collezione.

Fate attenzione di apportare l'adesivo con il corretto numero d'ordine 'FTS'. Il numero d'ordine appartenente al disco lo troverete sul visore del lettore.

Consultate le istruzioni d'uso per informazioni più dettagliate in merito.

Disse nummererte klebemerkene er for merking av de Compact-platene De har lagret i Deres Compact Disc spillers 'FTS'-hukommelse. Dette forenkler letingen etter disse platene i Deres samling.

Pass på at De bruker klebemerket som er påført riktig 'FTS' serienummer. Nummeret som korresponderer med platen kan avleses på spillerens display; se bruksanvisningen.

Disse nummererede klistermærker er beregnet til at mærke Deres Compact Discs som De har oplagret i Deres Compact Disc-afspillers 'FTS'-hukommelse. Derved kan De nemt genkende disse discs.

Sørg for at De anvender klistermærket med den rette 'FTS'-rækkefølge. Rækkefølgen som hører til disc'en, finder De på afspillerens display; rådspørg brugsanvisningen.

Med de här numrerade etiketterna kan Du märka dina Compact Disc skivor, som Du har lagrat i 'FTS'-minnet på din Compact Disc-spelare. Detta gör det lättare att känna igen skivorna i din samling.

Se till att Du använder etiketten med rätt 'FTS'-platsnummer. Platsnumret som hör till skivan kan Du se på spelarens display.

För mer detaljer, se bruksanvisningen.

Näillä numerotarroilla voit merkitä ne CD-levyt, jotka olet ohjelmoinut Compact Disc -soittimen 'FTS'-muistiin. Tarrojen avulla löydät levyt helpommin muiden levyjen joukosta.

Pidä huoli, että kiinnität levyyn oikean 'FTS'-numerotarran. Levyn 'FTS'-numero on helppo tarkistaa näytöstä, kun levy on syötetty soittimeen.

Tarkemmat ohjeet ovat käyttöohjeessa.

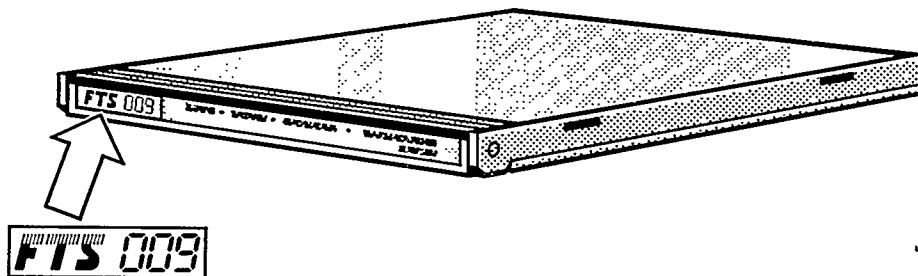

FIS	001	034	057	FIS	00	FIS	83	FIS	166	FIS	199	FIS	232	FIS	244
FIS	002	035	058	FIS	01	FIS	84	FIS	167	FIS	200	FIS	233	FIS	245
FIS	003	036	059	FIS	02	FIS	85	FIS	168	FIS	201	FIS	234	FIS	246
FIS	004	037	060	FIS	03	FIS	86	FIS	169	FIS	202	FIS	235	FIS	247
FIS	005	038	061	FIS	04	FIS	87	FIS	170	FIS	203	FIS	236	FIS	248
FIS	006	039	062	FIS	05	FIS	88	FIS	171	FIS	204	FIS	237	FIS	249
FIS	007	040	063	FIS	06	FIS	89	FIS	172	FIS	205	FIS	238	FIS	250
FIS	008	041	064	FIS	07	FIS	90	FIS	173	FIS	206	FIS	239	FIS	251
FIS	009	042	065	FIS	08	FIS	91	FIS	174	FIS	207	FIS	240	FIS	252
FIS	010	043	066	FIS	09	FIS	92	FIS	175	FIS	208	FIS	241	FIS	253
FIS	011	044	067	FIS	10	FIS	93	FIS	176	FIS	209	FIS	242	FIS	254
FIS	012	045	068	FIS	11	FIS	94	FIS	177	FIS	210	FIS	243	FIS	
FIS	013	046	069	FIS	12	FIS	95	FIS	178	FIS	211	FIS	244	FIS	
FIS	014	047	070	FIS	13	FIS	96	FIS	179	FIS	212	FIS	245	FIS	
FIS	015	048	071	FIS	14	FIS	97	FIS	180	FIS	213	FIS	246	FIS	
FIS	016	049	072	FIS	15	FIS	98	FIS	181	FIS	214	FIS	247	FIS	
FIS	017	050	073	FIS	16	FIS	99	FIS	182	FIS	215	FIS	248	FIS	
FIS	018	051	074	FIS	17	FIS	100	FIS	183	FIS	216	FIS	249	FIS	
FIS	019	052	075	FIS	18	FIS	101	FIS	184	FIS	217	FIS	250	FIS	
FIS	020	053	076	FIS	19	FIS	102	FIS	185	FIS	218	FIS	251	FIS	
FIS	021	054	077	FIS	20	FIS	103	FIS	186	FIS	219	FIS	252	FIS	
FIS	022	055	078	FIS	21	FIS	104	FIS	187	FIS	220	FIS	253	FIS	
FIS	023	056	079	FIS	22	FIS	105	FIS	188	FIS	221	FIS	254	FIS	
FIS	024	057	080	FIS	23	FIS	106	FIS	189	FIS	222	FIS	255	FIS	
FIS	025	058	081	FIS	24	FIS	107	FIS	190	FIS	223	FIS	256	FIS	
FIS	026	059	082	FIS	25	FIS	108	FIS	191	FIS	224	FIS	257	FIS	
FIS	027	060	083	FIS	26	FIS	109	FIS	192	FIS	225	FIS	258	FIS	
FIS	028	061	084	FIS	27	FIS	110	FIS	193	FIS	226	FIS	259	FIS	
FIS	029	062	085	FIS	28	FIS	111	FIS	194	FIS	227	FIS	260	FIS	
FIS	030	063	086	FIS	29	FIS	112	FIS	195	FIS	228	FIS	261	FIS	
FIS	031	064	087	FIS	30	FIS	113	FIS	196	FIS	229	FIS	262	FIS	
FIS	032	065	088	FIS	31	FIS	114	FIS	197	FIS	230	FIS	263	FIS	
FIS	033	066	089	FIS	32	FIS	115	FIS	198	FIS	231	FIS	264	FIS	

<b>English</b>	page 3
Figures	page 58-59
<b>Français</b>	page 9
Figures	page 58-59
<b>Deutsch</b>	Seite 15
Abbildungen	Seite 58-59
<b>Nederlands</b>	pagina 21
Figuren	pagina 58-59
<b>Español</b>	página 27
Figuras	página 58-59
<b>Italiano</b>	pagina 33
Figure	pagina 58-59
<b>Dansk</b>	side 39
Figurer	side 58-59
<b>Svenska</b>	sida 45
Figurer	sida 58-59
<b>Suomi</b>	sivu 51
Kuvat	sivu 58-59





# English

## INTRODUCTION

The Compact Disc system is a major step forward in the sphere of audio technology. By employing the most sophisticated digital and optical technologies, Compact Disc not only produces the ultimate in sound reproduction, it also offers unprecedented ease of operation, with rapid access to every track on the disc and the possibility of programming.

---

## CONTENTS

	Pag.
INSTALLATION	3
OPERATION	4-6
PROGRAMMING	6
FAVOURITE TRACK SELECTION (FTS)	7
ADDITIONAL INFORMATION	8
FAULTS AND THEIR LIKELY CAUSES	8
ILLUSTRATIONS	58-59

---

## INSTALLATION

### UNPACKING

With this changer are supplied:

- a power supply lead;
  - a connection cable;
  - a remote control;
  - batteries for the remote control;
  - a cartridge for six Compact Discs.
  - Remove all packaging materials from the changer and the accessories.
- 

### CHECKING THE POWER SUPPLY SETTING

- Check that the type plate on the rear of your changer indicates the correct supply voltage.
  - If your mains supply voltage is different, consult your dealer or our Service Organisation.
- 

### REMOVING THE TRANSIT CLAMPS (Fig. 1-2)

The three red transit clamps on the bottom lock the play mechanism to protect it during transportation.

- Turn the changer upside down.
  - Turn the clamps anti-clockwise and withdraw them from the changer.
  - Store them in the recesses provided on the rear of the changer. If you want to transport the changer, reinsert the clamps and rotate them clockwise until they lock in position.
- 

### INSERTING AND REPLACING THE BATTERIES IN THE REMOTE CONTROL (Fig. 3)

- Open the battery compartment.
- Insert the three batteries according to the diagram in the compartment.
- Replace the cover.

The life of the batteries is around one year. Remove them when they are flat or when you are not intending to use the remote control for some time. In this way you will prevent damage to the remote control by possible battery leakage.

For replacement only use batteries of the type R03, UM4 or AAA.

---

## SITING THE CHANGER

### Free-standing

- Always position the changer horizontally on a flat, firm surface.
- Allow a free space of at least 3 cm above the changer so as not to interfere with the cooling of the changer.

### In an audio rack

- The changer can be sited in any desired position.

### Stacked

- Site the changer preferably at the bottom or at the top.
- Never position the changer directly on top of a high-power amplifier, as such an amplifier gives off a substantial amount of heat.

### Warning!

Never stand the changer in persistent direct sunlight or near any heat source.

---

## CONNECTIONS (Fig. 4)

**a RC5 IN/OUT:** for a remote control system.

Use this connection for:

- Connecting up the equipment when you are incorporating the changer in a PHILIPS HiFi system with its own remote control system.
- Connecting the remote control receiver EM 2200, available as an accessory, if the siting of the changer prevents its REMOTE CONTROL eye from receiving the signals from the remote control directly.

**b LINE OUT L/R:** for the connection cable to the amplifier.

- Insert a red plug into the 'R' socket (right-hand channel) and the other plug into the 'L' socket (left-hand channel)
  - Insert the two other plugs into the corresponding sockets of the CD or AUX input of your amplifier.
- You can also use the TUNER or TAPE IN connection, but *never* the PHONO input. This is not suitable for Compact Disc reproduction.

**c MAINS:** connection for the mains lead.

---

## OPERATION

### EXPLANATION OF KEYS ETC. (Fig. 5)

#### 1 ON/OFF

- › For switching on and off.

#### 2 'DISC SELECT

- › For selecting another disc during play.
- › For selecting a disc to start play with.
- › For selecting discs during programming.  
The - DISC + keys on the remote control have the same function ('-' from high to low and '+' from low to high).

#### 3 DISPLAY

- › Informs you about the functioning of the changer.
- › Displays details from the disc contents list.  
See also: 'The information on the display'.

#### 4 ◀TRACK▶

- › For returning to the beginning of a track.
- › For selecting another track number during play.
- › For selecting a track number to start play with.
- › For selecting track numbers during programming.  
(◀ from high to low and ▶ from low to high.)  
The PREV REPLAY and NEXT keys on the remote control have the same function (PREV REPLAY from high to low and NEXT from low to high).

#### 5 PLAY-PAUSE

- › For starting play (PLAY).
- › For briefly interrupting play (PAUSE).
- › For holding play at the start of a disc, track or passage (PAUSE).

#### 6 STOP/CM

- › For stopping play (STOP).
- › For erasing a programme (CM = Clear Memory).

#### 7 REMOTE CONTROL

- › Receives the signals from the remote control.

#### 8 PHONES

- › For connection of headphones.  
See also: 'Listening with headphones'.

#### 9 OPEN/CLOSE

- › For opening and closing the cartridge compartment.
- › For ejecting the cartridge.

#### 10 REPEAT

- › For repeating a track, a disc, all discs, or a programme.

#### 11 SHUFFLE

- › For playing in random order.

#### 12 '◀◀ ▶▶'

- › For fast search to a particular passage during play ('◀◀' backwards and '▶▶' forwards).  
When used in conjunction with FAST, the search speed is increased.

#### 13 TR(ACK)/TIME

- › For selecting between track/index number and playing time indication.

#### 14 REVIEW

- › For checking a programme.

#### 15 C(LEAR)

- › For erasing track numbers from a programme.
- › For erasing favourite track selections.

#### 16 TRACK SELECT

- › For direct selection of:
  - Another track number during play.
  - A track number to start play with.
  - Track numbers during programming.

#### 17 S(TORE)

- › For storing disc and track numbers when compiling a programme.
- › For storing favourite selections.

#### 18 FTS

- › For activating the Favourite Track Selection circuit.

The keys of the remote control have the same function as the corresponding ones on the changer.

For the best reception of its signals you should aim the remote control as directly as possible at the REMOTE CONTROL-eye.

### THE INFORMATION ON THE DISPLAY (Fig. 6)

Each Compact Disc has, along with the music, a list of contents detailing the numbers of the tracks, the playing time of each track and the total playing time of the disc. The changer always scans this first and stores it in its memory in order, for instance, to provide information via the display.

#### PROGRAM

- › Lights up when a programme is stored in the changer's memory and whenever it is played.

#### FTS

- › Flashes after the FTS key has been pressed.
- › Flashes if there is an FTS programme of the disc to be played.
- › Lights up when a programme from the FTS memory is played.

#### SHUFFLE

- › Lights up when the tracks on the discs or in a programme are played in random order.

#### REVIEW

- › Lights up when you review a programme.

#### TRACK LAP

- › Lights up when the elapsed playing time of a track is shown (LAP = elapsed).

#### REM TRACK

- › Lights up when the remaining playing time of a track is shown (REM = remaining).

#### REM TOTAL

- › Lights up when the remaining playing time of a disc is shown.

#### ERROR

- › Lights up if you make a mistake when operating the changer.

#### DISC and ERROR

- › Both light if you try to start playback while the disc is loaded with the printed side facing upwards or if the disc is missing or damaged. If so, the number of the disc on the number indicator '1-6' goes out.

#### TRACK REPEAT

- › Lights up when a track is repeated.

#### REPEAT DISC

- › Lights up when a disc is repeated.

#### REPEAT ALL

- › Lights up when all discs are repeated.

#### '1-6'

- › Light up when the changer has been switched on.

#### PAUSE

- › Lights up when the changer is in the pause mode.

#### DISC

- › Indicates what disc is being played.

#### '▷'

- › Lights during playback.

#### '(((O)'

- › Lights up when the REMOTE CONTROL eye receives signals from the remote control.

#### TRACK

- › Indicates what track is being played.

#### INDEX

- › The numbers only change if the parts of a track have index numbers.

#### MIN and SEC

Indicate:

- › The elapsed playing time of a track (TRACK LAP).
- › The remaining playing time of a track (REM TRACK).
- › The remaining playing time of a disc (REM TOTAL).



## SWITCHING ON AND OFF (ON/OFF)

### Switching on

- Press ON/OFF.
- › The display lights up.
- › When there is a cartridge in the changer the number of the first disc appears above DISC and the number of the first track on it appears above TRACK.  
Play then starts automatically after 2 seconds.

### Switching off

- Press ON/OFF again.
- › All lights are extinguished.

### Warning!

Do not switch off the changer *until* the cartridge compartment has been closed.

## INSERTING DISCS INTO THE CARTRIDGE (Fig. 7-11)

- Open *one tray at a time*.
- Place the disc in the tray *with the printed side facing downwards*.
- Close each tray *before* opening another one.

### Warning!

- This cartridge is *only for home use* and *only 12-cm discs* should be inserted.
- A separate cartridge for 8-cm discs is available under type number SBC 3592.

## PLAYBACK (PLAY-PAUSE)

- Press OPEN/CLOSE to open the cartridge compartment.
- Push the cartridge into the changer (Fig. 12) as far *as it will go*.  
*You will then hear a click*.
- › The number of the first disc appears above DISC and the number of the first track on it appears above TRACK.
- › The cartridge compartment closes automatically after 2 seconds, the '▷' indication lights up and a few moments later playback starts.  
You can also start play with PLAY-PAUSE.
- › Above DISC and TRACK is always shown what disc and what track on it is being played.
- › After the last disc, play stops.
- › The '▷' indication goes out and above DISC and TRACK you will again see the number of the first disc and the number of the first track on it.
- Press OPEN/CLOSE to open the cartridge compartment and remove the cartridge.
- › The information disappears from the display.
- › The cartridge compartment closes automatically after 2 seconds.  
You may also close it by pressing OPEN/CLOSE.

## CHANGING TO PLAYING TIME INDICATION (TRACK/TIME)

- Press TRACK/TIME.
- › The TRACK LAP indication lights up.
- › Above MIN and SEC you will see the elapsed playing time of the track being played.
- Press TRACK/TIME again whenever you want to know the remaining playing time of the track.
- › The REM TRACK indication lights up.
- Press TRACK/TIME once more if you wish to know the remaining playing time of the entire disc.
- › The REM TOTAL indication lights up.
- Press TRACK/TIME a fourth time if you wish to return to track/Index number indication.

## GOING BACK TO THE BEGINNING OF A TRACK (◀ TRACK ▶)

- Press '◀'.
- › The track starts again from the beginning.

## SELECTING ANOTHER TRACK DURING PLAY

(TRACK SELECT or ◀ TRACK ▶)

- Key in the required number (numbers consisting of two figures must be keyed in *within two seconds*) or press '▶' or '◀' until the number appears on the display.
  - › The music stops and a moment later the selected track begins to play.
- If you key in a non-existent number, then ERROR appears and play continues as normal.
- If you press '▶' while playing the last track of a disc, the first one will be played.
- If you press '◀' while playing the first track of a disc, the last one will be played.

## SELECTING ANOTHER DISC DURING PLAY

(DISC SELECT or – DISC +)

- Key in the number of the required disc or press '–' or '+' until the number appears above DISC.
  - › The music stops and a moment later the selected disc begins to play.
- If you press '+' while playing the last disc, the first one will be played.
- If you press '–' while playing the first disc, the last one will be played.

## SEARCHING FOR A PARTICULAR PASSAGE DURING PLAY

('◀◀ ▶▶')

- Hold '◀◀' down to search backwards to the beginning.
  - Hold '▶▶' down to search forwards to the end.
- As soon as the key is released play restarts at once.
- As soon as you reach the beginning of the first track on a disc, ERROR appears. Play will resume there as soon as you release the key.
- If you reach the end of the last track on a disc, ERROR will also appear. If you then release the key, play will resume a few seconds before the end of the disc.
- At this searching speed the sound remains audible.

## RAPID SEARCH FOR A PASSAGE (FAST and '◀◀ ▶▶')

- Press FAST.
  - › 'FAST' lights up.
  - Now press '▶▶' or '◀◀' *within 2 seconds*.
  - Hold the key pressed down; if you release the key for a moment, search will recommence at the slowest speed.
- At the fast searching speed no sound is audible.

## BEGINNING WITH A DISC OTHER THAN THE FIRST

(DISC SELECT or – DISC + and PLAY-PAUSE)

- Key in the number of the required disc or press '–' or '+' until the number appears above DISC.
- Press PLAY-PAUSE.
- › The '▷' indication lights up and play begins with the selected disc.

## BEGINNING WITH A TRACK NUMBER OTHER THAN THE FIRST

(TRACK SELECT or ◀ TRACK ▶ and PLAY-PAUSE)

- Key in the number of the required disc or press '–' or '+' until the number appears above DISC.
  - Key in the the required track number (numbers consisting of two figures must be keyed in *within two seconds*) or press '▶' or '◀' until the number appears above TRACK.
  - Press PLAY-PAUSE.
  - › The '▷' indication lights up and play begins with the selected track.
- If you select a non-existent track number, then ERROR appears and play starts at the beginning of the selected disc.

### RANDOM PLAYBACK (SHUFFLE)

- Before or during play, press SHUFFLE.
    - › The SHUFFLE indication lights up.
    - › All tracks are now played in a random order.
- If you also press REPEAT twice then play is repeated in a different order each time.
- If you press '▶' then play continues with any other track.
- If you press '◀' then the track playing is restarted.
- Searching for a particular passage is limited to within the track being played.
- Press SHUFFLE again if you wish to return to normal play.
    - › The SHUFFLE indication goes out.
- 

### BRIEFLY INTERRUPTING PLAYBACK/HOLDING PLAY AT THE START OF A DISC, TRACK OR PASSAGE (PLAY-PAUSE)

#### To briefly interrupt playback

- Press PLAY-PAUSE.
  - › The PAUSE indication lights up.
  - › The sound stops but the disc continues to spin.
- Press PLAY-PAUSE again to restart.
  - › The PAUSE indication goes out.
  - › Play restarts at the point where it was interrupted.

#### Holding play at the start of a disc, track or passage

You can go to any place on a disc and hold it by pressing PLAY-PAUSE before:

- starting to play a disc;
- going back to the beginning of a track;
- selecting another disc or track;
- searching for a particular passage;
- beginning with a disc or track other than the first one.

Press PLAY-PAUSE again to start play at the chosen place.

---

### REPEATING A TRACK (REPEAT)

- Before or during play, press REPEAT.
    - › The TRACK REPEAT indication lights up.
    - › The track will now be replayed continuously.
  - To stop repeat, press REPEAT three times.
    - › The TRACK REPEAT indication goes out.
    - › Play continues as normal.
- 

### REPEATING A DISC (REPEAT)

- Before or during play, press REPEAT twice.
    - › The REPEAT DISC indication lights up.
    - › The disc will now be replayed continuously.
  - To stop repeat, press REPEAT twice again.
    - › The REPEAT DISC indication goes out.
    - › Play continues as normal.
- 

### REPEATING ALL DISCS (REPEAT)

- Before or during play, press REPEAT three times.
    - › The REPEAT ALL indication lights up.
    - › All discs will now be replayed continuously.
  - To stop repeat, press REPEAT again.
    - › The REPEAT ALL indication goes out.
    - › Play continues as normal.
- 

### STOPPING PLAYBACK (STOP/CM or OPEN/CLOSE)

- Press STOP/CM if you merely wish to stop.
    - › The '▷' indication goes out and above DISC and TRACK you will again see the number of the first disc and the number of the first track on it.
  - Press OPEN/CLOSE if you wish to stop and take out the cartridge.
    - › The information disappears from the display.
- 

## PROGRAMMING

By programming the changer you can play up to 30 tracks in any required sequence. If you exceed the maximum of 30 tracks, ERROR appears.

---

### STORING A PROGRAMME

#### Before playback

- Key in the number of the required disc or press '-' or '+' until the number appears above DISC.
- Key in the first track number you wish to programme (numbers consisting of two figures must be keyed in *within two seconds*) or press '▶' or '◀' until the number appears above TRACK.
- Press STORE.
  - › The PROGRAM indication lights up and 'P 1' appears; the track number has now been stored in the changer's memory.
- Select the remaining required track numbers of the disc and store each number by pressing PROGRAM.
- › Each time a track has been stored 'P' will appear along with the number of tracks stored.
- If you wish to store tracks from another disc, you must first enter the number of that disc.

#### During playback

- Press STORE with every track number you wish to include in the programme.
    - › Each time a track has been stored 'P' will appear along with the number of tracks stored.
- 

### CHECKING THE PROGRAMME

- Press REVIEW.
    - › The REVIEW indication lights up.
    - › All the disc and track numbers appear in the programmed sequence on the display.
- You can review a programme prior to or during programmed play. If ERROR appears nothing has been stored.
- 

### ERASING A TRACK NUMBER FROM THE PROGRAMME OR THE ENTIRE PROGRAMME

- Press REVIEW.
    - › The REVIEW indication lights up.
    - › All the disc and track numbers appear in the programmed sequence on the display.
  - Press CLEAR when the track number you wish to erase appears.
  - Press STOP/CM if you wish to erase the entire programme.
- 

### PLAYING THE PROGRAMME

- Press PLAY-PAUSE.
    - › The '▷' indication lights up and play starts with the first item of the programme.
    - › As play continues the following numbers in the sequence appear.
- All keys (except DISC SELECT, - DISC + and TRACK SELECT) can be used during the playback of a programme.
- Searching for a particular passage is limited to within the track being played.
- When STOP/CM is pressed or when all the tracks of the programme have been played, the disc stops, but the programme remains stored.
- The programme will be erased if you press OPEN/CLOSE. It will also be erased if you press STOP/CM twice in succession *during playback*.
-

## FAVOURITE TRACK SELECTION (FTS)

You can also transfer the programme of a particular disc to the permanent (FTS) memory of the changer. You can then call up and play your favourite selection from this disc at any time.

The selection remains stored in the FTS memory, even if you play the entire disc or compile another programme from it. Every disc is assigned a ranking number in the FTS memory which is shown on the display.

The number of discs you can store in the FTS memory is dependent on the number of tracks per programme.

### **Note!**

FTS must always be used together with other keys. Press the next key *within 5 seconds*, otherwise the FTS indication stops flashing. Press the FTS key again to reactivate the command.

---

### STORING FAVOURITE SELECTIONS

- Compile your programme as described under 'PROGRAMMING'.
- Press PLAY-PAUSE to play the programme.
- Press FTS for every disc of which you wish to store the programme in the FTS memory.
  - › The FTS indication starts flashing.
- Press STORE.
  - › The display shows the ranking number of this programme.
  - › Your favourite selection is now stored in the FTS memory under this ranking number.
- Stick the FTS sticker with the ranking number on the spine of the disc holder.

If a favourite selection of a particular disc had already been stored, then it is automatically erased and the new selection is stored under the old ranking number.

If ERROR appears after pressing STORE, it can be for one of the following reasons:

- The FTS memory is full, or there are no more ranking numbers available: You must now erase the entire FTS memory in order to provide space for the new programme. All ranking numbers then become available again.
  - You have not pressed PLAY-PAUSE first to play the programme.
  - No programme has been compiled.
- 

### PLAYING FAVOURITE SELECTIONS

- Press FTS.
  - › The FTS indication starts flashing.
- Press PLAY-PAUSE.
  - › The FTS indication now stays lit up.
  - › The favourite track selections of all discs in the cartridge are now played in succession.
  - › Before a selection is played its ranking number appears first on the display.

If ERROR appears no favourite selection has been stored.

- Press FTS and STOP/CM if you want to revert to normal play. All keys (except TRACK SELECT and SHUFFLE) can be used during the playback of a favourite selection.

Searching for a particular passage is limited to within the track being played.

---

### ERASING A FAVOURITE SELECTION FOR ONE SINGLE DISC

- Keep FTS *on the changer* pressed and in the meantime press '▶' or '◀' until the ranking number appears on the display.
- While still keeping FTS pressed, press CLEAR.
  - › '000' appears briefly on the display.
  - › The selection has now been erased.

### If you do not know the ranking number of a selection:

- Select the disc number using DISC SELECT or - DISC +.
  - Press FTS and PLAY-PAUSE.
    - › The ranking number appears on the display.
  - Note the ranking number.
  - You can now erase the selection as described above.
- 

### ERASING ALL FAVOURITE SELECTIONS AT ONCE

- Press FTS.
    - › The FTS indication starts flashing.
    - › Now immediately press REPEAT and CLEAR.
    - › The FTS indication keeps on flashing.
    - › When the entire FTS memory has been erased '000' appears briefly on the display.
    - › All ranking numbers are now available again.
-

## ADDITIONAL INFORMATION

### LISTENING WITH HEADPHONES (PHONES)

Connect headphones having a 6.3 mm jack plug and an impedance between 8 and 2000 ohms to the PHONES socket. The sound level you hear is dependent on the impedance of the headphones and the signal level on the disc itself.

### ATTACHING THE STICKERS TO THE CARTRIDGE (fig. 13-14)

The stickers can be used for:

- Noting disc titles, names of artists etc. on the storage case ('A' and 'C') and the cartridge itself ('B' and 'C').
- Numbering, alphabetizing and classifying different cartridges ('D', 'E', 'F' and 'G').

- Attach the stickers at the places indicated.

Should you attach them elsewhere this may hamper the functioning of the changer or the cartridge.

Do not place stickers on top of each other. Only the stickers 'D', 'E', 'F' and 'G' can be placed on top of the 'C' stickers.

### ACCESSORY CARTRIDGES

The following accessory cartridges are available through your dealer:

Type number	Description
SBC 3591	Cartridge for one 12-cm disc
SBC 3590	Cartridge for six 12-cm discs
SBC 3592	Cartridge for six 8-cm discs

### CARE OF THE DISCS

Although both sides of a disc are protected by a special coating, it is still advisable to treat the discs with care:

- Never leave discs lying around, put them back in their holders immediately after use.
- Never write on the printed side!
- Do not attach any stickers on the disc.
- Keep the shiny surface of the disc clean. Use a soft lint-free cloth and always wipe the disc in a straight line from centre to edge. You may breath lightly on the disc first.

The cleaning set SBC 3540, available separately, is a useful accessory for cleaning your discs. It contains a protective support, a special disc cleaning cloth and a bottle of cleaning fluid.

### Warning!

Cleaning agents for conventional records are not suitable for cleaning a Compact Disc. Nor may detergents or abrasive cleaning agents be used.

### CHANGER MAINTENANCE

A chamois leather slightly moistened with water is sufficient for cleaning the changer. Do not use cleaning agents containing alcohol, spirits, ammonia or abrasives.

The disc trays should be kept free of dust with a dry cloth.

## TECHNICAL DATA

### Typical Audio Performance

Frequency range: 2 Hz-20 kHz

Amplitude linearity:  $\pm 0.02$  dB (20 Hz-20 kHz)

Phase linearity:  $\pm 0.5^\circ$  (20 Hz-20 kHz)

Dynamic range:  $> 90$  dB (20 Hz-20 kHz)

Signal-to-noise ratio:  $> 100$  dB (20 Hz-20 kHz)

Channel separation: 100 dB (1 kHz)

Total harmonic distortion: 0.0015% (1 kHz)

Wow and flutter: quartz crystal precision

D/A conversion: quadruple oversampling (176.4 kHz) with digital filter and two 16-bit D/A-converters

Audio output level:  $2 V_{\text{rms}}$

Impedance PHONES socket: 8-1000 ohms

### Power supply

Mains voltage and frequency: see the type plate on the rear of the changer

Power consumption: 15 W approx.

Safety requirements: IEC 65

### Cabinet

Material/finish: metal and polystyrene with decorative trim

Dimensions (w x h x d): 420 x 87 x 310 mm

Weight: 5.5 kg approx.

### Subject to modification

***This Compact Disc changer complies with radio interference requirements as laid down in EC regulations.***

## FAULTS AND THEIR LIKELY CAUSES

Insufficient familiarity with the combination of a new product and new discs may lead to faults arising during use. These are generally caused by simple errors in operation or external factors. It is perhaps useful to check the points listed below and where possible remedy these before taking your changer for repair.

- The transit clamps have not been removed.
- Condensation has formed on the lens of the laser due to a dramatic change in temperature. This will disappear automatically after some time.
- There is a foreign object in the disc tray.
- The disc has not been inserted with the printed side down or there is no disc in the tray.
- The disc is dirty, badly scratched or warped.
- The changer has been connected to the PHONO socket of the amplifier.

If the fault remains, try to clear it by switching the changer off and on again.

If this also fails to help, do not continue experimenting, but remove the plug from the wall socket and consult your dealer.

Certain faults may be caused by a disc. In order to help determine the precise cause, take the disc with which the fault occurred with you when you take the changer for repair.

***Under no circumstances should you open up the changer yourself, as this will invalidate the guarantee!***



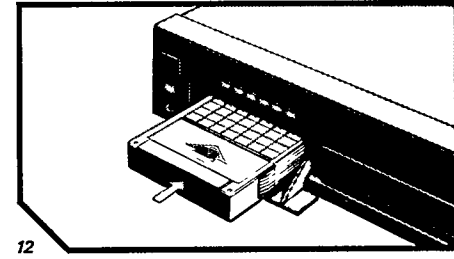
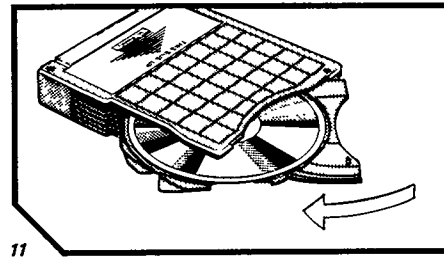
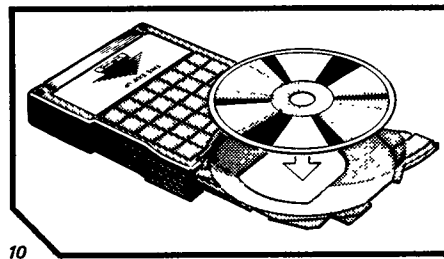
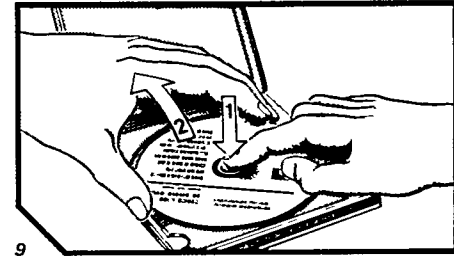
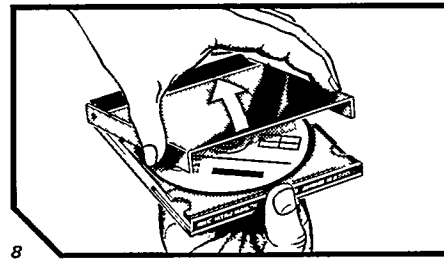
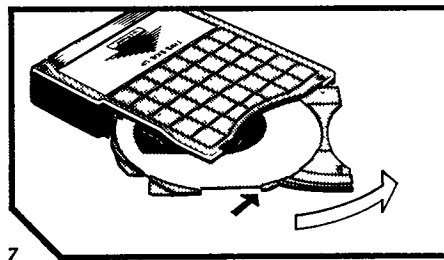
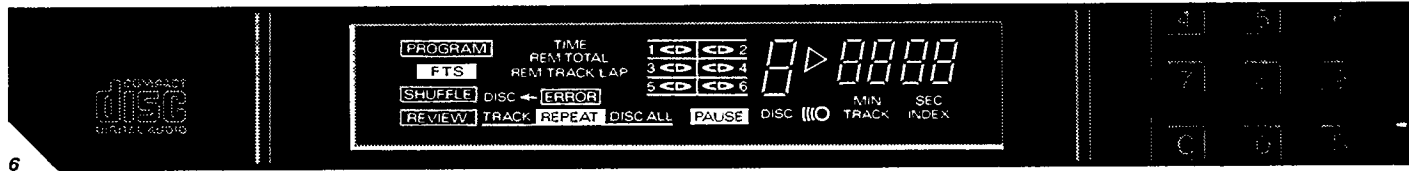
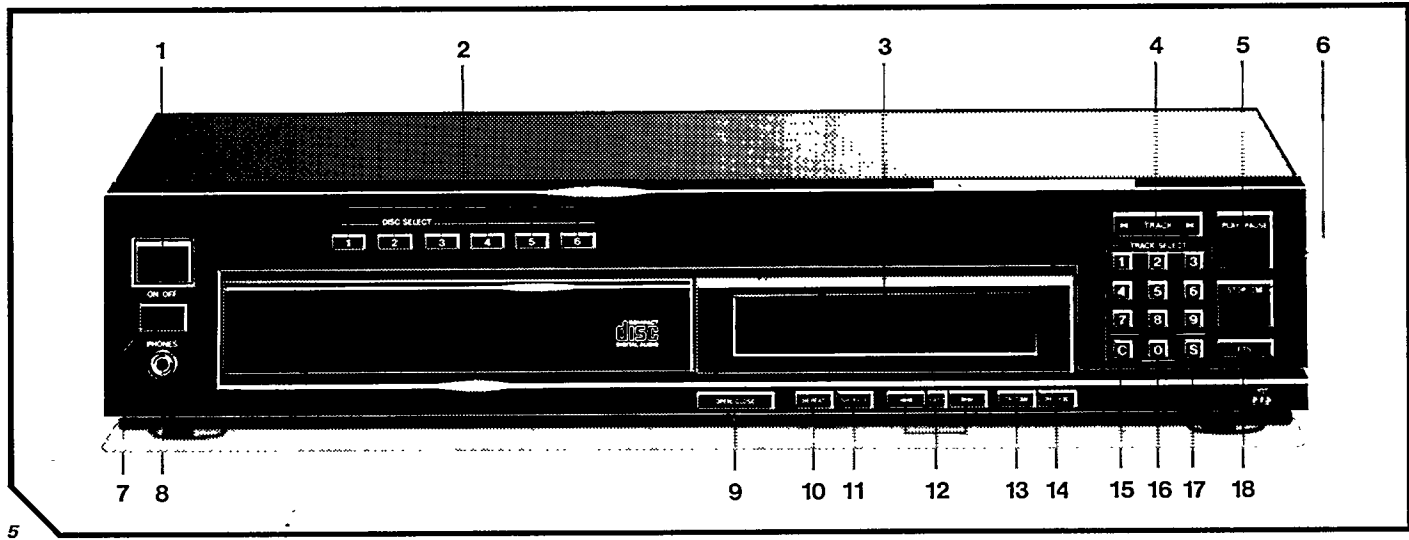
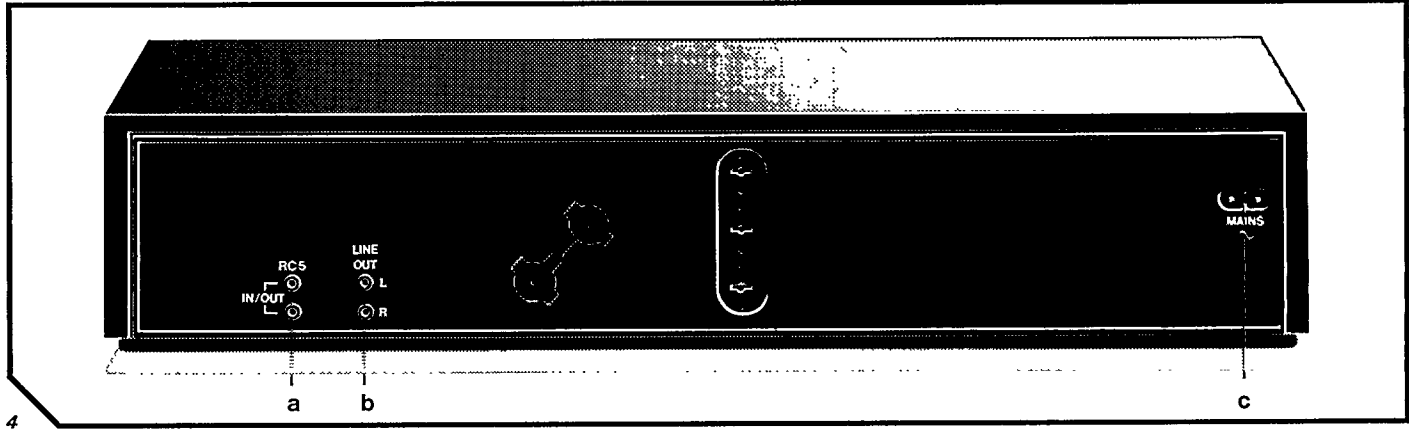
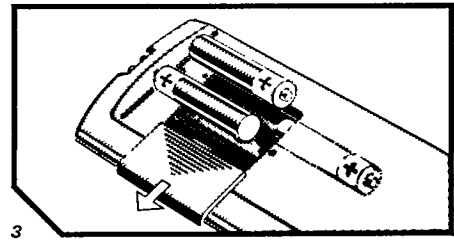
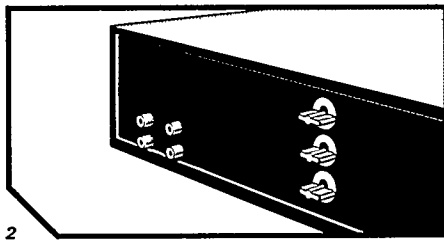
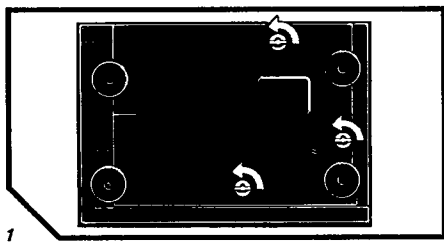

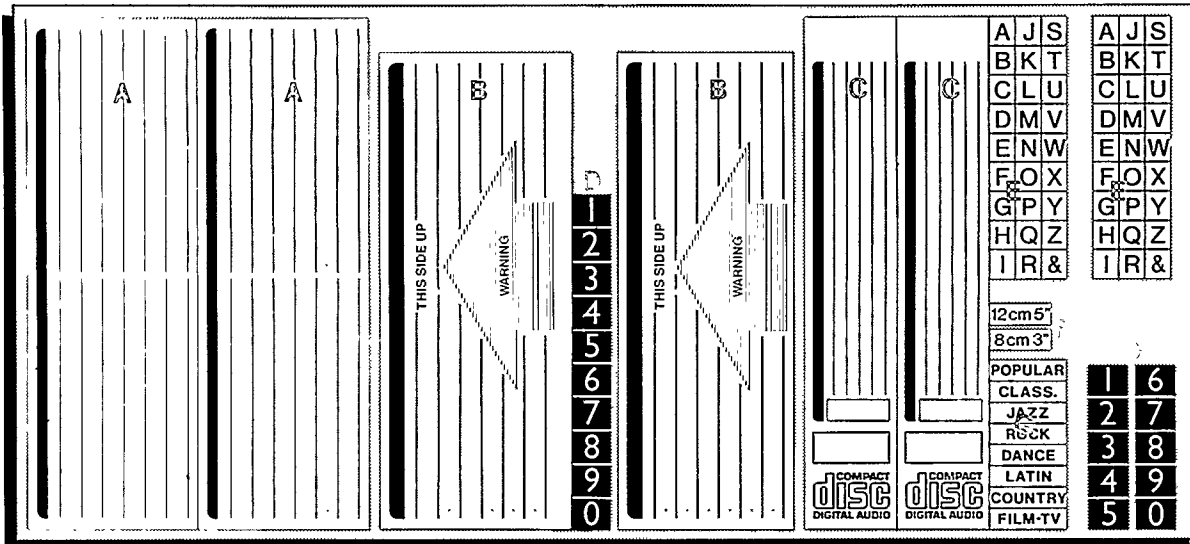

13

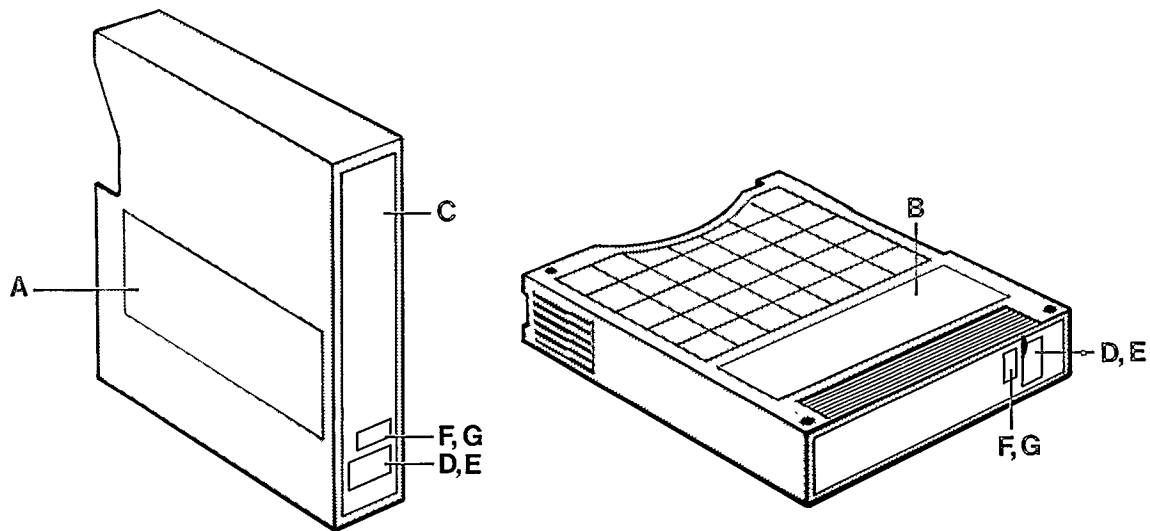

14





## Free Manuals Download Website

<http://myh66.com>

<http://usermanuals.us>

<http://www.somanuals.com>

<http://www.4manuals.cc>

<http://www.manual-lib.com>

<http://www.404manual.com>

<http://www.luxmanual.com>

<http://aubethermostatmanual.com>

Golf course search by state

<http://golfingnear.com>

Email search by domain

<http://emailbydomain.com>

Auto manuals search

<http://auto.somanuals.com>

TV manuals search

<http://tv.somanuals.com>