

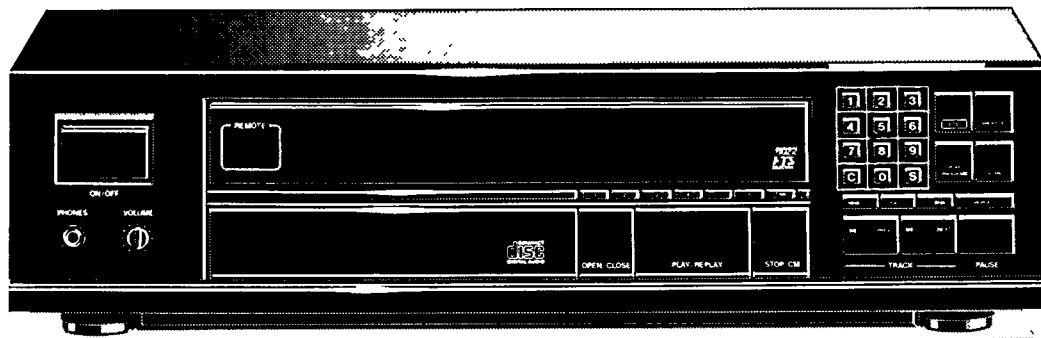

CONSUMER ELECTRONICS

PHILIPS



CDC 875

GB

Compact Disc Changer

F

Changeur de Disques Compacts

D

Compact Disc-Wechsler

NL

Compact Disc-Wisselaar

E

Cambiador 'Compact Disc'

I

CambiaCompact Disc

DK

Compact Disc-Skifter

S

Compact Disc-Växlare

SF

Compact Disc -Levynvaihdin

English

Figures

page 1

page 66-67

Français

Figures

page 8

page 66-67

Deutsch

Abbildungen

Seite 15

Seite 66-67

Nederlands

Figuren

pagina 22

pagina 66-67

Español

Figuras

página 29

página 66-67

Italiano

Figure

pagina 36

pagina 66-67

Dansk

Figurer

side 43

side 66-67

Svenska

Figurer

sida 50

sida 66-67

Suomi

Kuvat

sivu 57

sivu 66-67



English

INTRODUCTION

The Compact Disc system is a major step forward in the sphere of audio technology. By employing the most sophisticated digital and optical technologies, Compact Disc not only produces the ultimate in sound reproduction, it also offers unprecedented ease of operation, with rapid access to every track on the disc and the possibility of programming.

CONTENTS

	Pag.
INSTALLATION	1
OPERATION	2-5
PROGRAMMING	5
FAVOURITE TRACK SELECTION	6
ADDITIONAL INFORMATION	7
FAULTS AND THEIR LIKELY CAUSES	7
ILLUSTRATIONS	66-67

INSTALLATION

UNPACKING

With this changer are supplied:

- a power supply lead;
 - a connection cable;
 - a remote control;
 - batteries for the remote control;
 - a cartridge for six Compact Discs.
 - Remove all packaging materials from the changer and the accessories.
-

CHECKING THE POWER SUPPLY SETTING

- Check that the type plate on the rear of your changer indicates the correct supply voltage.
 - If your mains supply voltage is different, consult your dealer or our Service Organisation.
-

REMOVING THE TRANSIT CLAMPS (Fig. 1-2)

The three red transit clamps on the bottom lock the play mechanism to protect it during transportation.

- Turn the changer upside down.
 - Turn the clamps anti-clockwise and withdraw them from the changer.
 - Store them in the recesses provided on the rear of the changer. If you want to transport the changer, reinsert the clamps and rotate them clockwise until they lock in position.
-

INSERTING AND REPLACING THE BATTERIES IN THE REMOTE CONTROL (Fig. 3)

- Open the battery compartment.
- Insert the three batteries according to the diagram in the compartment.
- Replace the cover.

The life of the batteries is around one year. Remove them when they are flat or when you are not intending to use the remote control for some time. In this way you will prevent damage to the remote control by possible battery leakage.

For replacement only use batteries of the type R03, UM4 or AAA.

SITING THE CHANGER

Free-standing

- Always position the changer horizontally on a flat, firm surface.
- Allow a free space of at least 3 cm above the changer so as not to interfere with the cooling of the changer.

In an audio rack

- The changer can be sited in any desired position.

Stacked

- Site the changer preferably at the bottom or at the top.
- Never position the changer directly on top of a high-power amplifier, as such an amplifier gives off a substantial amount of heat.

Warning!

Never stand the changer in persistent direct sunlight or near any heat source.

CONNECTIONS (Fig. 4)

a SYSTEM REMOTE CONTROL IN/OUT: for a remote control system.

Use this connection for:

- Connecting up the equipment when you are incorporating the changer in a PHILIPS HiFi system with its own remote control system.

- Connecting the remote control receiver EM 2200, available as an accessory, if the siting of the changer prevents its REMOTE eye from receiving the signals from the remote control directly.

b DIG OUT: for digital signal processing or future applications such as CD-I.

c ANALOGUE OUT:

FIX: for connection to a PHILIPS amplifier or HiFi system with its own remote control.

VAR: for connection to an amplifier or HiFi system without its own remote control.

- Insert a red plug into the 'R' socket (right-hand channel) and the other plug into the 'L' socket (left-hand channel) of the FIX output or the VAR output. In the case of connection via the VAR output, the sound level can be adjusted with the - VOLUME + keys on the remote control.

- Insert the two other plugs into the corresponding sockets of the CD or AUX input of your amplifier.

You can also use the TUNER or TAPE IN connection, but *never* the PHONO input. This is not suitable for Compact Disc reproduction.

d Connection for the mains lead.

OPERATION

EXPLANATION OF KEYS ETC. (Fig. 5)

1 ON/OFF

- › For switching on and off. The blue light above serves as on/off indication.

2 REMOTE

- › Receives the signals from the remote control.

3 DISPLAY

- › Informs you about the functioning of the changer.
- › Displays details from the disc contents list.
See also: 'The information on the display'.

4 '1-6' disc number keys

- › For selecting another disc during play.
- › For selecting a disc to start play with.
- › For selecting discs during programming.

5 TIME

- For selecting which time information you wish to see:
- › TRACK LAP: The elapsed playing time of a track (LAP = elapsed).
- › REM TRACK: The remaining playing time of a track (REM = remaining).
- › REM TOTAL: The remaining playing time of an entire disc.

6 CLEAR

- › For erasing track numbers from a programme.
- › For erasing favourite track selections.

7 '1-0' digit keys

- › For selecting another disc or track number during play.
- › For selecting a disc or track number to start play with.
- › For selecting disc and track numbers during programming.

8 STORE

- › For storing disc and track numbers when compiling a programme.

9 FTS

- › For activating the Favourite Track Selection circuit.

10 SHUFFLE

- › For playing in random order.

11 PLAY PROGRAM

- › For direct selection and play (PLAY) or direct programming (PROGRAM) of discs and tracks.

12 SCAN

- › For automatically playing the beginning of each track.
- › For checking a programme (REVIEW).

13 PHONES

- › For connection of headphones.
- See also: 'Listening with headphones'.

14 VOLUME

- › For adjusting the volume when listening with headphones.

15 OPEN/CLOSE

- › For opening and closing the cartridge compartment.
- › For ejecting the cartridge.

16 PLAY/REPLAY

- › For starting play (PLAY).
- › For returning to the beginning of a track (REPLAY).

17 STOP/CM

- › For stopping play (STOP).
- › For erasing a programme (CM = Clear Memory).

18 ◀◀ ▶▶

- › For fast search to a particular passage during play (◀◀ backwards and ▶▶ forwards).
When used in conjunction with FAST, the search speed is increased.

19 ◀ PREV TRACK ▶ NEXT

- › For selecting another track number during play.
- › For selecting a track number to start play with.
- › For selecting track numbers during programming.
(◀ PREV from high to low and ▶ NEXT from low to high.)

20 PAUSE

- › For interrupting play.
- › For holding play at the start of a disc, track or passage.

21 REPEAT

- › For repeating a track, a disc, all discs, or a programme.

Most of the controls also appear on the remote control. The functions below can only be operated using the remote control:

– VOLUME +

- › For adapting the sound level when the changer is connected via the ANALOGUE OUT VAR sockets to an amplifier or HiFi system without its own remote control.

SELECT

For choosing the SELECT setting. Data can then be entered using the digit keys for:

- › Selecting another disc during play.
- › Selecting a disc to start play with.
- › Selecting discs during programming.

A → B

- › For setting the starting and stopping point of a passage to be repeated.

– DISC +

- › For selecting another disc during play.
- › For selecting a disc to start play with.
- › For selecting discs during programming.
('–' from high to low and '+' from low to high.)

For the best reception of the signals from the remote control you should aim it as directly as possible at the REMOTE eye.

THE INFORMATION ON THE DISPLAY (Fig. 6)

Each Compact Disc has, along with the music, a list of contents detailing the numbers of the tracks, the playing time of each track and the total playing time of the disc. The changer always scans this first and stores it in its memory in order, for instance, to provide information via the display.

(((O

› Lights up when the REMOTE eye receives signals from the remote control.

+20

› Lights up if there are more than 20 tracks on a disc.

1-20

› As soon as a disc contents list has been scanned by the changer, the numbers of the tracks on the disc remain lit. As soon as a track has been played its number goes out on the number indicator.

PLAY

› Lights up next to MODE when the changer is set to the direct play mode.

PROG

› Lights up next to MODE when the changer is set to the direct programming mode.

TRACK LAP

› Lights up when the elapsed playing time of a track is shown.

REM TRACK

› Lights up when the remaining playing time of a track is shown.

REM TOTAL

› Lights up when the remaining playing time of a disc is shown.

TRACK REPEAT

› Lights up when a track is repeated.

REPEAT DISC

› Lights up when a disc is repeated.

REPEAT ALL

› Lights up when all discs are repeated.

PROGRAM

› Lights up when a programme is stored in the changer memory and whenever it is played.

SHUFFLE

› Lights up when the tracks on the discs or in a programme are played in random order.

REVIEW

› Lights up when you review a programme.

FTS

› Flashes after the FTS key has been pressed.

› Flashes briefly if there is an FTS programme of the disc to be played.

› Lights up when a programme from the FTS memory is played.

SCAN

› Lights up when the beginning of each track is played automatically.

ERROR

› Lights up if you make a mistake when operating the changer.

PAUSE

› Lights up when the changer is in the pause mode.

A - B

› Lights up when a passage is repeated.

› Flashes until the stopping point of the passage is set.

DISC

› Lights up if you try to start playback while the disc is loaded with the printed side facing upwards or if the disc is missing or damaged.

The CD indication above the disc number key also goes out.

DISC and TRACK

› Indicate which disc and which track on it is being played.

MIN and SEC

Indicate:

› The elapsed playing time of a track (TRACK LAP).

› The remaining playing time of a track (REM TRACK).

› The remaining playing time of a disc (REM TOTAL).

SWITCHING ON AND OFF (ON/OFF)

Switching on

● Press ON/OFF.

› The display and the on/off indication light up.

› When there is a cartridge in the changer the number of the first disc appears under DISC and the number of the first track on it appears under TRACK.

Play then starts automatically after 2 seconds.

Switching off

● Press ON/OFF again.

› All lights are extinguished.

Warning!

Do not switch off the changer *until* the cartridge compartment has been closed.

INSERTING DISCS INTO THE CARTRIDGE (Fig. 7-10)

● Open *one tray at a time*.

● Place the disc in the tray *with the printed side facing downwards*.

● Close each tray *before* opening another one.

Warning!

› This cartridge is *only for home use*.

› *Only 12-cm discs* should be inserted.

› Should you wish to insert 8-cm discs (CD singles), they should *first* be adapted by means of adapter rings (Fig. 11). For this purpose *only* use adapter rings of the type SBC 3580.

A separate cartridge for 8-cm discs is also available.

PLAYBACK (PLAY/REPLAY)

● Press OPEN/CLOSE to open the cartridge compartment.

● Insert the cartridge into the changer (Fig. 12).

› The number of the first disc appears under DISC and the number of the first track on it appears under TRACK.

› The cartridge compartment closes automatically after 2 seconds and a few moments later playback starts.

You can also start play with PLAY/REPLAY.

› The number indicator shows how many tracks are on the disc.

› When a track has been played its number disappears.

› Under DISC and TRACK is always shown what disc and what track on it is being played.

› Under MIN and SEC the elapsed playing time of the track being played is always shown. TRACK LAP also remains lit.

› After the last disc, play stops.

› Under DISC and TRACK you will again see the number of the first disc and the number of the first track on it.

● Press OPEN/CLOSE to open the cartridge compartment and remove the cartridge.

› The information disappears from the display and the entire number indicator lights up.

› The cartridge compartment closes automatically after 2 seconds. You may also close it by pressing OPEN/CLOSE.

ADAPTING THE SOUND LEVEL (- VOLUME +)

● Press - VOLUME.

› The volume which has been set at the amplifier decreases in steps to a set level.

● Press VOLUME +.

› The volume now increases in the same steps to the originally set level.

Warning!

- The volume setting selected using - VOLUME + is cancelled when the changer is switched off.

-- - VOLUME + affects the signal strength of the changer.

For this reason these keys should not be used when making recordings.

CHANGING TO ANOTHER KIND OF TIME INFORMATION (TIME)

- Press TIME whenever you want to know the remaining playing time of a track.
 - › The REM TRACK indication lights up.
 - Press TIME again if you wish to know the remaining playing time of an entire disc.
 - › The REM TOTAL indication lights up.
 - Press TIME once more if you wish to return to elapsed playing time indication.
 - › The TRACK LAP indication lights up again.
-

GOING BACK TO THE BEGINNING OF A TRACK

(PLAY/REPLAY)

- Press PLAY/REPLAY.
 - › The track starts again from the beginning.
-

SELECTING ANOTHER TRACK DURING PLAY

With the '1-0' digit keys

- Key in the required number. Numbers consisting of two figures must be keyed in *within one second*.
 - › TRACK begins to flash.
 - › The music stops and a moment later the selected track begins to play.

If you key in a non-existent number, then ERROR appears and play continues as normal.

With ◀ PREV TRACK ▶ NEXT

- Press ◀ PREV or ▶ NEXT until the required number appears under TRACK.
 - › The music stops and a moment later the selected track begins to play.

If you press ▶ NEXT while playing the last track of a disc, the first one will be played.

If you press ◀ PREV while playing the first track of a disc, the last one will be played.

SELECTING ANOTHER DISC DURING PLAY

With the '1-6' disc number keys

- Key in the number of the required disc.
 - › The number appears under DISC.
 - › The music stops and a moment later the selected disc begins to play.

With – DISC +

- Press '–' or '+' until the required number appears under 'DISC'.
 - › The music stops and a moment later the selected disc begins to play.

If you press '+' while playing the last disc, the first one will be played.

If you press '–' while playing the first disc, the last one will be played.

With SELECT and the '1-0' digit keys

- Press SELECT.
 - › DISC begins to flash.
 - Key in the number of the required disc.
 - › The number appears under DISC.
 - › TRACK begins to flash.
 - Key in the required track number. Numbers consisting of two figures must be keyed in *within one second*.
 - › The number appears under TRACK.
 - › The music stops and a moment later the selected disc and track begin to play.
-

SEARCHING FOR A PARTICULAR PASSAGE DURING PLAY

(◀◀ ▶▶)

- Hold ◀◀ down to search backwards to the beginning.

- Hold ▶▶ down to search forwards to the end

As soon as the key is released play restarts at once.

As soon as you reach the beginning of the first track on a disc, ERROR appears. Play will resume there as soon as you release the key. If you reach the end of the last track on a disc, ERROR will also appear. If you then release the key, play will resume a few seconds before the end of the disc.

At this searching speed the sound remains audible.

RAPID SEARCH FOR A PASSAGE (FAST and ◀◀ ▶▶)

- Press FAST.

› FAST lights up.

- Now press ▶▶ or ◀◀ *within 2 seconds*.

- Hold the key pressed down; if you release the key for a moment, search will recommence at the slowest speed.

At the fast searching speed no sound is audible.

SCANNING THE DISCS (SCAN)

- Before or during play, press SCAN.

› The SCAN indication lights up.

› The first 10 seconds of each track are played in turn.

› After the last track on the last disc scanning starts again with the first disc.

› Press SCAN again at a track you wish to hear in full.

› The SCAN indication goes out.

› Play continues as normal.

During the scan, it is possible to use the '1-6' disc number keys, – DISC +, the '1-0' digit keys and TRACK.

BEGINNING WITH A DISC OTHER THAN THE FIRST

- Select the number of the required disc using:

– One of the '1-6' disc number keys,

– – DISC + or,

– SELECT and the '1-0' digit keys.

- Press PLAY/REPLAY.

› Play will start with the selected disc.

BEGINNING WITH A TRACK NUMBER OTHER THAN THE FIRST

With the '1-0' digit keys

- Select the number of the disc you want to start with.

- Key in the required track number. Numbers consisting of two figures must be keyed in *within one second*.

› TRACK begins to flash.

› Play begins with the selected track.

With ◀ PREV TRACK ▶ NEXT

- Select the number of the disc you want to start with.

- Press ▶ NEXT or ◀ PREV until the required track number appears under TRACK.

- Press PLAY/REPLAY.

› Play begins with the selected track.

RANDOM PLAYBACK (SHUFFLE)

- Before or during play, press SHUFFLE.

› The SHUFFLE indication lights up.

› All tracks are now played in a random order.

- Press SHUFFLE again if you wish to return to normal play.

› The SHUFFLE indication goes out.

If you also press REPEAT twice then play is repeated in a different order each time.

If you press ▶ NEXT then play continues with any other track.

If you press ◀ PREV then the track playing is restarted.

Searching for a particular passage is limited to within the track being played.

BRIEFLY INTERRUPTING PLAYBACK/HOLDING PLAY AT THE START OF A DISC, TRACK OR PASSAGE (PAUSE)

To briefly interrupt playback

- Press PAUSE.
 - › The PAUSE indication lights up.
 - › The sound stops but the disc continues to spin.
- Press PAUSE again to restart.
 - › The PAUSE indication goes out.
 - › Play restarts at the point where it was interrupted.

Holding play at the start of a disc, track or passage

You can go to any place on a disc and hold it by pressing PAUSE before:

- starting to play a disc;
 - going back to the beginning of a track;
 - selecting another disc or track;
 - searching for a particular passage;
 - beginning with a disc or track other than the first one.
- Press PAUSE again to start play at the chosen place.

REPEATING A PASSAGE (A → B)

- During play press A → B at the required starting point.
 - › The A → B indication starts flashing.
- Press A → B again at the required stopping point.
 - › The A → B indication now remains lit continuously.
 - › The passage between points A and B will now be replayed continuously.
- Press A → B again to stop repeat.
 - › The A → B indication goes out.
 - › Play continues as normal.

To find the starting and stopping points quickly, you can use the ►► and ►| NEXT keys.

Starting and stopping points can only be set within one disc.

REPEATING A TRACK (REPEAT)

- Before or during play, press REPEAT.
 - › The TRACK REPEAT indication lights up.
 - › The track will now be replayed continuously.
- To stop repeat, press REPEAT three times.
 - › The TRACK REPEAT indication goes out.
 - › Play continues as normal.

REPEATING A DISC (REPEAT)

- Before or during play, press REPEAT twice.
 - › The REPEAT DISC indication lights up.
 - › The disc will now be replayed continuously.
- To stop repeat, press REPEAT twice again.
 - › The REPEAT DISC indication goes out.
 - › Play continues as normal.

REPEATING ALL DISCS (REPEAT)

- Before or during play, press REPEAT three times.
 - › The REPEAT ALL indication lights up.
 - › All discs will now be replayed continuously.
- To stop repeat, press REPEAT again.
 - › The REPEAT ALL indication goes out.
 - › Play continues as normal.

STOPPING PLAYBACK (STOP/CM or OPEN/CLOSE)

- Press STOP/CM if you merely wish to stop.
 - › The number of the first disc will again appear under DISC and the number of the first track on it under TRACK.
- Press OPEN/CLOSE if you wish to stop and take out the cartridge.
 - › The information disappears from the display and the entire number indicator lights up.

PROGRAMMING

By programming the changer you can play up to 30 tracks in any required sequence. If you exceed the maximum of 30 tracks, ERROR appears.

STORING A PROGRAMME

Before playback

- Press PLAY PROGRAM.
 - › PROG lights up next to MODE.
 - › The changer is now in the direct programming mode; every track number that you now key in is included directly in the programme.
- Select the number of the required disc.
- Key in the first required track number. Numbers consisting of two figures must be keyed in *within one second*.
 - › TRACK begins to flash.
 - › The PROGRAM indication lights up and 'P 1' appears; the track number has now been stored in the changer's memory.
- Key in the remaining required track numbers of the disc.
 - › Each time a track has been stored 'P' will appear along with the number of tracks stored.
- If you wish to store tracks from another disc, you must first enter the number of that disc.

During playback

- Press STORE with every track number you wish to include in the programme.
 - › Each time a track has been stored 'P' will appear along with the number of tracks stored.

CHECKING THE PROGRAMME

- With PLAY PROGRAM set the changer to the direct programming mode.
 - › PROG lights up next to MODE.
 - Press SCAN.
 - › The REVIEW indication lights up. All the disc and track numbers appear in the programmed sequence on the display.
- You can review a programme prior to or during programmed play. If ERROR appears nothing has been stored.

ERASING A TRACK NUMBER FROM THE PROGRAMME OR THE ENTIRE PROGRAMME

- With PLAY PROGRAM set the changer to the direct programming mode.
 - › PROG lights up next to MODE.
- Press SCAN.
 - › The REVIEW indication lights up. All the disc and track numbers appear in the programmed sequence on the display.
- Press CLEAR when the track number you wish to erase appears.
- Press STOP/CM if you wish to erase the entire programme.

PLAYING THE PROGRAMME

- With PLAY PROGRAM set the changer to the direct programming mode.
 - › PROG lights up next to MODE.
- Press PLAY/REPLAY.
 - › Play starts with the first item of the programme.
 - › As play continues the following numbers in the sequence appear. The number indicator always shows what track numbers of a particular disc have been stored.

All keys (except the '1-6' disc number keys and — DISC +) can be used during the playback of a programme.

Searching for a particular passage is limited to within the track being played.

As long as the changer is in the direct programming mode you can continue to add to the programme during playback.

When STOP/CM is pressed or when all the tracks of the programme have been played, the disc stops, but the programme remains stored.

The program will be erased if you press OPEN/CLOSE. It will also be erased if you press STOP/CM twice in succession *during playback*.

FAVOURITE TRACK SELECTION (FTS)

You can also transfer the programme for a particular disc to the permanent (FTS) memory of the changer. You can then call up and play your favourite selection from this disc at any time. The selection remains stored in the FTS memory, even if you play the entire disc or compile another programme from it. Every disc is assigned a ranking number in the FTS memory which is shown on the display. The number of discs you can store in the FTS memory is dependent on the number of tracks per programme.

Note!

FTS must always be used together with other keys. Press the next key *within 5 seconds*, otherwise the FTS indication stops flashing. Press the FTS key again to reactivate the command.

STORING FAVOURITE SELECTIONS

- Compile your programme as described under 'PROGRAMMING'.
- Press PLAY/REPLAY to play the programme.
- Press FTS for every disc of which you wish to store the programme in the FTS memory.
 - › The FTS indication starts flashing.
- Press STORE.
 - › The FTS indication now stays lit continuously.
 - › The display shows 'FtS' and the ranking number of this programme.
 - › Your favourite selection is now stored in the FTS memory under this ranking number.
- Stick the FTS sticker with the ranking number on the spine of the disc holder.

If a favourite selection of a particular disc had already been stored, then it is automatically erased and the new selection is stored under the old ranking number.

If ERROR appears after pressing STORE, it can be for one of the following reasons:

- The FTS memory is full, or there are no more ranking numbers available: You must now erase the entire FTS memory in order to provide space for the new programme. All ranking numbers then become available again.
- No programme has been compiled.

PLAYING FAVOURITE SELECTIONS

- With PLAY PROGRAM set the changer to the direct programming mode.
 - › PROG lights up next to MODE.
 - Press FTS.
 - › The FTS indication starts flashing.
 - Press PLAY/REPLAY.
 - › The FTS indication now stays lit up.
 - › The favourite track selections of all discs in the cartridge are now played in succession.
 - › Before a selection is played its ranking number appears first on the display.
- If ERROR appears no favourite selection has been stored.

● Press FTS and STOP/CM if you want to revert to normal play. All keys can be used during the playback of a favourite selection. Searching for a particular passage is limited to within the track being played.

As long as the changer is in the direct programming mode you can continue to add to the programme during playback.

ERASING A FAVOURITE SELECTION FOR ONE SINGLE DISC

- Keep FTS pressed and in the meantime press ◀PREV or ▶NEXT until the ranking number appears next to 'FtS'.
- While still keeping FTS pressed, press CLEAR.
 - › 'FtS 000' appears briefly on the display.
 - › The selection has now been erased.

If you do not know the ranking number of a selection:

- Select the disc number.
- Press FTS and PLAY/REPLAY.
 - › 'FtS' appears, followed by the ranking number.
- Note the number.
- You can now erase the selection as described above.

ERASING ALL FAVOURITE SELECTIONS AT ONCE

- Press FTS.
 - › The FTS indication starts flashing.
- Now immediately press REPEAT and CLEAR.
 - › The FTS indication keeps on flashing.
 - › When the entire FTS memory has been erased 'FtS 000' appears briefly on the display.
 - › All ranking numbers are now available again.

ADDITIONAL INFORMATION

LISTENING WITH HEADPHONES (PHONES)

- Connect headphones having a 6.3 mm jack plug and an impedance between 8 and 2000 ohms to the PHONES socket.
- The sound level is adjusted with the VOLUME control.

ATTACHING THE STICKERS TO THE CARTRIDGE (fig. 13-14)

The stickers can be used for:

- Noting disc titles, names of artists etc. on the storage case ('A' and 'C') and the cartridge itself ('B' and 'C').
 - Numbering, alphabetizing and classifying different cartridges ('D', 'E', 'F' and 'G').
 - Attach the stickers at the places indicated.
- Should you attach them elsewhere this may hamper the functioning of the changer or the cartridge.
Do not place stickers on top of each other. Only the stickers 'D', 'E', 'F' and 'G' can be placed on top of the 'C' stickers.

CARE OF THE DISCS

Although both sides of a disc are protected by a special coating, it is still advisable to treat the discs with care:

- Never leave discs lying around, put them back in their holders immediately after use.
- Never write on the printed side!
- Do not attach any stickers on that side.
- Keep the shiny surface of the disc clean. Use a soft lint-free cloth and always wipe the disc in a straight line from centre to edge. You may breathe lightly on the disc first.

The cleaning set SBC 3540, available separately, is a useful accessory for cleaning your discs. It contains a protective support, a special disc cleaning cloth and a bottle of cleaning fluid.

Warning!

Cleaning agents for conventional records are not suitable for cleaning a Compact Disc. Nor may detergents or abrasive cleaning agents be used.

CHANGER MAINTENANCE

A chamols leather slightly moistened with water is sufficient for cleaning the changer. Do not use cleaning agents containing alcohol, spirits, ammonia or abrasives.

The disc trays should be kept free of dust with a dry cloth.

TECHNICAL DATA

Typical Audio Performance

Frequency range: 2 Hz-20 kHz
Amplitude linearity: ± 0.1 dB (20 Hz-20kHz)
Phase linearity: $\pm 1.0^\circ$ (20 Hz-20kHz)
Dynamic range: > 90 dB (20 Hz-20kHz)
Signal-to-noise ratio: > 96 dB (20 Hz-20kHz)
Channel separation: 93 dB (1 kHz)
Total harmonic distortion: 0.003% (1 kHz)
Wow and flutter: quartz crystal precision
D/A conversion: quadruple oversampling (176.4 kHz) with digital filter and two 16-bit D/A-converters
Audio output level: $2 V_{\text{rms}}$
Impedance PHONES socket: 8-1000 ohms

Power supply

Mains voltage and frequency: see the type plate on the rear of the changer

Power consumption: 15 W approx.

Safety requirements: IEC

Cabinet

Material/finish: metal and polystyrene with decorative trim

Dimensions (w x h x d): 420 x 113 x 340 mm

Weight: 6.5 kg approx.

Subject to modification

This Compact Disc changer complies with radio interference requirements as laid down in EC regulations.

FAULTS AND THEIR LIKELY CAUSES

Insufficient familiarity with the combination of a new product and new discs may lead to faults arising during use. These are generally caused by simple errors in operation or external factors. It is perhaps useful to check the points listed below and where possible remedy these before taking your changer for repair.

- The transit clamps have not been removed.
- Condensation has formed on the lens of the laser due to a dramatic change in temperature. This will disappear automatically after some time.
- There is a foreign object in the disc tray.
- The disc has not been inserted with the printed side down or there is no disc in the tray.
- The disc is dirty, badly scratched or warped.
- The changer has been connected to the PHONO socket of the amplifier.

If the fault remains, try to clear it by switching the changer on and off.

If this also fails to help, do not continue experimenting, but remove the plug from the wall socket and consult your dealer.

Certain faults may be caused by a disc. In order to help determine the precise cause, take the disc with which the fault occurred with you when you take the changer for repair.

Under no circumstances should you open up the changer yourself, as this will invalidate the guarantee!

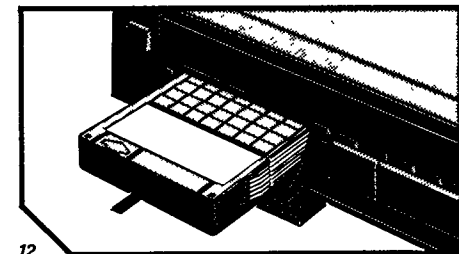
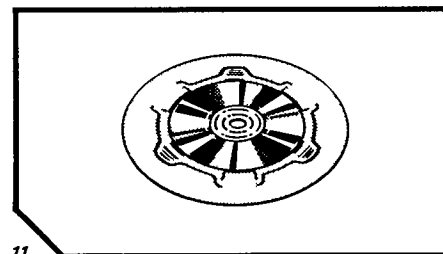
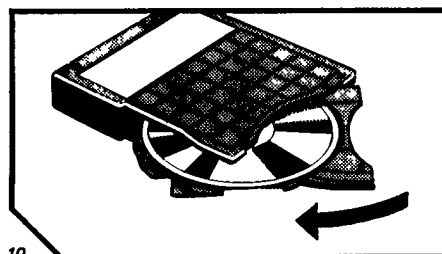
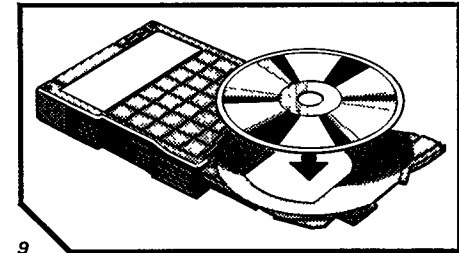
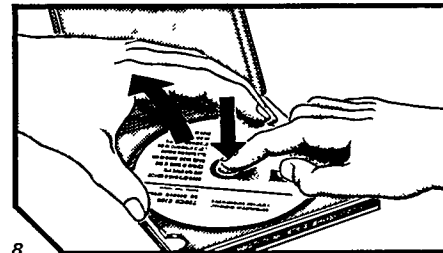
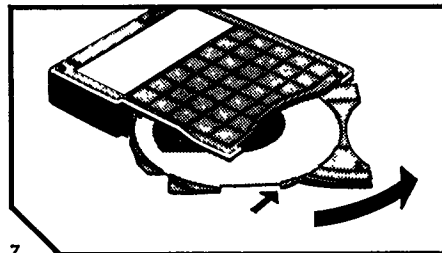
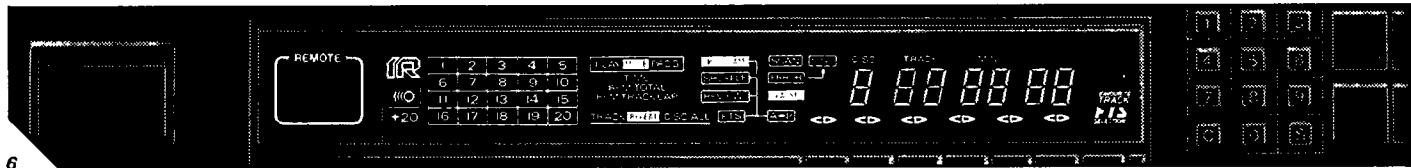
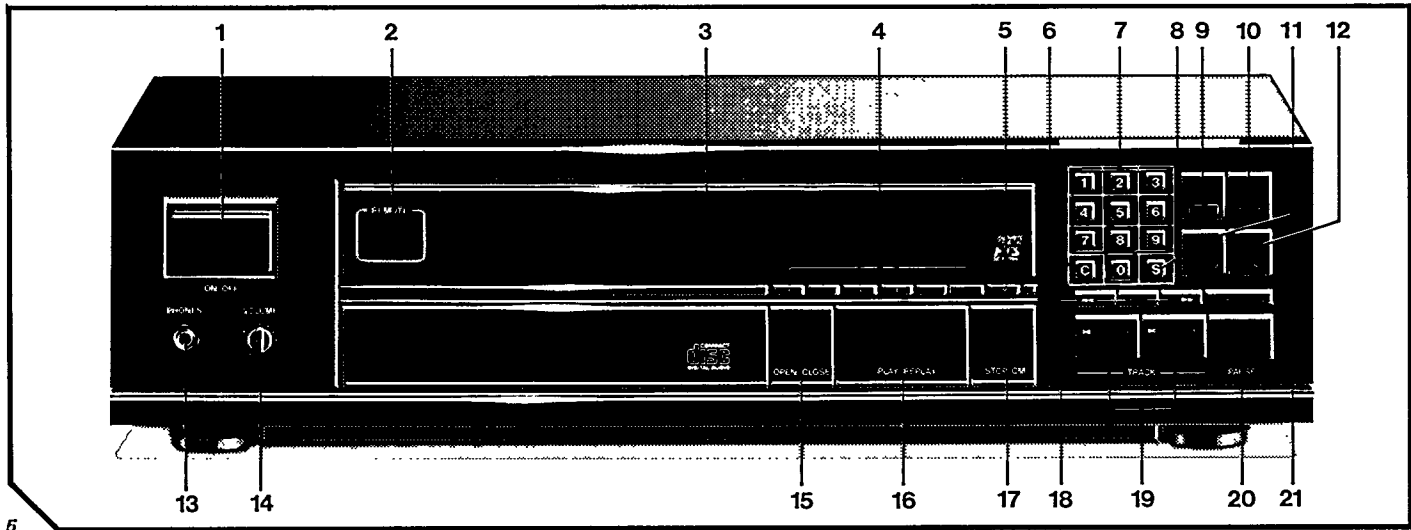
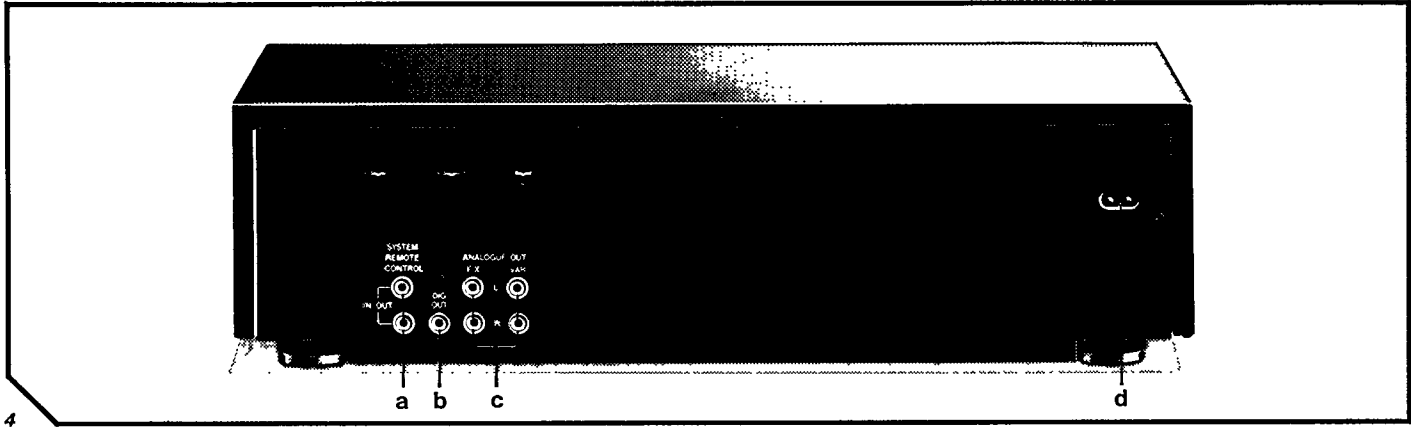
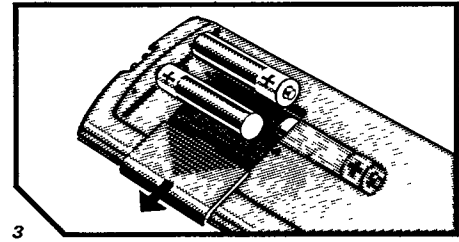
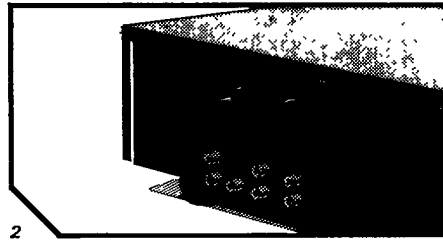
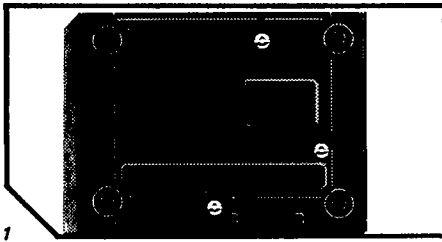

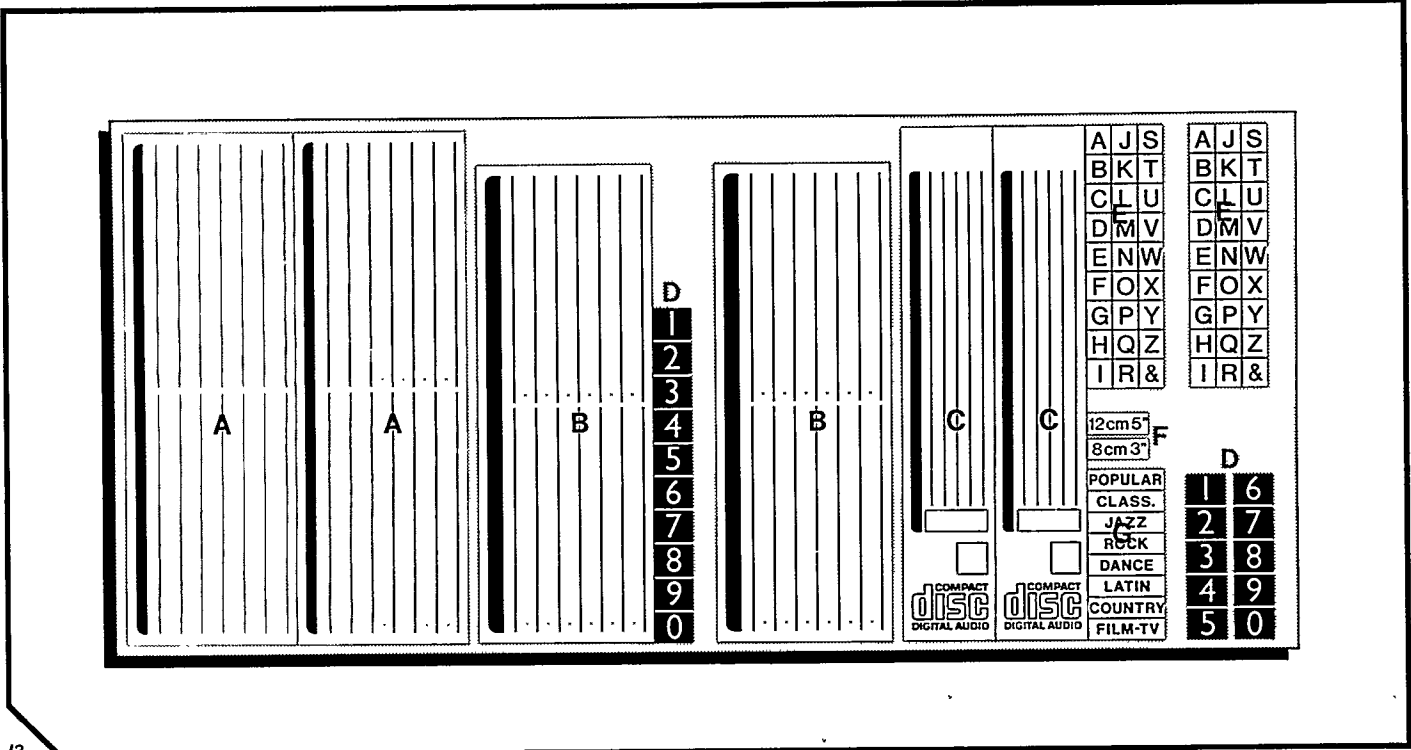

13

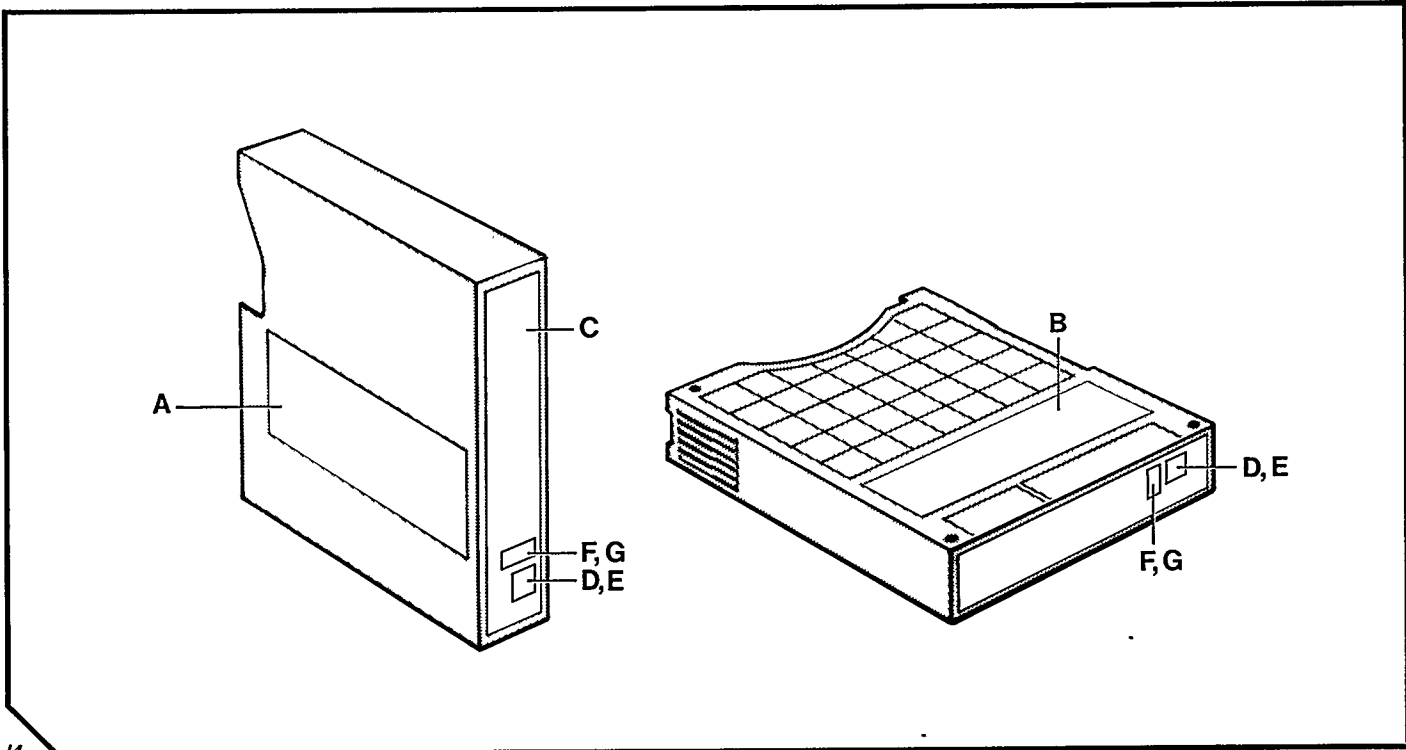

14

Free Manuals Download Website

<http://myh66.com>

<http://usermanuals.us>

<http://www.somanuals.com>

<http://www.4manuals.cc>

<http://www.manual-lib.com>

<http://www.404manual.com>

<http://www.luxmanual.com>

<http://aubethermostatmanual.com>

Golf course search by state

<http://golfingnear.com>

Email search by domain

<http://emailbydomain.com>

Auto manuals search

<http://auto.somanuals.com>

TV manuals search

<http://tv.somanuals.com>