

Register your product and get support at
www.philips.com/welcome



Thank you for choosing Philips.

Need help fast?

Read your Quick Start Guide and/or User Manual first for quick tips that make using your Philips product more enjoyable.

If you have read your instructions and still need assistance, you may access our online help at

www.philips.com/welcome
or call

1-888-PHILIPS (744-5477)

while with your product.

(and Model / Serial number)



Philips vous remercie de votre confiance.

Besoin d'une aide rapide?

Le Guide rapide de début et Manuel de l'utilisateur regorgent d'astuces destinées à simplifier l'utilisation de votre produit Philips.

Toutefois, si vous ne parvenez pas à résoudre votre problème, vous pouvez accéder à notre aide en ligne à l'adresse

www.philips.com/welcome
ou formez le

1-800-661-6162 (Francophone)

1-888-PHILIPS (744-5477) (English speaking)

Veillez à avoir votre produit à portée de main.

(et model / serial nombre)



Gracias por escoger Philips

Necesita ayuda inmediata?

Lea primero la Guía rápida del comienzo o el Manual del usuario, en donde encontrará consejos que le ayudarán a disfrutar plenamente de su producto Philips.

Si después de leerlo aún necesita ayuda, consulte nuestro servicio de asistencia en línea en

www.philips.com/welcome
o llame al teléfono

1-888-PHILIPS (744-5477)

y tenga a mano el producto.

(y número de model / serial)



PHILIPS

Note : This equipment has been tested and found to comply with the limits for a Class B digital device, pursuant to part 15 of the FCC Rules. These limits are designed to provide reasonable protection against harmful interference in a residential installation. This equipment generates, uses, and can radiate radio frequency energy and, if not installed and used in accordance with the instruction manual, may cause harmful interference to radio communications. However, there is no guarantee that interference will not occur in a particular installation. If this equipment does cause harmful interference to radio or television reception, which can be determined by turning the equipment off and on, the user is encouraged to try to correct the interference by one or more of the following measures :

- Relocate the receiving antenna.
- Increase the separation between the equipment and receiver
- Connect the equipment into an outlet on a circuit different from that to which the receiver is connected.
- Consult the dealer or an experienced radio/TV technician for help.

IMPORTANT !

modifications not authorized by the manufacturer may void users authority to operate this device.

Remarque : Cet équipement a été testé et a été certifié conforme aux limites imposées pour un appareil numérique de Classe B, conformément à la partie 15 des règlements FCC. Ces limites sont définies aux fins d'assurer une protection raisonnable contre les interférences nuisibles dans une installation résidentielle. Cet équipement génère, utilise et émet des fréquences radio qui, en cas d'une mauvaise installation ou d'une utilisation non-conforme aux instructions de ce manuel d'utilisation peuvent causer des interférences nuisibles aux communications radio. Il n'y a toutefois aucune garantie que des interférences nuisibles ne se produiront pas dans une installation donnée. Si cet équipement cause des interférences nuisibles avec votre poste radio ou de télévision, ce que vous pouvez déterminer en éteignant et en rallumant votre équipement, il est conseillé à l'utilisateur d'essayer de pallier à ces interférences nuisibles en prenant l'une ou l'autre des mesures suivantes:

- Changez la position de l'antenne de réception.
- Augmentez la séparation entre l'équipement et le récepteur.
- Branchez l'équipement sur une source d'alimentation différente de celle sur laquelle le récepteur est branché.
- Consultez votre distributeur ou un technicien qualifié en la matière pour assistance.

IMPORTANTE !

las modificaciones no autorizadas por el fabricante pueden anular la autoridad de los usuarios para utilizar este aparato.

Nota : Este aparato ha sido probado y cumple con los límites correspondientes a un aparato digital de Clase B, según la parte 15 de las Normas FCC. Estos límites han sido diseñados para facilitar suficiente protección frente a interferencias perjudiciales en una instalación residencial. Este aparato genera, utiliza y puede emitir energía de frecuencias de radio y, si no se instala y utiliza según el manual de instrucciones, puede provocar interferencias perjudiciales en las comunicaciones de radio. Sin embargo, no existe garantía de que las interferencias no ocurrirán en una instalación particular. Si este aparato provoca interferencias perjudiciales en la recepción de radio o televisión, que se puede identificar encendiendo y apagando el aparato, recomendamos al usuario que intente solucionar las interferencias siguiendo una o más de las siguientes medidas:

- Cambie la posición de la antena receptora.
- Aumente la separación entre el aparato y el receptor.
- Conecte el aparato a una toma de un circuito diferente al que está conectado el receptor.
- Consulte con el distribuidor o un técnico de radio/TV con experiencia para que le ayuden.

¡IMPORTANTE!

modificações não autorizadas pelo fabricante, podem causar danos na operação deste aparelho.

Return your Product Registration Card or register online at
www.philips.com/welcome today to get the very most from your purchase.

Registering your model with PHILIPS makes you eligible for all of the valuable benefits listed below, so don't miss out. Complete and return your Product Registration Card at once, or register online at www.philips.com/welcome to ensure:

***Proof of Purchase**

Returning the enclosed card guarantees that your date of purchase will be on file, so no additional paperwork will be required from you to obtain warranty service.

***Product Safety Notification**

By registering your product, you'll receive notification - directly from the manufacturer - in the rare case of a product recall or safety defect.

***Additional Benefits**

Registering your product guarantees that you'll receive all of the privileges to which you're entitled, including special money-saving offers.

PHILIPS

Congratulations on your purchase, and welcome to the "family!"

Dear PHILIPS product owner:

Thank you for your confidence in PHILIPS. You've selected one of the best-built, best-backed products available today. We'll do everything in our power to keep you happy with your purchase for many years to come. As a member of the PHILIPS "family," you're entitled to protection by one of the most comprehensive warranties and outstanding service networks in the industry. What's more, your purchase guarantees you'll receive all the information and special offers for which you qualify, plus easy access to accessories from our convenient home shopping network.

Most importantly, you can count on our uncompromising commitment to your total satisfaction.

All of this is our way of saying welcome - and thanks for investing in a PHILIPS product.

P.S. To get the most from your PHILIPS purchase, be sure to complete and return your Product Registration Card at once, or register online at:

www.philips.com/welcome

Know these
safety symbols



 This "bolt of lightning" indicates uninsulated material within your unit may cause an electrical shock. For the safety of everyone in your household, please do not remove product covering.

 The "exclamation point" calls attention to features for which you should read the enclosed literature closely to prevent operating and maintenance problems.

WARNING: To reduce the risk of fire or electric shock, this apparatus should not be exposed to rain or moisture and objects filled with liquids, such as vases, should not be placed on this apparatus.

CAUTION: To prevent electric shock, match wide blade of plug to wide slot, fully insert.

ATTENTION: Pour éviter les choc électriques, introduire la lame la plus large de la fiche dans la borne correspondante de la prise et pousser jusqu'au fond.

For Customer Use

Enter below the Serial No. which is located on the rear of the cabinet. Retain this information for future reference.

Model No. _____

Serial No. _____

PHILIPS

Visit our World Wide Web Site at <http://www.philips.com/welcome>

IMPORTANT SAFETY INSTRUCTIONS

1. **Read these instructions.**
2. **Keep these instructions.**
3. **Heed all warnings.**
4. **Follow all instructions.**
5. **Do not use this apparatus near water.**
6. **Clean only with dry cloth.**
7. **Do not block any ventilation openings. Install in accordance with the manufacturer's instructions.**
8. **Do not install near any heat sources**

such as radiators, heat registers, stoves, or other apparatus (including amplifiers) that produce heat.

9. **Do not defeat the safety**

purpose of the polarized or

grounding-type plug. A polarized plug has two blades with one wider than the other. A grounding type plug has two blades and a third grounding prong. The wide blade or the third prong are provided for your safety. If the provided plug does not fit into your outlet, consult an electrician for replacement of the obsolete outlet.

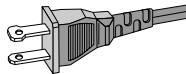

AC Polarized Plug

10. **Protect the power cord** from being walked on or pinched, particularly at plugs, convenience receptacles, and the point where they exit from the apparatus.
11. **Only use attachments/accessories** specified by the manufacturer:

12.  **Use only with the cart**, stand, tripod, bracket, or table specified by the manufacturer or sold with the apparatus. When a cart is used, use caution when moving the cart /apparatus combination to avoid injury from tip-over.

13. **Unplug this apparatus** during lightning storms or when unused for long periods of time.
14. **Refer all servicing** to qualified service personnel. Servicing is required when the apparatus has been damaged in any way, such as power-supply cord or plug is damaged, liquid has been spilled or objects have fallen into the apparatus, the apparatus has been exposed to rain or moisture, does not operate normally, or has been dropped.

15. **Where the MAINS plug or an appliance coupler is used as the disconnet device, the disconnet device shall remain readily operable.**

16. **Battery usage CAUTION** – To prevent battery leakage which may result in bodily injury, property damage, or damage to the unit:

Install **all** batteries correctly, + and - as marked on the unit.

Do not mix batteries (**old** and **new** or **carbon** and **alkaline**, etc.).

Remove batteries when the unit is not used for a long time.

17. **Apparatus shall not be exposed to dripping or splashing.**
18. **Do not place any sources of danger on the apparatus** (e.g. liquid filled objects, lighted candles).
19. This product may contain lead and mercury. Disposal of these materials may be regulated due to environment considerations.

For disposal or recycling information, please contact your local authorities or the Electronic Industries Alliance: www.eiae.org.

EL 6475-S004: 03/12

Class II equipment symbol



This symbol indicates that the unit has a double insulation system

Canada**English:**

This digital apparatus does not exceed the Class B limits for radio noise emissions from digital apparatus as set out in the Radio Interference Regulations of the Canadian Department of Communications.

Français:

Cet appareil numérique n'émet pas de bruits radioélectriques dépassant les limites applicables aux appareils numériques de Class B prescrites dans le Règlement sur le Brouillage Radioélectrique édicté par le Ministère des Communications du Canada.

English 6

Français 27

Español 50



Windows Media and the Windows logo are trademarks, or registered trademarks of Microsoft Corporation in the United States and/or other countries.

CAUTION

Use of controls or adjustments or performance of procedures other than herein may result in hazardous radiation exposure or other unsafe operation.

ATTENTION

L'utilisation des commandes ou réglages ou le non respect des procédures ci-incluses peuvent se traduire par une exposition dangereuse à l'irradiation.

ATENCIÓN

El uso de mando o ajustes o la ejecución de métodos que no sean los aquí descritos puede ocasionar peligro de exposición a radiación.

Contents

General Information

Environmental Information	7
Supplied accessories	7
Safety Information	7
Hearing Safety	8

Preparations

Connections	9~10
Power	
Connecting the wireless subwoofer	
Antenna connection	
Optional connection	
Connecting a USB mass storage device or SD/MMC memory card	
Connecting other equipment to your system	
Mounting the set onto wall	11
Using Remote Control	11

Controls

Controls on the system	12
Controls on the remote control	13

Basic Functions

Switching the system on	14
Switching the system to standby mode	14
Switching the system to Eco Power Standby mode	14
Power Saving Automatic Standby	14
Adjusting volume and sound	14

Radio Reception

Tuning to radio stations	15
Programming radio stations	15
Automatic programming	
Manual programming	
Tuning to preset radio stations	15

USB/Card

Using a USB mass storage device/SD/MMC memory card	16~17
Using playback features	17~18
Basic playback controls	
Different play modes: SHUFFLE and REPEAT	
Programming audio files	

Dock for iPod

Playing Apple iPod using DC912	19
Compatible iPod player	
Dock adaptor	
Playing Apple iPod	
Charging iPod battery using the dock	19

AUX

Listening to an external source	20
---------------------------------------	----

Clock/Timer

Clock setting	21
Timer setting	21
Sleep timer setting	22

Specifications

Maintenance

Troubleshooting

General Information

Congratulations on your purchase and welcome to Philips!

To fully benefit from the support that Philips offers, register your product at www.philips.com/welcome.

This set complies with the FCC rules, Part 15 and with 21 CFR 1040.10.

Operation is subject to the following two conditions:

- **This device may not cause harmful interference, and**
- **This device must accept any interference received, including interference that may cause undesired operation.**

Environmental Information

All unnecessary packaging has been omitted. We have tried to make the packaging easy to separate into three materials: cardboard (box), polystyrene foam (buffer) and polyethylene (bags, protective foam sheet).

Your system consists of materials which can be recycled and reused if disassembled by a specialized company. Please observe the local regulations regarding the disposal of packaging materials, exhausted batteries and old equipment.

Supplied accessories

- remote control with 1 CR2025 battery
- 4 X iPod dock adaptors
- 1 X certified AC/DC adapter
(Input: 100- 240V ~ 50/60Hz, 1.6A
Output: 29V \equiv 2.5A; manufacturer: Philips;
model No.:
PAT075A29UL/ OH-1065A2402700U)
- 1 x AUX cable
- Mounting kit (2 dowels and 2 screws)

Safety Information

- Before operating the system, check that the operating voltage indicated on the typeplate of your system is identical with the voltage of your local power supply. If not, please consult your dealer.

- Where the MAINS plug or an appliance coupler is used as the disconnect device, the disconnect device shall remain readily operable.
- Place the system on a flat, hard and stable surface.
- Place the system in a location with adequate ventilation to prevent internal heat build-up in your system. Allow at least 10 cm (4 inches) clearance from the rear and the top of the unit and 5 cm (2 inches) from each side.
- The ventilation should not be impeded by covering the ventilation openings with items, such as newspapers, table-cloths, curtains, etc.
- Do not expose the system, batteries or discs to excessive moisture, rain, sand or heat sources caused by heating equipment or direct sunlight.
- No naked flame sources, such as lighted candles, should be placed on the apparatus.
- No objects filled with liquids, such as vases, shall be placed on the apparatus.
- Install this unit near the AC outlet and where the AC power plug can be reached easily.
- The apparatus shall not be exposed to dripping or splashing.
- Excessive sound pressure from earphones and headphones can cause hearing loss.
- Battery shall not be exposed to excessive heat such as sunshine, fire or the like.
- If the system is brought directly from a cold to a warm location, or is placed in a very damp room, moisture may condense on the lens of the disc unit inside the system. Should this occur, the CD player would not operate normally. Leave the power on for about one hour with no disc in the system until normal playback is possible.
- The mechanical parts of the set contain self-lubricating bearings and must not be oiled or lubricated.
- Batteries (battery pack or batteries installed) shall not be exposed to excessive heat such as sunshine, fire or the like.
- **When the system is switched to Standby mode, it is still consuming some power.**

To disconnect the system from the power supply completely, remove the AC power plug from the wall socket.

General Information

Hearing Safety

Listen at a moderate volume.

- Using headphones at a high volume can impair your hearing. This product can produce sounds in decibel ranges that may cause hearing loss for a normal person, even for exposure less than a minute. The higher decibel ranges are offered for those that may have already experienced some hearing loss.
- Sound can be deceiving. Over time your hearing "comfort level" adapts to higher volumes of sound. So after prolonged listening, what sounds "normal" can actually be loud and harmful to your hearing. To guard against this, set your volume to a safe level before your hearing adapts and leave it there.

To establish a safe volume level:

- Set your volume control at a low setting.
- Slowly increase the sound until you can hear it comfortably and clearly, without distortion.

Listen for reasonable periods of time:

- Prolonged exposure to sound, even at normally "safe" levels, can also cause hearing loss.
- Be sure to use your equipment reasonably and take appropriate breaks.

Be sure to observe the following guidelines when using your headphones.

- Listen at reasonable volumes for reasonable periods of time.
- Be careful not to adjust the volume as your hearing adapts.
- Do not turn up the volume so high that you can't hear what's around you.
- You should use caution or temporarily discontinue use in potentially hazardous situations.
- Do not use headphones while operating a motorized vehicle, cycling, skateboarding, etc.; it may create a traffic hazard and is illegal in many areas.

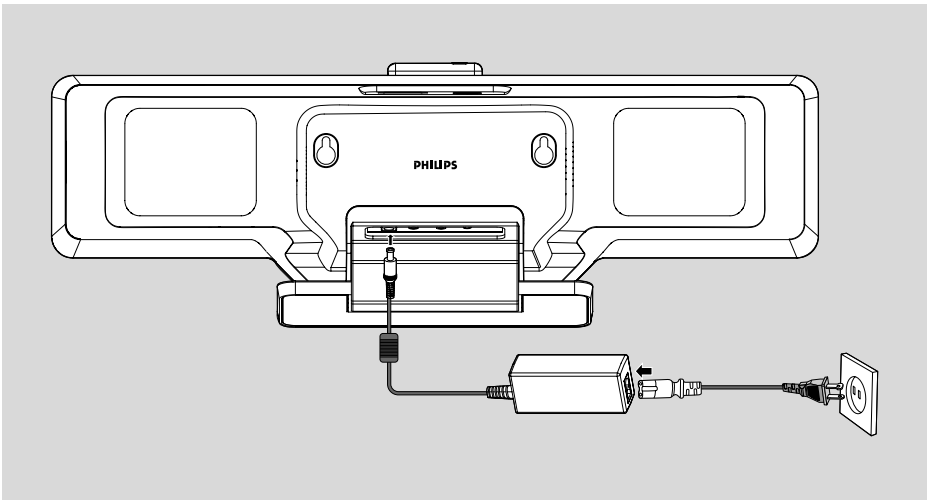

Connections

The type plate is located at the bottom of the system.

A Power

- Before connecting the AC power adaptor to the wall outlet, ensure that all other connections have been made.
- DC jack is located at the bottom panel of the set.

WARNING!

- Use the supplied AC power adaptor only! Using any other power connection device may damage your main set!
- For optimal performance, use only the original AC power adaptor.
- Never make or change connections with the power switched on.

To avoid overheating of the system, a safety circuit has been built in. Therefore, your system may switch to Standby mode automatically under extreme conditions. If this happens, let the system cool down before reusing it (not available for all versions).

B Connecting the wireless subwoofer

- 1 Place the subwoofer on the floor near an AC outlet.
- 2 Connect the power cord of the subwoofer to the AC outlet.
 - The LED indicator on the subwoofer's back panel light up blue.
- 3 Power on both the main set and subwoofer:
 - Wireless connection will set up automatically.
 - "NOT PAIR" will be displayed at intervals of 10 seconds if wireless connection fails to set up.

In case the wireless connection fails due to conflict or strong interference etc., you may need the following procedures for manual pairing:

- 1 In standby mode, press and hold ►► on the set for three seconds to activate signal transmitting.
 - "PAIR" flashes on the display screen.

Preparations

- 2 Press and hold the **PAIR** button on the rear of the subwoofer for three seconds to activate signal receiving.
→ The LED indicator on the subwoofer flashes in blue and green alternatively.

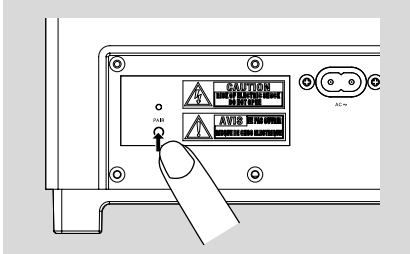

- If the connection succeeds, the display shows "PASS".
- If the connection fails or the connection cannot be set up successfully within 60 seconds, the display shows "FAIL".

Notes:

- The wireless connection will be disconnected automatically after power-off.
- See "Basic Functions - Switching the system to Eco Power Standby mode" for how to switch between Eco Power Standby mode and standby mode.

C Antenna Connection

FM Antenna

It is unnecessary to connect the FM pigtail antenna since it is fixed to the main unit.

- Adjust the FM antenna for optimal FM stereo reception.

D Optional connection

The optional equipment and connecting cords are not supplied. Refer to the operating instructions of the connected equipment for details.

Connecting a USB mass storage device or SD/MMC memory card

By connecting a USB mass storage device or SD/MMC memory card to the Hi-Fi system, you can enjoy the device's or card's stored music through the powerful speakers of the Hi-Fi system.

- Insert the USB device's USB plug into the  socket on the set.

OR

for the devices with USB cables:

- 1 Insert one plug of the USB cable (not supplied) to the  socket on the set.
- 2 Insert the other plug of the USB cable to the USB output terminal of the USB device.

OR

for the memory card:

- Fully insert the memory card (metal contact facing left) into the **SD / MMC** slot on the top of the system.

Connecting other equipment to your system

This feature allows you to listen to music from the external equipment through the powerful speakers of the Hi-Fi system.

- Use an Aux-in cable (supplied) to connect the AUX IN-1 or AUX-2 jack (3.5mm, located on the bottom panel) to an AUDIO OUT or headphone jack on an external device (such as TV, Laser Disc player, DVD player or CD recorder).

Note:

- Refer to the operating instructions for the connected equipment for details.

Mounting the set onto wall

See the separate sheet of Wall mounting instructions on how to mount the set onto wall.

Note:

– To secure the mounting on wall, cement wall is required.

Using Remote Control

IMPORTANT!

- Before using the remote control, remove the insulation plastic tab as shown in the picture below.
- If the remote control does not function correctly or the operating range is reduced, replace the battery with a new (CR2025) battery.

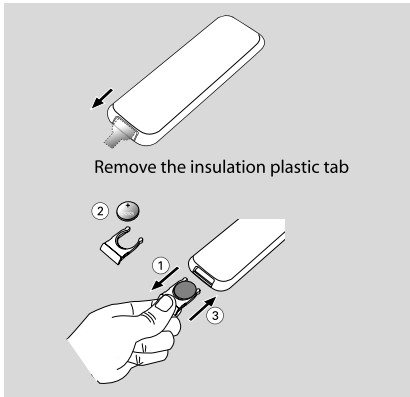

- 1 Push to open the battery tray.
- 2 Replace a new battery according to the indicated polarity.
- 3 Push the battery tray back to close it.

Using the Remote Control to operate the Player

- 1 Aim the Remote Control directly at the remote sensor (IR) on the front panel.
- 2 Select the source you wish to control by pressing one of the source select buttons on the remote.
- 3 Then select the desired function (for example, ► II, ◀ or ▶).

CAUTION!

- Remove battery if it is exhausted or will not be used for a long time.
- Battery contains chemical substances, so they should be disposed of properly.
- Perchlorate Material-special handling may apply. See www.dtsc.ca.gov/hazardouswaste/perchlorate.

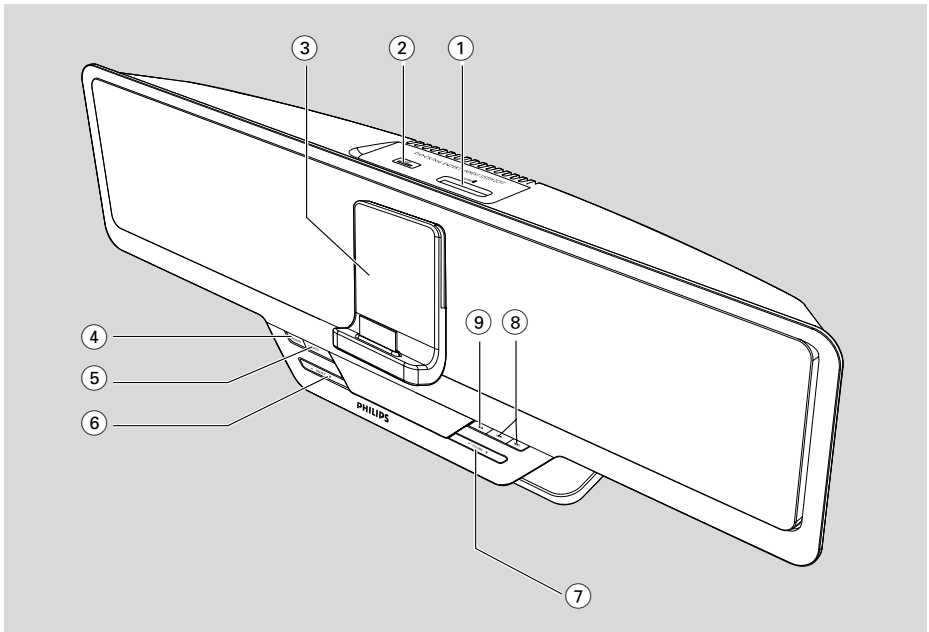

Controls on the system

- ① **SD / MMC**
 - is the slot used to insert an SD/MMC memory card.
- ② **USB port**
 - jack for the external USB mass storage device.
- ③ **iPod dock**
 - is used to dock your iPod player for playback or recharging through this system.
- ④ **POWER**
 - switches the system on or to Eco Power standby/normal standby with clock display.
- ⑤ **SOURCE**
 - selects the respective sound source for TUNER (FM)/iPod/USB/CARD (SD/MMC)/AUX.
- ⑥ **PRESET +/-**
 - (for USB/CARD) skips to the beginning of a current/previous/subsequent album.
 - selects a preset radio station.

DBB (Dynamic Bass Boost)

- enables or disables bass enhancement. (in USB/Tuner mode, hold down then release to select)

DSC (Digital Sound Control)

- selects different types of preset sound equalizer settings. (in USB/Tuner mode, hold down then release to select)

⑦ VOLUME +/-

- adjusts the volume level.
- adjusts the hours and minutes for the clock/timer function.
- switches between 12 hour and 24 hour display.

⑧

for USB/CARD/iPod

..... fast searches back and forward within a track (press and hold).

..... skips to the beginning of a current/previous/subsequent track.

for TUNER tunes to radio stations (down/up).

⑨

- starts or interrupts playback.

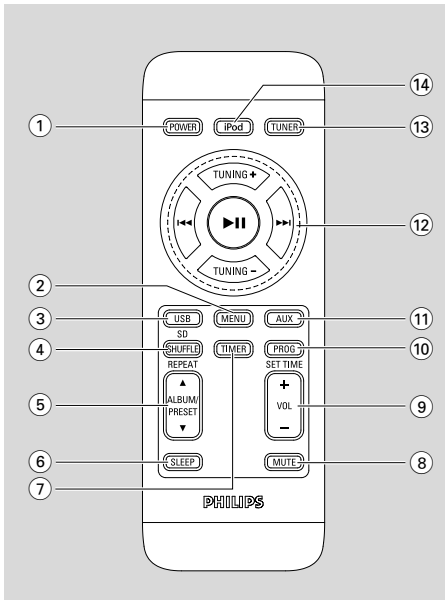

Controls on the remote control

- ① **POWER**
 - switches the system on or to Eco Power standby/normal standby with clock display.
- ② **MENU**
 - is equivalent to the MENU button on your iPod player.
- ③ **USB/SD**
 - switches between USB and SD mode.
- ④ **SHUFFLE/REPEAT**
 - for USB/CARD
 - selects a repeat playback mode.
 - plays USB/CARD tracks randomly.
- ⑤ **ALBUM/PRESET ▲ / ▼**
 - (for USB/CARD) skips to the beginning of a current/previous/subsequent album.
 - selects a preset radio station.
- ⑥ **SLEEP**
 - selects the sleeper time.
- ⑦ **TIMER**
 - sets the timer function.
- ⑧ **MUTE**
 - interrupts and resumes sound production.

- ⑨ **VOL +/-**
 - adjusts the volume level.
 - adjusts the hours and minutes for the clock/timer function.
 - switches between 12 hour and 24 hour display.
- ⑩ **PROG/SET TIME**
 - (for USB/CARD) programs tracks.
 - (for TUNER) programs radio stations.
 - sets the clock function.
- ⑪ **AUX**
 - selects AUX mode.
- ⑫ **▶ II**
 - starts or interrupts playback.
 - confirms a selection (for iPod menu operation only).

TUNING +/-

for TUNER tunes to radio stations (down/up).
 Navigates the iPod menu.



for USB/CARD/iPod

- fast searches back and forward within a track (press and hold).
- skips to the beginning of a current/previous/subsequent track.

- ⑬ **TUNER**
 - selects the tuner source
- ⑭ **iPod**
 - selects the iPod source.

Notes for remote control:

- **First select the source you wish to control by pressing one of the source select keys on the remote control (for example iPod, TUNER).**
- **Then select the desired function (for example ▶ II, <<<, >>>).**

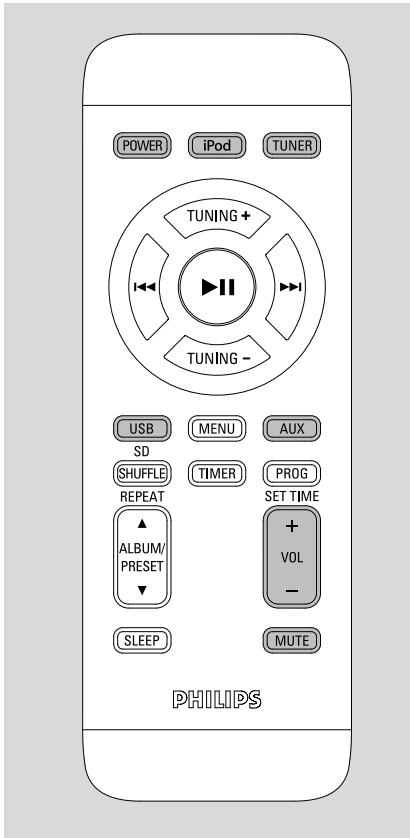

IMPORTANT!

– **Make sure to complete the preparation procedures before operating the system.**

Switching the system on

- Press **POWER**.
→ The system will switch to the last selected source.
- Press **SOURCE** on the set or **iPod, TUNER, USB/CARD** or **AUX** on the remote control.
→ The system will switch to the selected source.

Switching the system to standby mode

- Press **POWER**.
→ The backlight for clock display is off in standby.

- The display displays clock time, or ---: --- is displayed if clock time is not set.
- The volume level (up to a maximum volume level of 12), interactive sound settings, last selected mode (ECO Power Standby or normal standby), source and tuner presets will be retained in the player's memory.

Switching the system to Eco Power Standby mode

- Press and hold **POWER** for more than 2 seconds.
→ The backlight will go blank.

Power Saving Automatic Standby

As a power-saving feature, the system automatically switches to Eco Power/ Standby 15 minutes after playback has reached the end and no control is operated.

Adjusting volume and sound

- 1 Press **VOLUME +/-** on the system (or **VOL +/-** on the remote control) to decrease or increase the volume.
→ Display shows the volume level VOL and a number from 0, 1, 2, ...32.
 - 2 In USB/Tuner mode, press and hold **DSC** on the set, then release to select a sound effect: **ROCK/POP/JAZZ/CLASSIC**.
 - In iPod /AUX mode, simply press **DSC** on the set to select the desired sound effect.
 - 3 In USB/Tuner mode, press and hold **DBB** on the set, then release to switch bass enhancement on or off.
 - In iPod /AUX mode, simply press **DBB** on the set to switch bass enhancement on or off.
→ If the DBB is activated, **DBB ON** is shown.
→ If the DBB is deactivated, **DBB OFF** is shown.
 - 4 Press **MUTE** on the remote control to interrupt sound reproduction instantly.
→ Playback will continue without sound and **MUTE** will flash on the display.
- To activate sound reproduction you can:
 - press **MUTE** on the remote control again;
 - adjust the volume controls;
 - change source.

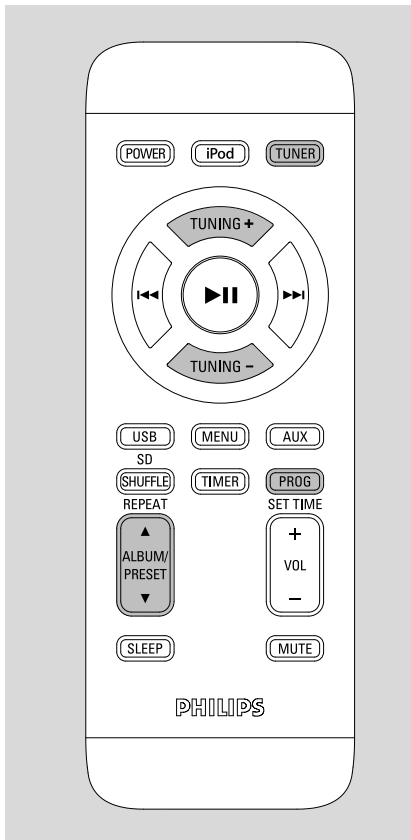

Tuning to radio stations

- 1 Press **SOURCE** repeatedly (or **TUNER** on the remote control) to select the tuner source (FM).
- 2 Hold **◀▶** on the system (or **TUNING +/-** on the remote control) and then release the button.
→ The system will start searching for a radio station with sufficient signal strength.
- 3 Repeat step 2 if necessary until you find the desired station.
- To tune to a weak station, press **◀▶** on the system (or **TUNING +/-** on the remote control) briefly and repeatedly until you have found optimal reception.

Programming radio stations

You can store up to a total of 40 radio stations (40 FM) in the memory.

Automatic programming

Automatic programming will start with a chosen preset number. From this preset number upwards, former programmed radio stations will be overridden.

- 1 Press **PRESET +/-** on the system (or **ALBUM/PRESET ▲ / ▼** on the remote control) to select the preset number where programming should start.

Note:

– If no preset number is selected, default is preset (1) and all your presets will be overridden.

- 2 Press **PROG** on the remote control for more than two seconds to activate programming.
→ All available stations are programmed.

Manual programming

- 1 Tune to your desired station (refer to "Tuning to radio stations").
- 2 Press **PROG** on the remote control to activate programming.
→ **PROG** appears in the display.
- 3 Press **PRESET +/-** on the system (or **ALBUM/PRESET ▲ / ▼** on the remote control) to allocate a number from 1 to 40 to this station.
- 4 Press **PROG** on the remote control again to confirm the setting.
→ **PROG** disappears, the preset number and the frequency of the preset station are shown.
- 5 Repeat the above four steps to store other stations.
- You can override a preset station by storing another frequency in its place.

Tuning to preset radio stations

- Press **PRESET +/-** on the system (or **ALBUM/PRESET ▲ / ▼** on the remote control) until the desired preset station is displayed.

Using a USB mass storage device/SD/MMC memory card

By connecting a USB mass storage device or SD/MMC memory card to the Hi-Fi system, you can enjoy the device's or card's stored music through the powerful speakers of Hi-Fi system.

Playing a USB mass storage device/SD/MMC memory card

Compatible mass storage devices/cards

With the Hi-Fi system, you can use:

- USB flash memory (USB 2.0 or USB1.1)
- USB flash players (USB 2.0 or USB1.1)
- SD/MMC memory cards

Notes:

– *In some USB flash players (or memory devices), the stored contents are recorded using copyright protection technology. Such protected contents will be unplayable on any other devices (such as this Hi-Fi system).*

– *Compatibility of the USB connection on this product:*

a) *This product supports most USB Mass storage devices (MSD) that are compliant to the USB MSD standards.*

i) *Most common Mass storage class devices are flash drives, memory sticks, jump drives and etc.*

ii) *If you see a "Disc Drive" show up on your computer after you plugged the mass storage device into your computer, most likely it is MSD compliant and it will work with this product.*

b) *If your Mass storage device required a battery/ power source. Please make sure you have a fresh battery in it or charge the USB device first and then plug it into the product again.*

– *Supported Music type:*

a) *This device only supports unprotected music with the following file extension:*

.mp3

.wma

b) *Music bought from on-line music stores are not supported because they are secured by Digital Rights Management protection (DRM).*

c) *File name extensions that end with the following are not supported:*

.wav; .m4a; .m4p; mp4; .aac and etc.

– *No Direct connection can be made from*

Computer USB port to the product even you have either or both mp3 or wma files in your computer.

Supported formats:

- USB or memory file format FAT12, FAT16, FAT32 (sector size: 512 bytes)
- MP3 bit rate (data rate): 32-320 Kbps and variable bit rate
- WMA v9 or earlier
- Directory nesting up to a maximum of 8 levels
- Number of albums/ folders: maximum 99
- Number of tracks/titles: maximum 400
- ID3 tag v2.0 or later
- File name in Unicode UTF8 (maximum length: 128 bytes)

The system will not play or support the following:

- Empty albums: an empty album is an album that does not contain MP3/WMA files, and will not be shown in the display.
- Non-supported file formats are skipped. This means that e.g.: Word documents .doc or MP3 files with extension .dlf are ignored and will not be played.
- AAC, WAV, PCM audio files
- DRM protected WMA files
- WMA files in Lossless format

How to transfer music files from PC to a USB mass storage device/SD/MMC memory card

By dragging and dropping music files, you can easily transfer your favorite music from PC to a USB mass storage device/SD/MMC memory card.

For a flash player, you can also use its music management software for the music transfer:

However, those WMA files may be unplayable for compatibility reasons.

How to organize your MP3/WMA files on the USB mass storage device/SD/MMC memory card

This Hi-Fi system will browse the MP3/WMA files in the folders/sub-folders/titles order:

Example:

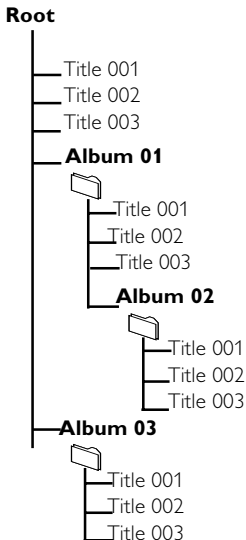

Organize your MP3/WMA files in different folders or subfolders as required.

Notes:

- If you have not organized MP3/WMA files into any albums on your disc, an album "01" will be automatically assigned for all those files.
- Make sure that the file names of MP3 files end with .mp3. and the file names of WMA files end with .wma.

– For DRM protected WMA files, use Windows Media Player 10 (or later) for conversion. Visit www.microsoft.com for details about Windows Media Player and WM DRM (Windows Media Digital Rights Management).

- 1 Check the USB device/SD/MMC memory card has been properly connected. (See "Preparations: Connecting a USB mass storage device or SD/MMC memory card").
- 2 Press **SOURCE** on the system (**USB/CARD** on the remote) once or more to select USB/ CARD.
→ **NO AUDIO** appears if no audio file is found in the USB device/SD/MMC memory card.
- 3 Play the available audio files using playback buttons on the set or remote control (such as **▶||**, **◀◀▶▶▶**).

Using playback features

Basic playback controls

To play audio file

- Press **▶||** to start playback.

To interrupt playback

- Press **▶||** during playback.
→ To resume, press **▶||** again.

To select a different track

- Press **◀◀▶▶▶** once or repeatedly until the desired track number appears in the display.
- For MP3/WMA, you may press **PRESET +/-** on the system (or **ALBUM/PRESET ▲ / ▼** on the remote control) to select a desired album, then select your desired track.

To find a passage within a track

- Press and hold down on **◀◀▶▶▶**.
→ The file is played at high speed and low volume.

Different play modes: SHUFFLE and REPEAT

You can select and change the various play modes before or during playback. The REPEAT modes can also be combined with PROGRAMME.

SHUFall the audio files are played in random order

REP ALLrepeats all the audio files/programme

REPplays the current audio file continuously

- 1 To select your play mode, press **SHUFFLE/REPEAT** on the remote control before or during playback until the display shows the desired function.
- 2 Press **▶II** to start playback if in the STOP position.
- 3 To return to normal playback, press **SHUFFLE / REPEAT** on the remote control until the various SHUFFLE/ REPEAT modes are no longer displayed.

Note:

– *The SHUFFLE and REPEAT functions cannot be used simultaneously.*

Programming audio files

You may store up to 40 audio files in the desired sequence. If you like, store any track more than once.

- 1 Press and hold **PROG** on the remote control to store.
→ **PROG** flashes, and **PR** □ ! is displayed.
- 2 Press **◀◀▶▶▶▶▶▶** to select your desired track number.
- For MP3/WMA, you may press **PRESET +/-** on the system (or **ALBUM/PRESET ▲ / ▼** on the remote control) to select a desired album, then select your desired track.
- 3 Repeat **steps 1-2** to select and store all desired tracks.
→ **PROGRAM FULL** is displayed if you attempt to programme more than 40 tracks.
- 4 To start playback of your programme, press **▶II**.
- 5 To stop playback, press and hold **PROG**.

To review the programme

- Press and hold **PROG** to stop playback, then press **◀◀▶▶▶▶▶▶**.

To delete the programme

- Press and hold **PROG** once in the STOP mode;
- Press **PROG** twice during playback.
→ **PROG** disappears from the display.

Note:

– *For compatibility reasons, the album/track information may differ from what it is displayed through flash players' music management software.*

Playing Apple iPod using DC912

The set is equipped with a dock for iPod. By connecting Apple iPod to the set, you can listen to the sound of the docked iPod through the powerful speakers of the Hi-Fi system and view the iPod video (if available).

Compatible iPod player

- Apple iPod models with 30-pin dock connector as follows:
20GB, 40GB, 20/30GB Photo, 40/60GB Photo, 30GB Video, 60GB/80 Video, Mini, Nano 1st / 2nd/3rd generation, iPod 5th generation (video), iPod touch and iPod classic.
- iPod Shuffle is not supported.

Dock adaptor

Before plugging your player in the dock, snap the suitable dock adaptor (supplied) into the dock to provide a snug fit for the player to be docked.

Selecting the correct dock adaptor

- 4 iPod dock adaptors are included. Each adaptor has indication to match different iPod types.

Installing the dock adaptor

- As shown below, align the slots of the dock and latches of the adaptor; then slide in the adaptor.

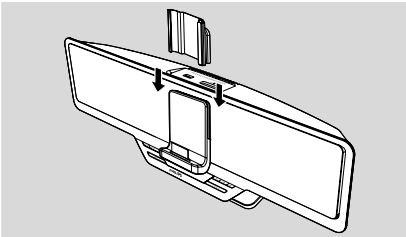

Removing the dock adaptor

- As shown, slide the adaptor up to take it out.

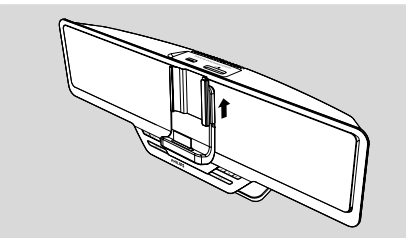

Playing Apple iPod

- 1 Correctly place the iPod in the dock.

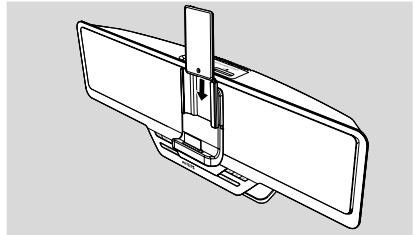

- 2 Press repeatedly **SOURCE** on the main unit to select iPod mode (or **iPod** on the remote control).
- 3 Power on your iPod.
- 4 Select and playback your favourite song/video/photo on the iPod.

Notes:

– Using the following buttons only (**▶||**, **◀◀/▶▶**, **VOLUME** and **MUTE**) on the DC912 and its remote control, you can control some iPod playback features, such as, Play/Pause, selecting next/previous track, fast forwarding/rewinding and changing volume.

– You may also use **TUNING +/-** and **▶ ||** on the remote control to navigate the iPod menu and confirm a selection.

Charging iPod battery using the dock

In normal standby or power-on mode, you can charge the iPod while docking.

Note:

– iPod charging is not available in **ECO** power standby mode.

Listening to an external source

This feature allows you to listen to music from the external equipment through the powerful speakers of the Hi-Fi system.

- 1 Use an Aux-in cable (supplied) to connect the AUX 1 or AUX 2 jack (3.5mm, located on the bottom panel) to an AUDIO OUT or headphone jack on an external device (such as TV, Laser Disc player; DVD player or CD recorder).
- 2 Press **SOURCE** on the system repeatedly (or **AUX** on the remote control) to select "AUX 1" or "AUX 2".

Note:

- Refer to the operating instructions for the connected equipment for details.

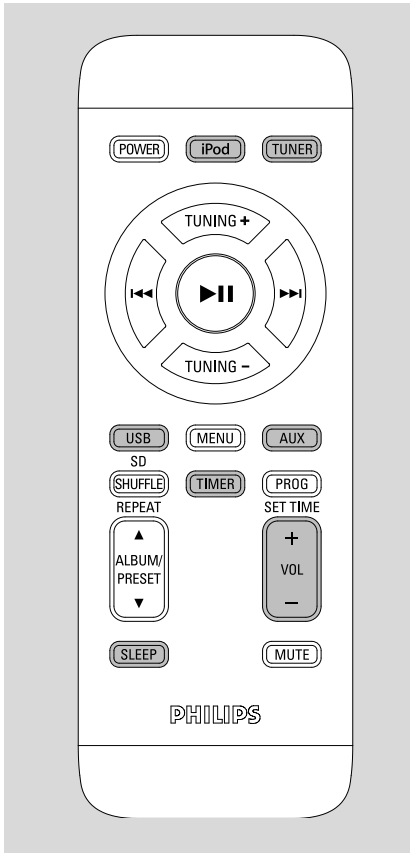

Clock setting

The clock can be set in either 12-hour or 24-hour mode (12HR or 24HR for example).

- 1 In standby mode, press and hold **PROG/SET TIME** on the remote control.
- 2 Press **VOLUME +/-** on the system (or **VOL +/-** on the remote control) to switch between 12 hour and 24 hour display.
- 3 Press **PROG/SET TIME** on the remote control again to confirm.
→ The clock digits flash on the display panel.
- 4 Press **VOLUME +/-** on the system (or **VOL +/-** on the remote control) to set the hours.
- 5 Press **PROG/SET TIME** on the remote control again.
→ The clock digits for the minutes flash.

- 6 Press **VOLUME +/-** on the system (or **VOL +/-** on the remote control) to set the minutes.
- 7 Press **PROG/SET TIME** on the remote control to confirm the time.

Timer setting

- The system can be used as an alarm clock, whereby the TUNER (FM)/iPod/USB/CARD (SD/MMC) is switched on at a set time (one time operation). The clock time needs to be set first before the timer can be used.
 - During setting, if no button is pressed within 30 seconds, the system will exit timer setting mode automatically.
- 1 In standby mode, press **TIMER** for more than two seconds.
 - 2 Press **SOURCE** on the system repeatedly (or the respective source keys on the remote control) to select the sound source.
 - 3 Press **TIMER** to confirm your desired mode.
→ The clock digits for the hours flash.
 - 4 Press **VOLUME +/-** on the system (or **VOL +/-** on the remote control) to set the hours.
 - 5 Press **TIMER** again.
→ The clock digits for the minutes flash.
 - 6 Press **VOLUME +/-** on the system (or **VOL +/-** on the remote control) to set the minutes.
 - 7 Press **TIMER** to confirm the time.
→ The timer is now set and activated.

Activating and deactivating timer

- In standby or during playback, press **TIMER once** on the remote control.
→ Display shows  if activated, and disappears if deactivated.

Notes:

- *Timer is not available in AUX mode.*
- *If USB/SD/MMC source is selected and no compatible USB/SD/MMC device is plugged, TUNER will be selected automatically.*

Clock/Timer

Sleep timer setting

The sleep timer enables the system to switch off by itself after a set period of time.

- 1 In power on mode, press **SLEEP** on the remote control repeatedly to select a preset time.
→ The selections are as follows (time in minutes):
120 → 90 → 60 → 45 → 30 → 15 → OFF → 120 ...
→ "SLEEP xx" is displayed. "xx" is the time in minutes.
→ "SLEEP" is displayed if the sleep time you have selected is not **OFF**.
- 2 When you reach the desired length of time, stop pressing the **SLEEP** button.

To deactivate the sleep timer

- Press **SLEEP** repeatedly until "OFF" is displayed, or press **POWER**.

Specifications

AMPLIFIER

Output power	2 x 25 W RMS
Signal-to-noise ratio	≥ 70 dBA
Frequency response	20 Hz – 20 KHz, ± 3 dB
(Subwoofer)	50 - 180Hz
Input sensitivity AUX	0.5 V (max. 2 V)
Impedance loudspeakers	4 Ω
(Subwoofer)	8 W

TUNER

FM wave range	87.5 – 108 MHz
Antenna	
FM	75 Ω wire

USB PLAYER/SD/MMC CARD

USB	12Mb/s, V1.1
.....	support MP3 and WMA files
Number of albums/folders	maximum 99
Number of tracks/titles	maximum 400

GENERAL INFORMATION

AC Power (for the main unit)	100 – 240 V,
.....	50/60 Hz
AC Power (for the subwoofer)	110V, 60Hz
Dimensions (w x h x d, main unit)	
.....	210 x 200 x 567 (mm)
Dimensions (w x h x d, subwoofer)	
.....	70 x 197 x 302 (mm)
Weight (main unit)	3 kg
Weight (subwoofer)	3.3 kg
Wireless subwoofer connection	2.4GHz, AFH
Standby power consumption	<2 W
Eco power standby	<1 W

Specifications and external appearance are subject to change without notice.

Maintenance

Cleaning the Cabinet

- Use a soft cloth slightly moistened with a mild detergent solution. Do not use a solution containing alcohol, spirits, ammonia or abrasives.

Troubleshooting

WARNING

Under no circumstances should you try to repair the system yourself, as this will invalidate the warranty. Do not open the system as there is a risk of electric shock.

If a fault occurs, first check the points listed below before taking the system for repair. If you are unable to remedy a problem by following these hints, consult your dealer or Philips for help.

Problem	Solution
Radio reception is poor.	<ul style="list-style-type: none">✓ If the signal is too weak, adjust the antenna or connect an external antenna for better reception.✓ Increase the distance between the Micro HiFi System and your TV or VCR.
The system does not react when buttons are pressed.	<ul style="list-style-type: none">✓ Remove and reconnect the AC power plug and switch on the system again.
Sound cannot be heard or is of poor quality.	<ul style="list-style-type: none">✓ Adjust the volume.
The remote control does not function properly.	<ul style="list-style-type: none">✓ Select the source (iPod or TUNER, for example) before pressing the function button (▶ , ◀◀ / ▶▶).✓ Reduce the distance between the remote control and the system.✓ Insert the battery with its polarities (+/- signs) aligned as indicated.✓ Replace the battery.✓ Point the remote control directly toward IR sensor on the front of the system.
The timer is not working.	<ul style="list-style-type: none">✓ Set the clock correctly.✓ Switch on the timer.
The Clock/Timer setting is erased.	<ul style="list-style-type: none">✓ Power has been interrupted or the power cord has been disconnected. Reset the clock/timer.
Some files on the USB device are not displayed.	<ul style="list-style-type: none">✓ Check if the number of folders exceeds 99 or the number of titles exceeds 400.
"DEVICE NOT SUPPORTED" scrolls on the display.	<ul style="list-style-type: none">✓ Remove the USB mass storage device or select another source.

Problem	Solution
Wireless connection with the subwoofer fails	<ul style="list-style-type: none">✓ Ensure that the subwoofer is powered on.✓ The distance between the main set and subwoofer may exceed the maximum range of wireless communication. Move the subwoofer closer to the main set.✓ Obstacles may exist between the main set and subwoofer. Remove the obstacles.✓ Strong interference may exist. Ensure there is no strong interference that may impair the communication between the main set and subwoofer.✓ If the problem remains, see "Preparations - Connecting the wireless subwoofer" for manual pairing.

PHILIPS LIMITED WARRANTY ONE (1) YEAR

WARRANTY COVERAGE:

PHILIPS warranty obligation is limited to the terms set forth below.

WHO IS COVERED:

Philips warrants the product to the original purchaser or the person receiving the product as a gift against defects in materials and workmanship as based on the date of original purchase ("Warranty Period") from an Authorized Dealer. The original sales receipt showing the product name and the purchase date from an authorized retailer is considered such proof.

WHAT IS COVERED:

The Philips warranty covers new products if a defect in material or workmanship occurs and a valid claim is received by Philips within the Warranty Period. At its option, Philips will either (1) repair the product at no charge, using new or refurbished replacement parts, or (2) exchange the product with a product that is new or which has been manufactured from new, or serviceable used parts and is at least functionally equivalent or most comparable to the original product in Philips current inventory, or (3) refund the original purchase price of the product.

Philips warrants replacement products or parts provided under this warranty against defects in materials and workmanship from the date of the replacement or repair for ninety (90) days or for the remaining portion of the original product's warranty, whichever provides longer coverage for you. When a product or part is exchanged, any replacement item becomes your property and the replaced item becomes Philips' property. When a refund is given, your product becomes Philips' property.

Note: Any product sold and identified as refurbished or renewed carries a ninety (90) day limited warranty.

Replacement product can only be sent if all warranty requirements are met. Failure to follow all requirements can result in delay.

WHAT IS NOT COVERED - EXCLUSIONS AND LIMITATIONS:

This Limited Warranty applies only to the new products manufactured by or for Philips that can be identified by the trademark, trade name, or logo affixed to it. This Limited Warranty does not apply to any non-Philips hardware product or any software, even if packaged or sold with the product. Non-Philips manufacturers, suppliers, or publishers may provide a separate warranty for their own products packaged with the bundled product.

Philips is not liable for any damage to or loss of any programs, data, or other information stored on any media contained within the product, or any non-Philips product or part not covered by this warranty. Recovery or reinstallation of programs, data or other information is not covered under this Limited Warranty.

This warranty does not apply (a) to damage caused by accident, abuse, misuse, neglect, misapplication, or non-Philips product, (b) to damage caused by service performed by anyone other than Philips or Philips Authorized Service Location, (c) to a product or a part that has been modified without the written permission of

Philips, or (d) if any Philips serial number has been removed or defaced, or (e) product, accessories or consumables sold "AS IS" without warranty of any kind by including refurbished Philips product sold "AS IS" by some retailers.

This Limited Warranty does not cover:

- Shipping charges to return defective product to Philips.
- Labor charges for installation or setup of the product, adjustment of customer controls on the product, and installation or repair of antenna/signal source systems outside of the product.
- Product repair and/or part replacement because of improper installation or maintenance, connections to improper voltage supply, power line surge, lightning damage, retained images or screen markings resulting from viewing fixed stationary content for extended periods, product cosmetic appearance items due to normal wear and tear, unauthorized repair or other cause not within the control of Philips.
- Damage or claims for products not being available for use, or for lost data or lost software.
- Damage from mishandled shipments or transit accidents when returning product to Philips.
- A product that requires modification or adaptation to enable it to operate in any country other than the country for which it was designed, manufactured, approved and/or authorized, or repair of products damaged by these modifications.
- A product used for commercial or institutional purposes (including but not limited to rental purposes).
- Product lost in shipment and no signature verification receipt can be provided.
- Failure to operate per Owner's Manual.

TO OBTAIN ASSISTANCE IN THE U.S.A., PUERTO RICO, OR U.S. VIRGIN ISLANDS...

Contact Philips Customer Care Center at:
1-888-PHILIPS (1-888-744-5477)

TO OBTAIN ASSISTANCE IN CANADA...

1-800-661-6162 (French Speaking)
1-888-PHILIPS (1-888-744-5477) - (English or Spanish Speaking)

REPAIR OR REPLACEMENT AS PROVIDED UNDER THIS WARRANTY IS THE EXCLUSIVE REMEDY FOR THE CONSUMER. PHILIPS SHALL NOT BE LIABLE FOR ANY INCIDENTAL OR CONSEQUENTIAL DAMAGES FOR BREACH OF ANY EXPRESS OR IMPLIED WARRANTY ON THIS PRODUCT. EXCEPT TO THE EXTENT PROHIBITED BY APPLICABLE LAW, ANY IMPLIED WARRANTY OF MERCHANTABILITY OR FITNESS FOR A PARTICULAR PURPOSE ON THIS PRODUCT IS LIMITED IN DURATION TO THE DURATION OF THIS WARRANTY.

Some states do not allow the exclusions or limitation of incidental or consequential damages, or allow limitations on how long an implied warranty lasts, so the above limitations or exclusions may not apply to you.

This warranty gives you specific legal rights. You may have other rights which vary from state/province to state/province.

Philips, P.O. Box 671539, Marietta, GA. 30066-0026

3121 233 48802

Es necesario que lea cuidadosamente su instructivo de manejo.

	PRECAUCIÓN - ADVERTENCIA	
	No abrir, riesgo de choque eléctrico	
	ATENCIÓN	
	Verifique que el voltaje de alimentación sea el requerido para su aparato	
Para evitar el riesgo de choque eléctrico, no quite la tapa. En caso de requerir servicio, dirijase al personal calificado.		

Descripción: **Système de divertissement avec station d'accueil**

Modelo : **DC912/ 37**

Alimentación: **100–240 V~; 50/60 Hz (unidad principal)
110 V, 60 Hz (subwoofer)**

Consumo: **25 W (unidad principal)
40 W (subwoofer)**

Importador: **Philips Mexicana, S.A. de C.V.**

Domicilio: **Av. La Palma No.6
Col. San Fernando La Herradura
Huixquilucan**

Localidad y Tel: **Edo. de México C.P. 52784
Tel.52 69 90 00**

Exportador: **Philips Electronics HK, Ltd.**

País de Origen: **China**

Nº de Serie: _____

**LEA CUIDADOSAMENTE ESTE INSTRUCTIVO
ANTES DE USAR SU APARATO.**

AVISO IMPORTANTE

Philips Mexicana, S.A. de C.V. no se hace responsable por daños o desperfectos causados por:

- *Maltrato, descuido o mal uso, presencia de insectos o roedores (cucarachas, ratones etc.).*
- *Cuando el aparato no haya sido operado de acuerdo con el instructivo del uso, fuera de los valores nominales y tolerancias de las tensiones (voltaje), frecuencia (ciclaje) de alimentación eléctrica y las características que deben reunir las instalaciones auxiliares.*
- *Por fenómenos naturales tales como: temblores, inundaciones, incendios, descargas eléctricas, rayos etc. o delitos causados por terceros (choques asaltos, riñas, etc.).*

POLIZA DE GARANTIA PARA MEXICO

ESTA POLIZA ES GRATUITA

Este aparato ha sido cuidadosamente diseñado y se ha fabricado con los mejores materiales bajo un estricto control de calidad, garantizando su buen funcionamiento por los periodos establecidos según el aparato (ver lista en la parte inferior) a partir de la entrega del aparato al consumidor.

Esta póliza incluye la reparación o reposición gratuita de cualquier parte o componente que eventualmente fallase y la mano de obra necesaria para su reparación, así como los gastos de transportación razonablemente erogados dentro de nuestros centros de servicio, misma que se hará efectiva en cualquiera de nuestros centros de servicio autorizados en el país.

Si su aparato llegase a requerir de nuestro servicio de garantía, acuda al centro de servicio más cercano a su domicilio, de tener alguna duda por favor llame a nuestro **CENTRO DE INFORMACIÓN AL CLIENTE LADA** sin costo en toda la republica al **01 800 504 62 00** en donde con gusto le indicaremos el centro de servicio autorizado más cercano a su domicilio.

PHILIPS MEXICANA S.A. de C.V. a través de sus centros de servicio autorizados **reparará y devolverá a usted su aparato en un plazo no mayor a 20 días hábiles**, contados a partir de la fecha de ingreso, impresa en la orden de servicio de cualquiera de nuestros centros de servicio autorizados.

La garantía de esta póliza cubre cualquier desperfecto o daño eventualmente ocasionado por los trabajos de reparación y/o traslado del aparato en el interior de nuestros centros de servicio autorizados.

Esta póliza sólo tendrá validez, si está debidamente requisitada, sellada por la casa vendedora, en caso de extravío de esta póliza, podrá hacer efectiva su garantía con la presentación de su factura de compra.

ESTA POLIZA NO SE HARA EFECTIVA EN LOS SIGUIENTES CASOS:

-Cuando el aparato sea utilizado en condiciones distintas a las normales.

-Cuando el aparato no haya sido operado de acuerdo con el instructivo de uso que se le acompaña.

-Cuando la causa de la falla o mal funcionamiento sea consecuencia de una reparación inadecuada o alteración producida por personas no autorizadas por PHILIPS MEXICANA S.A. de C.V.

PERIODOS DE GARANTIA

36 MESES.- Monitores para computadora.

12 MESES.- Televisores con y sin reproductor de video digital DVD, videocassetteras, reproductores de discos de video digital DVD, reproductores de disco de video digital con pantalla incluida, grabadores reproductores de disco de video digital DVD, grabadores reproductores de disco compacto, video proyectores (excepto la lámpara) , cámaras de video, radiograbadoras con y sin reproductor de disco compacto, reproductores de cassette portátil, reproductores de disco compacto portátil, reproductores de audio digital MP3 (Internet), decodificadores de señal (IRD), televisores para hotel, sistemas de observación, televisores de proyección, teléfonos celulares, pagers, minisistemas de audio, minisistemas de audio con reproductor de disco de video digital integrado, microsistemas de audio, sistemas de cine en casa, equipos modulares, sintonificadores, facsimils, LNB, antenas de recepción de satélite, DVD ROM, CDR ROM y CDRW ROM para computadora.

6 MESES.- radio relojes, radios A.M./F.M., auto estéreos, teléfonos inalámbricos, cámaras digitales.

3 MESES.- Accesorios, controles remotos, bocinas, cintas para fax y para cámaras de videoconferencia, audífonos.

PHILIPS

Philips Mexicana, S.A. de C.V.

Producto Importado por:
Philips Mexicana, S.A. de C.V.

Av. La Palma No.6
Col. San Fernando La Herradura
Huixquilucan, Edo. de México, C.P. 52784
Tel. 52 69 90 00

Centro de Información al Cliente
Información General

LADA SIN COSTO PARA TODA LA REPUBLICA
01 800 504 62 00
CORREO ELECTRONICO
philips@merkafon.com

MODELO _____ No. DE SERIE _____

La presente garantía contará a partir de: _____ DIA _____ MES _____ AÑO _____

En caso que en su producto presente alguna falla, acuda al centro de servicio más cercano a su domicilio (según listado de talleres anexo) y en caso de tener alguna duda o pregunta por favor llame a nuestro

Centro de información al Cliente, en donde con gusto le atenderemos en todo lo relativo a:

- * Servicio de sus aparatos Philips
- * Información de productos y Talleres Autorizados Philips
- * Asesoría en el manejo e instalación de su producto Philips
- * Información en donde puede adquirir productos y accesorios Philips

Para hacer efectiva la garantía de su producto, es necesario presentar esta póliza debidamente requisitada o de lo contrario, presentar su factura de compra.

CENTROS DE SERVICIO AUTORIZADOS PHILIPS EN LAS PRINCIPALES CIUDADES

NOTA: Los Centros que tengan (S) solo proporcionan Servicio y los que tengan (SR) venden refacciones, accesorios y proporcionan Servicio

CIUDAD	LADA	TELEFONO	CORREO ELECTRONICO		CIUDAD	LADA	TELEFONO	CORREO ELECTRONICO	
ACAPULCO, GRO	744	483-32-86	serprosa@yahoo.com.mx	S	MEXICO, D. F. ZONA NORTE	55	55-67-19-92 55-67-22-66	chyv_electronicas@yahoo.com.mx	S
AGUASCALIENTES, AGS	449	915-51-81	jimsa@hotmai.com	S	MEXICO, D. F. ZONA ORIENTE	55	57-58-89-37	cnoguedam@terra.com.mx	S
CAMPECHE, CAMP.	981	816 25 75	oreza@hotmail.com	S	MEXICO, D. F. ZONA PONIENTE	55	58 12 44 12	raulmtrm@avantel.net	S
CANCUN, Q ROO.	998	984 18 74	gsmmacancun@webtelmex.net.mx	S	MONTERREY, N.L.	818	375-16-17 400-54-03	mccasa@prodigy.net.mx	S
CD. JUAREZ, CHIH	656	618-21-28 923-46-20	teleservicio@prodigy.net.mx	S	MORELIA, MICH	443	312-03-17	multiservicios_profesionales_de_zamorana@msn.com	S
CD. OREGON, SON	644	412-41-51 416-20-93	mena747@prodigy.net.mx	S	NEZAHUALCOYOTL, EDO. MEX	55	57-33-34-98	vicentegutierrez@prodigy.net.mx	S
CD. VICTORIA, TAMPS	834	315-86-03 312-51-93	eeii_smler@yahoo.com.mx	S	OAXACA, OAX	951	516-47-37	elfancisor@prodigy.net.mx	S
COLIMA, COL	312	314-03-01	tv_antenas@hotmail.com	S	ORIZABA, VER	272	724 36 53	barreda_electronics@hotmail.com	S
CUERNAVACA, MOR	777	313-00-49 313-90-92	centroserviciohertz@hotmail.com	S	PACHUCA, HGO	771	714-15-51	zarateco@hotmai.com	S
CULIACAN, SIN	667	716-15-10	stereovox@cdn.megared.net.mx	S	POZA RICA, VER	782	824 47 62	sonydigital@prodigy.net.mx	S
CHIHUAHUA, CHIH	614	421-59-30 421-63-61	comercialdomestica@hotmail.com	S	PUEBLA, PUE	222	249-77-64 231-63-77	rascon12@prodigy.net.mx	S
CHILPANCIÑO, GRO.	747	471 72 73	ingelec_gro@hotmail.com	S	QUERETARO, QRO	442	216-10-09		S
DURANGO, DGO	618	825-00-05	evsurdge@yahoo.com	S	SAN TILLO, COAH	844	415 35 80	electronicadigital_07@hotmail.com	S
GUADALAJARA, JAL	33	36-15-72-62 36-16-83-27	www. Leeocom.com.mx	S	SAN LUIS POTOSÍ, S.L.P	444	815-34-07	centro_serviciosp@prodigy.net.mx	S
HERMOSILLO, SON	662	210-54-95 210-05-86	manuelw@prodigy.net.mx	S	SATELITE, EDO. MEX	55	55 62 99 73	missus_satelite@hotmail.com	S
IRAPUATO, GTO	462	626-61-10	tv_gase@hotmail.com	S	TAMPICO, TAMPS	833	214 13 60	electromovie@prodigy.net.mx	S
LA PAZ, B.C.S	612	122-95-99	conafa@prodigy.net.mx	S	TEPIC, NAY	311	212-66-03	spe_in@hotmail.co	S
LEON, GTO	477	770-26-99	tecespecializados@hotmail.com	S	TIJUANA, B.C.N	664	621-22-15	www.eg1@telhor.net	S
MATAMOROS, TAMPS	868	813-50-13	digitalelectronicas@comunicable.net	S	TOLUCA, EDO. MEX	722	214-83-09		S
MAZATLAN, SIN	669	982-42-21	e_santel@hotmail.com	S	TOLUCA, EDO. MEX	722	213 62 94		S
MERIDA, YUC	999	928-59-05	evia2@prodigy.net.mx	S	TORREON, COAH	871	732-49-49	jomar02@prodigy.net.mx	S
MEXICALI, B.C.N	686	561-98-08 561-86-18	bajaelectronics@aol.com	S	TUXTLA GUTIERREZ, CHIS	961	618-19-08	kcvideo@prodigy.net.mx	S
MEXICO D.F. ZONA ARAGON	55	57 94 06 34	philipservicio@hotmail.com	S	URUAPAN, MICH	452	524-26-38 524-37-78	rosaliaa@mich1.telmex.net.mx	S
MEXICO D.F. ZONA CENTRO	55	55 21 60 07	unitelemex@yahoo.com.mx	SR	VERACRUZ, VER	229	932-78-23 932-44-44	arntza@ver.megared.net.mx	S
MEXICO, D. F. ZONA SUR	55	55-96-71-03 55-36-25-75	centroservicioelectronico@hotmail.com	S	VILLAHERMOSA, TAB	993	314-31-36 314-61-67	villatec@intrasur.net.mx	S
MEXICO, D. F. ZONA NORTE	55	53 68 30 21	tissaser@prodigy.net.mx	S	ZACATECAS, ZAC.	492	922 31 63	sertecnur@hotmail.com	S

Para mayor referencia de Talleres de Servicio Autorizados en otras ciudades comunicarse al 01 800 504 62 00 (lada sin costo)

Validez de la garantía

Todos los productos de la línea de audio y video Philips, se registrarán por un año de garantía internacional (365 días), salvo para Chile donde los productos de las líneas CD Portable y RCR CD, los cuales se rigen por 6 meses de garantía (182 días)

Condiciones de la garantía

Esta garantía perderá su validez sí:

- El defecto es causado por uso incorrecto o en desacuerdo con el manual de instrucciones
- El aparato sea modificado, violado por una persona no autorizada por Philips
- El producto esté funcionando con un suministro de energía (red eléctrica, batería, etc.) de características diferentes a las recomendadas en el manual de instrucciones
- El número de serie que identifica el producto se encuentre de forma adulterada.

Están excluidos de garantía,

- Los defectos que se generen debido al incumplimiento del manual de instrucciones del producto
- Los casos fortuitos o de la fuerza mayor, como aquellos causados por agentes de la naturaleza y accidentes, descargas eléctricas, señales de transmisión débiles.
- Los defectos que se generen debido al uso de los productos en servicios no doméstico/residencial regulares o en desacuerdo con el uso recomendado
- Daños ocasionados por fluctuaciones de voltajes, voltaje fuera de norma o por causas fuera de Philips, como cortocircuitos en los bafles o parlantes.
- En las ciudades en donde no existe el taller autorizado del servicio de Philips, los costos del transporte del aparato y/o el técnico autorizado, corren por cuenta del cliente.
- La garantía no será válida si el producto necesita modificaciones o adaptaciones para que funcione en otro país que no es aquél para el cual fue mercadeado.

El único documento válido para hacer efectiva la garantía de los productos, es la Factura o Boleta de compra del consumidor final.

Aquellos productos que hayan sido adquiridos en otros países y que no estén en el rango normal del país donde se efectuará la reparación, dicha prestación de servicio tomará mas tiempo de lo normal ya que es necesario pedir las partes/piezas al centro de producción correspondiente.

Centros de información

Líneas de atención al consumidor

Chile: 600-7445477

Colombia: 01-800-700-7445

Costa Rica: 0800-506-7445

Ecuador: 1-800-10-1045

El Salvador: 800-6024

Guatemala: 1-800-299-0007

Panamá: 800-8300

Peru: 0800-00100

Rep. Dominicana: 1-800-751-2673

Venezuela: 0800-100-4888

PHILIPS CONSUMER ELECTRONICS NORTH AMERICA
P.O. BOX 671539, Marietta, GA. 30006-0026

Meet Philips at the Internet
<http://www.philips.com/welcome>

English

Français

Español

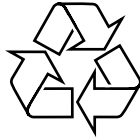

DC912



Free Manuals Download Website

<http://myh66.com>

<http://usermanuals.us>

<http://www.somanuals.com>

<http://www.4manuals.cc>

<http://www.manual-lib.com>

<http://www.404manual.com>

<http://www.luxmanual.com>

<http://aubethermostatmanual.com>

Golf course search by state

<http://golfingnear.com>

Email search by domain

<http://emailbydomain.com>

Auto manuals search

<http://auto.somanuals.com>

TV manuals search

<http://tv.somanuals.com>