

User Manual	6
Manuel D'utilisation	52
Manual del usuario	98
Benutzerhandbuch	144
Gebruikershandleiding	190

***Thank you for choosing Philips.***

***Need help fast?***

*Read your Quick Use/Start Guide and/or User Manual first for quick tips that make using your Philips product more enjoyable.*

*If you have read your instructions and still need assistance, you may access our online help at **[www.philips.com/support](http://www.philips.com/support)***



**PHILIPS**

## Important notes for users in the U.K.

### Mains plug

This apparatus is fitted with an approved 13 Amp plug. To change a fuse in this type of plug proceed as follows:

- 1 Remove fuse cover and fuse.
- 2 Fix new fuse which should be a BS1362 5 Amp, A.S.T.A. or BSI approved type.
- 3 Refit the fuse cover.

If the fitted plug is not suitable for your socket outlets, it should be cut off and an appropriate plug fitted in its place.

If the mains plug contains a fuse, this should have a value of 5 Amp. If a plug without a fuse is used, the fuse at the distribution board should not be greater than 5 Amp.

*Note: The severed plug must be disposed of to avoid a possible shock hazard should it be inserted into a 13 Amp socket elsewhere.*

### How to connect a plug

The wires in the mains lead are coloured with the following code: blue = neutral (N), brown = live (L).

- As these colours may not correspond with the colour markings identifying the terminals in your plug, proceed as follows:
  - Connect the blue wire to the terminal marked N or coloured black.
  - Connect the brown wire to the terminal marked L or coloured red.
  - Do not connect either wire to the earth terminal in the plug, marked E (or e) or coloured green (or green and yellow).

Before replacing the plug cover, make certain that the cord grip is clamped over the sheath of the lead - not simply over the two wires.

### Copyright in the U.K.

Recording and playback of material may require consent. See Copyright Act 1956 and The Performer's Protection Acts 1958 to 1972.

## Italia

### DICHIARAZIONE DI CONFORMITA'

Si dichiara che l'apparecchio HTS3115 Philips risponde alle prescrizioni dell'art. 2 comma 1 del D.M. 28 Agosto 1995 n. 548.

Fatto a Eindhoven

Philips Consumer Electronics  
Philips, Glaslaan 2  
5616 JB Eindhoven, The Netherlands

## Norge

Typeskilt finnes på apparatens underside.

**Observer: Nettbryteren er sekundert innkoplet. Den innebygde nettdelen er derfor ikke frakoplet nettet så lenge apparatet er tilsluttet nettkontakten.**

For å redusere faren for brann eller elektrisk støt, skal apparatet ikke utsettes for regn eller fuktighet.

## ATTENTION!

For Customer Use:

Read carefully the information located at the bottom or rear of your DVD Home Theatre System and enter below the Serial No. Retain this information for future reference.

Model No. HTS3115

Serial No. \_\_\_\_\_

**DK**

**Advarsel: Usynlig laserstråling ved åbning når sikkerhedsafbrydere er ude af funktion. Undgå udsættelse for stråling.**

**Bemærk: Netafbryderen er sekundært indkoblet og afbryder ikke strømmen fra nettet. Den indbyggede netdel er derfor tilsluttet til lysnettet så længe netstikket sidder i stikkontakten.**

**S**

**Klass I laserapparat**

**Varning! Om apparaten används på annat sätt än i denna bruksanvisning specificerats, kan användaren utsättas för osynlig laserstrålning, som överskrider gränsen för laserklass I.**

**Observera! Stömbrytaren är sekundärt kopplad och bryter inte strömmen från nätet. Den inbyggda nåtdelen är därför ansluten till elnätet så länge stickproppen sitter i vägguttaget.**

**SF**

**Luokan I laserlaite**

**Varoitus! Laitteen käyttäminen muulla kuin tässä käyttöohjeessa mainitulla tavalla saattaa altistaa käyttäjän turvallisuusluokan I ylittävälle näkymättömälle lasersäteilylle.**

**Oikeus muutoksiin varataan. Laite ei saa olla alttiina tippu-ja roiskevedelle.**

**Huom. Toiminnanvalitsin on kytketty toisiopuolelle, eikä se kytke laitetta irti sähköverkosta. Sisäänrakennettu verkko-osa on kytkettynä sähköverkkoon aina silloin, kun pistoke on pistorasiassa.**

## **LASER**

Type	Semiconductor laser GaAlAs
Wave length	650 - 660 nm (DVD) 784 - 796 nm (CD)
Output Power	7 mW (DVD) 10 mW (VCD/CD)
Beam divergence	60 degrees

## **CAUTION**

**VISIBLE AND INVISIBLE LASER RADIATION WHEN OPEN. AVOID EXPOSURE TO BEAM**

## **ADVARSEL**

**SYNLIG OG USYNLIG LASERSTRÅLING VED ÅBNING UNDGÅ UDSÆTTELSE FOR STRÅLING**

## **VARNING**

**SYNLIG OCH OSYNLIG LASERSTRÅLNING NÄR DENNA DEL ÄR ÖPPNAD BETRakta EJ STRÅLEN**

## **VARO!**

**AVATTAESSA OLET ALTTIINA NÄKYVÄLLE JA NÄKYMÄTTÖMÄLLE LASER SÄTEILYLLE. ÄLÄ KATSO SÄTEESEEN**

## **VORSICHT**

**SICHTBARE UND UNSICHTBARE LASERSTRAHLUNG WENN ABDECKUNG GEÖFFNET NICHT DEM STRAHL AUSSETZEN**

## **ATTENTION**

**RAYONNEMENT LASER VISIBLE ET INVISIBLE EN CAS D'OUVERTURE EXPOSITION DANGEREUSE AU FAISCEAU**

**This product complies with the radio interference requirements of the European Community.**



**This product complies with the requirements of the following directives and guidelines: 73/23/EEC + 89/336/EEC + 93/68/EEC**

### Disposal of your old product



Your product is designed and manufactured with high quality materials and components, which can be recycled and reused.

When this crossed-out wheeled bin symbol is attached to a product it means the product is covered by the European Directive 2002/96/EC. Please inform yourself about the local separate collection system for electrical and electronic products.

Please act according to your local rules and do not dispose of your old products with your normal household waste. The correct disposal of your old product will help prevent potential negative consequences for the environment and human health.

### Se débarrasser de votre produit usagé (Français)



Votre produit est conçu et fabriqué avec des matériaux et des composants de haute qualité, qui peuvent être recyclés et utilisés de nouveau.

Lorsque ce symbole d'une poubelle à roues barrée est attaché à un produit, cela signifie que le produit est couvert par la Directive Européenne 2002/96/EC.

Veuillez vous informer du système local de séparation des déchets électriques et électroniques.

Veillez agir selon les règles locales et ne pas jeter vos produits usagés avec les déchets domestiques usuels. Jeter correctement votre produit usagé aidera à prévenir les conséquences négatives potentielles contre l'environnement et la santé humaine.

### Cómo deshacerse del producto usado (Español)



Su producto ha sido diseñado y fabricado con materiales y componentes de alta calidad, que pueden ser reciclados y reutilizados.

Cuando vea este símbolo de una papelera con ruedas tachada junto a un producto, esto significa que el producto está bajo la Directiva Europea 2002/96/EC.

Deberá informarse sobre el sistema de reciclaje local separado para productos eléctricos y electrónicos.

Signa las normas locales y no se deshaga de los productos usados tirándolos en la basura normal de su hogar. El reciclaje correcto de su producto usado ayudará a evitar consecuencias negativas para el medio ambiente y la salud de la persona.

### Entsorgung Ihres Altgerätes (Deutsch)



Ihr Produkt ist aus hochqualitativen Materialien und Bestandteilen hergestellt, die dem Recycling zugeführt und wiederverwertet werden können.

Falls dieses Symbol eines durchgestrichenen Müllcontainers auf Rollen auf diesem Produkt angebracht ist, bedeutet dies, dass es von der Europäischen Richtlinie 2002/96/EG erfasst wird.

Bitte informieren Sie sich über die örtlichen Sammelstellen für Elektroprodukte und elektronische Geräte.

Bitte beachten Sie die lokalen Vorschriften und entsorgen Sie Ihre Altgeräte nicht mit dem normalen Haushaltsmüll. Die korrekte Entsorgung Ihres Altgerätes ist ein Beitrag zur Vermeidung möglicher negativer Folgen für die Umwelt und die menschliche Gesundheit.

### Wegwerpen van uw afgedankt apparaat (Nederlands)



Uw apparaat werd ontworpen met en vervaardigd uit onderdelen en materialen van superieure kwaliteit, die gerecycled en opnieuw gebruikt kunnen worden.

Wanneer het symbool van een doorstreepte vuilnisemmer op wielen op een product is bevestigd, betekent dit dat het product conform is de Europese Richtlijn 2002/96/EC.

Geleue u te informeren in verband met het plaatselijke inzamelingsysteem voor elektrische en elektronische apparaten.

Geleue u te houden aan de plaatselijke reglementering en apparaten niet met het gewone huishuif mee te geven. Door afgedankte apparaten op een correcte manier weg te werpen helpt u mogelijke negatieve gevolgen voor het milieu en de gezondheid te voorkomen.



Manufactured under license from Dolby Laboratories, "Dolby", "Pro Logic" and the double-D symbol are trademarks of Dolby Laboratories.



Manufactured under license from Digital Theatre Systems, Inc. U.S. Pat. Nois. 5,451,942; 5,956,674; 5,974,380; 5,978,762; 6,226,616; 6,487,535 and other U.S. and world-wide patents issued and pending. "DTS" and "DTS Digital Surround" are registered trademarks of Digital Theatre Systems, Inc. Copyright 1996, 2003 Digital Inc. All Rights Reserved.



DivX Ultra Certified products: "DivX, DivX Ultra Certified, and associated logos are trademarks of DivX, Inc. and are used under license.



Windows Media and the Windows logo are trademarks, or registered trademarks of Microsoft Corporation in the United States and/or other countries.

## HDMI

HDMI (High Definition Multimedia Interface) is a digital interface that allows pure HD digital video transmission without the loss of image quality. The integrated control bus allows system control between the TV set and connected devices like a digital set top box.

# Index

---

English ..... 6

English

Français ..... 52

Français

Español ..... 98

Español

Deutsch ..... 144

Deutsch

Nederlands ..... 190

Nederlands

# Table of contents

## General

<b>General Information .....</b>	<b>8</b>
Setup precautions.....	8
Accessories supplied .....	8
Cleaning discs .....	8
About recycling.....	8

## Product Overview

<b>Main Unit .....</b>	<b>9</b>
<b>Remote Control.....</b>	<b>10-12</b>
Using the remote control .....	12

## Connections

<b>Basic Connections .....</b>	<b>13-16</b>
Step 1 : Placing the speakers .....	13
Step 2 : Connecting the speakers and subwoofer.....	14
Step 3 : Connecting to TV.....	15
Step 4 : Connecting the FM/MW antennas.....	16
Step 5 : Connecting the power cord .....	16
<b>Optional Connections.....</b>	<b>17</b>
Connecting audio from an analogue audio/video device.....	17

## Basic Setup

<b>Getting Started .....</b>	<b>18-22</b>
Step 1: Turning on the DVD system .....	18
Turning off to Eco Power standby mode.....	18
Step 2: Finding the correct viewing channel.....	18
Step 3: Setting language preferences.....	19
On-screen display (OSD) language.....	19
Audio, Subtitle and Menu language for DVD playback.....	19-20
Step 4: Setting the TV.....	20
Selecting the matching colour system .....	20-21
Setting the TV Display .....	21
Step 5: Setting the speakers' channels .....	22

## Disc Playback

<b>Disc Operations .....</b>	<b>23-30</b>
Playable discs .....	23
Playing a disc .....	23
Basic playback controls.....	24
Selecting various repeat/shuffle functions .....	24
Programming disc tracks.....	25
Other playback features for video discs (DVD/VCD/SVCD) .....	25
Using the Disc Menu .....	25
Viewing playback information.....	26
Resuming playback from the last stopped point .....	26
Zooming in.....	26
Changing subtitle language (DVD only).....	26
Changing sound track language.....	27
Selecting camera angles.....	27
Playback Control (VCD only).....	27
Preview function (VCD/SVCD only).....	27

# Table of contents

Playing an MP3/ JPEG/MPEG-4/Window Media Audio disc .....	28
Playing a JPEG image file (slide show) .....	29
Preview function.....	29
Zoom picture .....	29
Rotating/flipping the picture .....	29
Playing MP3 music and JPEG pictures simultaneously .....	30
Playing a DivX disc .....	30

## USB

<b>USB Operations.....</b>	<b>31</b>
Playing from USB flash drive or USB memory card reader .....	31

## Setup Options

<b>DVD Setup Menu Options.....</b>	<b>32-39</b>
Accessing the DVD setup menu.....	32
General Setup Page.....	33
Audio Setup Page.....	34-35
Video Setup Page.....	36-37
Preference Setup Page .....	38-39

## Radio Tuning

<b>Tuner Operations .....</b>	<b>40-41</b>
Tuning to radio stations.....	40
Presetting radio stations .....	40
Using auto install .....	40-41
Using automatic preset.....	41
Using manual preset.....	41
Selecting a preset radio station.....	41
Deleting a preset radio station.....	41

## Others

<b>Sound and Volume Controls .....</b>	<b>42</b>
Selecting surround sound.....	42
Selecting digital sound effects.....	42
Volume control .....	42
<b>Other Features .....</b>	<b>43</b>
Controlling 'Philips' TV with the remote control.....	43
Software upgrades .....	43
<b>Troubleshooting.....</b>	<b>44-46</b>
<b>Frequently Asked Questions (USB) .....</b>	<b>47</b>
<b>Glossary .....</b>	<b>48-49</b>
<b>Specifications .....</b>	<b>50</b>

## General Information

### CAUTION!

The machine does not contain any user-serviceable parts. Please leave all maintenance work to qualified personnel.

### Setup precautions

#### Finding a suitable location

- Place the set on a flat, hard and stable surface. Do not place the set on a carpet.
- Do not position the set on top of other equipment that might heat it up (e.g., receiver or amplifier).
- Do not put anything under the set (e.g., CDs, magazines).
- Install this unit near the AC outlet where the AC power plug can be easily reached.

#### Space for ventilation

- Place the apparatus in a location with adequate ventilation to prevent internal heat build up. Allow at least 10 cm (4") clearance from the rear and the top of the set and 5cm (2") from the left and right to prevent overheating.

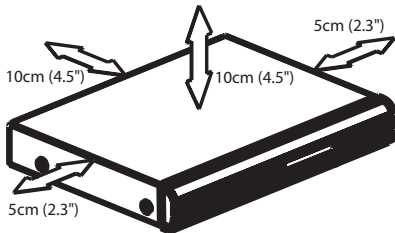

#### Avoid high temperature, moisture, water and dust

- Apparatus must not be exposed to dripping or splashing.
- Do not place any object or items that can damage the apparatus (e.g., liquid filled objects, lighted candles).

### Accessories supplied

- 1 passive subwoofer
- 2 front speakers with speaker stands
- 2 rear speakers
- 1 centre speaker
- 1 remote control with batteries
- 1 scart cable
- 1 FM wire antenna
- 1 MW loop antenna
- Quick Start Guide

### Cleaning discs

Some problems occur (frozen picture, sound disruptions, picture distortions) because the disc inside the unit is dirty. To avoid these problems, discs should be cleaned on a regular basis.

To clean a disc, use a micro fibre cleaning cloth and wipe the disc from the centre to the edge in a straight line.

### CAUTION!

Do not use solvents such as benzene, thinner, commercially available cleaners, or anti-static sprays intended for discs.

### About recycling

These operating instructions have been printed on non-polluting paper. The electronic equipment contains a large number of materials that can be recycled. If you are disposing of an old machine, please take it to a recycling centre. Please observe the local regulations regarding disposal of packaging materials, exhausted batteries and old equipment.



## Main Unit

English

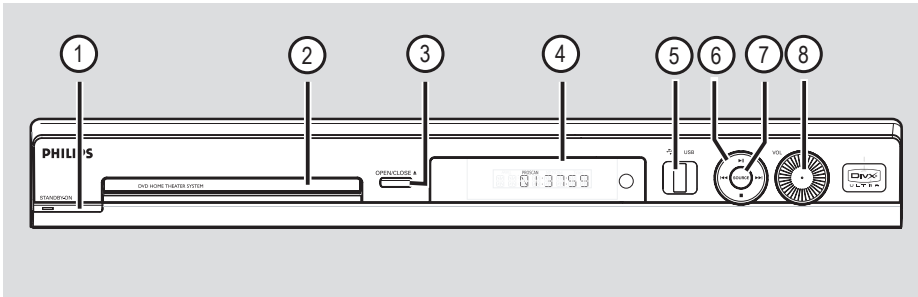

① **STANDBY ON** 

- Turns on the system or turns off to Eco Power standby mode.

② **Disc tray**

③ **OPEN CLOSE** 

- Opens/ closes the disc tray.

④ **System display panel**

⑤ **USB port**

- Input for USB flash drive or USB memory card reader.

⑥ **▶|| (PLAY PAUSE)**

- DISC: starts/pauses playback.
- TUNER: starts auto tuner installation for first time setup.

■ (STOP)

- Exits an operation.
- DISC: stops playback.
- TUNER: hold down this button to erase the current preset radio station.

◀◀ ▶▶

- DISC: moves to the previous/next track or hold down this button to search backward/forward.
- TUNER: selects a preset radio station.

⑦ **SOURCE**

- Selects the relevant active source mode: DISC, TUNER (FM/MW), TV or AUX.

⑧ **VOL**

- Adjusts the volume level.

# Remote Control

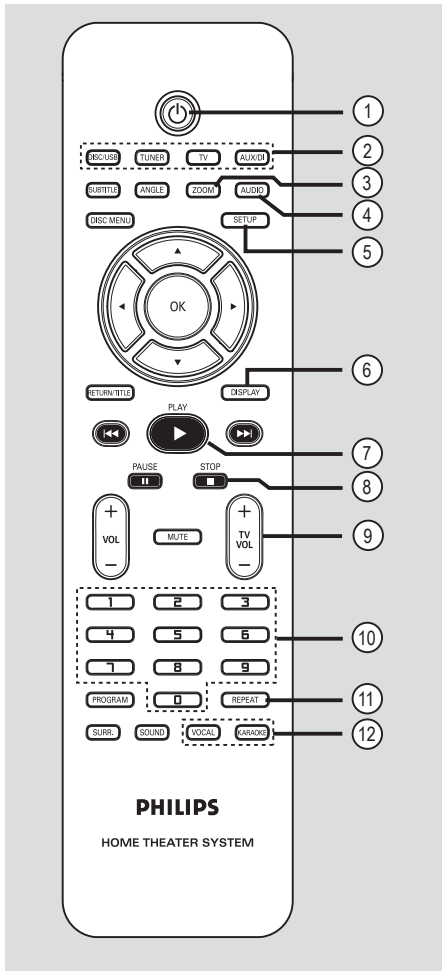

## ①

- Turns on the system or turns off to Eco Power standby mode.

## ② **Source buttons**

- **DISC/USB:** switches to DISC or USB mode.
- **TUNER:** toggles between FM and MW band.
- **TV:** switches to TV mode. The sound from the TV will output through the connected speaker system.
- **AUX/DI:** switches to the external device which is connected to this DVD system.

## ③ **ZOOM**

- Enlarges a picture on the TV screen.

## ④ **AUDIO**

- Selects an audio language (DVD) or an audio channel (CD).

## ⑤ **SETUP**

- Enters or exits the system setup menu.

## ⑥ **DISPLAY**

- Displays the current status or disc information.

## ⑦ **PLAY ▶**

- **DISC:** starts playback.
- **TUNER:** starts auto tuner installation for first time setup.

## ⑧ **STOP ■**

- Exits an operation.
- **DISC:** stops playback.
- **DISC:** hold down this button to open and close the disc tray.
- **TUNER:** hold down this button to erase the current preset radio station.

## ⑨ **TV VOL + –**

- Adjusts TV volume (Philips TV only).

## ⑩ **Numeric Keypad (0-9)**

- Enters a track/title number of the disc.
- Enters a number of a preset radio station.

## ⑪ **REPEAT**

- Selects various repeat modes; turns off repeat mode.

## ⑫ **VOCAL / KARAOKE**

- Not functional for this model.

## Remote Control (continued)

### 13 SUBTITLE

- Selects a DVD subtitle language.

### 14 ANGLE

- Selects a DVD disc camera angle (if available).

### 15 DISC MENU

- For DVD, enters or exits disc contents menu.
- For VCD/SVCD, enters digest menu.

### 16 ◀▶▶▶

- DISC: selects movement direction in the menu.
- DISC: press left or right for fast search and press up or down for slow search.
- TUNER: press up or down to tune the radio frequency.
- TUNER: press left or right to start auto search.

### 17 OK

- Confirms a selection.

### 18 RETURN/TITLE

- For DVD, go back to the previous menu.
- For VCD version 2.0 only; During playback, display the disc title menu or return to the main menu.

### 19 ◀◀▶▶

- DISC: hold down this button for fast forward and backward search.
- TV: selects previous/next channel (Philips TV only).
- TUNER: selects a preset radio station.

### 20 PAUSE II

- DISC: pauses playback and frame-by-frame playback.

### 21 VOL + -

- Adjusts the volume level.

### 22 MUTE

- Mutes or restores the volume.

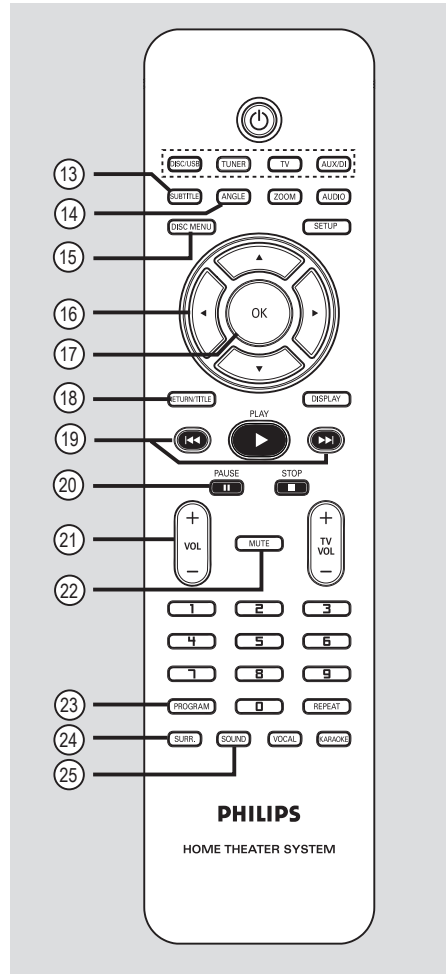

### 23 PROGRAM

- DISC: starts programming.
- TUNER: hold down this button to start automatic/ manual preset programming.

### 24 SURR.

- Selects multi-channel surround or stereo mode.

### 25 SOUND

- Selects a predefined sound effect.

## Remote Control (continued)

### Using the remote control

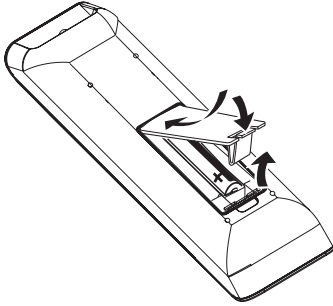

- 1 Open the battery compartment.
- 2 Insert two batteries type R03 or AAA, following the indications (+ -) inside the compartment.
- 3 Close the cover.
- 4 Point the remote control directly at the remote sensor (iR) on the front panel.

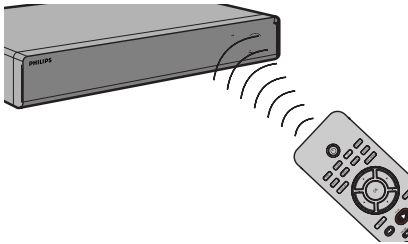

- 5 Select the source you wish to control by pressing the **DISC/USB, TUNER, TV** or **AUX/DI** button on the remote control.
- 6 Then select the desired function (for example **◀◀, ▶▶**).

### CAUTION!

- Remove batteries if they are exhausted or if the remote control is not to be used for a long time.
- Do not mix batteries (old and new or carbon and alkaline, etc.).
- Batteries contain chemical substances, so they should be disposed of properly.

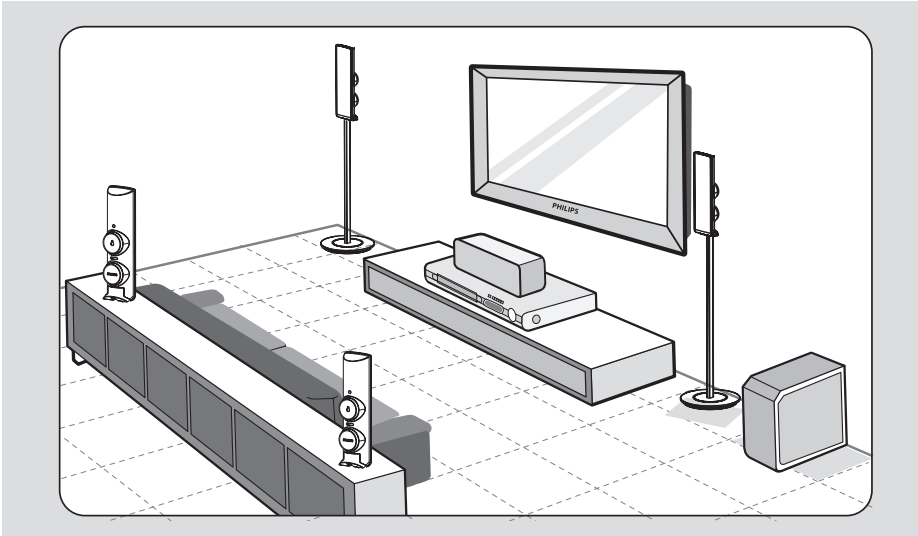

### Step 1: Placing the speakers

The Philips Home Theatre System is simple to install. However, proper system placement is critical to ensure an optimum sound experience.

- 1 Place the front left and right speakers at equal distances from the TV and at an angle of approximately 45 degrees from the listening position.
- 2 Place the centre speaker above the TV or the DVD system so that the centre channel's sound is localised.
- 3 Place the rear speakers at normal listening ear level facing each other.
- 4 Place the subwoofer at the corner of the room. Keep at least one metre away from the TV.

#### Helpful Hints:

- The placement diagram shown here is only a guideline that will provide great system performance. You may find other placement choices that are more suitable for your room layout and provide the sound experience you enjoy.
- To avoid magnetic interference, do not position the front speakers too close to your TV.
- The rear speakers are labeled as REAR LEFT or REAR RIGHT.
- The front speakers are labeled as FRONT LEFT or FRONT RIGHT.

**TIPS:** Before making or changing any connections, make sure that all the devices are disconnected from the power outlet.

## Basic Connections (continued)

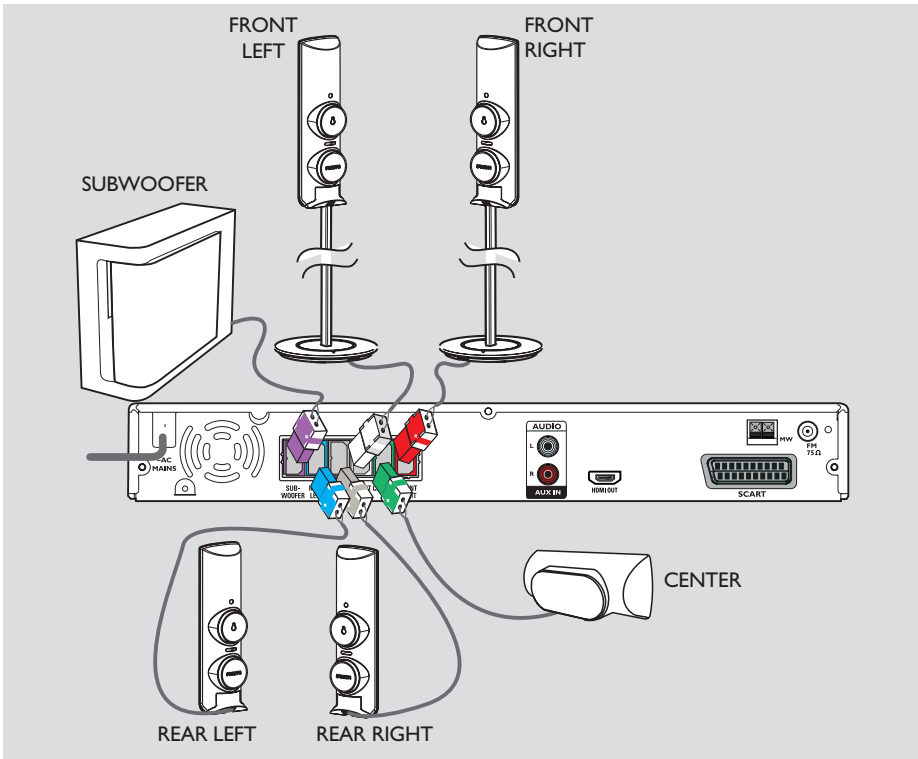

### Step 2: Connecting the speakers and subwoofer

- Connect all the speakers and subwoofer to the speaker sockets at the rear of the DVD system. Make sure that the colours of the plugs and sockets are matched.

#### *Helpful Hint:*

– To prevent unwanted noise, do not place the speakers too close to the DVD system, AC power adapter, TV or any other radiation sources.

**TIPS:** Before making or changing any connections, make sure that all the devices are disconnected from the power outlet.

## Basic Connections (continued)

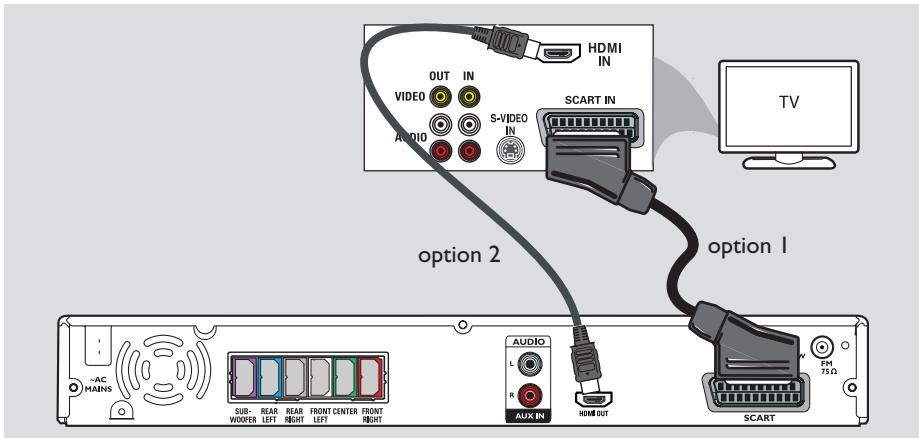

### Step 3: Connecting to TV

This connection enables you to view the playback from this DVD system. You only need to choose **one** of the options below to make the video connection.

- For a standard TV, follow option 1.
- For a HDMI TV, follow option 2.

#### IMPORTANT!

**Connect the DVD system directly to the TV.**

#### Helpful Hint:

– If you are using the scart connection, you can press TV on the remote control to get the sound output from the speakers system when watching the TV programmes.

#### Option 1: Using the Scart socket

- Use the scart cable to connect the **SCART** socket on the DVD system to the corresponding SCART input socket on the TV.

#### Option 2: Connecting to a HDMI-compatible TV

HDMI (High Definition Multimedia Interface) is a digital interface that allows pure digital video transmission without the loss of image quality.

- 1 Use an HDMI cable (not supplied) to connect the **HDMI OUT** on this DVD system to the HDMI IN on a HDMI-compatible device (e.g. HDMI TV, HDCP compliant DVI TV).
- 2 When you have completed the necessary connections, installation and set-up, see 'Audio Setup Page and Video Setup Page' for optimum HDMI audio and video settings.

#### Helpful Hints:

- The HDMI is backward compatible with some DVI devices using an appropriate adaptor plug.
- If a DVI device is connected, an additional audio cable is required for audio transmission.
- Most of the older DVI enable devices are not HDCP compliant and playback is not possible.

**TIPS:** Before making or changing any connections, make sure that all the devices are disconnected from the power outlet.

## Basic Connections (continued)

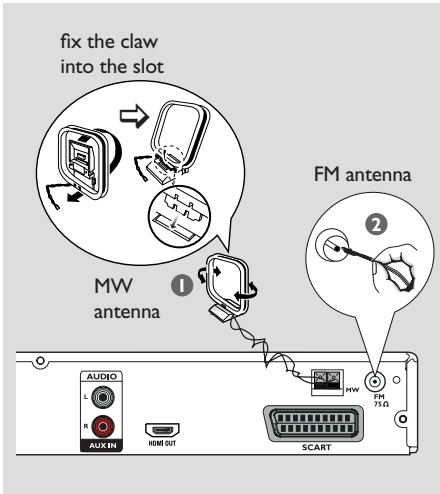

### Step 4: Connecting the FM/ MW antennas

- ① Connect the supplied MW loop antenna to the **MW** socket. Place the MW loop antenna on a shelf, or attach it to a stand or wall.
- ② Connect the supplied FM antenna to the **FM** socket. Extend the FM antenna and fix its ends to the wall.

For better FM stereo reception, connect an external FM antenna (not supplied).

*Helpful Hints:*

- Adjust the position of the antennas for optimal reception.
- Position the antennas as far away as possible from your TV, VCR or other radiation source to prevent any unwanted interference.

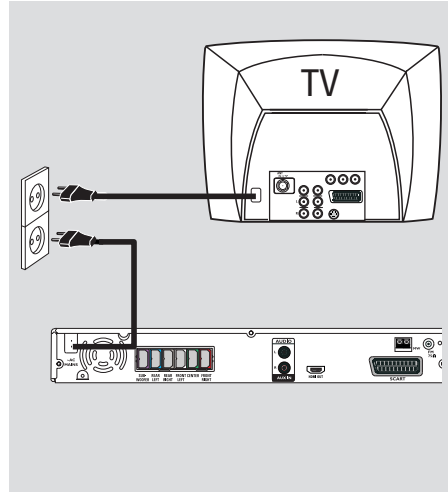

### Step 5: Connecting the power cord

**After everything is connected properly, plug the AC power cord into the power outlet.**

The Eco Power LED on the DVD system will light up. Never make or change any connections with the power turned on.

*Helpful Hints:*

- Refer to the type plate at the rear or bottom of the product for identification and supply ratings.

**TIPS:** Before making or changing any connections, make sure that all the devices are disconnected from the power outlet.



## Optional Connections

English

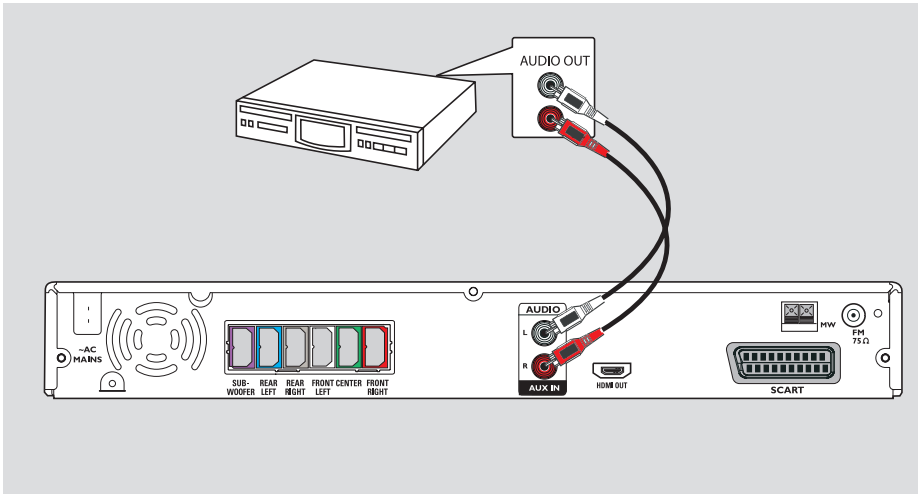

### Connecting audio from an analogue audio/video device

You can connect the audio output from an analogue audio/video device (e.g. VCR, Cable/Satellite Box or TV) to this Home Theatre Audio System in order to enjoy the multi-channel surround sound capabilities

- Use an audio cable (red/white - not supplied) to connect the **AUX IN** sockets on this DVD system to the **AUDIO OUT** sockets on an analogue audio/video device.

To listen to the sound, press **AUX/DI** as the sound source that you want to play.

#### *Helpful Hint:*

– To see the picture of the connected video device (e.g. VCR), connect the **VIDEO OUT** socket of the device to the **VIDEO IN** socket of the TV, and select the correct input channel on the TV.

**TIPS:** Refer to the respective connected device's user manual for other possible connections.

## Getting Started

### Step 1: Turning on the DVD system

- 1 Press **STANDBY ON** (⏻).
- 2 Press the **SOURCE** button on the front panel repeatedly to select :  
DISC → FM → MW → TV → AUX  
→ DISC ....

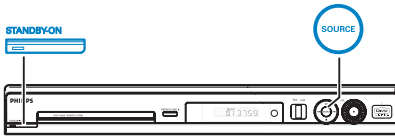

Or

- Press **DISC/USB, TUNER, TV** or **AUX/DI** on the remote control.  
→ If the USB is detected, pressing the **DISC/USB** will toggle between DISC and USB mode.  
→ Press **TUNER** to toggle between FM and MW band.

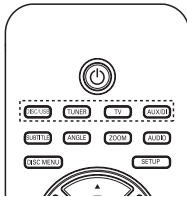

### Turning off to Eco Power standby mode

- Press **STANDBY ON** (⏻).  
→ The display screen will turn off.

### Step 2: Finding the correct viewing channel

#### Before you start ...

Make sure you have completed all the necessary connections.

- 1 Press **SOURCE** button until "DISC" appears on the display panel.
- 2 Turn on the TV and set it to the correct video-in channel. You should see the blue DVD background screen on the TV.  
→ You may go to Channel 1 on your TV, then press the Channel Down button on your TV's remote control until you see the Video In channel.  
→ You may press **⏻** button repeatedly on your TV's remote control.  
→ Usually this channel is between the lowest and highest channels and may be called FRONT, A/V IN, VIDEO. See your TV manual for more details.

## Getting Started (continued)

### Step 3: Setting language preferences

The language options are different depending on your country or region. It may not correspond to the illustrations shown on the user manual.

#### On-screen display (OSD) language

The OSD (On-Screen Display) language for this DVD system will remain as you have set it, regardless of the changes made to the DVD disc language.

- 1 In 'DISC' mode, press **SETUP** on the remote control.  
→ { **General Setup Page** } appears.
- 2 Use ▲▼ keys to highlight { **OSD Language** }, then press ►.



- 3 Use ▲▼ keys to select a language and press **OK** to confirm.

#### Audio, Subtitle and Menu language for DVD playback

You can select your preferred language settings for DVD playback. If the selected language is recorded on the DVD disc, the DVD system will automatically play the disc in that language. Otherwise, the disc's default language will be used instead.

- 1 Press ■ twice to stop playback (if any), then press **SETUP**.
- 2 Press ► repeatedly to select { **Preference Page** }.
- 3 Use ▲▼ keys to highlight one of the options below, then press ►.

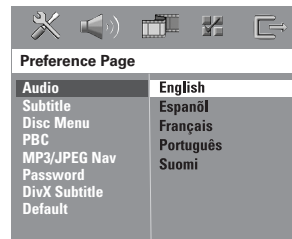

#### { **Audio** }

Selects the preferred audio language for DVD playback.

#### { **Subtitle** }

Selects the preferred subtitle language for DVD playback.

#### { **Disc Menu** }

Selects the preferred disc menu language for DVD playback.

- 4 Use ▲▼ keys to select a language and press **OK** to confirm.

**TIPS:** Press ◀ to go back to the previous menu item. Press **SETUP** to exit the menu.

## Getting Started (continued)

If the language you want is not available in the list, select { **Others** }. Use the **numeric keypad (0-9)** on the remote control to enter the 4-digit language code 'XXXX' (see last page) and press **OK** to confirm.

- 5 Repeat steps 3 ~ 4 for other settings.

### Helpful Hints:

– During DVD playback, you can switch the audio and subtitle languages by pressing the **AUDIO** and **SUBTITLE** buttons on the remote control. However, this does not change the default settings you have made here.

– For some DVDs, the subtitle/audio/menu language can only be changed via the DVD disc menu.

## Step 4: Setting the TV

### Selecting the matching colour system

The colour system of the DVD system, DVD and TV should match. Only then will it be possible to play a DVD on this system. Before changing the TV system, determine the colour system of your TV.

- 1 In 'DISC' mode, press **SETUP** on the remote control.
- 2 Press **▶** repeatedly to select { **Video Setup Page** }.
- 3 Press **▼** to highlight { **TV Type** }, then press **▶**.

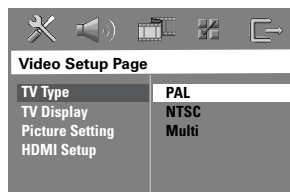

### { **PAL** }

Select this if the connected TV has the PAL colour system. It will change the video signal of an NTSC disc and output it to PAL format.

### { **NTSC** }

Select this if the connected TV has the NTSC colour system. It will change the video signal of a PAL disc and output it to NTSC format.

### { **Multi** }

Select this if the connected TV is compatible with both NTSC and PAL (multi-system). The output format will be in accordance with the video signal of the disc.

**TIPS:** The underlined option is the factory default setting.  
Press **◀** to go back to the previous menu item. Press **SETUP** to exit the menu.

## Getting Started (continued)

- 4 Select one of the options and press **OK** to confirm.  
→ Follow the instructions shown on the TV to confirm the selection (if any).  
→ If a blank/distorted TV screen appears, wait for 15 seconds for the auto recovery.

### Setting the TV Display

Set the aspect ratio of the DVD system according to the TV type you have connected. The format you select must be available on the disc. If it is not, the setting for TV display will not affect the picture during playback.

- 1 In 'DISC' mode, press **SETUP** on the remote control.
- 2 Press **▶** repeatedly to select { **Video Setup Page** }.
- 3 Press **▼** to highlight { **TV Display** }, then press **▶**.

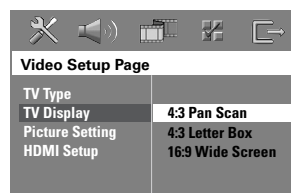

#### { **4:3 Pan Scan** }

Select this if you have a conventional TV and want both sides of the picture to be trimmed or formatted to fit your TV screen.

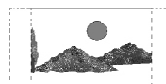

#### { **4:3 Letter Box** }

Select this if you have a conventional TV. In this case, a wide picture with black bands on the upper and lower portions of the TV screen will be displayed.



#### { **16:9 Wide Screen** }

Select this if you have a wide-screen TV.

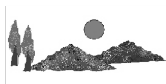

- 4 Select one of the options and press **OK** to confirm.

**TIPS:** The underlined option is the factory default setting.  
Press **◀** to go back to the previous menu item. Press **SETUP** to exit the menu.

## Getting Started (continued)

### Step 5: Setting the speakers' channels

You can adjust the delay times (centre and surround only) and volume level for individual speakers. These adjustments let you optimise the sound according to your surroundings and setup.

#### Before you start...

Stop the disc playback by pressing STOP button twice or remove the disc from the disc tray. Otherwise, the settings are not accessible.

- 1 In 'DISC' mode, press **SETUP** on the remote control.
- 2 Press **▶** repeatedly to select { **Audio Setup Page** }.
- 3 Press **▼** to highlight { **Speakers Volume** }, then press **▶**.

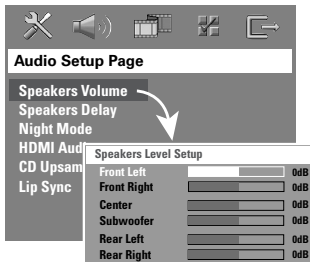

- 4 Use **◀▶** keys to set the volume level for each speaker (-6dB ~ +6dB) and press **OK** to confirm.

- 5 Use **▲▼** keys to highlight { **Speakers Delay** }, then press **▶**.

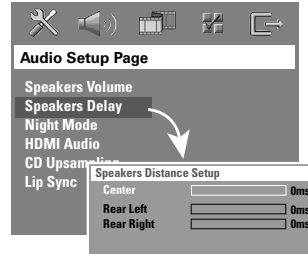

- 6 Use **◀▶** keys to set the delay times (0 ms ~ 15 ms) for centre and rear speakers that best suit your surround sound needs.
- 7 Press **OK** to confirm.

#### Helpful Hints:

- A 1ms increase/decrease of delay time is equivalent to 30 cm change in distance.
- Use the longer delay time settings when the rear speakers are closer to the listener than the front speakers.
- The test tone will be automatically generated to help you judge the sound level of each speaker.

**TIPS:** The underlined option is the factory default setting.  
Press **◀** to go back to the previous menu item. Press **SETUP** to exit the menu.

# Disc Operations

## Playable discs



### Your DVD home theatre system will play:

- Digital Versatile Discs (DVDs)
- Video CDs (VCDs)
- Super Video CDs (SVCDs)
- Finalised DVD+Recordable (DVD±R), DVD+Rewritable (DVD±RW)
- Audio Compact Discs (CDs)
- MP3/ Windows Media™ Audio discs, picture (Kodak, JPEG) files on CD-R(W)
  - ISO 9660/UDF format
  - JPEG resolution support up to 3072 x 2048
  - Supported sampling frequencies : 32 kHz, 44.1 kHz, 48 kHz
  - Supported Bit-rates : 32~256 (kbps), variable bit rates (average 128 kbps)
- DivX files on CD-R(W)/DVD+R(W):
  - DivX 3/4/5/6, DivX Ultra
  - Supports QPEL (Quarter Pixel).

### Region Codes for DVD discs

DVD discs and players are designed with regional restrictions. Before playing a disc, make sure the disc is for the same region as your player. The regional code for this DVD system is indicated at the rear panel.

### IMPORTANT!

- If the inhibit icon (Ø or X) appears on the TV screen when a button is pressed, it means the function is not available on the current disc or at the current time.
- Do not put any objects other than discs on the disc tray. Doing so may cause the disc player to malfunction.

## Playing a disc

- 1 Press **SOURCE** repeatedly until "DISC" appears on the display panel (or press **DISC/USB** on the remote control).
- 2 Turn on the TV to the Video In channel for the DVD system (e.g. 'EXT', '0', 'AV').  
→ You should see the blue DVD background screen on the TV.
- 3 Press **OPEN CLOSE ▲** to open the disc tray and load a disc, then press the same button again to close the disc tray.  
→ Make sure the disc label is facing up. For double-sided discs, load the side which you want to play facing up.
- You can also hold down the **STOP ■** button on the remote control to open and close the disc tray.
- 4 Playback will start automatically.  
→ See the following pages for more playback options and features.

### Helpful Hint:

- If you are having trouble playing a certain disc, remove the disc and try a different one. Improperly formatted discs will not play on this DVD system.

**TIPS:** Some discs cannot be played on this player due to the configuration and characteristics of the disc, or due to the condition of recording and authoring software that was used.

## Disc Operations (continued)

### Basic playback controls

#### Pausing playback

- During playback, press **▶||** (or **||** on the remote control).
  - While in pause mode, you can press **||** repeatedly to view the next still picture (for video playback only).
  - To resume playback, press **▶||** (or **PLAY ▶** on the remote control).

#### Selecting another track/chapter

- Press **◀◀/ ▶▶** or use the **numeric keypad (0-9)** to key in a track/chapter number.
  - If the repeat track mode is active, press **◀◀** again to replay the same track/chapter.

#### Searching backward/forward

- Hold down **◀◀/ ▶▶**.
  - While searching, press **◀◀/ ▶▶** repeatedly to decrease/increase the search speed.
  - To resume normal playback, press **▶||** (or **PLAY ▶** on the remote control).

#### Stopping playback

- Press **■**.

#### Helpful Hint:

– This is a power-saving feature, the system will automatically switch to Eco Power standby mode if you do not press any buttons within 30 minutes after a disc has stopped playing.

### Selecting various repeat/shuffle functions

- While playing a disc, press **REPEAT** on the remote control repeatedly to choose a repeat play mode.

#### DVD

- RPT ONE (repeat chapter)
- RPT TT (repeat title)
- SHUFFLE (random play)
- RPT SHF (repeat random play)
- RPT OFF (exit repeat mode)

#### VCD/SVCD/CD

- RPT ONE (repeat track)
- RPT ALL (repeat disc)
- SHUFFLE (random play)
- RPT SHF (repeat random play)
- RPT OFF (exit repeat mode)

#### MP3/DivX/Windows Media™ Audio

- RPT ONE (repeat track)
- RPT ALL/FLD (repeat folder)
- SHUFFLE (random play)
- RPT OFF (exit repeat mode)

#### Helpful Hint:

– Repeat playback is not possible on VCDs when the PBC mode is turned on.

**TIPS:** The operating features described here might not be possible for certain discs. Always refer to the instructions supplied with the discs.



## Disc Operations (continued)

### Programming disc tracks

(not for Picture CD/MP3)

You can play the contents of the disc in the order you want by programming the playing order of the tracks.

- 1 Press **PROGRAM** on the remote control.  
→ The programming menu appears.

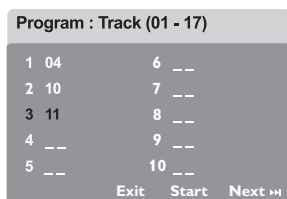

- 2 Use the **numeric keypad (0-9)** to enter a valid track/chapter number.
- 3 Use **◀▶▲▼** keys to move the cursor to the next position.
  - If there are more than ten total programme tracks, select { **Next** } on the screen and press **OK** (or press **▶▶** on the remote control) to access the next programming page.
  - To remove the track/chapter from the programming menu, select the track/chapter and press **OK**.
- 4 Once complete, select { **Start** } on the screen and press **OK** to start playback.  
→ Playback will start from the selected track under the programmed sequence.
- 5 To exit the programme menu, select { **Exit** } in the menu and press **OK**.

### Other playback features for video discs (DVD/VCD/SVCD)

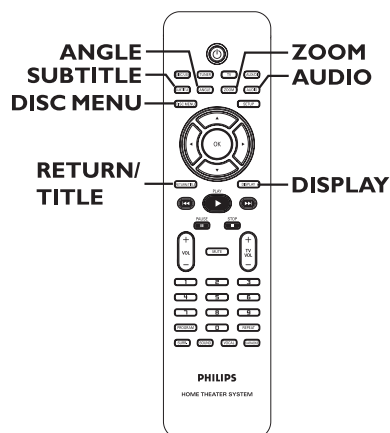

#### Using the Disc Menu

Depending on the disc format, a menu may appear on the TV screen once you load the disc.

#### To select a playback feature or item

- Use **◀▶▲▼** keys or **numeric keypad (0-9)** on the remote control, then press **OK** to start playback.

#### To access or remove the menu

- Press **DISC MENU** on the remote control.

**TIPS:** The operating features described here might not be possible for certain discs. Always refer to the instructions supplied with the discs.

## Disc Operations (continued)

### Viewing playback information

This DVD system can display the disc playback information (for example, title or chapter number, elapsed playing time, audio/subtitle language) and a number of operations can be done without interrupting disc playback.

- 1 During playback, press **DISPLAY**.  
→ A list of available disc information appears on the TV.



- 2 Use **▲▼** keys to view the information and press **OK** to access.
- 3 Use the **numeric keypad (0-9)** to input the number/time or use **▲▼** keys to make the selection, then press **OK** to confirm.  
→ Playback will change according to the chosen time or to the selected title/chapter/track.

### Resuming playback from the last stopped point

This DVD system is able to resume disc playback from its last stopped point (only possible for the last 10 discs that were recorded without a menu).

- 1 Load one of the last 10 discs played.
- 2 While "LOADING" appears on the display panel, press **PLAY ▶** (or **▶||**) to start playback from the last stop point.

### To cancel the resume mode

- Press **■** twice.

### Zooming in

This option allows you to enlarge the picture on the TV screen and to pan through the enlarged picture.

- 1 During playback, press **ZOOM** on the remote control repeatedly to select a different zoom factor.  
→ Use **◀▶▲▼** keys to move through the zoomed image.  
→ Playback will continue.
- 2 Press **ZOOM** repeatedly to return to the original size.

### Changing subtitle language (DVD only)

This operation works only on DVDs with multiple subtitle languages. You can change the language you want while playing a DVD.

- Press **SUBTITLE** repeatedly to select different subtitle languages.

**TIPS:** The operating features described here might not be possible for certain discs. Always refer to the instructions supplied with the discs.

## Disc Operations (continued)

### Changing sound track language

This operation works only on DVDs with multiple soundtrack languages, you can change the language you want while playing a DVD.

- Press **AUDIO** repeatedly to select the available audio languages.

### For VCD – changing the audio channel

- Press **AUDIO** repeatedly to select the available audio channels provided by the disc (STEREO, MONO LEFT, MONO RIGHT or MIX MONO).

### Switching camera angles

This option is only available with DVDs that contain sequences recorded from different camera angles. This allows you to view the picture from different angles.

- Press **ANGLE** repeatedly to select the available camera angles.

### Playback Control (VCD only)

Playback Control (PBC) playback allows you to play Video CDs interactively, following the menu on the display. This function can also be accessed via the 'Preference Page' menu.

### For VCDs with Playback Control (PBC) feature (version 2.0 only)

- During playback, press **RETURN/TITLE** to return to the disc title menu or main menu.

### Preview function (VCD/SVCD only)

This function allows you to preview the contents of a VCD/SVCD.

- 1 Press **DISC MENU**.

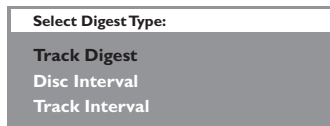

- 2 Use **▲▼** keys to select one of the following options and press **OK**.

#### { Track Digest }

View six different tracks on one screen each time. It allows you to have a quick glance at all the tracks on the disc.

#### { Disc Interval }

View the whole disc in six thumbnail pictures. It divides a disc into six portions at regular intervals and displays them on one screen.

#### { Track Interval }

View the content of a single track in six thumbnail pictures. It divides a single track into six portions at regular intervals and displays them on one screen.

This option is only available during playback mode.

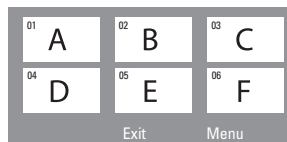

- To go to the previous or next page, press **◀◀ / ▶▶**.
  - To return to the main menu, select { **Menu** } on the screen and press **OK**.
  - Press **OK** on the selected thumbnail picture to start playback from there.
- 3 To exit the preview menu, select { **Exit** } on the screen and press **OK**.

**TIPS:** The operating features described here might not be possible for certain discs. Always refer to the instructions supplied with the discs.

## Disc Operations (continued)

### Playing an MP3/ JPEG/ Windows Media™ Audio disc

This DVD system can playback most of the MP3, JPEG and Windows Media™ Audio files recorded on a CD-R/RW disc or commercial CD.

#### Before you start ...

Turn on your TV to the correct Video In channel. See the section on 'Finding the correct viewing channel'.

- 1 Insert a disc.
  - The disc reading time may exceed 30 seconds due to the complexity of the directory/file configuration.
  - The disc menu appears on the TV.

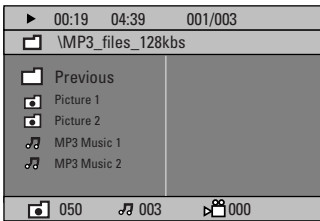

- 2 If the disc main menu contains various folders, use ▲▼ keys to select a desired folder and press **OK** to open the folder.
- 3 Use ▲▼ keys to select a track/file and press **OK** to start playback.
  - Playback will start from the selected file and continue through to the end of the folder.

During playback, you can;

- Press ◀◀/ ▶▶ to playback another track/file in the current folder.
- Hold down ◀◀/ ▶▶ to fast reverse/ forward search for a music track.
- To select another folder from the current disc, press ▲ to return to the root menu. Use ▲▼ keys to make your selection and press **OK** to confirm.
- Press **REPEAT** repeatedly to access various play modes.
- 4 To stop playback, press ■.

#### Helpful Hint:

– To skip the folders menu when you load a MP3/JPEG disc, set the MP3/JPEG NAV setting in the Preference Setup Page to { Without Menu. }.

**TIPS:** Some discs cannot be played on this player due to the configuration and characteristics of the disc, or due to the condition of recording and authoring software that was used.

## Disc Operations (continued)

### Playing a JPEG image file (slide show)

#### Before you start ...

Turn on your TV to the correct Video In channel. See the section on 'Finding the correct viewing channel'.

- Insert a Picture disc (Kodak Picture CD, JPEG).
  - For a Kodak disc, the slide show will begin automatically.
  - For a JPEG disc, the picture menu will appear on the TV. Press **PLAY** ► (or ►||) to start the slide-show playback.

#### Preview function

- 1 During playback, press ■.
  - 12 thumbnail pictures will be displayed on the TV.



- 2 Press ◀◀/ ▶▶ to display the other pictures on the previous/next page.
- 3 Use ◀▶▲▼ keys to highlight one of the pictures and press **OK** to start playback.
- 4 Press **DISC MENU** to return to Picture CD menu.

#### Zoom picture

- 1 During playback, press **ZOOM** repeatedly to select a different zoom factor.
- 2 Use ◀▶▲▼ keys to pan through the zoomed image.

#### Helpful Hint:

– This feature is not applicable for DivX disc.

#### Rotating/flipping the picture

- During playback, use ◀▶▲▼ keys to rotate/flip the picture on the TV.
  - ▲ : flip the picture vertically
  - ▼ : flip the picture horizontally
  - ◀ : rotate the picture anti-clockwise
  - ▶ : rotate the picture clockwise

#### Supported file format:

- The file extension has to be '\*.JPG' and not '\*.JPEG'.
- It can only display DCF-standard still pictures or JPEG pictures e.g. TIFF. It cannot play back moving pictures, Motion JPEG, Progressive JPEG and other formats, or pictures in formats other than JPEG, or pictures associated with sound.
- It may require longer time for the DVD system to display the disc content on the TV due to the large number of songs/pictures compiled into one disc.

**TIPS:** Some discs cannot be played on this player due to the configuration and characteristics of the disc, or due to the condition of recording and authoring software that was used.

## Disc Operations (continued)

### Playing MP3 music and JPEG pictures simultaneously

You can create a musical slide show if the disc contains both the MP3 music and JPEG picture files.

- ① Insert an MP3 disc that contains music and pictures.
- ② Select an MP3 track in the menu and press **PLAY ▶** (or **▶II**) to start playback.
- ③ During MP3 music playback, use **◀▶▲▼** keys to select a picture folder from the disc menu and press **PLAY ▶** (or **▶II**).  
→ The picture files will be played back through to the end of the folder.
- ④ To stop simultaneous playback, press **DISC MENU** and followed by **■**.

#### Helpful Hints:

- It is normal to experience an occasional “skip” while listening to your MP3 disc.
- It is normal to experience an occasional pixelation during MP3/DivX playback due to poor clarity of digital contents during internet downloading.
- Only the first session of a multi-session CD will be played back.

### Playing a DivX disc

This DVD system supports the playback of DivX movies which you can copy from your computer onto a CD-R/RW, DVD+R/+RW disc (see ‘General Setup Page - { DivX(R) VOD code }).

- ① Insert a DivX disc.
- ② If the DivX movie contains external subtitles, the subtitle menu will appear on the TV for your selection.
- In this case, pressing **SUBTITLE** on the remote control will turn the subtitle display on or off.
- ③ Press **PLAY ▶** (or **▶II**) to start playback.

During playback, you can;

- If multilingual subtitles are embedded on the DivX disc, you can press **SUBTITLE** to change the subtitle language while playing.
- Use **◀ / ▶** keys on the remote control to perform fast reverse/forward search.
- Press **DISPLAY** repeatedly until the Time Search menu appears, key in the time where playback should start and press **OK** to confirm.  
→ Playback skips to the time entered.

#### Helpful Hints:

- Subtitle files with the following file name extensions (.srt, .smi, .sub, .ssa, .ass) are supported but do not appear on the file navigation menu.
- The subtitle file name has to be the same as the file name of the movie.
- The subtitle can only be displayed up to an average of 45 characters.

**TIPS:** Some discs cannot be played on this player due to the configuration and characteristics of the disc, or due to the condition of recording and authoring software that was used.

## Playing from USB flash drive or USB memory card reader

This DVD system is able to access and view the data files (JPEG, MP3 or Windows Media™ Audio) in the USB flash drive or USB memory card reader. Editing and copying the data are not possible.

- 1 Insert a USB flash drive or USB memory card reader into the USB port on the front panel.

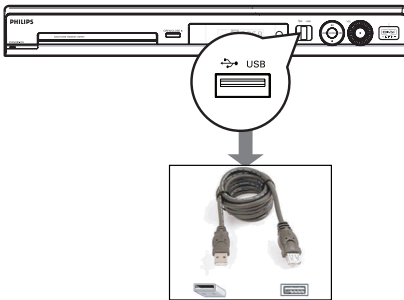

- 2 A message will appear on the TV for 5 (five) seconds when the device is detected.

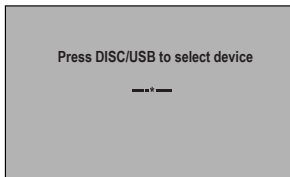

- 3 Press **DISC/USB** on the remote control to access the data in the drive.  
→ The device numbers may vary from different card readers.  
→ For the card reader, only one of the connected device can be accessed.

- During playback, you can press **DISC/USB** to return to the disc mode.
- 4 Before removing the USB device, press **■** to stop playback or press **DISC/USB** to switch to disc mode.

### Helpful Hint:

– If the USB device does not fit into the USB port, a USB extension cable is required.

### Compatibility of the USB device

- The USB port does not support the connection of other USB devices except USB flash drive or USB memory card readers.
- It is not possible to record/copy the data from the USB port to this DVD system.
- Copy-protected contents are not playable.

## DVD Setup Menu Options

### Accessing the DVD setup menu

This DVD system setup is carried out via the TV, enabling you to customise the DVD system to suit your particular requirements.

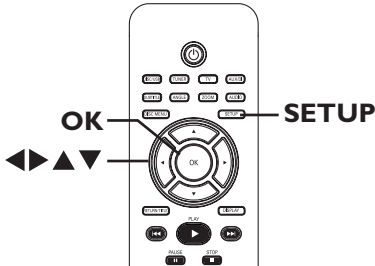

- 1 In 'DISC' mode, press **SETUP** on the remote control.  
→ The setup menu appears.
- 2 Use ◀ ▶ keys to select one of the setup menu pages and press **OK**.

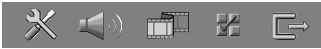

- If you are not able to access the { Preference Page }, press **SETUP** to exit the menu. Then, press **STOP** (■) twice before you press the **SETUP** again.
- 3 Use ▲ ▼ keys to select a setup option and press ▶ to access
  - 4 Select the setting you wish to change and press **OK** to confirm and go back to the previously selected item.  
→ Instructions and explanations of the options are provided in the following pages.  
→ If the option in the menu is greyed out, that means the setting is not available or cannot be changed in the current state.
  - 5 To exit, press **SETUP**.

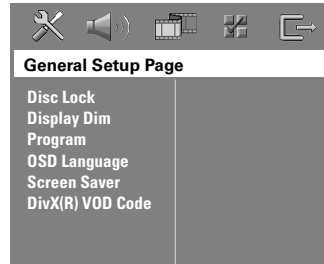

see page 33

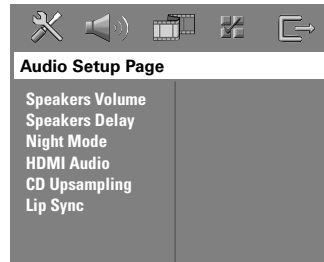

see pages 34~35

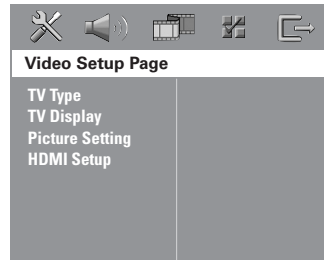

see pages 36~37

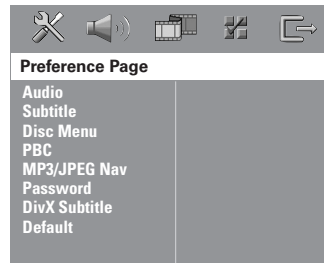

see pages 38~39



## DVD Setup Menu Options (continued)

### General Setup Page (underlined options are the factory default settings)

#### Disc Lock

Not all discs are rated or coded by the disc maker. You can prevent a specific disc from playing by locking the disc. Up to 40 discs can be locked.

- { **Lock** } – Selects this to block the playback of the current disc. Subsequent access to a locked disc requires a six-digit password. The default password is '136900' (see 'Preference Setup Page - { Password }').
- { **Unlock** } – All discs can be played.

#### Display Dim

Selects the brightness of the DVD system display panel.

- { **100%** } – Full brightness.
- { **70%** } – Medium brightness.
- { **40%** } – Dimmest display.

#### Program

Access the track programming menu. See 'Programming disc tracks' chapter.

#### OSD language

Selects the preferred language for the DVD system on-screen display menu.

#### Screen Saver

The screen saver will help prevent damage to your TV display device.

- { **On** } – Turns off the TV to screen saver mode when playback has been stopped or paused for more than 15 minutes.
- { **Off** } – Turns off the screen saver function.

#### DivX(R) VOD code

Philips provides you with the DivX® VOD (Video On Demand) registration code that allows you to rent and purchase videos using the DivX® VOD service. Press ► to see the registration code and press **OK** to exit.

Use the registration code to purchase or rent the videos from DivX® VOD service at [www.divx.com/vod](http://www.divx.com/vod). Follow the instructions and copy the video from your computer onto a CD-R/RW disc for playback on this DVD system.

**Note:** All the downloaded videos from DivX® VOD can only be played back on this DVD system. For more information, visit us at [www.divx.com/vod](http://www.divx.com/vod).

## DVD Setup Menu Options (continued)

### Audio Setup Page (underlined options are the factory default settings)

- Speakers Volume** Access the speaker's level setup menu. Use ◀ ▶ keys to adjust the volume level for each connected speaker between -6dB to +6dB.
- Speakers Delay** Access the speaker's distance setup menu. Use ◀ ▶ keys to set the delay times for the centre and rear speakers based on the listening position and distance.  
**Note:** 1 ms increase/decrease of delay time is equivalent to 30 cm change in distance. Use the longer delay time settings when the rear speakers are closer to the listener than the front speakers.
- Night Mode** This mode optimises playback of sound at low volume. High volume outputs will be softened and low volume outputs will be enhanced to an audible level. This feature is only applicable for DVD video discs with Dolby Digital mode.  
 { **On** } – Turns on night mode.  
 { **Off** } – Turns off night mode feature. Selects this to enjoy the surround sound with its full dynamic range.
- HDMI Audio** This setting is only required if you are using the DVD system's HDMI OUT socket to connect your TV or other display device (see 'Option 2: Connecting to a HDMI-compatible TV').  
**Note:** It may take a while for the DVD system and the input device to communicate and initialise.  
 { **Off** } – Select this if the playback audio format is not supported by HDMI connection (e.g. projector, SACD). It will turn off the HDMI audio output.  
 { **PCM** } – Select this to downmix the audio signals to linear-PCM (2-channel).  
 { **All** } – Select this to enjoy the multi-channel audio output through the HDMI connection.  
**Note:** It is not possible to listen to SACDs or copy-controlled DVD-Audio CPPM (Content Protection for Playable Media) sources using the HDMI connection.

## DVD Setup Menu Options (continued)

### **Audio Setup Page** (underlined options are the factory default settings)

#### **CD Upsampling**

This feature enables you to convert your music CD to a higher sampling rate using sophisticated digital signal processing for better sound quality. If you have activated the CD upsampling feature, the system will automatically switch to stereo mode.

{ Off } – Turns off CD-upsampling.

{ 88.2 kHz (X2) } – Select this to convert the sampling rate of the CDs twice as high as the original rate.

**Note:** If you press the SURR button on the remote control to select multi-channel mode, it will turn off the CD upsampling feature.

#### **Lip Sync**

This feature allows you to delay the sound output in order to synchronise it with the video playback. This may be necessary when you use certain LCD monitors or projectors.

Access the lip sync setup menu. Use ◀ ▶ keys to set the delay times (0 ~ 200 ms) for the audio output.

## DVD Setup Menu Options (continued)

### Video Setup Page (underlined options are the factory default settings)

#### TV Type

Selects the colour system that matches the connected TV. It will enable playback of a different type of disc (PAL or NTSC disc) on this DVD system.

- { PAL } – For PAL-system TV.
- { NTSC } – For NTSC-system TV.
- { **Multi** } – For TV that is compatible with both PAL and NTSC.

#### TV Display

The picture shape can be adjusted to fit your TV.

{ **4:3 Letter Box** } – For a 'wide-screen' display with black bars on the top and bottom.



{ 4:3 Pan Scan } – For a full-height picture with the sides trimmed.



{ **16:9 Wide Screen** } – For wide-screen TV (frame ratio 16:9).



#### Picture Setting

This DVD system provides three predefined sets of picture colour settings and one personal setting which you can define yourself.

- { Standard } – Original colour setting.
- { **Bright** } – Vibrant colour setting.
- { **Soft** } – Warm colour setting.
- { **Personal** } – Selects this to personalise your picture colour setting. Use ◀ ▶ keys to adjust to the setting that best suits your personal preference and press **OK** to confirm. For an average setting, select { 0. }

#### { **Brightness** }

Increase this value to brighten the picture colour or vice versa.

#### { **Contrast** }

Increase this value to sharpen the picture colour or vice versa.

#### { **Tint** }

Increase or decrease this value to change the colour phase of the picture.

#### { **Color** }

Increase this value to enhance the picture colour or vice versa.

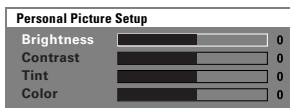

## DVD Setup Menu Options (continued)

### **Video Setup Page** (underlined options are the factory default settings)

#### **HDMI Setup**

It provides the picture settings to enhance the appearance and picture quality for disc playback. This feature is only applicable if you have connected this DVD system to a HDMI-compatible TV/device.

- { **HDMI Video** } – Selects a suitable video resolution depending on the capability of the connected TV/device to further enhance the HDMI video output.
- { **480p** }  
Progressive output in 480 lines for NTSC TV.
  - { **576p** }  
Progressive output in 576 lines for PAL TV.
  - { **720p** } - (if a HDMI TV is connected)  
Progressive output upscale to 720 lines.
  - { **1080i** } - (if a HDMI TV is connected)  
Interlaced output upscale to 1080 lines.
  - { **Auto** }  
The video output will automatically follow the display's supported resolution.

**Note:** If no display appears on the TV due to unsupported resolution, use the composite video cable to connect the DVD system and your TV. Turn on your TV to the correct input channel for the composite video and adjust the resolution setting to 480p/576p.

- { **Wide Screen Format** } – Selects a suitable screen display.
- This feature is only available if you have selected { **TV Display - 16:9 Wide Screen** }.
- { **Superwide** }  
Selects this to display the 4:3 picture disc on the wide-screen TV with non-linear stretching (centre position of the screen is stretched less than the side).
  - { **4:3 Pillar Box** }  
Selects this to display 4:3 picture disc on the wide-screen TV without stretching. Black bars will be shown on the both sides of the TV screen.
  - { **Off** }  
No aspect ratio adjustment is made when this option is selected.

**Note:** The { **Wide Screen Format** } feature will be disabled if your HDMI TV has been preset to { **480p** } or { **576p** } settings.

## DVD Setup Menu Options (continued)

### Preference Setup Page (underlined options are the factory default settings)

<b>Audio</b>	Selects the preferred audio language for DVD playback.
<b>Subtitle</b>	Selects the preferred subtitle language for DVD playback.
<b>Disc Menu</b>	Selects the preferred disc menu language for DVD playback.  <b>Note:</b> If the selected audio/subtitle/disc menu language is not available on the DVD, the disc's default language will be used instead.
<b>PBC</b>	Play Back Control feature is applicable for VCD/SVCD only. It allows you to play Video CDs (2.0) interactively, following the menu on the display. { <u>On</u> } – The index menu (if available) will appear on the TV when you load a VCD/SVCD. { <u>Off</u> } – The VCD/SVCD will skip the index menu and playback directly from the beginning.
<b>MP3/JPEG Nav</b>	MP3/JPEG Navigator can only be set if the disc is recorded with a menu. It allows you to select different display menus for easy navigation. { <u>Without Menu</u> } – Displays all the files contained in the MP3/Picture disc. { <u>With Menu</u> } – Displays the folder menu of the MP3/Picture disc.  <b>Note:</b> This DVD system can only display 648 files/folder in the directory.
<b>Password</b>	The password is used for the Disc Lock. Enter your six-digit password to play a locked disc or when prompted for a password. The default password is '136900'. To change the password: 1) Press <b>OK</b> to access the change password menu. 2) Use the <b>numeric keypad 0-9</b> on the remote control to enter your existing six-digit password at { Old Password }. <b>Note:</b> When doing this for the first time or if you forget your existing password, key in '136900'. 3) Enter the new six-digit password at { New Password }. 4) Enter the new six-digit password again at { Confirm PWD }. 5) Press <b>OK</b> to confirm and exit the menu.

Change Password

Old Password

New Password

Confirm PWD

**OK**

## DVD Setup Menu Options (continued)

### **Preference Setup Page** (underlined options are the factory default settings)

#### **DivX Subtitle**

Selects the font type that supports the recorded DivX subtitle.

- { **Standard** } – Displays a standard list of Roman subtitle fonts provided by this DVD system.
- { **Others** } – Displays other subtitle fonts.

#### **Default**

This feature enables you to reset all the setup menu options and your personal settings to the factory defaults, except your password for the Disc Lock. Press **OK** to confirm the default reset.

## Tuner Operations

### IMPORTANT!

Make sure the FM and MW antennas are connected.

### Tuning to radio stations

- 1 Press **SOURCE** repeatedly until "FM" appears on the display panel (or press **TUNER** on the remote control).
- 2 Press ◀ / ▶ briefly on the remote control to start tuning.  
→ "SEARCH > or <" will appear on the display panel until a radio station with sufficient signal strength is found.
- 3 Repeat step 2 if necessary until you find the desired radio station.
- 4 To fine-tune the reception of a weak station, press ▲ / ▼ briefly and repeatedly until optimal reception is found.

#### Helpful Hint:

– If the FM radio station is transmitting RDS (Radio Data System) data, the RDS name will be displayed and stored.

### Presetting radio stations

You can store up to 40 FM and 20 MW preset radio stations in the memory. There are three different ways to programme the radio stations:

- Using auto install (for first time setup only)
- Using automatic preset
- Using manual preset

#### Helpful Hints:

- The system will exit presetting mode if no button is pressed within 20 seconds.
- If no stereo signal is detected or less than 5 (five) stations are detected during tuner installation, "PLEASE CHECK ANTENNA" appears.

### Using auto install

This feature is only applicable for first time radio station programming. You will be prompted to install the radio stations when you access the tuner mode. With one touch of button, all the available radio stations will be stored automatically.

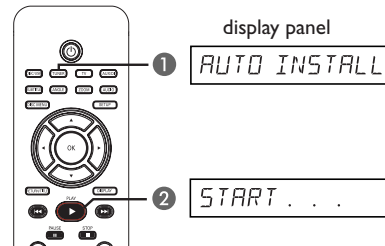

- 1 Press **TUNER**.  
→ "AUTO INSTALL PRESS PLAY" appears.



## Tuner Operations (continued)

- 2 Press **PLAY** ► until “START ...” appears on the display panel.
  - The system will start searching from the FM band followed by the MW band.
  - All the available radio stations with strong signal will be stored automatically.
  - Once complete, the last tuned radio station will be played back.

### Using automatic preset

Use automatic presetting to store or reinstall all the preset radio stations.

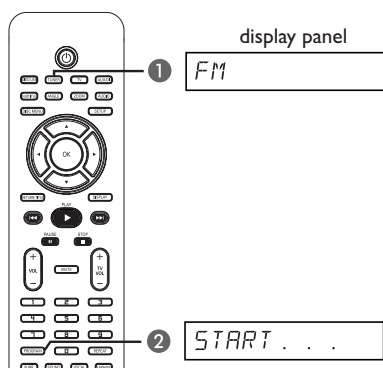

- 1 Press **TUNER** to select “FM” or “MW” band.
- 2 Hold down **PROGRAM** until “START ...” appears on the display panel.
  - All previously stored radio stations will be replaced.

### Using manual preset

Use manual presetting to store your favourite radio stations.

- 1 Tune to your desired radio station (see ‘Tuning to radio stations’).
- 2 Press **PROGRAM**.
- 3 Use **◀◀/ ▶▶** keys to select a preset number that you want to store the current radio station.
- 4 Press **PROGRAM** to store.

### Selecting a preset radio station

- 1 Press **TUNER** to select “FM” or “MW” band.
- 2 Use **◀◀/ ▶▶** keys to select a preset number (or use the numeric keypad on the remote control).
  - The waveband, preset number followed by the radio frequency will appear on the display panel.

### Deleting a preset radio station

- 1 In tuner mode, use **◀◀/ ▶▶** keys to select a preset radio station.
- 2 Hold down **■** until “FM/MW X DELETED” appears.
  - “X” is the preset number.
  - The radio station continues to play but has been deleted from the preset list.
  - The rest of the preset radio stations remain unchanged.

## Sound and Volume Controls

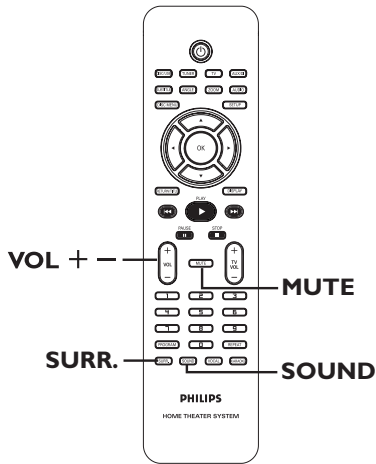

### Selecting surround sound

- Press **SURR.** to select : DOLBY+PL II (multi-channel) or STEREO.
  - The availability of the various surround sound modes depends on the sound available on the disc.
  - The centre and rear speakers operate only in multi-channel surround mode.
  - The available output modes for Multi-channel include: Dolby Digital, DTS (Digital Theatre Systems) Surround and Dolby Pro Logic II.
  - Stereo broadcasts or recordings will produce some surround channel effects when played in a surround mode. However, mono (single channel sound) sources will not produce any sound from the rear speakers.

#### Helpful Hint:

– You are not able to select the surround sound mode if the system setup menu is turned on.

### Selecting digital sound effects

Select a preset digital sound effect that matches your disc's content or that optimises the sound of the musical style you are playing.

- Press **SOUND** to select the available sound effect.

When playing movie discs or in TV mode, you can select : CONCERT, DRAMA, ACTION or SCI-FI.

When playing music discs or while in TUNER or AUX/DI mode, you can select : CLASSIC, JAZZ, ROCK or DIGITAL.

#### Helpful Hint:

– For flat sound output, select CONCERT or CLASSIC.

### Volume control

- Press **VOL +/–** on the remote control to increase or decrease the volume level.
  - “VOL MIN” is the minimum volume level and “VOL MAX” is the maximum volume level.

#### To turn off the volume temporarily

- Press **MUTE** on the remote control.
  - Playback will continue without sound and “MUTE” appears.
  - To restore the volume, press **MUTE** again, or increase the volume level.

## Other Features

### Controlling 'Philips' TV with the remote control

This DVD system's remote control enables you to control the basic functions of your 'Philips' brand TV.

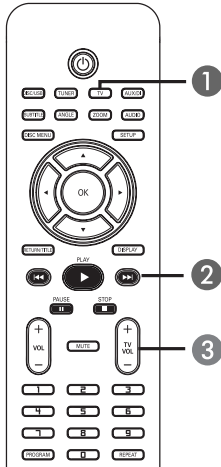

- 1 Press **SOURCE** repeatedly until "TV" appears on the display panel (or press **TV** on the remote control).
- 2 Use **◀▶** keys or the **numeric keypad (0-9)** to select the TV's channel.
- 3 Press **TV VOL +/-** to adjust the TV's volume level.

### Software upgrades

Periodically Philips will issue software upgrades to enhance your user experience.

#### Before you start ...

Check the current software version of this DVD system:

- 1) Press **OPEN CLOSE ▲** to open the disc tray.
- 2) Press **DISPLAY** on the remote control.

- 1 Visit the Philips website '[www.philips.com/support](http://www.philips.com/support)' to check the availability of the latest software upgrade. Download the software to a CD-R.
- 2 Press **OPEN CLOSE ▲** to open the disc tray.
- 3 Insert the CD-R and press **OPEN CLOSE ▲** again.  
→ The software will start to install on the set automatically.

#### IMPORTANT!

Power supply must not be interrupted during upgrade!

## Troubleshooting

### WARNING

Under no circumstances should you try to repair the system yourself, as this will invalidate the warranty. Do not open the system as there is a risk of electric shock.

If a fault occurs, first check the points listed below before taking the system for repair. If you are unable to solve a problem by following these instructions, consult your dealer or Philips for help.

Problem (General)	Solution
<b>No power.</b>	<ul style="list-style-type: none"> <li>– Check if the AC power cord is properly connected.</li> <li>– Press the (⏻) (STANDBY ON) on the front of the DVD system to turn on the power.</li> </ul>
<b>No picture.</b>	<ul style="list-style-type: none"> <li>– Refer to your TV's manual for correct Video In channel selection. Change the TV channel until you see the DVD screen.</li> <li>– Press the DISC/USB button to select disc mode.</li> </ul>
<b>Completely distorted picture or black/white picture.</b>	<ul style="list-style-type: none"> <li>– If this happens when you are changing the setting of the 'TV TYPE', wait for 15 seconds for the auto recovery.</li> <li>– Check the video connection.</li> <li>– Sometimes a small amount of picture distortion may appear. This is not a malfunction.</li> <li>– Clean the disc.</li> </ul>
<b>No sound or distorted sound.</b>	<ul style="list-style-type: none"> <li>– Adjust the volume.</li> <li>– Check the speaker connections and settings.</li> <li>– Make sure that the audio cables are connected and press the SOURCE button to select the correct input source (for example, TV or AUX/DI) to choose the device that you want to hear through the DVD system.</li> </ul>
<b>There is no sound from the centre and rear speakers.</b>	<ul style="list-style-type: none"> <li>– Make sure that the centre and rear speakers are connected correctly.</li> <li>– Press the SURR. button to select a correct surround sound setting.</li> <li>– Make sure that the source you are playing is recorded or broadcast in surround sound (DTS, Dolby Digital, etc.).</li> </ul>
<b>The remote control does not function properly.</b>	<ul style="list-style-type: none"> <li>– Select the source you want to play (for example, DISC/USB or TUNER) before pressing the function button (▶, ◀◀/▶▶).</li> <li>– Reduce the distance between the remote control and the system.</li> <li>– Replace the batteries with new ones.</li> <li>– Point the remote control directly toward the IR sensor.</li> <li>– Check that the batteries are loaded correctly.</li> </ul>

## Troubleshooting (continued)

Problem (Playback)	Solution
<b>The DVD system does not start playback.</b>	<ul style="list-style-type: none"><li>– Insert a readable disc with the playback side facing down. The DVD+R/CD-R must be finalised.</li><li>– Check the disc type, colour system (PAL or NTSC) and region code.</li><li>– Check for any scratches or smudges on the disc.</li><li>– Press SETUP to turn off the system setup menu screen.</li><li>– You may need to enter the password in order to unlock the disc for playback.</li><li>– Moisture may have condensed inside the system. Remove the disc and leave the system turned on for about an hour.</li></ul>
<b>The aspect ratio of the screen cannot be changed even though you have set the TV display.</b>	<ul style="list-style-type: none"><li>– The aspect ratio is fixed on the DVD disc.</li><li>– Depending on the TV, it may not be possible to change the aspect ratio.</li></ul>
<b>Cannot activate some features such as Angles, Subtitles, or multi-language Audio.</b>	<ul style="list-style-type: none"><li>– The features may not be available on the DVD.</li><li>– Changing the language for the sound or subtitle is prohibited on this DVD.</li></ul>
<b>Not able to select some items in the setup/system menu.</b>	<ul style="list-style-type: none"><li>– Press STOP button twice before selecting the system setup menu.</li><li>– Depending on the disc availability, some menu items cannot be selected.</li></ul>
<b>Unable to play DivX movies.</b>	<ul style="list-style-type: none"><li>– Check that the DivX file is encoded in 'Home Theatre' mode with DivX certified encoder.</li></ul>
<b>Radio reception is poor.</b>	<ul style="list-style-type: none"><li>– If the signal is too weak, adjust the antenna or connect an external antenna for better reception.</li><li>– Increase the distance between the system and your TV or VCR.</li><li>– Tune in to the correct frequency.</li><li>– Place the antenna further away from any equipment that may be causing the interference.</li></ul>
<b>The DVD system does not work.</b>	<ul style="list-style-type: none"><li>– Disconnect the power cord from the power outlet for a few minutes. Reconnect the power cord and try to operate again as usual.</li></ul>

## Troubleshooting (continued)

English

Problem (USB/HDMI/MP3 Direct)	Solution
<b>The contents of the USB flash drive cannot be read.</b>	<ul style="list-style-type: none"><li>– The USB flash drive format is not compatible with the system.</li><li>– Drive is formatted with a different file system which is not supported by this DVD system (e.g. NTFS).</li></ul>
<b>Slow operation of the USB flash drive.</b>	<ul style="list-style-type: none"><li>– Large file size or high memory USB flash drive takes longer time to read and display on the TV.</li></ul>
<b>No HDMI audio output.</b>	<ul style="list-style-type: none"><li>– You will not hear any sound from the HDMI output if the source device is only DVI/HDCP (High-bandwidth Digital Content Protection)-compatible.</li><li>– It is not possible to output SACD or copy-controlled DVD-Audio sources from the HDMI connection.</li></ul>
<b>No HDMI video output.</b>	<ul style="list-style-type: none"><li>– HDMI connection can only be made to HDMI-equipped devices with HDCP (High Bandwidth Digital Content Protection). If you wish to connect to a DVI connector (equipped with HDCP), you will need a separate adaptor (DVI to HDMI).</li><li>– Make sure the resolution of this DVD system matches the device you have connected using the HDMI. See HDMI setting.</li></ul>

## Frequently Asked Questions (USB)

### Why does it take so long to display the contents on my USB device?

- This could be due to the large numbers of files (>500 files/folders) or size of the files (>1MB).
- There could be other non-supported files in the device that the system is trying to read/display.

### What if un-supported devices (e.g. USB mouse, keyboards) are plugged into the system?

- The device may cause the system to be unstable. Remove the unsupported device and unplug the mains cord. Wait for a few minutes before reconnecting the mains cord and power on the system again.

### What happens when I plug in a USB HDD?

- HDD is not supported as the large storage capacity makes navigation very difficult. Transfer the music files (mp3) and photos (jpg) into a flash drive.

### Why does the system fail to detect my USB portable music player?

- The portable music player may require propriety software that is bundled with our system in order to access the contents (eg. playlist).

### What types of file does the system support?

- We support only FAT16 and FAT32, not NTFS.

### Why does the file name appear to be different from what was displayed on my computer (e.g. from “Good Bye. jpg” to “Good\_B~1.jpg”)?

- The length of the file name is restricted by the file system of the device (FAT16), which only supports eight (8) characters.
- The computer may be able to display the full file name as the operating system can convert the file system.

### Is simultaneous USB and Disc playback possible?

- Not possible due to memory limitation. In addition, a different user interface will be needed in order to function and in order to be simple enough to use.

### Why can't I rotate the pictures in my device?

- In order to rotate the pictures in the USB device, a “special” file in the jpeg picture called EXIF must be embedded. This EXIF information may have not been created by the USB device or removed when you edit or copy the picture from other devices using editing programmes.

### Why can't the system play some of my music files, photos or movies?

- The music files may not be playable because of different formats and encoding bit-rates. Similarly, the photos may be of low resolution or too high resolution for the system to support.

## Glossary

---

**Analogue:** Sound that has not been turned into numbers. Analogue sound varies, while digital sound has specific numerical values. These sockets send audio through two channels, the left and right.

**Aspect ratio:** The ratio of vertical and horizontal sizes of a displayed image. The horizontal vs. vertical ratio of conventional TVs is 4:3, and that of wide-screens is 16:9.

**Bit Rate:** The amount of data used to hold a given length of music; measured in kilobits per second, or kbps. Or, the speed at which you record. Generally, the higher the bit rate, or the higher the recording speed, the better the sound quality. However, higher bit rates use more space on a disc.

**Chapter:** Sections of a picture or a music piece on a DVD that are smaller than titles. A title is composed of several chapters. Each chapter is assigned a chapter number enabling you to locate the chapter you want.

**Disc menu:** A screen display prepared for allowing a selection of images, sounds, subtitles, multi-angles, etc to be recorded on a DVD.

**DivX:** The DivX code is a patent-pending, MPEG-4 based video compression technology, developed by DivXNetworks, Inc., that can shrink digital video to sizes small enough to be transported over the internet, while maintaining high visual quality.

**Dolby Digital:** A surround sound system developed by Dolby Laboratories containing up to six channels of digital audio (front left and right, surround left and right, centre and subwoofer).

**Dolby Surround Pro Logic II:** It is an improved matrix decoding technology that provides better spatiality and directionality on Dolby Surround programme material, provides a convincing three dimensional sound field on conventional stereo music recordings and is ideally suited to bring the surround experience to automotive sound. While conventional surround programming is fully compatible with Dolby Surround Pro Logic II decoders, soundtracks will be able to be encoded specifically to take full advantage of Pro Logic II playback, including separate left and right surround channels. (Such material is also compatible with conventional Pro Logic decoders).

**DTS:** Digital Theatre Systems. This is a surround sound system, but it is different from the Dolby Digital. The formats were developed by different companies.

**HDMI:** High-Definition Multimedia Interface (HDMI) is a high-speed digital interface that can transmit uncompressed high definition video and digital multi-channel audio. It delivers perfect picture and sound quality, completely free from noise. HDMI is fully backward-compatible with DVI. As required by the HDMI standard, connecting to HDMI or DVI products without HDCP (High-bandwidth Digital Content Protection) will result in no Video or Audio output.

**HDCP** (High-bandwidth Digital Content Protection) is a specification that provides a secure transmission of digital contents between different devices (to prevent unauthorised copyright).



**JPEG:** A very common digital still picture format. A still picture data compression system proposed by the Joint Photographic Expert Group, which features a small decrease in image quality in spite of its high compression ratio.

**MP3:** A file format with a sound data compression system. "MP3" is the abbreviation of Motion Picture Experts Group 1 (or MPEG-1) Audio Layer 3. By using the MP3 format, one CD-R or CD-RW can contain about 10 times more data than a regular CD.

**Multichannel:** DVDs are formatted to have each sound track constitute one sound field. Multichannel refers to a structure of sound tracks having three or more channels.

**Playback control (PBC):** Refers to the signal recorded on video CDs or SVCDs for controlling playback. By using menu screens recorded on a Video CD or SVCD that supports PBC, you can enjoy interactive playback and searching.

**Region code:** A system allowing discs to be played only in the region designated. This unit will only play discs that have compatible region codes. You can find the region code of your unit by looking at the product label. Some discs are compatible with more than one region (or ALL regions).

**Surround:** A system for creating realistic three dimensional sound fields full of realism by arranging multiple speakers around the listener.

**Title:** The longest section of a movie or music feature on DVD. Each title is assigned a title number, enabling you to locate the title you want.

**VIDEO OUT socket:** Yellow socket on the back of the DVD system that sends the DVD picture video to a TV.

# Specifications

## AMPLIFIER

Output power:	500 W
- Front:	75 W / channel
- Rear:	75 W / channel
- Centre:	100 W
- Subwoofer:	100 W
Frequency Response:	20 Hz – 20 kHz / –3 dB
Signal-to-Noise Ratio:	> 65 dB (CCIR)
Input Sensitivity	
- AUX In:	1000 mV

## TUNER

Tuning Range:	FM 87.5–108 MHz (50 kHz) MW 531–1602 kHz (9 kHz)
26 dB Quieting	
Sensitivity:	FM 20 dB, MW 4 $\mu$ V/m
Image Rejection Ratio:	FM 25 dB, MW 28 dB
IF Rejection Ratio:	FM 60 dB, MW 45 dB
Signal-to-Noise Ratio:	FM 60 dB, MW 40 dB
AM Suppression Ratio:	FM 30 dB
Harmonic Distortion:	FM Mono 3% FM Stereo 3% MW 5%
Frequency Response:	FM 180 Hz–10 kHz / $\pm$ 6 dB
Stereo Separation:	FM 26 dB (1 kHz)
Stereo Threshold:	FM 23.5 dB

## DISC SECTION

Laser Type:	Semiconductor
Disc Diameter:	12cm / 8cm
Video Decoding:	MPEG-1 / MPEG-2 / / DivX 3/4/5/6, Ultra
Video DAC:	12 Bits
Signal System:	PAL / NTSC
Video Format:	4:3 / 16:9
Video S/N:	65 dB
Composite Video	
Output:	1.0 Vp-p, 75 $\Omega$
Audio DAC:	24 Bits / 192 kHz
Frequency Response:	4 Hz–20 kHz (44.1 kHz) 4 Hz–22 kHz (48 kHz) 4 Hz–44 kHz (96 kHz)

## MAIN UNIT

Power Supply Rating:	220–240 V; 50 Hz
Power Consumption:	150 W
Eco Standby power:	< 1 W
Dimensions:	435 x 55 x 328.8 (mm) (w x h x d)
Weight:	2.96 kg

## SPEAKERS

### FRONT speakers

System:	2-way, closed box system
Impedance:	8 $\Omega$
Speaker drivers:	1 x 76mm (3") woofer
Frequency response:	120 Hz – 20 kHz
Dimensions:	249.8 x 1104 x 249.8 (mm) (w x h x d - height includes speaker stand)
Weight:	3.3 kg/each

### REAR speakers

System:	2-way, closed box system
Impedance:	8 $\Omega$
Speaker drivers:	1 x 76 mm (3") woofer
Frequency response:	120 Hz – 20 kHz
Dimensions:	100 x 359 x 99 (mm) (w x h x d)
Weight:	1.15 kg/each

### CENTRE speaker

System:	2-way, closed box system
Impedance:	4 $\Omega$
Speaker drivers:	1 x 76 mm (3") woofer
Frequency response:	120 Hz – 20 kHz
Dimensions:	239 x 99.6 x 69.4 (mm) (w x h x d)
Weight:	0.72 kg

### SUBWOOFER

Impedance:	4 $\Omega$
Speaker drivers:	152 mm (6") woofer
Frequency response:	30 Hz – 120 Hz
Dimensions:	194 x 266 x 339.5 (mm) (w x h x d)
Weight:	3.64 kg

Specifications subject to change without prior notice.



## Free Manuals Download Website

<http://myh66.com>

<http://usermanuals.us>

<http://www.somanuals.com>

<http://www.4manuals.cc>

<http://www.manual-lib.com>

<http://www.404manual.com>

<http://www.luxmanual.com>

<http://aubethermostatmanual.com>

Golf course search by state

<http://golfingnear.com>

Email search by domain

<http://emailbydomain.com>

Auto manuals search

<http://auto.somanuals.com>

TV manuals search

<http://tv.somanuals.com>