

Register your product and get support at
www.philips.com/welcome

HTS3371D

HTS3372D



Thank you for choosing Philips.

Need help fast?

Read your Quick Start Guide and/or User Manual first for quick tips that make using your Philips product more enjoyable.

Register your product and get support at
www.philips.com/welcome

or call
1 866 771 4018
while with your product
(and Model / Serial number)



Philips vous remercie de votre confiance.

Besoin d'une aide rapide?

Le Guide rapide de début et Manuel de l'utilisateur regorgent d'astuces destinées à simplifier l'utilisation de votre produit Philips.

Enregistrez votre produit et accédez à l'assistance sur
www.philips.com/welcome

ou formez le
1 800 661 6162 (Francophone)
1 866 771 4018 (English speaking)
Veillez à avoir votre produit à portée de main
(et model / serial nombre)



Gracias por escoger Philips

Necesita ayuda inmediata?

Lea primero la Guía rápida del comienzo o el Manual del usuario, en donde encontrará consejos que le ayudarán a disfrutar plenamente de su producto Philips.

Visite
www.philips.com/welcome
para registrar su producto y obtener información de contacto y asistencia.

o llame al teléfono
1 866 771 4018
y tenga a mano el producto
(y número de model / serial)

EN	User manual
----	-------------

FR_CA	Manual del usuario
-------	--------------------

ES_LA	Manuel d'utilisation
-------	----------------------



PHILIPS

Contents

1 Important	4	7 Adjust sound	36
Important safety instruction	4	Control the volume	36
Trademark notice	6	Select surround sound	36
		Select a preset sound	36
2 Your Home Theater System	7	8 Adjust settings	37
Feature highlights	7	General setup	37
Product overview	8	Audio setup	39
		Video setup	41
3 Connect	11	Preferences	43
Place the Home Theater System	11	9 Additional Information	45
Connect video cables	11	Update software	45
Connect speakers and subwoofer	14	Care	45
Connect radio antenna	14	10 Specifications	46
Connect audio cables/other devices	15	11 Troubleshooting	48
Connect power cord	17	12 Glossary	50
4 Get started	18		
Insert the remote control batteries	18		
Find the correct viewing channel	19		
Select menu display language	19		
Turn on Progressive Scan	20		
Change speaker settings	21		
Use Philips EasyLink	22		
Select a play source	24		
5 Play	25		
Play a disc	25		
Play video	25		
Play music	28		
Play photo	29		
Play from USB device	31		
Play from portable media player	31		
Play from iPod	32		
Play from radio	33		
6 Advanced features	35		
Create MP3 audio files	35		

1 Important

Important safety instruction

- Read these instructions.
- Keep these instructions.
- Heed all warnings.
- Follow all instructions.
- Do not use this apparatus near water.
- Clean only with dry cloth.
- Do not block any ventilation openings. Install in accordance with the manufacturer's instructions.
- Do not install near any heat sources such as radiators, heat registers, stoves, or other apparatus (including amplifiers) that produce heat.

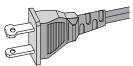

- Do not defeat the safety purpose of the polarized or grounding-type plug. A polarized plug has two blades with one wider than the other. A grounding type plug has two blades and a third grounding prong. The wide blade or the third prong are provided for your safety. If the provided plug does not fit into your outlet, consult an electrician for replacement of the obsolete outlet.
- Protect the power cord from being walked on or pinched, particularly at plugs, convenience receptacles, and the point where they exit from the apparatus.
- Only use attachments/accessories specified by the manufacturer.



- Use only with the cart, stand, tripod, bracket or table specified by the manufacturer or sold with the apparatus.

When a cart is used, use caution when moving the cart/apparatus combination to avoid injury from tip-over.

- Unplug this apparatus during lightning storm or when unused for long periods of time.
- Refer all servicing to qualified service personnel. Servicing is required when the apparatus has been damaged in any way, such as power-supply cord or plug is damaged, liquid has been spilled or objects have fallen into the apparatus, the apparatus has been exposed to rain or moisture, does not operate normally, or has been dropped.
- Battery usage CAUTION - To prevent battery leakage which may result in bodily injury, property damage or damage to the unit:
 - Install all batteries correctly, + and - as marked on the unit.
 - Do not mix batteries (old and new or carbon and alkaline, etc.).
 - Remove batteries when the unit is not used for a long time.
- Apparatus shall not be exposed to dripping or splashing.
- Do not place any sources of danger on the apparatus (e.g. liquid filled objects, lighted candles).
- This product may contain lead and mercury. Disposal of these materials may be regulated due to environmental considerations. For disposal or recycling information, please contact your local authorities or the Electronic Industries Alliance: www.eiae.org.com
- Use of controls or adjustments or performance of procedures other than herein may result in hazardous radiation exposure or other unsafe operation.



Warning

- Modifications not authorized by the manufacturer may void user authority to operate this device.
- Where the mains plug or an appliance coupler is used as the disconnect device, the disconnect device shall remain readily operable.
- Risk of overheating! Never install the Home Theater System in a confined space. Always leave a space of at least 4 inches around the Home Theater System for ventilation. Ensure curtains or other objects never cover the ventilation slots on the Home Theater System.

However, there is no guarantee that interference will not occur in a particular installation. Of this equipment does cause harmful interference to radio or television reception, which can be determined by turning the equipment off and on, the user is encouraged to try to correct the interference by one or more of the following measures:

- Relocate the receiving antenna.
- Increase the separation between equipment and receiver.
- Connect the equipment into an outlet on a circuit different from that to which the receiver is connected.
- Consult the dealer or an experienced radio/TV technician for help.

Recycle notice



This electronic equipment contains a large number of materials that can be recycled or reused if disassembled by a specialized company. If you are disposing of an old machine, please take it to a recycling center. Please observe the local regulations regarding disposal of packaging materials, exhausted batteries and old equipment.

Notice for USA

This equipment has been tested and found to comply with the limits for a Class B digital device, pursuant to part 15 of the FCC Rules. These limits are designed to provide reasonable protection against harmful interference in a residential installation. This equipment generates, uses and can radiate radio frequency energy and, if not installed and used in accordance with the instruction manual, may cause harmful interference to radio communications.

Notice for Canada

Class B Clause

This digital apparatus does not exceed the Class B limits for radio noise emissions from digital apparatus as set out in the Radio Interference Regulations of the Canadian Department of Communications.

This Class B digital apparatus complies with Canadian ICES-003.

Copyright notice



**Be responsible
Respect copyrights**

This product incorporates copyright protection technology that is protected by method claims of certain U.S. patents and other intellectual property rights owned by Macrovision Corporation and other rights owners. Use of this copyright protection technology must be authorised by Macrovision Corporation, and is intended for home and other limited viewing uses only unless otherwise authorised by Macrovision Corporation. Reverse engineering or disassembly is prohibited.

About Progressive Scan

Consumers should note that not all high definition television sets are fully compatible with this product and may cause artifacts to be displayed in the picture. In case of 525 or 625 progressive scan picture problems, it is recommended that the user switch the connection to the 'standard definition' output. If there are questions regarding our TV set compatibility with this model 525p and 625p DVD player, please contact our customer service center.

Trademark notice



Manufactured under license from Dolby Laboratories. Dolby, Pro Logic and the double-D symbol are trademarks of Dolby Laboratories.



DivX, DivX Ultra Certified, and associated logos are trademarks of DivX, Inc. and are used under license. Official DivX® Ultra Certified product. Plays all versions of DivX® video (including DivX® 6) with enhanced playback of DivX® media files and the DivX® Media Format. Plays DivX® video with menus, subtitles and audio tracks.



Windows Media and the Windows logo are trademarks, or registered trademarks of Microsoft Corporation in the United States and/or other countries.



HDMI, and HDMI logo and High-Definition Multimedia Interface are trademarks or registered trademarks of HDMI licensing LLC.



The USB-IF Logos are trademarks of Universal Serial Bus Implementers Forum, inc.



iPod is a trademark of Apple Inc., registered in the U.S. and other countries.

“Made for iPod” means that an electronic accessory has been designed to connect specifically to iPod and has been certified by the developer to meet Apple performance standards.

Apple is not responsible for the operation of this device or its compliance with safety and regulatory standards.



ENERGY STAR and the ENERGY STAR mark are registered U.S. marks.

Philips and Philips Shield are used under license of Koninklijke Electronics NV.



2 Your Home Theater System

Congratulations on your purchase, and welcome to Philips! To fully benefit from the support that Philips offers, register your product at www.philips.com/welcome.

Feature highlights

Video upscaling to 1080p

Enjoy watching discs in the highest picture quality available for your HDTV. This Home Theater System offers full high-definition video playback up to 1080p resolution that provides a highly detailed picture and increased sharpness that delivers a more true-to-life picture for an amazing viewing experience.

Philips EasyLink

Your Home Theater System supports Philips EasyLink, which uses the HDMI CEC (Consumer Electronics Control) protocol. EasyLink-compliant devices that are connected through HDMI connectors can be controlled by a single remote control.



Note

- Philips does not guarantee 100% interoperability with all HDMI CEC devices.

Listen to rich uncompressed multi-channel surround sound

This Home Theater System supports 5.1 channels of uncompressed audio that delivers a real-to-life sound experience as if you are listening to it live.

Hi speed USB 2.0 Link and MP3 link

Simply plug your USB device into the USB jack to play your MP3/WMA/JPEG/DivX files; or plug your portable media player to the MP3 LINK jack to enjoy the music play in superb sound quality.

Sync the audio output with the video play

Synchronize audio and video by delaying the audio output if the video signal sent to the TV is slower than the audio streams.

Create MP3 files

Convert your favorite audio tracks from an audio CD into MP3 format. The created MP3 files are saved in your USB device.

Screen Fit

View the movie in full screen display on any TV.

Region codes

You can play discs with the following region codes.

DVD region code	Countries
 	U.S.A. and Canada

Product overview

Main unit

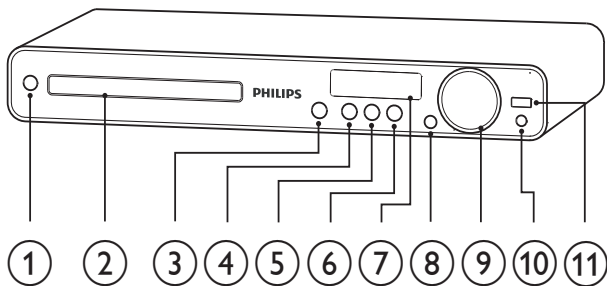

- ① **⏻ (Standby-On)**
 - Turns on the Home Theater System or switches to standby mode.
- ② **Disc compartment**
- ③ **▲ (Open/Close)**
 - Opens or closes the disc compartment.
- ④ **▶|| (Play/Pause)**
 - Starts, pauses or resumes disc play.
 - In radio mode, automatically tunes radio stations during first-time setup.
- ⑤ **■ (Stop)**
 - Stops disc play.
 - In radio mode, erases the current preset radio station.
- ⑥ **SOURCE**
 - Selects a media to play or listen to audio from the connected device.
- ⑦ **Display panel**
 - Displays the current status or disc information.

- ⑧ **IR sensor**
 - Detects signals from the remote control. Point the remote control at the IR sensor.
- ⑨ **VOL**
 - Increases or decreases volume.
- ⑩ **MP3 LINK**
 - Connects a portable audio player
- ⑪ **🔌 (USB)**
 - Connects a USB supported device.

Remote control

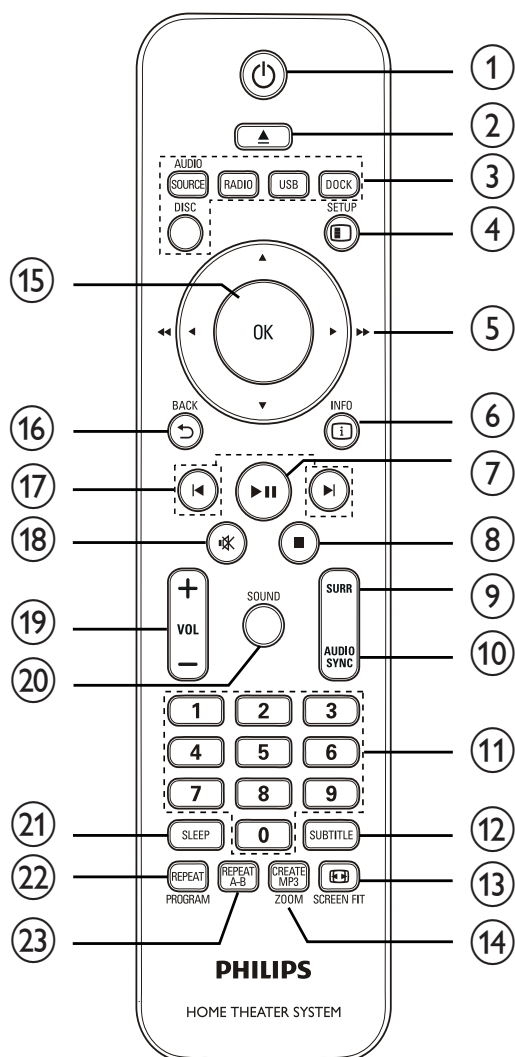

① ⏻ (Standby-On)

- Turns on the Home Theater System or switches to standby mode.
- Press and hold to turn off the Home Theater System and all HDMI CEC compliant devices.

② ▲ (Open/Close)

- Opens or closes the disc compartment.

③ Source buttons

- **AUDIO SOURCE:** Selects an audio input source.
- **RADIO:** Switches to FM band.
- **USB:** Switches to the USB source.
- **DOCK:** Switches to the iPod in the dock.
- **DISC:** Switches to the disc source.

④ ⓘ SETUP

- Accesses or exits the setup menu.

⑤ ▲▼◀▶ (Navigation buttons)

- Navigates through the menus.
- Press left and right for fast backward or forward search.
- In radio mode, press up and down to tune the radio frequency.
- In radio mode, press left or right to start auto search.

⑥ ⓘ INFO

- For discs, displays information about the current status or the disc.
- For slideshows, displays a thumbnail view of photo files.

⑦ ▶|| (Play/Pause)

- Starts, pauses or resumes disc play.
- In radio mode, automatically tunes radio stations during first-time setup.

⑧ ■ (Stop)

- Stops disc play.
- In radio mode, erases the current preset radio station.

⑨ SURR (Surround Sound)





- Switches to supported surround sound or stereo sound.

⑩ AUDIO SYNC

- Selects an audio language or channel.
- Press and hold to access the setting for audio sync, then press **VOL +/-** to set the audio delay time.

⑪ Numeric buttons

- Selects an item to play.

- ⑫ **SUBTITLE**
 - Select DVD or DivX subtitle languages.
- ⑬  **SCREEN FIT**
 - Fits the picture format to the TV screen.
- ⑭ **CREATE MP3/ZOOM**
 - Accesses the menu to create MP3.
 - Zooms in or out of the picture.
- ⑮ **OK**
 - Confirms an entry or selection.
- ⑯  **BACK**
 - Returns to a previous screen.
 - For DVD, goes to the title menu.
 - For VCD version 2.0 or SVCD with PBC turned on, returns to the menu during playback.
- ⑰  **(Previous/Next)**
 - Skips to the previous or next title, chapter, or track.
- ⑱  **(Mute)**
 - Mutes or restores audio output.
- ⑲ **VOL +/-**
 - Increases or decreases volume.
- ⑳ **SOUND**
 - Selects a predefined sound effect.
- ㉑ **SLEEP**
 - Sets a delay after which the Home Theater System switches to standby.
- ㉒ **REPEAT/PROGRAM**
 - Selects or turns off repeat or shuffle mode.
 - In radio mode, resets the list of preset stations: press to manually reset; press and hold to automatically reset.
- ㉓ **REPEAT A-B**
 - Marks the section for repeat play, or turns off repeat mode.

3 Connect

Make the following connections to use your Home Theater System.

Basic connections:

- Video
- Speakers and subwoofer
- Power

Optional connections:

- Radio antenna
- Audio
 - Audio from TV
 - Audio from cable box/recorder/game console
- Other devices
 - Portable media player
 - USB device
 - iPod docking station

Note

- Refer to the type plate at the back or bottom of the product for identification and supply ratings.
- Before you make or change any connections, ensure that all the devices are disconnected from the power outlet.

Tip

- Different types of connectors may be used to connect this product to your TV, depending on availability and your needs. A comprehensive interactive guide to help you connect your product is available at www.connectivityguide.philips.com.

Place the Home Theater System

- Place the Home Theater System where it cannot be pushed, pulled over or knocked down. Do not place it in an enclosed cabinet.
- Be sure that you have full access to the power cord for easy disconnection of the Home Theater System from the power supply.

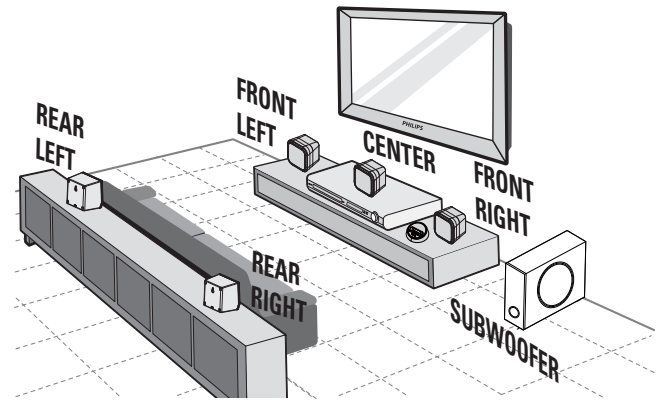

- 1 Place this Home Theater System near the TV.
- 2 Place the speakers system at normal listening ear-level and directly parallel to the listening area.
- 3 Place the subwoofer at the corner of the room or at least 3 feet away from the TV.

Tip

- To avoid magnetic interference or unwanted noise, never place this Home Theater System too close to any radiation devices.

Connect video cables

Connect this Home Theater System to TV to view disc play. Select the best video connection that the TV can support.

- Option 1: Connect to the HDMI jack (for a HDMI, DVI or HDCP-compliant TV).
- Option 2: Connect to the component video jacks (for a standard TV or Progressive Scan TV).
- Option 3: Connect to the video (CVBS) jack (for a standard TV).
- Option 4: Connect to the RF modulator (for TV with only a single antenna input jack).

Note

- You must connect this Home Theater System directly to a TV.

Option 1: Connect to the HDMI jack

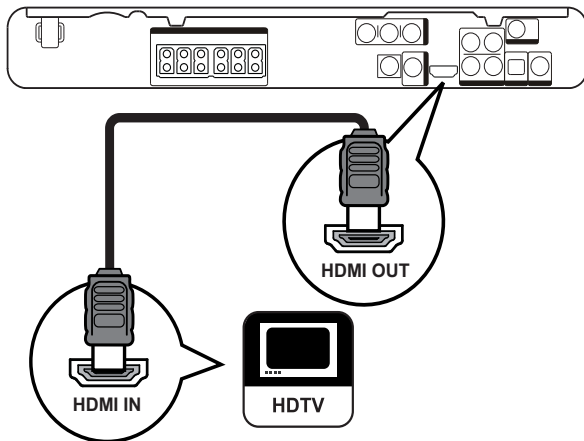

- 1 Connect an HDMI cable (not supplied) to the **HDMI OUT** jack on this Home Theater System and the HDMI input jack on the TV.

Note

- If your device supports HDMI CEC, you can control compliant devices with a single remote control. (see 'Get started' > 'Use Philips EasyLink').

Tip

- If the TV has a DVI connection only, connect via a HDMI/DVI adaptor. Connect an audio cable for sound output.
- You can optimize the video output. (see 'Adjust settings' > 'Video setup' > **[HDMI Setup]**).
- This type of connection provides the best picture quality.

Option 2: Connect to the component video jack

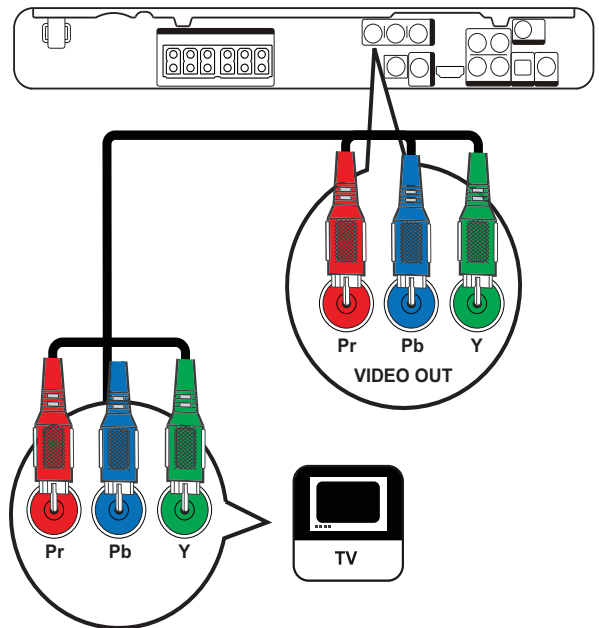

- 1 Connect the component video cable (not supplied) to the **Y Pb Pr** jacks on this Home Theater System and the COMPONENT VIDEO input jacks on the TV.
 - If a progressive scan TV is used, you may turn on the progressive scan mode. (see 'Get started' > 'Turn on Progressive Scan').

Note

- The component video input jack on the TV might be labeled as Y Pb/Cb Pr/Cr or YUV.
- This type of connection provides good picture quality.

Option 3: Connect to the Video (CVBS) jack

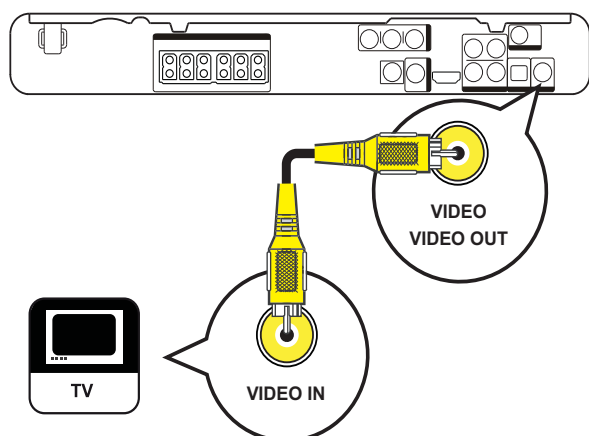

- 1 Connect a composite video cable to the **VIDEO** jack on this Home Theater System and the VIDEO input jack on the TV.



Note

- The video input jack on the TV might be labeled as A/V IN, VIDEO IN, COMPOSITE or BASEBAND.
- This type of connection provides standard picture quality.

Option 4: Connect to the RF modulator

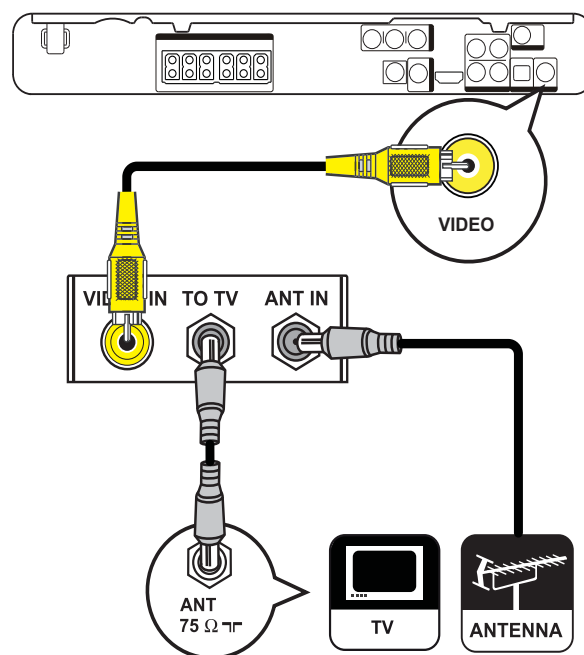

If your TV only has a single Antenna Input jack (labeled as 75 ohm or RF In), use a RF modulator to view the disc play on the TV.

- 1 Connect a composite video cable (yellow) from the **VIDEO** jack on this Home Theater System to the video input jack on RF modulator.
- 2 Connect a RF coaxial cable (not supplied) from the ANTENNA OUT or TO TV jack on the RF modulator to the ANTENNA IN jack on your TV.
- 3 If the off-air antenna or Cable TV service signal is connected to your TV, disconnect it from your TV and connect it to the ANTENNA IN or RF IN jack on the RF modulator.



Tip

- See your electronics retailer or contact Philips for details about RF modulator availability and operations.

Connect speakers and subwoofer

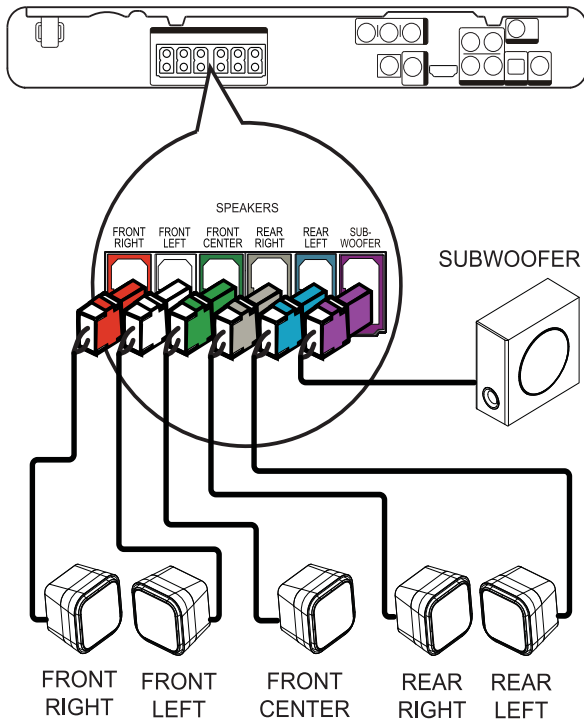

- 1 Connect the speakers and subwoofer to the matching jacks on the Home Theater System.

Note

- Ensure that the colors of the plugs and jacks are matched.

Connect radio antenna

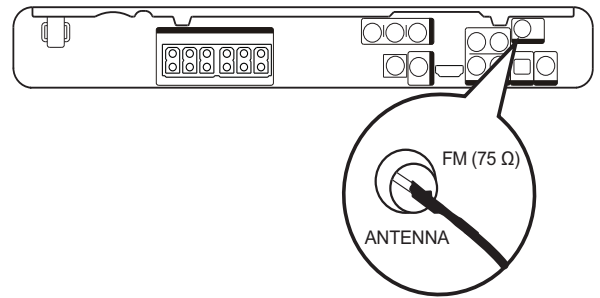

- 1 Connect the FM antenna to the **FM75 Ω** jack on this Home Theater System (for some models, this cable is already connected).
- 2 Extend the FM antenna and fix its ends to the wall.

Tip

- For better FM stereo reception, connect to an external FM antenna.

Connect audio cables/other devices

Route the audio from other devices to this Home Theater System to enjoy audio play with multi-channel surround capabilities.

Connect audio from TV

(also used for EasyLink control)

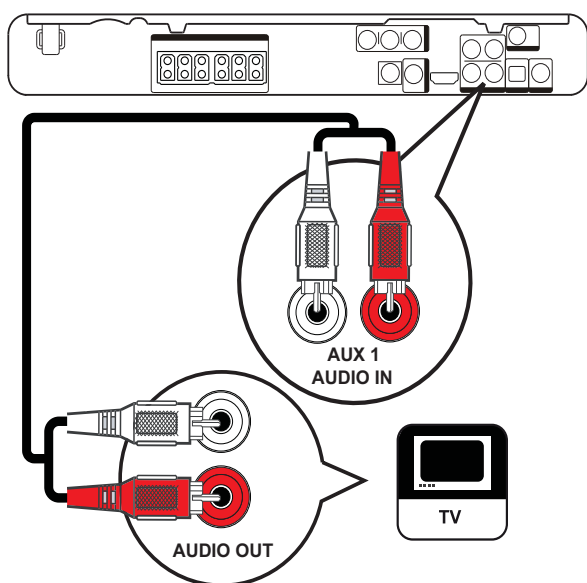

- 1 Connect the audio cables (not supplied) to the **AUDIO IN-AUX1** jacks on the Home Theater System and the **AUDIO** output jacks on the TV.

Note

- To listen to the audio output from this connection, press **AUDIO SOURCE** repeatedly until 'AUX1' is displayed on the display panel.

Connect audio from cable box/ recorder/game console

You can choose to connect to analog or digital jack depending on the device capabilities.

Connect to analog jacks

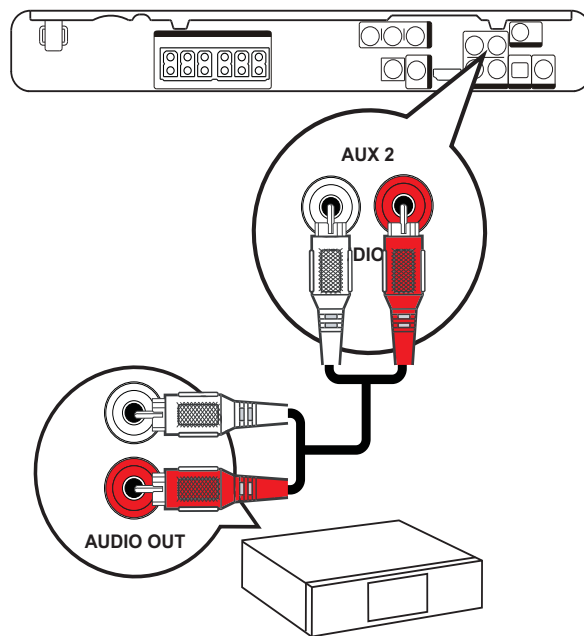

- 1 Connect the audio cables (not supplied) to the **AUDIO IN-AUX2** jacks on the Home Theater System and the **AUDIO** output jacks on the device.

Note

- To listen to the audio output from this connection, press **AUDIO SOURCE** repeatedly until 'AUX2' is displayed on the display panel.

Connect to coaxial jack

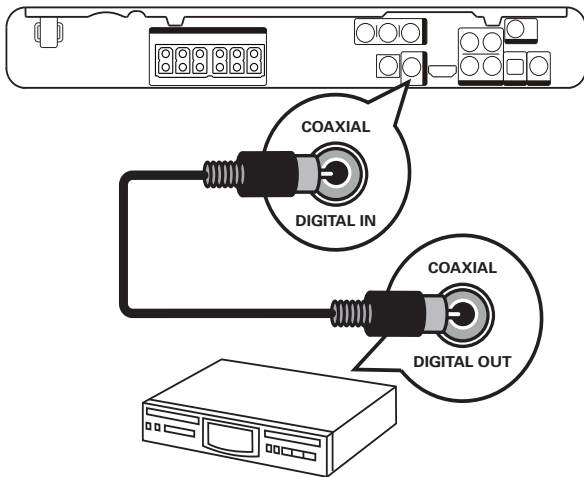

- 1 Connect a coaxial cable (not supplied) to the **COAXIAL DIGITAL-IN** jack on the Home Theater System and the COAXIAL/DIGITAL output jack on the device.

Note

- To listen to the audio output from this connection, press **AUDIO SOURCE** repeatedly until 'COAX IN' is displayed on the display panel.

Connect to optical jack

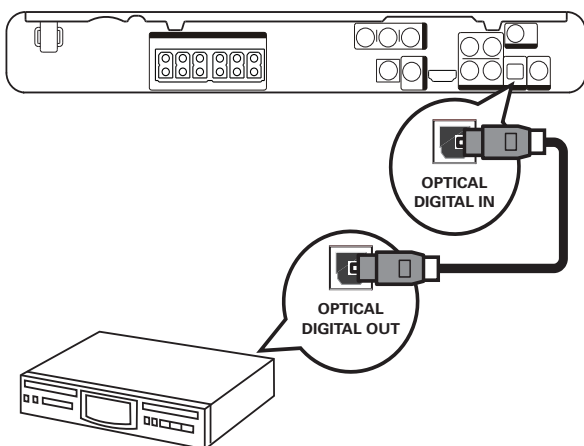

- 1 Connect an optical cable (not supplied) to the **OPTICAL DIGITAL-IN** jack on the Home Theater System and the OPTICAL/SPDIF output jack on the device.

Note

- To listen to the audio output from this connection, press **AUDIO SOURCE** repeatedly until 'OPTI IN' is displayed on the display panel.

Connect portable media player

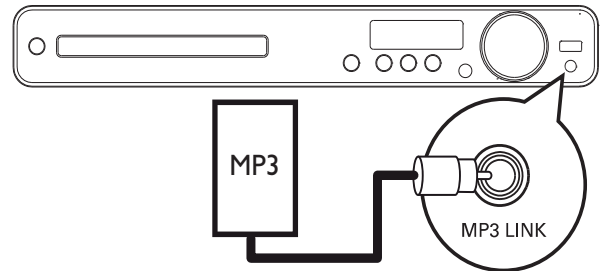



- 1 Connect a 3.5mm stereo audio cable (not supplied) to the **MP3 LINK** jack on this Home Theater System and the phone jack on the portable media player (such as MP3 player).

Note

- To listen to the audio output from this connection, press **AUDIO SOURCE** repeatedly until 'MP3 LINK' is displayed on the display panel.

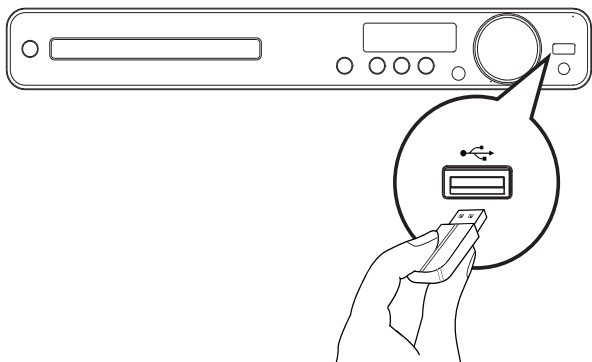
Connect USB device



- 1 Connect the USB device to  **USB** jack on this Home Theater System.

Note

- This Home Theater System can only play/view MP3, WMA, DivX (Ultra) or JPEG files that are stored on such devices.
- Press **USB** to access the content and play the files.

Connect iPod docking station

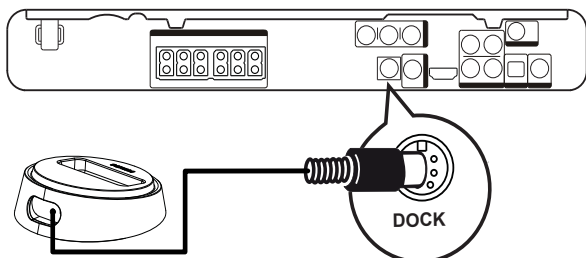

- 1 Connect the iPod docking station to **DOCK** jack on this Home Theater System.

Note

- To listen to the audio output from this connection, press **DOCK**.

Connect power cord

Warning

- Risk of product damage! Ensure that the power supply voltage corresponds to the voltage printed on the back or the underside of the Home Theater System.

- 1 Connect the power cord to the power outlet when all the required connections are done.
 - ↳ The Home Theater System is ready to be set up for use.

4 Get started

Insert the remote control batteries

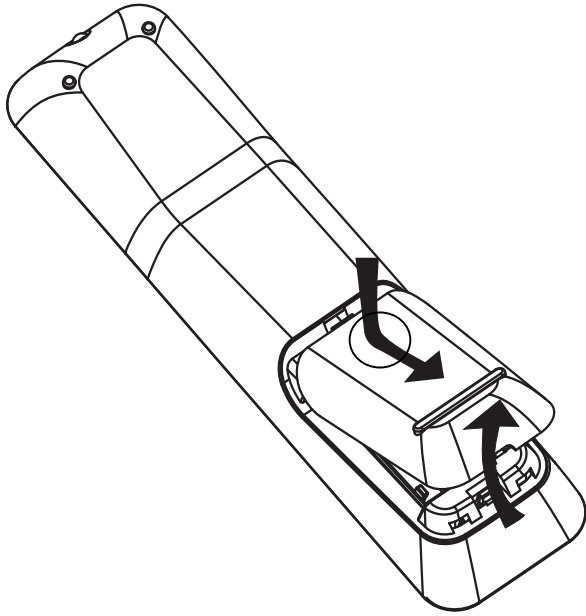

- 1 Slide the battery cover off the back of the remote control.
- 2 Insert the 2 supplied batteries (AAA). Be sure the + and - ends of the batteries line up with the markings inside the case.
- 3 Slide the cover back into position.



Note

- Do not mix batteries (old and new or carbon and alkaline, etc.).
- Remove batteries if they are exhausted or if the remote control is not to be used for a long time.
- Batteries contain chemical substances, they should be disposed of properly.

Control a play source

- 1 Select the source you wish to control by pressing the **AUDIO SOURCE**, **RADIO**, **USB**, **DOCK** or **DISC** button.
- 2 Then select the desired function (for example ◀, ▶).

Navigate through the menu

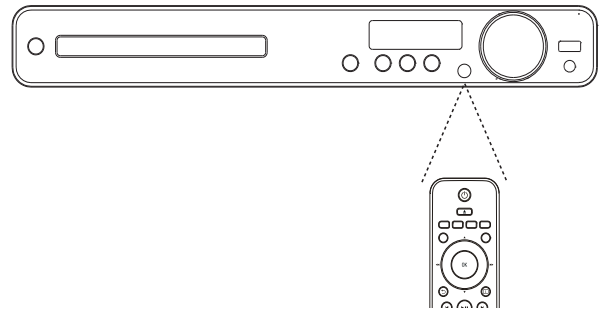

- 1 Point the remote control directly at the remote sensor on the Home Theater System and select the desired function.
- 2 Press the following buttons on the remote control to navigate through the on-screen menus.

Button	Action
▲▼	Move up or down
◀▶	Move left or right
OK	Confirm a selection
1 2 3	Enter numbers
4 5 6	
7 8 9	
0	

Find the correct viewing channel

- 1 Press **⏻** to turn on the Home Theater System.
- 2 Press **DISC** to switch to disc mode.
- 3 Turn on the TV and switch to the correct video-in channel in one of the following ways:
 - Go to the lowest channel on your TV, then press the Channel Down button until you see the Philips screen.
 - Press **⏻ SOURCE** button repeatedly on the remote control of your TV.
 - Set the TV to channel 3 or 4 if a RF modulator is used.

Tip

- The video-in channel is between the lowest and highest channels and may be called FRONT, A/V IN, VIDEO, HDMI etc.. See the TV user manual on how to select the correct input on your TV.

Select menu display language

Note

- Skip this setting if this Home Theater System is connected to a HDMI CEC compliant TV. It switches automatically to the same OSD menu language as per your TV setting.

General Setup	
EasyLink Setup	<input checked="" type="radio"/> Auto
Disc Lock	<input type="radio"/> English
Display Dim	<input type="radio"/> Français
OSD Language	<input type="radio"/> Español
Screen Saver	
Sleep Timer	
DivX(R) VOD Code	

- 1 Press **DISC**.
- 2 Press **⏻ SETUP**.
↳ **[General Setup]** menu is displayed.
- 3 Press **▶**.
- 4 Press **▲▼** to select **[OSD Language]** in the menu, then press **▶**.
 - The language options are different depending on your country or region. It may not correspond to the illustration shown here.
- 5 Press **▲▼** to select a language, then press **OK**.

Tip

- You can set the default language for DVD disc menu (see 'Adjust settings' > 'Preferences' > **[Disc Menu]**).

Turn on Progressive Scan

If the TV supports progressive scan output, you can connect this Home Theater System and the TV using component video connection. (see 'Connect video cables' > 'Option 2: Connect to the component video jack').

Video Setup	
TV System	<input type="radio"/> On
TV Display	<input checked="" type="radio"/> Off
Screen Fit	
Picture Setting	
HDMI Setup	
Closed Caption	
Progressive	

- 1 Turn on the TV and ensure that the TV progressive scan mode is deactivated (see the TV user manual).
- 2 Switch the TV to the correct viewing channel for this Home Theater System.
- 3 Press **DISC**.
- 4 Press **SETUP**.
- 5 Press **▼** to select **[Video Setup]** in the menu, then press **▶**.
- 6 Select **[Progressive]** > **[On]**, then press **OK**.
↳ A warning message is displayed.
- 7 To proceed, select **[Ok]** and press **OK**.
↳ The progressive setup is complete.

Note

- If a blank/distorted screen is displayed, wait for 15 seconds for the auto recover.
- If no picture displayed, turn off the progressive scan mode as follows: 1) Press **▲** to open the disc compartment. 2) Press **◀**. 3) Press **AUDIO SYNC**.

- 8 Press **SETUP** to exit the menu.
- 9 You can now turn on the progressive scan mode on the TV.

Note

- During play, when progressive scan mode is on for both this Home Theater System and the TV, distorted picture may display. Turn off the progressive scan feature on both this Home Theater System and the TV.

Change speaker settings







Ideally, the distance between listening position and all the speakers should be the same. If not, change the speaker settings based on their distance from the listening position to obtain the best possible surround sound.

Audio Setup	
Speakers Volume	
Speakers Delay	
HDMI Audio	
CD Upsampling	
Audio Sync	

- 1 Press **DISC**.
- 2 Press **SETUP**.
- 3 Press **▼** to select **[Audio Setup]** in the menu, then press **▶**.
 - If the speaker setup option is not accessible, press **■** twice before you press **SETUP**.

To set the speakers level

- 1 Select **[Speakers Volume]** in the menu, then press **▶**.

Speakers Volume Setup	
Front Left	 0dB
Front Right	 0dB
Center	 0dB
Subwoofer	 0dB
Rear Left	 0dB
Rear Right	 0dB

- 2 Press **◀▶** to change the volume level, then press **OK**.
 - ↳ The test tone is emitted from the speaker.
 - Repeat the above setting for other speakers until all the speakers output level sounds equally balance.
 - To exit the menu, press **SETUP**.

To set the output delay time (center and rear speakers only)

- 1 Select **[Speakers Delay]** in the menu, then press **▶**.

Speakers Distance Setup	
Center	<input type="text"/> 0MS
Rear Left	<input type="text"/> 0MS
Rear Right	<input type="text"/> 0MS

- 2 Press **◀▶** to set the delay time, then press **OK**.
 - Repeat the above setting for other speakers until the sound output from different speakers reach the listening position at the same time.
 - To exit the menu, press **SETUP**.

Tip

- Set a longer delay time if the center speaker or rear speaker is closer to the listening position than the front speaker.
- Allow 1ms setting for every 1 foot distance between the speaker and the listening position.

Use Philips EasyLink

Your Home Theater System supports Philips EasyLink, which uses the HDMI CEC (Consumer Electronics Control) protocol. EasyLink-compliant devices that are connected through HDMI connectors can be controlled by a single remote control.

Note

- Philips does not guarantee 100% interoperability with all HDMI CEC devices.

- 1 Turn on the HDMI CEC operations on the TV and other connected devices. See TVs/devices manual for details.
- 2 You can now enjoy the following Philips EasyLink controls.

EasyLink

You can turn off or turn on all EasyLink features.

One-touch play

When you connect your Home Theater System to devices that support one-touch play, you can control your Home Theater System and the devices with one remote control. For example, when you press Play on your Home Theater System remote control, your TV automatically switches to the correct channel to show the DVD content. To enable One-touch play, a video disc must be placed in the disc compartment before operation.

One-touch standby

When you connect your Home Theater System to devices that support standby, you can use your Home Theater System remote control to put your Home Theater System and all connected HDMI devices in standby mode. You can perform one-touch standby using the remote control from any of the connected HDMI devices.

System Audio Control

When you connect your Home Theater System to HDMI CEC compliant devices, your Home Theater System can switch automatically to play audio from the connected device.

To use one-touch audio, you must map the audio input from the connected device to your Home Theater System.

Audio Input Mapping

When you map the audio input correctly, this Home Theater System switches to the audio from the played device automatically.

Map the audio inputs to the connected devices

Note

- Before you start, ensure that the audio output of the HDMI TV and other HDMI devices have been connected to the audio input jacks on this Home Theater System.

General Setup	
EasyLink Setup	<input type="radio"/> EasyLink
Disc Lock	<input type="radio"/> One Touch Play
Display Dim	<input type="radio"/> One Touch Standby
OSD Language	<input type="radio"/> System Audio Control
Screen Saver	<input type="radio"/> Audio Input Mapping
Sleep Timer	
DivX(R) VOD Code	

- 1 Press **DISC**.
- 2 Press **SETUP**.
↳ **[General Setup]** menu is displayed.
- 3 Press **▶**.
- 4 Select **[EasyLink Setup]**, then press **▶**.
 - **[One Touch Play]** and **[One Touch Standby]** functions are turned on by default in the factory.
- 5 Select **[System Audio Control] > [On]**, then press **OK** to start scanning devices.
↳ Once complete, audio input mapping menu is displayed.

Audio Input Mapping	
Aux 1	<input type="radio"/> [TV]
Aux 2	<input type="radio"/> [DVD 3400]
Coaxial In	<input type="radio"/> other(non-HDMI)
Optical In	

For example, if the TV audio is connected to the **AUX1** jack on this Home Theater System, select **[Aux1]** and map with the TV (brand name) at the right panel.

- 6 Select the audio input of this Home Theater System that is used to connect to other HDMI device (e.g. AUX1, AUX2), then press **▶**.
- 7 Select the correct connected device, then press **OK**.
↳ Repeat steps 5~7 to map other connected devices.
- 8 Press **SETUP** to exit the menu.

Select a play source

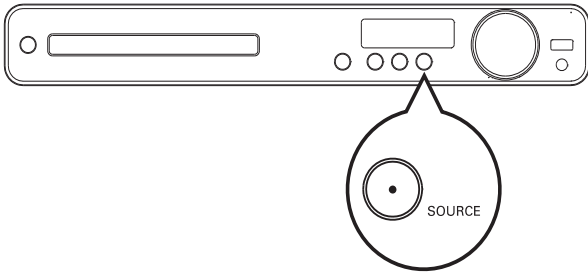

On the main unit

- Press **SOURCE** button repeatedly to select: **DISC** > **USB** > **FM** > **AUX 1** > **AUX 2** > **COAX IN** > **OPTI IN** > **MP3 LINK** > **DOCK** > **DISC ...**

On the remote control

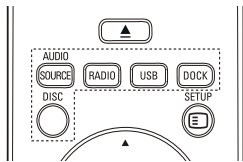

- Press **AUDIO SOURCE** repeatedly to switch to the connected audio source:

Display	Device connected to
AUX1	AUDIO IN-AUX1 jacks
AUX2	AUDIO IN-AUX2 jacks
COAX IN	COAXIAL DIGITAL IN jack
OPTI IN	OPTICAL DIGITAL IN jack
MP3 LINK	MP3 LINK jack

- Press **RADIO** to switch to FM band.
- Press **USB** to switch to USB mode.
- Press **DOCK** to switch to iPod mode.
- Press **DISC** to switch to disc mode.

5 Play

Play a disc

! Caution

- Never place any objects other than discs into the disc compartment.
- Never touch the disc optical lens inside the disc compartment.

- 1 Press **▲** to open the disc compartment.
- 2 Insert a disc with its label facing up.
 - For double-sided disc, load the side to play faces up.
- 3 Press **▲** to close the disc compartment and start disc play.
 - To view disc play, turn on the TV to the correct viewing channel for this Home Theater System.
 - To stop disc play, press **■**.

≡ Note

- Check the types of discs supported. (see 'Specifications' > 'Playback media').
- If the password entry menu is displayed, enter the password before you can play the locked or restricted disc.
- If you pause or stop a disc for about 5 minutes, the screen saver activates. To deactivate the screen saver, press **DISC**.
- After you pause or stop a disc and no buttons are pressed within 15 minutes, this Home Theater System automatically switches to standby mode.

Play video

≡ Note

- For video disc, playback always resumes from the point where it was last stopped. To start play from the beginning, press **◀** while the message is displayed.

Control video play

- 1 Play a title.
- 2 Use the remote control to control the title.

Button	Action
▶ 	Starts, pauses or resumes disc play.
■	Stops disc play.
▶	Skips to the next title or chapter.
◀	Skips to the beginning of the current title or chapter. Press twice to jump to the previous title or chapter.
◀◀ / ▶▶	Searches fast-forward (right) or fast-backward (left). Press repeatedly to change the search speed. In pause mode, slow motion backward or forward play.
▲ / ▼	Searches slow-forward (down) or slow-backward (up). Press repeatedly to change the search speed. For VCD, only slow-forward play is possible.

Change video play

- 1 Play a title.
- 2 Use the remote control to change the video play.

Button	Action
AUDIO SYNC	Selects an audio language or channel on a disc.
SUBTITLE	Selects the subtitle language on a disc.
REPEAT	Selects or turns off repeat or shuffle mode. Repeat options vary depending on the disc type. For VCDs, repeat play is only possible if the PBC mode is turned off.
ZOOM	Zooms in or out of the picture. To pan through the zoomed image, press the Navigation buttons .
INFO	Displays the current status or disc information. You can change the video play options here without interrupting disc play.
SCREEN FIT	Fits the picture format to the TV screen. You can watch the movie in full screen on TV.

Note

- Some operations may not work with some discs. See the information accompanying the disc for details.

Access DVD menu

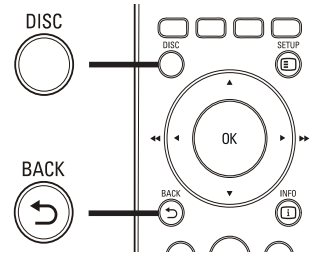

- 1 Press **DISC** to access disc main menu.
- 2 Select a play option, then press **OK**.
 - In some menus, press the **Numeric buttons** to input your selection.
 - To return to the title menu during play, press **BACK**.

Access VCD menu or preview menu

The PBC (Playback Control) for VCD is activated by default in the factory. When you load in a VCD, the contents menu is displayed.

- 1 Press **▲▼** to select a play option, then press **OK** to start play.
 - If PBC is off, it skips the menu and starts play from the first title.
 - To return to the menu during play, press **BACK** (only possible if the PBC mode is on).
- 2 Press **DISC** to preview the contents of the disc.
 - To exit the menu, press **DISC**.

Select Digest Type:

Track Digest
Disc Interval
Track Interval

- 3 Select a preview play option, then press **OK**

[Track Digest]

Plays the first few seconds of each track in a disc.

[Disc Interval]

Divides the total disc time by six and play the first few seconds of these intervals.

[Track Interval]

Divides the current track by six and play the first few seconds of these intervals.

This option is not available in stop mode.

**Tip**

- You can change the PBC setting (see 'Adjust settings' > 'Preferences' > [PBC]).

Sync audio output with video play

If the video play is slower than the audio output (sound does not match with the pictures), you can delay the audio output to match the video.

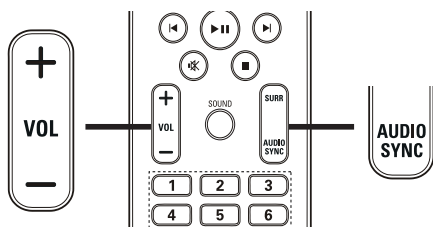

- Press and hold **AUDIO SYNC** until 'AUDIO SYNC' is displayed.
- Within five seconds, press **VOL +/-** to set the delay time for audio output.

**Note**

- If the volume control is not used within five seconds, it resumes normal volume control function.

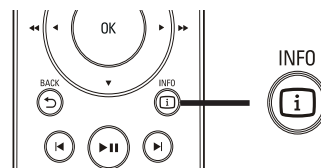
Quick skip play to a specific time

- During play, press **INFO**.
↳ The disc status menu is displayed.
- Press **▲▼** to view information, then press **OK**.
 - [TT Time] (title time)
 - [Ch Time] (chapter time)
 - [Disc Time] (disc time)
 - [Track Time] (track time)
- Press the **Numeric buttons** to enter the time where you want to skip to, then press **OK**.

**Note**

- The options are different depending on the disc type.

Repeat play a specific section

- During play, press **REPEAT A-B** at where you want to set the starting point.
- Press **REPEAT A-B** again to set the ending point.
↳ Repeat play starts.
- To cancel repeat play, press **REPEAT A-B** again.

**Note**

- The marked section for repeat play is only possible within a track/title.

View video play from different camera angles

- 1 During play, press **INFO**.
↳ The disc status menu is displayed.
- 2 Select **[Angle]**, then press **▶**.
- 3 Press the **Numeric buttons** to select an angle, then press **OK**.
↳ Play changes to the selected angle.

Note

- Applicable only to discs contain multi-angle scenes.

Play DivX® video

DivX video is a digital media format that retains high quality despite a high rate of compression. You can enjoy DivX video on this DivX® Certified Home Theater System.

- 1 Insert a disc or USB that contains the DivX videos.
- 2 Press **DISC** or **USB**.
↳ A contents menu is displayed.
- 3 Select a title to play, then press **▶||**.
- 4 Use the remote control to control the title.

Button	Action
AUDIO	Selects an audio language or channel.
SYNC	
SUBTITLE	Select DVD or DivX subtitle languages.
■	Stops play. For DivX Ultra video, press this button again to display the contents menu.
INFO	Displays DivX Ultra video information.

Note

- You can only play DivX videos that were rented or purchased with the DivX registration code of this Home Theater System (see 'Adjust settings' > 'General setup' > **[DivX(R) VOD Code]**).
- You can play DivX video files of up to 4GB.
- If the subtitle does not appear correctly, change the character set (see 'Adjust settings' > 'Preferences' > **[DivX Subtitle]**).
- This Home Theater System can display up to 45 characters in the subtitle.

Play music

Control audio track play

- 1 Play a track.
- 2 Use the remote control to control the track.

Button	Action
▶ 	Starts, pauses or resumes disc play.
■	Stops disc play.
▶ 	Skips to the next track.
◀ 	Skips to the beginning of the current track. Press twice to jump to the previous track.
1 2 3 4 5 6 7 8 9 0	Selects an item to play.
◀◀ / ▶▶	Searches fast-forward (right) or fast-backward (left). Press repeatedly to change the search speed.
REPEAT	Selects or turns off repeat or shuffle mode.

Play MP3/WMA music

MP3/WMA is a type of highly compressed audio file (files with .mp3 or .wma extensions).

- 1 Insert a disc or USB that contains the MP3/WMA music.
- 2 Press **DISC** or **USB**.
↳ A contents menu is displayed.
- 3 Select a folder, then press **OK**.
- 4 Select a track to play, then press **▶||**.
 - To return to the main menu, press **↶ BACK** or press **▲** until 'Previous' folder is selected, then press **OK**.



Note

- For disc recorded in multiple sessions, only the first session is played.
- This Home Theater System does not support MP3PRO audio format.
- If any special characters are present in the MP3 track name (ID3) or album name, it might not be displayed correctly on the screen because these characters are not supported.
- Some WMA files are protected by Digital Rights Management and cannot be played on this Home Theater System.
- Folders/files that exceed the supported limit of this Home Theater System will not be displayed or played.



Tip

- You can select the display of data contents, view folders or files (see 'Adjust settings' > 'Preferences' > [MP3/JPEG Display]).

Play photo

Play photo as slideshow

This Home Theater System can play JPEG photos (files with .jpeg or .jpg extensions).

- 1 Insert a disc or USB that contains the JPEG photos.
- 2 Press **DISC** or **USB**.
↳ Slideshow begins (for Kodak disc) or a contents menu (for JPEG disc) is displayed.
- 3 Select the folder/album you want to play.
 - To preview the photos in the folder/album, press **i INFO**.

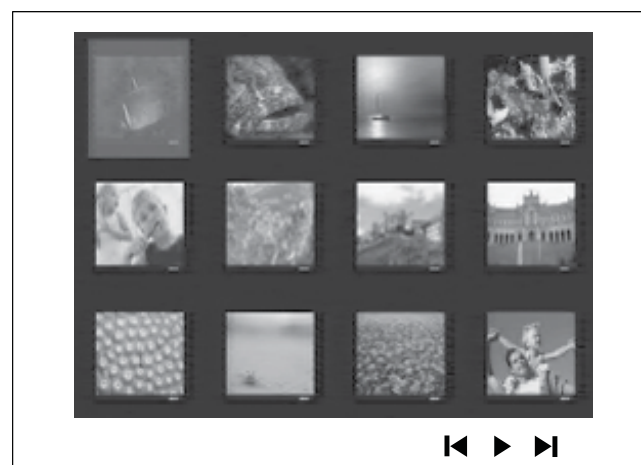

- To go to previous or next screen display, press **◀/▶**.
 - To select a photo, press the **Navigation buttons**.
 - To display the selected photo only, press **OK**.
- 4 Press **▶||** to start slideshow play.
 - To return to the menu, press **↶ BACK**.

Note

- You may require longer time to display the disc content on the TV due to the large number of songs/photos compiled onto one disc.
- If the JPEG photo is not recorded with an 'exif' type file, the actual thumbnail picture is not shown on the display. It is replaced by a 'blue mountain' thumbnail picture.
- This Home Theater System can only display digital camera pictures according to the JPEG-EXIF format, typically used by almost all digital cameras. It cannot display Motion JPEG and pictures in formats other than JPEG, or sound clips associated with pictures.
- Folders/files that exceed the supported limit of this Home Theater System are not displayed or played.

Control photo play

- 1 Play photo slideshow.
- 2 Use the remote control to control the photo.

Button	Action
◀	Skips to the previous photo.
▶	Skips to the next photo.
▲	Rotates the photo clockwise.
▼	Rotates the photo anti-clockwise.
ZOOM	Zooms in or out of the picture. Play pause in zoom mode.
■	Stops play.

Play musical slideshow

Play MP3/WMA music files and JPEG photo files simultaneously to create musical slideshow. The MP3/WMA and JPEG files must be stored on the same disc or USB device.



- 1 Play MP3/WMA music.
 - 2 Navigate to the photo folder/album and press **OK** to start slideshow play.
 - ↳ Slideshow begins and continues till the end of the photo folder or album.
 - ↳ Audio continues to play till the end of the disc.
- To stop slideshow play, press **■**.
 - To stop music play, press **■** again.

Play from USB device

This Home Theater System plays/views MP3, WMA, DivX (Ultra) or JPEG files on the following USB devices:

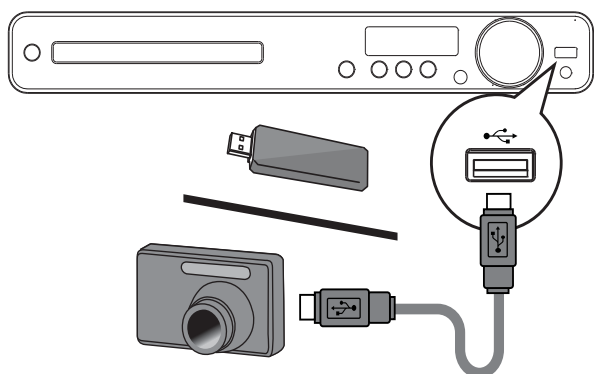
- digital camera that complies with the PTP standard
- flash drive
- memory card reader
- HDD (external power source needed)



- 1 Connect a USB device to the  (USB) jack.
- 2 Press **USB**.
↳ A contents menu is displayed.
- 3 Select a file to play, then press .
↳ Play starts.
 - To stop play, press  or remove the USB device.

Note

- If the device does not fit into the USB jack, connect it through a USB extension cable.
- If you connect a multiple USB card/device reader, only one card/device can be accessed.

Play from portable media player

Simply connect your portable media player (e.g. MP3 player) to this Home Theater System to enjoy superb sound quality from your music collections.

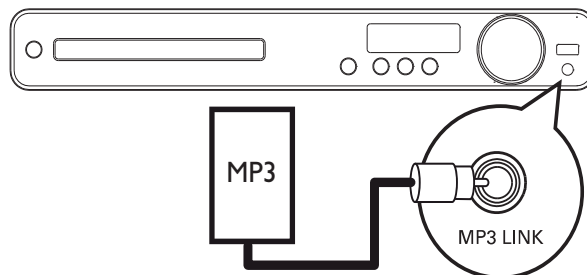

- 1 Connect a 3.5mm stereo audio cable (not supplied) from the **MP3 LINK** jack on this Home Theater System to the 'headphone' jack on the portable media player.
- 2 Press **AUDIO SOURCE** repeatedly until 'MP3 LINK' is displayed.
- 3 Start play on your portable media player.
 - To stop play, press **STOP** on the portable media player.

Note

- Control playback is only possible on the portable media player.
- Stop play on the portable media player before you switch to other play media/source.

Play from iPod

Simply connect your iPod to the docking station to enjoy your iPod play through this Home Theater System.

List of supported iPod range:

iPod classic	iPod nano	iPod 5G
iPod touch 2G	iPod nano 2G	iPod photo
iPod touch	iPod nano 3G	iPod 4G
	iPod nano 4G	iPod mini

Note

- Refer to the Philips website for latest updates on the supported iPod range.

Prepare the docking station

If your iPod cannot fit into the docking station, adjust the 'support' as below.

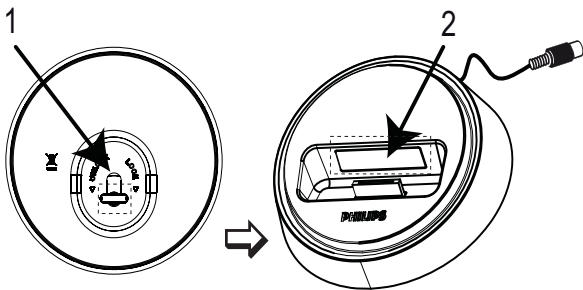

- Turn the knob at the bottom of the docking station anti-clockwise to loosen the adjustable 'support'.
- Adjust the 'support' until it can fit your iPod.
- Turn the knob clockwise to tighten it.

Control iPod music

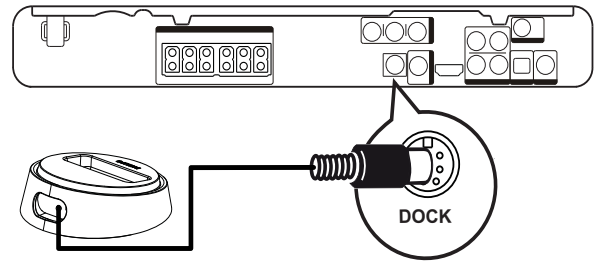

- Connect the docking station to the **DOCK** jack on this Home Theater System.
- Dock your iPod to the docking station and turn it on.
- Press **DOCK**.
 - It may require longer time to authenticate the compatibility of certain iPod range.
- Start play on your iPod.
- During playback, you can use the remote control to control the music play.

Button	Action
VOL +/-	Change the volume level
SOUND	Select a predefined sound effect
◀ ▶	Go to the previous/next track
◀◀ / ▶▶	Search backward/forward
▶	Pause/resume play

Note

- While in iPod mode, the battery of your iPod will be charged.

Play from radio

Check if the FM antenna has been connected to this Home Theater System. If not, connect the supplied FM antenna to the **FM75 Ω** jack and fix its ends to the wall.

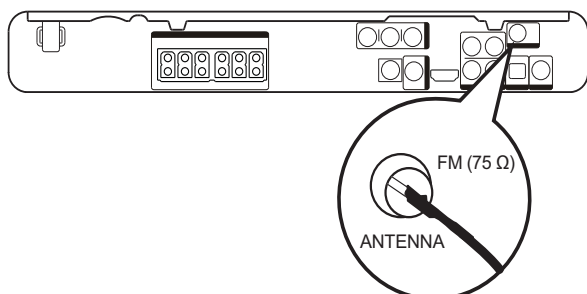

Tip

- For better FM stereo reception, connect an external FM antenna (not supplied).
- Position the antenna as far away as possible from your TV, VCR or other radiation source to prevent interference.

First time tuning

When you access to radio mode for the first time, follow the instructions to install the radio stations.

- 1 Press **RADIO**.
↳ 'AUTO INSTALL ... PRESS PLAY' is displayed.
- 2 Press **▶||**.
↳ All detected radio stations are stored.
↳ Once complete, it tunes to the first preset radio station.
 - To stop auto tuning, press **■**.



Note

- This Home Theater System can store up to a maximum of 40 radio stations.
- If auto installation is not activated or less than 5 radio stations are stored, you will be prompted to install the radio stations again.

Listen to radio

- 1 Press **RADIO**.
- 2 Use the remote control to control the radio.

Button	Action
◀▶	Selects a preset radio station.
▲▼	Tunes the radio frequency up or down.
■	Press and hold this button to erase the current radio station from the preset list. The preset number for other radio stations remain unchanged.

Reinstall all the radio stations

- 1 Press **RADIO**.
- 2 Press and hold **PROGRAM** for more than 5 seconds.
↳ All previously stored radio stations are replaced.



Note

- Check the radio antenna connection if no stereo signal is detected or less than 5 stations are detected during radio installation.

Search and store radio stations individually

- 1** Press **RADIO**.
- 2** Press **◀◀ / ▶▶**.
 - ↳ It starts searching until a radio station is detected.
- 3** Repeat step 2 until you tune to the radio station you wish to store.
 - To finetune the radio frequency, press **▲ / ▼**.
- 4** Press **PROGRAM**.
 - ↳ The preset station number blinks.
 - ↳ If no action is carried out within 20 seconds after the above step, it exits the preset mode.
- 5** Press **◀ / ▶** (or the **Numeric buttons**) to select a preset number to store.
- 6** Press **PROGRAM** to confirm.

6 Advanced features

Create MP3 audio files

You can convert audio CDs into MP3 audio files with this Home Theater System. The created MP3 audio files are saved in your USB device.

Option	Description
[Speed]	Selects the write-to-file speed. If [Normal] speed is selected, music play can be heard while creating the MP3 file.
[Bitrate]	Selects the quality level. Higher bitrate for better sound quality and bigger file size. Default setting is [128kbps] .

CREATE MP3			
OPTIONS		TRACK	
Speed	Normal	<input type="radio"/> Track01	04:14
Bitrate	128kbps	<input type="radio"/> Track02	04:17
		<input type="radio"/> Track03	03:58
		<input type="radio"/> Track04	04:51
		<input type="radio"/> Track05	03:53
		<input type="radio"/> Track06	04:09
		<input type="radio"/> Track07	04:38
SUMMARY			
Select Track	0		
Time	00:00		▼
Start	Exit	Select All	Deselect All

- 1 Insert an audio CD. (CDDA/HDCD)
- 2 Connect the USB flash drive to  (USB) jack on this Home Theater System.
- 3 During disc play, press **CREATE MP3**.
- 4 Select the conversion options in the **[OPTIONS]** panel, then press **OK**.
- 5 Press **▶** to access the **[TRACK]** panel.

- 6 Select the audio track, then press **OK**.
 - To select another track, repeat step 6.
 - To select all tracks, select **[Select All]** in the menu and press **OK**.
 - To deselect all tracks, select **[Deselect all]** in the menu and press **OK**.
- 7 Select **[Start]** in the menu to convert, then press **OK**.
 - ↳ Once complete, a new folder is created automatically in the USB device to store all the new MP3 files.
 - To exit the menu, select **[Exit]** and press **OK**.

Note

- While you convert, do not press any buttons.
- DTS CDs and copy-protected CDs cannot be converted.
- Write-protected or password-protected USB devices cannot be used to store MP3 files.

7 Adjust sound

Control the volume

- 1 Press **VOL +/-** to increase or decrease the volume.
 - To mute, press **MUTE**.
 - To restore the volume, press **MUTE** again or press **VOL +**.

Select surround sound

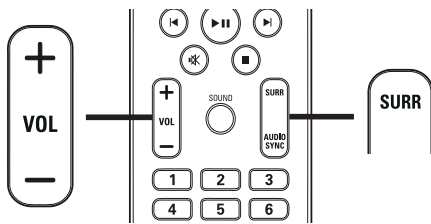

- 1 Press **SURR** repeatedly to select the best surround output that's available on the disc.

Option	Description
5 CH STEREO	Enhances the stereo channel output by duplicating the sound output to the center and rear speakers. Ideal for party music.
MULTI-CHANNEL / DPLII	Multi-channel surround output: Dolby Digital, and Dolby Pro Logic II.
STEREO	Stereo sound

Select a preset sound

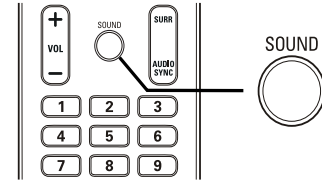





- 1 Press **SOUND** repeatedly to select the sound effect that most suitable for the video or music you play.

Video/Music	Description
ACTION / ROCK	Enhance low and high range for great sounding movie effects and atmosphere. Great for action movies and rock/pop music.
CONCERT/ CLASSIC	Flat and pure sound mode. Ideal for listening to classical music and watching live concert disc.
DRAMA / JAZZ	Clear mid and high range. Recreates the atmosphere of a live club with the artist just in front of you. Good for jazz music and watching dramas.
SPORTS	Moderate mid range and surround effects for clear vocals and the atmosphere of a live sports venue. It is also ideal for video gaming.
NIGHT	Dynamically controlled sound mode suitable for watching movies at night or for nonintrusive background music.

8 Adjust settings

You can customize various kinds of settings as you prefer. Refer to the following instructions to navigate through the setup menus.





Symbol	Options
	[General Setup]
	[Audio Setup]
	[Video Setup]
	[Preferences]

Note

- If the setup option is grayed out, it means the setting cannot be changed at the current state.

General setup

General Setup	
EasyLink Setup	
Disc Lock	
Display Dim	
OSD Language	
Screen Saver	
Sleep Timer	
DivX(R) VOD Code	

- 1 Press  **SETUP**.
↳ [General Setup] menu is displayed.
- 2 Press .
- 3 Select an option, then press **OK**.
- 4 Select a setting, then press **OK**.
 - To return to the previous menu, press  **BACK**.
 - To exit the menu, press  **SETUP**.

Note

- See the explanations of the above options in the following pages.

[EasyLink Setup]

If this Home Theater System is connected to HDMI CEC compliant TV/devices, all connected devices can respond to the following commands simultaneously:

Option	Description
[EasyLink]	Turns off or on all EasyLink features. To disable this feature, select [Off].
[One Touch Play]	When you press PLAY , the TV and Home Theater System are turned on. Disc play starts if there is a disc in the Home Theater System. To disable this feature, select [Off].
[One Touch Standby]	When you press and hold STANDBY for at least three seconds, connected HDMI CEC devices simultaneously switch to standby. To disable this feature, select [Off].
[System Audio Control]	When you play audio that is routed from the connected devices, this Home Theater System switches to the corresponding audio source automatically. To enable this feature, select [On]. Then proceed to [Audio Input Mapping] to scan and map all the connected devices.
[Audio Input Mapping]	When you map the audio input correctly, this Home Theater System switches to the audio from the played device automatically.



Note

- You must turn on the HDMI CEC operations on the TV/devices before you can enjoy the EasyLink controls. See the TV/devices manual for details.
- Philips does not guarantee 100% interoperability with all HDMI CEC compliant devices.

[Disc Lock]

Sets play restriction for a specific discs. Before you start, place the disc in the disc compartment (maximum 40 discs can be locked).

- [Lock] – Restricts access to the current disc. Once activated, a password is needed to unlock and play the disc.
- [Unlock] – Plays all discs.



Tip

- You can set or change the password (see 'Adjust settings' > 'Preferences' > [Password]).

[Display Dim]

Changes the brightness level of the display panel on this Home Theater System.

- [100%] – Normal brightness.
- [70%] – Medium brightness.
- [40%] – Dimmest display.

[OSD Language]

Selects the default on-screen menu language.

[Screen Saver]

Turns off or on the screen saver mode. Helps to protect the TV screen from being damaged due to over exposure to a static image for too long.

- [On] – Sets the screen saver to appear after 5 minutes of inactivity (for example, in pause or stop mode).
- [Off] – Disable screen saver mode.

[Sleep Timer]

Switches to standby automatically after the preset time.

- [15 mins], [30 mins], [45 mins], [60 mins] – Selects the count down time before the Home Theater System switches to standby.
- [Off] – Disables sleep timer mode.

[DivX(R) VOD Code]





Displays the DivX® registration code.

Tip

- Enter this Home Theater System DivX registration code when you rent or purchase video from www.divx.com/vod. The DivX videos rented or purchased through the DivX® VOD (Video On Demand) service can be played only on the device to which it is registered.

Audio setup

Audio Setup	
Speakers Volume	
Speakers Delay	
HDMI Audio	
CD Upsampling	
Audio Sync	

- 1 Press  **SETUP**.
↳ **[General Setup]** menu is displayed.
- 2 Press  to select **[Audio Setup]**, then press .
- 3 Select an option, then press **OK**.
- 4 Select a setting, then press **OK**.
 - To return to the previous menu, press  **BACK**.
 - To exit the menu, press  **SETUP**.

Note

- See the explanations of the above options in the following pages.

[Speakers Volume]

Sets the volume level of each speaker to get the ideal audio balance.

- 1) To start, press **OK**.
- 2) Select a speaker in the menu, then press  to adjust the volume level.
- 3) Press **OK** to confirm and exit.

Note

- The test tone is emitted from the speaker which you adjust.

[Speakers Delay]

Sets the delay time for the center and rear speakers if they are placed closer to the listening position, so that the sound output from all speakers reach the listening position at the same time.

- 1) To start, press **OK**.
- 2) Select a speaker in the menu, then press **◀▶** to set the delay time.
- 3) Press **OK** to confirm and exit.



Note

- Allow 1ms setting for every 1 foot distance between the speaker and the listening position.

[HDMI Audio]

Selects the HDMI audio setting when you connect this Home Theater System and the TV with a HDMI cable.

- **[On]** – Allows audio output through the TV and the speaker system. If the audio format on the disc is not supported, it will be downmixed to two-channel sound (linear-PCM).
- **[Off]** – Disables audio output from the TV. The sound is only output through the speaker system.

[CD Upsampling]

Converts the music CD to a higher sampling rate using sophisticated digital signal processing for better sound quality.

- **[Off]** – Disables CD-upsampling.
- **[88.2kHz (X2)]** – Converts the sampling rate of the CDs twice as high as the original rate.



Note

- CD upsampling is only available in stereo mode.

[Audio Sync]

Sets the default delay time for audio output when you play a video disc.

- 1) To start, press **OK**.
- 2) Select a speaker delay in the menu, then press **◀▶** to set the delay time.
- 3) Press **OK** to confirm and exit.

Video setup

Video Setup	
TV System	
TV Display	
Screen Fit	
Picture Setting	
HDMI Setup	
Closed Caption	
Progressive	

- 1 Press **⏏** **SETUP**.
↳ **[General Setup]** menu is displayed.
- 2 Press **▼** to select **[Video Setup]**, then press **▶**.
- 3 Select an option, then press **OK**.
- 4 Select a setting, then press **OK**.
 - To return to the previous menu, press **⏪** **BACK**.
 - To exit the menu, press **⏏** **SETUP**.



Note

- See the explanations of the above options in the following pages.

[TV System]

Change this setting if the video does not appear correctly. By default, this setting matches the most common setting for TVs in your country.

- **[NTSC]** – For NTSC-system TV.
- **[Multi]** – For TV that is compatible with both PAL and NTSC.

[TV Display]

Selects one of the following display formats:



4:3 Pan Scan (PS)



4:3 Letter Box (LB)



16:9 (Wide Screen)

- **[4:3 Pan Scan]** – For 4:3 screen TV: full-height display with the trimmed sides.
- **[4:3 Letter Box]** – For 4:3 screen TV: wide-screen display with black bars on the top and bottom of the screen.
- **[16:9 Wide Screen]** – For wide-screen TV: display ratio 16:9.

[Screen Fit]

Fits the picture format to the TV screen to enjoy watching disc play in full screen mode.

- **[Select]** – Displays various types of full screen format, press **OK** to select a suitable picture format that best fits to the TV screen.
- **[Off]** – Returns to normal screen display.

[Picture Setting]

Selects a predefined set of picture color settings or customize the personal setting.

- **[Standard]** – Original color setting.
- **[Bright]** – Vibrant color setting.
- **[Soft]** – Warm color setting.
- **[Personal]** – Customizes the color setting. Set the level of brightness, contrast, sharpness/tint and color saturation, then press **OK**.

[HDMI Setup]

Selects the HDMI video setting when you connect this Home Theater System and the TV with a HDMI cable.

- **[Wide Screen Format]** – Defines the wide screen format for disc play.

Option	Description
[Superwide]	Center position of the screen is stretched less than the side. Applicable only to 720p and above video resolution setting.
[4:3 Pillar Box]	No stretching of the picture. Black bars are displayed on both sides of the screen.
[Off]	Picture is displayed according to the format of the disc.



Note

- This setting is only available if you have set the **[TV Display]** setting to **[16:9 Wide Screen]**.

[HDMI Video] – Selects the HDMI video output resolution that is compatible with your TV display capability.

Option	Description
[Auto]	Detects and selects the best supported video resolution automatically.
[480i], [576i], [480p], [576p], [720p], [1080i], [1080p]	Selects a video resolution that is best supported by the TV. See the TV manual for details.



Note

- If the setting is not compatible with your TV, a blank screen appears. Wait for 15 seconds for auto recover or switch to its default mode as follows: 1) Press **▲**. 2) Press **◀**. 3) Press **ZOOM**.

[Closed Caption]

Turns off or on display captions.

- **[On]** – Shows the sound effects in subtitles. Applicable only to discs with Closed Caption information included and the TV supports this feature.
- **[Off]** – Disables closed caption.

[Progressive]

If the TV supports progressive scan output, you can turn on the progressive scan mode to enhance the picture quality. Video connection through Component Video is required.

- **[On]** – Turns on progressive scan mode.
- **[Off]** – Disables progressive scan mode.



Tip

- There is more detailed description available (see 'Get started' > 'Turn on Progressive Scan').

Preferences

Note

- Stop disc play before you can access to [Preferences].

Preferences	
Audio	
Subtitle	
Disc Menu	
Parental	
PBC	
MP3/JPEG Display	
Password	
DivX Subtitle	▼

- 1 Press **SETUP**.
↳ [General Setup] menu is displayed.
- 2 Press ▼ to select [Preferences], then press ▶.
- 3 Select an option, then press **OK**.
- 4 Select a setting, then press **OK**.
 - To return to the previous menu, press **BACK**.
 - To exit the menu, press **SETUP**.

Note

- See the explanations of the above options in the following pages.

[Audio]

Selects the default audio language for disc play.

[Subtitle]

Selects the default subtitle language for disc play.

[Disc Menu]

Selects the language for disc menu.

Note

- If the language you have set is not available on the disc, the disc uses its own default language.
- For some discs, the subtitle/audio language can only be changed from the disc menu.
- To select the languages that are not listed in the menu, select [Others]. Then check the Language Code list at the back of this user manual and enter the respective 4-digit language code.

[Parental]

Restricts access to discs that are unsuitable for children. These types of discs must be recorded with ratings.

- 1) Press **OK**.
- 2) Select a rating level, then press **OK**.
- 3) Press the **Numeric buttons** to enter the password.

Note

- Rated discs above the level you set in [Parental] require a password to be played.
- The ratings are country-dependent. To allow all discs to play, select '8'.
- Some discs have ratings printed on them but are not recorded with ratings. This function has no effect on such discs.

Tip

- You can set or change the password (see 'Preferences' > [Password]).

[PBC]

Turns off or on the content menu of VCDs/ SVCDs with PBC (playback control) feature.

- **[On]** - Displays index menu when you load a disc for play.
- **[Off]** - Skips the menu and start play from the first title.

[MP3/JPEG Display]

Selects to display the folders or display all the files.

- **[View Folders]** – Displays the folders of MP3/WMA files.
- **[View Files]** – Displays all the files.

[Password]

Sets or changes the password for locked discs and play restricted DVDs.

Change Password	
Old Password	<input type="password"/>
New Password	<input type="password"/>
Confirm Password	<input type="password"/>
OK	

- 1) Press the **Numeric buttons** to enter '136900' or the last set password at **[Old Password]** field.
- 2) Enter the new password at **[New Password]** field.
- 3) Enter the new password again at **[Confirm Password]** field.
- 4) Press **OK** to exit the menu.

Note

- If you forget the password, enter '136900' before you set a new password.

[DivX Subtitle]

Selects a character set that supports the DivX subtitle.

[Standard]	English, Irish, Danish, Estonian, Finnish, French, German, Italian, Portuguese, Luxembourgish, Norwegian (Bokmål and Nynorsk), Spanish, Swedish, Turkish
[Central Europe]	Polish, Czech, Slovak, Albanian, Hungarian, Slovene, Croatian, Serbian (Latin script), Romanian
[Cyrillic]	Belarusian, Bulgarian, Ukrainian, Macedonian, Russian, Serbian
[Greek]	Greek
[Hebrew]	Hebrew
[Chinese(Simp)]	Simplified Chinese
[Korean]	Korean

Note

- Ensure that the subtitle file has the exact same file name as the movie file. If for example the file name of the movie is 'Movie.avi', then you will need to name the text file 'Movie.sub' or 'Movie.srt'.

[Version Info.]

Displays the software version of this Home Theater System.

Tip

- This information is required when you want to find out if a newest software version is available at the Philips website that you may download and install on this Home Theater System.

[Default]

Resets all the settings of this Home Theater System to factory default, except for **[Disc Lock]**, **[Password]** and **[Parental]** settings.

9 Additional Information

Update software

To check for new updates, compare the current software version of your Home Theater System with the latest software version (if available) at the Philips website.

Preferences	
Disc Menu ▲	
Parental	
PBC	
MP3/JPEG Display	
Password	
DivX Subtitle	
Version Info.	
Default	

- 1 Press **SETUP**.
- 2 Select **[Preferences] > [Version Info.]**, then press **OK**.
- 3 Write down the version number, then press **SETUP** to exit the menu.
- 4 Go to www.philips.com/support to check the latest software version available for this Home Theater System.
- 5 If the latest software version is higher than the software version of this Home Theater System, download it and store onto a CD-R or USB flash drive.
- 6 Insert the CD-R or USB flash drive to this Home Theater System.
- 7 Press **DISC** or **USB**, then follow the instruction on the TV to confirm update operation.
 - ↳ Once software update is complete, this Home Theater System turns off to standby automatically.

Note

- Do not remove the CD-R or USB when software updating is in progress.

- 8 Disconnect the power cord for a few seconds and connect again to reboot the system.

Care

Caution

- Never use solvents such as benzene, thinner, cleaners available commercially, or anti-static sprays intended for discs.

Clean discs

Wipe the disc with a micro fibre cleaning cloth from the centre to the edge in a straight line movement.

Clean main unit screen

Wipe the screen surface with a micro fibre cleaning cloth.

10 Specifications



Note

- Specification and design are subject to change without notice

Playback media

- DVD-Video, DVD+R/+RW, DVD-R/-RW, DVD+R DL, CD-R/CD-RW, Audio CD, Video CD/SVCD, Picture CD, MP3-CD, WMA-CD, DivX-CD, USB flash drive

Amplifier

- Total output power:
 - Home Theater mode: 1000 W RMS (6 X 167)
 - FTC mode (1%THD): 520 W RMS * (Main Ch @ 1kHz Sub Ch 60Hz within 1% THD)
- Frequency response: 40 Hz ~ 20 kHz
- Signal-to-noise ratio: > 60 dB (A-weighted)
- Input sensitivity:
 - AUX1: 400 mV
 - AUX2: 400 mV
 - MP3 LINK: 250 mV

Disc

- Laser Type: Semiconductor
- Disc diameter: 12cm / 8cm
- Video decoding: MPEG1/ MPEG2 / DivX / DivX Ultra
- Video DAC: 12 bits, 108 MHz
- Signal system: Multi / NTSC
- Video S/N: 56 dB
- Audio DAC: 24 bits / 96 kHz
- Frequency response:
 - 4 Hz - 20 kHz (44.1 kHz)
 - 4 Hz - 22 kHz (48 kHz)
 - 4 Hz - 44 kHz (96 kHz)
- PCM: IEC 60958
- Dolby Digital: IEC 60958, IEC 61937

Radio

- Tuning range: FM 87.5-108 MHz (100 kHz)
- 26 dB quieting sensitivity: FM 22 dB
- IF rejection ratio: FM 60 dB
- Signal-to-noise ratio: FM 50 dB
- Harmonic distortion: FM 3%
- Frequency response: FM 180 Hz~10 kHz / ± 6 dB
- Stereo separation: FM 26 dB (1 kHz)
- Stereo Threshold: FM 29 dB

USB

- Compatibility: Hi-Speed USB (2.0)
- Class support: UMS (USB Mass Storage Class)
- File system: FAT12, FAT16, FAT32

Docking Station

- Dimension (H X D): 34.5 X 104 (mm)
- Weight: 164 g

Main Unit

- Power supply: 120V; ~ 60Hz
- Power consumption: 180 W
- Standby power consumption: < 1 W
- Dimensions (WxHxD): 360 x 57 x 333 (mm)
- Weight: 3.01 kg

Speakers

- System: full range satellite
- Speaker impedance: 4 ohm (center), 4 ohm (Front/Rear)
- Speaker drivers:
 - Center: 3" woofer
 - Front/Rear: 3" full range
- Frequency response: 150 Hz ~ 20 kHz
- Dimensions (WxHxD): 100 x 100 x 75 (mm)
- Weight:
 - Front: 0.48 kg
 - Rear: 0.45 kg
 - Center: 0.67 kg

Subwoofer

- Impedance: 4 ohm
- Speaker drivers: 165 mm (6.5") woofer
- Frequency response: 40 Hz ~ 150 Hz
- Dimensions (WxHxD): 163 x 363 x 369 (mm)
- Weight: 4.7 kg

Laser specification

- Type: Semiconductor laser GaAlAs (CD)
- Wave length: 645 - 665 nm (DVD),
770 - 800 nm (CD)
- Output power: 6 mW (DVD),
7 mW (VCD/CD)
- Beam divergence: 60 degrees.

Declaration of conformity

- Model number: HTS3371D/F7,
HTS3372D/F7
- Trade Name: Philips
- Responsible Party:
Philips Consumer Lifestyle
A Division of Philips Electronics
North America Corp.
P. O. Box 671539
Marietta, GA 30006-0026

11 Troubleshooting



Warning

- Risk of electric shock. Never remove the casing of the Home Theater System.

To keep the warranty valid, never try to repair the system yourself.

If you encounter problems when using the Home Theater System, check the following points before requesting service. If the problem remains unsolved, register your Home Theater System and get support at www.philips.com/welcome.

If you contact Philips, you will be asked for the model and serial number of your Home Theater System. The model number and serial number are on the back or bottom of your Home Theater System. Write the numbers here:

Model No. _____

Serial No. _____

Main unit

The buttons on this Home Theater System do not work.

- Disconnect this Home Theater System from the power outlet for a few minutes, then connect again.

Picture

No picture.

- See TV's manual for correct video input channel selection. Change the TV channel until you see the DVD screen.
- Press **DISC**.
- If you have changed the **[TV Display]** setting, switch back to default mode:
 - 1) Press **▲** to open the disc compartment.
 - 2) Press **◀**.
 - 3) Press **SUBTITLE**.

- If this happens when you turn on the progressive scan setting, you have to switch to its default mode:
 - 1) Press **▲**.
 - 2) Press **◀**.
 - 3) Press **AUDIO SYNC**.

No picture on HDMI connection.

- Check if the HDMI cable is faulty. Replace a new HDMI cable.
- If this happens when you change the HDMI video resolution, you have to switch to its default mode:
 - 1) Press **▲**.
 - 2) Press **◀**.
 - 3) Press **ZOOM**.

Sound

No sound.

- Ensure that the audio cables are connected and press the correct input source (for example, **AUDIO SOURCE**, **USB**) to select the device you want to play.

No sound on HDMI connection.

- Sound cannot transmit through HDMI connection if the connected device is non-HDCP compliant or only DVI-compatible. Make an analog or digital audio connection.
- Ensure that the **[HDMI Audio]** setting is turned on.

No sound from TV program.

- Connect an audio cable from the AUDIO input on this Home Theater System to the AUDIO output on your TV. Then press **AUDIO SOURCE** repeatedly to select the corresponding audio input source.

No surround sound effect from the speakers.

- Press **SURR** to select a correct surround sound setting.
- If the Home Theater System does not support DTS playback, press **AUDIO SYNC** to select other audio track.
- Ensure that the source you are playing is recorded or broadcast in surround sound (Dolby Digital, etc). Sound cannot transmit through HDMI connection if the connected device is non-HDCP compliant or only DVI-compatible. Make an analog or digital audio connection.

The contents of the USB flash drive cannot be read.

- The USB flash drive format is not compatible with this Home Theater System.
- Drive is formatted with different file system which is not supported by this unit (e.g. NTFS).
- Maximum size of memory supported is 160GB.

Play

DivX video files cannot be played.

- Ensure that the DivX file is encoded according to the 'Home Theater Profile' with the DivX encoder.
- Ensure that the DivX video file is complete.

The aspect ratio of the screen is not aligned with the TV display setting.

- The aspect ratio is fixed on the disc.

DivX subtitle does not display correctly.

- Ensure that the subtitle file name is the same as the movie file name.
- Select the correct character set:
 - 1) Press **⏏ SETUP**.
 - 2) Select **[Preferences]**, then press **▶**.
 - 3) Select **[DivX Subtitle]**, then press **OK**.
 - 4) Select the character set that supports the subtitle.

12 Glossary

A

Aspect ratio

Aspect ratio refers to the length to height ratio of TV screens. The ratio of a standard TV is 4:3, while the ratio of a high-definition or wide TV is 16:9. The letter box allows you to enjoy a picture with a wider perspective on a standard 4:3 screen.

D

DivX®

The DivX® codec is a patent-pending, MPEG-4 based video compression technology developed by DivX®, Inc. It can shrink the file size of digital video and still maintain the high visual quality.

Dolby Digital

A surround sound system developed by Dolby Laboratories that contains up to six channels of digital audio (front left and right, surround left and right, center and subwoofer.)

H

HDCP

High-bandwidth Digital Content Protection. This is a specification that provides a secure transmission of digital contents between different devices (to prevent unauthorized copyright.)

HDMI

High-Definition Multimedia Interface (HDMI) is a high-speed digital interface that can transmit uncompressed high definition video and digital multichannel audio. It delivers high quality picture and sound quality, completely free from noise. HDMI is fully backward-compatible with DVI.

As required by the HDMI standard, connecting to HDMI or DVI products without HDCP (High-bandwidth Digital Content Protection) will result in no Video or Audio output.

J

JPEG

A very common digital still picture format. A still-picture data compression system proposed by the Joint Photographic Expert Group, which features small decrease in image quality in spite of its high compression ratio. Files are recognized by their file extension '.jpg' or '.jpeg.'

M

MP3

A file format with a sound data compression system. MP3 is the abbreviation of Motion Picture Experts Group 1 (or MPEG-1) Audio Layer 3. With the MP3 format, one CD-R or CD-RW can contain about 10 times more data than a regular CD.

MPEG

Motion Picture Experts Group. A collection of compression systems for digital audio and video.

P

PBC

Playback Control. A system where you navigate through a Video CD/Super VCD with on-screen menus that are recorded onto the disc. You can enjoy interactive playback and search.

PCM

Pulse Code Modulation. A digital audio encoding system.

Progressive scan

The progressive scan displays twice the number of frames per second than in an ordinary TV system. It offers higher picture resolution and quality.

W

WMA

Windows Media™ Audio. Refers to an audio compression technology developed by Microsoft Corporation. WMA data can be encoded with Windows Media player version 9 or Windows Media player for Windows XP. Files are recognized by their file extension '.wma.'

WMV

Windows Media Video. Refers to a video compression technology developed by Microsoft Corporation. WMV content can be encoded by using Windows Media® Encoder 9 series. Files are recognised by their file extension '.wmv'.

**Return your Product Registration Card or register online at
www.philips.com/welcome today to get the very most from your purchase.**

Registering your model with PHILIPS makes you eligible for all of the valuable benefits listed below, so don't miss out. Complete and return your Product Registration Card at once, or register online at www.philips.com/welcome to ensure:

*** Proof of Purchase**

Returning the enclosed card guarantees that your date of purchase will be on file, so no additional paperwork will be required from you to obtain warranty service.

*** Product Safety Notification**

By registering your product, you'll receive notification - directly from the manufacturer - in the rare case of a product recall or safety defect.

*** Additional Benefits**

Registering your product guarantees that you'll receive all of the privileges to which you're entitled, including special money-saving offers.

PHILIPS

Congratulations on your purchase, and welcome to the "family!"

Dear PHILIPS product owner:

Thank you for your confidence in PHILIPS. You've selected one of the best-built, best-backed products available today. We'll do everything in our power to keep you happy with your purchase for many years to come.

As a member of the PHILIPS "family," you're entitled to protection by one of the most comprehensive warranties and outstanding service networks in the industry. What's more, your purchase guarantees you'll receive all the information and special offers for which you qualify, plus easy access to accessories from our convenient home shopping network.

Most importantly, you can count on our uncompromising commitment to your total satisfaction.

All of this is our way of saying welcome - and thanks for investing in a PHILIPS product.

P.S. To get the most from your PHILIPS purchase, be sure to complete and return your Product Registration Card at once, or register online at:

www.philips.com/welcome

Know these
safety symbols

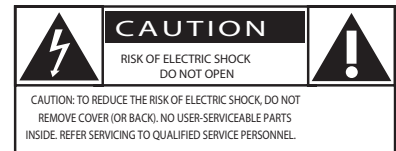

⚡ This "bolt of lightning" indicates uninsulated material within your unit may cause an electrical shock. For the safety of everyone in your household, please do not remove product covering.

! The "exclamation point" calls attention to features for which you should read the enclosed literature closely to prevent operating and maintenance problems.

WARNING: To reduce the risk of fire or electric shock, this apparatus should not be exposed to rain or moisture and objects filled with liquids, such as vases, should not be placed on this apparatus.

CAUTION: To prevent electric shock, match wide blade of plug to wide slot, fully insert.

ATTENTION: Pour éviter les choc électriques, introduire la lame la plus large de la fiche dans la borne correspondante de la prise et pousser jusqu'au fond.

For Customer Use

Enter below the Serial No. which is located on the rear of the cabinet. Retain this information for future reference.

Model No. _____

Serial No. _____

PHILIPS

Visit our World Wide Web Site at <http://www.philips.com/welcome>

PHILIPS LIMITED WARRANTY ONE (1) YEAR

WARRANTY COVERAGE:

PHILIPS warranty obligation is limited to the terms set forth below.

WHO IS COVERED:

Philips warrants the product to the original purchaser or the person receiving the product as a gift against defects in materials and workmanship as based on the date of original purchase ("Warranty Period") from an Authorized Dealer. The original sales receipt showing the product name and the purchase date from an authorized retailer is considered such proof.

WHAT IS COVERED:

The Philips warranty covers new products if a defect in material or workmanship occurs and a valid claim is received by Philips within the Warranty Period. At its option, Philips will either (1) repair the product at no charge, using new or refurbished replacement parts, or (2) exchange the product with a product that is new or which has been manufactured from new, or serviceable used parts and is at least functionally equivalent or most comparable to the original product in Philips current inventory, or (3) refund the original purchase price of the product. Philips warrants replacement products or parts provided under this warranty against defects in materials and workmanship from the date of the replacement or repair for ninety (90) days or for the remaining portion of the original product's warranty, whichever provides longer coverage for you. When a product or part is exchanged, any replacement item becomes your property and the replaced item becomes Philips' property. When a refund is given, your product becomes Philips' property.

Note: Any product sold and identified as refurbished or renewed carries a ninety (90) day limited warranty.

Replacement product can only be sent if all warranty requirements are met. Failure to follow all requirements can result in delay.

WHAT IS NOT COVERED - EXCLUSIONS AND LIMITATIONS:

This Limited Warranty applies only to the new products manufactured by or for Philips that can be identified by the trademark, trade name, or logo affixed to it. This Limited Warranty does not apply to any non-Philips hardware product or any software, even if packaged or sold with the product. Non-Philips manufacturers, suppliers, or publishers may provide a separate warranty for their own products packaged with the bundled product.

Philips is not liable for any damage to or loss of any programs, data, or other information stored on any media contained within the product, or any non-Philips product or part not covered by this warranty. Recovery or reinstallation of programs, data or other information is not covered under this Limited Warranty.

This warranty does not apply (a) to damage caused by accident, abuse, misuse, neglect, misapplication, or non-Philips product, (b) to damage caused by service performed by anyone other than Philips or Philips Authorized Service Location, (c) to a product or a part that has been modified without the written permission of

Philips, or (d) if any Philips serial number has been removed or defaced, or (e) product, accessories or consumables sold "AS IS" without warranty of any kind by including refurbished Philips product sold "AS IS" by some retailers.

This Limited Warranty does not cover:

- Shipping charges to return defective product to Philips.
- Labor charges for installation or setup of the product, adjustment of customer controls on the product, and installation or repair of antenna/signal source systems outside of the product.
- Product repair and/or part replacement because of improper installation or maintenance, connections to improper voltage supply, power line surge, lightning damage, retained images or screen markings resulting from viewing fixed stationary content for extended periods, product cosmetic appearance items due to normal wear and tear, unauthorized repair or other cause not within the control of Philips.
- Damage or claims for products not being available for use, or for lost data or lost software.
- Damage from mishandled shipments or transit accidents when returning product to Philips.
- A product that requires modification or adaptation to enable it to operate in any country other than the country for which it was designed, manufactured, approved and/or authorized, or repair of products damaged by these modifications.
- A product used for commercial or institutional purposes (including but not limited to rental purposes).
- Product lost in shipment and no signature verification receipt can be provided.
- Failure to operate per Owner's Manual.

TO OBTAIN ASSISTANCE IN THE U.S.A., PUERTO RICO, OR U.S. VIRGIN ISLANDS...

Contact Philips Customer Care Center at:
1 866 771 4018

TO OBTAIN ASSISTANCE IN CANADA...

1 800 661 6162 (French Speaking)
1 866 771 4018 (English or Spanish Speaking)

REPAIR OR REPLACEMENT AS PROVIDED UNDER THIS WARRANTY IS THE EXCLUSIVE REMEDY FOR THE CONSUMER. PHILIPS SHALL NOT BE LIABLE FOR ANY INCIDENTAL OR CONSEQUENTIAL DAMAGES FOR BREACH OF ANY EXPRESS OR IMPLIED WARRANTY ON THIS PRODUCT. EXCEPT TO THE EXTENT PROHIBITED BY APPLICABLE LAW, ANY IMPLIED WARRANTY OF MERCHANTABILITY OR FITNESS FOR A PARTICULAR PURPOSE ON THIS PRODUCT IS LIMITED IN DURATION TO THE DURATION OF THIS WARRANTY.

Some states do not allow the exclusions or limitation of incidental or consequential damages, or allow limitations on how long an implied warranty lasts, so the above limitations or exclusions may not apply to you.

This warranty gives you specific legal rights. You may have other rights which vary from state/province to state/province.

P&F USA, Inc. PO Box 672768, Marietta, GA. 30006

Free Manuals Download Website

<http://myh66.com>

<http://usermanuals.us>

<http://www.somanuals.com>

<http://www.4manuals.cc>

<http://www.manual-lib.com>

<http://www.404manual.com>

<http://www.luxmanual.com>

<http://aubethermostatmanual.com>

Golf course search by state

<http://golfingnear.com>

Email search by domain

<http://emailbydomain.com>

Auto manuals search

<http://auto.somanuals.com>

TV manuals search

<http://tv.somanuals.com>