

Register your product and get support at
www.philips.com/welcome

HTS6515D

STOP! Thank you for choosing Philips.

Need help fast?

Read your Quick Start Guide and/or User Manual first for quick tips that make using your Philips product more enjoyable.

Register your product and get support at
www.philips.com/welcome
or call
1-888-PHILIPS (744-5477)
while with your product
(and Model / Serial number)

ARRÊT! Philips vous remercie de votre confiance.

Besoin d'une aide rapide?

Le Guide rapide de début et Manuel de l'utilisateur regorgent d'astuces destinées à simplifier l'utilisation de votre produit Philips.

Enregistrez votre produit et accédez à l'assistance sur
www.philips.com/welcome
ou formez le
1-800-661-6162 (Francophone)
1-888-PHILIPS (744-5477)
(English speaking)
Veuillez à avoir votre produit à portée de main
(et model / serial nombre)

ALTO! Gracias por escoger Philips

Necesita ayuda inmediata?

Lea primero la Guía rápida del comienzo o el Manual del usuario, en donde encontrará consejos que le ayudarán a disfrutar plenamente de su producto Philips.

Visite
www.philips.com/welcome
para registrar su producto y obtener información de contacto y asistencia.
o llame al teléfono
1-888-PHILIPS (744-5477)
y tenga a mano el producto
(y número de model / serial)

EN	DVD Home Theater System	5
FR_CA	Système Home Cinéma DVD	53
ES_LA	Sistema de Home Theater con DVD	103



PHILIPS

**Return your Product Registration Card or register online at
www.philips.com/welcome today to get the very most from your purchase.**

Registering your model with PHILIPS makes you eligible for all of the valuable benefits listed below, so don't miss out. Complete and return your Product Registration Card at once, or register online at www.philips.com/welcome to ensure:

***Proof of Purchase**

Returning the enclosed card guarantees that your date of purchase will be on file, so no additional paperwork will be required from you to obtain warranty service.

***Product Safety Notification**

By registering your product, you'll receive notification - directly from the manufacturer - in the rare case of a product recall or safety defect.

***Additional Benefits**

Registering your product guarantees that you'll receive all of the privileges to which you're entitled, including special money-saving offers.

PHILIPS

Congratulations on your purchase, and welcome to the "family!"

Dear PHILIPS product owner:

Thank you for your confidence in PHILIPS. You've selected one of the best-built, best-backed products available today. We'll do everything in our power to keep you happy with your purchase for many years to come.

As a member of the PHILIPS "family," you're entitled to protection by one of the most comprehensive warranties and outstanding service networks in the industry. What's more, your purchase guarantees you'll receive all the information and special offers for which you qualify, plus easy access to accessories from our convenient home shopping network.

Most importantly, you can count on our uncompromising commitment to your total satisfaction.

All of this is our way of saying welcome - and thanks for investing in a PHILIPS product.

P.S. To get the most from your PHILIPS purchase, be sure to complete and return your Product Registration Card at once, or register online at:

www.philips.com/welcome

Know these **safety symbols**



⚡ This "bolt of lightning" indicates uninsulated material within your unit may cause an electrical shock. For the safety of everyone in your household, please do not remove product covering.

! The "exclamation point" calls attention to features for which you should read the enclosed literature closely to prevent operating and maintenance problems.

WARNING: To reduce the risk of fire or electric shock, this apparatus should not be exposed to rain or moisture and objects filled with liquids, such as vases, should not be placed on this apparatus.

CAUTION: To prevent electric shock, match wide blade of plug to wide slot, fully insert.

ATTENTION: Pour éviter les choc électriques, introduire la lame la plus large de la fiche dans la borne correspondante de la prise et pousser jusqu'au fond.

For Customer Use

Enter below the Serial No. which is located on the rear of the cabinet. Retain this information for future reference.

Model No. _____
Serial No. _____

PHILIPS

Visit our World Wide Web Site at <http://www.philips.com/welcome>

IMPORTANT SAFETY INSTRUCTIONS

1. Read these instructions.
2. Keep these instructions.
3. Heed all warnings.
4. Follow all instructions.
5. Do not use this apparatus near water.
6. Clean only with dry cloth.
7. Do not block any ventilation openings. Install in accordance with the manufacturer's instructions.
8. Do not install near any heat sources such as radiators, heat registers, stoves, or other apparatus (including amplifiers) that produce heat.
9. Do not defeat the safety purpose of the polarized or grounding-type plug. A polarized plug has two blades with one wider than the other. A grounding type plug has two blades and a third grounding prong. The wide blade or the third prong are provided for your safety. If the provided plug does not fit into your outlet, consult an electrician for replacement of the obsolete outlet.
10. Protect the power cord from being walked on or pinched, particularly at plugs, convenience receptacles, and the point where they exit from the apparatus.
11. Only use attachments/accessories specified by the manufacturer.

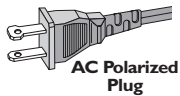

12.  Use only with the cart, stand, tripod, bracket, or table specified by the manufacturer or sold with the apparatus. When a cart is used, use caution when moving the cart/apparatus combination to avoid injury from tip-over.
13. Unplug this apparatus during lightning storms or when unused for long periods of time.
14. Refer all servicing to qualified service personnel. Servicing is required when the apparatus has been damaged in any way, such as power-supply cord or plug is damaged, liquid has been spilled or objects have fallen into the apparatus, the apparatus has been exposed to rain or moisture, does not operate normally, or has been dropped.
15. Battery usage **CAUTION** – To prevent battery leakage which may result in bodily injury, property damage, or damage to the unit:
 - Install **all** batteries correctly, + and - as marked on the unit.
 - Do not mix batteries (**old** and **new** or **carbon** and **alkaline**, etc.).
 - Remove batteries when the unit is not used for a long time.
16. Apparatus shall not be exposed to dripping or splashing.
17. Do not place any sources of danger on the apparatus (e.g. liquid filled objects, lighted candles).
18. This product may contain lead and mercury. Disposal of these materials may be regulated due to environmental considerations. **For disposal or recycling information, please contact your local authorities or the Electronic Industries Alliance : www.eiae.org.**

EL 6475-E005: 04/01



Manufactured under license from Dolby Laboratories. Dolby, Pro Logic and the double-D symbol are trademarks of Dolby Laboratories.



Manufactured under license under U.S. Patent #'s: 5,451,942; 5,956,674; 5,974,380; 5,978,762; 6,487,535 & other U.S. and worldwide patents issued & pending. DTS and DTS Digital Surround are registered trademarks and the DTS logos and Symbol are trademarks of DTS, Inc. © 1996-2007 DTS, Inc. All Rights Reserved.



DivX, DivX Ultra Certified, and associated logos are trademarks of DivX, Inc. and are used under license.

Official DivX® Ultra Certified product.

Plays all versions of DivX® video (including DivX® 6) with enhanced playback of DivX® media files and the DivX® Media Format.



Windows Media and the Windows logo are trademarks, or registered trademarks of Microsoft Corporation in the United States and/or other countries.



HDMI, and HDMI logo and High-Definition Multimedia Interface are trademarks or registered trademarks of HDMI licensing LLC.



The USB-IF Logos are trademarks of Universal Serial Bus Implementers Forum, Inc.



iPod is a trademark of Apple Computer, Inc., registered in the U.S. and other



ENERGY STAR and the ENERGY STAR mark are registered U.S. marks

'CONSUMERS SHOULD NOTE THAT NOT ALL HIGH DEFINITION TELEVISION SETS ARE FULLY COMPATIBLE WITH THIS PRODUCT AND MAY CAUSE ARTIFACTS TO BE DISPLAYED IN THE PICTURE. IN CASE OF 525 OR 625 PROGRESSIVE SCAN PICTURE PROBLEMS, IT IS RECOMMENDED THAT THE USER SWITCH THE CONNECTION TO THE 'STANDARD DEFINITION' OUTPUT. IF THERE ARE QUESTIONS REGARDING OUR TV SET COMPATIBILITY WITH THIS MODEL 525p AND 625p DVD PLAYER, PLEASE CONTACT OUR CUSTOMER SERVICE CENTER.'

Declaration of Conformity

Model number:	HTS6515D
Trade Name:	Philips
Responsible Party:	Philips Consumer Lifestyle A Division of Philips Electronics North America Corp. P.O. Box 671539 Marietta, GA 30006-0026 1-800-PHILIPS (744-5477)

LASER

- | | |
|-------------------|---|
| • Type | Semiconductor laser
GaAlAs |
| • Wave length | 645 - 660 nm (DVD)
770 - 800 nm (CD) |
| • Output Power | 6 mW (DVD)
7 mW (VCD/CD) |
| • Beam divergence | 60 degrees |

Contents

1 Important	6
Safety and important notice	6

2 Your product	7
Features highlight	7
Product overview	8

3 Connect	11
Place the unit	11
Connect video cables	12
Connect speakers to subwoofer	15
Connect subwoofer	15
Connect audio cables/other devices	16
Attach table stand to DVD Home Theater unit	18
Mount the DVD Home Theater unit	18
Mount the speakers	19

4 Get started	20
Prepare the remote control	20
Find the correct viewing channel	21
Select menu display language	21
Start Ambisound setup	22
Turn on Progressive Scan	23
Activate EasyLink control	24
Select a play source	25

5 Play	26
Play from disc	26
Play video	27
Play music	30
Play photo	31
Play from USB device	32
Play from portable media player	33
Play from iPod	33
Play from radio	35

6 Adjust sound	37
Control the volume	37
Adjust Bass/Treble	37
Select Ambisound	37
Select a preset sound effect	38

7 Adjust settings	39
General setup	39
Audio setup	41
Video setup	42
Preference Setup	44

8 Additional information	47
Update software	47
Care	47
Specifications	48

9 Troubleshooting	49
--------------------------	-----------

10 Glossary	51
--------------------	-----------

1 Important

Safety and important notice

Warning!

Risk of fire or electric shock!

- Ensure that air can circulate freely through the ventilation holes on this unit. Allow at least 5~10 cm clearance around the unit.
- Never expose this unit to direct sunlight, naked flames or heat.
- Never place this unit on other electrical equipment.
- Keep away from this unit during lightning storms.
- Never remove the casing of this unit. Please leave all maintenance work to qualified personnel.
- Keep this unit away from water, moisture and liquid-filled objects.

Caution!

- Remove batteries if they are exhausted or if the remote control is not to be used for a long time.
- Do not mix batteries (old and new or carbon and alkaline, etc.).
- Batteries contain chemical substances, they should be disposed of properly.
- Visible and invisible laser radiation when open. Avoid exposure to beam.
- Where the MAINS plug or an appliance coupler is used as the disconnect device, the disconnect device shall remain readily operable.

This system complies with the FCC rules, Part 15 and with 21 CFR 1040.10.

Operation is subject to the following two conditions:

- This device may not cause harmful interference, and
- This device must accept any interference received, including interference that may cause undesired operation.

Recycle notice



This electronic equipment contains a large number of materials that can be recycled or reused if disassembled by a specialized company. If you are disposing of an old machine, please take it to a recycling center. Please observe the local regulations regarding disposal of packaging materials, exhausted batteries and old equipment.

Copyright notice



This product incorporates copyright protection technology that is protected by method claims of certain U.S. patents and other intellectual property rights owned by Macrovision Corporation and other rights owners. Use of this copyright protection technology must be authorized by Macrovision Corporation, and is intended for home and other limited viewing uses only unless otherwise authorised by Macrovision Corporation. Reverse engineering or disassembly is prohibited.

2 Your product

Congratulations on your purchase, and welcome to Philips! To fully benefit from the support that Philips offers, register your product at www.philips.com/welcome.

This DVD Home Theater is designed to complement your home perfectly. Enjoy the DVD Home Theater with multi-channel surround sound and excellent picture quality.

Features highlight

Video upscaling to 1080p

You can now watch the DVDs in the highest picture quality available for your HDTV. This DVD Home Theater offers full high-definition video playback up to 1080p resolution for an amazing viewing experience. A highly detailed picture and increased sharpness delivers a more true-to-life picture.

EasyLink

EasyLink uses the HDMI CEC (Consumer Electronics Control) industry standard protocol to share functionality with all HDMI CEC compliant devices over HDMI. It enables the connected devices to control each other with a single remote control.



Note

- Philips does not guarantee 100% interoperability with all HDMI CEC devices.

Ambisound

Philips Ambisound technology reproduces multi-channel surround sound with fewer speakers to give an embracing surround experience without the hassle of setting up a full range of speaker systems.

USB direct and MP3 link

Simply plug your USB device into the USB jack to play your MP3/WMA/JPEG/DivX files; or plug your portable media player to the MP3 LINK jack to enjoy the music play in superb sound quality.

Sync the audio output with the video play

This DVD Home Theater provides you the feature of delaying the audio output if the video signals that go directly to the TV is slower than the audio streams.

Region codes

DVD movies are usually not released at the same time in all regions of the world, thus all DVD players are programmed to a specific region code.

Countries	DVD region code
United States of America	 

Product overview

Remote control

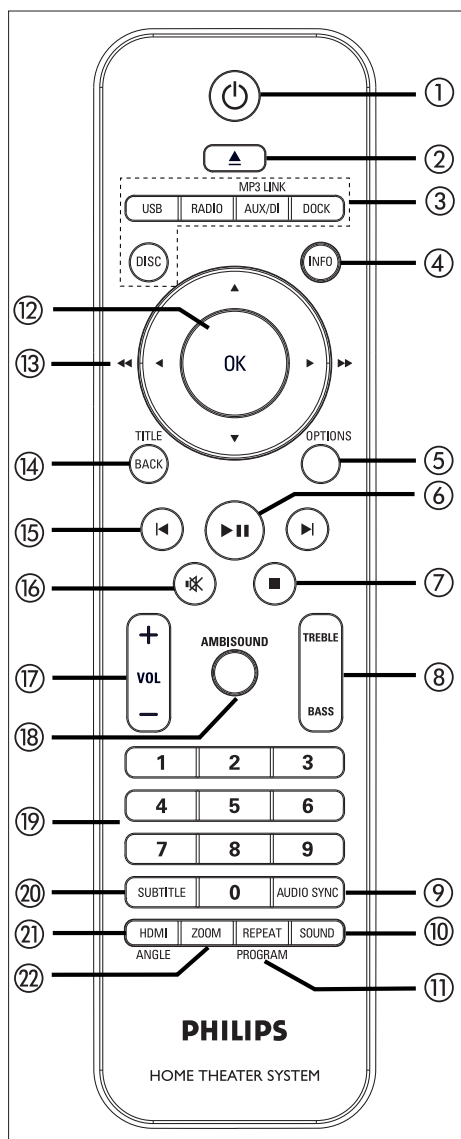

- ①
 - Turn on this unit or turn off to standby mode.
 - Press and hold to turn off this unit and all the HDMI CEC compliant TV/ devices (for EasyLink control only.)
- ② (Open/Close)
 - Open or close the disc compartment.
- ③ **Source buttons**
 - **DISC:** switch to DISC mode. While in disc mode, access or exit disc menu.
 - **USB:** switch to USB mode.
 - **RADIO:** switch to FM band.
 - **AUX/DI /MP3 LINK:** switch to AUX1 INPUT, AUX2 INPUT, AUX3 INPUT, DIGITAL INPUT or MP3 LINK that corresponds to the jack you used to connect the external device.
 - **DOCK:** switch to the iPod that is connected to the docking station.
- ④ **INFO**
 - Display the current status or disc information.
 - Display photo files in 12 thumbnails view.
- ⑤ **OPTIONS**
 - Access or exit Options menu (this menu provides various setting options.)
- ⑥ (Play/Pause)
 - Start or pause disc play.
 - **RADIO:** start auto radio installation (only available for first time setup.)
- ⑦ (Stop)
 - Stop disc play.
 - **RADIO:** erase the current preset radio station.

⑧ TREBLE / BASS

- Switch to treble or bass mode. Then press **VOL + -** to set its level setting.

⑨ AUDIO SYNC

- Select an audio language/channel.
- Press and hold to access audio sync setting. Then press **VOL + -** to set the audio delay time.
- **RADIO**: toggle between FM stereo and mono mode.

⑩ SOUND

- Select a predefined sound effect.

⑪ REPEAT / PROGRAM

- Select various repeat or shuffle modes; turns off repeat or shuffle mode.
- **RADIO**: press this button to start manual radio preset.
- **RADIO**: press and hold this button to start automatic radio preset.

⑫ OK

- Confirm an entry or selection.

⑬ Cursor buttons (▲ ▼ ◀ ▶)

- Navigate through the on-screen menu.
- Press left or right for fast backward or forward search.
- **RADIO**: press up or down to tune the radio frequency.
- **RADIO**: press left or right to start auto search.

⑭ BACK / TITLE

- Return to the previous display menu.
- For DVD, go to title menu.
- For VCD version 2.0 or SVCD with PBC turned on: return to the menu during playback.

⑮ ◀ / ▶ (Previous/Next)

- Skip to the previous or next title/ chapter/track.
- **RADIO**: select a preset radio station.

⑯ ✖ (Mute)

- Mute or restore the volume.

⑰ VOL + -

- Adjust the volume level.

⑱ AMBISOUND

- Select different surround sound output: auto, multi-channel or stereo.

⑲ Numeric buttons

- Enter a preset number or item to play.

⑳ SUBTITLE

- Select DVD or DivX subtitle language.

㉑ HDMI / ANGLE

- Select a video resolution setting for HDMI output.
- Press and hold to select a different viewing angle of a DVD movie.

㉒ ZOOM

- Zoom in or out the picture on the TV.

Main unit

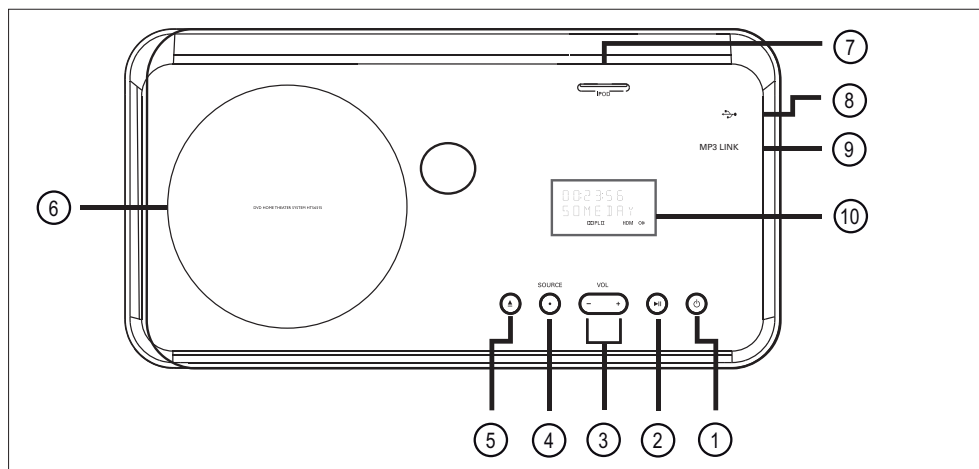

- ① **⏻** (Standby-on)
 - Turn on this unit or turn off to standby mode.
 - Press and hold to turn on this unit from a low power standby mode.
- ② **▶||** (Play/Pause)
 - Start or pause disc play.
 - **RADIO**: start auto radio installation (only available for first time setup.)
- ③ **VOL + -**
 - Adjust the volume level.
- ④ **SOURCE**
 - Select a play media: DISC, USB, DOCK, RADIO FM, DIGITAL INPUT, AUX1 INPUT, AUX2 INPUT, AUX3 INPUT or MP3 LINK.
- ⑤ **▲** (Open/Close)
 - Open or close the disc compartment.
- ⑥ **Disc compartment**
- ⑦ **iPod slot**
 - To connect iPod.
- ⑧ **↔ (USB) jack**
 - To connect USB flash drive, USB memory reader or digital camera.
- ⑨ **MP3 LINK jack**
 - To connect portable audio player.
- ⑩ **Display panel**

3 Connect

This section describes the basic connections required for this DVD Home Theater unit before it can be used.

Basic connections:

- Place the unit
- Connect video cables
- Connect speakers to subwoofer
- Connect subwoofer

Optional connections:

- Connect audio cables/other devices
 - Connect audio from TV
 - Connect audio from cable box/recorder/game console
 - Connect portable media player
 - Connect USB device
- Attach table stand to DVD Home Theater unit
- Mount the DVD Home Theater unit
- Mount the speakers.

Note

- Refer to the type plate at the rear or bottom of the product for identification and supply ratings.
- Before you make or change any connections, ensure that all the devices are disconnected from the power outlet.

Place the unit

- Place this unit on top of a table or mount it on the wall (see chapter 'Mount the DVD Home Theater unit' and 'Mount the speakers'.)
- Never place this unit in an enclosed cabinet.
- Install this unit near the AC outlet where the AC power plug can be easily reached.

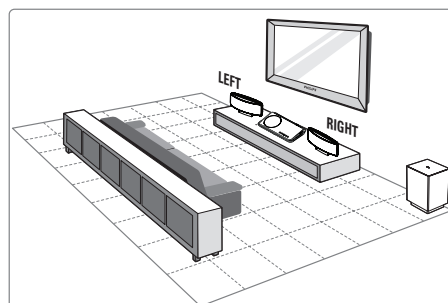

- 1 Place this DVD Home Theater unit near to the TV.
 - Attach the table stand to the DVD Home Theater unit before place it on a table top.
- 2 Place the speakers at the normal listening ear-level and directly parallel to the listening area.
- 3 Place the subwoofer at the corner of the room or at least one meter away from the TV.

Note

- To avoid magnetic interference or unwanted noise, never place the speakers too close to the TV or any radiation devices.

Connect video cables

This section describes how to connect this Home Theater unit to your TV so to enable viewing of disc play.

Select the best video connection that your TV can support.

- **Option 1:** Connect to HDMI jack (for a HDMI, DVI or HDCP-compliant TV.)
- **Option 2:** Connect to component video jack (for a standard TV or Progressive Scan TV.)
- **Option 3:** Connect to video (CVBS) jack (for a standard TV.)
- **Option 4:** Connect to RF modulator (for TV with only a single antenna input jack.)

Note

- You must connect this unit directly to a TV.

Before you connect

- 1 Push up the catch and remove the rear cover.

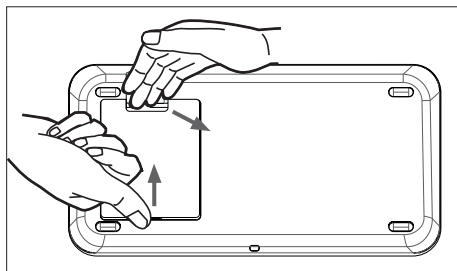

- 2 Connect the cables to the corresponding jacks and direct the cables to the open hole on top.
- 3 Once complete, close the rear cover.

Note

- All the cables must be placed properly inside the rear panel in order for the rear cover to close.

Option 1: Connect to HDMI jack

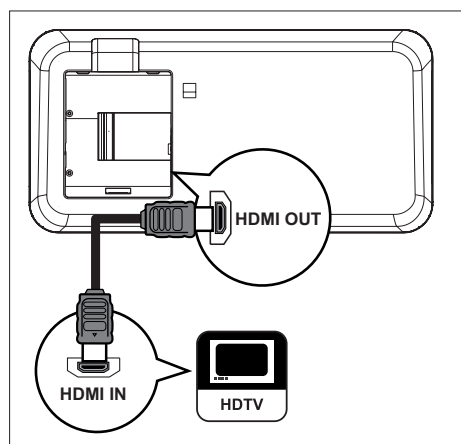

- 1 Connect a HDMI cable (supplied) from the **HDMI OUT** on this unit to the **HDMI IN** jack on your TV.

Note

- The HDMI connector is only compatible with HDMI compliant TVs and DVI-TVs.
- This connection does not support video play from your iPod, a separate video connection is required.

Tips

- To optimize the video output, see chapter 'Adjust settings' > [**Video Setup**] > [**HDMI Setup**] for details.
- This unit is HDMI CEC compatible. It enables connected TV/device to control each other over HDMI, see chapter 'Activate EasyLink control' for details.
- Use a HDMI/DVI adaptor in case your TV has only a DVI connection. An extra audio connection is needed to complete this connection.
- To route the audio from your TV to this DVD Home Theater unit, connect an audio cable from the audio input on this unit to the audio output on your TV.
- This type of connections provide best picture quality.

Option 2: Connect to component video jack

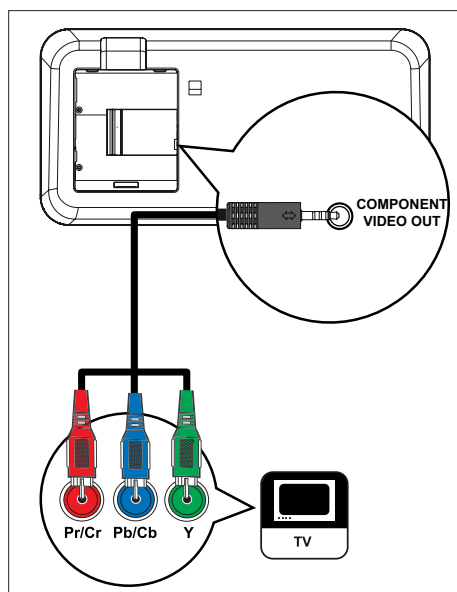

- 1 Connect the component video cable (supplied) from the **COMPONENT VIDEO OUT** jack on this unit to the component video input jacks on your TV.
 - If a progressive scan TV is used, you may turn on the progressive scan mode (see chapter 'Turn on Progressive Scan' for details.)

Tips

- The component video input jack on your TV may be labeled as Y Pb/Cb Pr/Cr or YUV.
- This type of connections provide good picture quality.

Option 3: Connect to Video (CVBS) jack

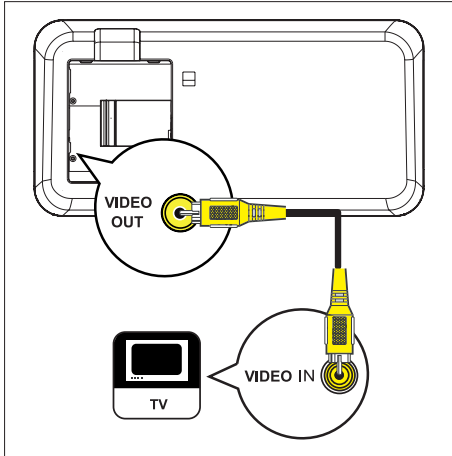

- 1 Connect a composite video cable (yellow - supplied) from the **VIDEO OUT** jack on this unit to the video input jack on your TV.

Note

- This video connection supports video play from your iPod.

Tips

- The video input jack on your TV may be labeled as A/V IN, VIDEO IN, COMPOSITE or BASEBAND.
- This type of connections provide standard picture quality.

Option 4: Connect to RF modulator

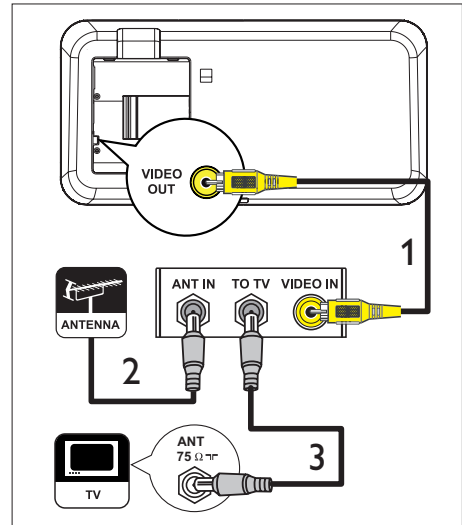

If your TV has only a single Antenna Input jack (labeled as 75 ohm or RF In,) you will need an RF modulator in order to view the DVD playback on the TV.

- 1 Connect a composite video cable (yellow - supplied) from the **VIDEO OUT** jack on this unit to the video input jack on RF modulator.
- 2 Connect a RF coaxial cable (not supplied) from the ANTENNA OUT or TO TV jack on the RF modulator to the ANTENNA IN jack on your TV.
- 3 If the off-air antenna or Cable TV service signal is connected to your TV, disconnect it from your TV and connect it to the ANTENNA IN or RF IN jack on the RF modulator.

Tips

- See your electronics retailer or contact Philips for details about RF modulator availability and operations.

Connect speakers to subwoofer

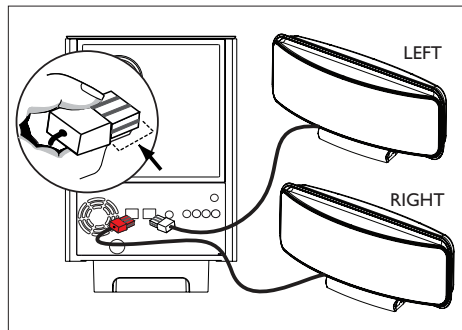

- 1 Connect the left and right Ambisound speakers to the matching jacks on the subwoofer.

Note

- Ensure that the front portion of the plug is fully inserted into the jack.
- To disconnect the Ambisound speakers, press down the catch on the plug before pulling out.

Connect subwoofer

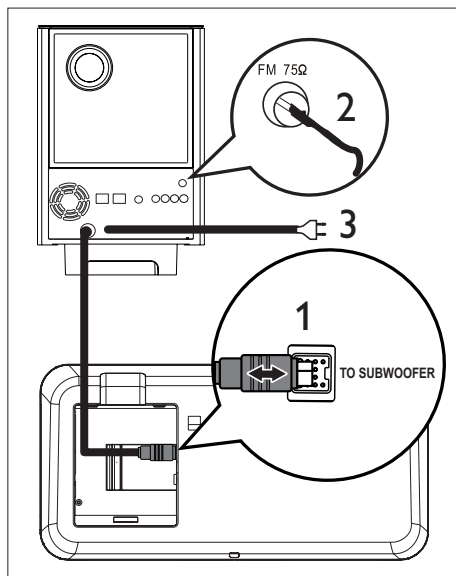

- 1 Unwind the subwoofer's interconnect cable at **TO MAIN UNIT** and connect it to the **TO SUBWOOFER** jack on this unit.
- 2 Connect the FM antenna (supplied) to the **FM75Ω** jack on the subwoofer (for some models, this cable has been connected.) Extend the FM antenna and fix its ends to the wall.
- 3 Connect the power cord when all the required connections are complete and you are ready to enjoy this DVD Home Theater unit.

Connect audio cables/other devices

This section describes how you can route the sound from other devices to this DVD Home Theater unit in order to enjoy sound output or audio play with multi-channel surround capabilities.

Connect audio from TV (also used for EasyLink control)

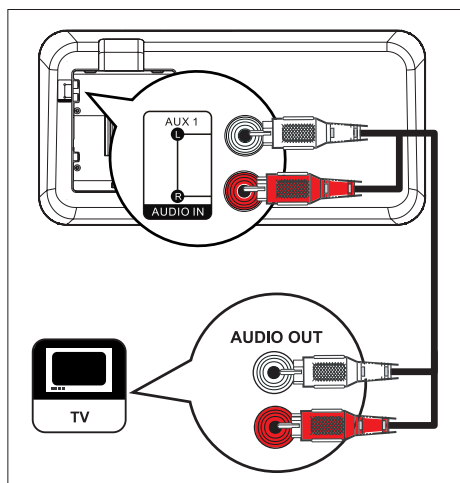

- 1 Connect an audio cable (not supplied) from the **AUDIO IN-AUX1** jacks on this unit to the **AUDIO OUT** jacks on your TV.

Note

- To listen to the audio output from this connection, press **AUX/DI /MP3 LINK** repeatedly until 'AUX1 INPUT' is displayed on the display panel.

Connect audio from cable box/ recorder/game console

You can choose to connect to analog or digital jack depending on the device capabilities.

Connect to analog jacks

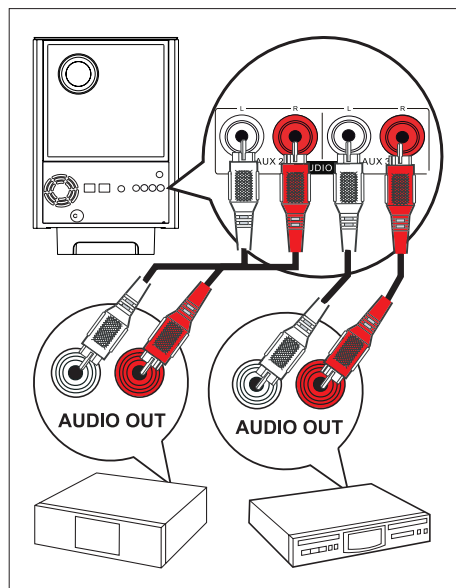

- 1 Connect an audio cable (not supplied) from the **AUDIO IN-AUX2** or **AUX3** jacks on the subwoofer to the **AUDIO OUT** jacks on the device.

Note

- To listen to the audio output from this connection, press **AUX/DI /MP3 LINK** repeatedly until 'AUX2 INPUT' or 'AUX3 INPUT' is displayed on the display panel.

Connect to digital jack

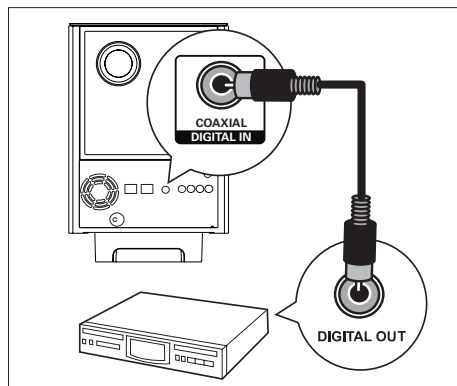

- 1 Connect a coaxial cable (not supplied) from the **DIGITAL IN-COAXIAL** jack on the subwoofer to the **COAXIAL/DIGITAL OUT** jack on the device.

Note

- To listen to the audio output from this connection, press **AUX/DI /MP3 LINK** repeatedly until 'DIGITAL INPUT' is displayed on the display panel.

Connect portable media player

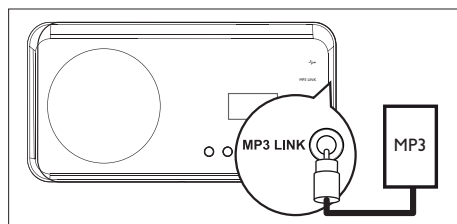

- 1 Connect a 3.5mm stereo audio cable (not supplied) from the **MP3 LINK** jack on this unit to the phone jack on your portable media player (such as MP3 player.)

Note

- To listen to the audio output from this connection, press **AUX/DI /MP3 LINK** repeatedly until 'MP3 LINK' is displayed on the display panel.

Connect USB device

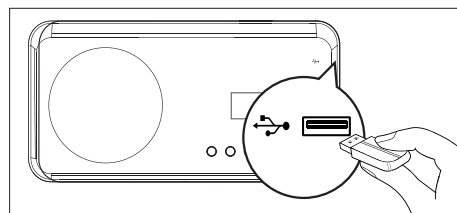

- 1 Connect the USB device to **→ (USB)** jack on this unit.

Note

- This unit can only play/view MP3, WMA, DivX (Ultra) or JPEG files that are stored on such devices.
- To listen to the audio output from this connection, press **USB**.

Attach table stand to DVD Home Theater unit

- 1 Ensure all the required cables are connected to this unit and close the rear cover.
- 2 Attach the table stand bracket to the rear of this unit.
 - Align the arrow indicators for correct positioning and placement.
 - Use the protrude panels to hold the table stand bracket.

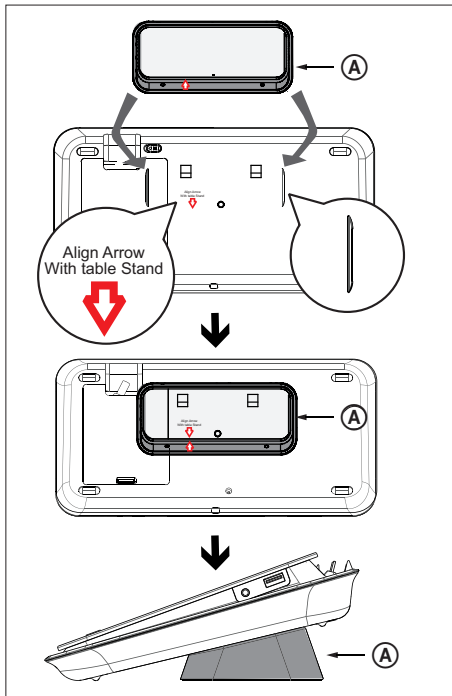

(A) table stand bracket

Mount the DVD Home Theater unit

! Caution!

- Risk of personal injury and damage to the unit. Allow only qualified persons to mount the unit.

- 1 Ensure all the required cables are connected to this unit and close the rear cover.
- 2 Attach the big wall mount bracket to table stand bracket with screws.

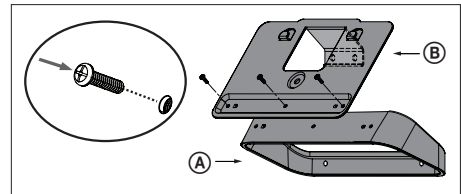

(A) table stand bracket

(B) big wall mount bracket

- 3 Position the brackets on the wall, drill four screw holes and secure the brackets onto the wall with screws (not supplied.)

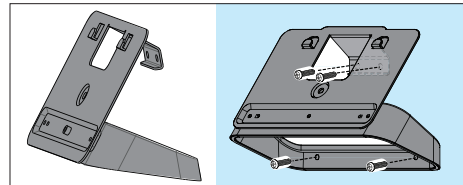

- 4 Hook the DVD Home Theater unit firmly onto the mounted bracket.

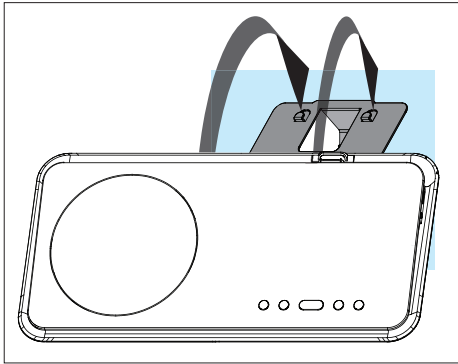

- 5** Screw the supplied knob to the hole at the center rear to secure the DVD Home Theater unit to the bracket.

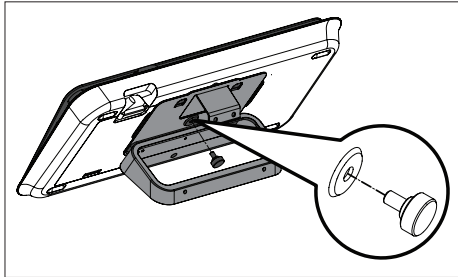

Mount the speakers



Caution!

- Risk of personal injury and damage to the unit. Allow only qualified persons to mount the unit.

- 1** Loosen the screws at the bottom of the speaker to remove the speaker stand.

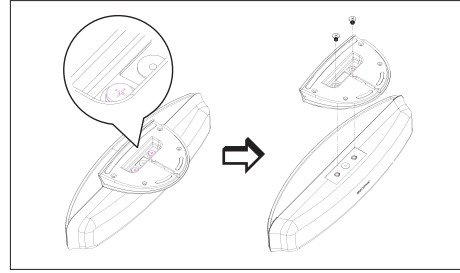

- 2** Attach the small wall mount bracket to the speaker with screws.

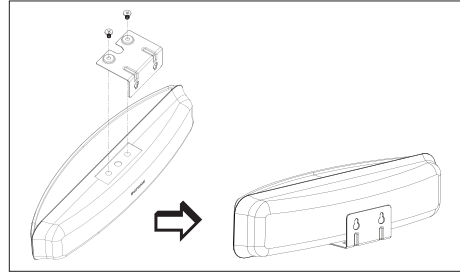

- 3** Fix two screws (not supplied) to the wall, then hook the bracket onto the screws and lock the speaker into position.

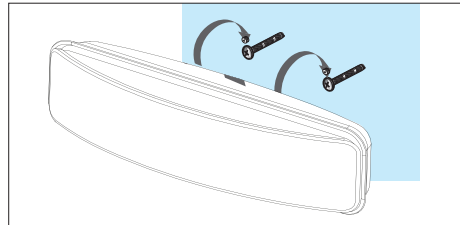

4 Get started

Prepare the remote control

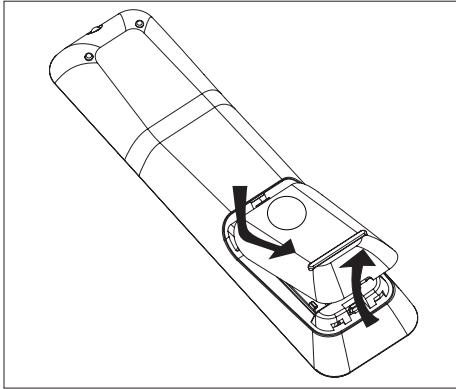

- 1 Push to open the battery compartment cover.
- 2 Insert two batteries type R03 or AAA. Match the indications (+ -) inside the battery compartment.
- 3 Close the cover.

Note

- If you are not going to use the remote control for a long time, remove the batteries.

Control a play source

- 1 Select the source you wish to control by pressing the **DISC**, **USB**, **RADIO** or **AUX/DI/MP3 LINK** or **DOCK** button.
- 2 Then select the desired function (for example **◀**, **▶**.)

Navigate through the menu

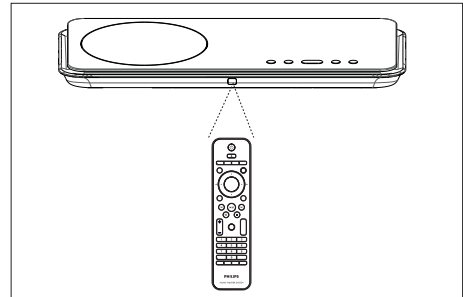

- 1 Point the remote control directly at the remote sensor on this unit and select the desired function.



- 2 Use the following buttons on the remote control to navigate through the on-screen menus.

Button	Action
▲ ▼	Move up or down.
◀ ▶	Move left or right.
○ OK	Confirm a selection.
1 2 3 4 5 6 7 8 9 0	Enter numbers.

Find the correct viewing channel

- 1 Press  to turn on the DVD Home Theater unit.
- 2 Press **DISC** to switch to disc mode.
- 3 Turn on the TV and switch it to the correct video-in channel.
 - You may go to the lowest channel on your TV, then press the Channel Down button on your TV's remote control until you see the Video In channel.
 - You may press  button repeatedly on your TV's remote control.
 - Usually this channel is between the lowest and highest channels and may be called FRONT, A/V IN, VIDEO, etc..
 - If you are using a RF modulator, set the TV to channel 3 or 4.



Tips

- See TV's user manual on how to select the correct input on your TV.





Select menu display language



Note

- You can skip this setting if this unit is connected to a HDMI CEC compliant TV. It switches automatically to the same OSD menu language as per your TV setting.

- 1 Press **DISC**.
- 2 Press **OPTIONS**.
↳ [**General Setup**] menu is displayed.
- 3 Press **▶**.
- 4 Press **▲▼** to select [**OSD Language**] in the menu, then press **▶**.

General Setup		
	EasyLink	Auto
	Disc Lock	English
	Display Dim	Espanol
	OSD Language	Français
	Screen Saver	
	Sleep Timer	
	Standby Mode	
	DivX(R) VOD Code	

- The language options are different depending on your country or region. It may not correspond to the illustration shown here.

- 5 Press **▲▼** to select a language, then press **OK**.







Tips

- To set the default language for DVD audio and disc menu, see chapter 'Adjust settings' - [**Preference Setup**] for details.

Start Ambisound setup





Change the Ambisound setup according to your room environment and setup in order to obtain the best possible surround sound effect.

- 1 Press **DISC**.
- 2 Press **OPTIONS**.
- 3 Press **▼** to select  [**Audio Setup**] in the menu, then press **▶**.

Audio Setup	
	Ambisound Setup
	HDMI Audio
	Night Mode
	

- To access Ambisound setup option, this DVD Home Theater unit must be in a complete stop mode. Press **■** twice if necessary.

- 4 Select [**Ambisound Setup**] in the menu, then press **▶**.

Ambisound Setup		
	Room Acoustics	Hard
	Room Placement	Soft
	Speaker Distance	
	Listening Position	

- 5 Select a setup you want to change, then press **▶**.

Type of wall that surround your room.

[Room Acoustics]

- [**Hard**] (concrete, wood)
- [**Soft**] (curtains, open space)

Speakers placement in your room.

[Room Placement]

- [**Middle of room**]
- [**Corner of room**]
- [**Near the right wall**]
- [**Near the left wall**]

Distance between two speakers.

[Speaker Distance]

- [**Near**] (< 2m / 78in)
- [**Default**] (2m~3m / 78~118in)
- [**Far**] (> 3m / 118in)

Distance between the listening position and the speakers.

[Listening Position]

- [**Near**] (< 2m / 78in)
- [**Default**] (2m~3m / 78~118in)
- [**Far**] (> 3m / 118in)





- 6 Press **▲▼** to select a setting, then press **OK**.

- 7 To exit the menu, press **OPTIONS**.

Turn on Progressive Scan

If you connect this unit to TV with the component video connection (see chapter 'Connect video cables - Option 2: Connect to component video jack' for details,) you can turn on the progressive scan output if your TV supports progressive scan.

- 1 Turn on the TV to the correct viewing channel for this unit.
- 2 Press **DISC**.
- 3 Press **OPTIONS**.
- 4 Press **▼** to select  [**Video Setup**] in the menu, then press **▶**.

Video Setup	
	TV Type On
	TV Display Off
	Picture Settings
	HDMI Setup
	Closed Caption
	Progressive

- 5 Select [**Progressive**] > [**On**], then press **OK**.
↳ A warning message is displayed.
- 6 To proceed, select [**OK**] in the menu and press **OK**.
↳ The progressive setup is complete.

Note

- If a blank/distorted screen is displayed, wait for 15 seconds for the auto recover.
- If no picture displayed, turn off the progressive scan mode as follows:
 - 1) Press **▲** to open the disc compartment.
 - 2) Press **▶**.
 - 3) Press **SUBTITLE**.

- 7 To exit the menu, press **OPTIONS**.
- 8 You can now turn on the progressive scan mode on your TV (see the TV user manual.)

Note

- There are some progressive scan TVs that are not fully compatible with this unit, resulting in an unnatural picture when playing back a DVD VIDEO disc in the progressive scan mode. In such case, turn off the progressive scan feature on this unit and your TV.

Activate EasyLink control

This feature is only applicable if this unit is connected to HDMI CEC compliant TV/device. It enables all the linked devices response or react to certain commands simultaneously with one touch control.

- 1 Turn on the HDMI CEC operations on your TV and other connected devices. See TVs/devices manual for details.
- 2 You can now enjoy the EasyLink controls.

One touch play [Auto Wake-up TV]

When you press PLAY button, this unit will wake- up from standby mode and start disc play (if a video disc is found in the disc compartment) and it will also turn on your TV and switch to the correct viewing channel.

One touch power off [System Standby]

When you press and hold STANDBY button, it will turn off this unit and all the linked devices to standby.

This unit also responses to standby command from other HDMI CEC devices.

One touch audio input switching [System Audio Control]

This unit is able to render the audio signals from the active source. It switches automatically to the corresponding audio input and output the sound from its speaker system.

- Before you can enjoy this function, you have to map the audio inputs to the connected devices.
- You can use any HDMI CEC TV/device remote control to adjust the volume.

Note





- To enable one touch play function, a video disc must be placed in the disc compartment before operation.
- Philips does not guarantee 100% interoperability with all HDMI CEC compliant devices.

Map the audio inputs to the connected devices

Note

- Before you start, ensure that an audio connection has been made between this unit and your TV/ devices.





- 1 Press DISC.
- 2 Press OPTIONS.
↳ [General Setup] menu is displayed.
- 3 Press ►.
- 4 Select [EasyLink], then press ►.

General Setup		
	EasyLink	Auto Wake-up TV
	Disc Lock	System Standby
	Display Dim	System Audio Control
	OSD Language	Audio Input Mapping
	Screen Saver	
	Sleep Timer	
	Standby Mode	
	DivX(R) VOD Code	

- [Auto Wake-up TV] and [System Standby] functions are turned on by default in the factory.
- 5 Select [System Audio Control] > [On], then press OK.
 - 6 Select [Audio Input Mapping], then press OK.

- 7 Select [**OK**] in the menu, then press **OK** to start scanning of devices.

↳ Once complete, audio input mapping menu is displayed.

Audio Input Mapping		
	AUX1 Input	TV
	AUX2 Input	Other (non-HDMI)
	AUX3 Input	
	Digital Input	

- For example, if your TV audio is connected to the AUX IN-AUX 1 sockets on this unit, select [**AUX1 Input**] and map with the TV (brand name) at the right panel.

- 8 Select the audio input of this unit that is used to connect to other HDMI device (e.g. AUX1 Input, AUX2 Input), then press **▶**.

- 9 Select the correct device that connected to this audio input, then press **OK**.
- Repeat steps 8~9 to map other connected devices.

- 10 To exit the menu, press **OPTIONS**.

Select a play source

On the main unit

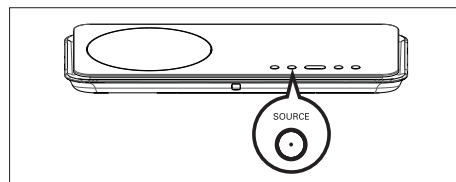

- 1 Press **SOURCE** button repeatedly to select: **DISC > USB > DOCK > RADIO FM > DIGITAL INPUT > AUX1 INPUT > AUX2 INPUT > AUX3 INPUT > MP3 LINK > DISC ...**

On the remote control

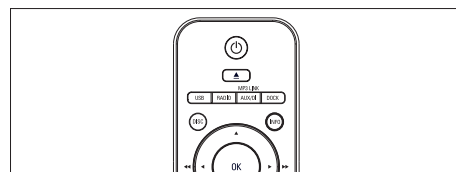

- Press **DISC** to switch to DISC mode.
- Press **USB** to switch to USB mode.
- Press **RADIO** to switch to FM band.
- Press **DOCK** to switch to iPod mode.
- Press **AUX/DI /MP3 LINK** repeatedly to select other external devices.

Display	Device connected to
AUX1 INPUT	AUDIO IN-AUX1 jacks.
AUX2 INPUT	AUDIO IN-AUX2 jacks.
AUX3 INPUT	AUDIO IN-AUX3 jacks.
DIGITAL INPUT	DIGITAL IN-COAXIAL jack.
MP3 LINK	MP3 LINK jack.

5 Play

Play from disc

Playable discs

	DVD Video (Digital Versatile Disc) <ul style="list-style-type: none">• Region 1
	DVD±RW (DVD Rewritable)
	DVD±R (DVD Recordable)
	DVD+R DL (DVD+R Double Layer)
	CD-RW (CD-Rewritable)
	CD-R (CD-Recordable)
	Audio CD (Compact Disc Digital Audio)
	Video CD <ul style="list-style-type: none">• Formats 1.0, 1.1, 2.0
	Super Video CD

Note

- DVDs and DVD players are designed with regional restrictions. Ensure that the DVD video you play is for the same region zone as your player (indicated on its rear.)
- This unit can support playback of the following file formats: MP3/WMA/JPEG/DivX.

Play a disc

! Caution!

- Never place any objects other than discs into the disc compartment.
- Never touch the disc optical lens inside the disc compartment.

- 1 Press **▲** to open the disc compartment.
- 2 Insert a disc with its label facing up.
 - For double-sided disc, load the side to play faces up.
- 3 Press **▲** to close the disc compartment and start disc play.
 - To view disc play, turn on the TV to the correct viewing channel for this DVD Home Theater unit.
- 4 To stop disc play, press **■**.

* Tips

- If the password entry menu is displayed, you have to Enter the 6-digit password before it can be played.
- Screen saver displays automatically if the disc play is stopped for about 15 minutes. To wake up from screen saver, press **DISC**.
- This unit automatically switches to standby mode if you do not press any buttons within 30 minutes after a disc has stopped playing.

Play video



Note

- For video disc, playback always resumes from the point where it was last stopped. To start playback from the beginning, press **◀** while the message is displayed.

Control a title

- 1 Play a title.
- 2 Use the remote control to control the title.

Button	Action
	Pause/ resume play.
	Stop play.
	Jump to the next title/chapter.
	Return to the beginning of the current title/chapter or jump to the previous title/chapter.
	Search backward/ forward. <ul style="list-style-type: none">• To change search speed, press this button repeatedly.
	Slow motion reverse/ forward play. <ul style="list-style-type: none">• To change play speed, press this button repeatedly.• For VCD, only forward play is possible.

Change video play

- 1 Play a title.
- 2 Use the remote control to change the video play.

Button	Action
	Change audio language. <ul style="list-style-type: none">• Only applicable to discs with multiple audio language or channel.
	Change subtitle language. <ul style="list-style-type: none">• Only applicable to discs with multiple subtitle language.
	Toggle through various repeat/ shuffle play mode; or turn off repeat mode. <ul style="list-style-type: none">• Repeat options vary depending on the disc type.• For VCDs, repeat play is only possible if the PBC mode is turned off.
	Zoom in/out. <ul style="list-style-type: none">• To pan through the zoomed image, press the cursor buttons.
	Display current play status. <ul style="list-style-type: none">• You can change the video play options here without interrupting disc play.
	View DVD play from different camera angles. <ul style="list-style-type: none">• Only applicable to DVDs that contain sequences recorded from different camera angles.

Access DVD menu

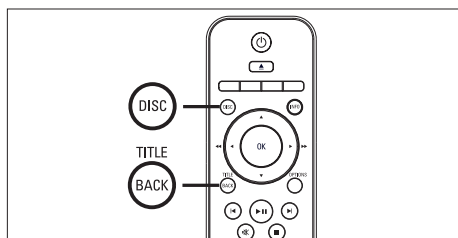

- 1 Press **DISC** to access disc main menu.
- 2 Select a play option, then press **OK**.
 - In some menus, press **number buttons** to input your selection.
 - To return to the title menu during playback, press **TITLE**.

Access VCD menu

The PBC (Playback Control) for VCD is turned on by default in the factory. When you load in a VCD, the contents menu is displayed.

- 1 Press **▲▼** to select a play option, then press **OK** to start play.
 - If PBC is off, it skips the menu and starts play from the first title.
 - During playback, you can press **BACK** to return to the menu (if the PBC mode is on.)



Tips

- The default setting for PBC is on. To change the default setting, see chapter 'Adjust settings' - [**Preference Setup**] > [**PBC**] for details.

Sync audio output with video play

If the video play is slower than the audio output (sound does not match with the pictures,) you can delay the audio output to match the video.

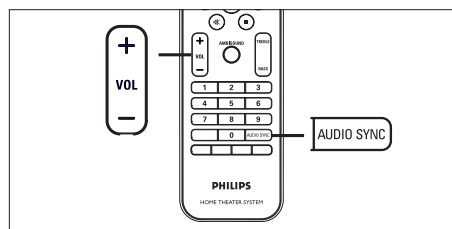

- 1 Press and hold **AUDIO SYNC** until 'AUDIO SYNC XXX' is displayed.
 - 'XXX' denotes the delay time.
- 2 Within five seconds, press **VOL + -** to set the delay time for audio output.



Note

- If the volume control is not used within 5 seconds, it resumes normal volume control function.

Quick skip play to a specific time

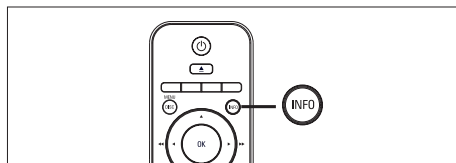





- 1 During playback, press **INFO**.
↳ The disc status menu is displayed.
- 2 Select the current elapsed playing time in the menu, then press **OK**.
 - [**TT Time**] (title time)
 - [**CH Time**] (chapter time)
 - [**Disc Time**] (disc time)
 - [**Track Time**] (track time)
- 3 Press the **number buttons** to change the time where you want to skip to, then press **OK**.

Play DivX® video

DivX video is a digital media format that retains high quality despite a high rate of compression. This unit is DivX® Certified that allows you to enjoy DivX video.

- 1 Insert a disc or USB that contains the DivX videos.
- 2 Press **DISC** or **USB**.
↳ A contents menu is displayed.
- 3 Select a title to play, then press **▶||**.
- 4 Use the remote control to control the title.

Button	Action
	Change subtitle language.
	Change audio language/track.
	Stop play. <ul style="list-style-type: none">• For DivX Ultra video, press this button again to display the contents menu.
	Display DivX Ultra video information.



Note

- Only those DivX videos that were rented or purchased using the DivX registration code of this unit can be played (see chapter 'Adjust settings' > [**General Setup**] > [**DivX(R) VOD Code**] for details).
- If the subtitle does not appear correctly, change the subtitle language (see chapter 'Adjust settings' - [**Preference Setup**] > [**DivX Subtitle**] for details.)
- The subtitle can only be displayed up to an average of 45 characters.
- This unit can play DivX video files that are up to 4GB in size.

Play music



Note

- For some commercial audio disc, playback may resume from the point where it was last stopped. To start playback from first track, press **◀**.

Control a track

- 1 Play a track.
- 2 Use the remote control to control the track.

Button	Action
	Pause/ resume play.
	Stop play.
	Jump to the next track.
	Return to the beginning of the current track or jump to the previous track.
	Direct input the track number.
	Search backward/ forward. <ul style="list-style-type: none">• To change search speed, press this button repeatedly.
	Toggle through various repeat/ shuffle play mode; or turn off repeat mode. <ul style="list-style-type: none">• Repeat options vary depending on the disc type.

Play MP3/WMA music

MP3/WMA is a type of highly compressed audio file (files with .mp3 or .wma extensions).

- 1 Insert a disc or USB that contains the MP3/WMA music.
- 2 Press **DISC** or **USB**.
 - ↳ A contents menu is displayed.
- 3 Select a folder, then press **OK**.
- 4 Select a track to play, then press **▶||**.
 - To return to the main menu, press **▲** until 'Previous' folder is selected, then press **OK**.



Note

- For CDs recorded in multiple sessions, only the first session is played.
- This unit does not support MP3PRO audio format.
- If any special characters are present in the MP3 track name (ID3) or album name, it might not be displayed correctly on the screen because these characters are not supported.
- Some WMA is protected by Digital Rights Management (DRM), it cannot be played on this unit.
- Folders/files exceed the supported file limit of this unit will not be displayed or played.



Tips

- To display the data disc contents without folders, see chapter 'Adjust settings' - **[Preference Setup] > [MP3/JPEG Nav]** for details.

Play photo

Play photos as slideshow

This unit can play JPEG photos (files with .jpeg or .jpg extensions).

- 1 Insert a disc or USB that contains the JPEG photos.
- 2 Press **DISC** or **USB**.
 - ↳ For a Kodak disc, the slideshow begins automatically.
 - ↳ For a JPEG disc, the photo menu is displayed.
- 3 Select the folder/album you want to play.
 - To preview the photos in the folder/album, press **INFO**.



- To go to previous or next screen display, press **◀** / **▶**.
 - To select a photo, press the cursor buttons.
 - To display the selected photo only, press **OK**.
- 4 Press **▶||** to start slideshow play.
 - To return to the menu, press **BACK**.

Note

- It may require longer time to display the disc contents on the TV due to the large number of songs/photos compiled onto one disc.
- If the JPEG photo is not recorded with an 'exif' type file, the actual thumbnail picture will not be shown on the display. It will be replaced with a 'blue mountain' thumbnail picture.
- This unit can only display digital camera pictures according to the JPEG-EXIF format, typically used by almost all digital cameras. It cannot display Motion JPEG and pictures in formats other than JPEG, or sound clips associated with pictures.
- Folders/files exceed the supported file limit of this unit will not be displayed or played.

Control photo play

- 1 Play photo slideshow.
- 2 Use the remote control to control the photo.

Button	Action
◀	Skip to the previous photo.
▶	Skip to the next photo.
▲	Rotate the photo clockwise.
▼	Rotate the photo anti-clockwise.
ZOOM	Zoom in/ out. <ul style="list-style-type: none">• Play will pause while in zoom mode.
◻	Stop play.

Play musical slideshow

Play MP3/WMA music files and JPEG photo files simultaneously to create musical slideshow. The MP3/WMA and JPEG files must be stored on the same disc or USB device.

- 1 Play MP3/WMA music.
- 2 Navigate to the photo folder/album and press **▶||** to start slideshow play.
 - ↳ Slideshow begins and continues till the end of the photo folder or album.
 - ↳ Audio continues to play till the end of the disc.
 - To return to the menu, press **BACK**.
- 3 To stop slideshow play, press **■**.
- 4 To stop music play, press **■** again.

Play from USB device

This unit can only play/view MP3, WMA, DivX (Ultra) or JPEG files that are stored on such devices.

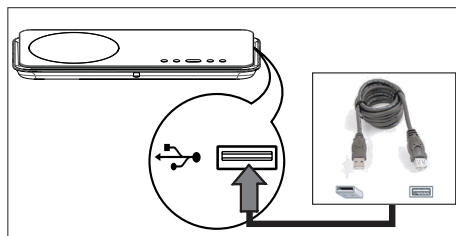

- 1 Connect a digital camera that comply with the PTP standard, USB flash drive, or USB memory card reader to the **↔** (USB) jack on this unit.
- 2 Press **USB**.
 - ↳ A contents menu is displayed.
- 3 Select a file to play, then press **▶||**.
 - For more information, see chapters 'Play music, Play photo, Play video' for details.
- 4 To stop play, press **■** or remove the USB device.

Tips

- If the device does not fit into the USB jack, connect it through a USB extension cable.
- If a multiple USB card reader is used, only one of the connected USB drive contents can be accessed.
- If a USB HDD is used, ensure that an auxiliary power cord connected to the USB HDD for proper operations.
- Digital cameras that use PTP protocol or require additional program installation when connected to a PC are not supported.

Play from portable media player

Simply connect your portable media player (e.g. MP3 player) to this unit to enjoy superb sound quality from your music collections.

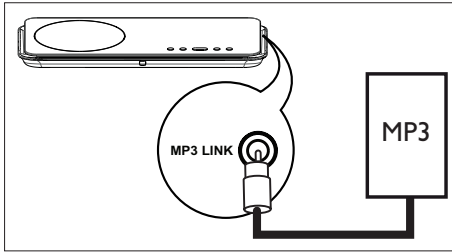

- 1 Connect a 3.5mm stereo audio cable (not supplied) from the **MP3 LINK** jack on this unit to the 'headphone' jack on your portable media player.
- 2 Press **AUX/DI /MP3 LINK/** repeatedly until 'MP3 LINK' is displayed.
- 3 Start play on your portable media player.
 - See chapter 'Adjust Sound' to enhance the audio output.
- 4 To stop play, press **STOP** button on your portable media player.

Note

- Control playback is only possible on your portable media player.
- Stop play on the portable media player before you switch to other play media/source.

Play from iPod

Simply dock your iPod to this DVD Home Theater unit to enjoy music/video play from your iPod.

List of supported iPod range:

iPod mini	iPod nano 1st gen
iPod touch	iPod nano 2nd gen
iPod classic	iPod nano 3rd gen
iPod mini 2nd gen	iPod 5th gen
iPod with color display	

Note

- Refer to Philips website for latest updates on supported iPod range.
- Later versions of iPod models and iPhones are not supported.

Prepare the iPod slot

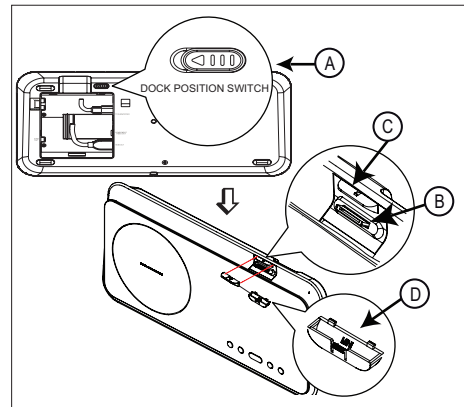

- (A) 'slide'
- (B) 'support'
- (C) 'holder'
- (D) iPod dock adaptor

- 1 Push the 'slide' button (A) to one side and move the 'holder' (C) until you get the best position to fit your iPod.
- 2 Release the 'slide' button (A).
- 3 Select a matching dock adaptor and attach it to the 'holder' (C).

Control iPod music

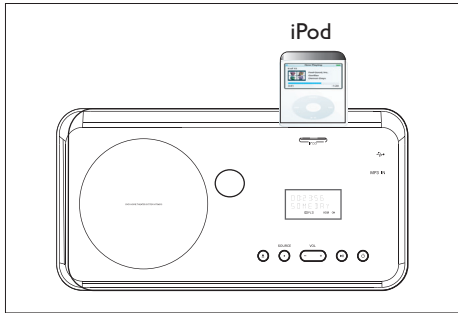

- 1 Dock your iPod to the **iPod** slot and turn it on.
- 2 Press **DOCK**.
 - It may require longer time to authenticate the compatibility of certain iPod range.
- 3 Start play on your iPod.
 - To view iPod video play, a video connection to your TV through the VIDEO OUT socket is required. Ensure that 'TV ON' setting on iPod is turned on.
- 4 During playback, you can use the remote control to control the music play.

Button	Action
	Change the volume level.
	Select a predefined sound effect.
	Select an Ambisound effect.
	Go to the previous/ next track.
	Search backward/ forward.
	Pause/resume play.
	Switch to 'Extended Control mode' to enable control of your iPod play through the contents displayed on TV. <ul style="list-style-type: none"> • Control buttons on iPod have no function in this mode. • Press this button again to return to simple play mode.

Tips

- While in iPod mode, the battery of your iPod will be charged.

Play from radio

Check if the FM antenna has been connected to the subwoofer. If not, connect the supplied FM antenna to the FM 75Ω jack and fix its ends to the wall.

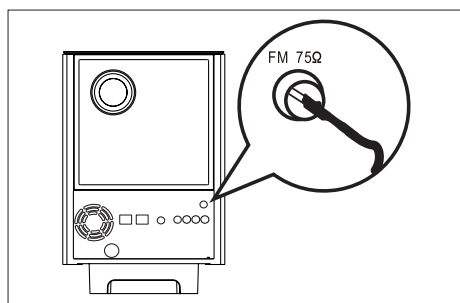

Tips

- For better FM stereo reception, connect an external FM antenna (not supplied.)
- Position the antenna as far away as possible from your TV, VCR or other radiation source to prevent interference.

First time tuning

The first time when you access 'RADIO' mode, follow the instructions to install the radio stations.





- 1 Press **RADIO**.
↳ 'AUTO INSTALL ... PRESS PLAY' is displayed.
- 2 Press **▶||**.
↳ All detected radio stations are stored.
↳ Once complete, it tunes to the first preset radio station.
 - To stop auto tuning, press **■**.

Note

- This unit can store up to a maximum of 40 radio stations.
- If auto installation is not activated or less than 5 radio stations are stored, 'AUTO INSTALL' will be displayed again the next time you turn on to radio mode.

Listen to radio

- 1 Press **RADIO**.
- 2 Use the remote control to control the radio.

Button	Action
	Select a preset radio station.
	Tune the radio frequency backward/ forward.
	Toggle between FM stereo and FM mono mode.
	Press and hold this button to delete the preset station from the preset list. <ul style="list-style-type: none">• The preset number for other radio stations remain unchanged

Reinstall all the radio stations

- 1 Press **RADIO**.
- 2 Press and hold **PROGRAM** until 'STARTING INSTALL' is displayed.
 - ↳ All previously stored radio stations will be replaced.



Note



- If no stereo signal is detected or less than 5 stations are detected during radio installation, 'CHECK ANTENNA' is displayed.

Search and store radio stations individually

- 1 Press **RADIO**.
- 2 Press **◀▶▶▶**.
 - ↳ The radio frequency indication starts to change until a radio station is detected.
- 3 Repeat step 2 until you tune to the radio station you wish to store.
 - To finetune the radio frequency, press **▲▼**.
- 4 Press **PROGRAM**.
 - If no action is carried out within 20 seconds after the above step, it exits the preset mode.
- 5 Press **◀▶** (or the **number buttons**) to select a preset number to store.
- 6 Press **PROGRAM** to confirm.

6 Adjust sound

Control the volume

- 1 Press **VOL + -** to increase or decrease the volume level.
 - To mute the volume, press .
 - To restore the volume, press  again or press the volume button.

Adjust Bass/Treble

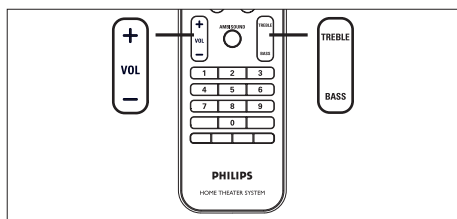

- 1 Press **BASS / TREBLE**.
- 2 Press **VOL + -** repeatedly to set the level for low (BASS) or high (TREBLE) tone.



Note

- If the volume control is not used within 10 seconds, it resumes normal volume control function.

Select Ambisound

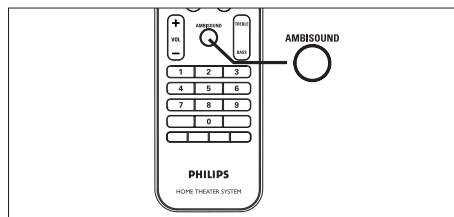

- 1 Press **AMBISOUND** repeatedly to select a best Ambisound output that most suits the video or music you play.

Options	Descriptions
AUTO	The surround output will be selected based on the audio stream of the played contents.
MULTI-CHANNEL	Multi-channel surround sound.
STEREO	Stereo sound.

Select a preset sound effect

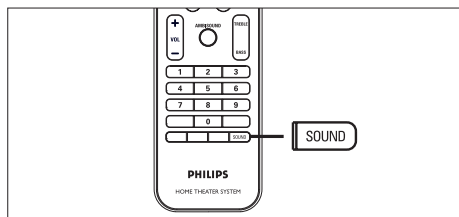





- 1 Press **SOUND** repeatedly to select a sound effect that most suits the video or music you play.

Video / Music /	Descriptions
ACTION / ROCK /	Enhanced low and high range for great sounding movie effects and atmosphere. Great for action movies and rock/pop music.
DRAMA / JAZZ	Clear mid and high range. Recreates the atmosphere of a live club with the artist just in front of you. Good for Jazz music and watching dramas.
CONCERT / CLASSIC	Flat and pure sound mode. Ideal for listening to classical music and watching live concert DVDs.
GAMING / PARTY	Slightly enhanced low range and strong mid range ideal for party music and video gaming.
SPORTS	Moderate mid range and surround effects for clear vocals and the atmosphere of a live sports venue.
NEWS	Enhanced mid range for clear vocals/speech.





7 Adjust settings

This section describes the various setting options of this unit.

Symbol	Options
	[General Setup]
	[Audio Setup]
	[Video Setup]
	[Preference Setup]

General setup

- 1 Press **OPTIONS**.
↳ [**General Setup**] menu is displayed.
- 2 Press **▶**.
- 3 Select an option, then press **OK**.

General Setup	
	EasyLink
	Disc Lock
	Display Dim
	OSD Language
	Screen Saver
	Sleep Timer
	Standby Mode
	DivX(R) VOD Code

- See the explanations of the above options in the following pages.
- 4 Select a setting, then press **OK**.
 - To return to the previous menu, press **BACK**.
 - To exit the menu, press **OPTIONS**.

[EasyLink]

This feature is only applicable if this unit is connected to HDMI CEC compliant TV/ device. It enables all the linked devices response or react to certain commands simultaneously with one touch control.

Options	Descriptions
[Auto Wake-up TV]	It wake-ups your TV automatically when you press PLAY to power up this unit and start disc play (if a video disc is found in the disc compartment). <ul style="list-style-type: none"> • To disable this feature, select [Off].
[System Standby]	Respond to standby command from other HDMI CEC compliant TV/devices. <ul style="list-style-type: none"> • To disable this feature, select [Decline].
[System Audio Control]	It enables this DVD Home Theatre unit to switch automatically to the audio input of the active device. <ul style="list-style-type: none"> • To enable this feature, select [On]. Then proceed to [Audio Input Mapping] to scan and map all the connected devices.

-
- [Audio Input Mapping]** Map the audio input to the connected TV/ devices correctly to enable automatic switching of input source.
1. Press **OK** to start scanning of devices.
 2. Select the audio input to map (e.g. AUX1 Input, AUX2 Input,) then press **▶**.
 3. Select the correct device that connected to this audio input, then press **OK**.
-

 **Note**

- Your TV and other connected devices must be compliant with HDMI CEC.
- You must turn on the HDMI CEC operations on your TV/devices before you can enjoy the EasyLink controls. See your TVs/devices manual for details.
- Philips does not guarantee 100% interoperability with all HDMI CEC compliant devices.

[Disc Lock]

Set play restriction for a specific discs. Before you start, place the disc in the disc compartment (maximum 40 discs can be locked.)

- **[Lock]** – restrict access to the current disc. The next time you want to play this disc, you need to enter the password.
- **[Unlock]** – all discs can be played.

 **Tips**

- To set or change your password, go to **[Preference Setup] > [Password]**.

[Display Dim]

Change the brightness level of the display panel to suit the lighting in your room.

- **[100%]** – normal brightness.
- **[70%]** – medium brightness.
- **[40%]** – dimmest display. The LEDs and display icons will not be shown.

[OSD Language]

Select the default on-screen menu language.

[Screen Saver]

Turn off or on the screen saver mode. It helps to protect the TV screen from being damage due to over exposure to a static image for too long.

- **[On]** – set the screen saver to appear after 15 minutes of inactivity (for example, in pause or stop mode.)
- **[Off]** – disable screen saver mode.

[Sleep Timer]

Switch to standby automatically after the preset time.

- **[Off]** – disable sleep mode.
- **[15, 30, 45, 60 mins]** – select the count down time before it switches to standby.

[Standby Mode]

Set the standby mode.

- **[Normal]** – normal standby power consumption.
- **[Low Power]** – low standby power consumption. However, it requires longer time to power up.

[DivX(R) VOD Code]

Display the DivX® registration code.







Tips

- Enter this unit's DivX registration code when you rent or purchase video from www.divx.com/vod. The DivX videos rented or purchased through the DivX® VOD (Video On Demand) service can be played only on the device to which it is registered.

Audio setup

- 1 Press **OPTIONS**.
↳ [**General Setup**] menu is displayed.
- 2 Press ▼ to select  [**Audio Setup**], then press ►.
- 3 Select an option, then press **OK**.

Audio Setup	
	Ambisound Setup
	HDMI Audio
	Night Mode
	
	

- 4 Select a setting, then press **OK**.
 - To return to the previous menu, press **BACK**.
 - To exit the menu, press **OPTIONS**.

[Ambisound Setup]

Change the Ambisound setup.

Options	Descriptions
[Room Acoustics]	Select the type of walls that surround your room.
[Room Placement]	Select this unit placement in the room.
[Speaker Distance]	Select the distance between two speakers.
[Listening Position]	Select the distance between your listening position and this unit.



Tips

- See chapter 'Get Started - Start Ambisound setup' for detailed information.

[HDMI Audio]

When you connect this unit and TV with HDMI cable, select the audio output setting for this connection.

- [**On**] – the sound is output through both your TV and this speaker system. If the audio format on the disc is not supported, it will be downmix to two-channel sound (linear-PCM).
- [**Off**] – disable audio output from your TV. The sound is only output through this speaker system.





[Night Mode]

Make loud sound level softer and soft sound level louder so that you can watch the DVD movies at a low volume, without disturbing others.

- [**On**] – for quiet viewing at night (DVDs only).
- [**Off**] – enjoy surround sound with a full dynamic range.

Video setup

- 1 Press **OPTIONS**.
↳ [**General Setup**] menu is displayed.
- 2 Press **▼** to select  [**Video Setup**], then press **▶**.
- 3 Select an option, then press **OK**.

Video Setup	
	TV Type
	TV Display
	Picture Settings
	HDMI Setup
	Closed Caption
	Progressive
	

- See the explanations of the above options in the following pages.
- 4 Select a setting, then press **OK**.
 - To return to the previous menu, press **BACK**.
 - To exit the menu, press **OPTIONS**.

[TV Type]

Change this setting only if the video does not appear correctly. By default, this setting matches the most common setting for TVs in your country.

- [**NTSC**] – for NTSC-system TV.
- [**Multi**] – for TV that is compatible with both PAL and NTSC.

[TV Display]

Select the screen format according to how you want the picture to appear on your TV.

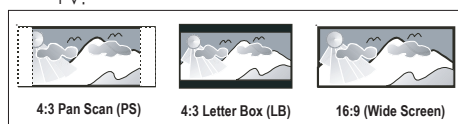

- [**4:3 Pan Scan**] – for standard TV, a full-height screen display with the sides trimmed.
- [**4:3 Letter Box**] – for standard TV, a 'wide-screen' display with black bars on the top and bottom.
- [**16:9 Wide Screen**] – for wide-screen TV (frame ratio 16:9).

[Picture Settings]

Select a predefined set of picture color settings or customize your personal setting.

- [**Standard**] – original color setting.
- [**Bright**] – vibrant color setting.
- [**Soft**] – warm color setting.
- [**Personal**] – customize the color setting. Set the level of brightness, contrast, tint and color saturation in the menu, then press **OK**.

[HDMI Setup]

When you connect this unit and TV with HDMI cable, select the best HDMI setup that your TV can support.

- [**Wide Screen Format**] – define the wide screen format for disc play.

Options	Descriptions
[Superwide]	Center position of the screen is stretched less than the side. This setting is only applicable if the video resolution is set to 720p or 1080i/p.
[4:3 Pillar Box]	No stretching of the picture. Black bars are displayed on both sides of the screen.
[Off]	Picture will be displayed according to the format of the disc.

Note

- This setting is only available if you have set the [**TV Display**] setting to [**16:9 Wide Screen**].

- [**HDMI Video**] – select a video resolution that is compatible with your TV display capability.

Options	Descriptions
[Auto]	It detects and selects the best supported video resolution automatically.
[480p, 576p, 720p, 1080i, 1080p]	Select a video resolution that best supported by your TV. See your TV's manual for details.



Note

- If the setting is not compatible with your TV, a blank screen appears. Wait for 15 seconds for auto recover or press **HDMI** repeatedly until the picture appears.

[Closed Caption]

Turn on or off display captions.

- [**On**] – show the sound effects in subtitle. Only applicable to disc with Closed Caption information included and your TV supports this feature.
- [**Off**] – disable closed caption.

[Progressive]

If your TV can support progressive signals, you can activate the progressive scan mode of this unit.

- [**On**] – turn on progressive scan mode.
- [**Off**] – disable progressive scan mode.



Tips

- See chapter 'Get Started - Turn on Progressive Scan' for detailed information.

Preference Setup

- 1 Press **OPTIONS**.
↳ [**General Setup**] menu is displayed.
- 2 Press **▼** to select [**Preference Setup**], then press **▶**.
- 3 Select an option, then press **OK**.

Preference Setup	
	Audio
	Subtitle
	Disc Menu
	Parental
	PBC
	MP3/JPEG Nav
	Password
	DivX Subtitle ▼

- See the explanations of the above options in the following pages.
- 4 Select a setting, then press **OK**.
 - To return to the previous menu, press **BACK**.
 - To exit the menu, press **OPTIONS**.

[Audio]

Select the default audio language for DVDs.

[Subtitle]

Select the default subtitle language for DVDs.

[Disc Menu]

Select the menu language for DVDs.

Note

- If the language you have set is not available on the disc, the disc uses its own default language.
- For some DVDs, the subtitle/audio language can only be changed from the disc menu.
- To select the languages that are not listed in the menu, select **[Others]**. Then check the Language Code list at the back of this user manual and Enter the respective 4-digit language code.

[Parental]

Restrict access to DVDs that are unsuitable for your children. These types of DVDs must be recorded with ratings.

1. To start, press **OK**.
2. Select a rating level in the menu, then press **OK**.
3. Press the **number buttons** to Enter your 6-digit password.

Note

- Rated DVDs above the level you set in **[Parental]** require a password to be played.
- The ratings are country-dependent. To allow all discs to play, select **'8'**.
- Some DVDs have ratings printed on them but are not recorded with ratings. This function has no effect on such DVDs.

Tips

- To set or change your password, go to **[Preference Setup] > [Password]**.

[PBC]

For VCDs/SVCDs recorded with PBC (playback control,) you can access the disc contents through an interactive menu.

- **[On]** – an index menu is displayed when you load a disc for play.
- **[Off]** – skip the menu and start play from the first title.

[MP3/JPEG Nav]

Turn off or on MP3/WMA folder display when you play a media that contains MP3/WMA files.

- **[Without Menu]** – display all the files.
- **[With Menu]** – display the folders of MP3/WMA files.

[Password]

Follow the instructions on the TV to set or change the password for locked discs and play restricted DVDs.

Change Password	
Old Password	<input type="text"/>
New Password	<input type="text"/>
Confirm PWD	<input type="text"/>
	<input type="button" value="OK"/>

1. Press the **number buttons** to Enter '136900' or your last set 6-digit password at **[Old Password]** field.
2. Enter the new password at **[New Password]** field.
3. Enter the new password again at **[Confirm PWD]** field.
4. Press **OK** to exit the menu.

Note

- If you forget your 6-digit password, Enter '136900' before you set a new password.

[DivX Subtitle]

Select a character set that supports the DivX subtitle.

[Standard]	English, Irish, Danish, Estonian, Finnish, French, German, Italian, Portuguese, Luxembourgish, Norwegian (Bokmål and Nynorsk), Spanish, Swedish, Turkish
[Central Europe]	Polish, Czech, Slovak, Albanian, Hungarian, Slovene, Croatian, Serbian (Latin script), Romanian
[Cyrillic]	Belarusian, Bulgarian, Ukrainian, Macedonian, Russian, Serbian
[Greek]	Greek
[Hebrew]	Hebrew



Note

- Ensure that the subtitle file has the exact same file name as the movie file. If for example the filename of the movie is 'Movie.avi', then you will need to name the text file 'Movie.sub' or 'Movie.srt'.

[Version Info]

Display the software version of this unit.



Tips

- This information is required when you want to find out if a newest software version is available at the Philips website that you may download and install on this unit.

[Default]

Reset all the settings of this unit to factory default, except for [**Disc Lock**], [**Password**] and [**Parental**] settings remain unchanged.

8 Additional information

Update software

Philips provides software updates to ensure that this unit is compatible with the newest formats.

To check for updates, compare the current software version of this unit with the latest software version available at the Philips website.

- 1 Press **OPTIONS**, .

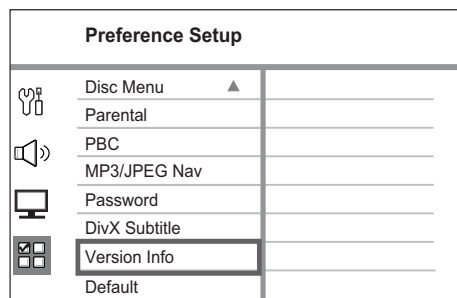

- 2 Select [**Preference Setup**] > [**Version Info**], then press **OK**.
- 3 Write down the version number, then press **OPTIONS** to exit the menu.
- 4 Go to www.philips.com/support to check the latest software version available for this unit.
- 5 If the latest software version is higher than the software version of this unit, download it and store onto a CD-R or USB flash drive

- 6 Insert the CD-R or USB flash drive to this unit.

- 7 Press **DISC** or **USB**, then follow the instruction on the TV to confirm update operation.



Note

- Do not remove the CD-R or USB when software updating is in progress.

- 8 Once software update is complete, this unit turns off to standby automatically.



Note

- We recommend that you disconnect the power cord for a few seconds and connect again to reboot the system.

Care



Caution!

- Never use solvents such as benzene, thinner, cleaners available commercially, or anti-static sprays intended for discs.

Clean discs

Wipe the disc with a micro fiber cleaning cloth from the center to the edge in a straight line movement.

Clean main unit screen

Wipe the screen surface with a micro fiber cleaning cloth.

Specifications



Note

- Specification and design are subject to change without notice.

Accessories supplied

- Quick Start Guide
- Remote control and batteries
- Composite video cable (yellow)
- Component video cables
- HDMI cable
- Subwoofer
- 2 Ambisound speakers
- 1 main unit wall mount bracket and 2 speakers wall mount bracket
- Mounting knob (to secure the main unit to the bracket)
- Table stand with screws (for main unit)
- 4 iPod dock adaptors
- FM wire antenna
- Micro fiber cleaning cloth

Amplifier

- Total output power:
 - Home Theater mode: 600 W
 - FTC mode (1% THD): 320 W
- Frequency response: 20 Hz - 20 kHz / ± 3 dB
- Signal-to-noise ratio: > 65 dB (CCIR)
- Input sensitivity
 - AUX : 800 mV
 - MP3 LINK: 370 mV

Disc

- Laser Type: Semiconductor
- Disc diameter: 12cm / 8cm
- Video decoding: MPEG1/ MPEG2 / DivX / DivX Ultra
- Video DAC: 12 bits, 148 MHz
- Signal system: PAL / NTSC
- Video S/N: 56 dB
- Audio DAC: 24 bits / 192 kHz
- Frequency response: 20 Hz - 20 kHz
- PCM: IEC 60958
- Dolby Digital, DTS: IEC60958, IEC61937

Radio

- Tuning range: FM 87.5-108 MHz (100 kHz)
- 26 dB quieting sensitivity: FM 22 dBf
- IF rejection ratio: FM 60 dB
- Signal-to-noise ratio: FM 60 dB
- Harmonic distortion: FM 3%
- Frequency response: FM 180 Hz - 9 kHz / ± 6 dB
- Stereo separation: FM 26 dB (1 kHz)
- Stereo Threshold: FM 23.5 dB

USB

- Compatibility: Hi-Speed USB (2.0)
- Class support: UMS (USB Mass Storage Class)

Power (Subwoofer)

- Power supply: 120V, ~60 Hz
- Power consumption: 150 W
- Standby power consumption
 - Normal: < 3 W
 - Low standby: < 0.3 W
- System: Bass Reflex System
- Impedance: 4 ohm
- Speaker drivers: 165 mm (6 1/2") woofer
- Frequency response: 30 Hz - 160 Hz
- Dimensions (WxHxD): 295 x 440 x 295 (mm)
- Weight: 9.5 kg

Main unit

- Dimensions (WxHxD): 419 x 48 x 214 (mm)
- Net Weight: 1.7 kg

Ambisound speakers:

- System: full range satellite
- Speaker impedance: 8 ohm/channel, 8 ohm/center channel
- Speaker drivers: 2.5" full range/channel
- Frequency response: 190 Hz - 20 kHz
- Dimensions (WxHxD): 335.5 x 113 x 128.5 (mm)
- Weight: 1.72 kg

9 Troubleshooting



Warning!

- Risk of electric shock. Never remove the casing of this unit.

To keep the warranty valid, never try to repair the system yourself.

If you encounter problems when using this unit, check the following points before requesting service. If the problem remains unsolved, register your product and get support at www.philips.com/welcome.

Main unit

The buttons on this unit do not work.

- Disconnect this unit from the power outlet for a few minutes, then connect again.
- Ensure that the interconnect cable from the subwoofer is connected to this DVD Home Theater unit.

Picture

No picture.

- See TV's manual for correct video input channel selection. Change the TV channel until you see the DVD screen.
- Press **DISC**.
- If this happens when you turn on the progressive scan setting or change the TV type setting, you have to switch to its default mode:
 1. Press **▲** to open the disc compartment.
 2. Press **▶** (for progressive scan) or **◀** (for TV type).
 3. Press **SUBTITLE**.

No picture on HDMI connection.

- Check if the HDMI cable is faulty. Replace a new HDMI cable.
- If this happens when you change the HDMI video resolution, press **HDMI** repeatedly until the picture appears.

Sound

- No sound.**
- Ensure that the audio cables are connected and press the correct input source (for example, AUX/DI /MP3 LINK, USB) to select the device you want to play.
-
- No sound on HDMI connection.**
- You may not hear any sound from the HDMI output if the connected device is non-HDCP compliant or only DVI-compatible.
 - Ensure that the [**HDMI Audio**] setting is turned on.
-
- No sound from TV programs.**
- Connect an audio cable from the AUDIO input on this unit to the AUDIO output on your TV. Then press **AUX/DI /MP3 LINK** repeatedly to select the corresponding audio input source.

Play

- DivX video files cannot be played.**
- Ensure that the DivX file is encoded according to the 'Home Theater Profile' with the DivX encoder.
 - Ensure that the DivX video file is complete.
-
- DivX subtitle are not displayed correctly.**
- Ensure that the subtitle file name is the same as the movie file name.
 - Select the correct character set.
 1. Press **OPTIONS**.
 2. Press **▶**, then select [**DivX Subtitle**] in the menu.
 3. Select the character set that supports the subtitle.
-
- The contents of the USB flash drive cannot be read.**
- The USB flash drive format is not compatible with this unit.
 - Drive is formatted with different file system which is not supported by this unit (e.g. NTFS.)
 - Maximum size of memory supported is 160GB.
-
- The video (movies, photos, video clips, etc) contents of the iPod does not display in Extended Control mode.**
- Video browsing is not supported in Extended Control mode, you can only browse the video contents on the iPod itself.

10 Glossary

Aspect ratio

Aspect ratio refers to the length to height ratio of TV screens. The ratio of a standard TV is 4:3, while the ratio of a high-definition or wide TV is 16:9. The letter box allows you to enjoy a picture with a wider perspective on a standard 4:3 screen.

DivX

The DivX code is a patent-pending, MPEG-4 based video compression technology, developed by DivX Networks, Inc., that can shrink digital video to sizes small enough to be transported over the internet, while maintaining high visual quality.

Dolby Digital

A surround sound system developed by Dolby Laboratories containing up to six channels of digital audio (front left and right, surround left and right, center and subwoofer.)

HDMI

High-Definition Multimedia Interface (HDMI) is a high-speed digital interface that can transmit uncompressed high definition video and digital multichannel audio. It delivers high quality picture and sound quality, completely free from noise. HDMI is fully backward-compatible with DVI.

As required by the HDMI standard, connecting to HDMI or DVI products without HDCP (High-bandwidth Digital Content Protection) will result in no Video or Audio output.

HDCP

High-bandwidth Digital Content Protection is a specification that provides a secure transmission of digital contents between different devices (to prevent unauthorized copyright).

JPEG

A very common digital still picture format. A still-picture data compression system proposed by the Joint Photographic Expert Group, which features small decrease in image quality in spite of its high compression ratio. Files are recognised by their file extension 'JPG or JPEG'.

MP3

A file format with a sound data compression system. 'MP3' is the abbreviation of Motion Picture Experts Group 1 (or MPEG-1) Audio Layer3. By using the MP3 format, one CD-R or CD-RW can contain about 10 times more data than a regular CD. Files are recognised by their file extension '.MP3'.

MPEG

Motion Picture Experts Group. A collection of compression systems for digital audio and video.

PBC

Playback Control. A system of Navigating a Video CD/Super VCD through on-screen menus recorded onto the disc. You can enjoy interactive playback and searching.

PCM

Pulse Code Modulation. A digital audio encoding system.

Progressive Scan

The progressive scan displays twice the number of frames per seconds than ordinary TV system. It offers higher picture resolution and quality.

WMA

Windows Media™ Audio. Refers to an audio compression technology developed by Microsoft Corporation. WMA data can be encoded by using Windows Media Player version 9 or Windows Media Player for Windows XP. Files are recognised by their file extension 'WMA'.

PHILIPS LIMITED WARRANTY ONE (1) YEAR

WARRANTY COVERAGE:

PHILIPS warranty obligation is limited to the terms set forth below.

WHO IS COVERED:

Philips warrants the product to the original purchaser or the person receiving the product as a gift against defects in materials and workmanship as based on the date of original purchase ("Warranty Period") from an Authorized Dealer. The original sales receipt showing the product name and the purchase date from an authorized retailer is considered such proof.

WHAT IS COVERED:

The Philips warranty covers new products if a defect in material or workmanship occurs and a valid claim is received by Philips within the Warranty Period. At its option, Philips will either (1) repair the product at no charge, using new or refurbished replacement parts, or (2) exchange the product with a product that is new or which has been manufactured from new, or serviceable used parts and is at least functionally equivalent or most comparable to the original product in Philips current inventory, or (3) refund the original purchase price of the product. Philips warrants replacement products or parts provided under this warranty against defects in materials and workmanship from the date of the replacement or repair for ninety (90) days or for the remaining portion of the original product's warranty, whichever provides longer coverage for you. When a product or part is exchanged, any replacement item becomes your property and the replaced item becomes Philips' property. When a refund is given, your product becomes Philips' property.

Note: Any product sold and identified as refurbished or renewed carries a ninety (90) day limited warranty.

Replacement product can only be sent if all warranty requirements are met. Failure to follow all requirements can result in delay.

WHAT IS NOT COVERED - EXCLUSIONS AND LIMITATIONS:

This Limited Warranty applies only to the new products manufactured by or for Philips that can be identified by the trademark, trade name, or logo affixed to it. This Limited Warranty does not apply to any non-Philips hardware product or any software, even if packaged or sold with the product. Non-Philips manufacturers, suppliers, or publishers may provide a separate warranty for their own products packaged with the bundled product.

Philips is not liable for any damage to or loss of any programs, data, or other information stored on any media contained within the product, or any non-Philips product or part not covered by this warranty. Recovery or reinstallation of programs, data or other information is not covered under this Limited Warranty.

This warranty does not apply (a) to damage caused by accident, abuse, misuse, neglect, misapplication, or non-Philips product, (b) to damage caused by service performed by anyone other than Philips or Philips Authorized Service Location, (c) to a product or a part that has been modified without the written permission of

Philips, or (d) if any Philips serial number has been removed or defaced, or (e) product, accessories or consumables sold "AS IS" without warranty of any kind by including refurbished Philips product sold "AS IS" by some retailers.

This Limited Warranty does not cover:

- Shipping charges to return defective product to Philips.
- Labor charges for installation or setup of the product, adjustment of customer controls on the product, and installation or repair of antenna/signal source systems outside of the product.
- Product repair and/or part replacement because of improper installation or maintenance, connections to improper voltage supply, power line surge, lightning damage, retained images or screen markings resulting from viewing fixed stationary content for extended periods, product cosmetic appearance items due to normal wear and tear, unauthorized repair or other cause not within the control of Philips.
- Damage or claims for products not being available for use, or for lost data or lost software.
- Damage from mishandled shipments or transit accidents when returning product to Philips.
- A product that requires modification or adaptation to enable it to operate in any country other than the country for which it was designed, manufactured, approved and/or authorized, or repair of products damaged by these modifications.
- A product used for commercial or institutional purposes (including but not limited to rental purposes).
- Product lost in shipment and no signature verification receipt can be provided.
- Failure to operate per Owner's Manual.

TO OBTAIN ASSISTANCE IN THE U.S.A., PUERTO RICO, OR U.S. VIRGIN ISLANDS...

Contact Philips Customer Care Center at:
1-888-PHILIPS (1-888-744-5477)

TO OBTAIN ASSISTANCE IN CANADA...

1-800-661-6162 (French Speaking)
1-888-PHILIPS (1-888-744-5477) - (English or Spanish Speaking)

REPAIR OR REPLACEMENT AS PROVIDED UNDER THIS WARRANTY IS THE EXCLUSIVE REMEDY FOR THE CONSUMER. PHILIPS SHALL NOT BE LIABLE FOR ANY INCIDENTAL OR CONSEQUENTIAL DAMAGES FOR BREACH OF ANY EXPRESS OR IMPLIED WARRANTY ON THIS PRODUCT. EXCEPT TO THE EXTENT PROHIBITED BY APPLICABLE LAW, ANY IMPLIED WARRANTY OF MERCHANTABILITY OR FITNESS FOR A PARTICULAR PURPOSE ON THIS PRODUCT IS LIMITED IN DURATION TO THE DURATION OF THIS WARRANTY.

Some states do not allow the exclusions or limitation of incidental or consequential damages, or allow limitations on how long an implied warranty lasts, so the above limitations or exclusions may not apply to you.

This warranty gives you specific legal rights. You may have other rights which vary from state/province to state/province.

Philips, P.O. Box 671539, Marietta, GA. 30006-0026

3121 233 48802

Free Manuals Download Website

<http://myh66.com>

<http://usermanuals.us>

<http://www.somanuals.com>

<http://www.4manuals.cc>

<http://www.manual-lib.com>

<http://www.404manual.com>

<http://www.luxmanual.com>

<http://aubethermostatmanual.com>

Golf course search by state

<http://golfingnear.com>

Email search by domain

<http://emailbydomain.com>

Auto manuals search

<http://auto.somanuals.com>

TV manuals search

<http://tv.somanuals.com>