

User Manual	6
Manuel D'utilisation	56
Manual de Instrucciones	106
Bedienungsanleitung	156
Gebruiksaanwijzing	206

Thank you for choosing Philips.

Need help fast?

Read your Quick Use/Start Guide and/or User Manual first for quick tips that make using your Philips product more enjoyable.

*If you have read your instructions and still need assistance, you may access our online help at **www.philips.com/support***



PHILIPS

Important notes for users in the U.K.

Mains plug

This apparatus is fitted with an approved 13 Amp plug. To change a fuse in this type of plug proceed as follows:

- 1 Remove fuse cover and fuse.
- 2 Fix new fuse which should be a BS1362 5 Amp, A.S.T.A. or BSI approved type.
- 3 Refit the fuse cover.

If the fitted plug is not suitable for your socket outlets, it should be cut off and an appropriate plug fitted in its place.

If the mains plug contains a fuse, this should have a value of 5 Amp. If a plug without a fuse is used, the fuse at the distribution board should not be greater than 5 Amp.

Note: The severed plug must be disposed of to avoid a possible shock hazard should it be inserted into a 13 Amp socket elsewhere.

How to connect a plug

The wires in the mains lead are coloured with the following code: blue = neutral (N), brown = live (L).

- As these colours may not correspond with the colour markings identifying the terminals in your plug, proceed as follows:
 - Connect the blue wire to the terminal marked N or coloured black.
 - Connect the brown wire to the terminal marked L or coloured red.
 - Do not connect either wire to the earth terminal in the plug, marked E (or e) or coloured green (or green and yellow).

Before replacing the plug cover, make certain that the cord grip is clamped over the sheath of the lead - not simply over the two wires.

Copyright in the U.K.

Recording and playback of material may require consent. See Copyright Act 1956 and The Performer's Protection Acts 1958 to 1972.

Italia

DICHIARAZIONE DI CONFORMITA'

Si dichiara che l'apparecchio HTS9800W, Philips risponde alle prescrizioni dell'art. 2 comma 1 del D.M. 28 Agosto 1995 n. 548.

Fatto a Eindhoven

Philips Consumer Electronics
Philips, Glaslaan 2
5616 JB Eindhoven, The Netherlands

Norge

Typeskilt finnes på apparatens underside.

Observer: Nettbryteren er sekundert innkoplet. Den innebygde nettdelen er derfor ikke frakoplet nettet så lenge apparatet er tilsluttet nettkontakten.

For å redusere faren for brann eller elektrisk støt, skal apparatet ikke utsettes for regn eller fuktighet.

This product complies with the radio interference requirements of the European Community.



This product complies with the requirements of the following directives and guidelines: 73/23/EEC + 89/336/EEC + 93/68/EEC

ATTENTION!

For Customer Use:

Read carefully the information located at the bottom or rear of your DVD system and enter below the Serial No. Retain this information for future reference.

Model No. HTS9800W

Serial No. _____

DK

Advarsel: Usynlig laserstråling ved åbning når sikkerhedsafbrydere er ude af funktion. Undgå udsættelse for stråling.

Bemærk: Netafbryderen er sekundært indkoblet og afbryder ikke strømmen fra nettet. Den indbyggede netdel er derfor tilsluttet til lysnettet så længe netstikket sidder i stikkontakten.

S

Klass I laserapparat

Varning! Om apparaten används på annat sätt än i denna bruksanvisning specificerats, kan användaren utsättas för osynlig laserstrålning, som överskrider gränsen för laserklass I.

Observera! Stömbrytaren är sekundärt kopplad och bryter inte strömmen från nätet. Den inbyggda nätdelen är därför ansluten till elnätet så länge stickproppen sitter i vägguttaget.

SF

Luokan I laserlaite

Varoitus! Laitteen käyttäminen muulla kuin tässä käyttöohjeessa mainitulla tavalla saattaa altistaa käyttäjän turvallisuusluokan I ylittävälle näkymättömälle lasersäteilylle.

Oikeus muutoksiin varataan. Laite ei saa olla alttiina tippu-ja roiskevedelle.

Huom. Toiminnanvalitsin on kytketty toisiopuolelle, eikä se kytke laitetta irti sähköverkosta. Sisäänrakennettu verkko-osa on kytkettynä sähköverkkoon aina silloin, kun pistoke on pistorasiassa.

CAUTION

VISIBLE AND INVISIBLE LASER RADIATION WHEN OPEN AVOID EXPOSURE TO BEAM

ADVARSEL

SYNLIG OG USYNLIG LASERSTRÅLING VED ÅBNING UNDGÅ UDSÆTTELSE FOR STRÅLING

VARNING

SYNLIG OCH OSYNLIG LASERSTRÅLNING NÅR DENNA DEL ÄR ÖPPNAD BETRAKTA EJ STRÅLEN

VARO!

AVATTAESSA OLET ALTTIINA NÄKYVÄLLE JA NÄKYMÄTTÖMÄLLE LASER SÄTEILYLLE. ÄLÄ KATSO SÄTEESEEN

VORSICHT

SICHTBARE UND UNSICHTBARE LASERSTRAHLUNG WENN ABDECKUNG GEÖFFNET NICHT DEM STRAHL AUSSETZEN

ATTENTION

RAYONNEMENT LASER VISIBLE ET INVISIBLE EN CAS D'OUVERTURE EXPOSITION DANGEREUSE AU FAISCEAU

LASER

Type	Semiconductor laser GaAlAs
Wave length	650 - 660 nm (DVD) 784 - 796 nm (CD)
Output Power	7 mW (DVD) 10 mW (VCD/CD)
Beam divergence	60 degrees

Disposal of your old product



Your product is designed and manufactured with high quality materials and components, which can be recycled and reused.
When this crossed-out wheeled bin symbol is attached to a product it means the product is covered by the European Directive 2002/96/EC. Please inform yourself about the local separate collection system for electrical and electronic products.

Please act according to your local rules and do not dispose of your old products with your normal household waste. The correct disposal of your old product will help prevent potential negative consequences for the environment and human health.

Se débarrasser de votre produit usagé (Français)



Votre produit est conçu et fabriqué avec des matériaux et des composants de haute qualité, qui peuvent être recyclés et utilisés de nouveau.
Lorsque ce symbole d'une poubelle à roue barrée est attaché à un produit, cela signifie que le produit est couvert par la Directive Européenne 2002/96/EC.

Veillez vous informer du système local de séparation des déchets électriques et électroniques.
Veillez agir selon les règles locales et ne pas jeter vos produits usagés avec les déchets domestiques usuels. Jeter correctement votre produit usagé aidera à prévenir les conséquences négatives potentielles contre l'environnement et la santé humaine.

Cómo deshacerse del producto usado (Español)



Su producto ha sido diseñado y fabricado con materiales y componentes de alta calidad, que pueden ser reciclados y reutilizados.
Cuando vea este símbolo de una papelera con ruedas tachada junto a un producto, esto significa que el producto está bajo la Directiva Europea 2002/96/EC.
Deberá informarse sobre el sistema de reciclaje local separado para productos eléctricos y electrónicos.

Siga las normas locales y no se deshaga de los productos usados tirándolos en la basura normal de su hogar. El reciclaje correcto de su producto usado ayudará a evitar consecuencias negativas para el medio ambiente y la salud de las personas.

Entsorgung Ihres Altgerätes (Deutsch)



Ihr Produkt ist aus hochqualitativen Materialien und Bestandteilen hergestellt, die dem Recycling zugeführt und wiederverwertet werden können.
Falls dieses Symbol eines durchgestrichenen Müllcontainers auf Rollen auf diesem Produkt angebracht ist, bedeutet dies, dass es von der Europäischen Richtlinie 2002/96/EG erfasst wird.
Bitte informieren Sie sich über die örtlichen Sammelstellen für Elektroprodukte und elektronische Geräte.

Bitte beachten Sie die lokalen Vorschriften und entsorgen Sie Ihre Altgeräte nicht mit dem normalen Haushaltsmüll. Die korrekte Entsorgung Ihres Altgerätes ist ein Beitrag zur Vermeidung möglicher negativer Folgen für die Umwelt und die menschliche Gesundheit.

Wegwerpen van uw afgedankt apparaat (Nederlands)



Uw apparaat werd ontworpen met en vervaardigd uit onderdelen en materialen van superieure kwaliteit, die gerecycled en opnieuw gebruikt kunnen worden.
Wanneer het symbool van een doorstreepte vuilnisemmer op wielen op een product is bevestigd, betekent dit dat het product conform is de Europese Richtlijn 2002/96/EC.

Geleue u te informeren in verband met het plaatselijke inzamelingsysteem voor elektrische en elektronische apparaten.
Geleue u te houden aan de plaatselijke reglementering en apparaten niet met het gewone huishuif mee te geven. Door afgedankte apparaten op een correcte manier weg te werpen helpt u mogelijke negatieve gevolgen voor het milieu en de gezondheid te voorkomen.

Due to the inconsistency of disc formats provided by various disc manufacturers, your DVD system/ player/recorder may require a playability enhancement or upgrade. As DVD technology advances, these enhancements will become common and will be easy to complete. Go to www.philips.com/support for software upgrade.



Manufactured under license from Dolby Laboratories, "Dolby", "Pro Logic" and the double-D symbol are trademarks of Dolby Laboratories.



Manufactured under license from Digital Theater Systems, Inc. U.S. Pat. Nois. 5,451,942; 5,956,674; 5,971,380; 5,978,762; 6,226,616; 6,487,535 and other U.S. and world-wide patents issued and pending. "DTS" and "DTS Digital Surround" are registered trademarks of Digital Theater Systems, Inc. Copyright 1996, 2003 Digital Inc. All Rights Reserved.



DivX[®], DivX Certified, and associated logos are trademarks of DivX Networks, Inc and are used under license.



Windows Media and the Windows logo are trademarks, or registered trademarks of Microsoft Corporation in the United States and/or other countries.

Index

English

Hereby, Philips Consumer Electronics, B. U. Peripherals & Accessories, declares that this product is in compliance with the essential requirements and other relevant provisions of Directive 1999/5/EC.

Français

Par la présente, Philips Consumer Electronics, B. U. Peripherals & Accessories, déclare que l'appareil est conforme aux exigences essentielles et aux autres dispositions pertinentes de la directive 1999/5/CE.

Español

Por medio de la presente, Philips Consumer Electronics, B. U. Peripherals & Accessories, declara que el cumple con los requisitos esenciales y cualesquiera otras disposiciones aplicables o exigibles de la Directiva 1999/5/CE.

Deutsch

Hiermit erklart Philips Consumer Electronics, B. U. Peripherals & Accessories die ubereinstimmung des Gerates mit den grundlegenden Anforderungen und den anderen relevanten Festlegungen der Richtlinie 1999/5/EG.

Nederlands

Hierbij verklaart, Philips Consumer Electronics, B. U. Peripherals & Accessories dat het toestel in overeenstemming is met de essentiele eisen en de andere relevante bepalingen van richtlijn 1999/5/EG.

Italiano

Con la presente Philips Consumer Electronics, B. U. Peripherals & Accessories dichiara che questo e conforme ai requisiti essenziali ed alle altre disposizioni pertinenti stabilite dalla direttiva 1999/5/CE.

Svenska

Harmed intygat, Philips Consumer Electronics, B. U. Peripherals & Accessories, att denna star i overensstammelse med de vasentliga egenskapskrav och ovriga relevanta bestammelser som framgar av direktiv 1999/5/EG.

Dansk

Undertegnede Philips Consumer Electronics, B. U. Peripherals & Accessories erklarer herved, at folgende udstyr overholder de vasentlige krav og ovrigt relevante krav i direktiv 1999/5/EF.

Finnish

Philips Consumer Electronics, B. U. Peripherals & Accessories vakuuttaa taten ett tyypinen laite on direktiivin 1999/5/EY oleellisten vaatimusten ja sita koskevien direktiivin muiden ehtojen mukainen.

Portuguese

Philips Consumer Electronics, B. U. Peripherals & Accessories declara que este est conforme com os requisitos essenciais e outras disposioes da Directiva 1999/5/CE.

Ελληνικά

ΜΕ ΤΗΝ ΠΑΡΟΥΣΑ Philips Consumer Electronics, B. U. Peripherals & Accessories ΔΗΛΩΝΕΙ ΟΤΙ ΣΥΜΜΟΡΦΩΝΕΤΑΙ ΠΡΟΣ ΤΙΣ ΟΥΣΙΩΔΕΙΣ ΑΠΑΙΤΗΣΕΙΣ ΚΑΙ ΤΙΣ ΛΟΙΠΕΣ ΣΧΕΤΙΚΕΣ ΔΙΑΤΑΞΕΙΣ ΤΗΣ ΟΔΗΓΙΑΣ 1999/5/ΕΚ.

English ----- 6

Français ----- 56

Español ----- 106

Deutsch ----- 156

Nederlands ----- 206

English

Français

Español

Deutsch

Nederlands

Table of contents

General

General Information	8
Setup precautions.....	8
Accessories supplied	8
Cleaning discs	8
About recycling.....	8

Product Overview

Main Unit	9
Remote control	10-12
Using the remote control	12
Basic Connections	13-16
Step 1: Assemble the speakers.....	13
Step 2: Positioning for best effect	13
Placing the speakers	13
Placing the subwoofer.....	14
Placing the DVD system.....	14
Placing the Junction Box.....	14
Placing the AV wireless receiver box.....	14
Step 3: Connecting the DVD system, AV subwoofer and front speakers	15
Step 4: Connecting the wireless rear speakers	16
Optional Connections	17-21
Mounting the DVD system on the wall	17
Mounting the speakers on the wall	18
Connecting to a Progressive Scan TV	19
Connecting to a HDMI compatible device.....	19
Connecting to an analogue audio/ video device.....	20
Connecting to a digital audio device.....	20
Connecting to an outdoor FM antenna terminal	21

Getting Started

Step 1: Switching on the DVD system.....	22
Switching to standby mode	22
Step 2: Finding the correct viewing channel	22
Step 3 Setting language preferences	23
On-screen display (OSD) language.....	23
Audio, Subtitle and Menu language for DVD playback.....	23
Step 4: Setting the TV.....	24
Selecting the matching colour system	24
Setting the TV Display	25
Setting up Progressive Scan feature (for Progressive Scan TV only)	25
Step 5: Setting the speakers' channels	27

Table of contents

Disc Playback	
Disc operations	28-36
Playable discs	28
Playing a disc	29
Basic playback controls.....	29
Selecting various repeat/shuffle functions	30
Other playback features for video discs (DVD/VCD/SVCD)	30
Using the Disc Menu	30
Viewing playback information.....	31
Resuming playback from the last stopped point	31
Zooming in.....	31
Changing subtitle language (DVD only)	32
Changing sound track language.....	32
Switching camera angles.....	32
Playback Control (VCD only).....	32
Playing an MP3/ JPEG/MPEG-4/Windows Media™ Audio disc	33
Playing a JPEG image file (slide show)	34
Preview function	34
Zoom picture	34
Rotating/flipping the picture	34
Playing MP3 music and JPEG picture simultaneously	35
Playing a Super Audio CD (SACD)	35
Playing a DivX disc	36
DVD System Menu Options	
Accessing the DVD setup menu.....	37
General Setup Page.....	38
Audio Setup Page.....	39
Video Setup Page.....	40
Preference Setup Page	43
Radio Tuning	
Tuner Operations	45-46
Tuning to radio stations.....	45
Presetting radio stations	45
Using auto install	45
Using automatic preset.....	46
Using manual preset.....	46
Selecting a preset radio station.....	46
Deleting a preset radio station.....	46
Other Information	
Sound and Volume Controls	47-48
Selecting surround sound.....	47
Adjusting the Bass/Treble level.....	47
Selecting digital sound effects.....	47
Volume control	47
Setting the Sleep timer	48
Dimming system's display screen.....	48
Using the remote to operate your 'Philips' television.....	48
Specifications	49
Troubleshooting	50-52
Glossary	53-54
Language Code	256

General Information

CAUTION!

The machine does not contain any user-serviceable parts. Please leave all maintenance work to qualified personnel.

Setup precautions

Finding a suitable location

- Place the set on a flat, hard and stable surface. Do not place the set on a carpet.
- Do not position the set on top of other equipment that might heat it up (e.g., receiver or amplifier).
- Do not put anything under the set (e.g., CDs, magazines).
- Install this unit near the AC outlet and where the AC power plug can be reached easily.

Space for ventilation

- Place the apparatus in a location with adequate ventilation to prevent internal heat build up. Allow at least 10 cm (4") clearance from the rear and the top of the set and 5 cm (2") from the left and right to prevent overheating.

Avoid high temperatures, moisture, water and dust

- Apparatus shall not be exposed to dripping or splashing.
- Do not place any sources of danger on the apparatus (e.g., liquid filled objects, lighted candles).

Accessories supplied

- 1 DVD system
- 1 AV subwoofer
- 1 AV wireless receiver box
- 1 Junction box
- 2 centre speakers
- 2 front speakers + stands
- 2 rear speakers + stands
- 3 x 1 pair of screws for wall mount
- 3 x 1 pair of brackets for wall mount
- 1 remote control with batteries
- 1 VGA cable (for connecting between the AV subwoofer and Junction box).
- 4 x speaker cables
- 2 x power cable
- 1 x micro fibre cleaning cloth (for DVD system)
- Quick Start Guide

Cleaning discs

To clean a disc, use a micro fibre cleaning cloth and wipe the disc from the centre to the edge in a straight line.

CAUTION!

Do not use solvents such as benzene, thinner, commercially available cleaners, or anti-static sprays intended for discs.

Since the optical unit (laser) of the DVD system operates at a higher power than regular DVD or CD players, cleaning CDs intended for DVD or CD players may damage the optical unit (laser). Therefore, refrain from using a cleaning CD.

About recycling

These operating instructions have been printed on non-polluting paper. The electronic equipment contains a large number of materials that can be recycled. If you are disposing of an old machine, please take it to a recycling centre. Please observe the local regulations regarding disposal of packaging materials, exhausted batteries and an old equipment.

Main Unit

English

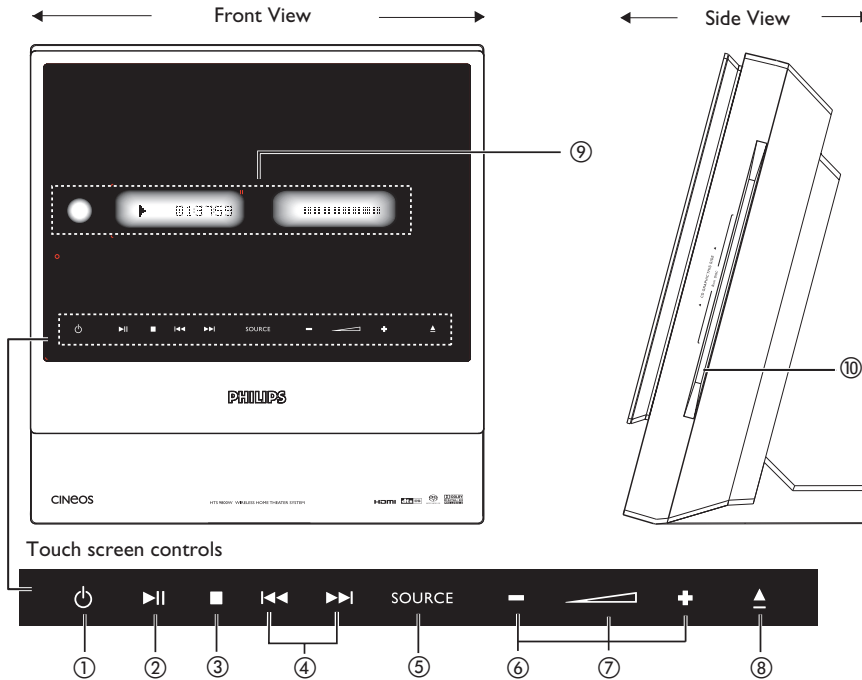

① **STANDBY ON**

- Switches to standby mode, or switches on the system.

② **PLAY PAUSE**

- DISC: starts/pauses playback.
- TUNER: starts preset radio station installation in Plug & Play mode.

③ **STOP**

- Exits an operation.
- DISC: stops playback.
- TUNER: press and hold this button to erase the current preset radio station.

④ **SEARCH**

- DISC: select a track or press and hold this button to search backwards/ forwards.
- TUNER: tunes the radio frequency up/down.

⑤ **SOURCE**

- Selects the relevant active source mode: DISC, TUNER FM, TV or AUX/DI.

⑥ **VOLUME**

- Adjusts the volume level.

⑦ **Volume Indicator**

⑧ **EJECT**

- Opens/ closes the disc tray.

⑨ **System display panel**

⑩ **Disc Slot**

Remote control

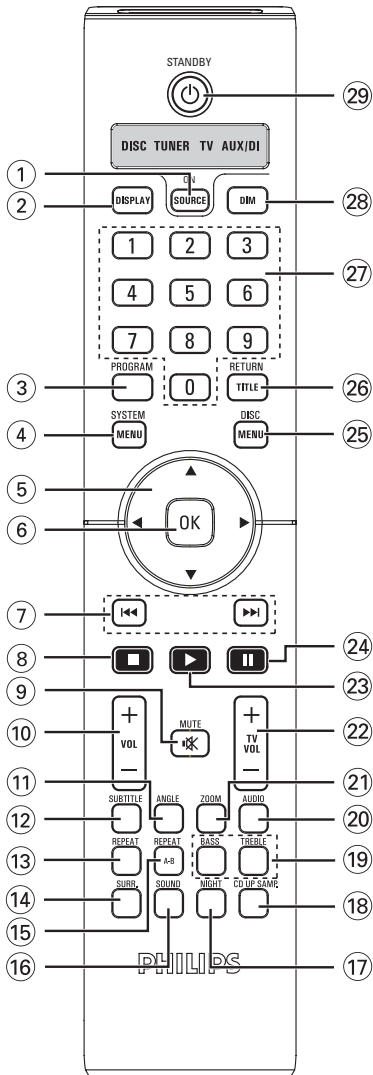

① SOURCE

- Selects the relevant active source mode: DISC, FM TUNER, TV or AUX/DI.

② DISPLAY

- Displays the current status or disc information.

③ PROGRAM

- TUNER: press and hold to start automatic/manual preset programming.

④ SYSTEM MENU

- Enters or exits the system menu.

⑤ ◀ ▶ ▲ ▼

- Selects movement direction in the menu.
- TUNER: press ◀ or ▶ to select a preset radio station.
- TUNER: press ▲ or ▼ to select auto tuning.

⑥ OK

- Confirms a selection.

⑦ ◀◀ / ▶▶

- DISC: press and hold to search backwards/forwards or to select a track.
- TV: selects previous/next channel (Philips TV only).
- TUNER: tunes the radio frequency up/down.

⑧ ■

- Exits an operation.
- DISC: stops playback or press and hold to eject a disc.
- TUNER: press and hold to erase a preset radio station.

⑨ MUTE 🔇

- Mutes or restores the volume.

⑩ VOL + -

- Adjusts the volume level.

Remote control (continued)

- ⑪ **ANGLE**
 - Select a DVD disc camera angle (if available).
- ⑫ **SUBTITLE**
 - Selects a subtitle language.
- ⑬ **REPEAT**
 - Selects various repeat modes.
- ⑭ **SURR.**
 - DISC: selects multichannel surround or stereo mode.
 - TUNER: selects stereo or mono signal.
- ⑮ **REPEAT A-B**
 - Repeats a specific section on a disc.
- ⑯ **SOUND**
 - Selects a sound effect.
 - Press and hold to select another transmission channel for the rear wireless speakers.
- ⑰ **NIGHT (in DVD mode only)**
 - Optimises the dynamics of the sound output.
- ⑱ **CD UP SAMP.**
 - Converts music CD to a higher sampling rate for better sound quality.
- ⑲ **BASS/TREBLE**
 - Select BASS (low tone) or TREBLE (high tone) sound mode and use the VOLUME control to change the tone level.
- ⑳ **AUDIO**
 - Selects an audio language (DVD) or an audio channel (CD).
- ㉑ **ZOOM**
 - Enlarges a picture on the TV screen.
- ㉒ **TV VOL + –**
 - Adjusts TV volume (Philips TV only).
- ㉓ **PLAY ▶**
 - DISC: starts playback.
- ㉔ **II**
 - DISC: pauses playback.
- ㉕ **DISC MENU**
 - Enters or exits disc contents menu.
 - For VCD version 2.0 only; In stop mode, turns on/off playback control (PBC) mode. During playback, returns to main menu.
- ㉖ **RETURN/ TITLE**
 - To go back to previous menu.
 - Displays the disc's Title menu (if available).
- ㉗ **Numeric Keypad (0-9)**
 - Enters a track/title number of the disc.
 - Enters a number of a preset radio station.
- ㉘ **DIM**
 - Selects different levels of brightness for display panel.
 - Press and hold to set the sleep timer function.
- ㉙ **STANDBY ⏻**
 - Switches to standby mode.

Remote control (continued)

Using the remote control

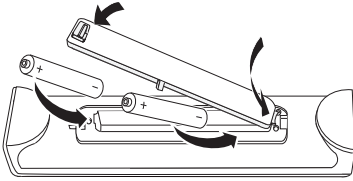

- 1 Open the battery compartment.
- 2 Insert two batteries type R06 or AA, following the indications (+ -) inside the compartment.
- 3 Close the cover.

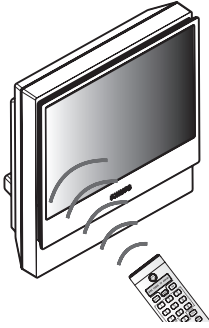

- 4 Aim the remote control directly at the remote sensor (IR) on the front panel of the DVD system.
- 5 Select the source you want to control by pressing the **SOURCE** button on the remote control.
- 6 Select the desired function (for example **◀◀**, **▶▶**).

CAUTION!

- Remove batteries if they are exhausted or if the remote control is not to be used for a long time.
- Do not mix batteries (old and new or carbon and alkaline, etc.).
- Batteries contain chemical substances, so they should be disposed of properly.

Basic Connections

Step 1: Assemble the speakers

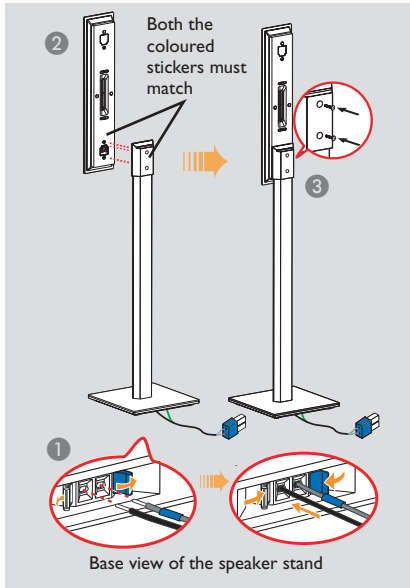

- 1 Connect the speaker stand with the supplied speaker wire. Match the colour of the speaker wire to the colour of the socket on the base of the speaker stand.
→ Hold down the socket tab while inserting the stripped portion of the speaker wire into the tab. Then, release the socket tab to lock the wire into position.
- 2 Match the coloured stickers on the rear of the speaker and the inside of the speaker stand. Position the speakers as shown and ensure the connectors fit. See the above illustration.
- 3 Secure the speaker stand with the supplied screws.

Helpful Hint:

- When you insert the speaker wire, make sure none of the rubber-coated wire is clamped by the socket tab.

Step 2: Positioning for best effect

The Philips HTS9800W Home Theatre System is simple to install. Proper system placement is critical to ensure an optimum sound experience.

- The placement diagrams shown here are only guidelines that provide great system performance, you may find other placement choices that are more suitable for your room layout and provide the sound experience you enjoy.

Placing the speakers

When placing the speakers, ensure that:

- The centre speakers (FRONT CENTER, REAR CENTER) should be placed at the same height and at the normal listening ear level for the best sound performance.
- The front speakers should be placed at an equal distance from the TV, the FRONT RIGHT on the right hand side and FRONT LEFT on the left hand side (as shown below).
- The rear speakers should be placed at equal distances from the REAR CENTER speaker; the REAR RIGHT on the right hand side and REAR LEFT on the left hand side. (as shown below).

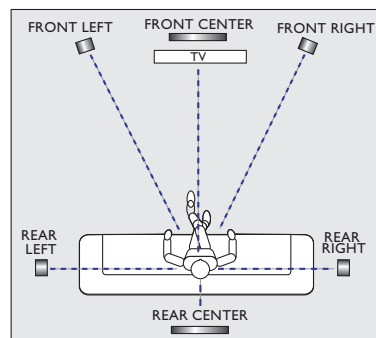

Basic Connections (continued)

Placing the subwoofer

For optimum performance, place the AV subwoofer in the corner of the room. Keep it at least one metre away from the TV. Adjust its position until a harmonious sound is achieved between the subwoofer and speakers.

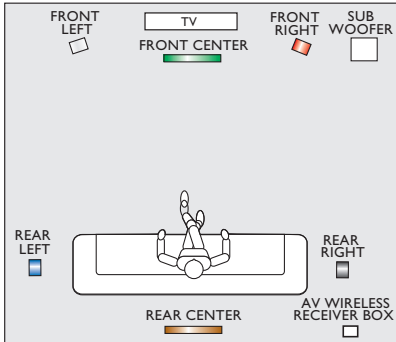

Placing the DVD system

Ensure ample space is available on the right hand side for ease of disc handling.

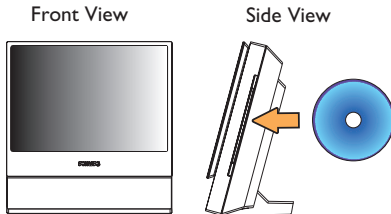

Placing the Junction Box

You may place the Junction Box behind the TV/ shelf/ table to hide away the cable connections.

For fixing purposes, attach one side of the supplied velcro strip on the Junction Box and another at the place you wish to fix the Junction Box.

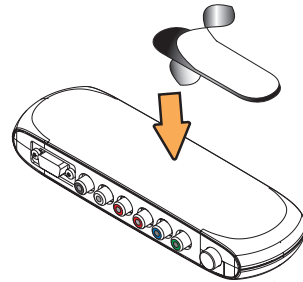

Placing the AV wireless receiver box

You may place the AV wireless receiver box at the back of the room and at a convenient distance so that you can connect the REAR CENTER, REAR LEFT and REAR RIGHT speakers to the box.

- Ensure the AV wireless receiver box is placed near the AC outlet where the AC power plug can be reached easily.
- Ensure that the front side of the AV wireless receiver box (with Philips logo) faces towards the DVD system.
- For optimal wireless performance, ensure that the AV wireless receiver box is not placed in an enclosed area.

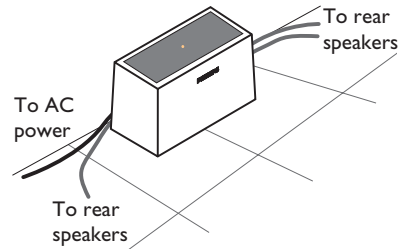

Basic Connections (continued)

English

Step 3: Connecting the DVD system, AV subwoofer and front speakers

Before you start...

If you wish to mount the DVD system on the wall, see the section "Optional Connections" before making any connections.

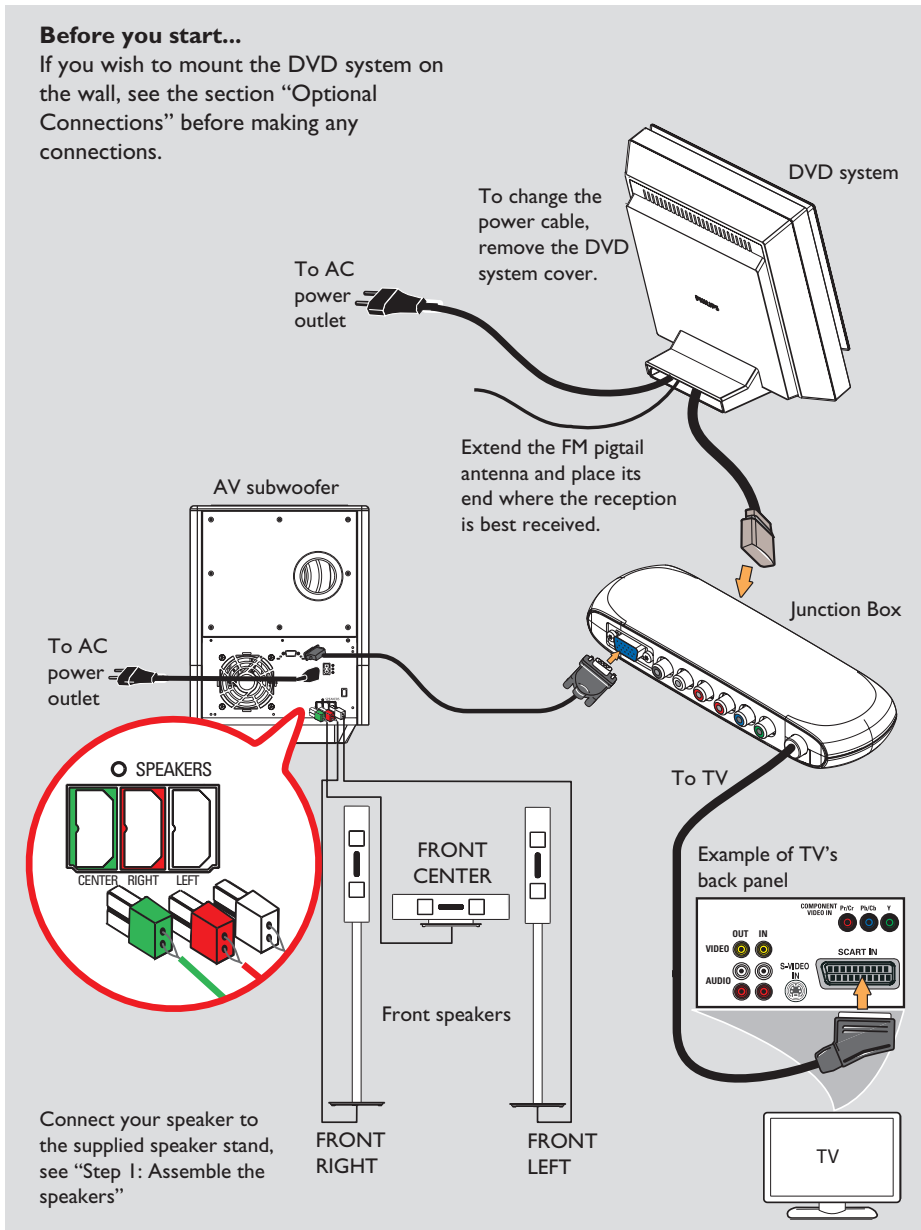

Basic Connections (continued)

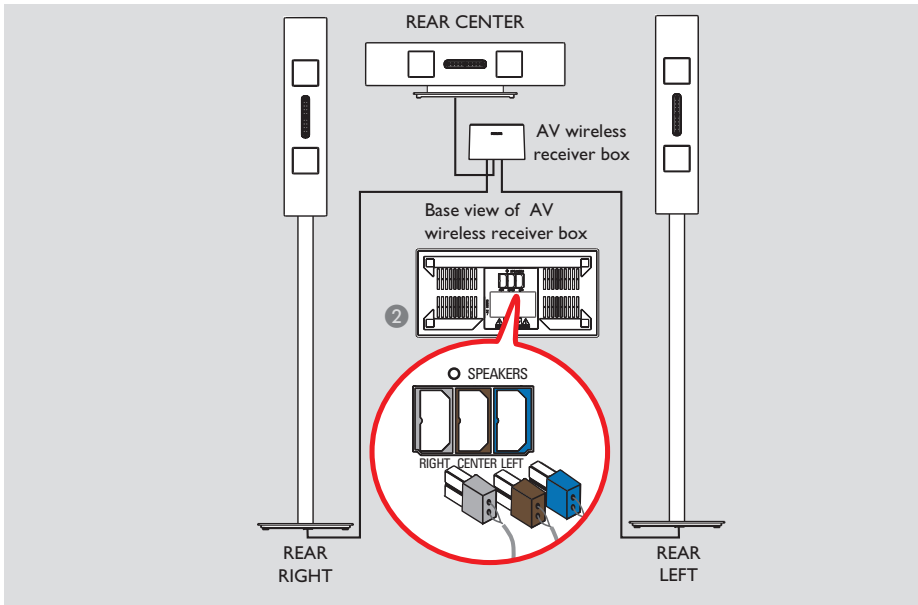

Step 4 : Connecting the wireless rear speakers

The rear speakers (REAR LEFT/ REAR RIGHT/ REAR CENTER) are to be connected to the AV wireless receiver box which receives signals from the DVD system.

Before you start...

If you wish to mount the speakers on the wall, see the section “Optional Connections” before making any connections.

- 1 Connect the stripped wire portion of the supplied speaker wire to the tab on the base of each speaker stand. See “Step 1: Assemble the speakers”.

- 2 Connect the coloured speaker plug from each speaker to the matching speaker socket on the base of the AV wireless receiver box. For convenience, each speaker socket has been colour-coded: REAR RIGHT (grey), REAR CENTER (brown) and REAR LEFT (blue).

Helpful Hints:

– To prevent unwanted noise, do not place the rear speakers too close to the DVD system, AC power adapter, TV or any other radiation sources.

Optional Connections

English

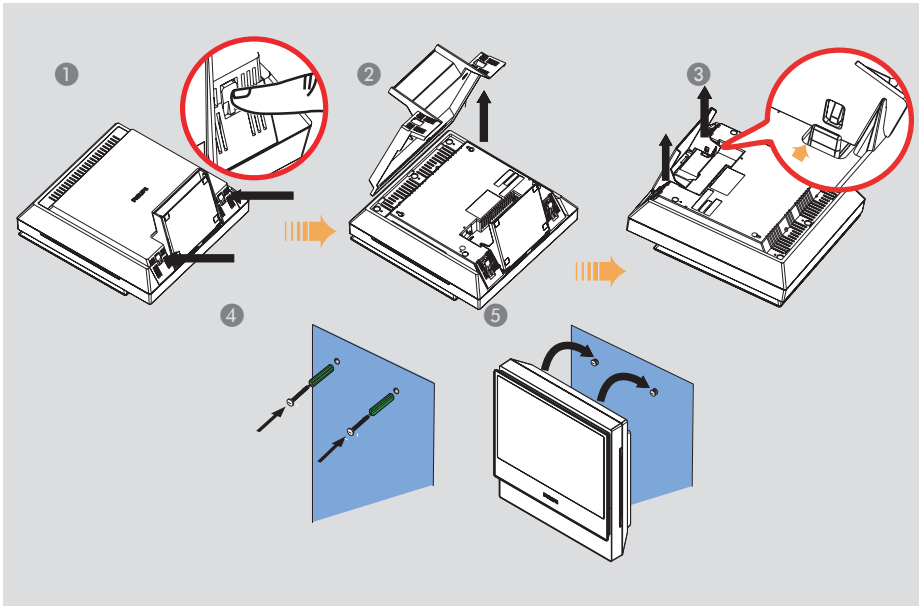

Mounting the DVD system on the wall

You can choose to wall mount the DVD system on the wall. Select a position where nothing obstructs the disc slot on its right hand side.

CAUTION!

You should get a qualified person to drill and insert the mounting screws (not supplied) on the wall. DO NOT do it yourself in order to avoid any unexpected damage to the equipment or injury to personnel.

Helpful Hint:

– Philips accepts absolutely no liability for any accidents or damage resulting from inadequate assembly or mounting, misuse or abuse, or natural disasters.

- 1 Position the DVD system face down on a non-scratch surface. Ensure the base of the system is facing you. Press the catch located on each side to release the back cover of the system.
- 2 Lift the back cover upwards and remove it from the DVD system.
- 3 Press the catch located on each inner side of the stand to remove the base of the DVD system.
- 4 Drill holes, then insert the rubber wall plugs and screws (not supplied) into the wall.
- 5 Hook the DVD system firmly onto the screws, by ensuring that they fit into the hanging brackets on the back of the DVD system to lock it into position.

Optional Connections (continued)

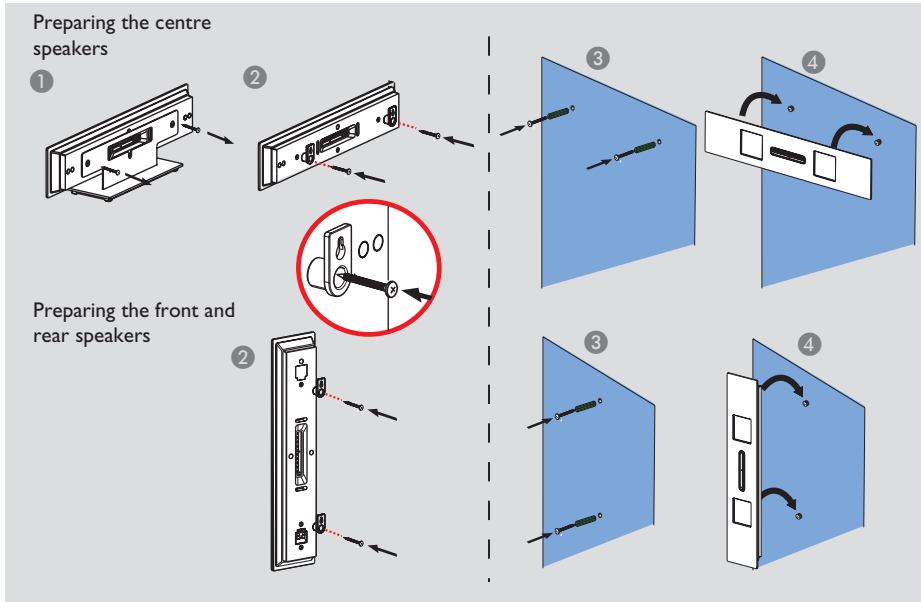

Mounting the speakers on the wall

You can choose to wall mount the speakers on the wall.

CAUTION!

You should get a qualified person to drill and insert the mounting screws (not supplied) on the wall. DO NOT do it yourself in order to avoid any unexpected damage to the equipment or injury to personnel.

Helpful Hint:

– Philips accepts absolutely no liability for any accidents or damage resulting from inadequate assembly or mounting, misuse or abuse, or natural disasters.

- 1 This step is only required for the centre speaker. To remove the centre speaker stand, loosen and remove the screws at the rear of the speakers. See the above illustrations.
- 2 Use the supplied screws to attach the supplied bracket firmly to the rear of the speakers.
- 3 Drill holes on the wall where the speaker is to be hung. Mount the rubber wall plugs and screws (not supplied) into the wall.
- 4 Hook the speaker firmly onto the screws, by ensuring that they fit into the brackets at the rear of the speaker.

Optional Connections (continued)

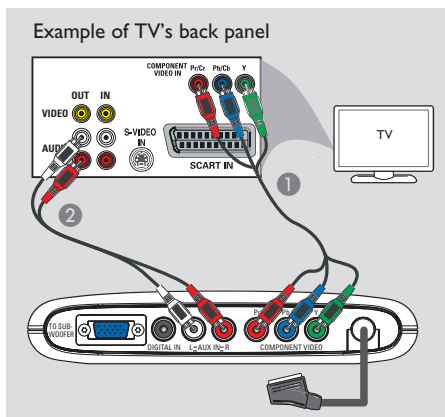

Connecting to a Progressive Scan TV

IMPORTANT!

- The progressive scan video quality is only possible when a progressive scan TV is connected to the Y Pb Pr sockets.
- **DO NOT** connect both the SCART and Y Pb Pr to a TV, it may affect the picture quality.

- 1 Use the component video cables (red/blue/green - not supplied) to connect the Junction Box's **Y Pb Pr** sockets to the corresponding component video input sockets (or labelled as Y Pb/Cb Pr/Cr or YUV) on the TV.
- Do not connect the SCART socket from the Junction Box to your TV.
- 2 To listen to the TV channels through this DVD system, use an audio cable (white/red - not supplied) to connect the **AUX IN** sockets to the corresponding AUDIO OUT sockets on the TV.
- 3 Proceed to pages 25~26 for detailed Progressive Scan set up.

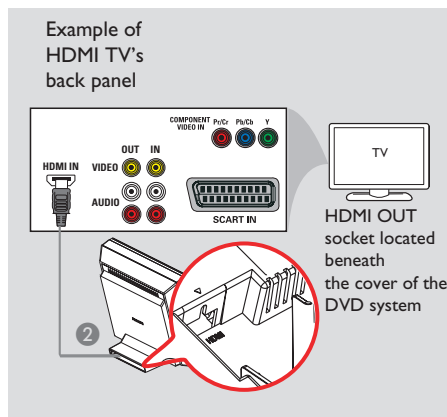

Connecting to a HDMI compatible device

HDMI connects uncompressed and unprocessed digital transmission for the highest and best defined sound/image quality. Its plug and play capability requires only one cable for both audio/video output.

- 1 Open the DVD system's back cover by releasing the two catches located at the base of the system.
- 2 Use a HDMI cable (not supplied) to connect the **HDMI OUT** socket (on the back of the DVD system) to the HDMI IN socket on a HDMI compatible device (eg. HDMI TV, HDCP compliant TV).
- 3 Once you have completed the necessary connections, installation and set-up, see pages 39 and 42 for optimum HDMI audio and video settings

Helpful Hints:

- HDMI is backward compatible with some DVI devices using an appropriate adaptor plug.
- Most older DVI-enabled devices are not HDCP compliant and playback is not possible.

Optional Connections (continued)

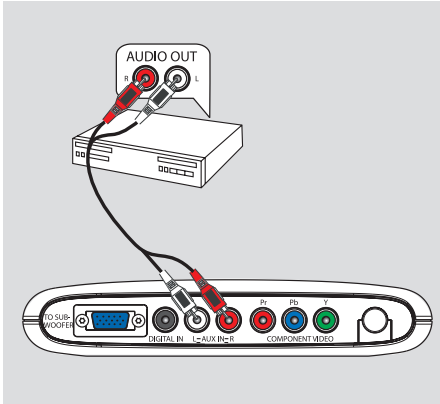

Connecting to an analogue audio/ video device

You can connect an analogue audio/video device (e.g. VCR, Cable/Satellite Box, TV or cassette recorder) to the Junction Box in order to enjoy the Home Theatre Audio System's surround sound capabilities.

- Use an audio cable (red/white - not supplied) to connect the **AUX IN** (R/L) sockets on the Junction Box to the **AUDIO OUT** sockets on an analogue audio/video device.

To listen to the sound, press **SOURCE** repeatedly to select "AUX" as the source to play.

Helpful Hints:

- Recording from this DVD system to your VCR is not possible.
- To see the picture of the connected video device (e.g. VCR), connect the **VIDEO OUT** socket of the device to the **VIDEO IN** socket of the TV, and select the correct input channel on the TV.

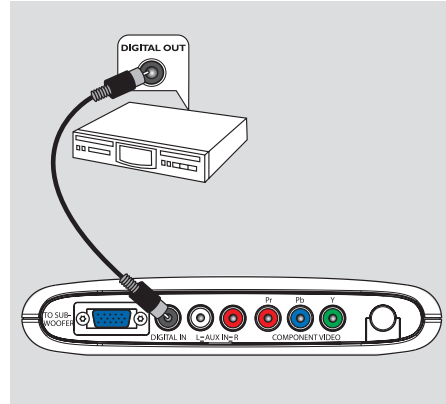

Connecting to a digital audio device

You can connect a digital audio device (e.g. CD recorder) to the Junction Box in order to enjoy the Home Theatre Audio System's surround sound capabilities.

- Use a coaxial cable (not supplied). Connect the **DIGITAL IN** socket on the Junction Box to the **DIGITAL OUT** socket on a digital audio device.

To listen to the sound, press **SOURCE** repeatedly to select "DI" as the source to play.

Helpful Hints:

- You cannot hear or record the SACD or MP3-CD playback if you use the digital connection.
- For your playback through **DIGITAL IN** connection, set the digital output of that player to **PCM** format.
- Always refer to the user manual of the other equipment for complete connection and usage details.

Optional Connections (continued)

English

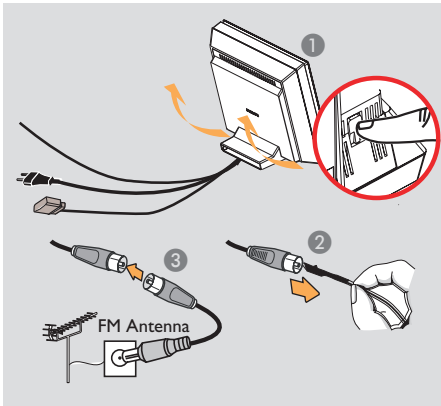

Connecting to an outdoor FM antenna terminal

If the FM reception is poor, you can use a FM coaxial cable (not supplied) to connect the FM 75 Ω coaxial cable (hidden inside the back cover) directly to the outdoor FM antenna terminal.

- 1 Open the DVD system's back cover by releasing the two catches located at the base of the system.
- 2 Unplug the FM pigtail antenna from the FM 75 Ω coaxial cable.
- 3 Connect the FM 75 Ω coaxial cable to one end of the FM coaxial cable which is connected to the outdoor FM antenna terminal.

Helpful Hint:

– Position the antennas as far away as possible from your TV, VCR or other radiation source to prevent any unwanted interference.

Getting Started

Step 1: Switching on the DVD system

- Press the **SOURCE** button on the DVD system repeatedly to select :
DISC → TUNER FM → TV → AUX
→ DI → DISC

Switching to standby mode

- Press **STANDBY**  on the remote control.
→ The message "Standby" will be shown on the display screen, and slowly fade away.

Step 2: Finding the correct viewing channel

Before you start...

Make sure you have completed all the necessary connections before proceeding.

- 1 Press the **SOURCE** button on the remote control repeatedly until "DISC" appears on the display panel.
- 2 Switch on the TV and set it to the correct video-in channel. You should see the blue DVD background screen on the TV.
→ Or, you may go to Channel 1 on your TV, then press the Channel down button repeatedly until you see the Video In channel.
→ Usually this channel is between the lowest and highest channels and may be called FRONT, A/V IN, VIDEO. See your TV manual for more details.
→ Or, the TV remote control may have a button or switch that chooses between different video modes.

TIPS: Press  to return to the previous menu item.
Press **SYSTEM MENU** to exit the menu.

Getting Started (continued)

Step 3: Setting language preferences

The language options are different depending on your country or region. It may not correspond to the illustrations shown on the user manual.

On-screen display (OSD) language

The OSD (On-Screen Display) language for this DVD system will remain as you have set it, regardless of the changes made to the DVD disc language.

- 1 In 'DISC' mode, press **SYSTEM MENU**.
- 2 Press **▶** to select { **General Setup Page** }.
- 3 Use **▲▼** keys to highlight { **OSD Language** }, then press **▶**.

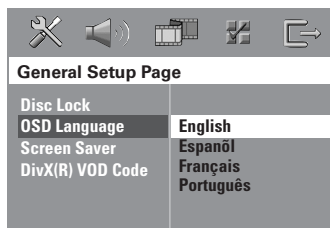

- 4 Use **▲▼** keys to select a language and press **OK** to confirm.

Audio, Subtitle and Menu language for DVD playback

You can select your preferred language settings for DVD playback. If the selected language is recorded on the DVD disc, the DVD system will automatically play the disc in that language. Otherwise, the disc's default language will be used instead.

- 1 Press **■** twice to stop playback (if any), then press **SYSTEM MENU**.
- 2 Press **▶** repeatedly to select { **Preference Page** }.
- 3 Use **▲▼** keys to highlight one of the options below, then press **▶**.

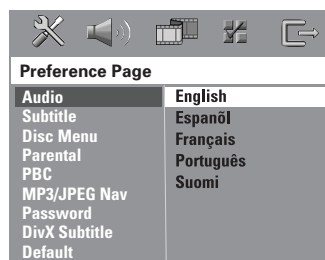

{ Audio }

Select the preferred audio language for DVD playback.

{ Subtitle }

Select the preferred subtitle language for DVD playback.

{ Disc Menu }

Select the preferred disc menu language for DVD playback.

TIPS: Press **◀** to return to the previous menu item.
Press **SYSTEM MENU** to exit the menu.

Getting Started (continued)

- 4 Use ▲▼ keys to select a language and press **OK** to confirm.

If the language you want is not in the list, then select { Others }.

Use the **numeric keypad (0-9)** on the remote to enter the 4-digit language code 'XXXX' (see page 256) and press **OK** to confirm.

- 5 Repeat steps 3 ~ 4 for other settings.

Helpful Hints:

– During DVD playback, you can switch the audio and subtitle languages by pressing the **AUDIO** and **SUBTITLE** buttons on the remote control. However, this does not change the default settings you have made here.

– For some DVDs, the subtitle/audio/menu language can only be changed via the DVD disc menu.

Step 4: Setting the TV

Selecting the matching colour system

The colour system of the DVD system, DVD and TV should match. Only then will it be possible to play a DVD on this system. Before changing the TV system, determine the colour system of your TV.

- 1 In 'DISC' mode, press **SYSTEM MENU** on the remote control.
- 2 Press ► repeatedly to select { **Video Setup Page** }.
- 3 Press ▼ to highlight { **TV Type** }, then press ►.

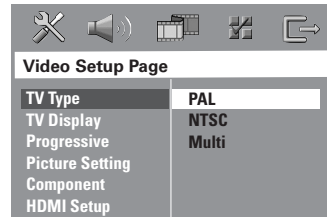

{ PAL }

Select this if the connected TV has the PAL colour system. It will change the video signal of an NTSC disc and output it to PAL format.

{ NTSC }

Select this if the connected TV has the NTSC colour system. It will change the video signal of a PAL disc and output it to NTSC format.

{ Multi }

Select this if the connected TV is compatible with both NTSC and PAL (multi-system). The output format will be in accordance with the video signal of the disc.

- 4 Select one of the options and press **OK** to confirm.
 - Follow the instructions shown on the TV to confirm the selection (if any).
 - If a blank/distorted TV screen appears, wait for 15 seconds for the auto recovery.

TIPS: Press ◀ to return to the previous menu item.
Press **SYSTEM MENU** to exit the menu.

Getting Started (continued)

Setting the TV Display

Set the aspect ratio of the DVD system according to the TV type you have connected. The format you select must be available on the disc. If it is not, the setting for TV display will not affect the picture during playback.

- 1 In 'DISC' mode, press **SYSTEM MENU** on the remote control.
- 2 Press **▶** repeatedly to select { **Video Setup Page** }.
- 3 Press **▼** to highlight { **TV Display** }, then press **▶**.

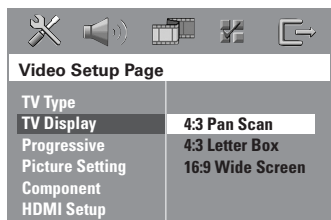

{ 4:3 Pan Scan }

Select this if you have a conventional TV and want both sides of the picture to be trimmed or formatted to fit your TV screen.



{ 4:3 Letter Box }

Select this if you have a conventional TV. In this case, a wide picture with black bands on the upper and lower portions of the TV screen will be displayed.



{ 16:9 Wide Screen }

Select this if you have a wide-screen TV.



- 4 Select one of the options and press **OK** to confirm.

Setting up Progressive Scan feature (for Progressive Scan TV only)

The progressive scan feature displays twice the number of frames per second than interlaced scanning (ordinary normal TV system). With nearly twice the number of lines, progressive scan offers a higher picture quality and resolution.

IMPORTANT!

Before enabling the progressive scan feature, you must ensure:

- 1) Your TV can accept progressive signals, a progressive scan TV is required.
- 2) You have connected the Junction Box to your TV using Y Pb Pr (see page 19).

- 1 Switch off your TV progressive scan mode or switch on to the interlaced mode (refer to your TV user manual).
- 2 Press the **SOURCE** button until "DISC" appears on the display panel.
- 3 Switch on your TV and select the correct Video Input channel.
→ The blue DVD background screen will appear on the TV.
- 4 Press **SYSTEM MENU** on the remote.
- 5 Press **▶** to select { **Video Setup Page** }.
- 6 Select { **Component** } > { **YUV** }, then press **OK** to confirm.

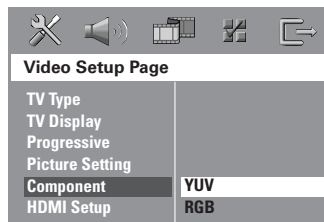

TIPS: Press **◀** to return to the previous menu item. Press **SYSTEM MENU** to exit the menu.

Getting Started (continued)

- 7 Select { **Progressive** } > { **On** }, then press **OK** to confirm.

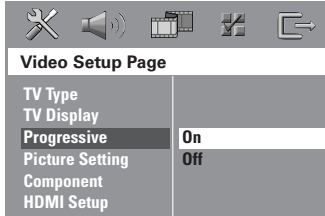

- 8 The menu below will appear on the TV.

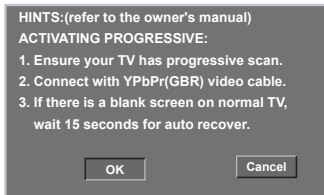

- 9 Press **◀** to highlight **OK** in the menu and press **OK** to confirm.

There will be no picture on your TV at this state until you switch on the progressive scan mode on your TV.

- 10 Switch on your TV's progressive scan mode (refer to your TV user manual).
→ The below menu will appear on the TV.

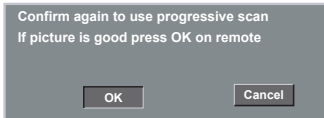

- 11 Press **◀** to highlight **OK** in the menu and press **OK** to confirm.
→ The setup is complete now and you can start to enjoy the high quality picture.

If no picture is displayed :

- Wait for 15 seconds for the auto recovery.
OR

- 1 Deactivate the Progressive Scan feature by pressing the **▲** (EJECT) on the front panel.

- 2 Press **▶** on the remote control.

- 3 Press **SUBTITLE** on the remote control.

→ The blue DVD background screen will appear on the TV.

Helpful Hint:

– There are some progressive scan TV and High-Definition TV sets that are not fully compatible with this DVD system, resulting in the unnatural picture when playing back a DVD VIDEO disc under the progressive scan mode. In such a case, switch off the progressive scan feature on both the DVD system and your TV set.

TIPS: Press **◀** to return to the previous menu item.
Press **SYSTEM MENU** to exit the menu.

Getting Started (continued)

Step 5: Setting the speakers' channels

You can adjust the delay times (centre and surround only) and volume level for individual speakers. These adjustments allow you to optimise the sound according to your surroundings and setup.

Before you start...

- Press the **SURR.** button on the remote to select multichannel surround mode before adjusting the speaker settings.
- In case of sound distortion, press and hold the **SOUND** button to select another transmission channel for the wireless rear speakers.

- 1 Press **■** to stop playback, then press **SYSTEM MENU**.
- 2 Press **▶** repeatedly to select { **Audio Setup Page** }.
- 3 Press **▲▼** to highlight { **Speaker Setup Page** }, then press **▶**.

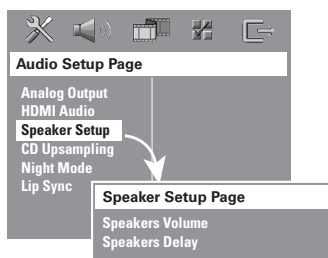

- 4 Enter its submenu by pressing **▶**.
- 5 Press **▲▼** to highlight one of the options below at a time, then press **▶**.

{ Speakers Volume }

- Volume level setting for individual speakers (-6dB – +6dB).

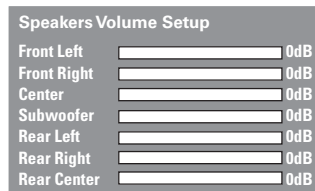

{ Speakers Delay }

- Delay times setting in relation to the listening position/ distance for centre and surround speakers.

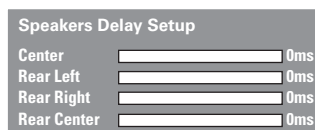

Note: 1 ms increase/decrease of delay time is equivalent to 30 cm change in distance. Use the longer delay time settings when the rear speakers are closer to the listener than the front speakers.

- 6 Press **◀▶** to adjust to the setting that best suit your surround sound needs.
- 7 Press **OK** to confirm.

Helpful Hints:

- Use the longer delay time settings when the rear speakers are closer to the listener than the front speakers.
- The test tone will automatically be generated to help you judge the sound level of each speaker.

TIPS: Press **◀** to return to the previous menu item.
Press **SYSTEM MENU** to exit the menu.

Disc operations

Playable discs



Your DVD home theatre system will play:

- Digital Versatile Discs (DVDs)
- Video CDs (VCDs)
- Super Video CDs (SVCDs)
- Super Audio CDs (SACDs)
- Finalised DVD Recordable (DVD±R), DVD Rewritable (DVD±RW)
- Audio Compact Discs (CDs) on CD-R(W).
- MP3/ Windows Media™ Audio discs, picture (Kodak, JPEG) files on CD-R(W).
 - JPEG/ISO 9660/UDF format
 - JPEG resolution support up to 3072 x 2048
 - Supported sampling frequencies : 32 kHz, 44.1 kHz, 48 kHz
 - Supported Bit-rates : 32~256 (kbps), variable bit rates
- MPEG-4 files on CD-R(W):
 - Simple profile
 - Advanced simple profile (640-480)
- DivX files on CD-R(W)/DVD+R(W):
 - DivX 3.11, 4.x, 5.x and 6.x
 - Supports QPEL (Quarter Pixel).
- XviD files on CD-R(W)/DVD+R(W)

Region Codes for DVD discs

DVD discs and players are designed with regional restrictions. Before playing a disc, make sure the disc is for the same region as your player. The regional code for this DVD system is indicated at the rear panel.

IMPORTANT!

- If the inhibit icon (Ø or X) appears on the TV screen when a button is pressed, it means the function is not available on the current disc or at the current time.
- Do not put any objects other than discs on the disc tray. Doing so may cause the disc player to malfunction.

Helpful Hints:

- It may not be possible to play a CD-R/RW or DVD-R/-RW disc in all cases due to the type of disc or condition of the recording.
- If you are having trouble playing a certain disc, remove the disc and try a different one. Improperly formatted discs will not play on this DVD system.

TIPS: The operating features described here might not be possible for certain discs. Always refer to the instructions supplied with the discs.

Disc operations (continued)

Playing a disc

- 1 Press the **SOURCE** button until "DISC" appears on the display panel.
- 2 Switch on the TV and set to the correct Video In channel. (See the section "Finding the correct viewing channel").
→ You should see the blue DVD background screen on the TV.
- 3 Insert a disc into the disc slot.
→ Make sure the disc label is facing out.
For double-sided discs, load the side you want to play facing out.
→ When loading an 8cm disc, slot into the middle of the disc loader.

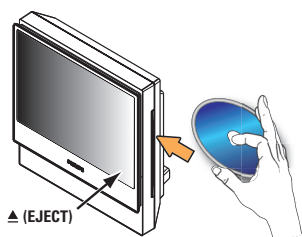

- 4 Playback will start automatically.
→ If a disc menu appears on the TV, see page 30 "Using the Disc Menu".
→ If the disc is locked by parental control, you must enter your six-digit password. (See page 44).
- 5 To remove the disc, press ▲ (EJECT) or press and hold the ■ button on the remote control.

Basic playback controls

Pausing playback

- During playback, press ►|| (PLAY PAUSE) or || on the remote control.
→ To resume playback, press ►|| again (or PLAY ► on the remote control).

Selecting another track/chapter

- Press ◀◀ / ▶▶ (PREV / NEXT) or use the **numeric keypad (0-9)** to key in a track/chapter number.
→ If the repeat track mode is active, press ◀◀ again to replay the same track/chapter.

Searching backwards/forwards

- Press and hold ◀◀ / ▶▶ (PREV / NEXT).
→ While searching, press ◀◀ / ▶▶ repeatedly to decrease/increase the search speed.
→ To resume normal playback, press ►|| (or PLAY ► on the remote control).

Stopping playback

- Press ■ (STOP).

TIPS: The operating features described here might not be possible for certain discs. Always refer to the instructions supplied with the discs.

Disc operations (continued)

Selecting various repeat/shuffle functions

- While playing a disc, press **REPEAT** on the remote control repeatedly to choose a repeat play mode.

DVD

- RPT ONE (repeat chapter)
- RPT TT (repeat title)
- SHUFFLE (random play)
- RPT SHF (repeat random play)
- RPT OFF (exit repeat mode)

VCD/SVCD/CD

- RPT ONE (repeat track)
- RPT ALL (repeat disc)
- SHUFFLE (random play)
- RPT SHF (repeat random play)
- RPT OFF (exit repeat mode)

MP3/SACD/DivX/Windows Media™

Audio

- RPT ONE (repeat track)
- RPT ALL/FLD (repeat folder)
- SHUFFLE (random play)
- RPT OFF (exit repeat mode)

Helpful Hint:

- Repeat playback is not possible on VCDs when the PBC mode is switched on.

Other playback features for video discs (DVD/VCD/SVCD)

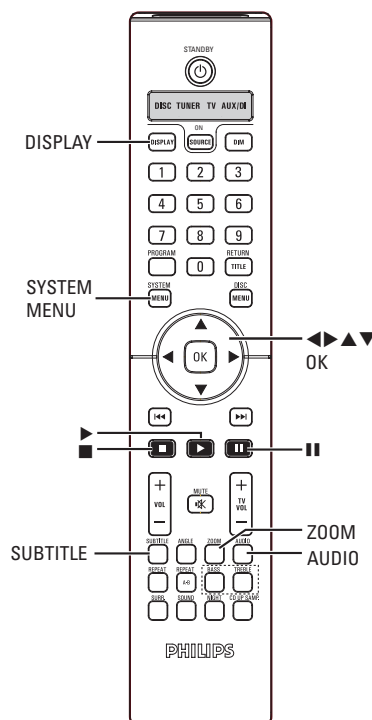

Using the Disc Menu

Depending on the disc format, a menu may appear on the TV screen once you load in the disc.

To select a playback feature or item

- Use **◀▶▲▼** keys or **numeric keypad (0-9)** on the remote, then press **OK** to start playback.

To access or remove the menu

- Press **DISC MENU** on the remote control.

TIPS: The operating features described here might not be possible for certain discs. Always refer to the instructions supplied with the discs.

Disc operations (continued)

Viewing playback information

The DVD system can display the disc playback information (for example, title or chapter number, elapsed playing time, audio/subtitle language) and a number of operations can be done without interrupting disc playback.

- 1 During playback, press **DISPLAY**.
→ A list of available disc information appears on the TV screen.

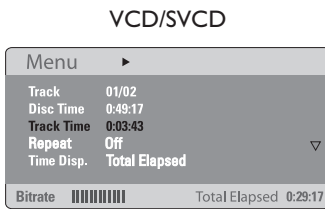

- 2 Use **▲▼** keys to view the information and press **OK** to access.
- 3 Use the **numeric keypad (0-9)** to input the number/time or use **▲▼** keys to make the selection, then press **OK** to confirm.
→ Playback will change according to the chosen time or to the selected title/chapter/track.

Resuming playback from the last stopped point

This DVD system is able to resume disc playback from its last stopped point (only possible for the last 10 discs that were recorded without a menu).

- 1 Load one of the last 10 discs played.
- 2 While "LOADING" appears on the display panel, press **PLAY ▶** (or **▶||** on the display panel) to start playback from the last stop point.

To cancel the resume mode

- 3 In stop mode, press **■ (STOP)** again.

Zooming in

This function allows you to enlarge the picture on the TV screen and to pan through the enlarged picture.

- 1 During playback, press **ZOOM** on the remote control repeatedly to select a different zoom factor.
→ Use **◀▶▲▼** keys to move through the zoomed image.
→ Playback will continue.
- 2 Press **ZOOM** repeatedly to return to the original size.

TIPS: The operating features described here might not be possible for certain discs. Always refer to the instructions supplied with the discs.

Disc operations (continued)

Changing subtitle language (DVD only)

This operation works only on DVDs with multiple subtitle languages, you can change the language you want while playing a DVD.

- Press **SUBTITLE** repeatedly to select different subtitle languages.

Changing sound track language

This operation works only on DVDs with multiple soundtrack languages, you can change the language you want while playing a DVD.

- Press **AUDIO** repeatedly to select the available audio languages.

For VCD – changing the audio channel

- Press **AUDIO** repeatedly to select the available audio channels provided by the disc (STEREO, MONO LEFT, MONO RIGHT or MIX MONO).

Switching camera angles

This option is only available with DVDs that contain sequences recorded from different camera angles. This allows you to view the picture from different angles.

- Press **ANGLE** repeatedly to select the available camera angles.

Playback Control (VCD only)

PBC playback allows you to play Video CDs interactively, following the menu on the display. This function can also be accessed via the 'Preference Page' menu (see page 44).

For VCDs with Playback Control (PBC) feature (version 2.0 only)

- When playback is stopped, press **DISC MENU** to toggle between 'PBC ON' and 'PBC OFF'.
 - If you select 'PBC ON', the disc menu (if available) will appear on the TV. Use **▲▼** keys or **numeric keypad (0-9)** to select a play option and press **OK** to confirm.
 - If you select 'PBC OFF', the VCD will skip the index menu and playback directly from the beginning.

TIPS: The operating features described here might not be possible for certain discs. Always refer to the instructions supplied with the discs.

Disc operations (continued)

Playing an MP3/ JPEG/ MPEG-4/Windows Media™ Audio disc

This DVD system can playback most of the MP3, JPEG, MPEG-4 and Windows Media™ Audio files recorded on a CD-R/RW disc or commercial CD.

Before you start...

You have to switch on your TV and set to the correct Video In channel. (See the section "Finding the correct viewing channel").

- 1 Insert a disc.
 - The disc reading time may exceed 30 seconds due to the complexity of the directory/file configuration.
 - The disc menu appears on the TV screen.

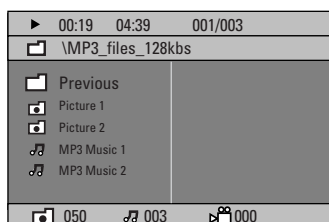

- 2 If the disc main menu contains various folders, use ▲▼ keys to select a desired folder and press **OK** to open the folder.
- 3 Use ▲▼ keys to select a track/file and press **OK** to start playback.
 - Playback will start from the selected file and continue till the end of the folder.

During playback, you can;

- Press ◀◀/▶▶ to select another track/file in the current folder.
- Press and hold ◀◀/▶▶ to fast reverse/forward search for a music track.
- To select another folder from the current disc, press ▲ to return to the root menu, then use ▲▼ keys to make your selection and press **OK** to confirm.
- Press **REPEAT** repeatedly to access various play modes.
- 4 To pause playback, press || on the remote control. To resume playback, press the PLAY ▶ button.
- 5 To stop playback, press ■.

TIPS: The operating features described here might not be possible for certain discs. Always refer to the instructions supplied with the discs.

Disc operations (continued)

Playing a JPEG image file (slide show)

Before you start...

You have to switch on your TV to the correct Video In channel. See the section on “Finding the correct viewing channel”.

- Insert a Picture disc (Kodak Picture CD, JPEG).
 - For a Kodak disc, the slide show will begin automatically.
 - For a JPEG disc, the picture menu will appear on the TV. Press **PLAY** **▶** (or **▶||**) to start the slide-show playback.

Preview function

- 1 During playback, press **■**.
 - 12 thumbnail pictures will be displayed on the TV.



- 2 Press **◀◀/ ▶▶** to display the other pictures on the previous/next page.
- 3 Use **◀▶▲▼** keys to highlight one of the picture and press **OK** to start playback.
- 4 Press **DISC MENU** to return to the Picture CD menu.

Zoom picture

- 1 During playback, press **ZOOM** repeatedly to select a different zoom factor.
- 2 Use **◀▶▲▼** keys to pan through the zoomed image.

Rotating/flipping the picture

- During playback, use **◀▶▲▼** keys to rotate/flip the picture on the TV.
 - ▲ : flip the picture vertically
 - ▼ : flip the picture horizontally
 - ◀ : rotate the picture anti-clockwise
 - ▶ : rotate the picture clockwise

Supported file format:

- The file extension has to be ‘*.JPG’ and not ‘*.JPEG’.
- It can only display DCF-standard still pictures or JPEG pictures e.g. TIFF. It cannot playback moving pictures, Motion JPEG, progressive JPEG and other formats, or pictures in formats other than JPEG, or pictures associated with sound.
- It may require longer time for the DVD system to display the disc content on the TV due to the large number of songs/pictures compiled into one disc.

TIPS: Some discs cannot be played on this player due to the configuration and characteristics of the disc, or due to the condition of recording and authoring software that was used.

Disc operations (continued)

Playing MP3 music and JPEG picture simultaneously

- 1 Insert an MP3 disc that contains music and pictures.
- 2 Select an MP3 track in the menu and press **PLAY ▶** (or **▶||**) to start playback.
- 3 During MP3 music playback, use **◀▶▲▼** keys to select a picture folder from the disc menu and press **PLAY ▶** (or **▶||**).
→ The picture files will be played back until the end of the folder.
- 4 To quit simultaneous playback, press **DISC MENU** and followed by **■**.

Helpful Hints:

- It is normal to experience an occasional “skip” while listening to your MP3 disc.
- It is normal to experience an occasional pixelation during MPEG-4/DivX playback due to poor clarity of digital contents during internet downloading.
- Only the first session of a multi-session CD will be played back.

Playing a Super Audio CD (SACD)

There are three types of SACD discs : single layer, double layer or hybrid discs. The hybrid disc contains both Super Audio CD and standard audio CD layers, only the SACD layer can be played back on this DVD system.

- 1 Insert a SACD.
→ The disc menu appears on the TV screen.
- 2 Playback will start automatically.
→ If the SACD consists of multi-channel and stereo tracks, multi-channel tracks will have the priority for playback.
→ To playback stereo tracks, use **▲▼** keys to make your selection from the disc menu, then press **PLAY ▶**.

Helpful Hint

- It is not possible to programme SACD tracks.

TIPS: Some discs cannot be played on this player due to the configuration and characteristics of the disc, or due to the condition of recording and authoring software that was used.

Disc operations (continued)

Playing a DivX disc

This DVD system supports the playback of DivX movies which you can copy from your computer onto a CD-R/RW, DVD±R/±RW disc.

- ① Insert a DivX disc.
- ② If the DivX movie contains external subtitles, the subtitle menu will appear on the TV for your selection.
 - In this case, pressing **SUBTITLE** on the remote will switch on or off the subtitle display.
- ③ To start playback, press **PLAY** ► on the remote control.
 - If multilingual subtitles are embedded on the DivX disc, you can press **SUBTITLE** to change the subtitle language during playback.

Helpful Hints:

- Subtitle files with the following filename extensions (.srt, .smi, .sub, .ssa, .ass) are supported but do not appear on the file navigation menu.
- The subtitle filename has to be the same as the filename of the movie.
- The subtitle can only be displayed up to a maximum of 35 characters.

TIPS: Some discs cannot be played on this player due to the configuration and characteristics of the disc, or due to the condition of recording and authoring software that was used.

DVD System Menu Options

Accessing the DVD setup menu

This DVD system setup is carried out via the TV, enabling you to customise the DVD system to suit your particular requirements.

- 1 In 'DISC' mode, press **SYSTEM MENU**.
→ The system setup menu appears.

- 2 Press ◀▶ to select one of the setup menu pages and press **OK**.



- If you are not able to access the { **Preference Page** }, press **SYSTEM MENU** to exit the menu. Press ■ (STOP) twice before you press the **SYSTEM MENU** button again.

- 3 Use ▲▼ keys to select a setup option and press ▶ to access

- 4 Select the setting you wish to change and press **OK** to confirm and go back to the previous selected item.

→ Instructions and explanations of the options are provided in the following pages.

→ If the option in the menu is greyed out, that means the setting is not available or cannot be changed in the current state.

- 5 To exit, press **SYSTEM MENU**.

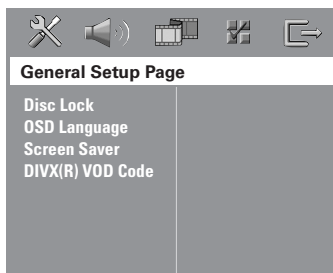

see page 38

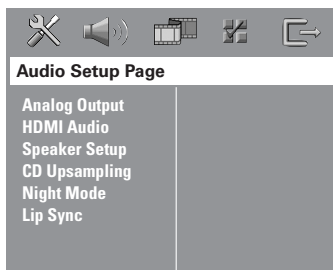

see page 39

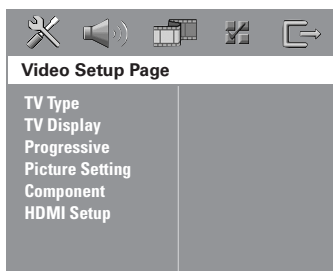

see page 40

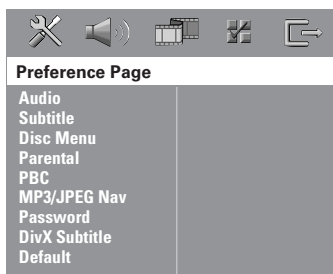

see page 43

DVD System Menu Options (continued)

General Setup Page (underlined options are the factory default settings)

Disc Lock

Not all discs are rated or coded by the disc maker. You can prevent a specific disc from playing back by locking the disc. Up to 40 discs can be locked.

- { **Lock** } – Select this to block the playback of the current disc. Subsequent access to a locked disc requires six-digit password. The default password is '136900' (see "Preference Setup Page Settings – Password").
- { **Unlock** } – All discs can be played back.

OSD language

Select the preferred language for the DVD system on-screen display menu.

Screen Saver

The screen saver will help prevent damage to your TV display device.

- { **On** } – Turns off the TV screen when playback has been stopped or paused for more than 15 minutes.
- { **Off** } – Disables the screen saver function.

DIVX(R) VOD code

Philips provides you with the DivX® VOD (Video On Demand) registration code that allows you to rent and purchase videos using the DivX® VOD service. Press ► to see the registration code and press **OK** to exit.

Use the registration code to purchase or rent the videos from DivX® VOD service at www.divx.com/vod. Follow the instructions and copy the video from your computer onto a CD-R/RW disc for playback on this DVD system.

Note: All the downloaded videos from DivX® VOD can only be played back on this DVD system. For more information, visit us at www.divx.com/vod.

DVD System Menu Options (continued)

Audio Setup Page (underlined options are the factory default settings)

Analog Output

This feature enables you to set the analogue output to match your DVD system's playback capability.

{ **Stereo** } – Select this to change the channel output to stereo that delivers sound from only the front speakers and subwoofer.

{ **Multi-channel** } – Select this to enable surround sound output from all speakers (except REAR CENTER) and the subwoofer.

{ **6.1 Multi-channel** } – Select this to enable surround sound output from all speakers and the subwoofer.

HDMI Audio

For HDMI connections, you are able to select the HDMI audio output selections. The available options will be displayed once you have connected the HDMI device. (see page 19).

It may take a while for the DVD system and the input device to communicate and initialise.

{ **Off** } – Select this to switch off HDMI audio output.

{ **All** } – Select this if you have connected the DVD system to a multichannel decoder/receiver.

{ **PCM Only** } – Select this only if your HDMI TV or receiver is not capable of decoding multichannel audio.

Speaker Setup

This feature allows you to to optimise the sound according to your surroundings and setup.

{ **Speakers Volume** } – Access the speakers level setup menu.
See “Step 5: Setting the speakers’ channels”

{ **Speakers Delay** } – Access the speakers distance setup menu.
See “Step 5: Setting the speakers’ channels”

CD Upsampling

This feature enables you to convert your music CD to a higher sampling rate using sophisticated digital signal processing for better sound quality. If you have activated the CD upsampling feature, the system will automatically switch to stereo mode.

Note: If you press **SURR.** button on the remote control to select multichannel mode, it will disable the CD upsampling feature.

DVD System Menu Options (continued)

Audio Setup Page (underlined options are the factory default settings)

Night Mode

This mode optimises playback of sound at low volume. High volume outputs will be softened and low volume outputs are brought upward to an audible level. This feature is only applicable for DVD video discs with Dolby Digital mode.

- { **On** } – Turns on night mode.
- { **Off** } – Turns off night mode feature. Select this to enjoy the surround sound with its full dynamic range.

Lip Sync

This feature allows you to adjust the audio delay times if video playback is slower than the audio output streams, hence resulting in lip-sync.

Access the lip sync setup menu. Use ◀ ▶ keys to set the delay times for the audio output.

Video Setup Page (underlined options are the factory default settings)

TV Type

Select the colour system that matches the connected TV. It will enable playback of different type of disc (PAL or NTSC disc) on this DVD system. This option is not available if a HDMI TV is connected.

- { **PAL** } – For PAL-system TV.
- { **NTSC** } – For NTSC-system TV.
- { **Multi** } – For TV that is compatible with both PAL and NTSC.

TV Display

The picture shape can be adjusted to fit your TV.

- { **4:3 Pan Scan** } – For a full-height picture with the sides trimmed.
- { **4:3 Letter Box** } – For a 'wide-screen' display with black bars on the top and bottom.
- { **16:9 Wide Screen** } – For wide-screen TV (frame ratio 16:9).



DVD System Menu Options (continued)

Video Setup Page (underlined options are the factory default settings)

Progressive

In the progressive scan mode, you can enjoy high quality picture with less flickers. It only works when you have connected the Y Pb Pr sockets on the Junction Box to your TV that supports progressive video input. Otherwise, the image may not appear or will be distorted.

This option is only available if you have selected { YUV } in the { Component } option. See next page "Video Setup Page – Component" for details.

- { **Off** } – Disable the progressive scan function.
- { **On** } – Enable the progressive scan function.

Note: If no picture appears, wait for 15 seconds for auto recovery. Otherwise, turn off the progressive scan as below:

- 1) Press **▲** EJECT on the DVD system.
- 2) Press **▶** on the remote control.
- 3) Press **SUBTITLE** on the remote control.

Picture Setting

This DVD system provides three predefined sets of picture colour settings and one personal setting which you can define yourself.

- { **Standard** } – Original colour setting.
- { **Bright** } – Vibrant colour setting.
- { **Soft** } – Warm colour setting.
- { **Personal** } – Select this to personalise your picture colour by adjusting the brightness, contrast, tint and colour (saturation).
Use **◀▶** keys to adjust to the setting that best suit your personal preference and press **OK** to confirm. For an average setting, select { **0** }.

Personal Picture Setup	
Brightness	0
Contrast	0
Tint	0
Color	0

- { **Brightness** }
Increase this value to brighten the picture colour or vice versa.
- { **Contrast** }
Increase this value to sharpen the picture colour or vice versa.
- { **Tint** }
Increase or decrease this value to change the colour phase of the picture.
- { **Color** }
Increase this value to enhance the picture colour or vice versa.

DVD System Menu Options (continued)

Video Setup Page (underlined options are the factory default settings)

Component

Select the type of video output that matches the video connection between the DVD system and your TV.

- { YUV } – Select this if you have connected the Junction Box to your TV using the component video sockets (Y Pb Pr).
- { RGB } – Select this if you have connected the Junction Box to your TV using the SCART socket.

HDMI Setup

It provides the picture settings to enhance the appearance and picture quality for disc playback.

{ Wide Screen Format } – Select a suitable screen display.

This feature is only available if you have selected { TV Display – 16:9 Wide Screen }.

{ Superwide }

Select this to display the 4:3 picture disc on the wide-screen TV with non-linear stretching (centre position of the screen is stretched less than the side).

{ 4:3 Pillar Box }

Select this to display the 4:3 picture disc on the wide-screen TV without stretching. Black bars will be shown on both sides of the TV screen.

{ Off }

No aspect ratio adjustment is made when this option is selected.

Note: The { Wide Screen Format } feature will be disabled if your HDMI TV has been preset to { 480p } or { 576p } settings .

{ HDMI Video } – Select this to further enhance your HDMI video output.

{ 480p }

Progressive output in 480 lines for NTSC TV. Selecting this will disable the { **Wide Screen Format** } feature.

{ 576p }

Progressive output in 576 lines for PAL TV. Selecting this will disable the { **Wide Screen Format** } feature.

{ 720p } - (if a HDMI TV is connected)

Progressive output upscale to 720 lines.

{ 1080i } - (if a HDMI TV is connected)

Interlaced output upscale to 1080 lines.

DVD System Menu Options (continued)

Video Setup Page (underlined options are the factory default settings)

HDMI Setup

(continued)

{ HDMI Video }– Select this to further enhance your HDMI video output. (continued).

{ Auto }

The video output will automatically follow the display's supported resolution.

Preference Setup Page (underlined options are the factory default settings)

Audio

Select the preferred audio language for DVD playback.

Subtitle

Select the preferred subtitle language for DVD playback.

Disc Menu

Select the preferred disc menu language for DVD playback.

Note: If the selected audio/subtitle/disc menu language is not available on the DVD, the disc's default language will be used instead.

Parental

This is to prohibit viewing of discs that had exceeded the limits you set. It works only on the DVDs with parental level assigned to the complete disc or to certain scenes on the disc.

- 1 Kid Safe
- 2 G
- 3 PG
- 4 PG 13
- 5 PGR
- 6 R
- 7 NC 17
- 8 Adult

1) Use **▲ ▼** keys to select a rating level from 1 to 8 and press **OK**.

The ratings are country-dependent ('1' is considered material that is least offensive and '8' is most offensive). To disable parental controls and allow all discs to play, select '8'.

2) Use the **numeric keypad 0-9** on the remote control to enter your six-digit password.

DVDs that are rated higher than the level you selected will not be played unless you enter the same six-digit password.

Note: Some DVDs are not encoded with a rating though the movie rating may be printed on the disc cover. The rating level feature does not prohibit playback of such discs. VCD, SVCD and CD have no level indication, so parental control has no effect on these type of discs.

DVD System Menu Options (continued)

Preference Setup Page (underlined options are the factory default settings)

PBC Play Back Control feature is only applicable for VCD/SVCD only. It allows you to play Video CDs (2.0) interactively, following the menu on the display.

{ **Off** } – The VCD/SVCD will skip the index menu and playback directly from the beginning.

{ **On** } – The index menu (if available) will appear on the TV once you load a VCD/SVCD.

MP3/JPEG Nav MP3/JPEG Navigator can only be set if the disc is recorded with a menu. It allows you to select different display menus for easy navigation.

{ **Without Menu** } – Displays all the files contained in the MP3/Picture disc.

{ **With Menu** } – Displays the folder menu of the MP3/Picture disc.

Password The same password is used for both Parental Control and Disc Lock. Enter your six-digit password to play a prohibited disc or when prompted for a password. The default password is '136900'. To change the password:

The screenshot shows a 'Change Password' menu with four input fields: 'Old Password', 'New Password', and 'Confirm PWD', each with a small cursor icon. Below these fields is an 'OK' button.

- 1) Press **OK** to access the change password menu.
- 2) Use the **numeric keypad 0-9** on the remote control to enter your existing six-digit password at { Old Password }. When doing this for the first time or if you forget your existing password, key in '136900'.
- 3) Enter the new six-digit password at { New Password }.
- 4) Enter the new six-digit password again at { Confirm PWD }.
- 5) Press **OK** to confirm and exit the menu.

DIVX Subtitle Select the font type that supports the recorded DivX subtitle.

{ **Standard** } – Displays a standard list of Roman subtitle fonts provided by this DVD system.

{ **Others** } – Displays other subtitle fonts.

Default This feature enables you to reset all the setup menu options and your personal settings to the factory defaults, except your password for Parental Control and Disc Lock. Press **OK** to confirm the default reset.

Tuner Operations

Tuning to radio stations

- 1 Press **SOURCE** button until “TUNER FM” appears on the display panel.
- 2 Press ▲ / ▼ briefly on the remote.
→ The display panel will show “SEARCH” until a radio station with sufficient signal strength is found.
- 3 Repeat step 2 if necessary until you find the desired radio station.
- 4 To fine-tune the reception of a weak station, press ◀◀ / ▶▶ briefly and repeatedly until an optimal reception is found.

Helpful Hint:

- If the FM radio station is transmitting RDS (Radio Data System) data, the RDS name will be displayed and stored.

Presetting radio stations

You can store up to 40 FM preset radio stations in the system’s memory. There are three different ways to programme the radio stations:

- Using auto install (for first time setup only)
- Using automatic preset
- Using manual preset

Helpful Hints:

- The system will exit presetting mode if no button is pressed within 20 seconds.
- If no valid frequency is detected during tuner installation, “PLEASE CHECK FM ANTENNA” appears.

Using auto install

This feature is only applicable for the first time radio station programming. You will be prompted for installing the radio stations once you access the tuner mode. With one touch of the button, all the available radio stations will be stored automatically.

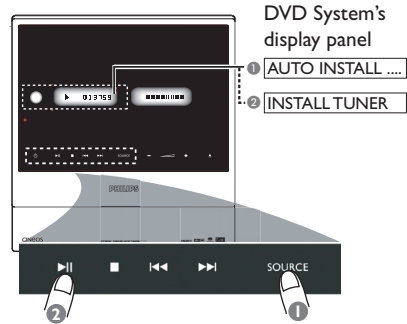

- 1 Press **SOURCE** on the system panel to select TUNER mode.
→ “AUTO INSTALL PRESS PLAY” appears.
- 2 Press and hold ►|| (PLAY PAUSE) on the system panel until “INSTALL TUNER” appears on the display panel.
→ All the available radio stations with strong signal strength will be stored automatically.
→ Once complete, the last tuned radio station will be played back.

Tuner Operations (continued)

Using automatic preset

Use automatic presetting to store or reinstall all the preset radio stations.

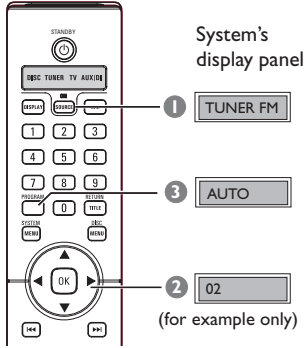

- 1 Press **SOURCE** button until “TUNER FM” appears on the display panel.
- 2 Press ◀▶ or use the **numeric keypad (0-9)** to select a preset number to begin.
- 3 Press and hold **PROGRAM** until “AUTO” appears.
 - If a radio station is stored in one of the earlier presets, the same radio station will not store under another preset number.
 - If no preset number is selected, automatic preset will begin from preset (1) and all your former presets will be overridden.

Using manual preset

Use manual presetting to store only your favourite radio stations.

- 1 Tune to your desired radio station (see “Tuner Operations – Tuning to radio stations”).
- 2 Press **PROGRAM**.
- 3 Use ◀▶ keys to select a preset number that you want to store the current radio station under.
- 4 Press **PROGRAM** again to store.

Selecting a preset radio station

- Use ◀▶ keys to select a preset number (or use the numeric keypad on the remote).
 - The preset number followed by the radio frequency will appear.

Deleting a preset radio station

- 1 In tuner mode, use ◀▶ keys on the remote to select a preset radio station.
- 2 Press and hold ■ until “PRESET DELETED” appears.
 - The radio station continues to play but has been deleted from the preset list.

Sound and Volume Controls

Selecting surround sound

- Press **SURR.** (SURROUND) to select : MULTI-CHANNEL or STEREO.
 - The availability of the various surround sound modes depends on the sound available on the disc.
 - The available output modes for Multichannel include: Dolby Digital, Dolby Digital EX, DTS (Digital Theatre Systems) Surround and Dolby Pro Logic II.
 - Stereo broadcasts or recordings will produce some surround channel effects when played in a surround mode. However, mono (single channel sound) sources will not produce any sound from the surround speakers.

Helpful Hint:

– You are not able to select the surround sound mode if the system setup menu is turned on.

Adjusting the Bass/ Treble level

The BASS (low tone) and TREBLE (high tone) features enable you to define the sound processor settings.

- 1 Press **BASS** or **TREBLE** on the remote.
- 2 Within five seconds, use the **VOL** + – to adjust the Bass or Treble level (MIN, – 2, – 1, 0, + 1, + 2 or MAX).
 - If the volume control is not used within five seconds, it will resume its normal volume control function.

Selecting digital sound effects

Select a preset digital sound effect that matches your disc's content or that optimises the sound of the musical style you are playing.

- Press **SOUND** to select the available sound effect.

When playing movie discs or in TV mode, you can select :

CONCERT, DRAMA, ACTION or SCI-FI.

When playing music discs or while in TUNER or AUX/DI mode, you can select : ROCK, DIGITAL, CLASSIC or JAZZ.



Helpful Hint:

– For flat sound output, select CONCERT or CLASSIC.

Volume control

- Press **VOL** + / – on the remote to increase or decrease the volume level.
 - “VOL MIN” is the minimum volume level and “VOL MAX” is the maximum volume level.

To turn off the volume temporarily

- Press **MUTE**  on the remote.
 - Playback will continue without sound and “MUTE” appears.
 - To restore the volume, press **MUTE**  again, or increase the volume level.

Sound and Volume Controls (continued)

Setting the Sleep timer

The sleep timer enables the system to switch to standby mode automatically at a preset time.

- 1 Press and hold **DIM** on the remote until "SLEEP XX" appear on the display panel (XX = 15, 30, 45, 60 or OFF).
- 2 To select the next sleep timer value, press **DIM** button again while in sleep timer mode until it reaches the desired preset switch-off time.
 - 'SLEEP' will be showed on the display panel, except if "OFF" is selected.
 - Before the system switches to standby mode, a countdown of 10 seconds is displayed.
 - "SLEEP10" → "SLEEP 9"... →
 - "SLEEP1" → "SLEEP"

To cancel the sleep timer

- Press and hold **DIM** until "OFF" appears or press the **STANDBY**  button.

Dimming system's display screen

- In any active mode, press **DIM** on the remote to select the desired brightness :

DIM 1 : 70% brightness

DIM 2 : 50% brightness

DIM 3 : 25% brightness

DIM OFF : normal brightness

Using the remote to operate your 'Philips' television

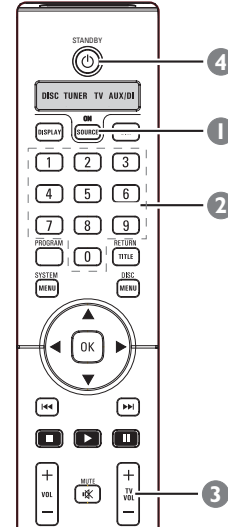

- 1 Press **SOURCE** button until "TV" appears on the display panel.
- 2 Press **◀◀ / ▶▶** or use the **numeric keypad (0-9)** to select the TV's channel.
- 3 Press **TV VOL + / -** to adjust the TV's volume level.
- 4 Press and hold **STANDBY**  to switch off your TV.

Specifications

AMPLIFIER SECTION

Output power	800 W
Front Left/Right	125 W / channel
Front Centre	125 W / channel
Rear Left/Right	85 W / channel
Rear Centre	105 W / channel
Subwoofer	150 W / channel
Frequency Response	20 Hz – 6 kHz / –3 dB
Signal-to-Noise Ratio	> 65 dB (CCIR)
Input Sensitivity	
– AUX In	1000 mV
– TV In	500 mV

TUNER SECTION

Tuning Range	FM 87.5 – 108 MHz (50 kHz)
26 dB Quieting Sensitivity	FM 20 dB
Image Rejection Ratio	FM 25 dB
IF Rejection Ratio	FM 60 dB
Signal-to-Noise Ratio	FM 60 dB
AM Suppression Ratio	FM 30 dB
Harmonic Distortion	FM Stereo 3%
Frequency Response	FM 180 Hz – 10 kHz / ±6 dB
Stereo Separation	FM 26 dB (1 kHz)
Stereo Threshold	FM 23.5 dB

DISC SECTION

Laser Type	Semiconductor
Disc Diameter	12cm / 8cm
Video Decoding	MPEG-1 / MPEG-2 / MPEG-4 / DivX 3.11, 4.x, 5.x and 6.0 / XviD
Video DAC	12 Bits / 108 MHz
Signal System	PAL / NTSC
Video Format	4:3 / 16:9
Video S/N	56 dB (minimum)
Composite Video Output	1.0 Vp-p, 75 W
Audio DAC	24 Bits / 96 kHz
Frequency Response	4 Hz – 20 kHz (44.1 kHz) 4 Hz – 22 kHz (48 kHz) 4 Hz – 44 kHz (96 kHz)
PCM	IEC 60958
Dolby Digital	IEC 60958, IEC 61937
DTS	IEC 60958, IEC 61937
SACD D/A converter	PCM
SACD cut-off frequency	50 kHz

CENTRE UNIT

Power Supply Rating	220 – 230 V; 50 Hz
Power Consumption	150 W
Standby Power Consumption	< 0.5 W
Dimensions (w x h x d)	273 x 284 x 144 mm
Weight	2.8 kg

AV SUBWOOFER

Power Supply Rating	220 – 230 V; 50 Hz
Power Consumption	150 W
Standby Power Consumption	< 0.5 W
System	Bass Reflex System
Impedance	4 Ω
Speaker drivers	165mm (6.5") woofer
Frequency response	30 Hz – 120 Hz
Dimensions (w x h x d)	300 x 399 x 300 mm
Weight	12 kg

LEFT/ RIGHT SPEAKERS

System	2-way, closed box system
Impedance	6 Ω
Speaker drivers	2 x (3"x3") flat cone woofer + 1 x (1"x4") ribbon tweeter
Frequency response	120 Hz + 20 kHz
Dimensions (w x h x d)	106 x 1220 x 32 mm (height including stand)
Weight	4.75 kg/each (including stand)

CENTRE FRONT/ REAR SPEAKERS

System	2-way, closed box system
Impedance	6 Ω
Speaker drivers	2 x (3"x3") flat cone woofer + 1 x (1"x4") ribbon tweeter
Frequency response	120 Hz + 20 kHz
Dimensions (w x h x d)	497 x 139 x 32 mm (height including stand)
Weight	1.5 kg/each (including base)

AV WIRELESS RECEIVER BOX

Power Supply Rating	110 – 240 V; 50 - 60Hz
Power Consumption	60 W
Standby Power Consumption	< 0.5 W
Dimensions (w x h x d)	242.5 x 157 x 117.5 mm
Weight	1.56 kg

JUNCTION BOX

Dimensions (w x h x d)	182 x 35 x 62 mm
Weight	0.27 kg



Specifications subject to change without prior notice.

Troubleshooting

WARNING

Under no circumstances should you try to repair the system yourself, as this will invalidate the warranty. Do not open the system as there is a risk of electric shock.

If a fault occurs, first check the points listed below before taking the system for repair. If you are unable to remedy a problem by following these hints, consult your dealer or Philips for help.

Problem	Solution
No power.	<ul style="list-style-type: none"> – Check if the AC power cord is properly connected. – Press the  (STANDBY ON) on the front of the DVD system to switch on the power.
No picture.	<ul style="list-style-type: none"> – Refer to your TV's manual for correct Video In channel selection. Change the TV channel until you see the DVD screen. – Press the SOURCE button to select disc mode. – If the progressive scan feature is activated, but the connected TV does not support progressive signals or the cables are not connected accordingly, see pages 25~26 for proper progressive scan set up or deactivate the progressive scan feature as below: <ol style="list-style-type: none"> 1) Switch off your TV progressive scan mode or switch on to interlaced mode. 2) Press  EJECT on the DVD system. 3) Press  on the remote control. 4) Press SUBTITLE on the remote control.
Completely distorted picture or black/ white picture is displayed.	<ul style="list-style-type: none"> – If this happens when you are changing the setting of the 'TV TYPE', wait for 15 seconds for the auto recovery. – If this happens when you are switching on the progressive scan feature, wait for 15 seconds for the auto recovery. – Check the video connection. – Sometimes a small amount of picture distortion may appear. This is not a malfunction. – Clean the disc.
The aspect ratio of the screen cannot be changed even though you have set the TV display.	<ul style="list-style-type: none"> – The aspect ratio is fixed on the DVD disc. – Depending on the TV, it may not be possible to change the aspect ratio.
No sound or distorted sound.	<ul style="list-style-type: none"> – Adjust the volume. – Check the speaker connections and settings. – Make sure that the audio cables are connected and press the SOURCE button to select the correct input source (TV or AUX/DI, for example) to choose the equipment that you want to hear through the DVD system.
Cannot activate some features such as Angles, Subtitles, or multi-language Audio.	<ul style="list-style-type: none"> – The features may not be available on the DVD. – Changing the language for the sound or subtitle is prohibited on this DVD.

Troubleshooting (continued)

Problem	Solution
Unable to select some items in the setup/system menu.	<ul style="list-style-type: none">– Press ■ STOP button twice before selecting the system setup menu.– Depending on the disc availability, some menu items cannot be selected.
The DVD system does not start playback.	<ul style="list-style-type: none">– Insert a readable disc with the playback side facing down. The DVD+R/CD-R must be finalised.– Check the disc type, colour system (PAL or NTSC) and region code.– Check for any scratches or smudges on the disc.– Press SYSTEM MENU to switch off the system setup menu screen.– You may need to enter the password in order to change the parental control rating level or to unlock the disc for playback.– Moisture may have condensed inside the system. Remove the disc and leave the system switched on for about an hour.
No surround sound effect from the speakers.	<ul style="list-style-type: none">– Press the SURR. button to select a correct surround sound setting.– Make sure the source you are playing is recorded or broadcast in surround sound (DTS, Dolby Digital, etc.).
Radio reception is poor.	<ul style="list-style-type: none">– If the signal is too weak, adjust the antenna or connect an external antenna for better reception.– Increase the distance between the system and your TV or VCR.– Tune in to the correct frequency.– Place the antenna further away from any equipment that may be causing the interference.
The remote control does not function properly.	<ul style="list-style-type: none">– Select the source (for example, SOURCE) before you press the function button (▶, ◀◀, ▶▶).– Reduce the distance between the remote control and the DVD system.– Replace the batteries with new ones.– Point the remote control directly toward the IR sensor.– Check that the batteries are loaded correctly.
Unable to play DivX movies.	<ul style="list-style-type: none">– Check that the DivX file is encoded in 'Home Theatre' mode with DivX 5.x/6.x encoder.
The DVD system does not work.	<ul style="list-style-type: none">– Disconnect the power cord from the power outlet for a few minutes. Reconnect the power cord and try to operate again as usual.
The disc in the disc slot cannot be ejected.	<ul style="list-style-type: none">– Press and hold the ■ STOP button on the remote control, followed by pressing number button "2", "5" and "9".

Troubleshooting (continued)

English

Problem	Solution
No HDMI audio output.	<ul style="list-style-type: none">- You will not hear any sound from the HDMI output if the source device is only DVI/HDCP (High-bandwidth Digital Content Protection)-compatible.- It is not possible to output SACD or copy-controlled DVD-Audio sources from the HDMI connection.
No HDMI video output.	<ul style="list-style-type: none">- HDMI connection can only be made to HDMI-equipped devices with HDCP (High Bandwidth Digital Content Protection.) If you wish to connect to a DVI connector (equipped with HDCP,) you will need a separate adaptor (DVI to HDMI.)- Make sure the resolution of this DVD system matches the device you have connected using the HDMI. See "DVD System Menu Options - Video Setup Page".
There is interference on your HTS9800W rear speakers or existing wireless network in your home.	<ul style="list-style-type: none">- You need to switch to another frequency channel to avoid bandwidth interference by other wireless devices.- To switch the frequency channel, press and hold the SOUND key on the remote control for 5 secs.- You will see the channel numbers (1- 4) flashing on the display panel of your DVD system.

Analogue: Sound that has not been switched into numbers. Analogue sound varies, while digital sound has specific numerical values. These sockets send audio through two channels, the left and right.

Aspect ratio: The ratio of vertical and horizontal sizes of a displayed image. The horizontal vs. vertical ratio of conventional TVs is 4:3, and that of wide-screens is 16:9.

AUDIO OUT Sockets: Red and white sockets on the back of the DVD system that send audio to another system (TV, Stereo, etc.).

Bit rate: The amount of data used to hold a given length of music; measured in kilobits per second, or kbps. Or, the speed at which you record. Generally, the higher the bit rate, or the higher the recording speed, the better the sound quality. However, higher bit rates use more space on a disc.

Chapter: Sections of a picture or a music piece on a DVD that are smaller than titles. A title is composed of several chapters. Each chapter is assigned a chapter number enabling you to locate the chapter you want.

Component Video Out sockets: Sockets on the back of the DVD system that send high-quality video to a TV that has Component Video In sockets (R/G/B, Y/Pb/Pr, etc.).

Disc menu: A screen display prepared for allowing a selection of images, sounds, subtitles, multi-angles, etc. to be recorded on a DVD.

DivX 3.11/4.x/5.x/6.x: The DivX code is a patent-pending, MPEG-4 based video compression technology, developed by DivX Networks, Inc., that can shrink digital video to sizes small enough to be transported over the internet, while maintaining high visual quality.

Dolby Digital: A surround sound system developed by Dolby Laboratories containing up to six channels of digital audio (front left and right, surround left and right, centre and subwoofer).

Dolby Digital EX: A surround sound system developed by Dolby Laboratories containing up to seven channels of digital audio (front left and right, surround left and right, centre front and rear subwoofer).

Dolby Surround Pro Logic II: It is an improved matrix decoding technology that provides better spatiality and directionality on Dolby Surround programme material, provides a convincing three dimensional sound field on conventional stereo music recordings and is ideally suited to bring the surround experience to automotive sound. While conventional surround programming is fully compatible with Dolby Surround Pro Logic II decoders, soundtracks will be able to be encoded specifically to take full advantage of Pro Logic II playback, including separate left and right surround channels. (Such material also compatible with conventional Pro Logic decoders).

DTS: Digital Theatre Systems. This is a surround sound system, but it is different from Dolby Digital. The formats are developed by different companies.

HDMI: High-Definition Multimedia Interface (HDMI) is a high-speed digital interface that can transmit uncompressed high definition video and digital multichannel audio. It delivers perfect picture and sound quality, completely free from noise. HDMI is fully backward-compatible with DVI. As required by the HDMI standard, connecting to HDMI or DVI products without HDCP (High-bandwidth Digital Content Protection) will result in no Video or Audio output.

HDCP (High-bandwidth Digital Content Protection) is a specification that provides a secure transmission of digital contents between different devices (to prevent unauthorised copyright).

JPEG: A very common digital still picture format. A still picture data compression system proposed by the Joint Photographic Expert Group, which features small decrease in image quality in spite of its high compression ratio.

MP3: A file format with a sound data compression system. "MP3" is the abbreviation of Motion Picture Experts Group I (or MPEG-1) Audio Layer3. By using the MP3 format, one CD-R or CD-RW can contain about 10 times more data than a regular CD.

Glossary

Multichannel: DVDs are formatted to have each sound track constitute one sound field. Multichannel refers to a structure of sound tracks having three or more channels.

Parental control: Limits disc play according to the age of the users or the limitation level in each country. The limitation varies from disc to disc; when it is activated, playback will be prohibited if the software's level is higher than the user-set level.

Playback control (PBC): Refers to the signal recorded on video CDs or SVCDs for controlling playback. By using menu screens recorded on a Video CD or SVCD that supports PBC, you can enjoy interactive playback and searching.

Progressive Scan: It displays all the horizontal lines of a picture at one time, as a signal frame. This system can convert the interlaced video from DVD into progressive format for connection to a progressive display. It dramatically increases the vertical resolution.

Region code: A system allowing discs to be played only in the region designated. This unit will only play discs that have compatible region codes. You can find the region code of your unit by looking on the product label. Some discs are compatible with more than one region (or ALL regions).

Super Audio CD (SACD): This audio format is based upon the current CD standards but includes a greater amount of information that provides higher quality sound. There are three types of discs: single layer, double layer and hybrid discs. The hybrid disc contains both standard audio CD and Super Audio CD information.

Surround: A system for creating realistic three dimensional sound fields full of realism by arranging multiple speakers around the listener.

Title: The longest section of a movie or music feature on DVD. Each title is assigned a title number, enabling you to locate the title you want.

VIDEO OUT socket: Yellow socket on the back of the DVD system that sends the DVD picture video to a TV.

WMA : WMA is short for Windows Media Audio and refers to an audio compression technology developed by Microsoft Corporation. WMA data can be encoded by using Windows Media Player version 9 or Windows Media Player for Windows XP. Files are recognised by their file extension". wma" or ".WMA".



Free Manuals Download Website

<http://myh66.com>

<http://usermanuals.us>

<http://www.somanuals.com>

<http://www.4manuals.cc>

<http://www.manual-lib.com>

<http://www.404manual.com>

<http://www.luxmanual.com>

<http://aubethermostatmanual.com>

Golf course search by state

<http://golfingnear.com>

Email search by domain

<http://emailbydomain.com>

Auto manuals search

<http://auto.somanuals.com>

TV manuals search

<http://tv.somanuals.com>