

3 DVD Digital Home Cinema System

MX 5000D



Read this manual first!

Congratulations on purchasing this Philips product. We've included everything you need to get started. If you have any problems, Philips Representatives can help you get the most from your new product by explaining:

- Hookups,
- First Time Setup, and
- Feature Operation.

Do not attempt to return this product to the store.

For fast help, call us first!

1-800-531-0039

Thank you for making Philips a part of your home!



Let's make things better.



PHILIPS

Return your Warranty Registration card today to ensure you receive all the benefits you're entitled to.

• Once your Philips purchase is registered, you're eligible to receive all the privileges of owning a Philips product.

• So complete and return the Warranty Registration Card enclosed with your purchase at once, and take advantage of these important benefits.

Warranty Verification

Registering your product within 10 days confirms your right to maximum protection under the terms and conditions of your Philips warranty.

Owner Confirmation

Your completed Warranty Registration Card serves as verification of ownership in the event of product theft or loss.

Model Registration

Returning your Warranty Registration Card right away guarantees you'll receive all the information and special offers which you qualify for as the owner of your model.

PHILIPS

Congratulations on your purchase, and welcome to the "family!"

Dear Philips product owner:

Thank you for your confidence in Philips. You've selected one of the best-built, best-backed products available today. And we'll do everything in our power to keep you happy with your purchase for many years to come.

As a member of the Philips "family," you're entitled to protection by one of the most comprehensive warranties and outstanding service networks in the industry.

What's more, your purchase guarantees you'll receive all the information and special offers for which you qualify, plus easy access to accessories from our convenient home shopping network.

And most importantly you can count on our uncompromising commitment to your total satisfaction.

All of this is our way of saying welcome – and thanks for investing in a Philips product.

Sincerely,



Lawrence J. Blanford
President and Chief Executive Officer

P.S. Remember, to get the most from your Philips product, you must return your Warranty Registration Card within 10 days. So please mail it to us right now!



Know these safety symbols



This "bolt of lightning" indicates uninsulated material within your unit may cause an electrical shock. For the safety of everyone in your household, please do not remove product covering.



The "exclamation point" calls attention to features for which you should read the enclosed literature closely to prevent operating and maintenance problems.

WARNING: TO PREVENT FIRE OR SHOCK HAZARD, DO NOT EXPOSE THIS EQUIPMENT TO RAIN OR MOISTURE.

CAUTION: To prevent electric shock, match wide blade of plug to wide slot, and fully insert.

For Customer Use

Enter below the Serial No. which is located on the rear of the cabinet. Retain this information for future reference.

Model No. _____

Serial No. _____





Getting started... MX-5000D

Connecting to speakers, subwoofer and antennas

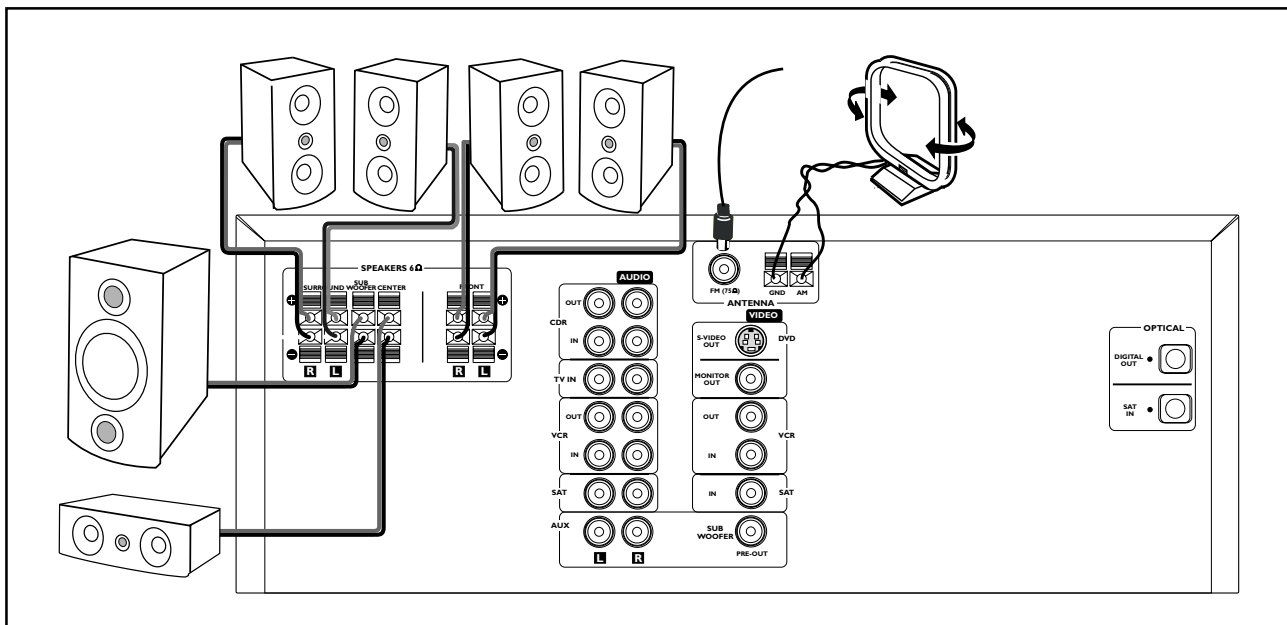

Speakers	⊖	⊕
FRONT (L/R)	black	red
CENTER	black	blue
REAR (SURROUND) (L/R)	black	grey
SUBWOOFER	black	brown

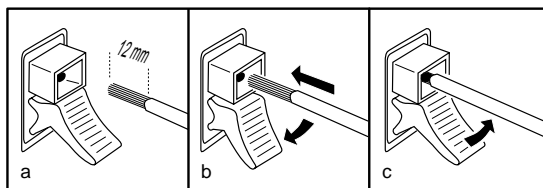

Positioning the speakers and subwoofer

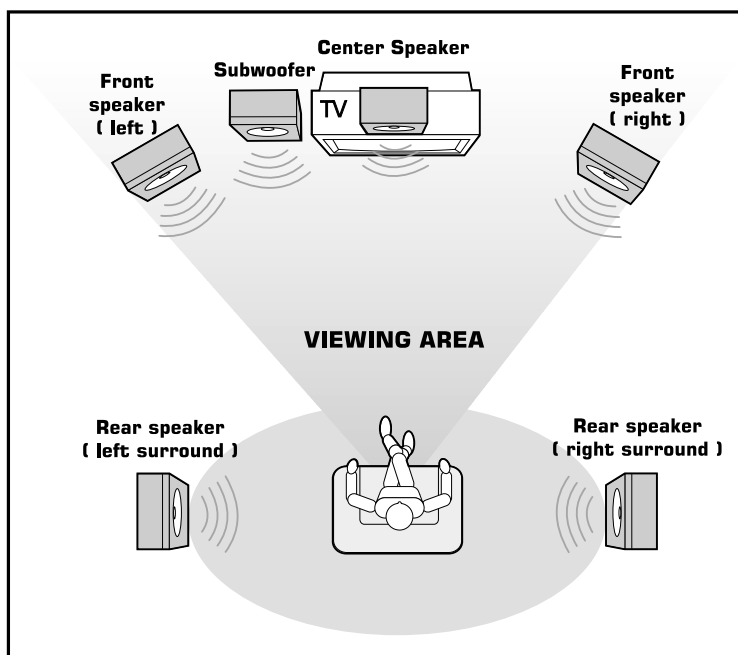



Connecting to TV

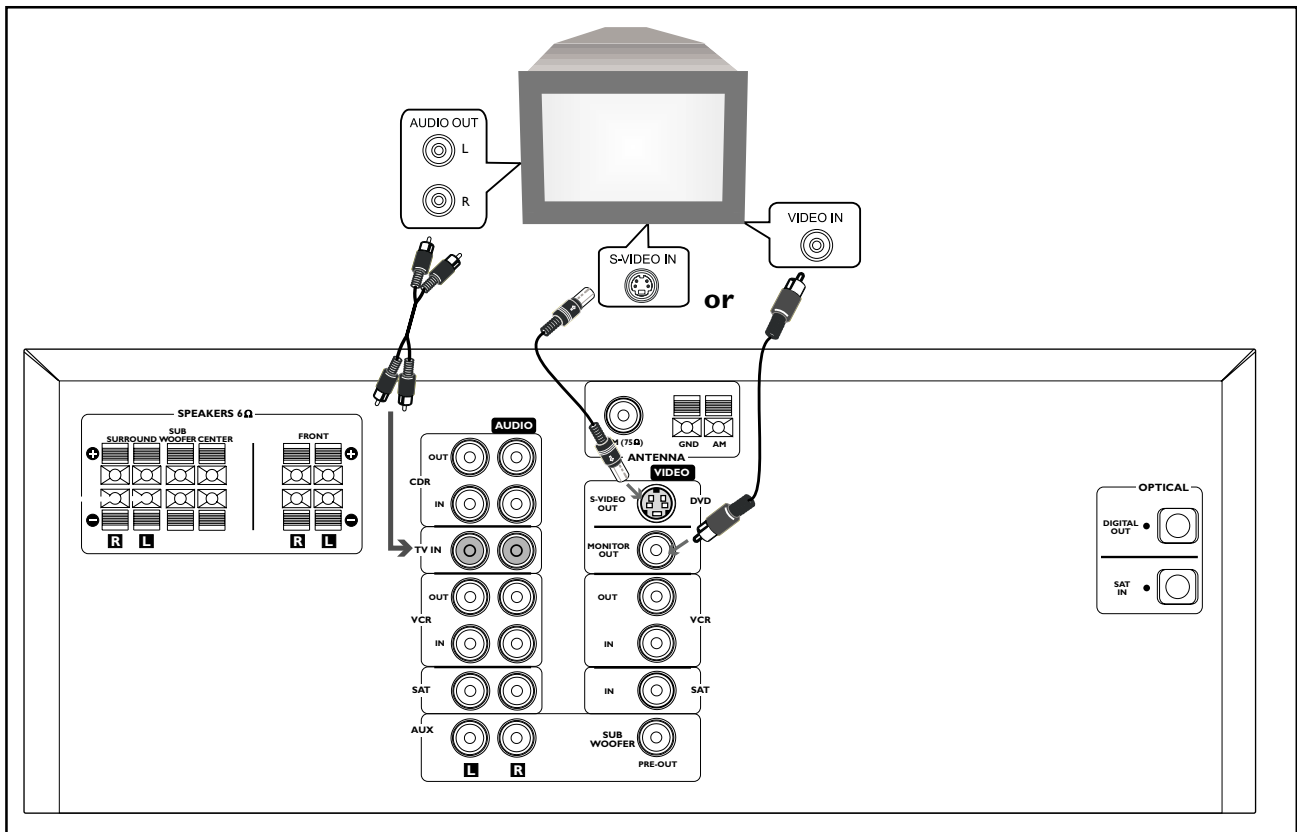

Connecting to VCR (optional)

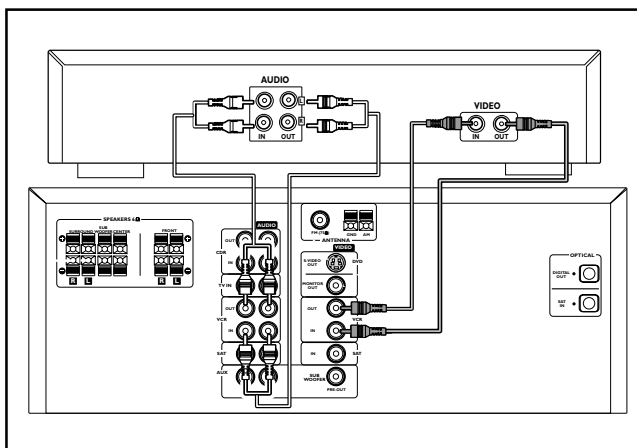

Connecting to CDR (optional)

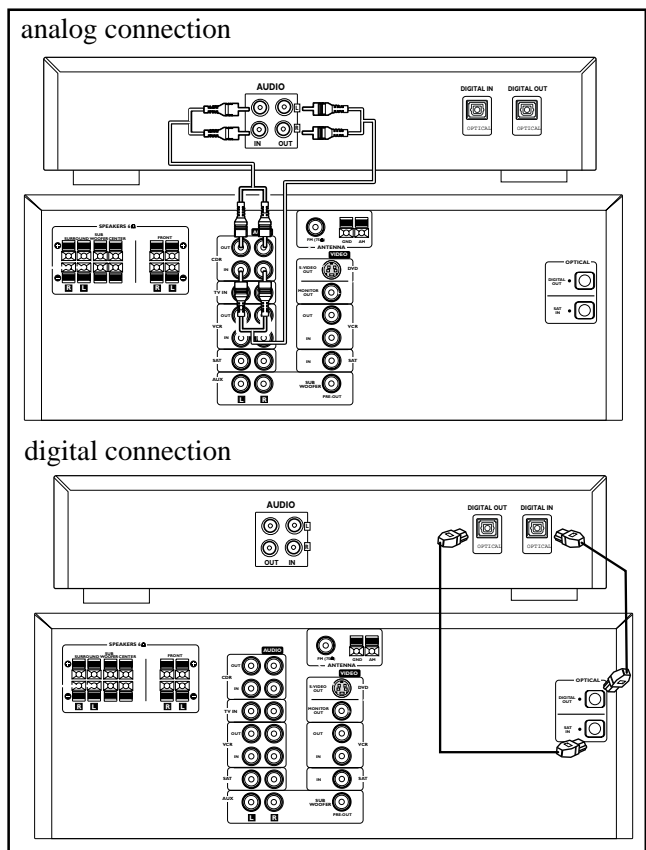

Canada

English:

This digital apparatus does not exceed the Class B limits for radio noise emissions from digital apparatus as set out in the Radio Interference Regulations of the Canadian Department of Communications.

Français:

Cet appareil numérique n'émet pas de bruits radioélectriques dépassant les limites applicables aux appareils numériques de Class B prescrites dans le Règlement sur le Brouillage Radioélectrique édicté par le Ministère des Communications du Canada.

Manufactured under license from Dolby Laboratories. "Dolby", "AC-3", "Pro Logic" and the double-D symbol are trademarks of Dolby Laboratories. Confidential Unpublished Works. ©1992-1997 Dolby Laboratories, Inc. All rights reserved.

Manufactured under license from Digital Theater system, inc. US Pat. No. 5,451,942 and other worldwide patents issued and pending. "DTS" and "DTS Digital Surround" are trademarks of Digital theater Systems, Inc. 1996 Digital Theater Systems, Inc. All rights reserved.

This product incorporates copyright protection technology that is protected by method claims of certain U.S. patents and other intellectual property rights owned by Macrovision Corporation and other rights owners. Use of this copyright protection technology must be authorized by Macrovision Corporation, and is intended for home and other limited viewing uses only unless otherwise authorized by Macrovision Corporation. Reverse engineering or disassembly is prohibited.

CAUTION

Use of controls or adjustments or performance of procedures other than herein may result in hazardous radiation exposure or other unsafe operation.

ATTENTION

L'utilisation des commandes ou réglages ou le non-respect des procédures ci-incluses peuvent se traduire par une exposition dangereuse à l'irradiation.

ATENCIÓN

El uso de mando o ajustes o la ejecución de métodos que no sean los aquí descritos puede ocasionar peligro de exposición a radiación.

English ----- 5

Français ----- 28

Español ----- 52

CAUTION : Any changes or modifications in construction of this device with are not expressly approved by the party responsible for compliance, could void the user's authority to operate the equipment.

This equipment has been tested and found to comply with the limits for a class B digital device, pursuant to part 15 of the FCC Rules. These limits are designed to provide reasonable protection against harmful interference in a residential installation. This equipment generates, uses and can radiate radio frequency energy and, if not installed and used in accordance with the instructions, may cause harmful interference to radio communications. However, there is no guarantee that interference will not occur in a particular installation. If this equipment does cause harmful interference to radio or television reception, which can be determined by turning the equipment off and on, the user is encouraged to try to correct the interference by one or more of the following measures :

- Reorient or relocate the receiving antenna.
- Increase the separation between the equipment and receiver.
- Connect the equipment into an outlet on a circuit different from that to which the receiver is connected.
- Consult the dealer or an experienced radio/ TV technician for help.

Laser

Type	Semiconductor laser GaAlAs
Wave length	650nm
Output Power	7mW
Beam divergence	60 degree

NOTE:

PICTURES SHOWN MAY BE DIFFERENT BETWEEN COUNTRIES.

NEVER MAKE OR CHANGE CONNECTIONS WITH THE POWER SWITCHED ON.

IMPORTANT SAFETY INSTRUCTIONS

1. **Read these instructions.**
2. **Keep these instructions.**
3. **Heed all warnings.**
4. **Follow all instructions.**
5. **Do not use this apparatus near water.**
6. **Clean only with dry cloth.**
7. **Do not block any ventilation openings. Install in accordance with the manufacturer's instructions.**
8. **Do not install near any heat sources** such as radiators, heat registers, stoves, or other apparatus (including amplifiers) that produce heat.
9. **Do not defeat the safety purpose** of the polarized or grounding-type plug. A polarized plug has two blades with one wider than the other. A grounding type plug has two blades and a third grounding prong. The wide blade or the third prong are provided for your safety. If the provided plug does not fit into your outlet, consult an electrician for replacement of the obsolete outlet.
10. **Protect the power cord** from being walked on or pinched, particularly at plugs, convenience receptacles, and the point where they exit from the apparatus.

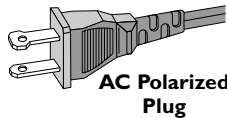

11. **Only use attachments/accessories** specified by the manufacturer.
12.  **Use only with the cart,** stand, tripod, bracket, or table specified by the manufacturer or sold with the apparatus. When a cart is used, use caution when moving the cart/apparatus combination to avoid injury from tip-over.
13. **Unplug this apparatus** during lightning storms or when unused for long periods of time.
14. **Refer all servicing** to qualified service personnel. Servicing is required when the apparatus has been damaged in any way, such as power-supply cord or plug is damaged, liquid has been spilled or objects have fallen into the apparatus, the apparatus has been exposed to rain or moisture, does not operate normally, or has been dropped.
15. **Battery usage CAUTION** – To prevent battery leakage which may result in bodily injury or damage to the unit:
 - Install **all** batteries correctly, **+** and **-** as marked on the unit.
 - Do not mix batteries (**old** and **new** or **carbon** and **alkaline**, etc.).
 - Remove batteries when the unit is not used for a long time.

EL 6475-E003: 01/6

Introduction and General Information

Features	6
Discs for playback	6
Player zone	
Supplied accessories	6
Environmental information	6
Installation	6
Maintenance	6

Functional Overview

Front panel	7
Remote Control	8

Connections

Connecting antennas	9
FM Indoor Antenna	
FM Outdoor Antenna	
AM Indoor Loop Antenna	
AM Outdoor Antenna	
Connecting the speakers	10
Connecting a TV	10
Connecting additional components	11
Connecting a CD Recorder	
Connecting a VCR	
Connecting a Satellite Receiver or Cable Box	
Connecting an auxiliary audio device	
Connecting a second Subwoofer	
Connecting a Digital (Optical) audio device	

Preparations

Inserting batteries into the remote control	12
Switching on the system	12
NTSC/PAL automatic conversion	12
Setting up the surround sound system	12–13
Placing the speakers	
Changing the speaker size	
Changing the speaker distance	
Changing the channel level	
Test Tone	
Changing system settings-special circumstances	
Selecting TV aspect	14
Selecting digital audio out	14
Selecting a satellite receiver or cable box	14

Basic Functions

Selecting the source	15
Volume control	15
Adjusting the tone	15
Dimming the display screen	15
Selecting the surround sound mode	15–16
Selecting the virtual sound effect	16
Night mode	16
Sleep timer setting	16

Operations

Discs information	17
Basic playback	17
Playing an MP3 disc	17
General features	18
Skipping to another track/chapter	
Fast Search	
Continue playback from the last stop point	
Repeat play	
Program favorite tracks (CD)	18–19
Exit the program mode temporarily	
Reviewing the program	
Clearing the entire program	
Modifying the program	
Special DVD features	19–20
Advancing by playback	
Searching for a particular passage	
Playing in slow motion mode	
Zooming in	
Viewing from another angle	
Changing subtitle language	
Changing sound track language	
Title menu	
DVD menu	
Advanced features (DVD)	20
Using Graphic User Interface (GUI) menu icons	
Parental control (DVD)	21
Setting a rating level and password	
Selecting a rating level	
Setting a password	
Clearing the password	

Radio Reception

Tuning to radio stations	22
Presetting radio stations	22
Manual Preset	
Automatic Preset	
Listening to preset radio stations	22

Specifications

Troubleshooting

Introduction and General Information

Features

Your complete 6-piece 700-Watt DVD Digital Home Cinema System creates the same dynamic sound qualities that you find in full-fledged cinemas and incorporates some of the best features in home cinema technology.

Other features include:

Built-in DTS and Dolby Digital® decoder, supporting Dolby Pro Logic® and virtual surround

Lets you use the Home Cinema Audio System for a movie-theater surround sound experience.

Adjustable Speaker Size, Channel Level, and Distance

Lets you customize your setup for a true surround sound experience.

Additional Component Connections

Lets you connect other audio and audio/visual components to the DVD system so you can use the system's surround sound speakers.

Night Mode (Dolby Digital mode only)

Lets you compress the dynamic range, reducing the difference in loudness between different sounds in Dolby Digital mode.

Parental Control (Rating Level)

Lets you set a ratings level so that your children cannot watch a DVD that has a rating higher than you set.

Sleep Timer

Enables the system to switch to standby mode automatically at a preset time.

Discs for playback

Your DVD player is able to play :

- **All pre-recorded audio CDs**
- **All finalized audio CDR and audio CDRW discs**
- **All DVDs**
- **MP3-CDs (CD-ROMs with MP3 tracks)**



Player zone

DVD discs and players are designed with regional restrictions. Before playing a disc, make sure the disc is the same zone as your player.

The region code for this DVD player is 1.



Supplied accessories

- a remote control with two AA batteries
- an AM loop antenna and an FM wire antenna
- an audio and video cable for connection with your TV
- five satellite speakers, including five speaker cables
- a subwoofer; including a connection cable and a power cable
- this instruction booklet

If any item is damaged or missing, contact your retailer or Philips.

Environmental information

All unnecessary packaging has been omitted. We have tried to make the packaging easy to separate into three materials: cardboard (box), polystyrene foam (buffer) and polyethylene (bags, protective foam sheet).

Your system consists of materials which can be recycled and reused if disassembled by a specialized company. Please observe the local regulations regarding the disposal of packaging materials, exhausted batteries and old equipment.

Installation

- Place the player on a flat, hard, and stable surface.
- There must be sufficient room in front of the player for the drawer to open.
- In a cabinet, allow about 10cm (4 inches) of free space all around the player for adequate ventilation.
- Do not expose your player to extreme temperatures or humidity.

Maintenance

- When a disc becomes dirty, clean it with a cleaning cloth. Wipe the disc from the center out, in a straight line.
- Do not expose the player, batteries or discs to humidity, rain, sand or excessive heat (caused by heating equipment or direct sunlight). Always keep the disc tray closed to avoid dust on the lens.
- Do not use solvents such as benzene, thinner, commercially available cleaners, or anti-static spray intended for analog discs.
- The lens may cloud over when the player is suddenly moved from cold to warm surroundings, making it impossible to play a disc. Leave the player in the warm environment until the moisture evaporates.

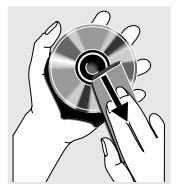

Front panel

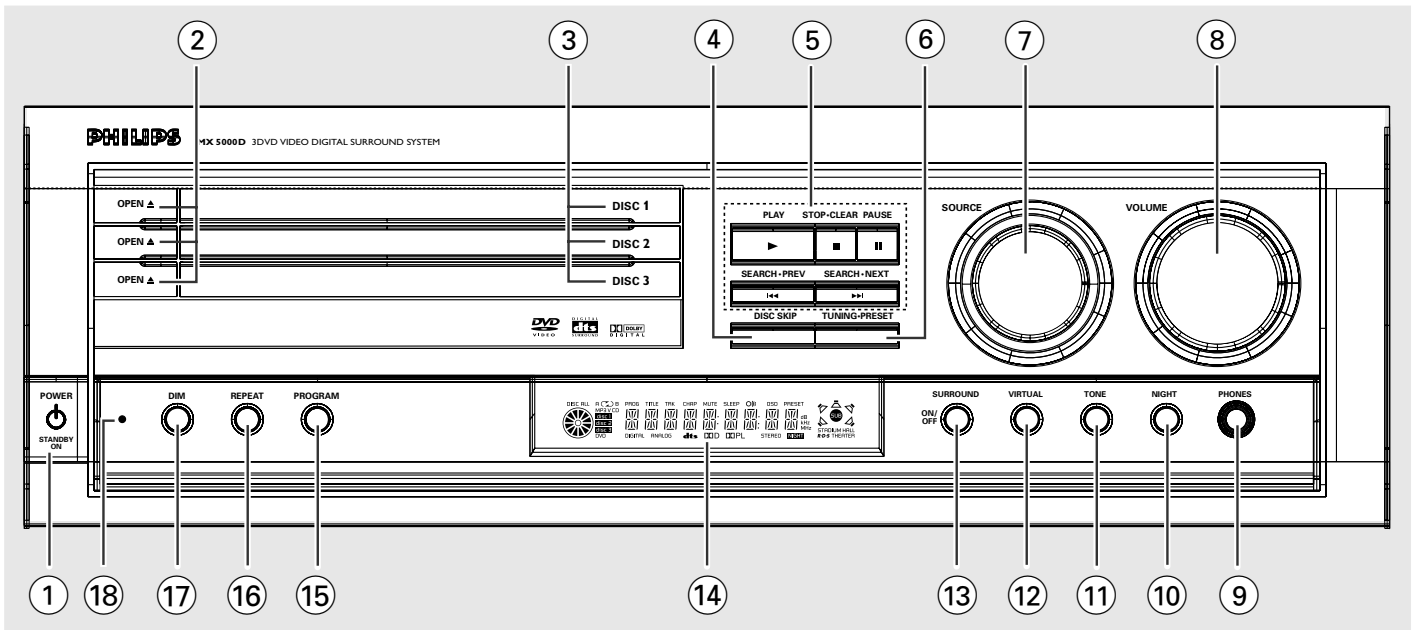

- ① **POWER / STANDBY ON**

 - to switch between power on and standby modes.

- ② **OPEN ▲ (DVD/CD mode only)**

 - to open or close the disc tray.

- ③ **Disc Trays**
- ④ **DISC SKIP**

 - in DVD/CD mode, to select another discs.

- ⑤ **Mode selection (DVD/CD mode only)**

 - PLAY ▶**

 - to play the disc.

 - STOP•CLEAR ■**

 - in DVD/CD mode, to stop playing the disc.

 - PAUSE II**

 - to freeze the sound and picture.

 - SEARCH•PREV ◀◀ / SEARCH•NEXT ▶▶**

 - in DVD/CD mode, press to skip to the previous/next chapter/track.
 - in DVD/CD mode, hold down to fast reverse/forward the disc.
 - in Tuner mode, to tune to a lower or higher radio frequency.
 - in Philips TV mode, to tune channel up/down.

- ⑥ **TUNING•PRESET**

 - to switch between preset or tuning mode.

- ⑦ **SOURCE**

 - to select the desired source or external input source (DVD/CD, TV/AV, TUNER (FM/AM), CDR, AUX, SAT or VCR).
 - (on the remote control only)**

 - to switch on the system.
 - in DVD/CD mode, press to select another disc.
 - in Tuner mode, press to select FM or AM band.

- ⑧ **VOLUME (+ / -)**

 - to adjust the master volume.
 - in Philips TV mode, to adjust the volume level.
 - in Tone mode, to adjust the treble/bass tone level.

- ⑨ **PHONES**

 - to connect headphones.

- ⑩ **NIGHT (Dolby Digital mode only)**

 - to optimize the dynamic of the sound output.

- ⑪ **TONE**

 - to select Bass/Treble adjustment mode.

- ⑫ **VIRTUAL**

 - to select the virtual sound effect : STADIUM, HALL or THEATER

- ⑬ **SURROUND**

 - to select multichannel surround (Dolby Digital, DTS or Dolby ProLogic) or stereo sound effect.

- ⑭ **Display screen**

 - to display details for user's information.

- ⑮ **PROGRAM**

 - in DVD/CD mode, to program disc tracks.
 - in Tuner mode, to program preset radio stations.

- ⑯ **REPEAT**

 - to repeat chapter, track, title, disc(s).
 - to repeat a specific section on a disc.

- ⑰ **DIM**

 - to dim the display screen or return to normal brightness.

- ⑱ **Standby LED indicator**

 - to indicate standby mode.

Remote control

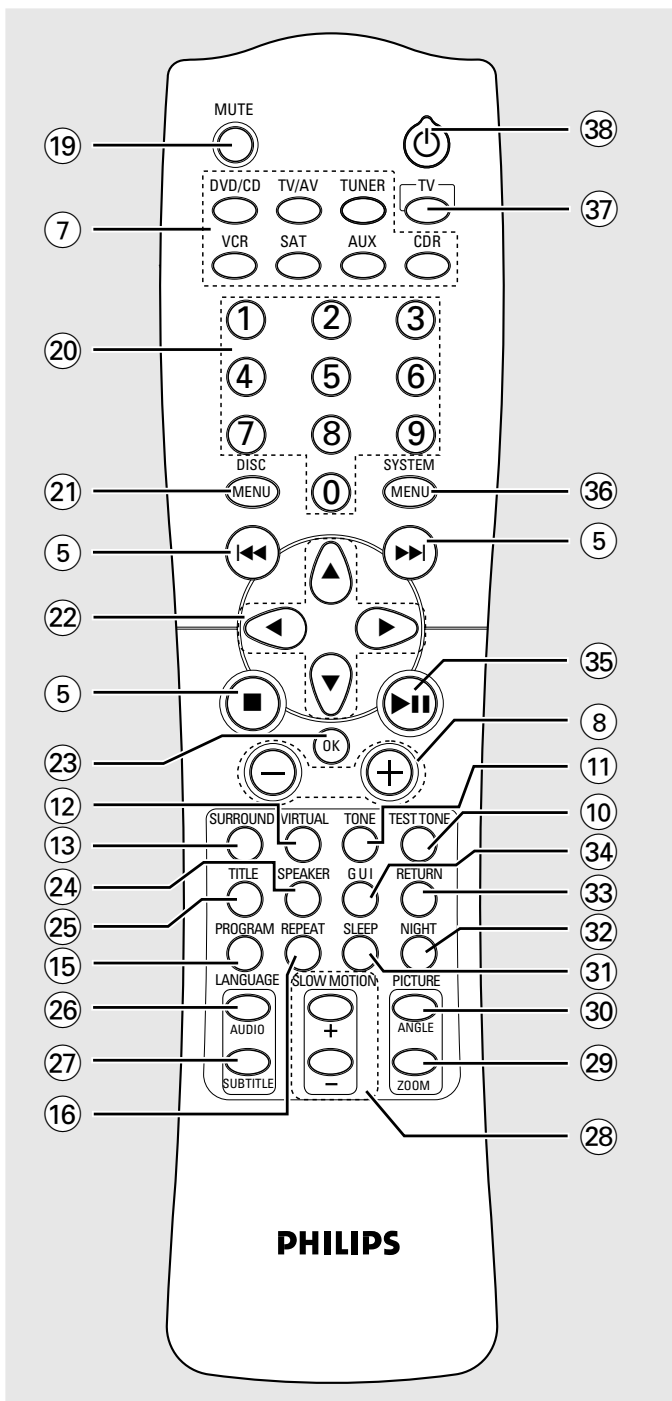

Notes for remote control:

- First, select the source you wish to control by pressing one of the source select keys on the remote control (DVD/CD or TUNER, for example).
- Then select the desired function (▶, ◀◀, ▶▶ for example).

- ①9 **MUTE**
 - to interrupt or resume sound reproduction.
- ②0 **Numeric keypad (0-9)**
 - to enter a track/title number of the disc.
 - to enter a number of preset radio stations.
- ②1 **DISC MENU (DVD mode only)**
 - to enter or exit the disc contents menu.
- ②2 **▲ ▼ ◀ ▶**
 - in Tuner mode, to select a preset radio station number (◀ or ▶).
 - to select movement direction in disc contents menu / system setup menu / GUI menu.
- ②3 **OK (DVD/CD mode only)**
 - to enter or confirm the selection.
- ②4 **SPEAKER**
 - to select speaker settings, volume balance and to test the speaker settings.
- ②5 **TITLE (DVD mode only)**
 - to display the Title menu if present on the disc.
- ②6 **LANGUAGE - AUDIO**
 - to select different audio languages available in the DVD disc.
- ②7 **LANGUAGE - SUBTITLE**
 - to select different subtitle languages available in the DVD disc.
- ②8 **SLOW MOTION + / -**
 - to watch a disc at a slower speed.
- ②9 **PICTURE - ZOOM**
 - to enlarge a still picture on the TV screen.
- ③0 **PICTURE - ANGLE**
 - to select a camera angle available in the DVD disc.
- ③1 **SLEEP**
 - to set the sleep (auto-off) timer function.
- ③2 **NIGHT (Dolby Digital mode only)**
 - to optimize the dynamic of the sound output.
- ③3 **RETURN**
 - to return to the previous menu level during playback.
- ③4 **GUI (DVD/CD mode only)**
 - to show the information contained on the disc.
- ③5 **▶ II**
 - to start or interrupt disc playback.
- ③6 **SYSTEM MENU (DVD mode only)**
 - to enter or exit the system setup menu.
- ③7 **TV**
 - to select Philips TV mode.
- ③8 **⏻**
 - to switch the system to standby mode.

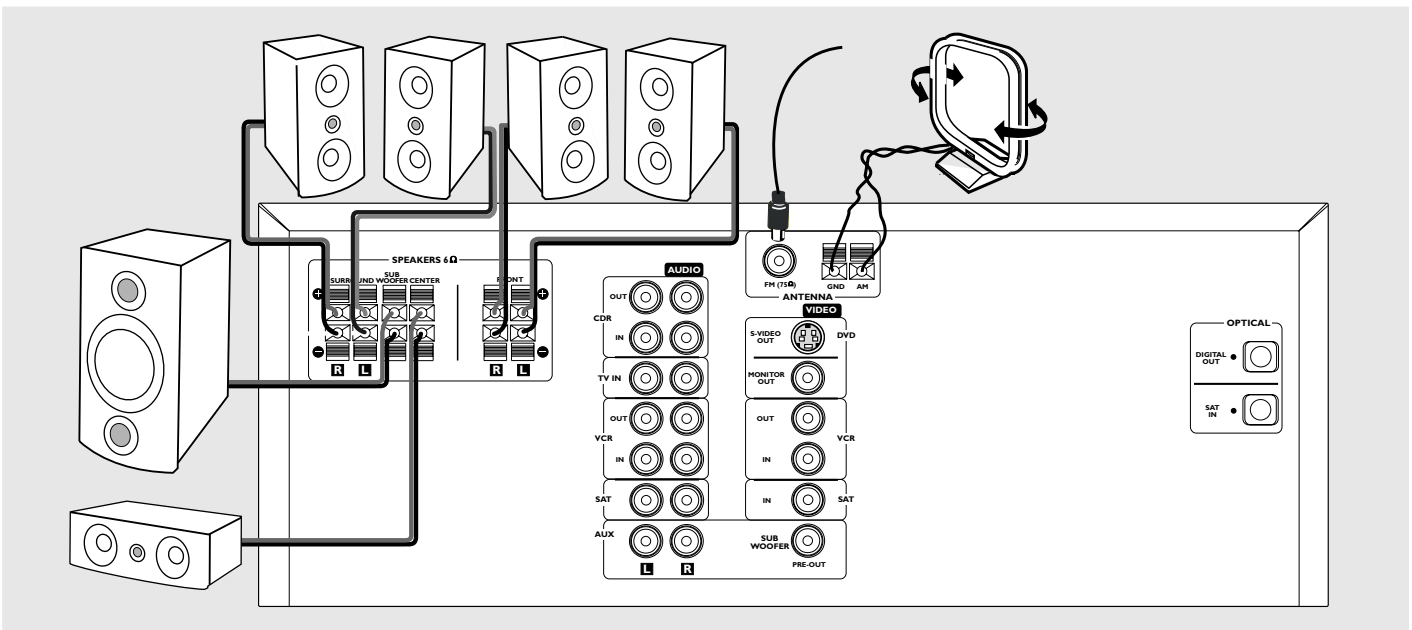

IMPORTANT!

- Before connecting the AC power cord to the wall outlet, ensure that all other connections have been made.
- Never make or change any connections with the power switched on.
- The type plate is located at the rear of the system.

Connecting antennas

FM Indoor Antenna

Connect the supplied FM antenna to the **FM (75 Ω)** jack. Move the antenna in various directions until the clearest signal is received.

Note:

- Keep the antenna as far away as possible from the TV, VCR or any radiation source to prevent unwanted noise.

FM Outdoor Antenna

For better FM reception, use a 75 ohm coaxial cable (not supplied) to connect the system to an outdoor FM antenna as shown.

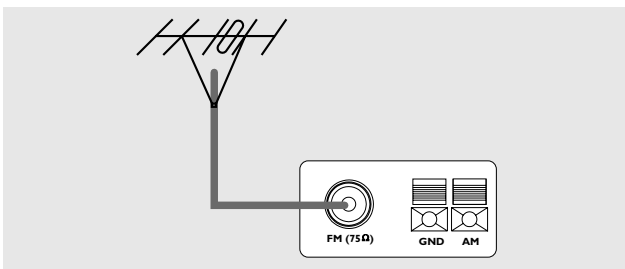

AM Indoor Loop Antenna

The supplied high-performance AM loop antenna is sufficient for good reception in most areas.

- 1 Connect the loop antenna's wires to **AM** and **GND**.
- 2 Place the antenna in a location (for example, on a shelf or window frame) that gives the best reception.

Note:

- Keep the antenna as far away as possible from the entire system, speaker cables, and the power cable to prevent unwanted noise.

AM Outdoor Antenna

If the supplied AM loop antenna does not deliver sufficient reception, use an outdoor AM antenna (not supplied).

Use an insulated wire more than 15 feet (5m) long. Strip one end, and connect that end to **AM**.

String the antenna wire outdoors or indoors near a window. For better reception, connect the **GND** terminal to a reliable ground.

Connecting the speakers

Connect the supplied speaker systems using the supplied speaker cables by matching the colors of the jacks and speaker cables.

Speakers	⊖	⊕
FRONT (L/R)	black	red
CENTER	black	blue
REAR (SURROUND) (L/R)	black	gray
SUBWOOFER	black	brown

- 1 Press up (or down) the speaker's jack and fully insert the stripped portion of the speaker cable into the jack, then release.

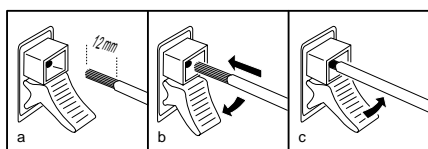

- 2 Connect the Front Left speaker to the **FRONT L** jacks. Connect the Front Right speaker to the **FRONT R** jacks. Connect the Center speaker to the **CENTER** jacks. Connect the Rear Surround Left speaker to **SURROUND L** jacks. Connect the Rear Surround Right speaker to **SURROUND R** jacks. Connect the subwoofer's audio input to the **SUBWOOFER** jack.

Notes:

- Ensure that the speaker cables are correctly connected. Improper connections may damage the system due to short-circuit.
- For optimal sound performance, use the supplied speakers.
- Do not connect more than one speaker to any one pair of + / – speaker jacks.
- Do not connect speakers with an impedance lower than the speakers supplied. Please refer to the SPECIFICATIONS section of this manual.

Connecting a TV

You must connect a TV to the DVD system in order to use the DVD player:

IMPORTANT!

- There are various ways to connect the system to a TV (as shown in the illustration below). You only need to make one of the best connections, depending on the capabilities of your TV system.
- The player's S-VIDEO jack is for use with the built-in 3-disc DVD player only. If you plan to use a VCR, satellite, or other equipment with this DVD system, you must use audio/visual cables to connect your TV to MONITOR OUT (and view DVDs through MONITOR OUT as well).

- Use the supplied audio cables to connect **AUDIO-TV IN (L/R)** jacks to the corresponding AUDIO OUT jacks on the TV.
- Use the supplied video cable to connect **VIDEO-MONITOR OUT** jack to the corresponding VIDEO IN jack on a TV.

Option

If the TV has a S-Video input jack, connect it to the **VIDEO-S-VIDEO OUT** jack using an S-video cable (not supplied) instead of MONITOR OUT jack for better picture clarity.

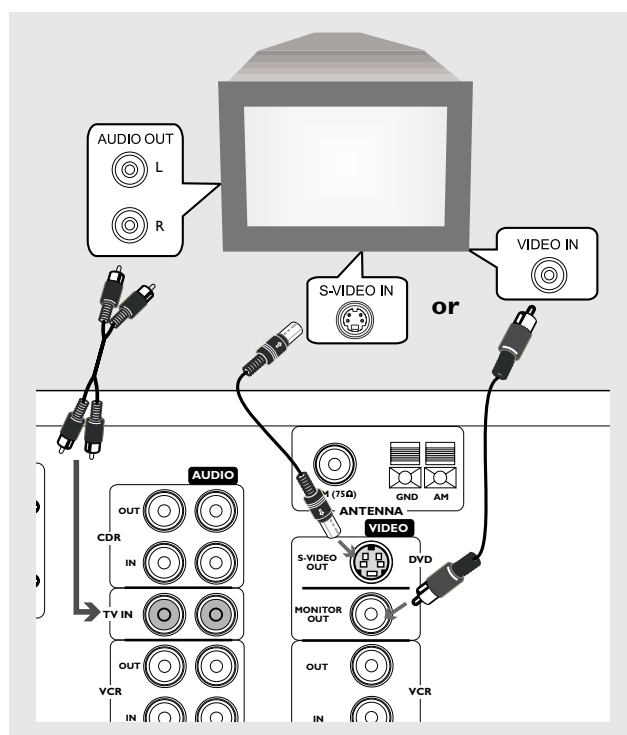

Note:

- Do not connect your TV to both the S-VIDEO and MONITOR OUT jacks.

Connecting additional components

You can connect other audio and audio/visual components to the DVD system in order to use the Home Cinema Audio System's surround sound capabilities.

IMPORTANT!

- For connection to additional components, the audio/video cables are not supplied.
- When making connections, make sure that the color of cables matching the color of jacks.
- Always refer to the instruction manual of the connected equipment to make an optimal connection.
- Some DVD discs have anti-copying devices, so you will not be able to record the disc through a VCR.

Connecting a CD Recorder

For analog recording

- Use the audio cables to connect **AUDIO-CDR OUT (L/R)** jacks to the corresponding **AUDIO IN** jacks on the CD Recorder.

For listening to the analog playback of the connecting device

- Use the audio cables (not supplied) to connect **AUDIO-CDR IN (L/R)** jacks to the corresponding **AUDIO OUT** jacks on the CD Recorder.

Connecting a VCR

Use audio/video cables to connect a VCR to the DVD system.

For recording

- 1 Connect **AUDIO-VCR OUT (L/R)** jacks to **AUDIO IN** on the VCR.
- 2 Connect **VIDEO-VCR OUT** jack to **VIDEO IN** jack on the VCR.

For viewing to the playback of the connecting device

- 1 Connect **AUDIO-VCR IN (L/R)** jacks to **AUDIO OUT** on the VCR.
- 2 Connect **VIDEO-VCR IN** jack to **VIDEO OUT** jack on the VCR.

Note:

- Make sure you connect the VCR to both the **IN** and **OUT** sets of jacks.

Connecting a Satellite Receiver or Cable Box

Use a video cable to connect a satellite receiver or cable box to the DVD system.

- Connect **VIDEO-SAT IN** jack to the **VIDEO OUT** jack of the connecting device.

For analog connection

- Use the audio cables to connect **AUDIO-SAT (L/R)** jacks to the **AUDIO OUT** jacks on the satellite receiver or cable box.

For digital connection

- Use an optical fiber-optic cable to connect **OPTICAL-SAT IN** jack to the **DIGITAL OPTICAL OUT** jack on the satellite receiver or cable box.

Note:

- If your satellite receiver or cable box is only equipped with a coaxial output, connection to the DVD system is not possible.

Connecting an auxiliary audio device

Use the audio cables to connect **AUDIO-AUX (L/R)** jacks to the corresponding **AUDIO OUT** jacks on an external audio device (such as an MP3 player, playback cassette deck, or portable CD player).

Connecting a second Subwoofer

You can connect a larger powered subwoofer to the system. Connect the subwoofer to the **SUBWOOFER PRE-OUT** jack using a shielded audio cable.

Connecting a Digital (Optical) audio device

- 1 Remove the dust caps from the digital optical connections. Keep the caps in a safe place.
- 2 Use an optical fiber-optic cable and make sure that both plugs are fully inserted (until a click is heard).

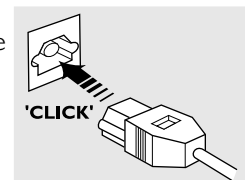

For digital recording

- Connect **OPTICAL-DIGITAL OUT** jack to the **DIGITAL OPTICAL IN** jack on an external digital(optical) audio device (such as Digital Audio Tape or CD Recorder).

For listening to the digital playback of the connecting device

- Connect **OPTICAL-SAT IN** jack to the **DIGITAL OPTICAL OUT** jack on a digital(optical) audio device (such as satellite receiver, portable CD player or DAT recorder).

Notes:

- MP3 audio is not available on the digital output.
- If the DVDs are encoded with anti-copy digital signal, digital recording is not possible.

Inserting batteries into the remote control

- 1 Open the battery compartment.
- 2 Place the batteries in the compartment with the correct polarity as indicated by “+” and “-” symbols.
- 3 Close the cover.

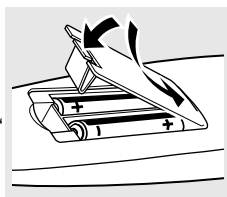

CAUTION!

- Remove batteries if they are exhausted or will not be used for a long time.
- Do not use old and new or different types of batteries in combination.
- Batteries contain chemical substances, so they should be disposed off properly.

Switching on the system

- 1 After completing all the connections, connect the AC power cord of the player and subwoofer to the wall outlet.
 - 2 Press **POWER** to switch on the last selected source.
 - 3 Adjust the **SOURCE** button (or press **DVD/CD, TV/AV, TUNER, CDR, AUX, SAT** or **VCR**) to select the input source.
 - The selected source will be displayed.
- For viewing a DVD disc, a TV set needs to be connected (refer to “Connections - Connecting a TV”). Switch on the TV and set to the correct video in channel (for example, EXT1, EXT2, AV1, AV2). Refer to your TV instruction manual for detail.
 - The default screen appears on the TV.

NTSC/PAL automatic conversion

This player is equipped with an NTSC/PAL automatic conversion feature that converts the video output of the disc to match your TV system (NTSC) automatically. For example, you are able to play a PAL disc on an NTSC system TV.

Setting up the surround sound system

You must connect all the speakers and set up the system properly in order to enjoy the Digital Cinema experience at home (refer to “Connections - Connecting the speakers”). You will have the feeling of being in the middle of the action because sound is coming from everywhere around you. The subwoofer can enhance the bass performance of your system dramatically.

IMPORTANT!

- Please sit at your usual listening position in order to set up the speaker balance correctly.
- To change the surround sound settings, the DVD system must be in a surround mode that uses all the speakers (for example, Dolby Digital).

Placing the speakers

To obtain the best surround effect, place the speaker as follows.

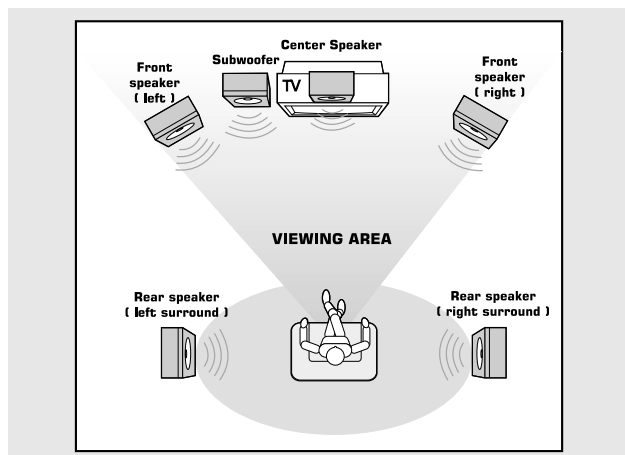

- 1 Place the front left and right speakers at equal distances from the TV and at an angle of approximately 45 degrees from the listening position.
- 2 Place the center speaker above or below the TV, so the center channel's sound is localized.
- 3 Place the surround speakers at normal listening ear level facing each other or mounted on the wall.
- 4 Place the subwoofer on the floor near to the TV.

Notes:

- To avoid magnetic interference, do not position the front speakers too close to your TV.
- If the rear surround speakers are installed farther away from the listening position than the front and center speakers, it will weaken the surround effect.
- All speakers should be securely installed to prevent accidents and improve sound quality.

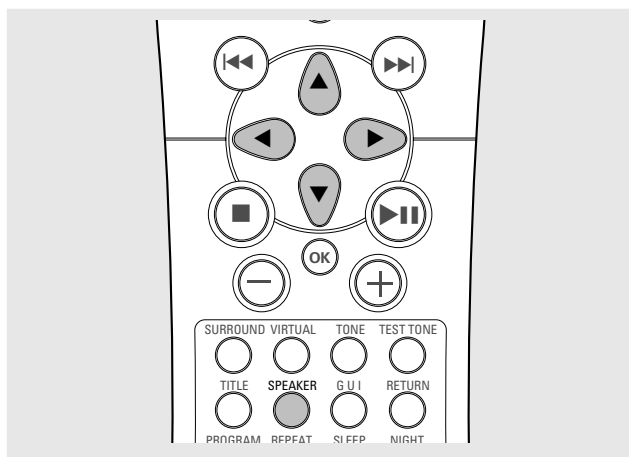

Changing the speaker size

If you are using the speakers provided in your DVD Digital Home Cinema System, the speaker size defaults are correct. If you are using other speakers, follow these steps.

- 1 Switch on to DVD/CD mode.
- 2 Press **SPEAKER**.
→ "SP SIZE" appears.
- 3 Press ► to confirm.
- 4 Press ▲ or ▼ repeatedly to select a different speaker (if necessary) and followed by ► to confirm.
 - "FRONT" – front speakers.
 - "CENTER" – center speaker.
 - "SURR" – surround speakers.
 - "SUB-WF" – subwoofer.
- 5 Press ▲ or ▼ to change the speaker's setting (if necessary).
 - front speakers
"F-LARGE" or "F-SMALL"
 - center speaker
"C-SMALL" or "C-LARGE" or "C-NONE"
 - surround speakers
"S-SMALL" or "S-LARGE" or "S-NONE"
 - subwoofer
"SW-YES" or "SW-NO"
- 6 Press ► to confirm.
- 7 Repeat **step 4-6** for other settings.
- 8 Press **SPEAKER** again to exit.

Notes:

- If the cone size (diameter) of the speaker is larger than five inches, select **LARGE**.
- If the front speaker is set to **F-SMALL**, the subwoofer cannot be set to **SW-NO**.

Changing the speaker distance

When you have arranged your home cinema (speakers, receiver, and components), you can change the speaker distance entered in the DVD system's memory. The default setting is 10 feet.

- 1 Switch on to DVD/CD mode.
- 2 Press **SPEAKER**.
- 3 Press ▲ **twice**.
→ "SP DIST" appears.
- 4 Press ► to confirm.
- 5 Press ▲ or ▼ repeatedly to select a different speaker (if necessary) and ► to confirm.
 - "FRONT" – front speakers.
 - "CENTER" – center speaker.
 - "SURR" – surround speakers.
- 6 Press ► to confirm.
- 7 To change the distance between the listening position and the speakers, press ▲ or ▼ repeatedly until you reach the desired distance (□ to □) and press ► to confirm.
- 8 Repeat **steps 5-7** for other settings.
- 9 Press **SPEAKER** again to exit.

Changing the channel level

You can change the speakers' sound distribution to suit your surround sound needs. For example, if you are close to the left front speaker than the right front speaker, the left front speaker might seem "louder" than the right one. To adjust it, you must change the channel level for one or both speakers until the sound evens out.

- 1 Switch on to DVD/CD mode.
- 2 Press **SPEAKER**, followed by ▲ on the remote control.
→ "CH LEVEL" appears.
- 3 Press ► to confirm.
- 4 Press ▲ or ▼ repeatedly to select a different speaker (if necessary) and ► to confirm.
 - "FL LEVEL" – front left speaker's level.
 - "C LEVEL" – center speaker's level.
 - "FR LEVEL" – front right speaker's level.
 - "SR LEVEL" – right surround speaker's level.
 - "SL LEVEL" – left surround speaker's level.
 - "SW LEVEL" – subwoofer's level.
- 5 Press ▲ or ▼ repeatedly until you reach the desired level (- 10 to + 10) and press ► to confirm.
- 6 Repeat **steps 4-5** for other settings.
- 7 Press **SPEAKER** again to exit.

Test Tone

This feature enables you to check the sound level of the respective front left/right, center and surround speakers in any mode except stereo mode.

You must sit at the ideal sitting position to perform this operation.

- 1 Press **POWER** to switch on the system.
- 2 Press **TEST TONE**.
 - A test signal is generated. It will move through the left, center, right, and surround speakers.
 - The test signal will last for about 2-3 seconds.

Changing system settings-special circumstances

To ensure proper recording quality when you make a copy of a DVD/CD via analog output, set the speaker size to **F-LARGE** and set the surround mode to **STEREO**.

Selecting TV aspect

Select the appropriate screen type according to your TV set. Conventional size screens use a 4:3 aspect ratio, and wide-screens use a 16:9 ratio.

- 1 Press **SYSTEM MENU**.
- 2 At the setup menu, press ▲ or ▼ to select "TV DISPLAY" then press **OK**.
- 3 Press **OK** repeatedly to select the desired aspect, then press **SYSTEM MENU**.

16:9 WIDE (Widescreen)

– If you have a widescreen TV set, use this setting. The DVD plays in full size. (You must also set your widescreen TV to "full size").



4:3 LB (Letterbox)

– If you have a conventional TV set and your DVD is formatted for widescreen viewing, use this setting. A wide picture with bands is displayed on the upper and lower portions of the TV screen.



4:3 PS (Pan and Scan)

– If you have a conventional TV set and your DVD is not formatted for widescreen viewing, use this setting. A wide picture is displayed on the whole TV screen with a portion automatically cut off.

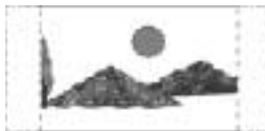

Note:

– If your DVD is not encoded to allow you to change the aspect ratio, TV DISPLAY cannot be changed.

Selecting digital audio out

Each DVD has a variety of audio output options. If you connected a device to the player's digital optical jacks (refer to "Connecting a Digital (Optical) audio device"), you might have to change the digital audio output setting. Set the player's Digital Audio Output to the type of audio system you use.

CAUTION!

If an active digital audio output signal is supplied to a DVD system or other equipment without a corresponding digital decoding capability, a very loud noise might be produced which could permanently damage your speakers.

- 1 Press **SYSTEM MENU**.
- 2 At the setup menu, press ▲ or ▼ to select "DIGITAL OUT".
- 3 Press **OK** repeatedly to select the desired output (PCM or BITSTREAM), then press **SYSTEM MENU**.

BITSTREAM

– To play DVDs, the digital audio output must be set to **BITSTREAM** for the DVD to use Dolby Digital or DTS modes.

PCM

– To record audio from the player to an MD player or other equipment (refer to "Recording Audio from the Receiver to Digital Audio Equipment") set the digital audio output to **PCM**.

Note:

– To play audio CDs, you do not have to change **BITSTREAM** to **PCM**. The player makes the switch automatically.

Selecting a satellite receiver or cable box

Make sure you made the correct connections (refer to "Connecting a Satellite Receiver or Cable Box").

- To use a satellite receiver that has analog audio output, press **SAT**.
 - "SAT" appears.
- To use a satellite receiver that has digital audio output, press **SAT** twice.
 - "SAT-- OPT" appears.

Note:

– You cannot use **SAT-OPT** if you do not have digital audio output. If you adjust **SOURCE** to select "SAT-OPT" and you do not have digital audio output, "OPT" flashes.

Selecting the source

- Adjust the **SOURCE** button (or press **DVD/CD, TV/AV, TUNER, CDR, AUX, SAT** or **VCR**) to select the input source.
→ The selected source will be displayed.

Volume control

Adjust **VOLUME** button (or press **+ / -**) to increase or decrease the volume level.

To use the volume control to adjust Philips TV's volume level, press **TV** on the remote control to select TV mode first.

To listen through the headphones

- Connect the headphones plug to the **PHONES** socket at the front of the player.
→ The speakers will be muted.

To switch off the volume temporarily

- Press **MUTE**.
→ "MUTE" icon appears.
- To restore the volume, press **MUTE** again.

Adjusting the tone

The tone controls only affect the front left and right speakers.

- 1 Press **TONE** repeatedly to select Bass or Treble adjustment.
- 2 While in Bass or Treble adjustment mode, adjust **VOLUME** knob to adjust the selected Bass or Treble level.

Note:

– *If no button is pressed within a few seconds, the player will exit the tone mode automatically.*

Dimming the display screen

- Press **DIM** to switch the dim mode on or off.

Selecting the surround sound mode

IMPORTANT!

– **For proper surround sound, make sure you have followed the "Connections" and "Preparations" procedure fully.**

– **The center and surround speakers only operate when the unit is set to a surround sound mode and the source material being played is recorded or broadcast in Dolby Digital, DTS or Dolby Pro Logic surround sound.**

– **Stereo broadcasts or recordings will produce some surround channel effects when played in a surround mode. However, monaural sources will not produce any sound from the surround speakers.**

- Press **SURROUND ON/OFF** repeatedly to select surround or stereo mode.
→ The availability of the various surround sound modes depend on the number of speakers used and the incoming sound information available on the disc. The available output modes are shown below.

Dolby Digital Surround

Dolby Digital (also known as AC-3 or Dolby 5.1) and MPEG Multichannel delivers a realistic and dynamic sound similar to theater and cinema. It requires connection of all five speakers (front left/right, center, surround left/right) and subwoofer for correct Dolby Digital Surround sound reproduction. Each channel plays its own unique role in providing the right sound. Front left, center and right join two surround speakers to reproduce high, mid and bass frequencies in five full-range channels of surround. Bass rumble, explosions and low frequency effects you feel are delivered through the subwoofer. A large number of DVD discs have been recorded in Dolby Digital Surround.

DTS Surround

The DTS Surround is a cinema surround sound format that offers superior digital audio performance. DTS offers more clarity and definition especially for higher tones. The better sound quality is a result of the limited sound compression (3:1 instead of 11:1 for Dolby Digital) and the 20-bit resolution.

Dolby Pro Logic Surround

The Dolby Pro Logic Surround system is a specially encoded two-channel analog format that will produce sound through four speaker channels (front left, center, front right, monaural surround) when a Dolby Pro Logic Decoder is used. It is also compatible with stereo systems but the user will only have two-channel (front left & right) of sound.

Stereo

All sound is reproduced and played through the front left and right speakers. This enables standard stereo reproduction.

Selecting the virtual sound effect

The virtual sound effects allow you to select from various pre-set modes that control the frequency bands of sound to optimize certain musical styles. It greatly enhances the excitement and enjoyment of your favorite music.

- Press **VIRTUAL** repeatedly to select the available sound effects.

STADIUM

This mode recreates a large stadium effect using very long reverberation times.

HALL

The surround effect recreates a hall using lots of reflections suitable for orchestral music such as classical and opera.

THEATER

This effect recreates a theater environment, emphasizing sound from the front speakers.

Note:

– *Selecting the virtual sound effect is only possible if the source materials are recorded or broadcast in Dolby Pro Logic or stereo mode, see your disc case for details.*

Night mode (for discs with Dolby Digital mode only)

Set night mode to on to level out the volume. For example, the disc will play at the same sound level throughout the movie.

- Press **NIGHT** to switch the Night mode on or off.

Note:

– *Night Mode is not available for movies using DTS mode.*

Sleep timer setting

The sleep timer enables the system to switch to standby mode automatically at a preset time.

- 1 Press **SLEEP** repeatedly to select a preset time.
 - The selections are as follows (time in minutes):
10 → 20 → 30... → 80 → 90
 - "SLEEP XX" appears. "XX" is the time in minutes.
- 2 When you reach the desired length of time, stop pressing the **SLEEP** button.
 - "SLEEP" icon appears.

To check the remaining length of time after sleep timer is activated

- Press **SLEEP** once.

To change the preset sleep timer

- Press **SLEEP** again while the remaining sleep timer is shown.
 - The display will show the next sleep timer options.

To deactivate the sleep timer

- Press **SLEEP** repeatedly until "SLEEP" icon disappears.

Discs information

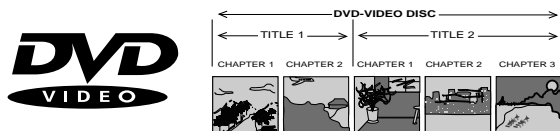

- DVD video discs may have one or more Titles, and each Title may have one or more Chapters.
- Playback stops at the end of each Title.



- Audio CDs contain only Tracks.

Basic playback

CAUTION!

- Do not move the disc player during playback, as doing so might damage the DVD system.
- Do not push on the disc tray or put any objects other than disc on the disc tray. Doing so may cause the disc player malfunction.

- 1 Press **POWER** to switch the system on.
- 2 Adjust **SOURCE** (or press **DVD/CD** on the remote control) to select DVD/CD.
- 3 Press one of the **OPEN ▲** to open the desired disc tray.
- 4 Load a disc with the label side facing up.
- 5 Press again the corresponding **OPEN ▲** button to close the disc tray.
 - There will be a short delay while the player identifies the disc and reads the menu from the disc.
 - The selected disc's number begins to flash.
- Some discs will start playing automatically, while others will display the Disc Contents Menu on the TV screen. If the menu is presented, use **▲▼◀▶** keys to highlight your selection and press **OK** to confirm or **numeric keypad (0-9)** to select a play option.
- 6 Press **▶ (▶▶)** to start playback.

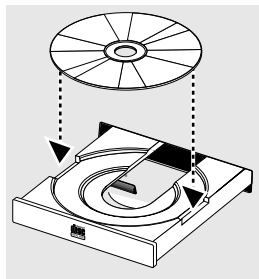

Notes:

- If you leave the disc tray open for more than 8 minutes, the disc tray automatically closes.
- Your player will not play discs that have a region code different from the region code of your player.
- When the inhibit icon (X) appears on the TV screen when a button is pressed, it means the function is not available on the disc you are playing.

To interrupt playback

- Press **▶ (▶▶)**.
 - The picture freezes and the sound will be muted.
- To resume playback, press **▶ (▶▶)** again.

To stop playback

- Press **■**.

To select a another disc

- Press **DISC SKIP** (or **DVD/CD**) until the desired disc loads.
 - The current selected disc's number and "LOADING" begin to flash.
 - If a disc has loaded, it automatically plays.

Playing an MP3 disc

Playing an MP3 disc is only possible within an album.

- 1 Load an MP3 disc.
 - The MP3 menu is displayed on the TV screen.
- 2 To select a desired album, press **◀/▶, ▲/▼** button, followed by **▶ (▶▶)** or **OK**.
 - On the player display screen, "FOLDER XX" is displayed.
- 3 To select a desired title, press **◀/▶, ▲/▼** button.
 - On the player display screen, "FILE XXX" is displayed.
- To return to the previous menu, press **■**, followed by **◀/▶, ▲/▼** button.
- 4 To start playback, press **▶ (▶▶)**.
 - The disc will stop playing after completing the playback of all the titles in the selected album.
- To play the next or previous title during playback, press **◀◀** or **▶▶** button.
- You can also select the desired album/title number directly using the **numeric keypad (0-9)**.
 - In stop mode, numbers are used for album selection.
 - In play mode, numbers are used for title selection.

Notes:

- When the system does not read a file, "?" will be displayed.
- It is not possible to create a program with MP3 tracks from multiple CDs, or combined with normal audio tracks.

General features

Skipping to another track/chapter

- Press **⏮** or **⏭** repeatedly during playback to skip backward or forward. Each press will take the disc to the beginning of the previous or next track/chapter.

Note:

- If the **REPEAT** function has been set, pressing **⏮** or **⏭** will replay the same track/chapter.

To skip to the beginning of the current track/chapter during playback

- Press **⏮** **once**.

To go directly to any track/chapter

- Use the **numeric keypad (0-9)** to enter the number of the desired track/chapter.

Fast Search

- 1 Hold down **⏮** or **⏭** about **two seconds** to fast reverse or forward the disc. The available speeds are as follows :

MP3-CD	: x2 → x4 → x8 → x16
CD	: x2 → x4 → x8

- 2 To resume normal play, press **▶** (**▶||**).

Continue playback from the last stop point

- 1 Press **■** **once** will go into "Resume Stop" mode. The disc can resume playback from the point at which it stopped when you press **▶** (**▶||**).
→ "RESUME" appears.
- 2 To stop playback completely, press **■** again.

Notes:

- When the player is disconnected from the power supply or the disc tray is opened, the resume option will be cancelled automatically.
- The resume option may not be available on some discs.

Repeat play

For CD - Repeat track/disc(s)

- 1 Press **REPEAT** repeatedly to select the following :
→ **⏮** – to repeat playback of the current track.
→ **⏮** **ALL** – to repeat playback of the current disc.
→ **⏮** **ALL DISC** – to repeat playback of all three discs.
- 2 To return to normal play, press **REPEAT** until **⏮** disappears from the display.
- For MP3-CD, it can only repeat the current track or the album.

Notes:

- To use **⏮** **DISC ALL** (repeat all discs), you must have a disc in all three trays . Otherwise, it will stop when reaching an empty tray.
- When **⏮** (repeat one) is activated, you cannot skip to another track by pressing **⏮** or **⏭**. You must either exit Repeat mode or use the numeric keypad to enter the desired track number.

For DVD - Repeat chapter/title

- 1 Press **REPEAT** repeatedly during playback to select :
→ **CHAPTER REPEAT** – to repeat playback of the current chapter: **CHAP** icon flashes.
→ **TITLE REPEAT** – to repeat playback of the current title. **TITLE** icon flashes.
- 2 To return to normal play, press **REPEAT** until "REPEAT OFF" appears.

Note:

- Repeat play might not work correctly with some DVDs.

Program favorite tracks (CD)

You can program up to 32 tracks for playback in any desired order. **This function only operates with audio CDs (not DVDs).**

- 1 Load the desired discs on the disc trays (refer to "Basic playback").
- 2 Press **PROGRAM**.
→ "PROG" icon start flashing.
- 3 Press **DISC SKIP** (or **DVD/CD**) repeatedly to select the desired disc (if necessary).
→ The disc number appears.
- 4 Use the **numeric keypad (0-9)** to select the desired track number.
→ If you attempt to program more than 32 tracks, "P-FULL" is displayed.
- 5 Press **OK** on the remote control to store the track.
- Repeat **steps 3-5** to store other tracks.
- 6 To end programming, press **■** **once**.
→ "PROG" icon stays and the program mode remains active.
- 7 To start program play, press **▶** (**▶||**).

Exit the program mode temporarily

- In stop mode, press **■** and followed by **PROGRAM**.
→ "P-FFF" appears.
- To return to the programming mode, press **PROGRAM** again.

Reviewing the program

- Stop playback and press **▲** or **▼** repeatedly.
- To exit review mode, press **■**.

Clearing the entire program

- In stop mode, press **■** twice.
→ "P-CLEAR" appears.

Modifying the program

- 1 In program mode, press **■** twice.
- 2 Press **▲** or **▼** repeatedly to select the desired programmed track.

To clear the track

- Press and hold **■**.

To change the track under another track number

- Use the **numeric keypad (0-9)** to enter the desired track number, then press **OK**.

To add a track

- 1 Press **▲** repeatedly until you reach the empty programmed track.
- 2 Use the **numeric keypad (0-9)** to enter the number of the desired track, then press **OK**.

To change the programmed track in other disc

- 1 Press **DISC SKIP** (or **DVD/CD**) repeatedly to select the desired disc.
- 2 Use the **numeric keypad (0-9)** to enter the number of the desired track, then press **OK**.

Notes:

- You cannot modify the programming in Resume mode.
- The programmed contents are lost if you turn off the DVD system or change the function to TUNER.

Special DVD features

IMPORTANT!

Some operations may be different or restricted, depending on the disc format. Refer to the jacket or case of the disc you are playing.

Advancing by playback

- 1 In pause mode, press **PAUSE II** on the system will show the next frame of the picture.
→ Each time you press the button, the picture advances one frame.
- 2 To resume normal play, press **▶ (▶II)**.

Searching for a particular passage

- 1 Hold down **◀◀** or **▶▶** for more than **two seconds** to fast reverse or forward the disc. There are four scan speeds (2x, 4x, 16x or 100x). Each press will increase the speed.
- 2 To resume normal play, press **▶ (▶II)**.

Playing in slow motion mode

- 1 Press **SLOW MOTION + / -** repeatedly to select the speed and direction for slow playback.

To decrease the playback speed

- Press **SLOW MOTION +** repeatedly to select between : 1/2x, 1/4x or 1/8x.

To reverse the playback direction

- Press **SLOW MOTION -**.
- 2 To resume normal play, press **▶ (▶II)**.

Notes:

- The player sound will be muted during slow-motion, high-speed-reverse, or high-speed-forward of DVDs.
- Subtitles do not appear on the screen during scan playback higher than 2x, reverse scan, or reverse slow motion.

Zooming in

Zoom allows you to zoom in and enlarge the picture on the screen to either 4 times (4x) or 16 times (16x) its normal size.

- 1 Press **ZOOM** during normal or still playback.
- 2 To resume normal size, press **ZOOM** to cancel the zoom feature and resume normal playback or still playback.

Notes:

- Some DVD might not respond to zoom.
- Zoom does not work on subtitles or menus included on DVD video discs.

Viewing from another angle

If the disc contains sequences recorded from different camera angles, this allows you to view the picture from different angles.

- Press **ANGLE** repeatedly during playback until the desired angle is selected.
→ Playback changes to the selected angle.

Changing subtitle language

This operation works only on DVDs with multiple subtitle languages.

- Press **SUBTITLE** repeatedly during playback until the desired language is selected.
→ When no subtitles are recorded, "OFF" appears instead of the language number.
- To eliminate the subtitles, press **SUBTITLE** repeatedly and select "OFF".

Changing sound track language

This operation works only on DVDs with multiple soundtrack language.

- Press **AUDIO** repeatedly during playback until the desired language is selected.

Notes:

- When the desired language for Subtitle or Audio is not selected even after pressing the button several times, it means the language is not available on the disc.
- When the power is turned off or the DVD is completely stopped, the Subtitle or Audio language reverts to the DVD's default setting.

Title menu

Some DVDs may contain two or more titles. If the disc has a title menu recorded on it, you can start playback from the selected movie title.

- 1 Press **TITLE**.
→ A list of the DVD's titles appears.
- 2 Press ◀/▶, ▲/▼ or use the **numeric keypad (0-9)** to select the desired title, followed by ▶ (▶II) or **OK**.
→ The selected title starts playing.

Notes:

- The details of operation might differ depending on the DVD disc.
- Selecting a title might not be possible on certain DVD discs.

DVD menu

Some DVDs have unique DVD menus. For example, DVDs programmed with complex contents provide guide menus, and those recorded with various languages provide menus for audio and subtitle language.

The DVD menu's contents and operation differ from disc to disc. The following procedure explains the basic operation when this feature is used.

- 1 Press **DISC MENU** during playback.
→ The DVD menu available on the disc appears.
- To resume play from the scene when DISC MENU was first pressed, press **RETURN**.
- 2 Press ◀/▶, ▲/▼ or use the **numeric keypad (0-9)** to select the desired scene, followed by ▶ (▶II) or **OK**.
→ The selected scene starts playing.

Advanced features (DVD)

For the advanced features, the player screen does not change. The displays appear on your television.

Using Graphic User Interface (GUI) menu icons

GUI menu icon shows disc information (for example, title or chapter number; elapsed playing time, audio/subtitle language, angle) and player information (for example, repeat play, play mode). A number of operations can be done with the GUI menu without interrupting disc playback.

All GUI functions are only available through your remote control. You cannot use the player to access GUI menu.

- 1 Press **GUI** during playback.
→ The GUI menu icons will be displayed across the top of the TV screen.
- 2 Press the ◀ or ▶ to select the desired item.
→ The currently selected item is highlighted.

Note:

- Some DVDs might not provide all of the below GUI menu icons.

Title

Use the **numeric keypad** to select the desired title's number; then press **OK**.



1

Chapter

Use the **numeric keypad** to select the desired chapter's number; then press **OK**.



3

Time search

Use the **numeric keypad** to key in the desired time in the movie, then press **OK**.



0:00:00

Language

Press **AUDIO** repeatedly to change the sound track language, then press **OK** to select.



Subtitle

Press **SUBTITLE** repeatedly to change the subtitle languages, then press **OK** to select.



OFF

Angle

Press **ANGLE** repeatedly to change the angle's number; then press **OK** to select.



Parental control (DVD)

Setting a rating level and password

You can prohibit the playing of specified DVDs which are unsuitable for children. Some DVD discs contain a restriction level which enables parents to remove scenes or prevent playback of discs by children. Your DVD player has password device designed to prevent children from changing the level.

Selecting a rating level

Your DVD player has eight rating settings. Level **1** provides the strictest viewing restrictions.

Note:

– If your DVD is not encoded with a rating, the Rating Level feature does not work.

- 1 Press **SYSTEM MENU**.
- 2 At the setup menu, press **▲** or **▼** to select "RATING", then press **OK**.

Note:

– The password is preset to 1234. The rating is preset to UNLOCK.

- 3 Enter a password and press **OK**.
- 4 Press **OK** repeatedly to select the desired level.
- You cannot play DVD video discs rated higher than the level you selected unless you cancel the parental lock function. For example, when you select level 7, discs rated higher than level 7 are blocked and cannot be played.
- 5 Press **SYSTEM MENU** to exit.

IMPORTANT!

Some DVDs may prompt you for a password if they have a higher rating than the level you set. If you get this prompt, enter your password. For DVDs that do not have the prompt display "PARENTAL VIOLATION", you have to reset the rating level to a higher level before you can play the desired DVD (refer to "Selecting a rating level").

Notes:

- Some DVD discs are not encoded with a rating though the movie rating is printed on the disc case. The rating level feature does not work for such discs.
- If you change the level and enter a password, playback of all DVDs with a rating higher than your selection will be blocked unless you enter the correct password again. For example: if you change the level to 5, the DVD player will not play discs with ratings of 6, 7, or 8 unless the correct password is entered from the remote control.

Setting a password

- 1 Press **SYSTEM MENU**.
- 2 At the setup menu, press **▼** to select "PASSWORD", then press **OK**.
- 3 Key in a 4-digit password into "OLD" (for example, 1234).
- 4 Key in a new 4-digit password into "NEW", then press **OK**.

IMPORTANT!

- Do not forget your password.
- To log in the password, you have to reset the player by switching off and on again.

Clearing the password

- 1 At the setup menu, press **▼** to select "RATING", then press **OK**.
- 2 Enter the default password (**2580**), then press **OK**.
→ Your 4-digit password is cleared.

IMPORTANT!

Do not use "2580" as user's password because it is the the manufacturer's default code for returning to initial setting.

Tuning to radio stations

- 1 Press **POWER** to switch on the last selected source.
- 2 Adjust **SOURCE** (or press **TUNER** on the remote control) to select the desired band : FM or AM.
→ If an FM station is received in stereo, "STEREO" icon appears.
- 3 If necessary, press **TUNING•PRESET** to switch on tuning mode.
- 4 Press and hold **◀◀** or **▶▶** until the frequency indication starts to change, then release.
→ The system automatically tunes to the next strong radio station.
- To tune to a weak station, press **◀◀** or **▶▶** briefly and repeatedly until optimal reception is found.
- 5 Repeat **step 4** if necessary until you find the desired radio station.

Presetting radio stations

You can preset up to 30 AM and 30 FM stations regardless of the reception. Tune in the desired stations using automatic or manual tuning.

Manual Preset

- 1 Tune to your desired radio station (refer to "Tuning to radio stations").
- 2 Press **PROGRAM**.
→ "PROG" icon starts flashing.
→ The next available preset number is displayed for selection.

To store the radio station to another preset number

- While "PROG" icon is flashing, press **◀◀** or **▶▶** (**◀ / ▶** on the remote control) to select the desired preset number.

Note:

– If "PROG" icon goes off before you select the desired preset number, press **PROGRAM** again.

- 3 Press **PROGRAM** again to store the radio station.
→ "PROG" icon stops flashing.
- Repeat **steps 1–3** to store other radio stations.

Automatic Preset

- 1 Adjust **SOURCE** (or **TUNER** on the remote control) again to select the desired band : FM or AM.

To begin automatic preset from a desired preset number

- Press **TUNING•PRESET** to switch on preset mode and followed by **◀◀** or **▶▶** (**◀ / ▶** on the remote control) to select the desired preset number.
- 2 Hold down **PROGRAM** until the "PRESET" icon flashes.
→ All available radio stations with sufficient signal strength will be stored automatically.
→ It will stop automatically when all the available radio stations are stored or the memory for 30 presets is used.
- To store stations on the other band, repeat **steps 1-2**.

To stop storing the automatic preset

- Press **PROGRAM** again.

Notes:

- If no preset number is selected, automatic preset will begin from preset (1) and all your former presets will be overridden.
- During programming, if no key is pressed within five seconds, the system will exit the program mode automatically.

Listening to preset radio stations

- In tuner mode, press **TUNING•PRESET** to switch on preset mode and followed by **◀◀** or **▶▶** (**◀ / ▶** or **numeric keypad 0-9** on the remote control) to select the desired preset number.
→ The preset number, radio frequency, and waveband are displayed.

AMPLIFIER SECTION

Output power (6Ω, 1 kHz, 10% THD, 100W)	
- Stereo (Front left/right)	2 x 100 W / 2 x 90 W FTC
Output power (6Ω, 1 kHz, 10% THD, 100W)	
- Front left/right	2 x 100 W
- Center	100 W
- Surround left/right	2 x 100 W
- Subwoofer	100 W
Total Harmonic Distortion	10% at rated power 100W (1 kHz)
Signal-to-Noise Ratio	
- Stereo-TV	> 67 dB (IHF-A)
- Surround front/center/rear	> 65 dB (IHF-A, -20 dB FS)
Frequency Response	10 Hz – 20 kHz, –3 dB/+1 dB
Tone Control	±10 dB
Input Sensitivity	450 mV / 47 Kohm
Output level	420 mV / 1 Kohm
Cross-talk (separation)	
- Stereo-TV (line)	> 55 dB
- Dolby Digital	> 45 dB

TUNER SECTION

Tuning Range	FM 87.5 – 108 MHz (100 kHz steps)
	AM 530 – 1700 kHz (10 kHz steps)
26 dB Quieting Sensitivity	FM < 22 dBf
	AM < 3250 μV/m
Harmonic Distortion (15 kHz LPF on)	FM Mono < 3%
	FM Stereo < 2%
Signal-to-Noise Ratio	FM Mono > 60 dB
	FM Stereo > 60 dB
	AM > 40 dB
Frequency Response	FM 20 Hz – 15 kHz, –3 dB
Selectivity	AM > 25 dB

DVD SECTION

Laser Type	Semiconductor
Disc Diameter	12cm / 8cm
Video Decoding	MPEG-2
Video DAC	10 Bits
Video Format	4:3 / 16:9
Video S/N	> 45 dB (minimum)
Input sensitivity	1.0Vpp / 75 Ω
Output level	1.0Vpp / 75 Ω
S-Video Output	Y - 1.0 V (p-p), 75 Ω
	C - 286 mVp-p, 75 Ω
Frequency Response	20 Hz – 20 kHz (44.1 kHz)
	20 Hz – 22 kHz (48 kHz)
	20 Hz – 44 kHz (96 kHz)

MISCELLANEOUS

Power Supply Rating	120V / 60 Hz
Power Consumption	3.4 A
Dimensions (w x h x d)	430 mm x 140 mm x 400 mm
Weight	16.7 kg

IR REMOTE CONTROL

Effective Range	> 8 Meter
Number of Keys	51
Battery (1.5V)	AA x 2

SPEAKERS (front / center / surround)

Front Speakers	
System	3-way shielded
Impedance	6 Ω
Speaker drivers	3" woofer, 1.75" tweeter
Dimensions (w x h x d)	94 mm x 155 mm x 88 mm
Weight	0.45 kg

SUBWOOFER

Subwoofer (not magnetically shielded design)	6.5"
Output power	100 W (6 Ω, DIN)
THD	10% at 55 Hz
Reproduction frequency response	35 Hz – 150 Hz
Dimensions (w x h x d)	200 mm x 310 mm x 370 mm
Weight	7 kg

Specifications subject to change without prior notice

Troubleshooting

WARNING

Under no circumstances should you try to repair the system yourself, as this will invalidate the warranty. Do not open the system as there is a risk of electric shock.

If a fault occurs, first check the points listed below before taking the system for repair. If you are unable to solve a problem by following these hints, consult your dealer or service center.

Problem	Solution
No power.	<ul style="list-style-type: none">– Check if the AC power cord is properly connected.
No picture.	<ul style="list-style-type: none">– Select the appropriate video input mode on the TV.– Check if the TV is switched on.– Check the video connection.
Distorted or poor picture.	<ul style="list-style-type: none">– Sometimes a small amount of picture distortion may appear. This is not a malfunction.– Clean the disc.
The DVD player does not start playback.	<ul style="list-style-type: none">– Insert a readable disc with the playback side facing down.– Check the disc type, color system and regional code. Check for any scratches or smudges on the disc.– Press SYSTEM MENU to turn off the setup menu screen.– Cancel the parental control rating function or change the rating level.– Moisture has condensed inside the system. Remove the disc and leave the system turned on for about an hour.
The remote control does not work properly.	<ul style="list-style-type: none">– Point the remote control at the remote sensor of the unit.– Reduce the distance to the player.– Remove any possible obstacles.– Replace the batteries with new ones.
The DVD system does not respond when the buttons are pressed.	<ul style="list-style-type: none">– Disconnect the power plug from the outlet, and insert again.
No sound or distorted sound.	<ul style="list-style-type: none">– Adjust the volume.– Check that the speakers are connected correctly.
No image is output when a function is selected.	<ul style="list-style-type: none">– Make sure the component is connected correctly.– Press the correct function button for the input source.
Considerable noise in radio broadcasts.	<ul style="list-style-type: none">– Tune in the correct frequency.– Connect the antenna.– Route RF (AC-3) and digital cables away from the antenna terminals and wires.– Fully extend the FM wire antenna. Position for best reception and secure to a wall.– Connect an outdoor FM or AM antenna.– Adjust the direction and position for best reception.– Turn off the equipment causing the noise or move it away from the DVD system.– Place the antenna farther away from the equipment causing the noise.
Broadcast station cannot be selected automatically.	<ul style="list-style-type: none">– The signal is weak. Connect an outdoor antenna.
The display is dark.	<ul style="list-style-type: none">– Press DIM again.
Low hum or buzz sound.	<ul style="list-style-type: none">– Place the DVD system as far away as possible from electric devices with interference.
Sound is only heard from one channel.	<ul style="list-style-type: none">– Connect the input cords securely.– Adjust the channel level.
Sound cuts off or there is no sound even though power is on.	<ul style="list-style-type: none">– After turning off the power and then turning it on again, reduce the volume or change to the correct 6-ohm speakers.
Low bass response.	<ul style="list-style-type: none">– Check all speakers for correct polarity.
No sound from the surround speakers.	<ul style="list-style-type: none">– Set the mode to the desired surround mode position.– Use surround mode.– Check all surround wires for good connection.
No sound from the center speaker.	<ul style="list-style-type: none">– Set surround mode to DTS, DOLBY DIGITAL, or DOLBY PRO LOGIC.
The disc tray cannot open.	<ul style="list-style-type: none">– Hold down PROGRAM button until "TRAY LOCKED?" appears on the display, then hold down PLAY button for more than two seconds.

LIMITED WARRANTY

AUDIO SYSTEM

One Year Free Labor

One Year Free Service on Parts

This product must be carried in for repair.

WHO IS COVERED?

You must have proof of purchase to receive warranty service. A sales receipt or other document showing that you purchased the product is considered proof of purchase.

WHAT IS COVERED?

Warranty coverage begins the day you buy your product. *For one year thereafter*, all parts will be repaired or replaced, and labor is free.

After one year from the day of purchase, you pay for the replacement or repair of all parts, and for all labor charges.

All parts, including repaired and replaced parts, are covered only for the original warranty period. When the warranty on the product expires, the warranty on all replaced and repaired parts also expires.

WHAT IS EXCLUDED?

Your warranty does not cover:

- labor charges for installation or setup of the product, adjustment of customer controls on the product, and installation or repair of antenna systems outside of the product.
- product repair and/or part replacement because of misuse, accident, unauthorized repair or other cause not within the control of Philips Consumer Electronics Company.
- reception problems caused by signal conditions or cable or antenna systems outside the unit.
- a product that requires modification or adaptation to enable it to operate in any country other than the country for which it was designed, manufactured, approved and/or authorized, or repair of products damaged by these modifications.
- incidental or consequential damages resulting from the product. (Some states do not allow the exclusion of incidental or consequential damages, so the above exclusion may not apply to you. This includes, but is not limited to, prerecorded material, whether copyrighted or not copyrighted.)
- a product that is used for commercial or institutional purposes.

WHERE IS SERVICE AVAILABLE?

Warranty service is available in all countries where the product is officially distributed by Philips Consumer Electronics Company. In countries where Philips Consumer Electronics Company does not distribute the product, the local Philips service organization will attempt to provide service (although there may be a delay if the appropriate spare parts and technical manual(s) are not readily available).

MAKE SURE YOU KEEP...

Please keep your sales receipt or other document showing proof of purchase. Attach it to this owner's manual and keep both nearby. Also keep the original box and packing material in case you need to return your product.

BEFORE REQUESTING SERVICE...

Please check your owner's manual before requesting service. Adjustments of the controls discussed there may save you a service call.

TO GET WARRANTY SERVICE IN U.S.A., PUERTO RICO OR U.S. VIRGIN ISLANDS...

Take the product to a Philips factory service center (see enclosed list) or authorized service center for repair. When the product has been repaired, you must pick up the unit at the center. Centers may keep defective parts.

(In U.S.A., Puerto Rico and U.S. Virgin Islands, all implied warranties, including implied warranties of merchantability and fitness for a particular purpose, are limited in duration to the duration of this express warranty. But, because some states do not allow limitations on how long an implied warranty may last, this limitation may not apply to you.)

TO GET WARRANTY SERVICE IN CANADA...

Please contact Philips at:

1-800-661-6162 (French Speaking)

1-800-363 7278 (English Speaking)

(In Canada, this warranty is given in lieu of all other warranties. No other warranties are expressed or implied, including any implied warranties of merchantability or fitness for a particular purpose. Philips is not liable under any circumstances for any direct, indirect, special, incidental or consequential damages, howsoever incurred, even if notified of the possibility of such damages.)

REMEMBER...

Please record the model and serial numbers found on the product below. Also, please fill out and mail your warranty registration card promptly. It will be easier for us to notify you if necessary.

MODEL # _____

SERIAL # _____

This warranty gives you specific legal rights. You may have other rights which vary from state/province to state/province.

Philips Service Solutions Group, P.O. Box 2976, Longview, Texas 75606, USA, (903) 242-4800

EL4965E006 / MAC 4110 / 12-98

Free Manuals Download Website

<http://myh66.com>

<http://usermanuals.us>

<http://www.somanuals.com>

<http://www.4manuals.cc>

<http://www.manual-lib.com>

<http://www.404manual.com>

<http://www.luxmanual.com>

<http://aubethermostatmanual.com>

Golf course search by state

<http://golfingnear.com>

Email search by domain

<http://emailbydomain.com>

Auto manuals search

<http://auto.somanuals.com>

TV manuals search

<http://tv.somanuals.com>