

SERVICE MANUAL

ADDITIONAL INFORMATION

CASSETTE CAR STEREO

KP-151 E

CASSETTE CAR STEREO

KP-212 E

CASSETTE CAR STEREO WITH FM-STEREO

KP-250 ZE

CASSETTE CAR STEREO WITH AM/FM-STEREO

KP-4000 G

CASSETTE CAR STEREO WITH AM/FM-STEREO

KP-4000A ZE
ZEB

CASSETTE CAR STEREO WITH LW/MW/FM-STEREO

KP-4300A ZE
ZEB

CASSETTE CAR STEREO WITH MW RADIO

KP-410A ZE

CASSETTE CAR STEREO WITH LW/MW

KP-4400A ZE

CASSETTE CAR STEREO WITH SW1/SW2/FM

KP-4900A SE

CASSETTE CAR STEREO

08118-65707

CASSETTE CAR STEREO WITH FM-STEREO

08118-65708

Subject:

Cassette Mechanism Assembly has been changed to improve cassette insertion.
The white name plate is changed to light blue for the models employing this new Cassette Mechanism Assembly. Use this manual together with the original manuals.

Cassette Mechanism Assembly has been changed for the models starting from the serial numbers shown in the table below.

Model	Serial No. Applied	Model	Serial No. Applied
KP-151 E	24,601~	KP-4300A ZEB	7,601~
KP-212 E	77,601~	KP-410A ZE	6,601~
KP-250 ZE	31,101~	KP-4400A ZE	1~
KP-4000 G	89,101~	KP-4900A SE	2,601~
KP-4000A ZE	26,101~	08118-65707	1,101~
KP-4000A ZEB	11,101~	08118-65708	1,101~
KP-4300A ZE	1,601~		

● Before Change (Name Plate)

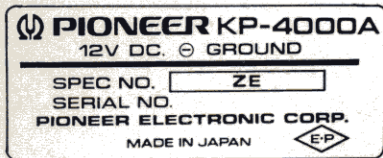

● After Change (Name Plate)

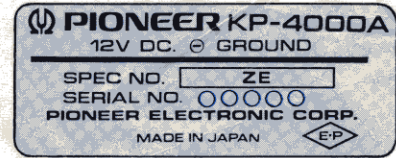

CASSETTE MECHANISM EXPLODED VIEW (TOP)

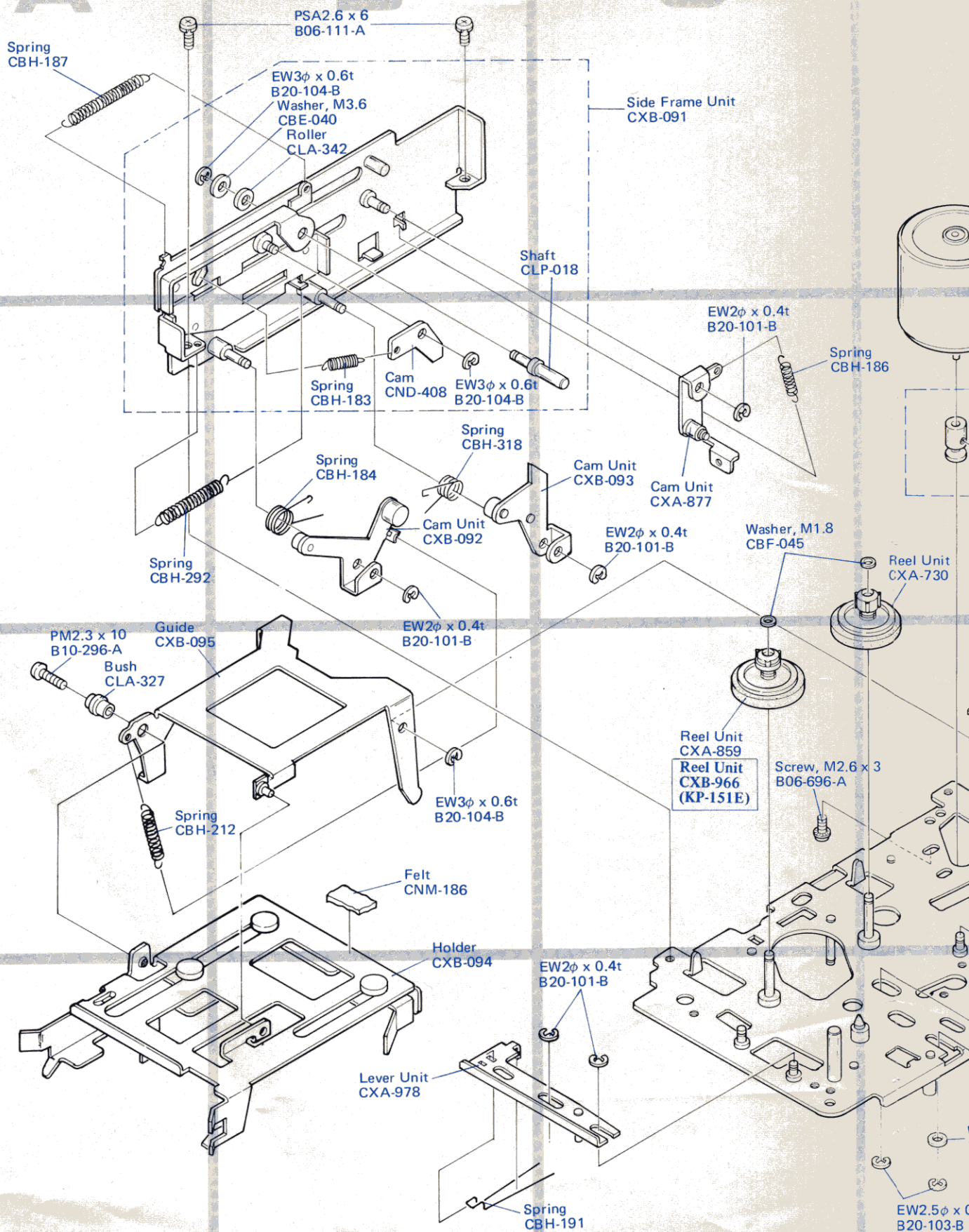

Unit

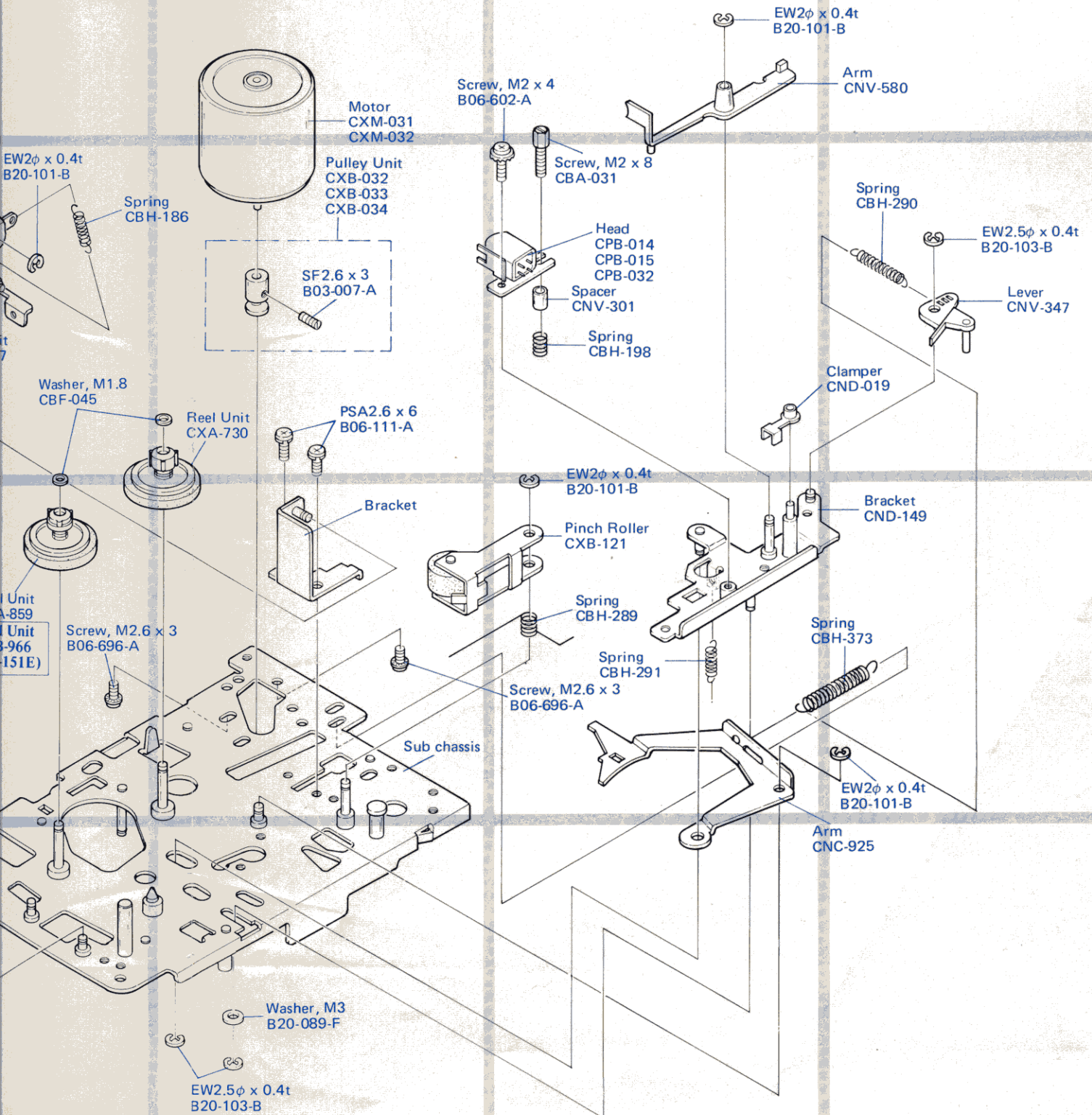

CASSETTE MECHANISM EXPLODED VIEW (BOTTOM)

CASSET

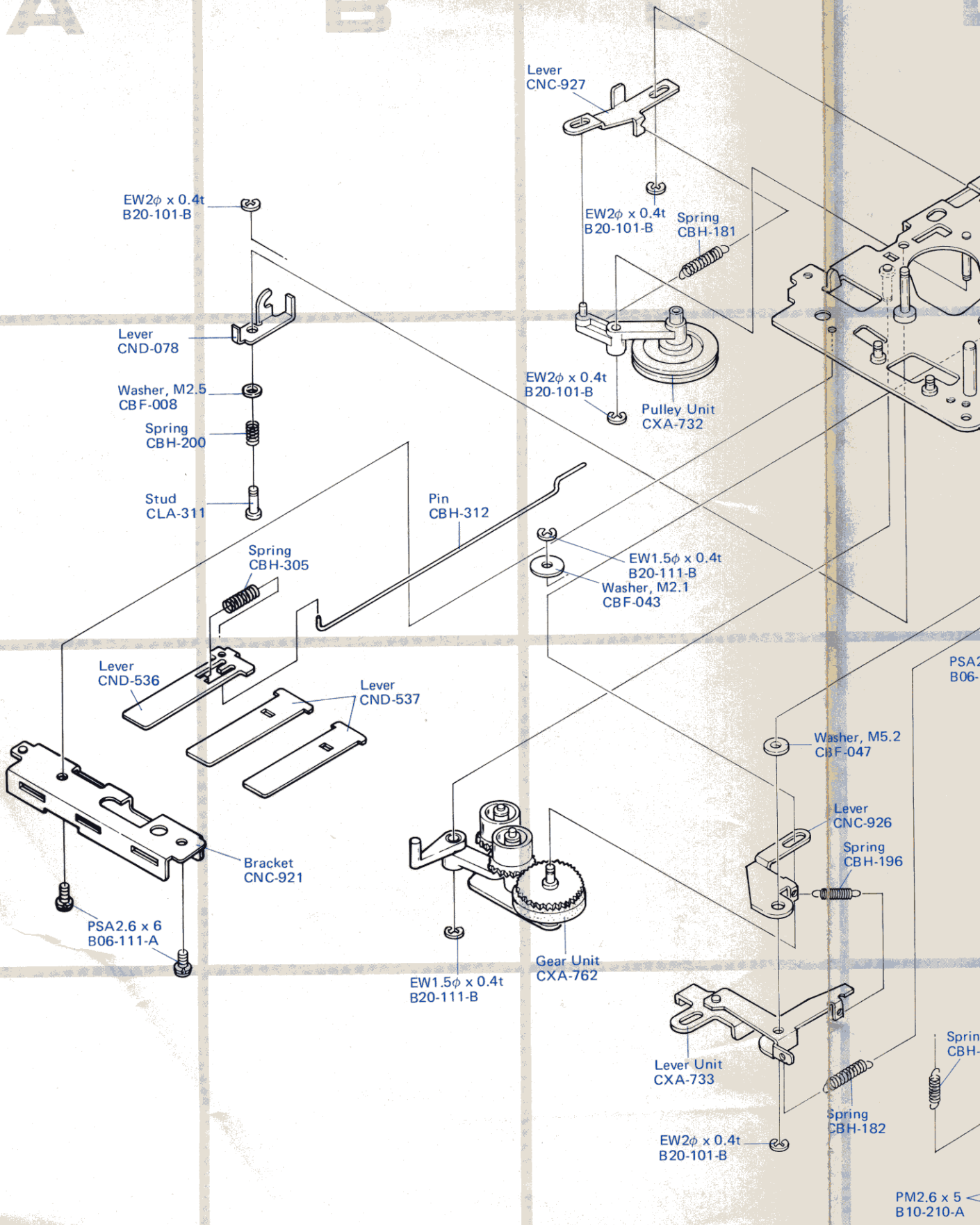

NOTICE: Part whose parts number is omitted is subject to being not supplied.

CASSETTE MECHANISM EXPLODED VIEW (BOTTOM)

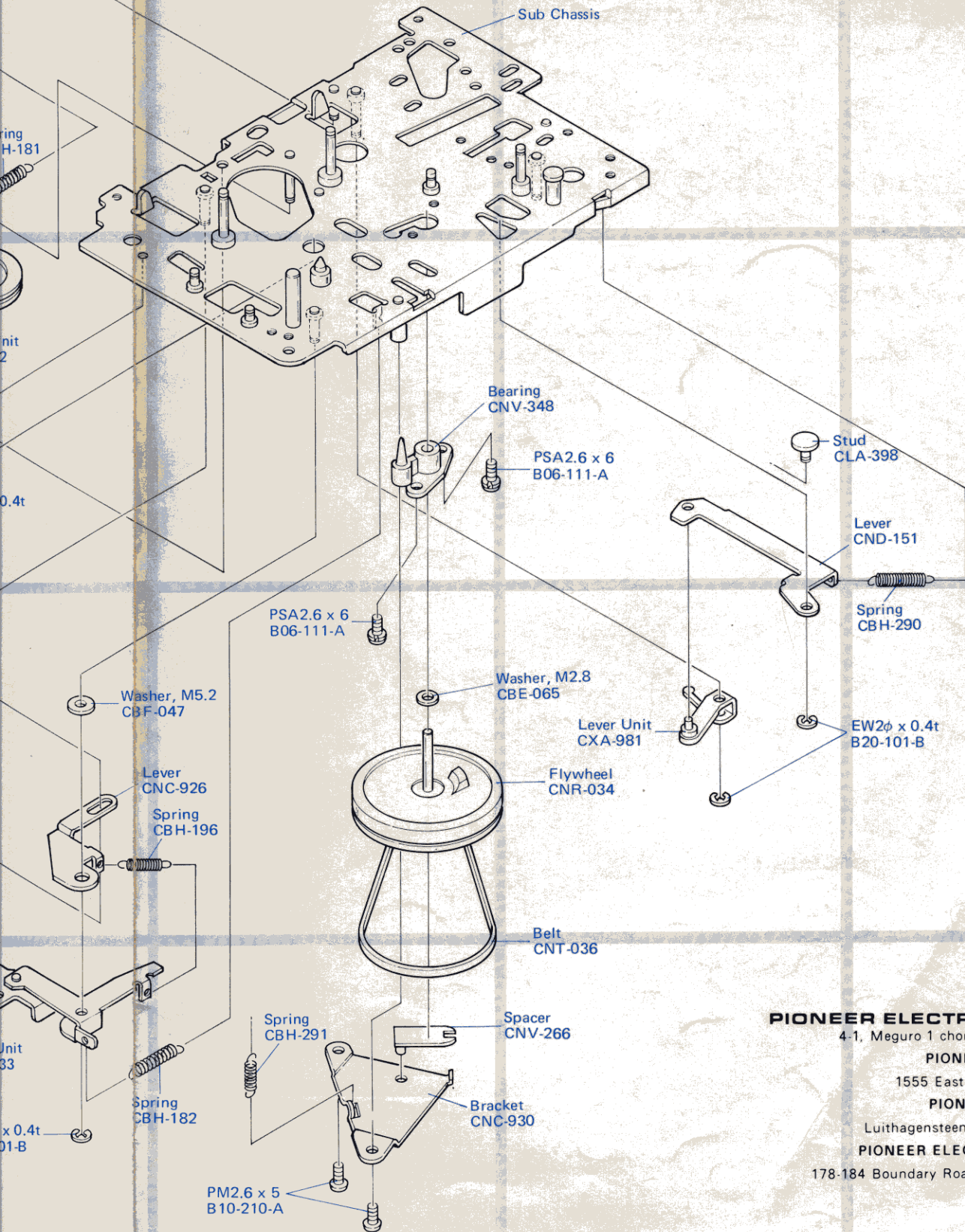

PIONEER ELECTRONIC CORPORATION

4-1, Meguro 1 chome, Meguro-ku, TOKYO, 153, JAPAN

PIONEER ELECTRONICS OF AMERICA

1555 East Del Amo Blvd. Carson, Calif. 90746

PIONEER ELECTRONIC (EUROPE) N.V.

Luithagensteenweg, No. 9, 2030 Antwerp, Belgium

PIONEER ELECTRONICS AUSTRALIA PTY. LTD.

178-184 Boundary Road, Braeside, Victoria 3195, Australia

© APR. 1976 Printed in Japan

<76D03E61K>

SCHEMATIC CIRCUIT DIAGRAM

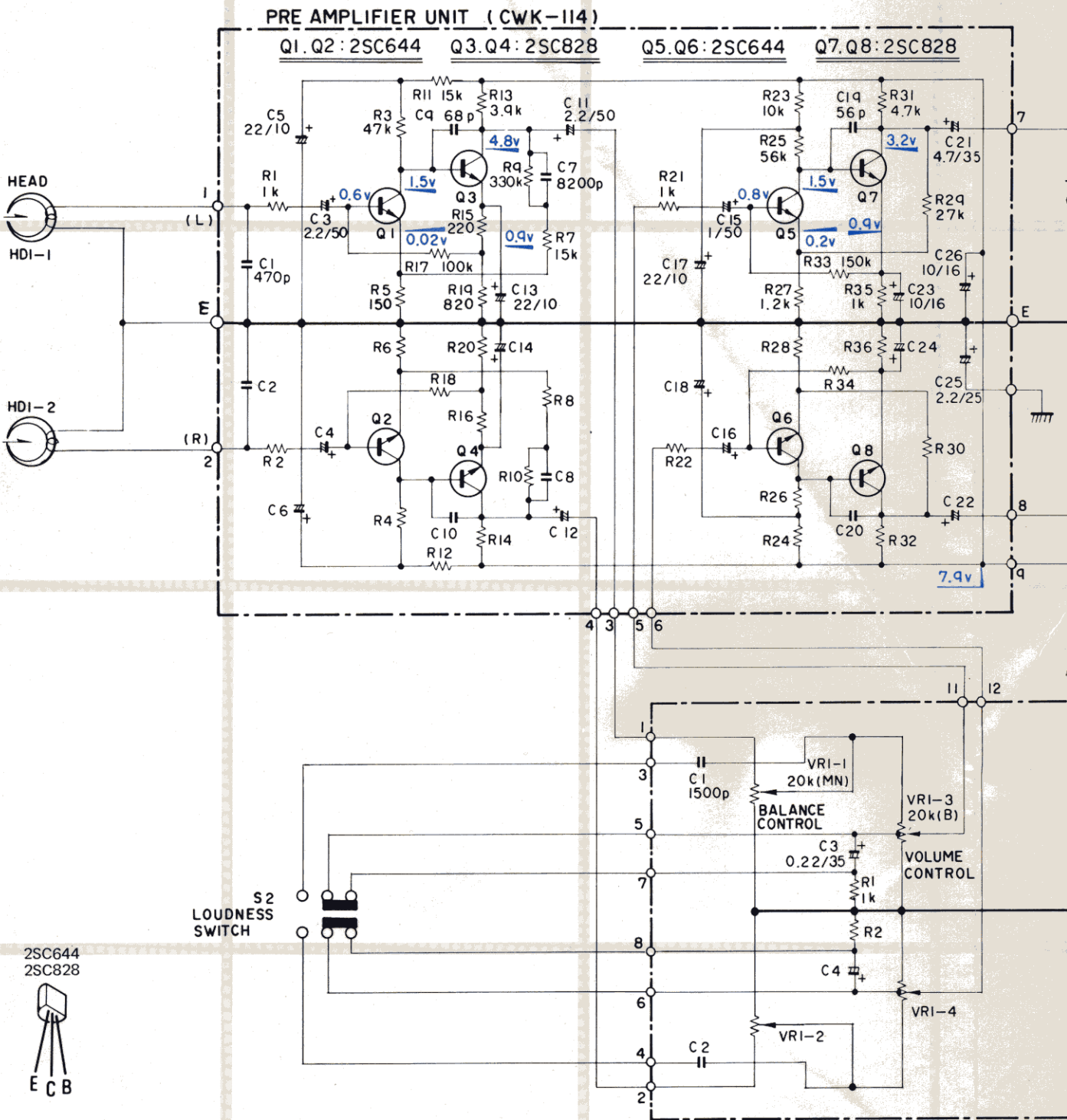

D E F

CONTROL AMPLIFIER UNIT (CWK-115)

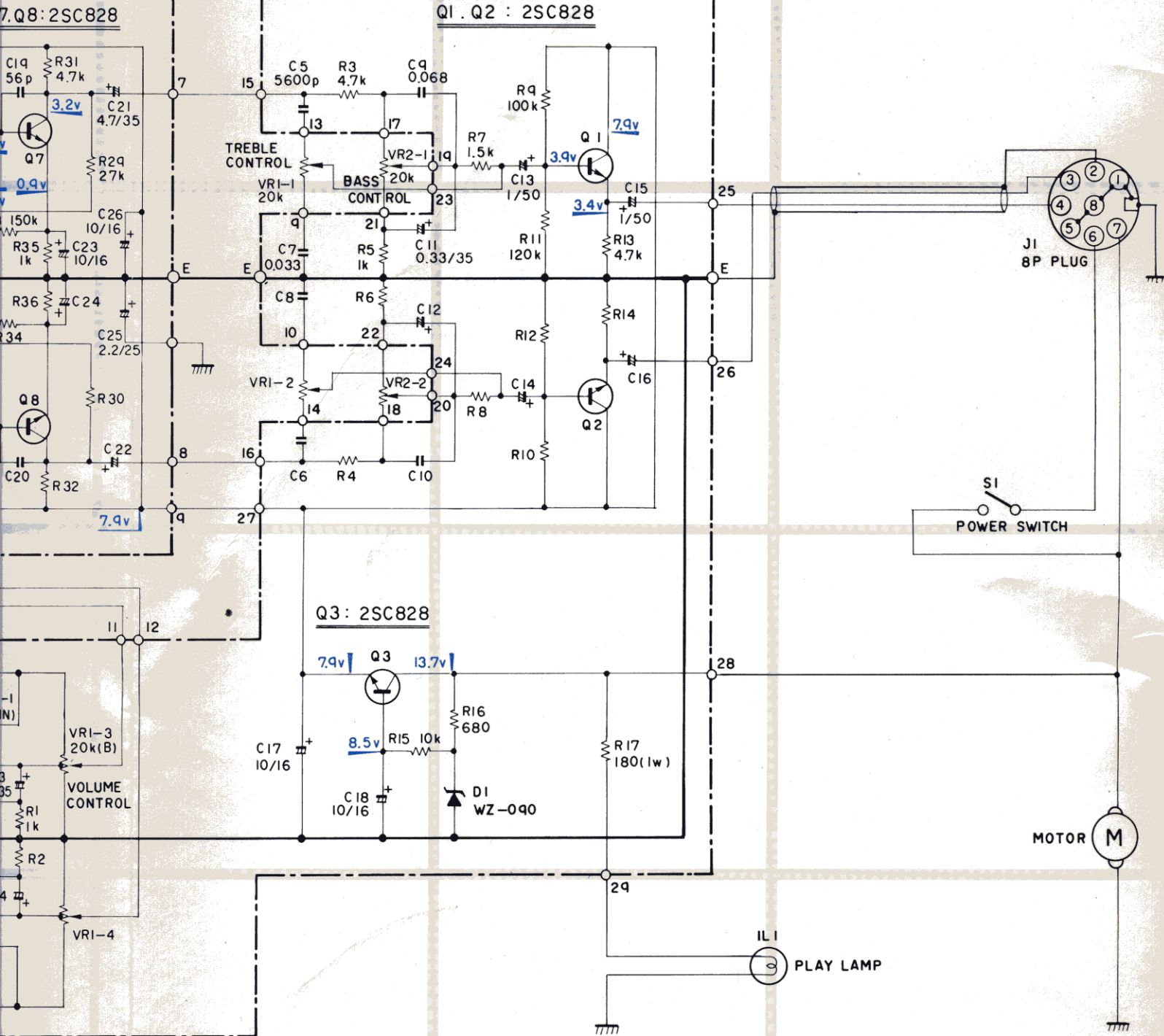

Free Manuals Download Website

<http://myh66.com>

<http://usermanuals.us>

<http://www.somanuals.com>

<http://www.4manuals.cc>

<http://www.manual-lib.com>

<http://www.404manual.com>

<http://www.luxmanual.com>

<http://aubethermostatmanual.com>

Golf course search by state

<http://golfingnear.com>

Email search by domain

<http://emailbydomain.com>

Auto manuals search

<http://auto.somanuals.com>

TV manuals search

<http://tv.somanuals.com>