

AUDIOWOX



**2.4GHz Digital Spread Spectrum
Dual Handset Cordless Phone**

**Téléphone numérique sans fil 2.4GHz
à identification de l'appelant et haut-parleur**

**Teléfono inalámbrico con dos auriculares y
espectro digital de 2.4GHz**

***OWNER'S MANUAL
MANUEL D'UTILISATION
MANUAL DEL USUARIO***



CONTENTS

IMPORTANT SAFETY INSTRUCTIONS 2-3

BATTERY CAUTIONARY INSTRUCTIONS 3

IMPORTANT ELECTRICAL CONSIDERATIONS 4 - 6
 • Telephone line problems • FCC Part 15 regulation • Customer information
 • Applicable for coin or pay phone only

INTRODUCTION 7

INSTALLATION 8 - 9
 • Line cord connection • AC power connection • Battery installation and charging • Placing the battery • Low battery voltage warning • Install base unit & additional handset in a location

LOCATION OF CONTROLS 10
 • Handset section • Base section • Accessories • Icon explanations

USING THE MENU SYSTEM 11

TELEPHONE OPERATION 12 - 13
 • Answering an incoming call • Making a call • Transferring an external call

MEMORY OPERATION 14 - 15
 • Adding a new entry to memory • Editing a memory entry • Delete a memory entry

CALLER ID OPERATION 16 - 17
 • Dial from call record • Save the call record to phonebook • Delete the call record • Delete all call record

TELEPHONE SETTINGS 18 - 20
 • Ringer volume • Ringer melody • Receiver volume • Keypad • Setting clock • Format setting (12 hour) • Daily alarm setting

WALKIE-TALKIE FUNCTION 21 - 22

OTHER FUNCTION 23
 • Dialing mode • Auto answer • Speaker phone mode

TROUBLE SHOOTING GUIDE 24



IMPORTANT SAFETY INSTRUCTIONS

Please take a few moments to read the following instructions for your safety and to ensure that you get the maximum benefit from your product.

When using your telephone equipment, basic safety precautions should always be followed to reduce the risk of fire, electric shock, and injury to persons, including the following :

- 1) Read and understand all instructions.
- 2) Follow all warnings and instructions marked on the product.
- 3) Unplug this product from the wall outlet before cleaning. Do not use liquid cleaners or aerosol cleaners. Use a dry cloth for cleaning.
- 4) Do not use this product near water, for example, near a bath tub, wash bowl, kitchen sink, laundry tub, in a wet basement, or near a swimming pool.
- 5) Do not place this product on an unstable cart, stand, or table. The telephone may fall, causing serious damage to the telephone.
- 6) Slots and openings on the sides and back of the base of the phone are provided for ventilation. These openings must not be blocked or covered. The opening should never be blocked by a built-in installation unless proper ventilation is provided.
- 7) This product should be operated only from the type of power source indicated on the marking label. If you are not sure of the type of power supply to your home, consult your dealer or local power company.
- 8) Do not allow anything to rest on the power cord. Do not locate this product where the cord will be abused by persons walking on it.
- 9) Do not overload wall outlets and extension cords as this can result in the risk of fire or electric shock.
- 10) Never push objects of any kind into this product through phone base slots as they may touch dangerous voltage points or short out parts that could result in a risk of fire or electric shock. Never spill liquid of any kind on the product.
- 11) To reduce the risk of electric shock, do not disassemble this product. Take it to a qualified service personnel when some service or repair work is required. Opening or removing covers may expose you to dangerous voltages or other risks. Incorrect reassembly can cause electric shock when the appliance is subsequently used.
- 12) Unplug this product from the wall outlet and refer servicing to qualified service personnel under the following condition.
 - a) When the power supply cord plug is damaged or frayed.
 - b) If liquid has been spilled into the product.
 - c) If the product has been exposed to rain or water.



IMPORTANT SAFETY INSTRUCTIONS

- d) If the product does not operate normally by following the operating instructions. Adjust only those controls that are covered by the operating instructions. Improper adjustment of other controls may result in damage, and will often require extensive work by a qualified technician to restore the product to normal operation.
 - e) If the product has been dropped or the cabinet has been damaged.
 - f) If the product exhibits a distinct change in performance.
- 13) Do not use the telephone to report a gas leak in the vicinity of the leak.
- 14) Avoid using a telephone (other than a cordless type) during an electrical storm. There may be a remote risk of electric shock from lightning.



USE ONLY WITH CLASSE 2 POWER SOURCE 7.5V DC 450mA  + (For Base)
7.5V DC 150mA  + (For Charger)

BATTERY CAUTIONARY INSTRUCTIONS

CAUTION

Risk of explosion if battery is replaced by an incorrect type.
Replace only with the same type recommended by the manufacturer.
Dispose of used batteries according to the manufacturer's instructions.

- 1) Use only the following type and size battery : type no. SHIDA BATTERY CO. LTD., AP55AAAH3 NIMH 3.6V 550mAH.
- 2) Do not dispose of the battery pack in a fire. The cell may explode. Check with state and local codes for possible special disposal instructions.
- 3) Do not open and mutilate the battery pack. Released electrolyte is corrosive and may cause damage to the eyes or skin. It may be toxic if swallowed.
- 4) Exercise care in handling the battery to prevent shorting it with conducting materials such as rings, bracelets, and keys. The battery or conductor may overheat and cause burns.
- 5) Charge the battery pack provided with or identified for use with this product only in accordance with the instructions and limitations specified in the instruction manual provided for this product.
- 6) Observe proper polarity orientation between the battery pack and battery charger.
- 7) Keep batteries out of the reach of children.

SAVE THESE INSTRUCTIONS

E - 3





IMPORTANT ELECTRICAL CONSIDERATIONS

Unplug all electrical appliances when you know an electrical storm is approaching. Lightning can pass through your household wiring and damage any device connected to it. This telephone is no exception.

Warning : Please do not attempt to unplug any appliance during an electrical storm.

Caution : Changes or modifications to this product not expressly approved, or operation of this product in any way other than as detailed by this Operating Guide, could void your authority to operate this product as well as void the product's warranty.

Telephone Line Problems

The FCC has granted the telephone company the right to disconnect service in the event that your phone causes problems on the telephone line. Also, the telephone may make changes in facilities and services which may affect the operation of your unit. However, your telephone company must give adequate notice in writing prior to such actions to allow you time for making necessary arrangements to continue uninterrupted service. If you are having trouble with your telephone service, you must first disconnect your phone to determine if it is the cause of your problem. If your trouble has been corrected.

FCC Part 15

Warning : Changes or modifications to this unit not expressly approved by the party responsible for compliance could void the user's authority to operate the equipment.

Caution : To maintain compliance with the FCC's RF exposure guidelines place the base unit at least 20 cm from nearby persons.

Note : This equipment has been tested and found to comply with the limits for a Class B digital device, pursuant to Part 15 of the FCC Rules. These limits are designed to provide reasonable protection against harmful interference in a residential installation. This equipment generates, uses and can radiate radio frequency energy and, if not installed and used in accordance with the instructions, may cause harmful interference to radio communications.

However, there is no guarantee that interference will not occur in a particular installation. If this equipment does cause harmful interference to radio or television reception which can be determined by turning the equipment off and on, the user is encouraged to try to correct the interference by one or more of the following measures.

- Increase the separation between the equipment and receiver.
- Connect the equipment into an outlet on a circuit different from that to which the receiver is needed.
- Consult the dealer or an experienced radio/TV technician for help.

Customer information

This equipment complies with Part 68 of the FCC rules and the requirements adopted by the ACTA. On the bottom of this equipment is a label that contains, among other information, a product identifier in the format US:3W4WIO3BTL9035, if requested, this number must be provided to the telephone company.

E - 4



IMPORTANT ELECTRICAL CONSIDERATIONS

An applicable certification jacks Universal Service Order Codes (USOC) for the equipment is provided (i.e., RJ11C) in the packaging with each piece of approved terminal equipment.

A plug and jack used to connect this equipment to the premises wiring and telephone network must comply with the applicable FCC Part 68 rules and requirements adopted by the ACTA. A compliant telephone cord and modular plug is provided with this product. It is designed to be connected to a compatible modular jack that is also compliant. See installation instructions for details.

The REN is used to determine the number of devices that may be connected to a telephone line. Excessive RENs on a telephone line may result in the devices not ringing in response to an incoming call. In most but not all areas, the sum of RENs should not exceed five (5.0). To be certain of the number of devices that may be connected to a line, as determined by the total RENs, contact the local telephone company. [For products approved after July 23, 2001, the REN for this product is part of the product identifier that has the format US:3W4WI03BTL9035. The digits represented by ## are the REN without a decimal point (e.g., 03 is a REN of 0.3). For earlier products, the REN is separately shown on the label.

If this equipment Model TL9038 causes harm to the telephone network, the telephone company will notify you in advance that temporary discontinuance of service may be required. But if advance notice isn't practical, the telephone company will notify the customer as soon as possible. Also, you will be advised of your right to file a complaint with the FCC if you believe it is necessary.

The telephone company may make changes in its facilities, equipment, operations or procedures that could affect the operation of the equipment. If this happens the telephone company will provide advance notice in order for you to make necessary modifications to maintain uninterrupted service.

Please follow instructions for repairing if any (e.g. battery replacement section); otherwise do not alter or repair any parts of device except specified.

Connection to party line service is subject to state tariffs. Contact the state public utility commission, public service commission or corporation commission for information.

The equipment is hearing aid compatible.

NOTICE: If your home has specially wired alarm equipment connected to the telephone line, ensure the installation of this [equipment ID] does not disable your alarm equipment. If you have questions about what will disable alarm equipment, consult your telephone company or a qualified installer.

Should you experience trouble with this equipment, please contact (Audiovox Electronics Corporation, 150 Marcus Blvd. Hauppauge, New York 11788. Phone: 1-800-252-6123) for repair or warranty information. If the equipment is causing harm to the telephone network, the telephone company may request that you disconnect the equipment until the problem is resolved.

NOTICE: According to telephone company reports, AC electrical surges, typically resulting from lightning strikes, are very destructive to telephone equipment connected to AC power sources. To minimize damage from these types of surges, a surge arrestor is recommended.

Applicable for Coin or Pay Phone Only

To comply with state tariffs, the telephone company must be given notification prior to connection for customer-owned coin or credit card phone. In some states, the state public utility commission, public service commission or corporation commission must give prior approval of connection.



IMPORTANT ELECTRICAL CONSIDERATIONS

“This product meets the applicable Industry Canada technical specifications.”

Before installing this equipment, users should ensure that it is permissible to be connected to the facilities of the local telecommunications company. The equipment must also be installed using an acceptable method of connection. In some cases, the company's inside wiring associated with a single line individual service may be extended by means of a certified connector assembly (telephone extension cord). The customer should be aware that compliance with the above conditions may not prevent degradation of service in some situations.

Repairs to certified equipment should be made by an authorized Canadian maintenance facility designated by the supplier. Any repairs or alternations made by the user to this equipment, or equipment malfunctions, may give the telecommunications company cause to request the user to disconnect the equipment.

Users should ensure for their own protection that the electrical ground connections of the power utility, telephone lines and internal metallic water pipe system, if present, are connected together. This precaution may be particularly important in rural areas.

Caution: Users should not attempt to make such connections themselves, but should contact the appropriate electric inspection authority, or electrician, as appropriate.

“The Ringer Equivalence Number is an indication of the maximum number of terminals allowed to be connected to a telephone interface. The termination on an interface may consist of any combination of devices subject only to the requirement that the sum of the Ringer Equivalence Numbers of all the devices does not exceed five.”



INTRODUCTION

TELEPHONE FEATURES

- Operating in 2400 MHz ~ 2483 MHz.(ISM band) with 45 Channels
- Digital Spread Spectrum Technology (Frequency Hopping)
- Up to 4 Handsets operate in one base.
- Caller ID with call waiting function (Type II).
- Speaker phone function in handset.
- 60 hours Standby time, 6 hours talk time.
- Simultaneous call – a Telephone call & 1 pair of Intercom call (HS 2 & HS3)
- Two line Displaying Alphanumeric Characters (2 x 10-digit Dot Matrix LCD) & functional Icons.
- Auto talk (pick up the handset from cradle during call ringing)
- Auto standby (place handset on cradle after call conversation)
- Call transfer between H/S.
- Clear talk Range – Min. 220meter outdoors (line on sight).
- Up to 50 phone book memories; 20 digits with 10 characters.
- 10 dialed number records (20 digits).
- 7-level Adjustable Receiver Volume
- 7-level Adjustable Ringer Volume
- 10 Ringer melody selection
- Name to number matching *
- Real time clock function
- Call timer display
- Alarm clock function
- Hold function for call transfer
- Pre - dial facility.
- Low battery indication.
- Keypad Lock
- Key tone on/off
- Walkie-Talkie function
- Speaker phone function.

* Function has to work with caller ID feature.

Important: In order to use Caller ID functions, you must subscribe to Caller ID service from your local access provider. To receive calling number in your display while you are on the phone, you must subscribe to caller ID and call waiting with your local telephone provider.

NOTE : The two handsets supplied with this model are already registered with the main base. All other additional handsets purchased will need to be subscribed to the main base. (See instructions included with additional handsets for further details).

E - 7



INSTALLATION

LINE CORD CONNECTION :

Plug the telephone line cord into the modular jack on the back of the telephone base and the other end into the modular jack of your telephone wall outlet.

AC POWER CONNECTION :

Use only the AC/DC adaptor provided with the telephone. First insert the DC adaptor plug into the DC adaptor socket provided on the telephone base. Then plug the AC adaptor into your main power outlet.

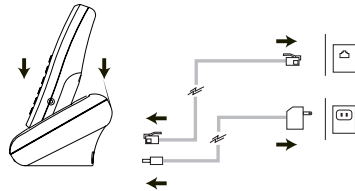

BATTERY INSTALLATION AND CHARGING :

This equipment uses Nickel Metal Hydride (NiMH) batteries. To keep the batteries at full charge you can leave the handset in the base unit at all times for safe trickle charging. During charge, the charge LED will be on and battery icons will be FLASHING.

PLACING THE BATTERY

Place the battery pack as shown below. Observing correct polarity.

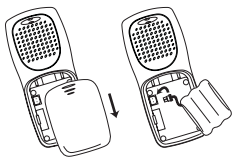

LOW BATTERY VOLTAGE WARNING

At installation the battery voltage will be low and the handset should be placed on the station for 10 hours continuously to fully charge the batteries.

If the voltage is extremely low then the handset will not function at all, but if there is sufficient residual voltage then the handset will power up indicating low voltage. This can be seen from both the battery icon flashing empty.



INSTALLATION

Install base unit & additional handset in a location where:

- Away from electrical appliances, such as computer, TV, microwave ovens, wireless equipment or another cordless phone.
- In a HIGH and CENTRAL location with no obstructions & barriers,
- For maximum reception & noise free during use the phone, keeping handset as close to the base unit.
- Being visible at most of your area.

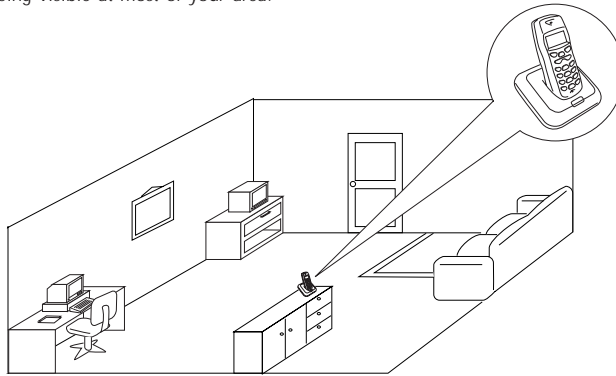



LOCATION OF CONTROLS

HANDSET SECTION

- 1) RECEIVER
- 2) DISPLAY
- 3) OFF HOOK / YES / FLASH KEY
- 4) INT / REDIAL / PAUSE KEY
- 5) ON HOOK / NO KEY
- 6) SCROLL KEYS ▲ / ▼
- 7) DIAL KEYS / ID#s
- 8) SPEAKER KEY
- 9) MICROPHONE
- 10) STRAP HOLDER
- 11) SPEAKER
- 12) BATTERY DOOR
- 13) HEADSET JACK

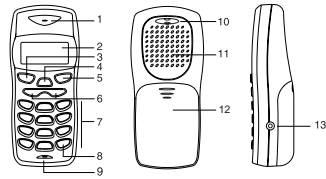

CHARGER SECTION

- 14) CHARGE LED
- 15) ADAPTOR SOCKET

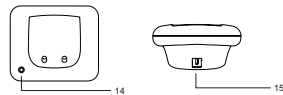

BASE SECTION

- 16) PAGE KEY
- 17) IN-USE & CHARGER LED
- 18) LINE CORD MODULAR JACK
- 19) ADAPTOR SOCKET

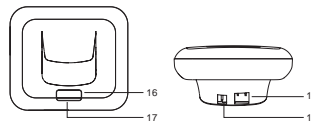

ACCESSORIES

- 20) MAIN ADAPTOR
- 21) CHARGER ADAPTOR
- 22) LINE CORD
- 23) BATTERY PACK

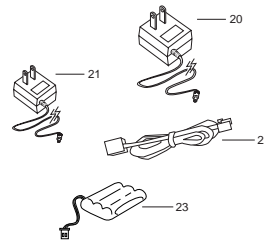

ICON EXPLANATIONS

**RECEIVED SIGNAL STRENGTH INDICATOR (RSSI) :**

On when registered and in range, flashes when out of range.

**RINGER MUTED :**

On when ringer volume is set to zero.

**LINE INDICATOR :**

On when the handset is on line.

**BATTERY STRENGTH :**

Three segments to indicate state of charge of battery. Flashes when battery needs recharging.



USING THE MENU SYSTEM

The user interface has been designed with simplicity of operation in mind. Functions that are not available from the keyboard directly are found within a shallow menu structure. The menu is available from the default screen simply by pressing either of the \blacktriangle / \blacktriangledown (6) arrow keys. All menus wrap around, for example if one presses down from the bottom item one reaches the top item.

If the user has entered into the menu structure and decides not to complete the operation that has been selected, then there are two mechanisms that allow the user to recover:

1. Pressing and holding the **NO (5)** key during a function will return the user to the menu from which that function was selected. If this key is pressed while in a submenu then the user is returned to the menu from which that submenu was selected.
2. Menus and memory selections (also navigated via the arrow keys) all have simple timeouts, so that a phone left in these states will revert to the default screen after a suitable period.

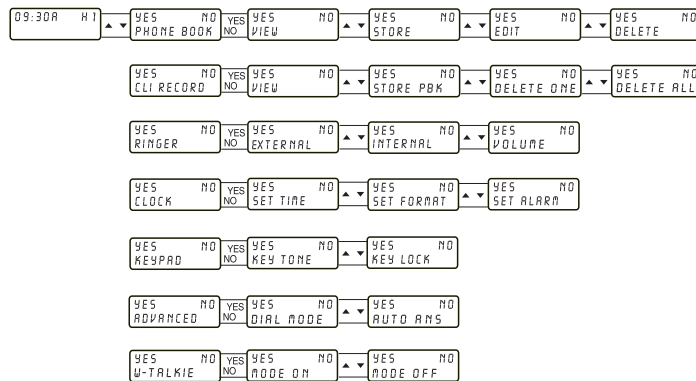



TELEPHONE OPERATION

ANSWERING AN INCOMING CALL

Internal call

When the internal call comes, the display shows the identity (ID) number of the calling handset. The user answers the call by pressing **YES (3)** and ends the call by pressing **NO (5)**.

Pressing **NO (5)** during ringing rejects the incoming call and both calling and called handsets return to standby state.

External call

When an external call comes, the display will show the caller's number and time. If the handset is on charge unit (i.e. on base station), simply picking up the unit will cause it to answer. If it is not, then press **YES (3)** to answer or press **NO (5)** to stop the ring.

"**UNKNOWN**" would be displayed during an incoming call if Caller ID service is not activated, or if a network does not pass on this information, or if callers withhold their numbers.

MAKING A CALL

Calling an External Number

In this case, the user goes off hook' using the **YES (3)** key, then dials the number in the standard way.

Once the user has chosen to go off-hook, the phone has no way of sensing that the dialing of the number is finished. Therefore the display will revert to showing the elapsed call duration after a 5-second timeout.

Pre-dialing

Here the user enters the number and can edit and correct it before going 'off hook', at which point the number is actually dialed.

Calling from Alphanumeric Memory

The user dials a number, which has already been stored in one of the alphanumeric memories. Entries in the memories are stored in alphabetical order, or in the case where two memories have the same alpha name, they will be stored in the numeric order.

If a number exceeds 10 digits, the first 10 digits are shown initially.

As with other lists and menus, the memory lists will wrap around.

Calling another Internal Handset

Press and hold **INT (REDAIL/PAUSE) (4)** button for 1 second to activate an internal call to call another handset that is registered on the same base. The display will show "**INT?**" enter the hand set to call by dialing 1-4.

If the called handset is not subscribed (number has not been allocated), does not respond or the handset is busy, the user will be given a "**busy tone**".

Press **NO (5)** to end the call.



TELEPHONE OPERATION

Last Number Redial

In the on hook mode, press the **REDIAL (INT/PAUSE) (4)** button to show the last dialing number on display.

The user can select up to last ten external numbers by pressing the **▲/▼ (6)** buttons.

These are stored in chronological order, with the most recent being displayed first. Then press the **YES (3)** button to dial the selected number.

If there are no numbers in the list, then the redial button will show "**NO ENTRIES**".

As with other lists and menus, the redial list will wrap around.

TRANSFERRING AN EXTERNAL CALL

It is not possible to transfer internal calls from one internal extension to another - the users must redial. The facility to transfer an external call is described here.

Transferring to another registered handset

If the user needs to transfer an outgoing or incoming call to another handset registered to the same base station, this is done by pressing the **INT (REDIAL/PAUSE) (4)** key for 1 second, followed by the internal telephone number. The call transfer is completed by pressing the **NO (5)** key to return to standby state or aborted by pressing the **INT (REDIAL/PAUSE) (4)** key for 1 second again. The call duration timer is not transferred between internal extensions.

Transferring using the Flash Key

If the base station is connected to a PABX extension, then the **OFF HOOK/YES (3)** key may be pressed during a call to send a Flash to the PABX. Call transfer to another PABX extension is then handled according to the procedure specified by the PABX.





MEMORY OPERATION

This describes how memory is managed - how numbers are added, removed and edited. All of these memory functions use the menu system.

ADDING A NEW ENTRY TO MEMORY

- Enter the Phonebook mode by pressing scroll keys $\blacktriangle/\blacktriangledown$ (6), then press **YES** (3).
- Select the **"STORE"** then enter the Name and Number respectively.
- Press the **YES** (3) to confirm the corresponding input item.



Particular points to note are:

- Alpha characters are entered by pressing the number keys, which cycle round the available characters. For example, pressing the 2 key once shows 'A', pressing it again changes the character to 'B', pressing it again gives 'C', pressing it again gives '2', then 'A' again etc. The user interface waits at each letter position until a key is pressed, then stays there until no key is pressed for 3 seconds, at which point it moves on to the next letter position. The user can correct entries using the \blacktriangle (6) key.
- Pauses in the dialling sequence may be programmed as part of the number by pressing the **Pause (REDIAL/INT)** (4) key during the number sequence.
- Holding down the **NO** (5) key at any point allows the user to abort the procedure.

EDITING A MEMORY ENTRY

Both the alpha name field and the phone number field of a memory entry can be edited. This allows the user to change entries whose names have been misspelled or when their contacts move house.

- Select to the **"PHONE BOOK"** by pressing scroll keys $\blacktriangle/\blacktriangledown$ (6), then press **YES** (3).
- Select **"EDIT"** by pressing scroll keys $\blacktriangle/\blacktriangledown$ (6) then press **YES** (3).
- Press scroll keys $\blacktriangle/\blacktriangledown$ (6) to select the memory item that user need to edit
- Press **YES** (3) start the editing. (Name then number).

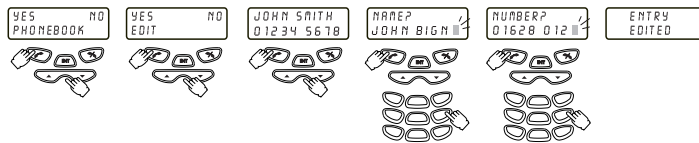



MEMORY OPERATION

DELETING A MEMORY ENTRY

Memory deletion is considerably simpler than adding new memory entries.

- Enter Phonebook mode by pressing scroll keys $\blacktriangle/\blacktriangledown$ (6) and **YES** (3).
- Then select "**DELETE**" by pressing scroll keys $\blacktriangle/\blacktriangledown$ (6) and **YES** (3).
- Press scroll keys $\blacktriangle/\blacktriangledown$ (6) to select the memory to be deleted from the Phonebook.
- Press **YES** (3) to confirm the selection. "**SURE?**" would be shown on.
- Press **YES** (3) to execute the deletion.





CALLER ID OPERATION

These calls can also be dialed out and stored into the phone book.

Remark: To use the caller-ID operation, you have to subscribe the caller-ID service from your operator.

DIAL FROM CALL RECORD

- Press scroll keys $\blacktriangle/\blacktriangledown$ (6) to select "CLI RECORD", then YES (3) to confirm.
- Press scroll keys $\blacktriangle/\blacktriangledown$ (6) to select "VIEW" then YES (3) to confirm.
- Press scroll keys $\blacktriangle/\blacktriangledown$ (6) to select the record to be dialed then YES (3) to dial it out.

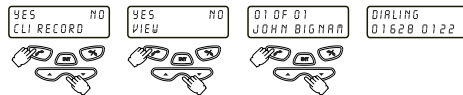

SAVE THE CALL RECORD TO PHONE BOOK

- Press scroll keys $\blacktriangle/\blacktriangledown$ (6) to select "CLI RECORD", then YES (3) to confirm.
- Press scroll keys $\blacktriangle/\blacktriangledown$ (6) to select "STORE PBK", then YES (3).
- Press scroll keys $\blacktriangle/\blacktriangledown$ (6) to select the record to be stored then YES (3) to store it.
- Enter the name then confirm by YES (3).



DELETE ONE CALL RECORDS

- Press scroll keys $\blacktriangle/\blacktriangledown$ (6) to select "CLI RECORD", then YES (3) to confirm.
- Press scroll keys $\blacktriangle/\blacktriangledown$ (6) to select "DELETE ONE", then YES (3).
- Press scroll keys $\blacktriangle/\blacktriangledown$ (6) to select the call record to be deleted then YES (3) to confirm.
- Display will show "SURE?" to confirm the deletion.
- Press YES (3) again to execute the deletion.





CALLER ID OPERATION

DELETE ALL CALL RECORDS

- Press scroll keys ▲/▼ (6) to select "CLI RECORD", then YES (3) to confirm.
- Press scroll keys ▲/▼ (6) to select "DELETE ALL", then YES (3).
- Display will show "SURE?" to confirm the deletion.
- Press YES (3) again to execute the deletion.

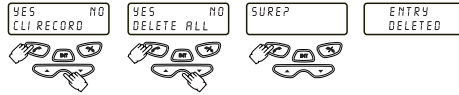

CALLER-ID WITH CALL WAITING

During phone conversation, when there is incoming call from a third party, you will hear beep tone from the handset receiver and the display will show the telephone number of the third party.

- Simply press YES (3) to switch the line to the third party.
- Press YES (3) again if you want to switch the line back to the original party.





TELEPHONE SETTINGS

RINGER VOLUME

Ringer volume is set by following procedure.

- Press scroll keys ▲/▼ (6) to select "RINGER" and press YES (3) to confirm.
- Press scroll keys ▲/▼ (6) to select "VOLUME" and press YES (3) to confirm.
- Press scroll keys ▲/▼ (6) to select Volume level (RING * to RING *****)
- Then press YES (3) to confirm the setting.

Note : The ringer volume setting is applied to internal calls, external calls.



RINGER MELODY

The user will be able to choose the ringer melody from a list of pre-set tones.

Set the ringer melody for external call (Incoming call)

- Press scroll keys ▲/▼ (6) to select "RINGER" and press YES (3) to confirm.
- Press scroll keys ▲/▼ (6) to select "EXTERNAL" and press YES (3) to confirm.
- Press scroll keys ▲/▼ (6) to select RING NUMBER and press YES (3) to confirm.



Set the ringer melody for Internal call (Intercom)

- Press scroll keys ▲/▼ (6) to select "RINGER" and press YES (3) to confirm.
- Press scroll keys ▲/▼ (6) to select "INTERNAL" and press YES (3) to confirm.
- Press scroll keys ▲/▼ (6) to select RING NUMBER and press YES (3) to confirm.

Note : When one of the melodies has been selected, the corresponding melody will sound. However, this melody would not be set until YES (3) is pressed.



RECEIVER VOLUME

Receiver volume is set using the scroll keys during the talk mode.





TELEPHONE SETTINGS

KEYPAD

There are two user options for the keypad.

The keypad can be locked to prevent unintended operation

- Press scroll keys ▲/▼ (6) to select "KEYPAD" and press YES (3) to confirm.
 - Press scroll keys ▲/▼ (6) to select "KEY LOCK" and press YES (3) to lock the key pad.
- Once locked, all key presses cause the message 'UNLOCK?' to be shown on the LCD. The user must then press the YES (3) key to unlock.



The Key tone can be used to indicate that a key has been pressed. This beep can be enabled or disabled.

To disable the key tone:

- Press scroll keys ▲/▼ (6) to select "KEYPAD" and press YES (3) to confirm.
- "KEY TONE" would be displayed and press YES (3) to confirm.
- Press scroll keys ▲/▼ (6) to select "TONE OFF" and press YES (3) to disable the key tone.



To enable the key tone:

- Press scroll keys ▲/▼ (6) to select "KEYPAD" and press YES (3) to confirm.
- "KEY TONE" would be displayed and press YES (3) to confirm.
- Press scroll keys ▲/▼ (6) to select "TONE ON" and press YES (3) to enable the key tone.



SETTING CLOCK

The clock is set by the user and can be viewed as 24 hour or 12 hour. The default format is factory set, but the user can then change to the alternative format if preferred.

- Press scroll keys ▲/▼ (6) to select "CLOCK" and press YES (3) to confirm.
- Press scroll keys ▲/▼ (6) to select SET TIME and press YES (3) to confirm.
- "TIME" is displayed, key in the correct time by 24 hour format. (e.g. 10:00pm, press 2200) then YES (3) to confirm.
- The set time is displayed on LCD.

E - 19





TELEPHONE SETTINGS

Note that if Caller ID service is activated, this service will reset the time at every incoming call.

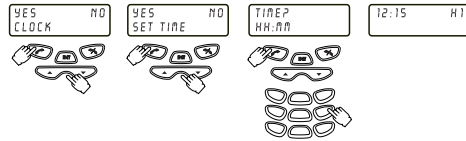

FORMAT SETTING (12 HOUR)

- Press scroll keys $\blacktriangle/\blacktriangledown$ (6) to select "CLOCK" and press YES (3) to confirm.
- Press scroll keys $\blacktriangle/\blacktriangledown$ (6) to select "SET FORMAT" and press YES (3) to confirm.
- Press scroll keys $\blacktriangle/\blacktriangledown$ (6) to select "12 - HOUR" and press YES (3) to confirm.
- The clock will be displayed by set format (e.g. 10:00A)

For the 24 hours setting, it is same procedure as above except selecting 24 HOUR at item 3. The clock will be displayed by 24 hour format (e.g. 22:00).



DAILY ALARM SETTING

- Press scroll keys $\blacktriangle/\blacktriangledown$ (6) to select "CLOCK" and press YES (3) to confirm.
- Press scroll keys $\blacktriangle/\blacktriangledown$ (6) to select "SET ALARM" and press YES (3) to confirm.
- "TIME? hh:mm" is displayed, key in the desired alarm time in 24 hour format. (e.g. 10:00pm, press 2200) then YES (3) to confirm.
- Press scroll keys $\blacktriangle/\blacktriangledown$ (6) to turn on the ALARM ON and press YES (3) to confirm.
- A clock icon "⌚" will be displayed beside the real time clock when the alarm is set.

Note : When the alarm is ringing, it can only be stopped with the YES (3) key. The YES (3) key only turns off the alarm for that day, it will ring each day at the set time until "ALARM OFF" is selected as above.

During phone conversation, the alarm tone will only be heard from the handset receiver. You can press YES (3) to stop it.





WALKIE-TALKIE FUNCTION

Handset could be set to walkie-talkie mode. In walkie-talkie mode, handset could communicate with other handset even the base is unavailable.

ENABLE WALKIE-TALKIE MODE

- By manual

- Press scroll keys ∇/\blacktriangle (6) to select "W-TALKIE" and press **YES (3)** to confirm.
- Press ∇/\blacktriangle (6) to select walkie-talkie mode on or off (e.g. "MODE ON") and press **YES (3)** to confirm.
- Press scroll keys ∇/\blacktriangle (6) to assign walkie-talkie ID number.
- Press **YES (3)** to confirm the setting and handset will enter to walkie-talkie mode.

Note : For each handset, a different ID# must be assigned, for example: if you have 2 handsets, the first one should be set to W-T ID1 and the second handset should be set to W-T ID2 & so on for the addition of more handsets.

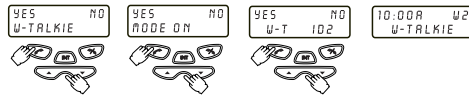

- By short-cut key (For Twins Handsets version only)

- Press and hold ' * ' key for 1 second in standby mode.

DISABLE WALKIE-TALKIE MODE (BACK TO PHONE MODE)

- By manual

- Press scroll keys ∇/\blacktriangle (6) to select "W-TALKIE" and press **YES (3)** to confirm.
- Press ∇/\blacktriangle (6) to select walkie-talkie mode on or off (e.g. "MODE OFF").
- Press **YES (3)** to confirm the setting and handset will go back to phone mode.

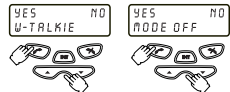

- By short-cut key (For Twins Handsets version only)

- Press and hold ' * ' key for 1 second in walkie-talkie mode.

MAKE WALKIE-TALKIE CALL.

- Press the dial keys (7) to enter the ID# for the handset you want to call, then press **YES (3)** to call.
- A calling tone could be heard if it is available and within the communication range.
- Press the **NO (5)** key to end the call.



WALKIE-TALKIE FUNCTION

ANSWER WALKIE-TALKIE CALL.

- Press **YES (3)** to answer the call.

Both handsets have to be set to walkie-talkie mode before talking walkie-talkie call. In walkie-talkie mode, handset could not make & response phone/intercom call.

Note :

Please check battery level in handsets before taking them away for Walkie Talkie function.

In standby mode, handset's battery will be consumed very soon IF its base is not available. Therefore, you are recommended that:

- Unplug batteries from your handsets before taking them away from their Base.
- Connect the batteries back to handsets and switch handsets to Walkie Talkie mode when you want to use Walkie Talkie function.

or

- Switch your handsets to walkie talkie mode before its Base will be unavailable.





OTHER FUNCTION

DIALING MODE

The dialing mode (DTMF/ Pulse) in base is decided by handsets independently.

- Press scroll keys ▲/▼ (6) to select "ADVANCED", then press YES (3) to confirm.
- Press scroll keys ▲/▼ (6) again to select "DIAL MODE", then press YES (3) to confirm.
- Press scroll keys ▲/▼ (6) to select either "TONE DIAL" or "PULSE DIAL", then press YES (3) to confirm the dialing mode.



AUTO ANSWER

The auto answer function could be activated/deactivated by following procedure.

- Press scroll keys ▲/▼ (6) to select "ADVANCED", then press YES (3) to confirm.
- Press scroll keys ▲/▼ (6) again to select "AUTO ANS", then press YES (3) to confirm.
- Press scroll keys ▲/▼ (6) to select either "AUTO ON" or "AUTO OFF", then press YES (3) to confirm.



SPEAKER PHONE MODE

Enable the speakerphone mode:

While the phone is in off hook mode or in Walkie Talkie mode (handset to handset), simply press and hold the speaker phone button (☎), which is located at # key, for 1 sec to activate the speaker phone mode. When speakerphone mode is activated, speaker will sound and symbol "☎" will also show on LCD.

Disable the speakerphone mode.

Press and hold the speakerphone button for 1 sec. Speaker will be turned off.



TROUBLE SHOOTING GUIDE

In the event of your telephone NOT working or difficulty in opening, the following suggestion can be help you of solving the problem.

Symptom	Suggested Solution
Base unit doesn't work (Power "LED" does not light)	<ul style="list-style-type: none">• Ensure the power adaptor is firmly plugged into power outlet & base unit.• If power LED on base unit is still NOT lighted up, make sure the power outlet has power by connecting another appliance to the outlet.
Base LED doesn't light up for battery charging	<ul style="list-style-type: none">• Ensure the charging contacts on the handset and the base cradle are kept clean regularly.
Handset does NOT work at all	<ul style="list-style-type: none">• Ensure the handset battery is correctly connected & fully charged up 10 hours before use.
No dial tone	<ul style="list-style-type: none">• Ensure telephone line is plugged firmly into base unit & telephone wall jack.• Make sure your telephone line is operating normally by unplugging the unit & replacing with another which is known to be operating correctly.• If you still don't hear dial tone, call your local telephone company.
Receiving a call but handset doesn't ring	<ul style="list-style-type: none">• Ensure telephone line is plugged firmly into base unit & telephone wall jack.• Make sure handset battery is NOT in battery low status.• Handset may be out of range from the base.• Try disconnecting some of your other extension phones which you may have.
Interference by other calls while using your phone If still	<ul style="list-style-type: none">• Replace handset to base's cradle & try your phone call later.• This problem may be caused by your telephone line wiring or local telephone services, call your local telephone company.
Voice background, most of time inherent with noise, static OR fading in & out	<ul style="list-style-type: none">• Probably the phone is out of range, move closer to base, or relocate the base.• The phone operating range may be limited or interfered by the layout of your home environment, try to relocate the base unit.



90 DAY LIMITED WARRANTY

AUDIOVOX ELECTRONICS CORPORATION (the Company) warrants to the original retail purchaser of this product that should this product or any part thereof, under normal use and conditions, be proven defective in material or workmanship within 90 days from the date of original purchase, such defect(s) will be repaired or replaced with new or reconditioned product (at the Company's option) without charge for parts and repair labor.

To obtain repair or replacement within the terms of this Warranty, the product is to be delivered with proof of warranty coverage (e.g. dated bill of sale), specification of defect(s), transportation prepaid, to an approved warranty station. For the location of the nearest warranty station to you, call toll-free to our control office:

1-800-252-6123

This Warranty does not extend to the elimination of externally generated static or noise, to correction of antenna problems, to cost incurred for installation, removal, or reinstallation of the product, or damage to tapes, compact discs, speakers, accessories or electrical systems.

This Warranty does not apply to any product or part thereof which, in the opinion of the Company, has suffered or been damaged through alteration, improper installation, mishandling, misuse, neglect, accident or by removal or defacement of the factory serial number/bar code label(s). THE EXTENT OF THE COMPANY'S LIABILITY UNDER THIS WARRANTY IS LIMITED TO THE REPAIR OR REPLACEMENT PROVIDED ABOVE AND, IN NO EVENT, SHALL THE COMPANY'S LIABILITY EXCEED THE PURCHASE PRICE PAID BY PURCHASER FOR THE PRODUCT.

The Warranty is in lieu of all other express warranties or liabilities. ANY IMPLIED WARRANTIES, INCLUDING ANY IMPLIED WARRANTY OF MERCHANTABILITY, SHALL BE LIMITED TO THE DURATION OF THIS WRITTEN WARRANTY. ANY ACTION FOR BREACH OF ANY WARRANTY HEREUNDER INCLUDING ANY IMPLIED WARRANTY OF MERCHANTABILITY MUST BE BROUGHT WITHIN A PERIOD OF 30 MONTHS FROM DATE OF ORIGINAL PURCHASE. IN NO CASE SHALL THE COMPANY BE LIABLE FOR ANY CONSEQUENTIAL OR INCIDENTAL DAMAGES FOR BREACH OF THIS OR ANY OTHER WARRANTY, EXPRESS OR IMPLIED, WHATSOEVER. No person or representative is authorized to assume for the Company any liability other than expressed herein in connection with the sale of this product.

Some states do not allow limitations on how long an implied warranty lasts or the exclusion or limitation of incidental or consequential damage so the above limitations or exclusions may not apply to you. This warranty give you specific legal rights and you may also have other rights which vary from state to state.

U.S.A.: AUDIOVOX ELECTRONIC CORPORATION, HAUPPAUGE, NEW YORK 11788

CANADA: AUDIOVOX CANADA LTD., MISSISSAUGA, ONTARIO

AUSTRALIA: AUDIOVOX PACIFIC PTY LTD., DOYLE AVENUE, UNANDERRA, NEW 2526 • (042) 718-555

NEW ZEALAND: AUDIOVOX PACIFIC PTY LTD., UNIT B, 6 HEADERSON PLACE, PENROSE, AUCKLAND, AUCKLAND • (09) 645-720



Free Manuals Download Website

<http://myh66.com>

<http://usermanuals.us>

<http://www.somanuals.com>

<http://www.4manuals.cc>

<http://www.manual-lib.com>

<http://www.404manual.com>

<http://www.luxmanual.com>

<http://aubethermostatmanual.com>

Golf course search by state

<http://golfingnear.com>

Email search by domain

<http://emailbydomain.com>

Auto manuals search

<http://auto.somanuals.com>

TV manuals search

<http://tv.somanuals.com>