

Pioneer *sound.vision.soul*

HDD/DVD Recorder

DVR-650H-K

DVR-550H-K

DVR-450H-S

HDD
HARD DISK DRIVE

DVD
VIDEO

DVD MULTI
RECORDER

RW
DVD • ReWritable

DIVX

COMPACT
disc
DIGITAL AUDIO

COMPACT
disc
DIGITAL VIDEO

VCR plus+

HDMI
HIGH DEFINITION MULTIMEDIA INTERFACE

Register Your Product on
<http://www.pioneerelectronics.ca>

Operating Instructions

RW
COMPATIBLE

Thank you for buying this Pioneer product.
Please read through these operating instructions so you will know how to operate your model properly.
After you have finished reading the instructions, put them away in a safe place for future reference.

IMPORTANT



The lightning flash with arrowhead, within an equilateral triangle, is intended to alert the user to the presence of uninsulated "dangerous voltage" within the product's enclosure that may be of sufficient magnitude to constitute a risk of electric shock to persons.

CAUTION

**RISK OF ELECTRIC SHOCK
DO NOT OPEN**

CAUTION:
TO PREVENT THE RISK OF ELECTRIC SHOCK, DO NOT REMOVE COVER (OR BACK). NO USER-SERVICEABLE PARTS INSIDE. REFER SERVICING TO QUALIFIED SERVICE PERSONNEL.



The exclamation point within an equilateral triangle is intended to alert the user to the presence of important operating and maintenance (servicing) instructions in the literature accompanying the appliance.

D1-4-2-3_En

IMPORTANT NOTICE – THE SERIAL NUMBER FOR THIS EQUIPMENT IS LOCATED IN THE REAR. PLEASE WRITE THIS SERIAL NUMBER ON YOUR ENCLOSED WARRANTY CARD AND KEEP IN A SECURE AREA. THIS IS FOR YOUR SECURITY.

D1-4-2-6-1_En

This Class B digital apparatus complies with Canadian ICES-003.

Cet appareil numérique de la Classe B est conforme à la norme NMB-003 du Canada.

D8-10-1-3_EN

CAUTION

This product is a class 1 laser product, but this product contains a laser diode higher than Class 1.
To ensure continued safety, do not remove any covers or attempt to gain access to the rear of the product.
Refer all servicing to qualified personnel.
The following caution label appears on your unit.
Location: inside of the unit

**CLASS 1 LASER PRODUCT
APPAREIL À LASER DE CLASSE 1**

CAUTION	CLASS 3B VISIBLE AND INVISIBLE LASER RADIATION WHEN OPEN, AVOID EXPOSURE TO THE BEAM.	VRW2262 - A
ATTENTION	RADIATIONS LASER VISIBLES ET INVISIBLES DE CLASSE 3B QUAND OUVERT. ÉVITEZ TOUT EXPOSITION AU FAISCEAU.	
ADVARSEL	KLASSE 3B SYNLIG OG USYNLIG LASERSTRÅLING VED ÅBNING. UNDGÅ UDSÆTTELSE FOR STRÅLING.	
VARNING	KLASSE 3B SYNLIG OCH OSYNLIG LASERSTRÅLNING NÄR DENNA DEL ÄR ÖPPNAD. UNDVIK ATT UTSÄTTA DIG FÖR STRÅLEN.	
VORSICHT	BEI GEÖFFNETER ABDECKUNG IST SICHTBARE UND UNSICHTBARE LASERSTRAHLUNG DER KLASSE 3B IM GERÄTENNEREN VORHANDEN. NICHT DEM LASERSTRAHL AUSSETZEN!	
PRECAUCIÓN	CUANDO SE ABRE HAY RADIACIÓN LÁSER DE CLASE 3B VISIBLE E INVISIBLE. EVITE LA EXPOSICIÓN A LOS RAYOS LÁSER.	
VARO!	AVATTAESSA OLET ALTIINA NÄKYVÄLLE JA NÄKYMÄTTÖMÄLLE LUOKAN 3B LASERSÄTELYLLE. ÄLÄ KATSO SÄTEESEEN.	
注意	打開時會有CLASS 3B可見和不可見鐳射輻射・請勿受鐳射束輻射。	
注意	ここを開くと CLASS 3B の可視レーザー光及び不可視レーザー光が出ます。ビームを直接見たり、触れたりしないこと。	

D3-4-2-1-8_B_En

If the AC plug of this unit does not match the AC outlet you want to use, the plug must be removed and appropriate one fitted. Replacement and mounting of an AC plug on the power supply cord of this unit should be performed only by qualified service personnel. If connected to an AC outlet, the cut-off plug can cause severe electrical shock. Make sure it is properly disposed of after removal.
The equipment should be disconnected by removing the mains plug from the wall socket when left unused for a long period of time (for example, when on vacation).

D3-4-2-2-1a_A_En

CAUTION

The STANDBY/ON switch on this unit will not completely shut off all power from the AC outlet. Since the power cord serves as the main disconnect device for the unit, you will need to unplug it from the AC outlet to shut down all power. Therefore, make sure the unit has been installed so that the power cord can be easily unplugged from the AC outlet in case of an accident. To avoid fire hazard, the power cord should also be unplugged from the AC outlet when left unused for a long period of time (for example, when on vacation).

D3-4-2-2-2a_A_En

NOTE TO CATV SYSTEM INSTALLER

THIS REMINDER IS PROVIDED TO CALL THE CATV SYSTEM INSTALLER'S ATTENTION TO ARTICLE 820-40 OF THE NEC THAT PROVIDES GUIDELINES FOR PROPER GROUNDING AND, IN PARTICULAR, SPECIFIES THAT THE CABLE GROUND SHALL BE CONNECTED TO THE GROUNDING SYSTEM OF THE BUILDING, AS CLOSE TO THE POINT OF CABLE ENTRY AS PRACTICAL.

D1-4-2-8_En

WARNING

Before plugging in for the first time, read the following section carefully.

The voltage of the available power supply differs according to country or region. Be sure that the power supply voltage of the area where this unit will be used meets the required voltage (e.g., 230 V or 120 V) written on the rear panel.

D3-4-2-1-4_A_En

WARNING

To prevent a fire hazard, do not place any naked flame sources (such as a lighted candle) on the equipment.

D3-4-2-1-7a_A_En

VENTILATION CAUTION

When installing this unit, make sure to leave space around the unit for ventilation to improve heat radiation (at least 10 cm at top, 10 cm at rear, and 10 cm at each side).

WARNING

Slots and openings in the cabinet are provided for ventilation to ensure reliable operation of the product, and to protect it from overheating. To prevent fire hazard, the openings should never be blocked or covered with items (such as newspapers, table-cloths, curtains) or by operating the equipment on thick carpet or a bed.

D3-4-2-1-7b_A_En

Operating Environment

Operating environment temperature and humidity:
+5 °C to +35 °C (+41 °F to +95 °F); less than 85 %RH (cooling vents not blocked)
Do not install this unit in a poorly ventilated area, or in locations exposed to high humidity or direct sunlight (or strong artificial light)

D3-4-2-1-7c_A_En

This product is for general household purposes. Any failure due to use for other than household purposes (such as long-term use for business purposes in a restaurant or use in a car or ship) and which requires repair will be charged for even during the warranty period.

K041_En

WARNING

This equipment is not waterproof. To prevent a fire or shock hazard, do not place any container filled with liquid near this equipment (such as a vase or flower pot) or expose it to dripping, splashing, rain or moisture.

D3-4-2-1-3_A_En

POWER-CORD CAUTION

Handle the power cord by the plug. Do not pull out the plug by tugging the cord and never touch the power cord when your hands are wet as this could cause a short circuit or electric shock. Do not place the unit, a piece of furniture, etc., on the power cord, or pinch the cord. Never make a knot in the cord or tie it with other cords. The power cords should be routed such that they are not likely to be stepped on. A damaged power cord can cause a fire or give you an electrical shock. Check the power cord once in a while. When you find it damaged, ask your nearest PIONEER authorized service center or your dealer for a replacement.

5002_En

This product contains mercury. Disposal of this material may be regulated due to environmental considerations. For disposal or recycling information, please contact your local authorities or the Electronics Industries Alliance : www.eiae.org.

K057_En

Recording equipment and copyright: You may use this product only to reproduce or copy materials for which you own the copyright or have obtained permission to copy from the copyright owner or for which you otherwise have a legal right to reproduce or copy. Unless you own the copyright or have obtained permission from the copyright owner or otherwise have a legal right to reproduce or copy, you may be violating the law, including copyright law, and may be subject to payment of damages and other remedies.

K018US_En

WARNING: Handling the cord on this product or cords associated with accessories sold with the product will expose you to chemicals listed on proposition 65 known to the State of California and other governmental entities to cause cancer and birth defect or other reproductive harm.
Wash hands after handling

D36-P4_A_En

WARNING – TO PREVENT FIRE OR SHOCK HAZARD, DO NOT EXPOSE THIS APPLIANCE TO RAIN OR MOISTURE.

D1-4-2-1_En



Dear Customer:

Selecting fine audio equipment such as the unit you've just purchased is only the start of your musical enjoyment. Now it's time to consider how you can maximize the fun and excitement your equipment offers. This manufacturer and the Electronic Industries Association's Consumer Electronics Group want you to get the most out of your equipment by playing it at a safe level. One that lets the sound come through loud and clear without annoying blaring or distortion-and, most importantly, without affecting your sensitive hearing.

Sound can be deceiving. Over time your hearing "comfort level" adapts to higher volumes of sound. So what sounds "normal" can actually be loud and harmful to your hearing. Guard against this by setting your equipment at a safe level BEFORE your hearing adapts.

To establish a safe level:

- Start your volume control at a low setting.
- Slowly increase the sound until you can hear it comfortably and clearly, and without distortion.

Once you have established a comfortable sound level:

- Set the dial and leave it there.

Taking a minute to do this now will help to prevent hearing damage or loss in the future. After all, we want you listening for a lifetime.

We Want You Listening For A Lifetime

Used wisely, your new sound equipment will provide a lifetime of fun and enjoyment. Since hearing damage from loud noise is often undetectable until it is too late, this manufacturer and the Electronic Industries Association's Consumer Electronics Group recommend you avoid prolonged exposure to excessive noise. This list of sound levels is included for your protection.

Decibel Level Example

30	Quiet library, soft whispers
40	Living room, refrigerator, bedroom away from traffic
50	Light traffic, normal conversation, quiet office
60	Air conditioner at 20 feet, sewing machine
70	Vacuum cleaner, hair dryer, noisy restaurant
80	Average city traffic, garbage disposals, alarm clock at two feet.

THE FOLLOWING NOISES CAN BE DANGEROUS UNDER CONSTANT EXPOSURE

90	Subway, motorcycle, truck traffic, lawn mower
100	Garbage truck, chain saw, pneumatic drill
120	Rock band concert in front of speakers, thunderclap
140	Gunshot blast, jet plane
180	Rocket launching pad

Information courtesy of the Deafness Research Foundation.



Contents

01 Before you start

What's in the box	7
Putting the batteries in the remote control.....	7
Using the remote control.....	7
Disc/content format playback compatibility	8
About the internal hard disk drive	13
Symbols used in this manual	14

02 Connections

Rear panel connections.....	15
Front panel connections	16
Easy connections	17
Using other types of video output	18
Connecting to a cable box or satellite receiver (1)	19
Connecting to a cable box or satellite receiver (2)	20
Connecting to an AV amplifier or receiver	21
Connecting using HDMI	22
Connecting other AV sources	23
Connecting a USB device	24
Plugging in	25

03 Controls and displays

Front panel	26
Display	27
Remote control	28

04 Getting started

Switching on and setting up	30
-----------------------------------	----

05 Recording

About DVD recording	33
About HDD recording.....	34
Recorded audio	35
Restrictions on video recording	35
Using the built-in TV tuner	36
Setting the picture quality/recording time	36
Basic recording from the TV	37
Setting a timer recording	38
Simultaneous recording and playback (Chase Play).....	45
Recording from an external component.....	46
Automatic recording from a satellite tuner.....	46
Playing your recordings on other DVD players	48
Initializing recordable DVD discs	49
DVD-RW Auto Initialize.....	50

06 Playback

Introduction	51
Basic playback	51
Using the Disc Navigator to browse the contents of a disc.....	55
Scanning discs.....	56
Playing in slow motion	56
Frame advance/frame reverse	57
The Play Mode menu	57
Displaying and switching subtitles	59
Switching DVD and DivX soundtracks	60
Switching audio channels	60
Switching camera angles	60
Displaying disc information on-screen	61

07 Playing and recording from a DV camcorder (DVR-650H-K/DVR-550H-K)

Playing from a DV camcorder	62
Recording from a DV camcorder	62
About DV	64

08 Editing

Editing options	65
The Disc Navigator screen	66

09 Copying and backup

Introduction	77
One Touch Copy	77
Using Copy Lists	79
Using disc backup	83

10 Using the Jukebox

Copying music to the HDD	85
Copying files via USB	85
Playing music from the Jukebox	88
Editing Jukebox albums	89

11 The PhotoViewer

Locating JPEG picture files	90
Changing the display style of the PhotoViewer	91
Playing a slideshow	91
Reloading files from a disc or USB device	92
Importing files to the HDD	92
Selecting multiple files or folders	93
Copying files to a DVD-R/RW	94
Copying selected files to a DVD-R/RW	94
Editing files on the HDD	95
Printing file	97

12 The Disc Setup menu

Basic settings	98
Initialize settings	99
Finalize settings	99
Optimize HDD	99
Initialize HDD	100

13 The Video Adjust menu

Setting the picture quality for TV and external inputs	101
Setting the picture quality for disc playback	102

14 The Initial Setup menu

Using the Initial Setup menu	104
Selecting other languages for language options	113

15 Additional information

Minimum copying times	114
Manual recording modes	115
Troubleshooting	116
If the picture freezes and the front panel and remote control buttons stop working	120
On-screen displays	121
Front-panel displays	123
Language code list	124
Country/Area code list	124
Screen sizes and disc formats	125
Handling discs	126
Cleaning the pickup lens	126
Condensation	126
Hints on installation	127
Moving the recorder	127
Resetting the recorder	127
Specifications	128

Chapter 1

Before you start

What's in the box

Please confirm that the following accessories are in the box when you open it:

- Remote control
- AA/R6P dry cell batteries x 2
- Audio/video cable (red/white/yellow)
- RF antenna cable
- Power cable
- These operating instructions
- Warranty card

Putting the batteries in the remote control

- Insert two AA/R6P batteries into the battery compartment following the indications (+, -) inside the compartment.

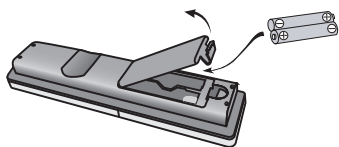

Important

Incorrect use of batteries can result in hazards such as leakage and bursting. Please observe the following:

- Don't mix new and old batteries together.
- Don't use different kinds of batteries together — although they may look similar, different batteries may have different voltages.
- Make sure that the plus and minus ends of each battery match the indications in the battery compartment.

- Remove batteries from equipment that isn't going to be used for a month or more.
- When disposing of used batteries, please comply with governmental regulations or environmental public instruction's rules that apply in your country or area.

WARNING

Do not use or store batteries in direct sunlight or other excessively hot place, such as inside a car or near a heater. This can cause batteries to leak, overheat, explode or catch fire. It can also reduce the life or performance of batteries.

D3-4-2-3-3_En

Using the remote control

Please keep in mind the following when using the remote control:

- Make sure that there are no obstacles between the remote and the remote sensor on the unit.
- Remote operation may become unreliable if strong sunlight or fluorescent light is shining on the unit's remote sensor.
- Remote controllers for different devices can interfere with each other. Avoid using remotes for other equipment located close to this unit.
- Replace the batteries when you notice a fall off in the operating range of the remote.
- When the batteries run down or you change the batteries, the remote control mode is reset to Recorder 1. See *Remote Control Mode* on page 111.
- Use within the operating range in front of the remote control sensor on the front panel, as shown.

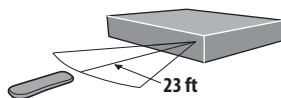

Before you start

- You can control this recorder using the remote sensor of another Pioneer component via the **CONTROL IN** jack on the rear panel. See *Rear panel connections* on page 15 for more information.

Disc/content format playback compatibility

Compatible media

- DVD-RW ver. 1.1 / 1x / 1x to 2x, ver. 1.2 / 2x to 4x / 2x to 6x
- DVD-R ver. 2.0 / 1x / 1x to 4x / 1x to 8x / 1x to 16x, ver. 2.1 / 1x to 8x / 1x to 16x
- DVD+RW 1x to 2.4x / 1x to 4x / 3.3x to 8x
- DVD+R 1x to 2.4x / 1x to 4x / 1x to 8x / 1x to 16x
- DVD-RAM ver. 2.0 / 2x, ver. 2.1 / 2x / 2x to 3x / 2x to 5x, ver. 2.2 / 2x / 2x to 3x / 2x to 5x
- DVD-R DL ver. 3.0 / 2x to 4x / 2x to 8x
- DVD+R DL 2.4x / 2.4x to 8x

Note that older models of DVD recorders and DVD writers may reject DVD-RW ver. 1.2 discs and/or corrupt the data on the disc. If you want to share DVD-RW discs between this recorder and an older recorder/writer, we recommend using ver. 1.1 discs.

The following table shows older Pioneer DVD recorders' limited compatibility with DVD-RW ver. 1.2 discs.

Model	Playable	Recordable
DVR-7000	Yes ^{*1,2,3}	No
DVR-810 H DVR-57H DVR-210 DVR-310 DVR-510H	Yes ^{*1}	No

^{*1} Discs should be finalized in this recorder before playing. Unfinalized VR mode and Video mode discs may not play.

^{*2} **Cannot read the CPRM information** will show in the display when you load a disc. However, this will not affect playback.

^{*3} Copy-once protected disc titles will not play.

Readable file system

This recorder can play DVDs recorded under the following file systems¹: ISO 9660*, UDF 1.02, UDF 1.50, UDF 2.00, UDF 2.01.

* ISO 9660 Level 1 or 2 compliant. Romeo and Joliet file systems are both compatible with this recorder.

Note

















¹ Depending on the recording technique used, even files recorded in compatible file systems may not play correctly.

- MP3/WMA files can be played back when recorded onto a DVD that contains no video files and uses the UDF 1.02, UDF 1.50, UDF 2.01 or ISO 9660 file systems.

Before you start

HDD/DVD Recording and playback compatibility

This recorder can play and record all widely-used DVD disc types, and additionally provides HDD functionality. The table below shows some specific compatibility differences between the different disc types.

	HDD	DVD-R	DVD-RW	DVD+R	DVD+RW	DVD-RAM
Marks used in this manual		 	 			
		*1	*1	*2		*13, 16
Logos			 		 	
Re-recordable/ Erasable	●	*3	*3	●	*3	● *14
Editing of recorded programmes	●	●	● *4	●	● *4	● *4
Recording of Copy- once protected material	●	● *12	● *12			● *12
Playback in other players/recorders	n/a	*5	● *6	*7	● *6	● *8
					*6, 15	● *9
Chase play	●					
16:9 and 4:3 programme recording	●	●		●		●
Dual mono broadcast recording of both audio channels	● *10, 11	● *11		● *11		● *11

Notes to table

*1 Must be initialized for VR mode recording (page 99).

*2 Must be initialized for Video mode recording (page 99).

*3 Erasable, but free space does not increase.

*4 Cannot erase sections, edit chapters or use playlist editing.

*5 Must be compatible with DVD-R (VR) playback.

*6 Finalize using this recorder (may not playback in some units) (page 48).

*7 Must be compatible with DVD-RW (VR) playback.

*8 Must be compatible with DVD+RW playback.

*9 Must be compatible with DVD-RAM playback.

*10 Only when HDD Recording Format is set to Video Mode Off (page 109).

*11 Only when the recording mode is not set to LPCM.

*12 CPRM-compatible discs only.

*13 Take the disc out of the cartridge before use. Only Panasonic and Maxell discs have been tested to work reliably with this recorder. Discs from other makers may become unusable when recorded or edited.

*14 Erasing a title does not increase the available recording time, nor increase the number of recordable titles left.

*15 Must be compatible with DVD+R playback.

*16 Depending on the disc, it may have to be initialized before it can be recorded (page 99). In this case, initialization will take about an hour.

 is a trademark of DVD Format/Logo Licensing Corporation.

Using DVD-R DL/DVD+R DL discs

DVD-R DL (Dual-Layer) and DVD+R DL (Double-Layer) discs contain two recordable layers on a single side, giving about 1.8 times the recording capacity of a conventional single-layer disc. This unit can record to both DVD-R DL and DVD+R DL discs.

- If you intend to play DVD-R DL (Video mode) or DVD+R DL discs recorded on this unit on other DVD recorders/players, you must finalize them. (Note that some DVD recorders/players may not play even finalized DL discs.)
- This logo indicates that the disc is a DVD-R DL or DVD+R DL disc:



Correct operation has been confirmed for DL discs:

- DVD-R DL ver. 3.0/2x to 4x
Mitsubishi Kagaku Media (Verbatim)
- DVD-R DL ver. 3.0/2x to 8x
Mitsubishi Kagaku Media (Verbatim)
That's
JVC
- DVD+R DL 2.4x
Mitsubishi Kagaku Media (Verbatim)
RICOH
- DVD+R DL 2.4x to 8x
Mitsubishi Kagaku Media (Verbatim)
RICOH

About DualDisc playback

A DualDisc is a new two-sided disc, one side of which contains DVD content –video, audio, etc. –while the other side contains non-DVD content such as digital audio material.

The non-DVD, audio side of the disc is not compliant with the CD Audio specification and therefore may not play.

It is possible that when loading or ejecting a DualDisc, the opposite side to that being played will be scratched. Scratched discs may not be playable.

The DVD side of a DualDisc plays in this product. DVD-Audio content will not play.

For more detailed information on the DualDisc specification, please refer to the disc manufacturer or disc retailer.

Other disc compatibility

In addition to DVD, this recorder is compatible with a wide range of disc types (media) and formats. Playable discs will generally feature one of the logos on the disc and/or disc packaging shown below. Note however that some disc types, such as recordable CD (and DVD), may be in an unplayable format — see below for further compatibility information.



CD-R/-RW compatibility

This recorder cannot record CD-R or CD-RW discs.

- Readable formats: CD-Audio, Video CD, ISO 9660 CD-ROM* containing MP3, WMA, JPEG or DivX files
* ISO 9660 Level 1 or 2 compliant. CD physical format: Mode1, Mode2 XA Form1. Romeo and Joliet file systems are both compatible with this recorder.
- Multi-session playback: Yes (except CD-Audio and Video CD)
- Unfinalized disc playback: CD-Audio only

Compressed audio compatibility

- Compatible media: DVD-ROM, DVD-R/-RW, DVD+R/+RW, DVD-RAM, CD-ROM, CD-R, CD-RW
DVR-650H-K/DVR-550H-K only: USB
- Compatible formats: MPEG-1 Audio Layer 3 (MP3), Windows Media Audio (WMA)
- Sampling rates: 32 kHz, 44.1 kHz or 48 kHz
- Bit-rates: Any (128 kbps or higher recommended)

Before you start

- Variable bit-rate (VBR) MP3 playback: Yes
- VBR WMA playback: No
- WMA encoder compatibility: Windows Media Codec 8 (*files encoded using Windows Media Codec 9 may be playable but some parts of the specification are not supported; specifically, Pro, Lossless, Voice and VBR*)
- DRM (Digital Rights Management)¹ file playback: No
- File extensions: .mp3, .wma (these must be used for the recorder to recognize MP3 and WMA files – do not use for other file types)
- File structure: Up to 99 folders/999 files (if these limits are exceeded, only files and folders up to these limits are playable)

WMA (Windows Media™ Audio) compatibility

This recorder can playback Windows Media Audio content.

WMA is an acronym for Windows Media Audio and refers to an audio compression technology developed by Microsoft Corporation. WMA content can be encoded by using Windows Media Player for Windows XP, Windows Media Player 9 or Windows Media Player 10 series.

Windows Media is a trademark of Microsoft Corporation.

This product includes technology owned by Microsoft Corporation and cannot be used or distributed without a license from Microsoft Licensing, Inc.

DivX video compatibility



DivX is a compressed digital video format created by the DivX[®] video codec from DivX, Inc. This recorder can play DivX video files burned on CD-R/-RW/-ROM discs. Keeping the same terminology as DVD-Video, individual DivX video files are called "Titles". When naming files/titles on a CD-R/-RW disc prior to burning, keep in mind that by default they will be played in alphabetical order.

- Official DivX[®] Certified product.
- Plays all versions of DivX[®] video (including DivX[®] 6) with standard playback of DivX[®] media files.
- File extensions: .avi and .divx (these must be used for the recorder to recognize DivX video files). *Note that all files with the .avi extension are recognized as MPEG4, but not all of these are necessarily DivX video files and therefore may not be playable on this recorder.*
- File structure: Up to 99 folders or 999 files.

DivX, DivX Certified, and associated logos are trademarks of DivX, Inc. and are used under license.

Note

¹ DRM (digital rights management) copy protection is a technology designed to prevent unauthorized copying by restricting playback, etc. of compressed audio files on devices other than the PC (or other recording equipment) used to record it. For detailed information, please see the instruction manuals or help files that came with your PC and/or software.

DivX® VOD content



In order to play DivX VOD (video on demand) content on this recorder, you first need to register the recorder with your DivX VOD content provider. You do this by generating a DivX VOD registration code, which you submit to your provider.

Some DivX VOD content may only be playable a fixed number of times. When you load a disc containing this type of DivX VOD content, the remaining number of plays is shown on-screen and you then have the option of playing the disc (thereby using up one of the remaining plays), or stopping. If you load a disc that contains expired DivX VOD content (for example, content that has zero remaining plays), the message **Rental Expired** is displayed.

If your DivX VOD content allows an unlimited number of plays, then you may load the disc into your recorder and play the content as often as you like, and no message will be displayed.



Important

- DivX VOD content is protected by a DRM system. This restricts playback of content to specific, registered devices.
- If you load a disc that contains DivX VOD content not authorized for this recorder, the message **Authorization Error** is displayed and the content will not play.
- Resetting the recorder (as described in *Resetting the recorder* on page 127) will not cause you to lose your registration code.

JPEG file compatibility

- Compatible formats: Baseline JPEG and EXIF 2.2* still image files
*File format used by digital still cameras
- Sampling ratio: 4:4:4, 4:2:2, 4:2:0
- Horizontal resolution: 160 to 5120 pixels
- Vertical resolution: 120 to 3840 pixels
- Progressive JPEG compatible: No

- File extensions: .jpg, .jpeg, .jpe, .jif, .jffif (must be used for the recorder to recognize JPEG files – do not use for other file types)
- File structure: The recorder can load up to 99 folders/999 files at one time (*if there are more files/folders than this on the disc then more can be reloaded*)

PC-created disc compatibility

Discs recorded using a personal computer may not be playable in this unit due to the setting of the application software used to create the disc. In these particular instances, check with the software publisher for more detailed information.

Discs recorded in packet write mode (UDF format) are not compatible with this recorder.

Check the DVD-R/-RW or CD-R/-RW software disc boxes for additional compatibility information.

Dolby Digital



Manufactured under license from Dolby Laboratories. "Dolby" and the double-D symbol are trademarks of Dolby Laboratories.

DTS



"DTS" and "DTS Digital Out" are registered trademarks of DTS, Inc.

About the internal hard disk drive

The internal hard disk drive (HDD) is a fragile piece of equipment. When used without the proper care or in the wrong conditions, it is possible that recorded contents may be damaged or lost entirely, in some cases making even normal playback or recording impossible. Please understand that in the event of repair or replacement of the HDD or related components, all your HDD recordings will be lost.

Please use the recorder following the guidelines below to protect against possible HDD failure.

The HDD should not be regarded as a place to store recordings permanently. We recommend that you back up your important recordings onto DVD discs in order to protect against accidental loss.

Pioneer cannot under any circumstances accept responsibility for any direct or indirect loss arising from any inconvenience or loss of recorded material resulting from HDD failure.

- Install and use the recorder on a stable, level surface.
- Do not block the rear vent/cooling fan.
- Do not use the recorder in excessively hot or humid places, or in places that may be subject to sudden changes in temperature. Sudden changes in temperature can cause condensation to form inside the recorder. This can be a cause of HDD failure.
- Do not move the recorder immediately after switching it off. If you need to move the recorder, please follow the steps below:
 - 1** After the message **POWER OFF** is shown on the front panel display, wait at least two minutes.
 - 2** Unplug from the wall socket.
 - 3** Move the recorder.
- If there's a power failure while the recorder is on there is a chance that some data on the HDD will be lost.













- The HDD is very delicate. If used over time in an improper manner or in an unsuitable environment, it is possible that the HDD will fail. Signs of problems include playback unexpectedly freezing and noticeable block noise (mosaic) in the picture. However, sometimes there will be no warning signs of HDD failure. If the HDD fails, no playback of recorded material will be possible. In this case it will be necessary to replace the HDD unit.

Optimizing HDD performance

As you record and edit material on the HDD, the data on the disk becomes fragmented, eventually affecting the recorder's performance. Before this happens, the recorder will warn you that it is time to optimize the HDD (which you can do from the Disc Setup menu; see *Optimize HDD* on page 99).

Symbols used in this manual

The following icons are provided to help you quickly identify which instructions you need for which kind of disc.

	HDD
	Any type of DVD disc (recordable or playback only), finalized or not.
	Commercially produced DVD, finalized Video mode DVD-R/-RW.
	Video mode DVD-R/-RW (unfinalized)
	VR mode DVD-R/-RW
	DVD+R
	DVD+RW
	DVD-RAM
	Audio CD
	Video CD
	WMA or MP3 files
	DivX files
	All of the above

Chapter 2

Connections

Rear panel connections

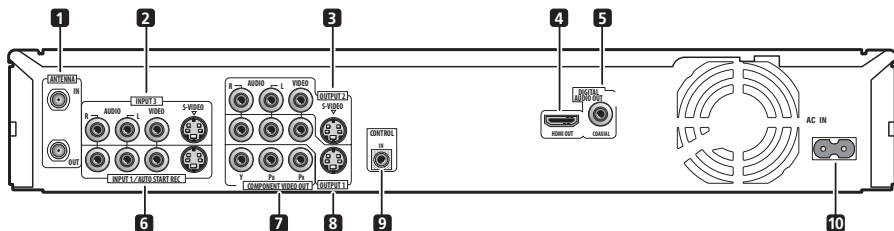

1 ANTENNA IN (RF IN)/OUT

Connect your TV antenna to the **ANTENNA IN (RF IN)** jack. The signal is passed through to the **ANTENNA OUT** jack for connection to your TV.

2 INPUT 3

Stereo analog audio, video and S-video inputs for connection to a satellite receiver, set top box, etc.

3 OUTPUT 2

Stereo analog audio, video and S-video outputs for connection to a TV or AV amplifier/receiver.

4 HDMI OUT

HDMI output for high quality digital audio and video.

5 DIGITAL AUDIO OUT (COAXIAL)

Coaxial digital audio jack for connecting to an AV amplifier/receiver, Dolby Digital/DTS decoder or other equipment with a digital input.

6 INPUT 1/AUTO START REC

Stereo analog audio, video and S-video inputs for connection to a satellite receiver, set top box, etc.

7 COMPONENT VIDEO OUT

A high-quality video output for connecting to a TV or monitor with a component video input.

8 OUTPUT 1

Stereo analog audio, video and S-video outputs for connection to a TV or AV amplifier/receiver.

9 CONTROL IN

Use to control this recorder from the remote sensor of another Pioneer component with a **CONTROL OUT** terminal and bearing the Pioneer  mark. Connect the **CONTROL OUT** of the other component to the **CONTROL IN** of this recorder using a mini-plug cord.

10 AC IN – Power inlet

Connect to a power outlet using the supplied power cable after making all other connections.

Front panel connections

On the front panel there is a flip-down cover that hides more connections.

Left side:

(DVR-650H-K, DVR-550H-K only)

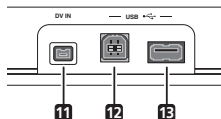

11 DV IN

A DV input i.LINK connector, suitable for connecting a DV camcorder.

12 USB port (Type B)

USB port for connecting a PictBridge-compatible printer or PC.

13 USB port (Type A)

USB port for connecting a digital camera, keyboard or other USB device.

Right side:

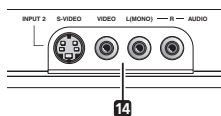

14 INPUT 2

Audio/video input (stereo analog audio; composite and S-video), especially suitable for camcorders, game consoles, portable audio, etc.

Easy connections

The setup described here is a basic configuration that allows you to record TV programmes on both this recorder and your VCR. When watching recordings from this recorder, set your TV to input 1; switch to input 2 to watch a video playing in the VCR.

Important

- This recorder is equipped with copy protection technology. Do not connect this recorder to your TV via a VCR (or your VCR via this recorder) using AV cables, as the picture from this recorder will not appear properly on your TV.
- Before making or changing any rear panel connections, make sure that all components are switched off and unplugged from the wall outlet.

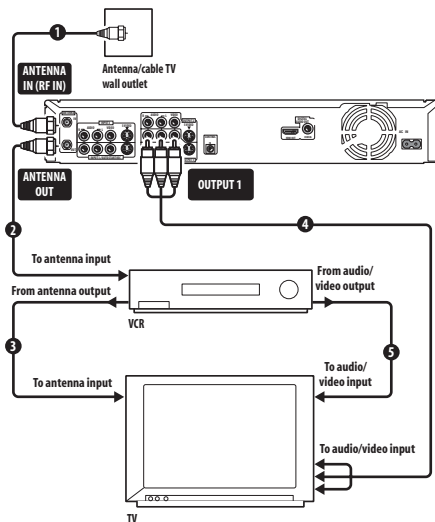

1 Connect your TV antenna/cable TV outlet to the ANTENNA IN (RF IN) jack on this recorder.

2 Use an RF antenna cable (one is supplied) to connect the ANTENNA OUT jack on this recorder to the antenna input on your VCR.

- If you are not connecting a VCR in the chain, connect this recorder directly to your TV and skip the next step.

3 Use an RF antenna cable to connect the antenna output on your VCR to the antenna input on your TV.

4 Connect the AUDIO and VIDEO OUTPUT jacks (1 or 2) to a set of audio/video inputs on your TV.

Use the supplied three-pin audio/video cable. It is colour-coded to help you match them up (red/white for the right/left audio connections and yellow for video in/out). Make sure you match up the left and right outputs with their corresponding inputs for correct stereo sound.

5 Connect your VCR to your TV (A/V IN 2 above) using a set of audio and video cables.

- See the following page if you want to use S-video or component video cables for the video connection.

Using other types of video output

This recorder has standard (composite), S-video and component video outputs. The main difference between them is the quality of the picture. S-video delivers a better picture than composite video, while component video gives better picture quality still. The variety of outputs also gives you the flexibility of connecting your particular equipment using the best connection type available.

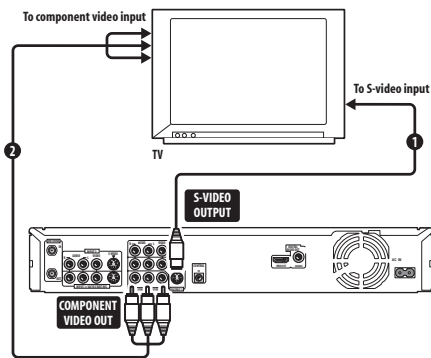

1 Connecting using an S-video output

S-video carries the picture as separate colour and luminance (brightness) signals. There are two S-video outputs for connection to TVs, monitors, VCRs or other equipment.

- Use an S-video cable (not supplied) to connect an S-VIDEO OUTPUT (1 or 2) to an S-video input on your TV, monitor (or other equipment).

2 Connecting using the component video output

Component video carries the picture as two separate colour signals, plus a luminance (brightness) signal.

See also *Component Video Out* on page 105 for how to set up the component video output for use with a progressive scan-compatible TV.

- Use a component video cable (not supplied) to connect the COMPONENT VIDEO OUT jacks to a component video input on your TV, monitor (or other equipment).

Connecting to a cable box or satellite receiver (1)

If you are using a cable box or satellite receiver with only a few scrambled channels, follow the setup on this page¹. If many or all the channels are scrambled, we recommend using the setup on the following page.

Using the setup on this page you can:

- Record unscrambled channels by selecting them on this recorder.
- Record scrambled channels by selecting them on the cable box/satellite receiver and using the Auto Start Recording feature (see *Automatic recording from a satellite tuner* on page 46).
- Watch one channel while recording another.



Important

- Do not connect this recorder 'through' your VCR, satellite receiver or cable box. Always connect each component directly to your TV or AV amp/receiver.

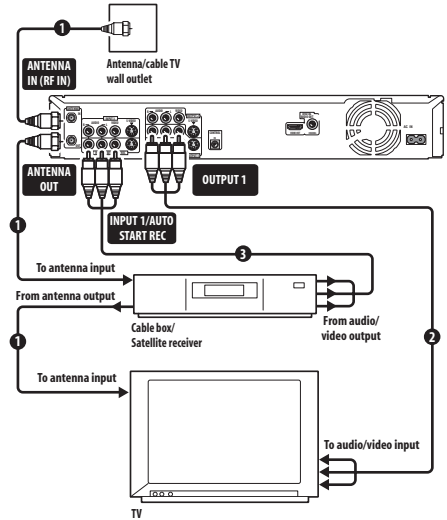

1 Connect RF antenna cables as shown.

This enables you to watch and record TV channels.

2 Connect the AUDIO and VIDEO OUTPUT jacks (1 or 2) on this recorder to a set of audio/video inputs on your TV using a set of A/V cables (as supplied).

This enables you to watch the output from this recorder.

3 Connect the audio/video output of your cable box/satellite receiver to the INPUT 1 jacks on this recorder using a set of A/V cables.

This enables you to record scrambled TV channels.

Note

¹ The diagram shows standard video connections, but you can alternatively use the S-video or component video connections if they're available.

Connecting to a cable box or satellite receiver (2)

If many or all the channels you receive by cable or satellite are scrambled, we recommend using this setup.¹

Using the setup on this page you can:

- Record any channel by selecting it on the cable box/satellite receiver.
- Record using the Auto Start Recording feature (see *Automatic recording from a satellite tuner* on page 46).



Important

- Do not connect this recorder 'through' your VCR, satellite receiver or cable box. Always connect each component directly to your TV or AV amp/receiver.

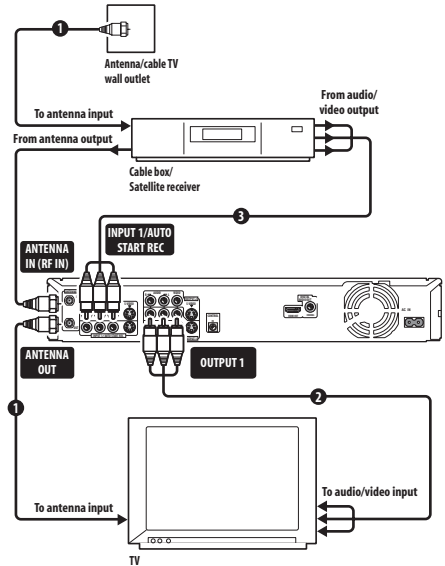

1 Connect RF antenna cables as shown.

This enables you to watch and record TV channels.

2 Connect the AUDIO and VIDEO OUTPUT jacks (1 or 2) on this recorder to a set of audio/video inputs on your TV using a set of A/V cables (as supplied).

This enables you to watch discs.

3 Connect the audio/video output of your cable box/satellite receiver to the INPUT 1 jacks on this recorder using a set of A/V cables.

This enables you to record scrambled TV channels.

Note

- The setup on this page does not allow you to watch one channel and record another.
- The diagram shows standard video connections, but you can alternatively use the S-video or component video connections if they're available.

Connecting to an AV amplifier or receiver

To enjoy multichannel surround sound you need to connect this recorder to an AV amp/receiver using the digital coaxial output. In addition to the digital connection, we recommend also connecting using the stereo analog connection.

You'll probably also want to connect a video output to your AV amp/receiver. Use the standard (composite) video output (as shown here), or the S-video or component video connections.

See also *Audio Out* on page 106 for how to set up the digital audio output. (Noise may be output from your speakers if the recorder is not set up to work with your AV amp/receiver.)



Important

- Do not connect this recorder to your TV 'through' your VCR or other component using A/V cables. Always connect it directly to your TV.

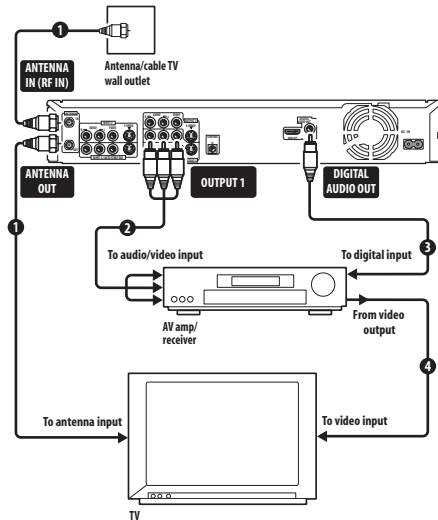

1 Connect RF antenna cables as shown.

This enables you to watch and record TV channels.

2 Connect the AUDIO and VIDEO OUTPUT jacks (1 or 2) on this recorder to a set of audio/video inputs on your AV amp/receiver.

3 Use an coaxial digital audio cable (not supplied) to connect the DIGITAL AUDIO OUT (COAXIAL) jack on this recorder to an coaxial digital input on your AV amp/receiver.

This enables you to listen to multichannel surround sound.¹

4 Connect the AV amp/receiver's video output to a video input on your TV.

Note

¹ If your AV amp/receiver doesn't have an coaxial digital input, but has an optical type, converter boxes that convert from coaxial to optical are available at specialist audio dealers.

Connecting using HDMI

If you have an HDMI or DVI-equipped¹ monitor or display², you can connect it to this recorder using an HDMI cable (not supplied).

The HDMI connector outputs uncompressed digital video, as well as almost every kind of digital audio.

1 Use an HDMI cable to connect the HDMI OUT connector on this recorder to an HDMI connector on an HDMI-compatible display.

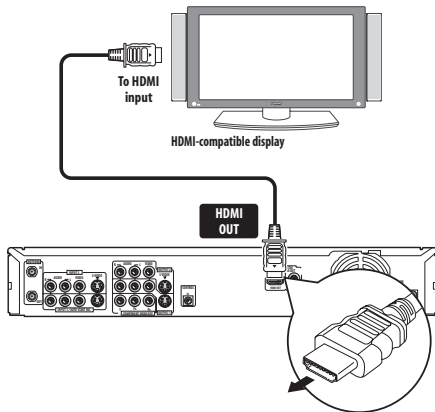

- The arrow on the cable connector body should be face down for correct alignment with the connector on the recorder.

When connected to an HDMI component or HDCP-compatible DVI component, the HDMI indicator lights.

HDMI setup is generally automatic. There are however settings you can change if you need to. See *HDMI Output (only available when an HDMI device is connected)* on

page 110 for more information. Note that the HDMI settings remain in effect until you change them, or connect a new HDMI component.



Important

- An HDMI connection can only be made with DVI-equipped components compatible with both DVI and High-bandwidth Digital Content Protection (HDCP). If you choose to connect to a DVI connector, you will need a DVI to HDMI adaptor cable. A DVI to HDCP connection, however, does not support audio. Consult your local audio dealer for more information.
- The HDMI connection is compatible with 32 kHz, 44.1 kHz, 48 kHz, 96 kHz, 16 bit/20 bit/24 bit 2-channel linear PCM signals, as well as Dolby Digital, DTS and MPEG audio bitstream.
- If your connected component is only compatible with Linear PCM, the signal is output as Linear PCM (DTS audio is not output).
- If you have connected to a Pioneer plasma display, please select the HDMI setup on the display (refer to the supplied manual for more on this).

About HDMI

HDMI (High-Definition Multimedia Interface) supports both video and audio on a single digital connection for use with DVD players and recorders, DTV, set-top boxes, and other AV devices. HDMI was developed to provide the technologies of High-bandwidth Digital Content Protection (HDCP) as well as Digital Visual Interface (DVI) in one specification. HDCP is used to protect digital content transmitted and received by DVI-compliant displays.

Note

¹ Depending on the component you have connected, using a DVI connection may result in unreliable signal transfers.

² The pixel resolution of this recorder's HDMI video output is (according to TV format): NTSC (720 x 480i/p, 1280 x 720p, 1920 x 1080i/p). If your display is not compatible with these resolutions the picture may not be correctly reproduced.

HDMI has the capability to support standard, enhanced, or high-definition video plus standard to multi-channel surround-sound audio. HDMI features include uncompressed digital video, a bandwidth of up to five gigabits per second (Dual Link), one connector (instead of several cables and connectors), and communication between the AV source and AV devices such as DTVs.

HDMI, the HDMI logo and High-Definition Multimedia Interface are trademarks or registered trademarks of HDMI Licensing LLC.

Connecting other AV sources

Connecting a VCR or analog camcorder

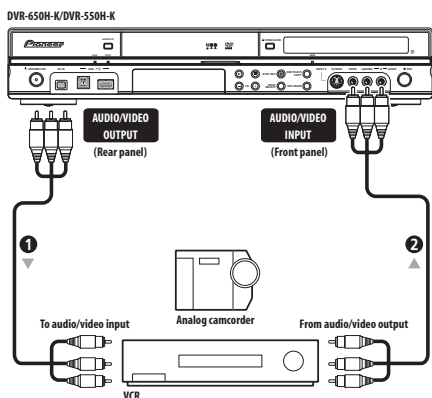

1 Connect a set of audio and video inputs of your VCR or camcorder to a set of outputs on this recorder.

This enables you to record from this recorder to your VCR or camcorder.

- You can use standard video or S-video cables for the video connection.

2 Connect a set of audio and video outputs of your VCR or camcorder to a set of inputs on this recorder.

This enables you to record tapes from your VCR or camcorder.

- You can use standard video or S-video cables for the video connection.

- The front panel connections make convenient connections for a camcorder input.
- When connecting an external AV source that only supports monaural sound, only insert the left (white) audio jack to this device. Doing so will allow the same sound track to be recorded to both channels. You must connect to the **INPUT 2** jack on the front panel.

Connecting a DV camcorder

(DVR-650H-K/DVR-550H-K only)

You can connect a DV camcorder or DVD recorder with DV output to the front panel **DV IN** jack.

Important

- This jack is for connection to DV equipment only. It is not compatible with digital satellite receivers or D-VHS video decks.

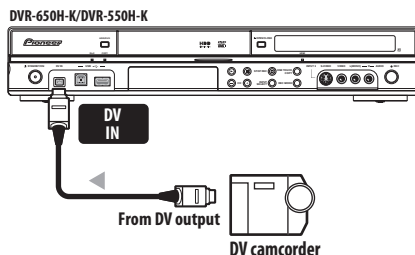

- Use a DV cable (not supplied) to connect the DV jack of your DV camcorder to the front panel DV IN jack of this recorder.**

Connecting a USB device

(DVR-650H-K/DVR-550H-K only)

Using the USB ports on the front of the recorder you can connect USB devices such as digital cameras, printers, keyboards and PCs. Please also see the instructions that came with the device you want to connect before using.

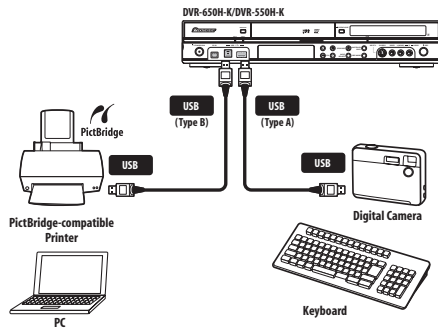

Important

- Some USB devices may not work with this recorder.
- When connecting a PC to this unit, make sure the power is turned off on both the PC and this unit when you connect them via USB.
- We recommend connecting USB devices when this recorder is switched off (in standby).

JPEG file storage devices

- Digital still camera
- Memory card reader (any type of memory card)
- USB memory

The Mass Storage Class (MSC) device should be FAT-compatible. Note that if the device is partitioned, this recorder may not recognize it.

The Picture Transfer Protocol (PTP) can be used to transfer up to maximum 4000 files.

WMA/MP3 file storage devices

- Memory card reader (any type of memory card)
- USB memory
- PC (Use Connect PC function)

The Mass Storage Class (MSC) device should be FAT-compatible. Note that if the device is partitioned, this recorder may not recognize it.

Note that although multi-slot card readers can be used, the recorder will only recognize the first card inserted. To read another card, remove all the cards and insert the card to be read again.

Using a USB hub

- Use a hub compatible with USB 1.1 and/or 2.0.
- Use an independently powered hub (bus powered hubs may not work reliably).
- In the event of unreliable operation with the hub, we recommend plugging the device directly into the recorder's USB port.
- Operation may become unreliable if too many devices are connected to the hub. In this case, try unplugging some devices.
- If the power delivered through a hub is insufficient for the devices connected, communication can become unreliable. In this case, disconnect one or more devices then perform a USB restart. (See *Restart USB Device* on page 112.)

Using a USB printer

- Use a PictBridge-compatible printer.

Using a USB keyboard

- Do not use a PS/2 keyboard connected using a PS/2-USB adapter.

Using a PC

- Note that you can connect a PC to this device via USB to copy WMA and MP3 files. For more information, see *Connect PC* on page 86. To use Connect PC with this device, your PC must run either the Windows XP Home Edition (SP2) or Windows XP Professional (SP2) operating system and be able to run Windows Media Player 10. Even if your PC can run Windows Media Player 10, we cannot guarantee that it will function properly with this device. For more details see the 'Help' section of Windows Media Player 10.

Plugging in

After checking all the connections, plug in the recorder.

- **Use the supplied power cable to connect this recorder to a power outlet.**

Chapter 3

Controls and displays

Front panel

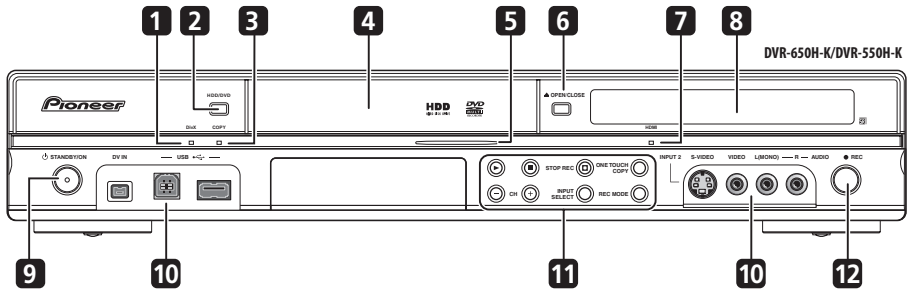
**1 DivX indicator**

Lights when this recorder plays DivX video files.

2 HDD/DVD

Press to switch between HDD and DVD for recording and playback.

3 COPY indicator

Lights when copying is underway.

4 Disc tray**5 HDD/DVD indicator**

Indicator lights blue when the hard disk (HDD) is selected; orange when the DVD drive is selected.

6 ▲ OPEN/CLOSE

Press to open/close the disc tray.

7 HDMI indicator

Lights when this recorder is connected to HDMI (HDCP) compatible component.

8 Front panel display and IR remote sensor

See *Display* on page 27 for details.

9 ⏻ STANDBY/ON

Press to switch the recorder on/into standby.

10 Front panel inputs

See *Front panel connections* on page 16 for more information on these.

11 ▶

Press to start or restart playback.

■ Press to stop playback.

□ STOP REC

Press to stop recording.

ONE TOUCH COPY

Press to start One Touch Copy of the currently playing title to DVD or the HDD.

CH +/-

Use to change channels, skip chapters/tracks, etc.

INPUT SELECT

Press to change the input used for recording.

REC MODE

Press repeatedly to cycle through recording modes (picture quality).

12 ● REC

Press to start recording. Press repeatedly to set the recording time in 30 minute blocks.

Display

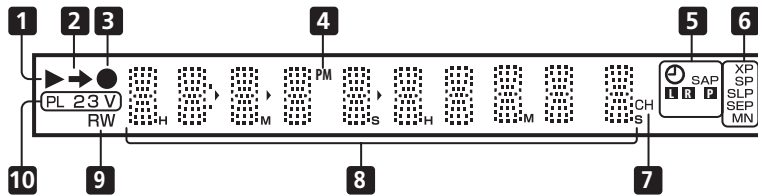

- 1 ▶**
Lights during playback; blinks when playback is paused.
- 2 →**
Lights when copying.
- 3 ●**
Lights during recording; blinks when recording is paused.
- 4 PM**
Lights to indicate PM (after midday) for the clock display.
- 5 ⌚** (page 38)
Lights when a timer recording has been set. (Indicator blinks if the timer has been set to DVD but there isn't a recordable disc loaded, or the timer has been set to HDD but the HDD is not recordable.)

SAP
Lights when the currently selected TV channel has a Second Audio Programme channel.

Ⓛ Ⓜ (page 105)
Indicates which channels are recorded when **Dual Mono** is selected.

Ⓜ (page 105)
Lights when the component video output is set to progressive scan.
- 6 Recording quality indicators** (page 36)

XP
Lights when the recording mode is set to **XP** (best quality).

SP
Lights when the recording mode is set to **SP** (standard play).

LP/SLP
Lights when the recording mode is set to **LP** (long play) or **SLP** (super-long play).

EP/SEP
Lights when the recording mode is set to **EP** (extended play) or **SEP** (super-extended play).

MN
Lights when the recording mode is set to **MN** (manual recording level) mode.
- 7 CH** (page 36)
Channel indicator for the built-in TV tuner.
- 8 Character display**
- 9 R/RW**
Lights when a recordable DVD-R or DVD-RW disc is loaded.
- 10 PL** (page 66)
Lights when a VR mode disc is loaded and the recorder is in Play List mode.

2 3 (page 111)
Shows the remote control mode (if nothing is displayed, the remote control mode is 1).

V
Lights when an unfinalized Video mode disc is loaded.

Remote control

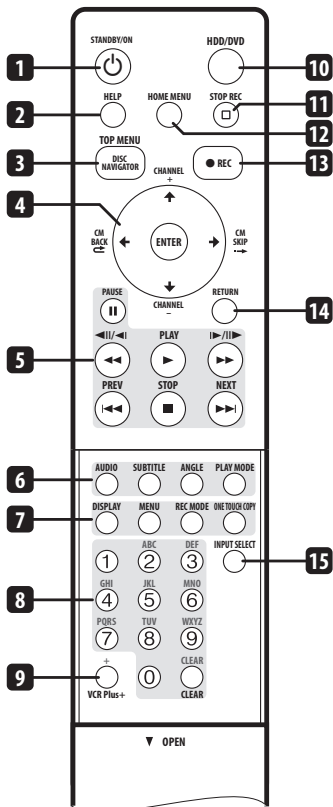

1 **STANDBY/ON**

Press to switch the recorder on/into standby.

2 **HELP**

Press for help on how to use the current GUI screen.

3 **DISC NAVIGATOR** (page 55, 66)/

TOP MENU (page 52)

Press to display the Disc Navigator screen, or the top menu if a DVD-Video or finalized DVD-R/-RW (Video) disc is loaded.

4 **↑/↓/←/→ and ENTER**

Used to navigate all on-screen displays. Press **ENTER** to select the currently highlighted option.

CM BACK (commercial back)

Press repeatedly to skip progressively backward through the video playing.

CM SKIP (commercial skip)

Press repeatedly to skip progressively forward through the video playing.

CHANNEL +/- (page 36)

Press to change the channel of the built-in TV tuner.

5 **Playback controls** (page 51)

II PAUSE

Press to pause playback or recording.

▶ PLAY (page 51)

Press to start playback.

■ STOP (page 51)

Press to stop playback.

◀◀ ▶▶

Press to skip to the previous or next title/ chapter/track/folder; or to display the previous or next menu page.

◀◀ ▶▶ (page 56)

Press to start reverse or forward scanning. Press again to change the speed.

◀◀/◀▶ ▶▶/▶▶ (page 56)

While paused, press and hold to start slow-motion playback. Press repeatedly to change the playback speed.

While paused, press to advance a single frame in either direction.

6 playback function buttons

AUDIO (page 36, 60)

Press to change the audio language or channel. (When the recorder is stopped, press to change the tuner audio.)

SUBTITLE (page 59)

Press to display/change the subtitles included in multilingual DVD-Video discs.

ANGLE (page 60)

Press to switch camera angles on discs with multi-angle scenes.

PLAY MODE (page 57)

Press to change the play mode (search, repeat, programme play, etc.).

7 DISPLAY (page 61)

Displays/changes the on-screen information displays.

MENU (page 52)

Press to display the disc menu if a DVD-Video, finalized DVD-R/-RW or finalized DVD+R/+RW disc is loaded.

REC MODE (page 36)

Press repeatedly to change the recording mode (picture quality).

ONE TOUCH COPY (page 77)

Press to start One Touch Copy of the currently playing title to DVD or the HDD.

8 Number buttons, CLEAR

Use the number buttons for track/chapter/title selection; channel selection, and so on. The same buttons can also be used to enter names for titles, discs and so on.

Use **CLEAR** to clear an entry and start again.

9 VCR Plus+®

Press then use the number buttons to enter a PlusCode® programming number for timer recording.

10 HDD/DVD (page 37)

Press to select the hard disk (HDD) or DVD for recording and playback.

11 STOP REC

Press to stop recording.

12 HOME MENU

Press to display the Home Menu, from which you can navigate all the functions of the recorder.

13 ● REC

Press to start recording. Press repeatedly to set the recording time in blocks of 30 mins.

14 RETURN

Press to go back one level in the on-screen menu or display.

15 INPUT SELECT (page 46)

Press to change the input to use for recording.

Chapter 4

Getting started

Switching on and setting up

When you switch the recorder on for the first time, you can make several basic settings using the Setup Navigator feature. This takes you through setting the clock, the internal TV tuner and the video output.

If you're using the recorder for the first time, we strongly recommend you use the Setup Navigator before starting to use the recorder.

1 Switch on your TV and set the video input to this recorder.

2 Switch on the recorder.

When you switch on for the first time, your TV should display the Setup Navigator screen (If the Setup Navigator doesn't appear, you can also access it from the Initial Setup menu; see page 104).

3 Choose a language (then press ENTER).



This will also set the audio, subtitle and DVD menu language preferences.

4 Start the Setup Navigator.

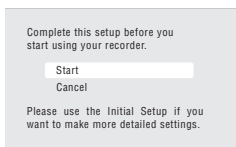

- If you don't want to use the Setup Navigator, press **↓** to select **Cancel**, then press **ENTER** to exit the Setup Navigator.

5 Select 'Antenna' or 'Cable' depending on how you receive your terrestrial TV channels.

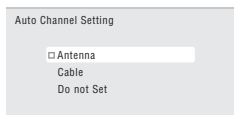

After selecting **Antenna** or **Cable** the recorder starts automatic tuning. This takes a couple of minutes to complete.

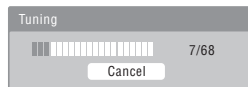

- Select **Do not set** if you want to skip channel setup (because they have already been set up, for example).
- You can go back to the previous screen in the Setup Navigator by pressing **RETURN**.

6 Select 'Auto' for automatic time setting, or 'Manual' to set the clock manually.

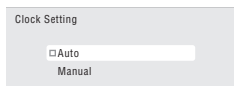

- Auto clock setting**
Some TV channels broadcast time signals together with the programme. This recorder can use these signals to set the clock automatically.

Set 'Clock Set CH' to the channel preset number that broadcasts a time signal, then move the cursor down to 'Start' and press ENTER.

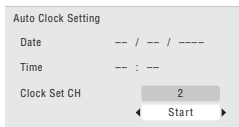

The recorder takes a short while to set the time. After you see that it's set, select **Next** to proceed.

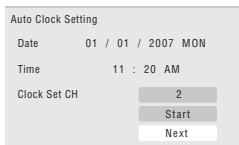

If the time could not be set automatically, press **RETURN** to go back to the previous screen and select **Manual**.

• **Manual clock setting**

If no stations in your area are broadcasting time signals, you can set the clock manually.

Use the **←/→** buttons to set your time zone.

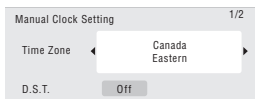

Press **↓** then use the **←/→** buttons to set 'On' or 'Off' for daylight saving (D.S.T), then press ENTER.

Select **On** if you are currently using daylight saving.



Set the date (month/day/year) and time, then press ENTER to make all the settings.

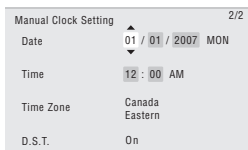

- Use the **↑/↓** buttons to change the value in the highlighted field.
- Use the **←/→** buttons to move from one field to another.
- Press **ENTER** to finish setting the time.

7  Select the TV screen type, 'Wide (16:9)' or 'Standard (4:3)'.



8  Select whether or not your TV is compatible with progressive scan video.



- Note that progressive scan video is only output through the component video outputs.

9  Press to continue after reading the HDD caution.

In the event of HDD failure, recordings may be lost or normal playback/recording may not be possible.

As recordings might be lost in case of a HDD failure, we recommend to use the HDD only as temporary storage media.

Please copy recordings you want to keep to recordable DVD.

Press ENTER to continue.



10 Select 'Finish Setup' to exit the Setup Navigator, or 'Go Back' if you want to start again.

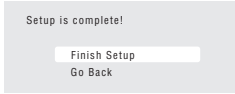

That completes basic setup using the Setup Navigator.

- If there are blank channels with no station, you can set these to skip using the manual channel setting. See *Manual CH Setting* on page 104.

Chapter 5

Recording

About DVD recording

This recorder can record to DVD-R, DVD-RW, DVD+R, DVD+RW, DVD-RAM, DVD-R DL and DVD+R DL media.

DVD-R and DVD-RW discs can be initialized for *Video mode* or *VR mode* recording. Each has its advantages, and it depends on what you want to do with the recording which mode you choose.

If you want to edit your recordings in any significant way, VR mode offers greater possibilities for cutting, copying, and changing the way the video is presented.

Video mode is less flexible when it comes to editing, but it has the advantage that it is compatible with standard DVD players (many of which won't play VR mode discs¹).

Once a disc is initialized for a particular mode, all recording on that disc will be in that mode.

DVD+RW discs can be initialized for *+VR mode* recording.

DVD-RAM discs can be initialized for VR mode recording.

DVD+R discs do not require initializing.



Important

The table below shows the maximum number of titles recordable per disc and the maximum number of chapters per title:

Disc type/rec. format	Max. titles (per disc)	Max. chapters (per title)
DVD-R/-RW Video mode	99	99
DVD-R/-RW/-RAM VR mode	99	999 ^{*1}
DVD+R/+RW	49	99 ^{*2}

^{*1} A maximum of 999 chapters are recordable per disc.

^{*2} A maximum of 254 chapters are recordable per disc.

- This recorder cannot play or record unfinalized DVD-R/-RW (Video mode) and DVD+R discs recorded on another recorder. DVD+RW discs recorded on another recorder are playable on this recorder but are not recordable.
- The maximum continuous recording time for one title is eight hours when using a DVD+R/+RW disc.
- If you delete a title from a DVD+R/+RW disc, the total number of recordable titles remaining may not increase.
- Fingerprints, dirt and small scratches on a disc can affect playback and/or recording performance. Please take proper care of your discs.
- Pioneer takes no responsibility for recording failure due to power cuts, defective discs, or damage to the recorder.
- See also *Disc/content format playback compatibility* on page 8 for detailed disc compatibility information.

Note

¹ Some DVD players, such as some Pioneer models, are compatible with VR mode discs. Check the operating instructions for your player for VR mode compatibility information.

Recording to DVD-R DL/DVD+R DL discs

Recording to DVD-R DL/DVD+R DL discs is generally the same as recording to regular single-layer discs; however, please note the following points:

- When the recorder switches from the first layer to the second during recording a DVD-R DL (Video mode) disc, a new title is automatically started on the new layer.
- Up to 99 titles can be recorded on a DVD-R DL (Video mode) disc. If the 99th title is being recorded when the layer is switched, recording will stop.
- Up to 49 titles can be recorded on a DVD+R DL disc.
- You cannot play, record additional material to, edit or finalize a DVD-R DL or DVD+R DL disc that has been recorded on but not yet finalized on another DVD recorder.

About HDD recording

Recording to the internal hard disk drive (HDD) is very flexible; you have the full choice of recording quality options, including manual mode, and of course you can record, erase and re-record as many times as you like.

The capacity of the hard disk drive means that you can store many hours of video on it, even using the higher quality recording modes.



Important

- The maximum number of titles/chapters per title that can be recorded on the HDD is 999 and 99 respectively. No more recording is possible on the HDD after the maximum number of titles has been reached.
- The maximum continuous recording time for one title is 12 hours.

HDD Video mode compatibility

When recording to the HDD you can choose to record in one of two formats. Set the format from the HDD Recording Format item in the Initial Setup menu (see page 109).

When set to Video Mode On, high-speed copying from HDD to DVD-R/-RW (Video mode) or DVD+R/+RW is possible. When recording a broadcast with a Secondary Audio Programme (SAP) channel, set which channel you want to record from the Initial Setup menu (see *Dual Mono Recording* on page 105).

When HDD Recording Format is set to Video Mode Off, high-speed copying from HDD to DVD-R/-RW (Video mode) or DVD+R/+RW isn't possible. However, both the main and SAP channels are recorded and you can switch the audio on playback.

Recorded audio

In all except the **LPCM** mode, sound is recorded in two channel Dolby Digital format (*only Dolby Digital 2.0 can be recorded; Dolby Digital 5.1 recording is not possible*). When set to **LPCM**, sound is recorded in high quality, uncompressed Linear PCM format.

If the broadcast audio has a SAP channel and you are recording to Video mode DVD-R/-RW, DVD+R/+RW, or to the HDD with the HDD Recording Format set to Video Mode On, or on the **LPCM** setting, use the **AUDIO** button to select the **Mono**, **Stereo** or **SAP** audio channel to record before recording starts. In other cases, if SAP is selected then both the main and SAP audio channels will be recorded and you can switch on playback.

The table below shows the different audio output possibilities:

Audio setting	Audio output	
	Left (L)	Right (R)
MONO	L + R	L + R
STEREO	L	R
SAP	L + R	SAP

Restrictions on video recording

You cannot record copy-protected video using this recorder. Copy-protected video includes DVD-Video discs and some satellite broadcasts. If copy-protected material is encountered during a recording, recording will pause automatically and an error message will be displayed on-screen.

Video that is 'copy-once only' can only be recorded to DVD-RAM or HDD, CPRM-compatible VR mode DVD-R/-RW (see below).

When recording a TV broadcast or through an external input, you can display copy control information on screen (see *Displaying disc information on-screen* on page 61).

CPRM

CPRM is a copy protection/scrambling system developed for the recording of 'copy once' broadcast programmes. CPRM stands for *Content Protection for Recordable Media*.

This recorder is CPRM compatible, which means that you can record copy-once broadcast programmes, but you cannot then make a copy of those recordings. CPRM recordings can only be made on CPRM-compatible DVD-R (ver. 2.0/8x or higher) or DVD-RW (ver. 1.1 or higher) discs formatted in VR mode, DVD-RAM discs or on the HDD.

DVD CPRM recordings can only be played on players that are specifically compatible with CPRM.

Recording equipment and copyright

You may use this product only to reproduce or copy materials for which you own the copyright or have obtained permission to copy from the copyright owner or for which you otherwise have a legal right to reproduce or copy. Unless you own the copyright or have obtained permission from the copyright owner or otherwise have a legal right to reproduce or copy, you may be violating the law, including copyright law, and may be subject to payment of damages and other remedies.

This product incorporates copyright protection technology that is protected by method claims of certain U.S. patents and other intellectual property rights owned by Macrovision Corporation and other rights owners. Use of this copyright protection technology must be authorized by Macrovision Corporation, and is intended for home and other limited viewing uses only unless otherwise authorized by Macrovision Corporation. Reverse engineering or disassembly is prohibited.

Using the built-in TV tuner

There are three different ways to select TV channels. Note that you can't change the TV channel during playback, recording or during recording standby.

- 
CHANNEL +/- buttons

- 
Number buttons



For example, to select channel 4, press **4** then **ENTER**; for channel 34, press **3**, **4**, **ENTER**.¹

- CH +/- buttons** on the front panel

Changing cable channels

When a cable box is connected, you can use the remote to change cable channels (up to 999).



If your cable box is connected to the RF antenna input on this recorder:

- 
 or
 
Change the cable channel.

In this case, you can't change the channel of the built-in tuner.

If your cable box is connected to a set of AV inputs:

- 
Select the cable box input.

- 
 or
 
to change the cable channel.

Changing audio channels

Some TV programmes are broadcast with both a main and a Second Audio Programme (SAP). You can change the TV audio using the **AUDIO** button.

- 
Press to change the audio type.
 The current audio channel is displayed on-screen.

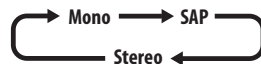

- If **SAP** is selected, but there is no SAP channel being broadcast, you will still hear the main audio channel.
- If the sound is poor quality when set to **Stereo**, you can often improve it by changing to **Mono**.

Note

- When recording to the HDD with HDD Recording Format set to Video Mode On, to DVD in Video mode, or on the **LPCM** setting, only one channel of a dual mono broadcast is recorded. In this case, decide which language you want to record before recording by setting the Dual Mono Recording setting (see *Dual Mono Recording* on page 105).

Setting the picture quality/recording time

DVD (VR) DVD (Video) DVD+R DVD+RW DVD-RAM HDD

Before starting a recording, you will usually want to set the picture quality/recording time. There are six standard settings available, which allow you to choose a balance between picture quality and recording time.

Recording

When Manual Recording is set to On (see *Manual Recording* on page 108), a further option will be available (**MN1 to MN32**, **LPCM**, or **XP+** (a super-high quality HDD recording mode that features a transfer rate of around 15 Mbps) depending on what you set).

When recording to DVD, **MN32** is the highest recording quality available. If you select **XP+**, the recording mode will automatically revert to **MN32**.

When recording to DVD+R/+RW, **SLP** is the longest recording time available. If you select **SEP** or **MN1 to MN3**, the recording mode will automatically revert to **SLP**.

- REC MODE**
- **XP** – High quality setting, gives about one hour of recording time on a DVD disc.
 - **SP** (Standard Play) – Default quality, used for most applications, gives about two hours of recording time on a DVD.
 - **LP** (Long Play) – Lower video quality than SP, but doubles the recording time on a DVD to about four hours.
 - **EP** (Extended Play) – Lower quality than LP, but gives about six hours of recording time on a DVD disc.
 - **SLP** (Super Long Play) – Lower quality than EP, but gives about eight hours of recording time on a DVD disc.
 - **SEP** (Super Extended Play) – Lowest video quality but gives about ten hours of recording time on a DVD disc.
 - **MN1 to MN32/LPCM¹/XP+²** – Manual/Linear PCM/XP+ (available only when manual recording is on).

The setting is indicated in the front panel display, and shown on-screen together with the recording time for a blank recordable disc. If a recordable disc is loaded, the

approximate remaining recording time for that disc is also shown. (Note that if the On Screen Display setting (see *On Screen Display* on page 111) is **Off** then this information is not displayed.)

Basic recording from the TV

DVD (VR) **DVD (Video)** **DVD+R** **DVD+RW** **DVD-RAM** **HDD**

Basic recording from the TV involves just setting the channel to record, choosing whether to record to the HDD or a DVD and selecting the recording quality.

- 1**  **Select the HDD or DVD for recording.**

- If you're recording to DVD, load a recordable disc (if you load a new blank DVD-RW or DVD+RW disc, the recorder takes a short while to initialize the disc).
- If you want to record a VR mode DVD-R or a Video mode DVD-RW, you must initialize it before proceeding (see *Initializing recordable DVD discs* on page 49).

- 2**  **Select a TV channel to record.**
The front panel display shows the channel number:

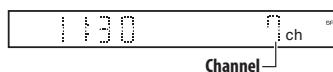

- While the recorder is stopped, you can also use the number buttons on the remote to select the channel (e.g., for channel 24, press **2**, **4** then **ENTER**).
- If the recorder is stopped, you can also use the **CH +/-** buttons on the front panel to select the channel number.

Note

¹ Audio is recorded in 16-bit Linear PCM format, video is recorded at **XP** quality. When recording a broadcast with a SAP channel, select which audio channel to record (see *Dual Mono Recording* on page 105).

² Applicable only to HDD recording. (If this setting is used when recording to DVD, **MN32** is used.) When copied to DVD, **XP+** recordings are always copied in real time.

3 Set the picture quality/recording time.

- See *Setting the picture quality/recording time* on page 36 for detailed instructions.

4 Select the audio channel to record.

See *Changing audio channels* on page 36 for more on this.

- When recording in VR mode (DVD) or with HDD Recording Format set to Video Mode Off (HDD), both mono and SAP audio channels are recorded, allowing you to switch the audio channel on playback. The only exception to this is when the picture quality is set to **LPCM**, in which case you do need to select the audio channel before recording.

5 Start recording.

If you want to set a recording end time, press the **REC** button repeatedly. The recording time increases in 30 minute increments, up to a maximum of six hours. The time the recording will end is shown on-screen and in the front panel display. When the recording ends, the recorder automatically switches into standby if no other operation is being performed.

- To cancel the set recording time, press **REC**.
- If you want to pause recording at any time¹, press **II PAUSE**. Press again to restart the recording. (If recording to the HDD, DVD-RAM or in VR mode, a new chapter is started after recording restarts)

6 Press to stop recording.

- If you set the recording time in the previous step, you can still stop the recording anytime by pressing **STOP REC**.

- Recording will stop automatically when there is no more space on the HDD/ DVD, or after 12 hours of HDD recording (whichever is sooner).

Setting a timer recording

Using the timer recording features you can program up to 32 timer recordings up to a month in advance. Timer recording programmes can be set to record just once, every day, or every week.

There are three ways to set a timer recording; using the Easy Timer Recording feature (see *Easy Timer Recording* on page 39), using the VCR Plus+ programming system (see *Timer recording using the VCR Plus+®** programming system on page 40), or using manual timer recording (see *Setting a manual timer recording* on page 42).

You can set the recording quality for your timer recording in the same way as for a regular recording, but with the added option of an **AUTO** mode, which maximizes the recording quality for the space available on the disc (if recording to DVD), or to fit on to a blank DVD disc (if recording to HDD).

You can set timer recordings to record to a recordable DVD or to the hard disk drive. For regular (daily or weekly) HDD timer recordings that you don't need to keep, you can use the Auto Replace Recording feature to automatically replace the previous timer recording with the new one. Note that when you use this feature, the previous recording made on that timer programme will be replaced by the next one, regardless of whether you have watched it yet or not.

You can also set the recorder so that it will adjust the recording quality to try and fit the recording on to the disc if it would not otherwise fit at the recording quality you set (see *Optimized Rec* on page 108 for more on this).

Finally, if you set a timer recording to record to DVD but there isn't a recordable DVD loaded at the time of the recording, the Recovery Recording feature will automatically record the programme to the HDD for you.

Important

- A timer recording can't be set if there are already 32 timer programmes waiting to be recorded.
- Timer recording will not start if:
 - The recorder is already recording.
 - A disc is being initialized, finalized or unfinalized.
- Timer recording will start when the operation preventing timer recording has finished.
- When the front panel display is set to ON, the timer indicator (⏰) lights in the front panel display when the timer is active. If the indicator is blinking it means that (for a DVD timer recording) there is no disc loaded, or the disc loaded is not recordable (for an HDD timer recording it means that the HDD is not recordable).
- Approximately two minutes before a timer recording is set to start, the recorder will go into timer recording standby. In timer recording standby you cannot use some functions.
- The maximum length for timer recordings made to the HDD is 24 hours. However, because one title (HDD) is limited to 12 hours, recordings over 12 hours will be spread over two titles. Note that there will be a break in the recording of a few seconds between titles.

Easy Timer Recording

As the name suggests, Easy Timer Recording makes setting up a timer recording as simple as possible.

- 1  Select 'Timer Recording', then 'Easy Timer' from the Home Menu.

- 2   Set the TV channel to record.

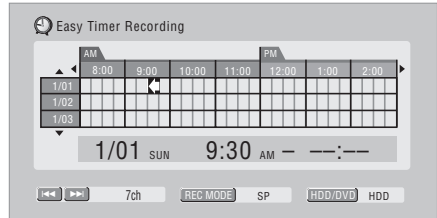

- 3  Set the recording quality.

- *DVD recording:* The **AUTO** option automatically sets the best recording quality for the space available on the disc loaded at the time of recording.
- *HDD recording:* The **AUTO** option automatically sets the best recording quality that would fit on to a blank DVD disc.

- 4  Select the HDD or DVD for recording.

- 5  Move the cursor to the recording start date and time on the grid.

- You can move the cursor forward or back an hour at a time using the ◀◀ and ▶▶ buttons.

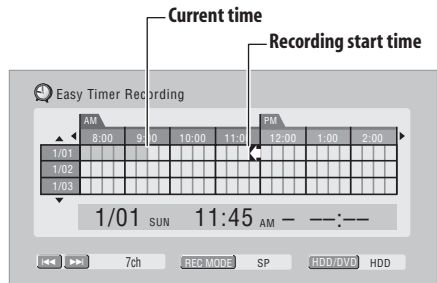

Each row of the grid is one day (you can set the timer recording for up to a month in advance). Each column is a 15 minute interval.

The darker area represents time that has already passed and can't therefore be selected. The lighter area is time that's available.

6 Set the start time.

The start date and time is displayed in the middle of the screen.

- You can go back and reset the start time if you need to by pressing **RETURN**.



7 Move the cursor to the recording end time on the grid.

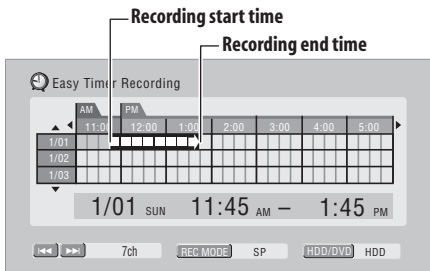

As you move the cursor around the grid, an arrow stretches from the start time to the current cursor position, representing the length of the recording. A recording of up to six hours can be set.

8 Set the end time.



9 Select 'Yes' to set the timer recording and exit, or 'No' to go back to the Easy Timer Recording screen.

- You can check the timer recording details you just set from the main timer recording screen (see *Setting a manual timer recording* on page 42).

Timer recording using the VCR Plus+®* programming system

This system makes programming timer recordings very simple. Most TV guides publish PlusCode programming numbers with their programme details. If you want to

make a timer recording of a programme, you just input the corresponding code. The date, start, stop and channel settings are made automatically. All you have to do is tell the recorder the recording mode, and whether it's a once-only recording or a regular recording.

** VCR Plus+ and PlusCode are registered trademarks of Gemstar Development Corporation.*

The VCR Plus+ system is manufactured under license from Gemstar Development Corporation.

1 Press 'VCR Plus+' to display the VCR Plus+ programme screen.

You can also access this screen from the Home Menu (press **HOME MENU**, select **Timer Recording**, then **VCR Plus+**).

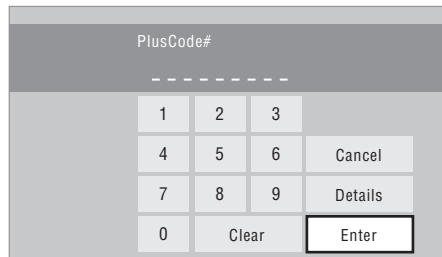

- Use the number buttons to enter the PlusCode number. (To clear the last digit entered, press **CLEAR**.)
- You can also use the **↑/↓/←/→** buttons to select digits from the on-screen display.

2 After making the settings, select 'Enter' and press ENTER.

The timer recording screen appears with the timer programme you just set.

3 Confirm that the settings are correct.

If the channel number isn't displayed, use the **←/→** buttons to highlight **CH**, then use the **↑/↓** buttons to set the correct channel number.

- If the channel number is set, but incorrectly, set up the guide channel (see *VCR Plus+ CH Setting* on page 105).

Recording

- 4 Select 'Store Programme' to finish.
- Other options in the same menu panel allow you to name the programme, and change the recording destination and/or recording mode.

Checking/editing timer recording settings

You can check and/or edit the timer recording settings made by the VCR Plus+ system by selecting **Details** from the PlusCode# setting screen.



- 1 Select 'Details' from the PlusCode# setting screen.

The Timer Programme Set screen appears, filled out with the timer recording details.

- 2 Check and edit the fields as necessary.

See *Setting a manual timer recording* on page 42 for more on this.



- 3 Select 'Store Programme' to save the timer programme and exit.

VCR Plus+ programming with the power off

You can enter a PlusCode programming number when the recorder is in standby.

Note that the recording is always made to the HDD. If you want to record to a DVD disc, you'll need to switch on the power and use the full VCR Plus+ programme screen.



Important

- You can't use this feature until you have set up the guide channels. see *VCR Plus+ CH Setting* on page 105.
- You can't change the recording mode.
- You can't programme daily or weekly timer recordings.

- 1 Press 'VCR Plus+'.

The front panel display shows the current recording mode and prompts you to enter the PlusCode programming number.



- 2 Use the number buttons to enter the PlusCode number.



- To clear the last digit entered, press **CLEAR**.

- 3 Press **ENTER**.

The display shows the timer settings: Date → Start time → End time → HDD and Recording channel → Recording mode

- If **CODE ERROR** appears in the display, check that the number is correct and that the guide channel is set (see *VCR Plus+ CH Setting* on page 105), then set the timer recording again.
- If **CAN'T SET** appears in the display, it means that although you entered a valid PlusCode number, the programme has already finished.

Setting a manual timer recording

The timer recording screen you can see all the timer programmes already set, clear programmes and set up new ones.

1 Press HOME MENU, select Timer Recording, then Timer Recording.

This screen shows all the timer programmes currently set.

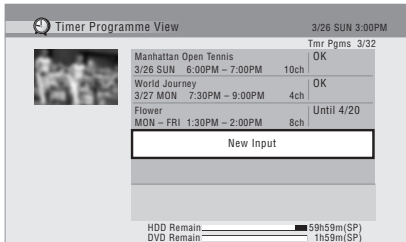

- Each row is for one timer recording programme, with the date and time information, channel, recording mode, DVD or HDD and recording status.
- The amount of free space available on the HDD and the currently loaded recordable DVD is shown towards the bottom of the screen.
- In the upper-right corner, the number of timer programmes already set is shown next to **Tmr Pgms**.
- If there are more than five timer programmes already set, press **NEXT ►►** to switch page (go back using the **PREV ◀◀** button).
- You can also delete a timer programme before it's started (before the recorder enters timer recording standby) by highlighting it and pressing **CLEAR**. See also *Deleting a timer programme* on page 44.

2 Select 'New Input' to set a new timer programme, then press ENTER.

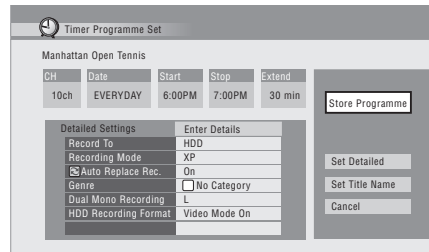

3 Enter the timer recording settings.

Use the **←/→** buttons to select a field; use the **↑/↓** buttons to change the value.

- **CH** – Choose a channel (2 to 69 for antenna channels; 1 to 125 for cable, excluding skip channels), or one of the external inputs from which to record.
- **Date** – Choose a date up to one month in advance, or select a daily or weekly programme.
- **Start** – Set the recording start time.
- **Stop** – Set the recording end time (maximum length of a timer recording is 24 hours).
- **Extend** – Extend the end time of the timer recording (select **Off**, **30**, **60**, **90** or **120** mins).

4 If you want to change the recording mode, recording destination, etc., select 'Set Detailed'.

In this area you can set:

Record to – Select **HDD** for hard disk recording or **DVD** for DVD recording. Select **HDD** for Auto Replace Recording (daily or weekly timer recording only).

Recording Mode – Select **XP**, **SP**, **LP**, **EP**, **SLP** or **SEP**. (See *Setting the picture quality/recording time* on page 36). If Manual Recording is on, then you can also select the **LPCM** setting, **XP+** or **MN** (press **ENTER** then use the **←/→** buttons to select the level).

Auto Replace Rec. – Automatically erases the previous daily or weekly recording when the next one is recorded.

Genre – Select a record genre (for HDD recording only).

Dual Mono Recording – Select which channel of a dual mono broadcast to record (necessary if recording to a Video mode DVD or to the HDD with the **HDD Recording Format** set to **Video Mode On**).

HDD Recording Format – Select **Video Mode On** or **Video Mode Off** depending on whether you need high-speed copying to Video mode DVD capability or not.

5 After entering all the timer recording information, highlight 'Store Programme' and press ENTER.

The timer recording list screen is displayed again. The timer programme you just input appears in the list. The rightmost column shows various timer recording status messages:

- **OK** – Can be recorded.
 - **Time Over** – Not enough space on the HDD (the recording won't finish).
 - **Over 12h** – Recording time of over 12 hours set (when recording to the HDD the recording will be split into two titles).
 - **Overlap** – Two timer programmes partially or completely overlap. The one starting earlier will take priority.
 - **Until ...** (e.g., **Until 8/13**) – For a regular recording, the last programme that could be recorded is shown.
 - **Data Over** – Can't record because the disc management area of the disc is full.
 - **Cancel Once** – A regular timer programme is set to skip.
 - **Can't Rec** – Not possible to record.
 - **Title Over** – Can't record because there is already the maximum number of titles on the disc (HDD: 999; DVD: 99).
 - **Recording** – The programme is currently recording.
 - **Standby** – The recorder is in timer recording standby.
- *nothing displayed* – Another timer recording or copying is in progress.

6 To exit the timer recording screen, press HOME MENU.



Tip

- To enter a title name for the timer recording in advance, select **Set Title Name** and follow the on-screen display.



Note

- If you set a DVD timer recording but there is no recordable DVD disc loaded, or the disc loaded doesn't have enough free space for the complete recording, **Recovery** is shown. In this case (unless you load a suitable disc before the recording actually starts), the recorder will use the HDD for recording. (The message **Can't Rec** will appear if there are already 999 titles on the HDD or if there is not enough free space on the HDD for recording.)
- For a DVD timer recording, if **Optimized Rec** (see *Optimized Rec* on page 108) is set to **On**, the recorder will adjust the recording quality to try and fit the recording on the disc. If the recording will not fit onto the disc even on **MN1 (MN4 for DVD+R/+RW)** recording quality then the Recovery Recording feature will automatically make the recording to the HDD instead.
- If there is very little free space left on the HDD, an Auto Replace Recording may not complete successfully.
- If the HDD is being used for playback or high-speed copying when an Auto Replace Recording is due to start, the new timer recording will not replace the old one. However, the next time the timer recording starts, both of the older two programmes will be erased.

Editing a timer programme

You can change any of the settings in a timer programme before the recording is due to start.

- 1 Press **HOME MENU**, select **Timer Recording**, then **Timer Recording**.
- 2 Highlight the timer programme you want to change.
- 3 Press **→** then select '**Modify**' from the command menu panel.
Alternatively, press **ENTER**.
The Timer Programme Set screen appears from which you can edit the settings.
- 4 Edit the timer recording settings as necessary.
- 5 Select '**Store Programme**' to finish.
Confirm the settings you made from the following screen.

Deleting a timer programme

You can delete timer programmes you no longer need.

- 1 Press **HOME MENU**, select **Timer Recording**, then **Timer Recording**.
- 2 Highlight the timer programme you want to erase.
- 3 Press **→** then select '**Erase**' from the command menu panel.
 - Select **Yes** to confirm or **No** to cancel.
 - You can also just press **CLEAR** when the timer programme is highlighted.

Skipping a regular timer programme

If you've set a regular daily or weekly timer programme, you can set the recorder to skip the next scheduled recording.

- 1 Press **HOME MENU**, select **Timer Recording**, then **Timer Recording**.
- 2 Highlight the timer programme you want to skip.



3 Press **→** then select 'Cancel Once' from the command menu panel.

- In the timer programme list, **Cancel Once** appears by the programme.
- You can also just press **II PAUSE** when the timer programme is highlighted.

Extending a timer recording in progress

You can extend a timer recording beyond the programmed end time in two different ways. This can be useful if a broadcast programme overruns, for example.

Cancelling or extending the timer

- 1  Press and hold for three seconds during a timer recording.
Recording continues, but the timer indicator disappears from the front panel display indicating that the timer has been cancelled.
- 2  Press repeatedly to extend recording in 30 minute blocks.

Programming a new end time

You can edit the end time of a timer recording you have previously set.

- 1  Select '**Timer Recording**' then '**Timer Recording**' from the Home Menu.

- 2  Highlight the timer recording you want to change.

- 3  Press **→** then select '**Modify**' from the command menu panel.
Alternatively, press **ENTER**.

The Timer Programme Set screen appears, from which you can edit the settings.

- 4  Edit the end time as necessary.
You can also edit the **Extend** time parameter.

5  Select 'Store Programme'.

6  Press to exit the Timer Recording screen.

Stopping a timer recording

1  Press during a timer recording.

2  Select 'Yes' to confirm.

Preventing use of the recorder before a timer recording (child lock)

You can make all the front panel and remote control buttons inoperative using the child lock feature. This is useful when you set a timer recording and want to make sure that the timer settings are not changed before recording has finished.

1  If the recorder is on, switch it into standby.

2  [Front panel] Press and hold for three seconds to lock the controls.

The front panel display briefly shows **LOCKED**. If any buttons are pressed on the remote or front panel, **LOCKED** is briefly displayed again.

- To unlock the recorder, press and hold  (Stop) on the front panel (while the recorder is stopped) for three seconds until the display shows **UNLOCKED**.

Timer recording FAQ



Frequently Asked Questions

- Even though the timer is set, the recorder doesn't start recording!*

Check that the disc loaded or HDD is recordable, not locked (see *Lock Disc* on

page 98), and that there are fewer than 99/999 titles already on the DVD/HDD.

- The recorder won't let me enter a timer programme! Why not?*

You can't enter a timer programme if the clock isn't set.

- What happens when two or more timer programmes overlap?*

Basically, the programme with the earlier recording start time has priority.

However, the recorder will start recording the programme with the later start time after the earlier programme is finished. If schedule to record two programmes have the same times (but different channels, for example), then only one of the two programmes will be recorded. In this event you should cancel the scheduled recording of the lesser important programme. If one of the overlapping programmes is a regular timer programme, you may choose '**Cancel Once**' in order to avoid having it overlap with a separately scheduled programme (see *Skipping a regular timer programme* on page 44).



Simultaneous recording and playback (Chase Play)

HDD

Chase Play allows you to watch a recording that is still in progress from the start, without having to wait until the recording has finished (i.e., playback is 'chasing' the recording).

In fact, you're not just limited to watching the recording in progress. You can watch anything else already on the HDD (or on a DVD if you're recording to the HDD) by selecting it from the Disc Navigator screen (see *Using the Disc Navigator with recordable discs and the HDD* on page 55).

Chase Play is not possible when DV is the recording input (DVR-650H-K/DVR-550H-K only).

-  **Press during recording to start playback from the beginning of the current recording¹.**
-  **Press during recording to select another title to play.**

You can use all the usual playback controls, such as pause, slow-motion play, scan and skip.

- To stop playback, press **■ STOP** (recording will continue).
- To stop recording, press **□ STOP REC** (playback will continue).

Recording from an external component

You can record from an external component, such as a camcorder or VCR, connected to one of the recorder's external inputs.

1 Make sure that the component you want to record from is connected properly to the HDD/DVD recorder.

See Chapter 2 (*Connecting up*) for connection options.

2 Press repeatedly to select one of the external inputs to record from.

There are three analog inputs. The current input is shown on-screen and in the front panel display:

- **L1** – INPUT 1/AUTO START REC
- **L2** – INPUT 2 (front panel)
- **L3** – INPUT 3

Check that the **Audio In** settings for **External Audio**, and **Dual Mono Recording** are as you want them (see *Audio In* on page 105).

- If the aspect ratio is distorted (squashed or stretched), adjust on the source component or your TV before recording.
- On DVR-650H-K and DVR-550H-K, to watch video coming in via the DV input (front panel), select **DV > DV Video Playback** from the Home Menu (see also *Playing from a DV camcorder* on page 62).

3 Set the recording quality.

- See *Setting the picture quality/recording time* on page 36 for detailed information.

4 Select the HDD or DVD for recording.

5 Press to start recording.

- If your source is copy-protected using Copy Guard, you will not be able to record it. See *Restrictions on video recording* on page 35 for more details.

Automatic recording from a satellite tuner



If you have a satellite tuner or some other kind of set top box connected to the **INPUT 1/AUTO START REC** input, you can have the recorder start and stop recording automatically with the timer settings of the connected component. (If the other component doesn't have a built-in timer, you'll need to use it with an external timer unit.)²

Note

¹ You can't start playback immediately after recording starts. Simultaneous playback and recording doesn't work while copying or backing up.

² You can't set Auto Start Recording when:

- the recorder is recording or in timer recording standby.
- the HDD is not recordable.
- the HDD already contains the maximum number of titles (999).

Recording

After setting up for Auto Start Recording, this recorder starts recording when it detects a signal from the other component. When the signal ceases, the recorder stops recording.

If you want to use this recorder with the timer features of your satellite tuner, see *Additional information for cable/satellite/STB (set-top box) users* below.



Important

- It takes a little while for this recorder to switch on and start recording after detecting a signal. Please bear this in mind when setting the timer.
- If Auto Start Recording is set, it will not start if another timer recording is in progress.
- Timer recordings take precedence over Auto Start Recording. Auto Start Recording will stop if a timer recording is due to start. After the timer recording has finished, Auto Start Recording will resume.

1 Set the timer for the satellite receiver (or other component), then switch it into standby (if necessary).

Check the manual that came with the receiver if you're not sure how to do this.

2 Check that the 'Audio In' settings for 'External Audio' and 'Dual Mono Recording' are as you want them.

See *Audio In* on page 105 for more on these settings.

3 Set up the recorder.

- Use **REC MODE** to set the recording quality. See *Setting the picture quality/recording time* on page 36 for detailed information.

4 Select 'Timer Recording', then 'Auto Start Recording' from the Home Menu.







5 Select 'Yes' to switch Auto Start Recording on, or 'No' to switch off.

If you choose '**Yes**' the recorder automatically goes into standby.

The **AUTO** indicator in the front panel display lights.

The recorder will automatically switch on and start recording when the other component comes on. Recording stops when the external component switches off.

- To cancel Auto Start Recording, press  **STANDBY/ON** while the recorder is in standby. The **AUTO** indicator goes off.
- To cancel Auto Start Recording once recording has already started, press  **REC** for three seconds (this cancels Auto Start Recording, but recording continues), then  **STOP REC** to stop recording.
- You can also stop recording by pressing  **STOP REC** then selecting **Yes** to confirm.



Tip

- Alternatively, with no OSD displayed, press and hold the front panel  **STOP REC** button for more than three seconds to switch Auto Start Recording on directly. After switching on, switch the recorder into standby.

Additional information for cable/satellite/STB (set-top box) users

The following instructions show how to use the timer features of your STB with this recorder.

Setting up

1 Connect the STB's audio/video outputs to a set of audio/video inputs on this recorder.

2 Switch on both the STB and this recorder and switch the recorder's input function to the STB (L1, L2 or L3).

To check that everything is connected properly, switch on your TV and select this recorder as the video input. You should see whatever the STB is tuned to.

3 Program the IR controller supplied with your STB to send start/stop recording codes for a Pioneer VCR.

See the manual that came with the STB for how to do this.

Only the **REC** and **STOP** codes have any effect when used with this recorder:

- **REC** – Start recording
- **STOP** – Stop recording

4 Position the IR controller so that it will control this recorder.

The IR sensor on the recorder is located just above the  mark on the front panel.

Making a timer recording

1 Set the timer on the STB.

See the manual that came with your STB for how to do this.

2 Switch on this recorder.

You must leave the recorder on until the recording finishes.

- At the programmed times, the STB will start and stop recording on this recorder.

Playing your recordings on other DVD players

Most regular DVD players can play finalized discs recorded in DVD-R/-RW (Video mode) and DVD+R discs. A number of players (including many Pioneer models) can also play DVD-RW discs recorded in VR mode, finalized or not. Most players will not play VR mode DVD-R discs, although some DVD-ROM drives and DVD recorders may be able to (finalization might be necessary). Check the manual that came with the player to check what kinds of discs it will play.

When you finalize a DVD-R/-RW (Video mode) or DVD+R disc, a title menu is created from which you can select titles when you play the disc. There are a number of different styles of title menu to choose from to suit the content of the disc.

All the title menus are navigated in the usual way, pressing **MENU** or **TOP MENU** to display the menu, then using the **↑/↓/←/→** followed by **ENTER** to select titles and start playback.

Finalizing a disc

Finalizing 'fixes' the recordings on the disc so that it can be played on a regular DVD player or computer equipped with a suitable DVD-ROM drive.¹

Note that the disc name will appear in the title menu after you finalize a disc. Make sure the disc name is as you want it before you finalize the disc as it can't be changed afterwards. If you want to rename the disc, see *Input Disc Name* on page 98 before starting the steps below.

DVD+RW discs don't generally need finalizing. However, if you want a title menu to appear when you play the disc, then you will need to finalize. When using a DVD+RW, you can still record and edit even after finalizing, although the title menu will disappear if you do so. Finalize the disc again to generate a new title menu.



Important

- Once you've finalized a DVD-R/-RW (Video mode) or DVD+R disc, you can't edit or record anything else on that disc. However, the finalization on a DVD-RW disc maybe 'undone'; see *Undo Finalize* on page 99 for how to do this.

Note

¹ If the TV line system of the disc is different to the current setting of the recorder, you will not be able to finalize the disc.

Recording

- A VR mode DVD-R/-RW (excluding DVD-R DL) disc can still be recorded and edited on this recorder even after finalizing.
- DVD-R DL (Video mode) discs and DVD+R DL discs must be finalized in order to play in other recorders/players. Note however that some recorders/players will not play even finalized dual-layer discs.

1 Load the disc you want to finalize.

Make sure that the recorder is stopped before proceeding.

2 Select 'Disc Setup' from the Home Menu.



3 Select 'Finalize' > 'Finalize' > 'Next Screen'.

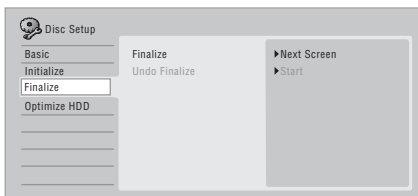

4 For DVD-R/-RW (Video mode) and DVD+R/+RW discs only, select a title menu style, then select 'Yes' to start finalization or 'No' to cancel.

The menu you select will be the one that appears when the 'top menu' (or 'menu' for a DVD+R/+RW) is selected on any DVD player.



- Discs recorded partially or fully on the Pioneer DVR-7000 DVD recorder do not support this feature. These discs will have only a text title menu when finalized on this recorder.

5 The recorder will now start finalizing the disc.

During finalization:

- If the finalization process of a DVD-RW or DVD+R/+RW disc is going to take more than around four minutes, you can press **ENTER** to cancel. Around four minutes before completion, the option to cancel disappears.
- You can't cancel the finalization of a VR mode DVD-R disc.
- How long finalization takes depends on the type of disc, how much is recorded on the disc and the number of titles on the disc. A disc recorded in VR mode can take up to one hour to finalize. DVD-R/-RW (Video mode) and DVD+R/+RW discs can take up to 20 minutes.

Initializing recordable DVD discs

DVD-R/-RW discs can be initialized for either Video mode recording or VR mode recording.¹

When you first load a blank DVD-RW or DVD+RW disc, the recorder initializes it for recording automatically. By default, blank DVD-RW discs are initialized for VR mode recording. See *DVD-RW Auto Initialize* on page 50 if you want to change the default to Video mode.

DVD-R discs are ready for Video mode recordings out of the box; if you want to use a DVD-R for VR mode recording, you must initialize it before recording anything on the disc.

Note

¹ If a disc was previously finalized on an older DVD recorder, you may not be able to re-initialize and/or initialize it for Video mode recording.

DVD+RW and DVD-RAM discs can also be initialized in order to erase the contents of the disc.

Important

- Initializing a DVD-RW, DVD+RW or DVD-RAM disc will erase everything recorded on it. Make sure there is nothing on the disc that you want to keep!
- You may not be able to re-initialize a DVD-RW disc in a different format if it was originally initialized on an older DVD recorder.
- Once initialized for VR mode recording, you can't re-initialize a DVD-R back to Video mode.

- 1  Select 'Disc Setup' from the Home Menu.



- 2 Select 'Initialize' > 'Video Mode', 'VR Mode' or 'Initialize DVD+RW'.

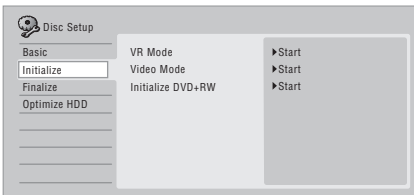

- 3 Select 'Start'.

It takes about 30 seconds to initialize the disc (except DVD-RAM discs, which can take up to an hour).

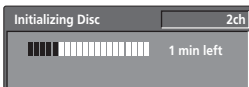

DVD-RW Auto Initialize

DVD-RW

- Default setting: **VR Mode**

Initialization mode is automatically carried out when you insert a blank DVD-RW. You must set the desired initialization mode before inserting a disc.

- 1  Select 'Disc Setup' from the Home Menu.



- 2 Select 'Basic' > 'DVD-RW Auto Init.', then 'VR Mode' or 'Video Mode'.

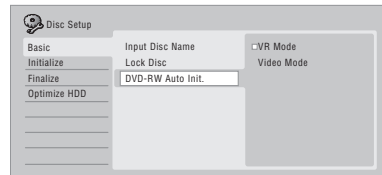

Chapter 6

Playback

Introduction

Most of the features described in this chapter make use of on-screen displays. Navigate these using the cursor buttons and **ENTER**. To go back one level from any screen, use the **RETURN** button.

Remember also that the button guide at the bottom of every screen shows which buttons do what.

Many of the functions covered in this chapter apply to the HDD, DVD discs, Video CDs, WMA/MP3/DivX discs and CDs, although the exact operation of some varies slightly with the kind of disc loaded.

- Many functions are not available when a Video CD is playing in PBC mode. Start playback from the Disc Navigator screen for non-PBC playback (see *Using the Disc Navigator with playback-only discs* on page 56).
- For discs that contain JPEG picture files, see *The PhotoViewer* on page 90.

Basic playback

ALL

This section shows you how to use your recorder for playback of discs (DVD, CD, etc.), and for playback of video from the HDD.



Important

- Throughout this manual, the term 'DVD' means any kind of playable or recordable DVD. If a function is specific to a particular kind of DVD disc, it is specified.
- Some DVD-Video, DVD+R and DVD+RW discs don't allow certain playback controls to operate at certain points in the disc. This is not a malfunction.

HDD/DVD



1 Select the HDD or DVD for playback.

If playing video from the HDD, skip to step 3 below.

Select DVD for any kind of disc playback.

OPEN/CLOSE



2 [Front panel] Load a disc.

Load a disc with the label side facing up, using the disc tray guide to align the disc (if you're loading a double-sided DVD-Video disc, load it with the side you want to play face down).

- If you want to play a DTS audio CD, please first read the note on page 53.

PLAY



3 Start playback.

- If you're playing a DVD-Video or Video CD, a disc menu may appear when you start playback. Use the **↑/↓/←/→** buttons, number buttons, and **ENTER** to navigate DVD disc menus, and the number buttons and **ENTER** for Video CD menus.
- When playing video from the HDD, playback will automatically stop after the end of a title is reached.
- There may be a slight pause when playback switches from the first to the second layer of a dual-layer disc.
- See the following sections for more details on playing specific kinds of discs.

STOP





4 Press to stop playback.

5 When you've finished using the recorder, eject the disc and switch the recorder back into standby.



Playing DVD discs



The table below shows the basic playback controls for DVD-Video, and recordable DVD discs.

 **PLAY** Press to start playback.
If **RESUME** is displayed on-screen, playback starts from the place last stopped.

 **STOP** Press to stop playback.
You can resume playback from the same point by pressing **▶ PLAY**. (Press **■ STOP** again to cancel the resume function.)

 **PAUSE** Pauses playback, or restarts playback when paused.

  Press to start scanning. Press repeatedly to increase the scanning speed.

  Press to skip to previous/next chapter/title. (During playback you can also use the front panel **CH +/-** buttons.)
DVD+R/DVD+RW only:
◀◀ PREV may not always skip to the previous title.





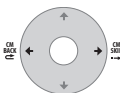

Except VR mode: During playback, enter a chapter number then press **ENTER** to skip directly to that chapter within the currently playing title.

 **ENTER** On some discs, you can also use the number buttons to select numbered items in the disc menu.
VR mode only: During playback, enter a title number then press **ENTER**.
All: Press **CLEAR** to clear a number entry and start again.



DVD-R/-RW, DVD-RAM only:
(Commercial back/skip) Each press skips backward/forward progressively up to a maximum of two hours in either direction.

  While paused, press and hold to start slow-motion playback. Press repeatedly to change the playback speed.
While paused, press to advance a single frame in either direction.

  Press to display the menu of a DVD-Video disc. (DVD+R/+RW discs finalized on this recorder will display the Disc Navigator. Press **MENU** to display the disc menu.)

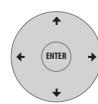
 Use the cursor buttons to navigate DVD-Video disc menus; press **ENTER** to select items.

 Press to return to the previous level of a DVD-Video disc menu.



Playing from the HDD

The table below shows the basic playback controls when playing video recorded on the hard disk (HDD).

 **PLAY** Press to start playback.
If **RESUME** is displayed on-screen, playback starts from the place last stopped.
Playback automatically stops after the end of a title is reached.

 **STOP** Press to stop playback.
You can resume playback from the same point by pressing **▶ PLAY**. (Press **■ STOP** again to cancel the resume function.)

 **PAUSE** Pauses playback, or restarts playback when paused.

  Press to start scanning. Press repeatedly to increase the scanning speed.

Playback



Press to skip to previous/next chapter/title. (During playback you can also use the front panel **CH +/-** buttons.)



During playback, enter a title number then press **ENTER** to skip directly to that title. Press **CLEAR** to clear a number entry and start again.

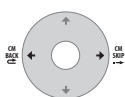

(Commercial back/skip) Each press skips backward/forward progressively up to a maximum of two hours in either direction.



While paused, press and hold to start slow-motion playback. Press repeatedly to change the playback speed. While paused, press to advance a single frame in either direction.



Except WMA: Press to start scanning. Press again to increase the scanning speed. (There are two scan speeds; the current scan speed is shown on-screen.)



Press to skip to previous/next track (or folder for WMA/MP3 disc). (During playback you can also use the front panel **CH +/-** buttons.)



During playback, enter a track number then press **ENTER** to skip directly to that track. Press **CLEAR** to clear a number entry and start again.



Playing Video CD

The table below shows the basic playback controls for Video CDs.

Some discs feature Playback Control (PBC for short) menus. These discs show PBC in the display when you load them and display a menu on-screen from where you can select what to watch.²



Press to start playback.



Press to stop playback.



Pauses playback, or restarts playback when paused.



Press to start playback. If **RESUME** is displayed on-screen, playback starts from the place last stopped.



Press to stop playback. You can resume playback from the same point by pressing ► **PLAY**. (Press **STOP** again to cancel the resume function.)



Pauses playback, or restarts playback when paused.

Note

- If you want to play a DTS audio CD, make sure the recorder is connected to a DTS-compatible amp/receiver with a digital connection. Noise will be output through the analog outputs. Also make sure that **STEREO** is selected using the **AUDIO** button (see *Switching audio channels* on page 60).
- When playing in PBC mode, some playback features, such as search, repeat and programme play are not available. You can play a PBC Video CD in non-PBC mode by starting playback using the Disc Navigator (see *Using the Disc Navigator with playback-only discs* on page 56).



Press to start scanning. Press repeatedly to increase the scanning speed.



Press to skip to previous/next track.

When a PBC menu is displayed, press to display the previous/next page. (During playback you can also use the front panel **CH +/-** buttons.)



During playback, enter a track number then press **ENTER** to skip directly to that track.

Press **CLEAR** to clear a number entry and start again.

While a PBC menu screen is displayed, use to select numbered menu items.

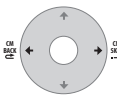

Each press skips backward/forward progressively up to a maximum of two hours in either direction. Note that this function doesn't work when playing in PBC mode.



While paused, press and hold to start slow-motion playback. Press repeatedly to change the playback speed (forward only). While paused, press to advance a single frame (forward only).



Press to display the disc menu of a Video CD playing in PBC mode.

Playing DivX video files

The table below shows the basic playback controls for DivX video files.

PLAY



Press to start playback. If **RESUME** is displayed on-screen, playback starts from the place last stopped. Playback of titles (DivX files) proceeds in alphabetical order.

STOP



Press to stop playback. You can resume playback from the same point by pressing **▶ PLAY**. (Press **■ STOP** again to cancel the resume function.)

PAUSE



Pauses playback, or restarts playback when paused.



Press to start scanning. Press repeatedly to increase the scanning speed.



Press to skip to previous/next title. (During playback you can also use the front panel **CH +/-** buttons.)



While paused, press to advance one frame. Press and hold to start slow motion playback (press repeatedly to change the slow motion play speed).

AUDIO



Press to display the playback audio type; press repeatedly to change the playback audio type.

SUBTITLE



Press to display subtitle information; press repeatedly to change subtitles.

Playback

Using the Disc Navigator to browse the contents of a disc



Use the Disc Navigator to browse the contents of a disc and start playback.

Using the Disc Navigator with recordable discs and the HDD

DVD-R DVD-RW DVD+R DVD+RW DVD-RAM HDD

You can use the Disc Navigator to browse and edit video on recordable DVDs and the HDD, and to view information on titles.

See also *Editing* on page 65 for more on editing recordable discs.

- 1  Select the HDD or DVD.
- 2  Open the Disc Navigator.

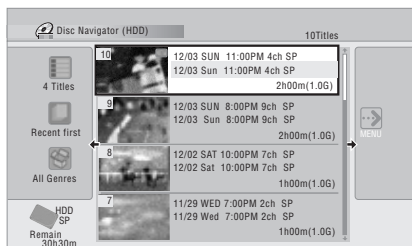

- You can also access the Disc Navigator from the Home Menu.

- 3  Browse the list of titles.

- Use the **PREV**/**NEXT** buttons to display the previous/next page of titles.
- To change the thumbnail picture displayed for a title see *Set Thumbnail* on page 70.
- For HDD recordings, you should be able to see a thumbnail title digest. If it doesn't display, set *Set Preview* to **Normal**. See *Set Preview* on page 112.

- 4  Play the highlighted title.

- You can also select **Play** from the command menu options.

Changing the display style of the Disc Navigator

You can choose to display titles in the Disc Navigator in various different ways, sorted alphabetically, by recording date, by genre, and so on. You can also choose whether to display four or eight titles on the screen at the same time.

- 1  Display the View Options panel.

The View Options panel

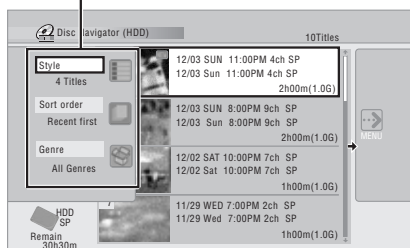

- 2  Choose 'Style', 'Sort order' or 'Genre', then press ENTER to see the available view options.

- **Style** – Select four or eight titles per screen view
- **Sort order** – Sort by date (most recent first), unwatched first, title name or recording date (oldest first)
- **Genre** – Display all genres or just a selected genre

- 3  Choose a view option, then press ENTER.

The title list display is updated according to the new display preferences.

Using the Disc Navigator with playback-only discs

DVD-Video CD Video CD WMA/MP3 DivX

1  Display the Home Menu.



2 Select 'Disc Navigator'.

Alternatively, for a CD, Video CD or WMA/MP3/DivX disc, you can press **DISC NAVIGATOR**, which takes you straight to the Disc Navigator screen.



3 Select what you want to play.

Depending on the type of disc you have loaded, the Disc Navigator looks slightly different, but they are all navigated in the same way.

The screen below shows a WMA/MP3/DivX disc. Navigate to the folder, or the track/title within a folder that you want to play.

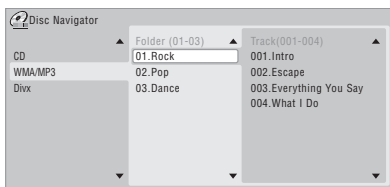



Playback starts after you press **ENTER**.

- For discs that contain CD-Audio tracks and WMA/MP3 tracks or DivX titles, you can switch the playback area between **CD**, **WMA/MP3** and **DivX**. This can only be done while the disc is stopped.



Scanning discs

ALL (except WMA)

You can scan discs at various speeds, forwards or backwards.¹

1   During playback, start reverse or forward scanning.

- The scanning speed is shown on-screen.

2   Press repeatedly to change the scanning speed.

There are four scanning speeds available when playing HDD video, a DVD or a DivX title. Reverse playback is also possible with HDD and DVD video.²

There are two scanning speeds for other types of disc.

3  Resume normal playback.



Playing in slow motion

DVD HDD Video CD DivX

You can play video at various slow motion speeds. DVDs and video on the HDD can be played in slow motion in either direction, while Video CDs and DivX titles can only be played forwards in slow motion.

There is no sound when playing in slow motion.

1  Pause playback.

2   Press and hold to start slow motion reverse or forward play.

Note

- No subtitles are displayed when scanning DVDs and DivX titles.
 - No sound is output when scanning from the HDD, DVDs and DivX, except on forward **SCAN 1**.
 - Depending on the disc, normal playback may automatically resume when a new chapter is reached on a DVD disc.
- Reverse playback may not be smooth.

Playback

- 3  Press repeatedly to change the slow motion speed.

The current playback speed is indicated on-screen.

- 4  Resume normal playback.

Frame advance/frame reverse

DVD HDD Video CD DivX

You can advance or back up video on a DVD disc¹ or the HDD frame-by-frame.

With Video CDs and DivX titles, you can only use frame advance.

- 1  Pause playback.

- 2  Back up or advance one frame with each press.

- 3  Resume normal playback.

The Play Mode menu

ALL

The Play Mode menu gives you access to search functions, repeat and programme functions.

- Press  to display the Play Mode menu.

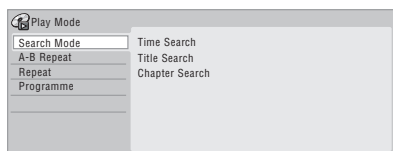

- You can also access the Play Mode menu from the Home Menu (press **HOME MENU**).
- To exit the Play Mode menu, press **HOME MENU** or **PLAY MODE**.

Search Mode

ALL

The Search Mode feature lets you start playback from a specified point in a disc by time² or by title/chapter/folder/track number.

- 1  Select 'Search Mode' from the Play Mode menu, then choose a search option.

The available search options depend on the type of disc.

- 2  Enter a title/chapter/folder/track number or a search time.

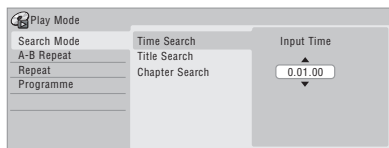

Time Search (HDD, DVD): For example, for 25 minutes into the current title, press **2, 5, 0, 0**. For 1 hour and 15 minutes and 20 seconds into the title, press **1, 1, 5, 2, 0**.

Time Search (Video CD): For example, for 2 minutes and 30 seconds into the current track, press **2, 3, 0**.

Title/Chapter/Folder/Track Search: For example, for track 6, press **6**.

- 3  Start playback.

Note

- 1 Depending on the disc, normal playback may automatically resume when a new chapter is reached.
- 2 When using time search, playback may occasionally start slightly before or after the time you input.

A-B Repeat

DVD HDD CD Video CD DivX

The A-B Repeat function allows you to specify two points (A and B) within a track or title that form a loop which is played over and over.¹



1 During playback, select 'A-B Repeat' from the Play Mode menu.

2 With 'A (Loop Start)' highlighted, press at the point you want the loop to start.

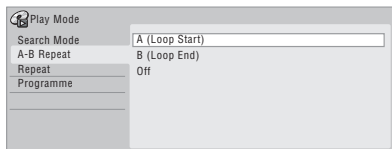

3 With 'B (Loop End)' highlighted, press at the point you want the loop to end.

Playback immediately jumps back to the start point and plays the loop round and round.

- When playing a DVD-Video, DVD-R/-RW (Video mode), DVD+R/+RW, or from the HDD, the start and end points of the loop must be in the same title.
- To resume normal playback, select **Off** from the A-B Repeat menu, or press **CLEAR** if no menu OSD (such as the Play Mode menu) is displayed.

Repeat play

ALL

There are various repeat play options, depending on the kind of disc loaded, or if you're using the HDD for playback. It's also possible to use repeat play together with programme play to repeat the tracks/chapters in the programme list (see *Programme play* below).²



• Select 'Repeat' from the Play Mode menu, then choose a repeat play mode.

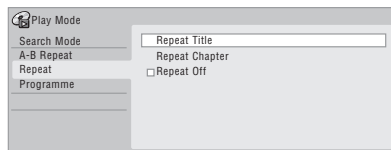

- To resume normal playback, select **Repeat Off** from the Repeat Play menu, or press **CLEAR** if no menu OSD (such as the Play Mode menu) is displayed.

Programme play

HDD DVD-Video CD Video CD WMA/MP3

This feature lets you program the play order of titles/chapters³/folders/tracks on a disc or the HDD.



1 Select 'Programme' from the Play Mode menu, then 'Input/Edit Programme'.

Note

¹ If you switch camera angles on a DVD during A-B repeat play, A-B repeat is cancelled.

² If you switch the camera angle during repeat play of a DVD-Video disc, repeat play is cancelled.

³ When playing a programme list of DVD-Video chapters, chapters not included in the programme list may be sometimes be played, depending on the disc.

Playback

The Input/Edit Programme screen varies according to the disc type. Below is the DVD input screen.

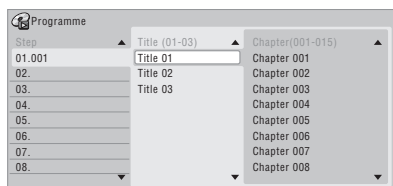

2 Select a title, chapter, folder or track for the current step in the programme list.

After pressing **ENTER** to add the title/chapter/folder/track, the step number automatically moves down one.

- To insert a step into the programme list, highlight the step number where you want to insert another step, then select a chapter/title/folder/track as usual. After pressing **ENTER**, all the subsequent steps move down one.
- To delete a step from the programme list, highlight the step you want to delete, then press **CLEAR**.

3 Repeat step 2 to build up a programme list.

A programme list can contain up to 24 titles/chapters/folders/tracks.

PLAY

4 Play the programme list.

Programme play remains active until you cancel programme play, erase the programme list, eject the disc or switch off the recorder.



Tip

- To save your programme list and exit the programme edit screen without starting playback, press **HOME MENU** or **PLAY MODE**.

- During programme play, press **▶▶ NEXT** to skip to the next programme step.
- To repeat play the programme list, select **Programme Repeat** from the Repeat Play Mode menu (see *Repeat play* on page 58).
- Press **CLEAR** during playback to switch off programme play (if no menu OSD, such as the Disc Navigator, is displayed). Press while stopped to erase the programme list.
- From the Programme menu you can also:
 - Start Programme Play** – Starts playback of a saved programme list
 - Cancel Programme Play** – Turns off programme play, but does not erase the programme list
 - Erase Programme List** – Erases the programme list and turns off programme play

Displaying and switching subtitles

DVD-Video DivX

Some DVD and DivX discs have subtitles in one or more languages; the disc box will usually tell you which subtitle languages are available. You can switch subtitle language during playback.¹

Check the disc packaging for details of the subtitle options.

SUBTITLE

Select/change the subtitle language.

The current subtitle language is shown on-screen and in the front panel display.

- To switch off subtitles, press **SUBTITLE** then **CLEAR**.

Note

- 1 Some discs only allow you to change subtitle language from the disc menu. Press **MENU** or **TOP MENU** to access.
 - To set subtitle preferences, see *Subtitle Language* on page 107.

Switching DVD and DivX soundtracks

DVD-Video DivX

When playing a DVD disc or DivX title recorded with two or more soundtracks (often in different languages), you can switch the soundtrack during playback.¹ Check the disc packaging for details of the soundtrack options.

AUDIO

• **Change the audio soundtrack.** The current audio language is shown on-screen and in the front panel display.

- The sound may drop out for a few seconds when switching soundtracks.
- Some discs feature both Dolby Digital and DTS soundtracks. There is no analog audio output when DTS is selected. To listen to the DTS soundtrack, connect this recorder to a DTS decoder or AV amp/receiver with built-in DTS decoder via the digital output. See *Connecting to an AV amplifier or receiver* on page 21 for connection details.

Switching audio channels

DVD (VR) DVD-RAM HDD CD Video CD WMA/MP3

For HDD² and VR mode content that has both a main and a SAP (Secondary Audio Programme) audio channels, you can switch between main (**L**), SAP (**R**), or both (**L+R**).³

When playing Video CDs and audio CDs you can switch between stereo, just the left channel or just the right channel.

AUDIO

• **Press repeatedly to display/switch the audio channel.**

The audio channel(s) currently playing are indicated on-screen.

HDD DVD (VR) DVD-RAM

L+R – Both channels (default)

L – Left/main channel only

R – Right/SAP channel only

CD Video CD WMA/MP3

Stereo – Stereo (default)

1/L – Left channel only

2/R – Right channel only

Switching camera angles

DVD-Video

Some DVD-Video discs feature scenes shot from two or more angles — check the disc box for details: it should be marked with a  icon if it contains multi-angle scenes. When a multi-angle scene is playing, the same icon appears on screen to let you know that other angles are available (this can be switched off if you prefer — see *Angle Indicator* on page 110).

ANGLE

• **Switch the camera angle.**

- The angle number is displayed on-screen.
- If the disc was paused, playback starts again with the new angle.

Note

- Some discs only allow you to change audio language from the disc menu. Press **MENU** or **TOP MENU** to access.
 - To set audio language preferences, see *Audio Language* on page 107.
- Only when HDD Recording Format is set to Video Mode Off (*HDD Recording Format* on page 109).
- When playing a dual mono recording on a VR mode disc, if you are listening to the Dolby Digital soundtrack via the digital output, you cannot switch the audio channel. Set **Dolby Digital Out** to **Dolby Digital** → **PCM** (see *Dolby Digital Out* on page 106) or listen via the analog outputs if you need to switch the audio channel.

Playback

Displaying disc information on-screen

You can display various on-screen information about the disc loaded or the HDD.

- 
Display/change the on-screen information.
 - Press once to show the HDD and removable disc (DVD, etc.) activity together. Press again to show the status of just the currently selected playback/recording device (HDD or removable disc).
 - To hide the information display, press **DISPLAY** repeatedly until it disappears.

HDD and removable disc activity display

Press **DISPLAY** once to see the HDD and removable disc (DVD, etc.) activity. Use the **HDD/DVD** button to switch between the two kinds of display.

The example displays below show high-speed copying from HDD to DVD, and HDD chase playback.

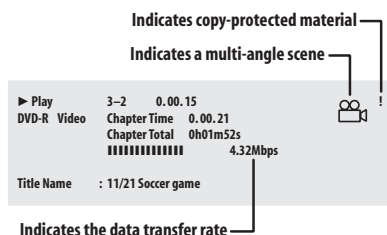
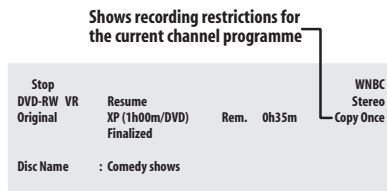
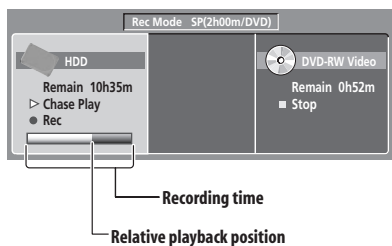
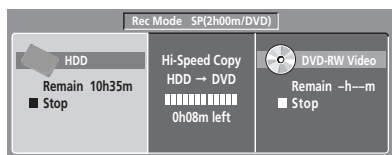

Tip

- See *Switching camera angles* on page 60 for more on multi-angle scene switching.
- When using the simultaneous play and record feature, the display shows information for playback only.
- During real-time copy, the copy source playback information is displayed.
- The Video mode DVD-R/RW displays become the same as a DVD-Video disc once the disc is finalized.
- The total recording time figure shown in parenthesis is calculated based on a 12 cm/4.7 GB disc at the displayed record setting.
- Recording and playback times for TV recordings are approximately 0.1 % shorter than the actual time. This is because of the slightly different frame rates of TV broadcasts versus DVD.
- The frame number is shown next to the elapsed time display when the disc is paused.
- Copy Once** or **Can't Record** messages may appear in the stop or recording displays. These indicate that the broadcast TV programme contains copy control information.

Chapter 7

Playing and recording from a DV camcorder (DVR-650H-K/DVR-550H-K)

You can play back and record video from a DV camcorder connected to the **DV IN** jack on the front panel of this recorder.



Important

- If you connect a second recorder using a DV cable, you cannot control the second unit from this one.
- You can't control this unit remotely from a component connected to the **DV IN** jack.

Playing from a DV camcorder

1 Make sure your DV camcorder is connected to the front panel DV IN jack.

2 From the Initial Setup menu, check that the DV audio input is setup as you would like.

See *DV Input* on page 106 for more on this.

- Check also that the **Audio In** settings for **External Audio** and **Dual Mono Recording** are as you want them (see *Audio In* on page 105).

HOME MENU

3  **Select 'DV', then 'DV Video Playback' from the Home Menu.**

4 Start playback on the camcorder.

Images from the camcorder should appear on your TV.

- To record the incoming video, press **HDD/DVD** to select the HDD or a DVD for recording, then press **REC**. Press **STOP REC** to finish recording. If there is no signal from the device connected to the DV jack, or the signal is copy-protected, recording will pause. It will automatically restart once there is a recordable signal.

- The recorder will only start recording from the **DV IN** jack if there is a valid signal. Recording will pause if the signal is interrupted during recording.
- If your source is copy-protected using Copy Guard, you will not be able to record it. See *Restrictions on video recording* on page 35 for more details.

Recording from a DV camcorder

- The source signal must be DVC-SD format.
- You can't record date and time information from DV cassette.
- During DV recording, if a part of the tape is blank, or has copy-protected material on it, this recorder will pause recording. Recording will restart automatically when there is a recordable signal. However, if there is more than two minutes of blank tape, this recorder will stop recording and the camcorder should stop (depending on the camcorder).

Copying from a DV source

Using the recorder's remote, you can control both the camcorder and this recorder.



Important

- Some camcorders cannot be controlled using this recorder's remote.
- For best results when recording from a DV camcorder to this recorder, we recommend cueing the camcorder to the place you want to start recording from and setting the camcorder to play-pause.

1 Make sure your DV camcorder is connected to the front panel DV IN jack.

Also, set the camcorder to VTR mode.

REC MODE

2  **Set the recording quality.**

- See *Setting the picture quality/recording time* on page 36 for detailed information.

3 From the Initial Setup menu, check that the DV audio input is setup as you would like.

See *DV Input* on page 106 for more on this.

- Check also that the **Audio In** settings for **External Audio** and **Dual Mono Recording** are as you want them (see *Audio In* on page 105).

HOME MENU

4  **Select 'DV', then 'Copy from a DV Source' from the Home Menu.**









- DV recording only works when the DV camcorder is in VTR mode with a tape loaded.



5  **Select 'Record to Hard Disk Drive' or 'Record to DVD'.**

6 Find the place on the camcorder tape that you want to start recording from.

For best results, pause playback at the point from which you want to record.

- Depending on your camcorder, you can use this recorder's remote to control the camcorder using the , , , , , , ,  and  buttons.



7  **Select 'Start Rec'.**

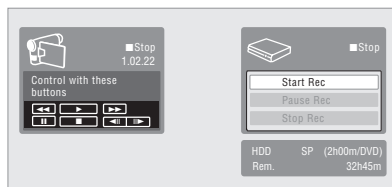

- You can pause or stop the recording by selecting **Pause Rec** or **Stop Rec** from the on-screen display. You cannot control the camcorder from this remote control during recording.

- If you restart recording after stopping the camcorder, the first few seconds of the camcorder tape will not be recorded.

Use the pause button on your camcorder instead and recording will start immediately.

- **HDD, DVD (VR Mode) and DVD-RAM only:** A chapter marker is inserted every time there is a break in the timecode on the DV tape. This happens when the recording is stopped or paused then restarted, for example.
- If you don't want to see the DV recording screen during recording, press **DISPLAY** to hide it (press again to display).
- While recording, you cannot exit the DV recording screen using the **HOME MENU** or **RETURN** button.

DV Auto Copy

DV Auto Copy allows you to make an exact copy of the contents of a DV source to the HDD or a DVD.

1 Make sure your DV camcorder is connected to the front panel DV IN jack.

Also, set the camcorder to VTR mode.

REC MODE

2  **Set the recording quality.**

- See *Setting the picture quality/recording time* on page 36 for detailed information.

3 From the Initial Setup menu, check that the DV audio input is setup as you require.

See *DV Input* on page 106 for more on this.

- Check also that the **Audio In** settings for **External Audio** and **Dual Mono Recording** are as you want them (see *Audio In* on page 105).

HOME MENU

4  **Select 'DV', then 'DV Auto Copy' from the Home Menu.**

- DV recording only works when the DV camcorder is in VTR mode with a tape loaded.



5 Select 'Record to Hard Disk Drive' or 'Record to DVD'.

The DV tape is rewound to the beginning. Once it is rewound, the DV tape is played from the beginning and copied to either the HDD or a DVD.

- If there is a gap of two minutes or more between recorded contents, the copying process is automatically stopped.
- Once copying is finished, the DV tape is automatically rewound.
- To cancel the copying process, press **STOP REC** for more than three seconds.

About automatic finalization

If you use a DVD-R/-RW (Video mode) or DVD+R/+RW disc for copying, it will automatically be finalized after copying is complete.

- You can't customize the background for DVD-R/-RW or DVD+R/+RW disc finalization.
- No title names are assigned.
- If you want to give the disc a name, please do so before you start the copy (see *Input Disc Name* on page 98).
- If a timer recording is scheduled to start, and in some other instances, the disc will not be finalized.



Frequently Asked Questions

- *I can't get my DV camcorder to work with the recorder!*

Check that the DV cable is properly connected. Also make sure that what you're trying to record is not copy-protected.

If it still doesn't work, try switching off the camcorder then switch back on.

- *There's a picture, but no sound!*

Try switching the **DV Input** setting (see *DV Input* on page 106) between **Stereo 1** and **Stereo 2**.¹

About DV

Using DV, also known as i.LINK or IEEE 1394-1995, you can connect a DV camcorder to this recorder using a DV cable for input of audio, video, data and control signals.

"i.LINK" and the "i.LINK" logo are trademarks.

- This recorder is only compatible with DV-format (DVC-SD) camcorders. Digital satellite receivers and Digital VHS video recorders are not compatible.
- You cannot connect more than one DV camcorder at a time to this recorder.
- You cannot control this recorder from external equipment connected via the **DV IN** jack.
- It may not always be possible to control the connected camcorder via the **DV IN** jack.
- DV camcorders can usually record audio as stereo 16-bit/48 kHz, or twin stereo tracks of 12-bit/32 kHz. This recorder can only record one stereo audio track. Set the **DV Input** setting as required (see *DV Input* on page 106).
- Audio input to the **DV IN** jack should be 32 kHz or 48 kHz (not 44.1 kHz).
- Picture disturbance in the recording may occur if the source component pauses playback or plays an unrecorded section of tape, or if the power fails in the source component, or the DV cable is disconnected.
- The **DV IN** jack is an input only. There is no output functionality.

Note

¹ If the audio subcode on the DV tape cannot be read correctly, the audio type will not switch automatically. You can switch the audio manually from the **External Audio** setting (page 105).

Chapter 8

Editing

Editing options



The table below shows which commands you can use with the HDD and different disc types.

	HDD	DVD-R/-RW (Video mode), DVD+R/+RW	DVD-R/-RW, DVD-RAM (VR mode)	
			Original	Play List
Create (page 67)				●
Play (page 67)	●	●	●	●
Erase (page 67)	●	●	●	●
Edit > Title Name (page 68)	●	●	●	●
Edit > Set Thumbnail (page 70)	●	●	●	●
Edit > Erase Section (page 70)	●		●	●
Edit > Divide (page 71)	●			●
Edit > Chapter Edit (page 71)	●		●	●
Edit > Set Genre (page 72)	●			
Edit > Lock (page 73)	●	●	●	
Edit > Move (page 73)				●
Edit > Combine (page 74)				●
Genre Name (page 74)	●			
Multi-Mode (page 75)	●			
Undo (page 75)		●	● *1	● *1

*1 DVD-R/-RW only

The Disc Navigator screen





The Disc Navigator screen is where you can edit video content on unfinalized Video mode and DVD-R/-RW (VR mode) discs, DVD+R/+RW and DVD-RAM, as well as video content on the internal hard disk drive.

-  **Select the HDD or DVD.**
-  **Display the Disc Navigator screen.**

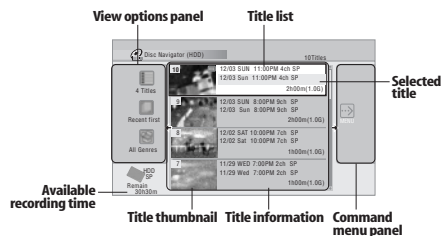
Playback will automatically stop when you do this.

- The Disc Navigator is also accessible from the Home Menu.



-  Press to display the command menu panel. Use the **↑/↓** and **ENTER** buttons to navigate the menus.
-  When in the title list, press to display the previous/next page if there are more titles than can be displayed.
-  Press to change the title information displayed in the title list.
-  Press to switch between the HDD and DVD Disc Navigator screens.

- If you are editing a DVD-R/-RW (VR mode) or DVD-RAM disc you can display the Play List by selecting **Play List** from the view options panel (press **←**, then select **Play List** from the view options, then **Play List**).



- Titles on the HDD marked with a **NEW** icon are recently recorded titles that haven't yet been played.
-  **Press to exit the Disc Navigator.**

Editing accuracy

Some editing commands ask you whether you want to keep Video mode compatibility or frame accuracy (*Video Mode Compatible Editing* or *Frame Accurate Editing*).

Frame Accurate Editing is very precise. The edit point is accurate to the exact frame you choose. However, this accuracy is not preserved in any copy you make if you use the high-speed copy function to make a DVD-R/-RW (Video mode) or DVD+R/+RW.

Video Mode Compatible Editing is less precise. The edit point you choose will only be accurate to within one-half to one second. On the other hand, these edit points will be preserved if you use high-speed copy to make a DVD-R/-RW (Video mode) or DVD+R/+RW.

HDD genres

The large capacity of the HDD means that there may be many hours of video in the recorder. To help you organize your HDD video content you can assign different genres to titles. There are 10 genres in total, including ten user-definable ones that you can name as you like.

Create

DVD (VR) DVD-RAM *Play List only*

Use this function to create a Play List and add titles to it.

Before you can use this command, make sure that the Play List is switched on in the view options panel on the left.

- 1  Select 'Create' from the command menu panel.

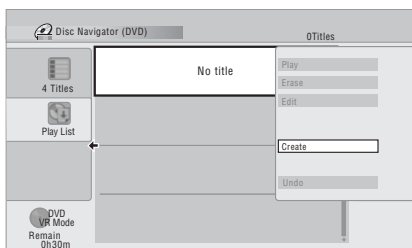

- 2  Select an original title to add to the Play List.

Repeat these two steps to add as many titles as necessary to the Play List.

Play

DVD (Video) DVD (VR) DVD+R DVD+RW DVD-RAM

HDD

Use this function to start playback of a title.

- 1  Highlight the title you want to play.

- 2  Select 'Play' from the command menu panel.

Playback of the title you selected starts.

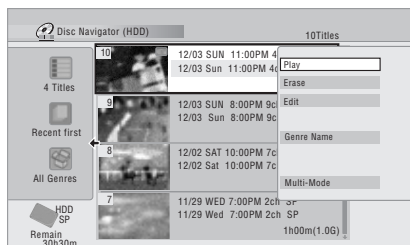

Erase

DVD (Video) DVD (VR) DVD+R DVD+RW DVD-RAM

HDD

Use this function to erase unwanted titles.

When you erase titles from the HDD or Original titles from a VR mode DVD-RW, the available recording space increases accordingly. Erasing a title from a DVD-RW (Video mode) or DVD+RW disc increases the available recording time only if it is the last title on the disc.¹

Erasing Play List titles, or titles from a DVD-R (VR mode or Video mode) or DVD+R, will not result in any more free space on the disc.

 **Note**

¹ There may be cases where erasing a title from a DVD+R/+RW disc will result in in contiguous title numbers.



1 Highlight the title you want to erase.



2 Select 'Erase' from the command menu panel.



3 Select 'Yes' to confirm or 'No' to cancel.



Tip

- You can erase a title quickly by pressing **CLEAR** when the title is highlighted. Confirm the edit by pressing **ENTER**.

Title Name

DVD (Video) DVD (VR) DVD+R DVD+RW DVD-RAM

HDD

You can give titles new names of up to 64 characters long for VR mode, DVD-RAM and HDD recordings, and up to 40 characters for Video mode recordings and DVD+R/+RW discs.



1 Highlight the title you want to name (or rename).



2 Select 'Edit' > 'Title Name' from the command menu panel.

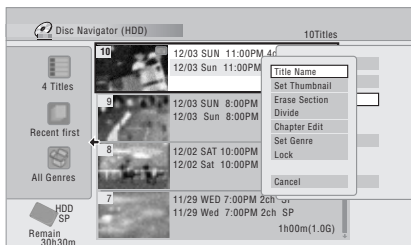

3 Input a name for the selected title.

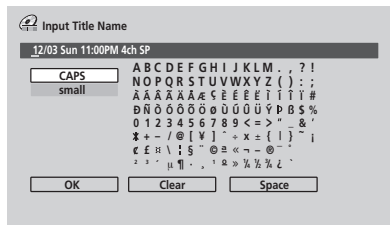

- A name generated automatically by the recorder will already be in the name input section of the screen. Use the **◀◀** / **▶▶** buttons to change the cursor position.
- Select **CAPS** or **small** to change to upper or lower-case, or use the **CASE SELECTION** buttons (**◀◀** **PREV** / **▶▶** **NEXT**).
- You can also use the **CLEAR** button to delete characters directly (press and hold for two seconds to delete the whole name). For other remote control key shortcuts, see *Using the remote key shortcuts to input a name* below.
- For discs formatted on a different DVD recorder, you will see only a limited character set.



4 Select 'OK' to enter the name and return to the main Disc Navigator screen.

- To return to the main Disc Navigator screen without saving changes to the title name, press **RETURN**.

Editing

Using the remote key shortcuts to input a name

The table below shows the remote control key shortcuts that you can use to input characters in the name input screen. Pressing a button repeatedly cycles through the characters shown.

If you want to enter two characters in succession that are both on the same button (for example a **P** and an **R**), press ►► to advance the cursor one space manually between inputting the two characters.

Key	Characters	Key	Characters
1	, ' ? ! - & 1	6	m n o ö ö ð ò ó ø ñ
2	a b c 2 ä à á â ã æ ç	7	p q r s 7 \$ ÿ/ß * ¹
3	d e f 3 è é ê ë	8	t u v 8 ü ù ú
4	g h i 4 î ï ï ï	9	w x y z 9
5	j k l 5 £	0	0
◀◀	[cursor back]	►►	[cursor forward]
◀◀/ ►►	[change case]	CLEAR	[clear character]
	<space>	■	[finish name input]
+	~ () _ / : ; " ` ^ @ # * % ¥ + = { } [] < >		

*¹ lower-case: ÿ; upper-case: ß

Using a USB keyboard to enter a name

(DVR-650H-K/DVR-550H-K only)

Using a USB keyboard connected to this recorder makes entering names very quick and convenient.¹ When in USB keyboard input mode, a USB icon (🔌) appears in the lower-left of the screen.²

Other than the standard alpha-numeric keys, use the following keys when entering names:

Key	Function
◀ ▶	Change the cursor position
F1	Select CAPS
F2	Select small
delete	Delete character at the current cursor position
back space	Delete the character at the previous cursor position
enter	Enter the name
esc	Exit the input screen

Note

- It's possible that some USB keyboards will not work exactly as expected when connected to this recorder. See also *Connecting a USB device* on page 24 for more connection information.
 - Certain keyboards may not be able to correctly input all characters.
- If you use the remote control to enter a name when in the USB keyboard input mode, the recorder will automatically switch to remote control input mode. Press any key on the USB keyboard to return to USB keyboard input mode.

Set Thumbnail

HDD DVD (Video) DVD (VR) DVD+R DVD+RW

DVD-RAM

You can change the thumbnail picture that appears in the Disc Navigator for a title to any frame that appears in that title.

1  Highlight the title you want to change the thumbnail picture for.

2  Select 'Edit' > 'Set Thumbnail' from the command menu panel.

The thumbnail setting screen appears from which you can find the frame you want.



3 Use the playback controls (▶, II, ◀◀, ▶▶, etc.) to find a suitable frame, then press ENTER to set.

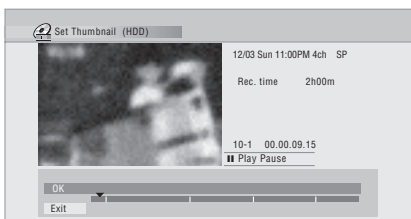

You can also use the chapter and time search features (press **PLAY MODE**), and the **→ CM SKIP** and **← CM BACK** buttons.

4  Select 'Exit' to return to the Edit screen.

Erase Section

HDD DVD (VR) DVD-RAM

Using this command you can delete a part of a title, ideal for cutting out the commercial breaks in a recording made from the TV.

1  Highlight the title containing the section you want to erase.

2  Select 'Edit' > 'Erase Section' from the command menu panel.

3  *HDD only:* Select the type of edit.

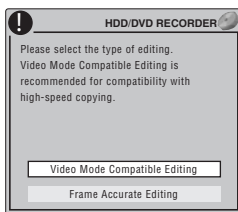

• For more information about these options, see *Editing accuracy* on page 66.

4 Highlight 'From' then use the playback controls (▶, II, ◀◀, ▶▶, etc.) to find the start of the section to erase, then press ENTER.

The bar at the bottom of the screen indicates the current play position in the title. After pressing **ENTER**, a marker shows the start of the section.



Editing



- 5 Highlight 'To' then, in the same way, find the end of the section to erase, then press ENTER.

After pressing **ENTER**, another marker indicates the end of the section, with the section itself marked in red.



- 6 Select 'Yes' to confirm, or 'No' to cancel.

In the thumbnail viewer you can see a few seconds of video either side of the marked section to see how the edit will look.

- When editing VR mode Original content, you may not be able to erase very short sections (less than five seconds).

Divide

HDD DVD (VR) DVD-RAM *Play List only*

Use this command to divide a title into two. Note that once divided, the two new HDD titles cannot be recombined into one again.



- 1 Highlight the title you want to divide.



- 2 Select 'Edit' > 'Divide' from the command menu panel.

- 3 *HDD only:* Select the type of edit.

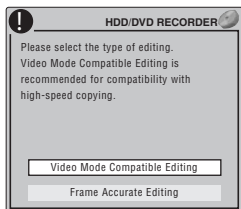

- For more information about these options, see *Editing accuracy* on page 66.

- 4 Use the playback controls (▶, II, ◀◀, ▶▶, etc.) to find the place you want to divide the title.



- 5 **ENTER** Press to divide the title at the current playback position.



- 6 Select 'Yes' to confirm or 'No' to cancel.

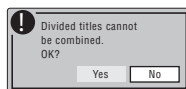

Chapter Edit

DVD (VR) DVD-RAM **HDD**

When editing a VR mode DVD or video on the HDD you can edit individual chapters within a title, with commands for erasing, combining and dividing.

- 1 Highlight the title that contains the chapters you want to edit.



- 2 Select 'Edit' > 'Chapter Edit' from the command menu panel.



- 3 *HDD only:* Select the type of edit.

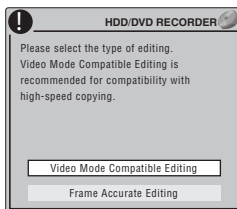

- For more information about these options, see *Editing accuracy* on page 66.
- 4 Select the command you want:**
- **Divide** – Divide a chapter into two or more parts: Use the playback controls (▶, II, ◀◀, ▶▶, etc.) to find the point at which you want to divide the chapter, then press **ENTER**.

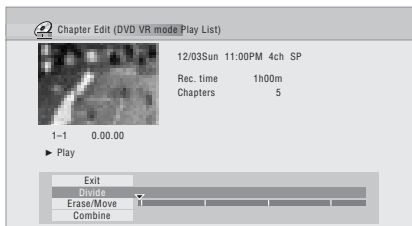

You can keep dividing the chapter as many times as you wish (up to 999 chapters per DVD-R/-RW/-RAM disc or 99 chapters per HDD title).

- **Erase¹/Move²** – Erase or move chapters: Select the chapter you want to erase/move and press **ENTER**. Select whether you want to erase or move the chapter.

Move command only: Select the destination for the chapter, and press **ENTER**.

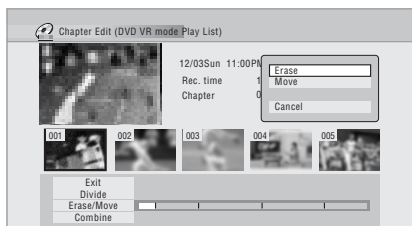

- **Combine³** – Combine two adjacent chapters into one: Highlight the bar divider between two adjacent chapters and press **ENTER**.

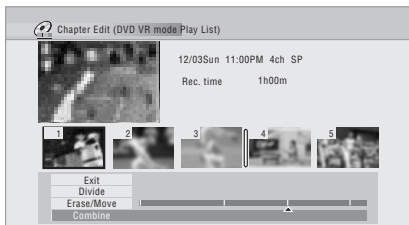

- 5**  Select 'Exit' to get back to the main Disc Navigator screen.

Set Genre



Use this command to assign a genre to a title.

- 1**  Highlight the title you want to assign a genre to.

- 2**  Select 'Edit' > 'Set Genre' from the command menu panel.



Note

- 1 When editing VR mode Original content, it may not be possible to erase chapters less than five seconds long.
- 2 VR mode Play List only.
- 3 It may not always be possible to combine two chapters, even though they are adjacent. If a chapter has been divided into three, then the middle chapter erased, it is not possible to combine the two remaining chapters into one.



3 Select a genre for the title.

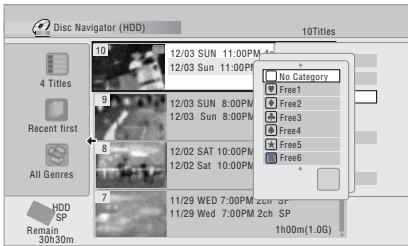

Lock

HDD DVD (Video) DVD (VR) DVD+R DVD+RW

DVD-RAM

Original only

You can lock a title so that it can't be edited or erased accidentally. If you do need to edit it, you can always unlock it later.



Important

- You can't undo any edits made before changing the lock status. You also can't undo a lock/unlock command using the **Undo** option from the Disc Navigator menu.

1 Highlight the title you want to lock (or unlock).



2 Select 'Edit' > 'Lock' from the command menu panel.



An unlocked title will become locked; a locked title will be unlocked. Locked titles are shown in the Disc Navigator with a padlock icon.

Move

DVD (VR) DVD-RAM *Play List only*

Use this function to re-arrange the playing order of Play List titles.



1 Highlight the title you want to move.



2 Select 'Edit' > 'Move' from the command menu panel.

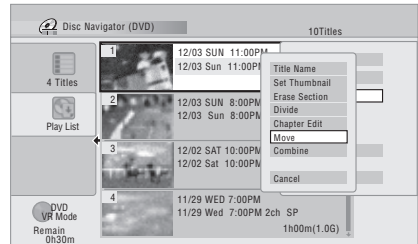

3 Select a new position for the title.

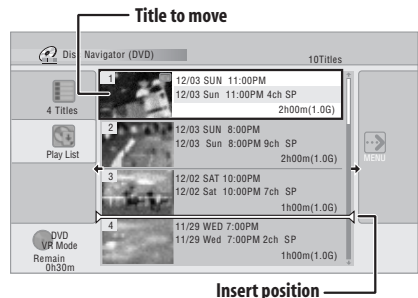

After pressing **ENTER**, the new, updated Play List is displayed.

Combine

DVD (VR) DVD-RAM *Play List only*

Use this function to combine two Play List titles into one.



- 1 Highlight the title you want to combine.

This title will remain in the same place after combining with another title.



- 2 Select 'Edit' > 'Combine' from the command menu panel.

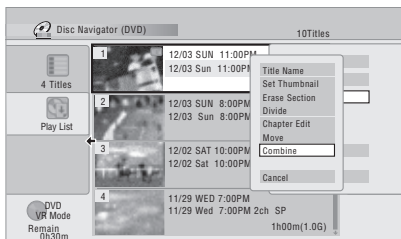

- 3 Select another title to combine with the first.

This title will be appended to the first title selected.

The screen below shows title 3 selected to be appended to title 1.

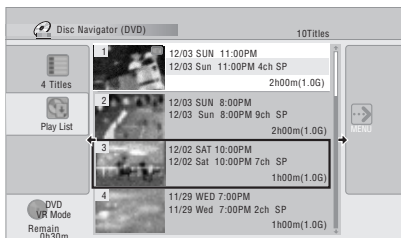

- 4 Select 'Yes' to confirm or 'No' to cancel.

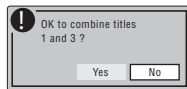

Genre Name

HDD

Use this command to rename one of the ten user-definable genres (**Free 1 to Free 10**).



- 1 Select 'Genre Name' from the command menu panel.

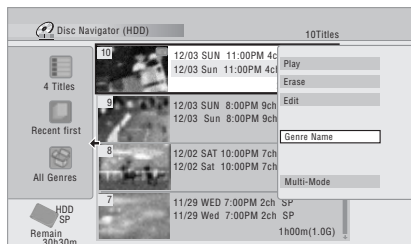

- 2 Select one of the user-definable genre names.



- 3 Input a name for the genre.

- The name can be up to 12 characters long.

- For information on remote control key short cuts, see *Using the remote key shortcuts to input a name on page 69.*

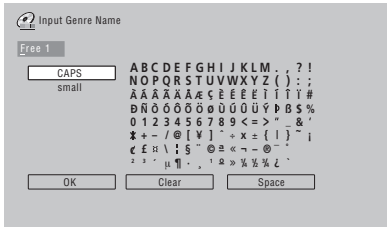

4 Select 'OK' to enter the name and exit.

Multi-Mode



Multi-Mode allows you to select several titles, then select a command that will be applied to all of them. In this way you can select multiple titles and then erase them all at once, for example.



1 Select 'Multi-Mode' from the command menu panel.

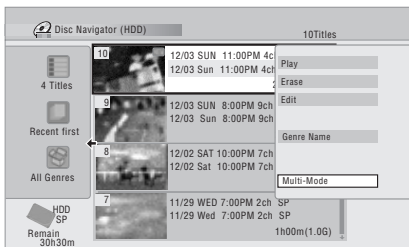

2 Select titles from the title list. Selected titles are marked with a .



3 Select the command that you want applied to all the marked titles.

For example, select **Erase** to erase all the marked titles.

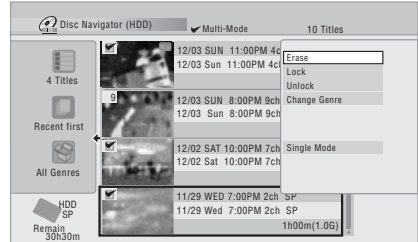

Once the command is completed, Multi-Mode is automatically exited.

Undo

DVD (Video) DVD (VR) DVD+R DVD+RW

If you make a mistake while editing, you can generally undo it. There is one level of undo (in other words, you can only undo the last edit you made).



• Select 'Undo' from the command menu panel.

- You can't undo anything after exiting the Disc Navigator screen.

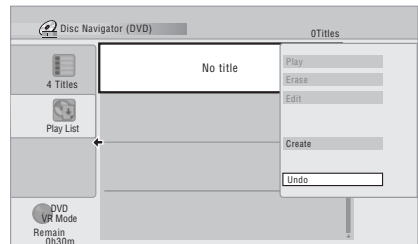



Frequently asked questions

- *Why doesn't the available recording time increase when I erase titles from a VR mode DVD-R?*

When you erase titles from a DVD-R (or DVD+R), the titles are no longer displayed, but the content remains on the disc. DVD-R/+R are write-once media; they can't be erased or rewritten.

- *I can't edit my disc!*

You may find that as the available recording time is reduced on a VR mode DVD-R disc, editing is no longer possible. This is because information about your edits requires a certain amount of disc space. As you edit, this information builds up, eventually preventing you from editing further.

Chapter 9

Copying and backup

Introduction

Use the copying features of this recorder to:

- Back up important recordings stored on the HDD to a DVD.
- Make a DVD copy of a recording on the HDD to play in another player.
- Transfer video from a DVD to the HDD for editing.
- Transfer edited video from the HDD to DVD.

The simplest way to copy a title is to use the One Touch Copy feature. This copies the currently playing HDD title to DVD, or DVD title to the HDD. See *One Touch Copy* below for detailed instructions.

For more sophisticated copying tasks you can build a Copy List of titles to copy, and edit titles so that you only copy the bits you want. See *Using Copy Lists* on page 79 for detailed instructions.

Where possible, the recorder will copy your recordings at high-speed. Depending on the recording mode, the kind of disc loaded and various other factors, copying can be as fast as one minute per hour of video. See *Minimum copying times* on page 114 for more on copying times.

If you want to save disc space you can copy video at a lower recording quality (for example, an **XP** recording on the HDD copied to **SP** on a DVD). Copying in this way is always done in real-time.

When real-time copying from the HDD to a DVD-R/+RW (Video mode) or DVD+R/+RW, the chapter markers in the original material are not copied. Chapter markers are put into the copy at intervals, according to the Auto Chapter settings (see also *Auto Chapter (Video)* and *Auto Chapter (DVD+R/+RW)* on page 109).

Restrictions on copying

Commercial DVD-Video discs are protected using Copy Guard. These discs cannot be copied to the HDD.

Some video material is copy-once protected. This means that it can be recorded to HDD, but it can't then be freely copied again. If you want to transfer copy-once protected material from HDD to DVD, you'll need to a CPRM ver. 1.1 or higher VR mode DVD-RW, ver. 2.0 or 2.1 VR mode DVD-R, or CPRM-compatible DVD-RAM disc (see *CPRM* on page 35 for more on this). Only one instance of a copy-once protected title can be added to the Copy List, and after it's been copied, the title is erased from the HDD (it is therefore not possible to copy a locked title that is copy-once protected).

You can identify copy-once protected material during playback by displaying disc information on-screen. If the current title is copy-once protected, an exclamation mark (!) is shown.

Copyright

You may use this product only to reproduce or copy materials for which you own the copyright or have obtained permission to copy from the copyright owner or for which you otherwise have a legal right to reproduce or copy. Unless you own the copyright or have obtained permission from the copyright owner or otherwise have a legal right to reproduce or copy, you may be violating the law, including copyright law, and may be subject to payment of damages and other remedies.

One Touch Copy

* See also *Copyright* above.

The One Touch Copy feature copies the currently playing or selected (in the Disc Navigator) HDD title to DVD, or DVD title to

HDD. The whole title is copied, regardless of where in the title you start the copy.

HDD to DVD copies are made in the same recording mode. When copying DVD to HDD, the copy is made in whatever recording mode is currently set.

Make sure that a recordable DVD disc is loaded when trying to copy from the HDD.

REC MODE

1 If you're copying from DVD to the HDD, select a recording mode.

Note that selecting a recording mode higher than the title playing will not result in a better quality recording.

ONE TOUCH COPY

2 Press during playback to copy the current title.

The front panel display indicates that the title is being copied.

- High-speed copying is used when copying from the HDD to DVD. Playback continues while copying.
- Real-time copying is used when copying from DVD to the HDD. Playback restarts from the beginning of the title.

Cancelling One Touch Copy

You can cancel a One Touch Copy once it's started.

ONE TOUCH COPY

Press and hold for more than a second.

Copying is cancelled and the video already copied is erased.

- If you cancel a HDD to DVD-R/+R copy, the space available for recording does not return to the pre-copy figure.

Notes on copying using One Touch Copy

Copying to DVD

- Title name, chapter markers, as well as thumbnail picture markers for the Disc Navigator, are also copied. However, if you copy to a DVD-R/-RW (Video mode)

or DVD+R/+RW, only the first 40 characters of a name are copied.

- The chapter markers in the copy may not be in exactly the same positions as the original when recording on to a DVD-R/-RW (Video mode) or DVD+R/+RW.
- You can't use the One Touch Copy function to copy a title if any part of the title is copy-once protected.
- A title that contains mixed aspect ratios can't be copied to a DVD-R/-RW (Video mode) or DVD+R/+RW. Use a DVD-R/-RW (VR mode) or DVD-RAM disc for this type of material.
- Low resolution (**SEP** through **LP** modes¹) widescreen material can't be copied to a DVD-R/-RW (Video mode) or DVD+R/+RW. Use a DVD-R/-RW (VR mode) or DVD-RAM disc for this type of material.
- When HDD Recording Format is set to Video Mode Off, titles recorded in **LP/MN9** to **MN15** modes cannot be high-speed copied to a DVD-R/-RW (Video mode) or DVD+R/+RW. Please use a DVD-R/-RW (VR mode) or DVD-RAM.
- Recordings of dual mono broadcasts cannot be high-speed copied to a DVD-R/-RW (Video mode) or DVD+R/+RW. Please use a DVD-R/-RW (VR mode) or DVD-RAM.
- **XP+** titles cannot be copied to DVD via One Touch Copy.
- Titles over eight hours cannot be copied to single-layer DVD+R/+RW discs using One Touch Copy. Use DVD+R DL discs for titles over eight hours.
- Titles recorded in **MN1** to **MN6**, **SEP**, **SLP** or **EP** mode cannot be copied to DVD+R/+RW using One Touch Copy.

Copying to the HDD

- The maximum title length for copying is 12 hours.
- Title name and chapter markers are also copied, except when copying from a finalized Video mode DVD-R/-RW.

Note

¹ In manual recording mode these equate to **MN1** to **MN15** (Video Mode Off) or **MN1** to **MN8** (Video Mode On).

- Thumbnail picture markers and chapter markers for the Disc Navigator are copied, but their position in the copy may be slightly changed from the original.
- If some part of the title being copied is copy-protected, copying will start, but the copy-protected portions will not be copied.

Using Copy Lists

* See also *Copyright* on page 77.

At its simplest, a Copy List is just a list of HDD or DVD titles that you want to copy. When copying HDD titles to DVD, you can, however, edit the titles in your copy list, erasing chapters you don't need, or re-naming titles, for example. Edits you make to titles in the Copy List do not affect the actual video content; only the 'virtual' content of the Copy List. So you can freely erase and modify anything in your Copy List safe in the knowledge that the actual content is not being altered.

Copying from HDD to DVD

Important

- The recorder can only store one Copy List at a time.
- Resetting the recorder to its factory settings (see *Resetting the recorder* on page 127) will erase the Copy List.

1 Load a recordable DVD.

- It is possible to complete the following steps without having a recordable DVD loaded (or having an uninitialized DVD loaded); however, the steps are slightly different.
- If you want to use a DVD-RW (VR mode) disc for the copy, make sure it is initialized before you start.

2  Select 'Copy' from the Home Menu.

3  Select 'HDD → DVD'.

If this is the first time to create a Copy List, skip to step 5 below.

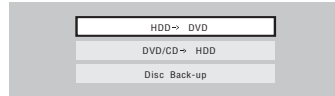

4 If there is already a Copy List stored in the recorder, choose whether to 'Create New Copy List' or 'Continue Using Previous Copy List'.

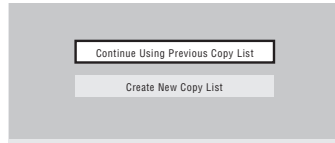

- If you select **Continue Using Previous Copy List**, skip to step 10 below.
- Selecting **Create New Copy List** will erase any Copy List already stored in the recorder.

5  Add titles to the Copy List (highlight a title and press ENTER to add).

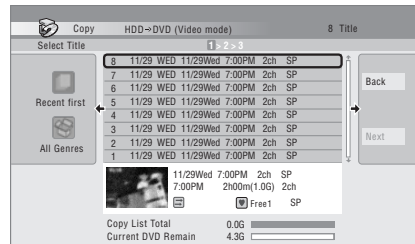

Titles you've added to the Copy List are highlighted in pink.

There are some restrictions on titles that can be added to the Copy List if you are copying to a DVD-R/-RW (Video mode) or DVD+R/+RW:

- When adding titles that contain copy-once protected material, the copy-once parts will not be added.
- When adding titles that contain material of more than one aspect ratio (screen size), each part with a different aspect ratio will be added as a separate title if high-speed copying is possible.

Depending on the title¹, high-speed copying may not be possible to DVDs.

6 Press **→** to display the command menu panel.

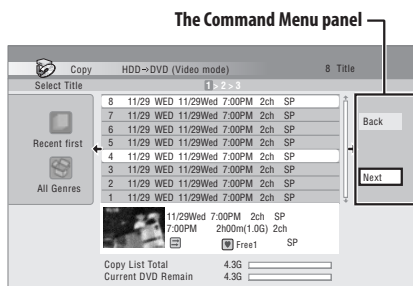

7 Select **'Next'** to move on to the Title Edit screen.

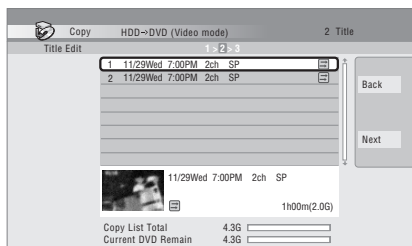

8 To edit a title, highlight it using the **↑/↓** buttons, then press **ENTER**.

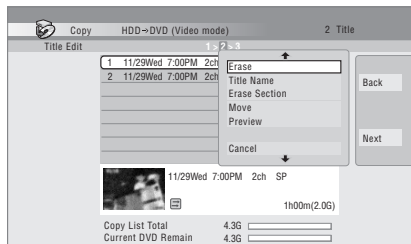

A menu of editing commands appears:

- **Erase** – Erase individual titles from the Copy List (see *Erase* on page 67).
- **Title Name** – Name or rename a title in the Copy List (see *Title Name* on page 68).
- **Erase Section** – Erase part of a title (see *Erase Section* on page 70).
- **Move** – Change the order of titles in the Copy List (see *Move* on page 73).
- **Preview** – Check the content of a title in the Copy List.
- **Divide** – Divide a title in the Copy List into two (see *Divide* on page 71).
- **Combine** – Combine two titles in the Copy List into one (see *Combine* on page 74).
- **Chapter Edit** – Edit chapters within a Copy List title (see *Chapter Edit* on page 71):
 - **Divide** – Divide a chapter into two.
 - **Erase/Move** – Erase a chapter/ Change the chapter order.
 - **Combine** – Combine two chapters into one.

Note

¹ The following titles cannot be copied at high-speed for DVD+R/+RW:

- Titles recorded in **MN1** to **MN6**, **SEP**, **SLP** or **EP** mode.

The following titles cannot be copied at high-speed for DVD-R/+RW (Video Mode) and DVD+R/+RW:

- Widescreen titles recorded at low resolution (**SEP** through **LP/MN1** to **MN15** (Video Mode Off) or **MN1** to **MN8** (Video Mode On)).
- **LP/MN9** to **MN15** recordings when HDD Recording Format is set to Video Mode Off.
- Dual mono recordings.
- Combined titles that were originally recorded using different recording modes.

The following titles cannot be copied at high-speed for any types of DVD:

- **XP+** titles.

- **Set Thumbnail** – Set the thumbnail frame for a title (see *Set Thumbnail* on page 70).
- **Recording Mode** – Set the picture quality of the copy (see *Recording Mode* on page 82).
- **Dual Mono Audio** – Set how dual mono audio should be copied when copying from HDD to DVD-R/-RW (Video mode) and DVD+R/+RW (see *Dual Mono Audio* on page 83).
- **Cancel** – Exit the menu.

Repeat this step for as many titles you have that need editing.



9 Display the command menu panel.



10 Select 'Next' to proceed.

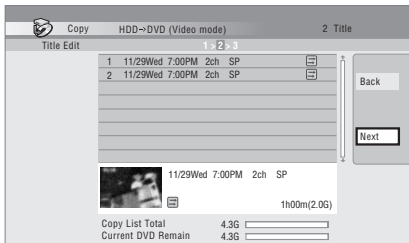

There are several options available from the next screen:

- Select **Recording Mode** if you want to change the recording quality (see *Recording Mode* on page 82).
- Select **Input Disc Name** if you want to change the disc name. Input a name of up to 64 characters for a VR mode disc or 40 characters for a Video mode disc or DVD+R/+RW. (The input method is similar to that of naming titles; see *Title Name* on page 68.)

- Select **Finalize** if you want to automatically finalize a DVD-R/-RW (Video mode) or DVD+R after copying.¹ Select a title menu style from the following screen.



11 Select 'Start Copy' to start copying.

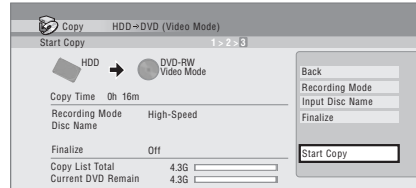

- If you're using a DVD-R DL or DVD+R DL disc and the copy will span both layers, the **Copy List Total** bar will be purple.
- The **Current DVD Remain** bar will be half-length if the first layer of a DVD-R DL or DVD+R DL disc is already full.

Copying from DVD to HDD



Important

- The DVD to HDD Copy screen isn't accessible when a finalized Video mode DVD-R/-RW or a DVD-Video is loaded. As long as the disc is not Copy Guard protected, you can still use the One Touch Copy function, however (See *One Touch Copy* on page 77).
- The recorder can only store one Copy List at a time.
- The Copy List will be erased if:
 - any of the titles on the DVD disc are erased or edited.
 - the disc tray is opened.
 - playback is switched between Play List and Original.
 - the DVD disc is re-initialized or finalized.

Note

¹ If a timer recording is scheduled to start during copying, the disc will not be finalized.

Copying and backup

– the recorder is reset to its factory settings (see *Resetting the recorder* on page 127).

- It may not be possible to copy from a DVD disc that was recorded on a different DVD recorder or a PC.

- 1**  Select 'Copy' from the Home Menu.

- 2**  Select 'DVD/CD → HDD'.

- 3**  Select a Copy List type.
- Selecting **Create New Copy List** will erase any Copy List already stored in the recorder.

- 4**  Add titles to the Copy List (highlight a title and press ENTER to add). Titles you've added to the Copy List are highlighted in pink.

- 5**  Select 'Next' from the command menu panel to proceed to the title edit screen.

- 6**  Select a title to edit.
A menu appears of Copy List editing commands:

- **Erase** – Erase individual titles from the Copy List (see *Erase* on page 67).
- **Move** – Change the order of titles in the Copy List (see *Move* on page 73).
- **Preview** – Check the content of a title in the Copy List.

- **Cancel** – Exit the menu.

Repeat this step for as many titles you have that need editing.

- 7**  Select 'Next' from the command menu panel to proceed to the copy options screen.

- Select **Recording Mode** if you want to change the recording quality (see *Recording Mode* below).

- 8**  Select 'Start Copy' to start copying.

Recording Mode

- 1**  Select 'Recording Mode' from the command menu panel.

- 2**  Select a recording mode for the copy.

- **High-Speed Copy**¹ – The Copy List is copied at the same recording quality as the original.
- **XP, SP, LP, EP, SLP, SEP, MN**² – The Copy List is copied at the specified recording quality in real-time. (Note that if you copy at a higher quality setting than the original, the copy will not be better quality than the original.)

If you select **MN** above, you can also change the level setting (**MN1** to **MN3**³, **LPCM** or **XP+**⁴) from the Recording Quality box that appears.



Note

- When copying to a DVD-R/+RW (Video mode) or DVD+R/+RW, the chapter markers in the copy may not be in exactly the same position as the original.
- When the copy mode is set to something other than High-Speed Copy for copying to a DVD-R/+RW (Video mode) or DVD+R/+RW, the chapter markers of the original are not copied. Chapter markers are put into the copy at regular intervals, according to the Auto Chapter setting (see also *Auto Chapter (Video)* and *Auto Chapter (DVD+R/+RW)* on page 109).
- When copying to a DVD+R/+RW, **MN1** to **MN3** and **SEP** modes are not available.
- XP+** mode available only when copying to HDD.

- **Optimized**^{1,2} – The recording quality is automatically adjusted so that the Copy List fits on to the space available on the disc. Copying is carried out in real-time.

When you change the recording mode setting, you can see how much disc space it will require. If this is more than is available, it shows up in red and you won't be able to start copying. In this case, either change the recording quality, or press **RETURN** to go back to the Copy List screen and erase one or more titles from the Copy List.

Dual Mono Audio

- 1  **Select the title containing the audio you want to change.**
- 2  **Select 'Dual Mono Audio' from the command menu panel.**
- 3  **Select a dual mono audio option.**

Using disc backup

* See also *Copyright* on page 77.

This feature offers a simple way to make a backup copy of finalized DVD-R/+RW (Video mode) discs or DVD+R/+RW discs. The data is copied first to the hard disk drive³, then on to another recordable DVD disc.

- 1  **Select 'Copy', then 'Disc backup' from the Home Menu.**

- 2  **Select a backup option.**

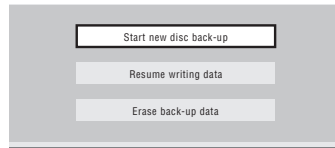

There are three backup options:

- **Start new disc back-up** – Start making a backup of a disc.
- **Resume writing data** – Record the backup data already on the HDD to a recordable DVD.
- **Erase back-up data** – Erase the backup data on the HDD.

- 3 **Load the disc you want to make a backup of.**

You can only make backup copies of finalized Video mode DVD-R/+RW discs, finalized DVD+R or DVD+RW discs (excluding DVD-R DL/DVD+R DL discs).

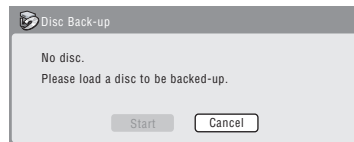

- 4  **Select 'Start'.**

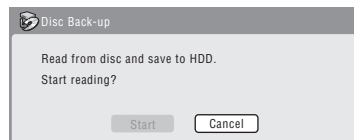

- To see the progress of the backup, press **DISPLAY**.

Note

- 1 When the copy mode is set to something other than High-Speed Copy for copying to a DVD-R/+RW (Video mode) or DVD+R/+RW, the chapter markers of the original are not copied. Chapter markers are put into the copy at regular intervals, according to the Auto Chapter setting (see also *Auto Chapter (Video)* and *Auto Chapter (DVD+R/+RW)* on page 109).
- 2 Optimized mode only available when copying to DVD. Due to remaining space on the disc or the title that you copy, this mode does not always exactly fill a disc.
- 3 It is not possible to play this material directly from the HDD.

- You can cancel the backup process by pressing **ONE TOUCH COPY** for more than one second.

5 When the data has been copied, take out the disc and load a blank* recordable DVD.

* If you're using a DVD-RW or DVD+RW, the disc doesn't have to be blank, although the previous contents of the disc will be erased in the backup process.

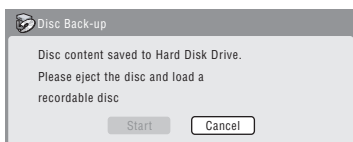

You can use a DVD-R ver. 2.0, 2.1 or 2.2 disc, or DVD-RW ver. 1.1 or ver. 1.2 disc for the backup.

- If you backup a DVD-R disc to DVD-RW, you cannot undo the finalization later.
- Actual recordable capacity of discs vary so there may be cases where the contents of the disc you're backing-up will not fit on to a particular blank disc. If this happens, please try another brand of disc.
- DVD-R/-RW discs can only be backed up to DVD-R/-RW discs; DVD+R/+RW discs can only be backed up to DVD+R/+RW discs.

6 Select 'Start' to start writing the backed-up data to the blank disc.

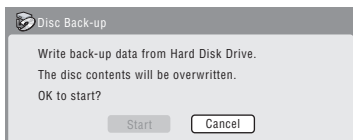

- To see the progress of the backup, press **DISPLAY**.

- You can cancel the backup process by pressing **ONE TOUCH COPY** for more than one second. However, this will make the disc unusable (although if you are using a DVD-RW or DVD+RW disc you can re-initialize it in order to make it usable again — see *Initializing recordable DVD discs* on page 49.)

7 After the recorder has finished recording the backup disc, you can select whether to make another backup of the same data or exit.

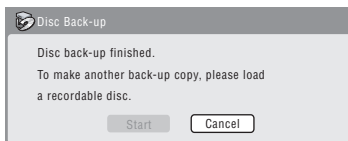

- Select **Start** to make another backup copy or **Cancel** to finish. If you want to make another backup copy, return to step 6 above.

8 If you don't need to keep the backup data on the HDD, you can delete it now.

Select **Yes** to delete the data from the HDD; select **No** to keep it (you can delete it later if you want to).

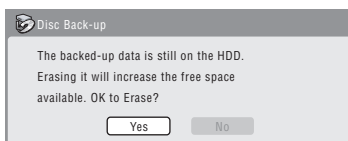

- If you decide to leave the backup data on the HDD, you can make backup copies to recordable DVD discs anytime from the Disc Back-up menu.

Chapter 10

Using the Jukebox

The Jukebox feature allows you to use the recorder's HDD to store and playback music from up to 999 of your CDs. You can also transfer WMA/MP3 files stored on CD-R/-RW/-ROM, DVD, USB device or PC (USB function only works with DVR-650H-K and DVR-550H-K). Once on the HDD, you can name albums and tracks, assign them a genre, and set tracks that you don't want to play to Jump.

Copying music to the HDD

The first step is to copy some music to the HDD. CD audio, WMA and MP3 files are copied at high speed. All tracks are copied from each CD/DVD as an album.¹

WMA/MP3 album and track names are copied along with the audio. CD album and track names are not copied, but you can add these later (see *Editing Jukebox albums* on page 89).

Usually, the tracks are copied to the HDD in the order they appear on the CD/DVD.

Note that once copied to the HDD, audio tracks cannot be copied to a recordable DVD disc.



Important

- While copying, no other recorder operation is possible.
- When copying, scheduled timer recordings will not start until copying is complete.
- Copy protected CDs may not copy successfully.

1 Load the CD/DVD you want to copy to the HDD.

2 Select 'Copy' from the Home Menu.



3 Select 'DVD/CD to HDD'.

On pressing **ENTER** all tracks (or files) on the CD or all WMA/MP3 files on the DVD are copied to the HDD.

- You can also start copying by starting playback of the CD/DVD and then pressing **ONE TOUCH COPY**.
- To cancel copying press **ENTER**.
- If the CD loaded contains both CD audio tracks and WMA/MP3 files, the part currently selected will play.

Copying files via USB

(DVR-650H-K/DVR-550H-K only)

Connecting a regular USB device

You can copy WMA or MP3 files from a connected USB device, such as a USB drive, to the HDD.

1 Connect the USB device.

2 Select 'Jukebox' from the Home Menu.



3 Select 'Listen to Music from USB Device'.



4 Select 'Copy Album' from the command menu panel.



5 Select 'Yes' to confirm or 'No' to cancel.

The selected folder on the USB device will be copied to the HDD.

Note

- ¹ Up to 999 albums can be created in the Jukebox. If you copy via Connect PC, the total number of albums you are able to create may be less than 999 (for more information, see page 87).
- Sound quality is not worsened when you copy data from another source.
- When playing back an album copied from a source whose original audio track plays continuously (such as a live recording), there will be a brief pause in sound between tracks.

- Up to 99 folders/999 files on the USB device can be copied/displayed.

Connect PC

Using a USB connection, you can copy WMA and MP3 files from a PC to the HDD of this device. Operations carried out on the PC require Windows Media Player 10.



Important

- If the PC you are using does not currently have Windows Media Player 10 installed, you must first install the program and make sure it functions correctly before connecting the USB cable and attempting to use the Connect PC function.
- For more information on Connect PC, see *Using a PC* on page 25.
- You cannot edit or delete albums from this device when it is connected to a PC via USB. If you wish to edit or delete albums via the Jukebox, you must first disconnect the USB cable.

1 Connect the PC via USB cable.

The screen below is displayed. Choose 'Take no action' and click 'OK'.

*Depending on the settings for Windows Media Player 10, the screen shown below may not be displayed.



'OK'

- 2  Select 'Jukebox' from the Home Menu.

- 3  Select 'Connect PC'.

- 4  Select 'Yes' to confirm, or 'No' to cancel.

- 5 **Verify that the import screen is displayed on the device.**

If no actions are carried out for 20 minutes, the import screen is automatically closed. To reopen it, you will have to repeat steps 2 through 4.

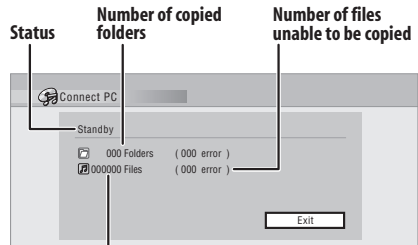

Number of copied files

Using the Jukebox

6 Open Windows Media Player 10 on the PC.

The device settings screen appears. Click 'Cancel'.

*Depending on the settings for Windows Media Player 10, the screen shown below may not be displayed.



'Cancel'

From the PC, in Windows Media Player 10:

1. Click 'Library'.
2. Choose the artist, album or song you would like to copy, and press the right mouse button.
3. Click 'Add to Sync list' (when choosing songs, click 'Add to' then 'Sync list').
4. Click 'Start Sync' in Windows.

This begins the synchronization process. When finished, the message 'Synchronized to Device' is displayed in Windows Media Player 10.

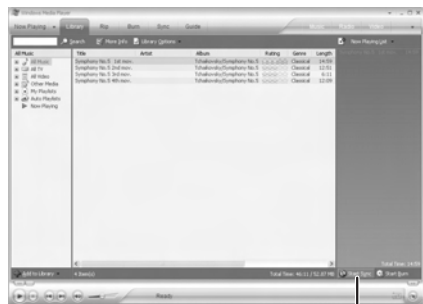

'Start Sync'

For more information refer to the Help menu of Windows Media Player 10.

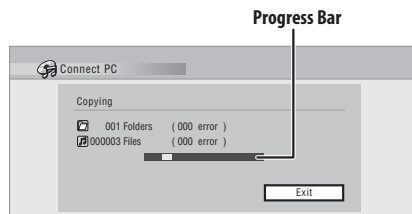

- To cancel the synchronization process while it is underway, press **ENTER** on the remote control. The Connect PC screen is closed.

7 When you have finished copying files, close Windows Media Player 10 on the PC.

8 Close the import screen on this device.

- If no actions are carried out for 20 minutes after copying, the import screen is automatically closed.

Note

- When using the sync function of Windows Media Player 10, music, artist and album folders are created as follows:

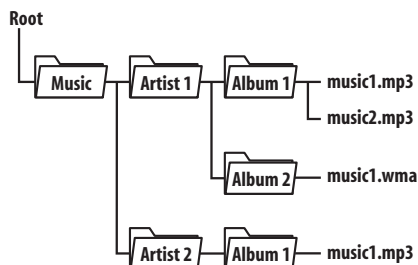

- Folders containing no files are not displayed in the Jukebox (such as the above 'Artist1' and 'Artist2' folders), but do count toward the maximum of 999 folders allowed in Jukebox.

- Up to 999 tracks can be included in one album. Note that when there are many tracks contained in one album, it may take time to display and transfer these tracks.
- Albums and tracks with no set name that are transferred from CD/DVD/USB are displayed as 'UnknownAlbum' and 'UnknownFile' in Windows Media Player 10.
- Album and track names that do not conform to the ISO8859-1 standard may display differently in Windows Media Player 10 and the Jukebox.
- When albums are deleted in the Jukebox, their file hierarchy as displayed in Windows Media Player may change.
- File whose extensions are not supported by the Jukebox (i.e. files that are not .mp3 or .wma) cannot be transferred.
- Files imported to this recorder via Connect PC cannot be exported from this recorder.
- Note that no recording functions, including timer recordings, will be carried out when you are using the Connect PC function.

Playing music from the Jukebox

You can select albums or individual tracks from the Jukebox to play.

- 1  Select 'Jukebox' from the Home Menu.

For DVR-450H-S, skip to step 3.



- 2 Select a Jukebox option.

- **Listen to Music/Edit** – Listen to CDs or WMA/MP3 files that have been copied to the HDD.
- **Listen to Music from USB device** – Listen to music from an external USB device.



- 3 Select what you want to play.

The screen below shows albums stored on the HDD:

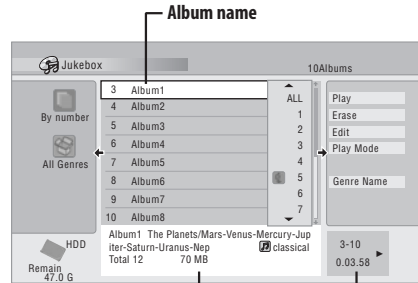

Info for selected album

Playback status

- If you select a whole album to play, all tracks that are not set to Jump will play.
- If you want to start playback from a selected track in an album, or play a track that is set to Jump, press  to enter the track list then select a track to play.

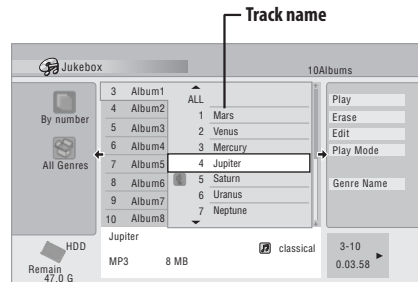

- Press **SUBTITLE** or **ANGLE** to change the page.

Changing the album view

1  From the album list, display the view options menu panel.

2  Select a view option.

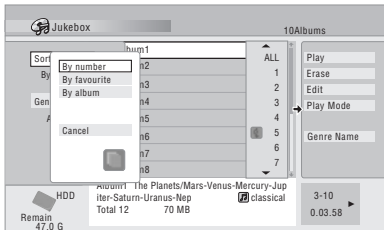

• Sort order

By number – Albums are listed by the album number.

By favourite – Most often listened to music appears at the top of the list.

By album – Albums are listed alphabetically.

• Genre

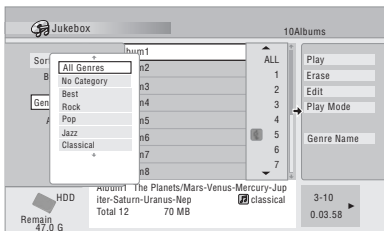

All Genres – All albums are displayed.

Genre – Only albums in the selected genre are displayed.

Editing Jukebox albums

A number of commands are available for editing and changing the playback behavior of albums.

1  Select 'Jukebox' from the Home Menu.

For DVR-450H-S, skip to step 3.

2  Select 'Listen to Music/Edit'.

3  Select what you want to edit.

4  Select an edit function from the command menu panel.

- **Erase** – Erase the selected track (if all tracks in an album are selected, the whole album is erased).
- **Edit > Album name** – Enter a name of up to 64 characters for the album. See page *Title Name* on page 68 for how to enter names.
- **Edit > Track name** – Enter a name of up to 64 characters for the track. See page *Title Name* on page 68 for how to enter names.
- **Edit > Set Genre** – Set or change the genre for the album.
- **Edit > Jump Set¹** – Set a track to jump so that it doesn't play (choose this command again to cancel the Jump setting).
- **Play Mode** – Change the playback order for albums and tracks.
- **Genre Name** – Enter a name of up to 12 characters for a genre. See page *Title Name* on page 68 for how to enter names.

Note

¹ Tracks set to Jump will be skipped during consecutive track playback.

Chapter 11

The PhotoViewer

From the PhotoViewer you can view JPEG photos and picture files stored on the HDD, recordable DVD or CD-R/-RW/-ROM, or on a USB-equipped digital camera (USB function only works with DVR-650H-K and

DVR-550H-K).¹ You can also import files and save them to the recorder's HDD or a DVD-R/-RW disc.

Locating JPEG picture files

1  Select 'PhotoViewer' from the Home Menu.

2  Select the location of the files you want to view or edit.



- **View/Edit Photos on the HDD** – View or edit photos already stored on the recorder's HDD.
- **View Photos on a CD/DVD** – View photos on a Fujicolor CD, CD-ROM, CD-R/-RW, or DVD-R/-RW.
- **View Photos on a USB Device** (DVR-650H-K/DVR-550H-K only) – View photos on a digital camera (or other USB device) connected to the USB port.
- **Copy Files from a Digital Camera** (DVR-650H-K/DVR-550H-K only) – Copy all DCF files directly from a connected digital camera to a recordable DVD-R/-RW.

3  Select the folder containing the files you want to view, copy or edit. The first image from the selected folder is displayed as thumbnail at the bottom of the screen. From the Folder Information column, you can change thumbnails via the <<< >>> buttons.

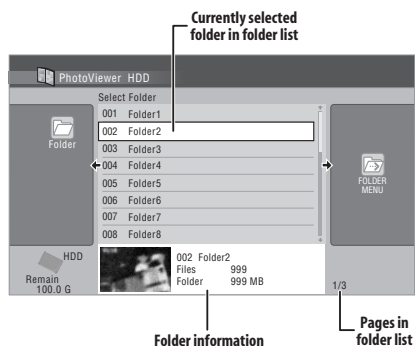

4  Select the file you want to view, copy or edit.

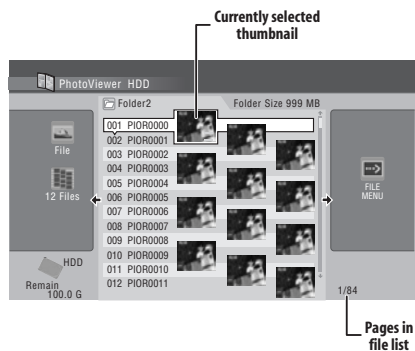

Note

¹ Up to 999 files or 99 folders are viewable, but if there are more files/folders than this on the disc or connected USB camera it is still possible to view them all using the Reload function (see *Reloading files from a disc or USB device* on page 92).

The PhotoViewer

- The larger the file size, the longer it takes the recorder to load the file.
- You can change folders via the ◀◀/▶▶ buttons.
- If you encounter a disc that will not play, check that the disc and file formats are compatible with this recorder (see *JPEG file compatibility* and *PC-created disc compatibility* on page 12).
- The thumbnail of files that cannot be played is displayed as the  logo.

Changing the display style of the PhotoViewer

You can choose to display photos by grouping them by folder, file, or number of thumbnails.



- 1** Display the View Options panel.

The View Options panel

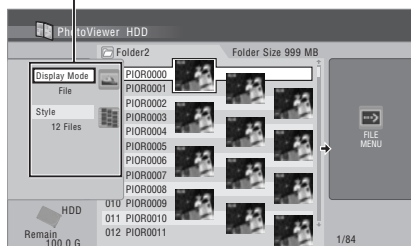

- 2** Choose 'Display Mode' or 'Style' then press ENTER to see the available view options.
- **Display Mode** – Choose between folder and file display modes.
 - **Style** – Choose between displays of 1, 4 and 12 thumbnails.



- 3** Choose a view option, then press ENTER.

The display mode will change to that which you have chosen.

Playing a slideshow



- 1** Select a folder from the folder list.

To start the slideshow from the first file in the folder, skip to step **3** after choosing the desired folder and pressing **→**.



- 2** Select a thumbnail.

- Use **I◀◀ PREV** and **▶▶I NEXT** to display the previous/next page of thumbnails.



- 3** Select 'Start Slideshow' or 'Start Audio Slideshow' from the menu.

When you select 'Start Audio Slideshow', you are prompted to select the Genre of music you would like to hear, and when you press **ENTER**, music of that Genre stored on the Jukebox will be played during the slideshow.

For more information on adding music to the HDD, see *Using the Jukebox* on page 85.

- You can also select a file or folder then press **▶ PLAY** to start playing the slideshow.
- Use **I◀◀ PREV/▶▶I NEXT** to display the previous/next picture, or **II PAUSE** to pause the slideshow.
- Depending on the aspect ratio, some pictures may be displayed with black bars top and bottom, or left and right.
- Large picture files may take a few seconds to display. This is normal.



- 4** Press to return to the thumbnail.

- You can also use the **RETURN** button.

- 5  Press to exit the PhotoViewer.

Zooming an image

During a slideshow you can zoom in to enlarge a portion of the picture by a factor of two or four. You can also move the area of the picture displayed.

- 1  Press during the slideshow to zoom the picture.

Repeated presses cycle between zoom off, 2x zoom and 4x zoom. The zoom factor is displayed on-screen.

- 2  Use to move the zoomed area.

Rotating an image

You can rotate the displayed picture during a slideshow so you can always view pictures the right way up, whichever way they were taken.

-  Press during the slideshow to rotate the displayed picture clockwise by 90°.

Press repeatedly to continue rotating the picture in increments of 90°.

Reloading files from a disc or USB device

If you have a disc with more than 1000 files and/or 100 folders, you can still view all the images using the reload function.

- 1  Navigate to the last entry in the folder list ('Read next: ...').

- 2  Load the next batch of up to 999 files/99 folders from the disc or connected USB device (USB function only works with DVR-650H-K and DVR-550H-K).

It will take a moment (at most a few minutes) to load in the images.¹

Importing files to the HDD

You can import files and save them to the HDD² from a CD, DVD or a connected USB camera (USB function only works with DVR-650H-K and DVR-550H-K). Once on the HDD you can edit and organize your pictures and print them out if you've connected a PictBridge-compatible printer (USB function only works with DVR-650H-K and DVR-550H-K).

- 1  Select the location of folders/files you want to import.

To import a whole folder, select the desired folder, press **➡**, and skip to step 3 below.

- To import multiple folders, use the Multi-Mode; see *Selecting multiple files or folders* on page 93.

- 2  Select a file to import, then press **➡**.

- To import multiple files, use the Multi-Mode; see *Selecting multiple files or folders* on page 93.

Note

¹ You can press **HOME MENU** to exit the PhotoViewer screen while the recorder is reloading images. (If you enter the PhotoViewer again, it will resume reloading.)

² For files you want to keep permanently, we recommend backing up to DVD-R/RW.



3 Select 'Copy to HDD' from the menu.



3 Select 'Multi-Mode' from the menu.

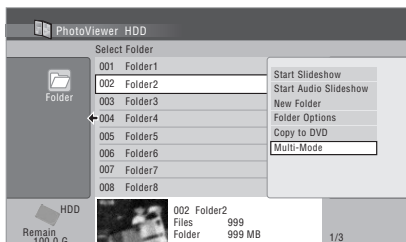

4 Select 'Yes' to confirm and copy the folder(s)/file(s), or 'No' to cancel.

- The files will be copied to the HDD with the same folder structure as the original.
- Importing to the HDD will not work if there is insufficient space on the HDD, or if there are already the maximum number of files and/or folders on the HDD (999 folders/999 files per folder).



4 Select files/folders from the list.

An orange check mark box () is shown by the item you selected. A blue check mark box () appears on the folder select screen when files from that folder are selected.

Selecting multiple files or folders

The Multi-Mode allows you to select multiple folders/files at once for importing or editing.



1 Select the folder containing the files you want to import.



2 Display the command menu.



5 Display the command menu.



6 Select the command you want to apply to all the selected items.

Copying files to a DVD-R/-RW

(DVR-650H-K/DVR-550H-K only)

Using this feature you can copy all the files¹ (including audio and movie files) stored on a connected USB camera to a recordable DVD disc.

A slideshow of the files is also recorded on the disc as a Video mode title, making it possible to view the photos on other DVD players/recorders that may not be compatible with JPEG file playback.

Once the files have been copied, the disc is automatically finalized.



Important

- Use a blank DVD-R/-RW disc, or one that has already been initialized for Video mode recording but has nothing yet recorded on it. Discs that have already been recorded on (as well as CD-R/-RW discs) cannot be used.
- After backing up the pictures in your digital camera to DVD, we recommend verifying that they have been recorded properly before deleting anything from the camera.

1 Press HOME MENU and select 'PhotoViewer' to display the PhotoViewer screen.

2 Load a blank (or unrecorded Video mode) DVD-R or DVD-RW disc.

3 Select 'Copy Files from a Digital Camera' from the menu.

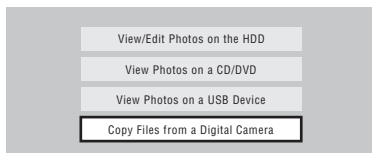

4 Select 'Yes' to confirm, or 'No' to cancel.

- Note that during copying, any timer programmes set to start will not begin, and no other operations are possible.

Copying selected files to a DVD-R/-RW

This feature allows you just to copy some of the files stored on HDD to a DVD.

A slideshow of the files is also recorded on the disc as a Video mode title, making it possible to view the photos on other DVD players/recorders that may not be compatible with JPEG file playback. Note however that you may need to finalize the disc before it will play on another DVD player (copying selected files doesn't automatically finalize the disc).



Important

- A maximum of 99 slideshow titles can be recorded.
- One slideshow title can contain up to 99 files. If there are more files than this in the slideshow, multiple slideshows are created on the disc.
- If you erase a slideshow title from a DVD the slideshow will become unplayable but the free space will not increase.

1 Load a blank (or unfinalized Video mode) DVD-R or DVD-RW disc.



2 Select 'View/Edit Photos on the HDD' from the menu.



3 Select the file(s) or folder(s) you want to copy.

- Copying a folder will copy all the files contained in it.

Note

- ¹ There is a limit to the number of files/amount of data you can copy at one time.
- Only DCF format files in DCIM folders can be copied to a recordable DVD-R/-RW.

The PhotoViewer

- To copy multiple folders, use the Multi-Mode; see *Selecting multiple files or folders* on page 93.

4  Select 'Copy to DVD' from the menu.

5  Select 'Yes' to confirm or 'No' to cancel.

- Folder names on the disc will be number **PIONR**. File names will be **PHOT number**.
- Note that during copying, any timer programmes set to start will not begin, and no other operation is possible.
- While 'Cancel' is displayed, you can press **ENTER** to cancel.

Editing files on the HDD

There are a number of commands you can use to edit and organize your pictures stored on the HDD.

Creating a new folder

1  From the folder list, display the menu.

2  Select 'New Folder'.

The folder appears at the bottom of the folder list with the name **F_number**.

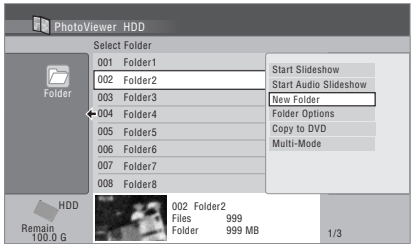

- There can be up to 999 folders on the HDD.

Erasing a file or folder

1  Select the file(s) or folder(s) you want to erase.

- To erase multiple files or folders, use the Multi-Mode; see *Selecting multiple files or folders* on page 93.
- Erasing a folder will erase all the files contained in it. Please be careful!
- You can't erase files that have been locked.
- Folders containing locked files can't be erased. Unlocked files in the folder, however, will be erased.

2  Display the command menu.

3  Select 'File Options' or 'Folder Options'.

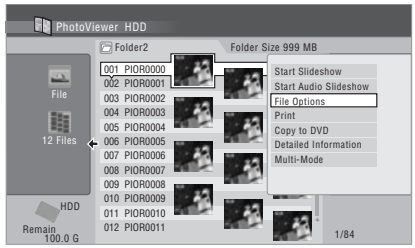

4  Select 'Erase' or 'Erase Folder'.

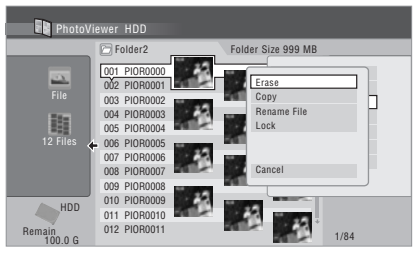



5 Select 'Yes' to confirm, or 'No' to cancel.

- You can also erase a file or folder by pressing **CLEAR** when the file or folder is highlighted. Press **ENTER** to confirm.

Copying files



1 Select the file(s) or folder(s) you want to copy.

- Copying a folder will copy all the files contained in it.
- To copy multiple files or folders, use the Multi-Mode; see *Selecting multiple files or folders* on page 93.



2 Display the command menu.



3 Select 'File Options' or 'Folder Options'.



4 Select 'Copy' or 'Copy Folder Contents'.

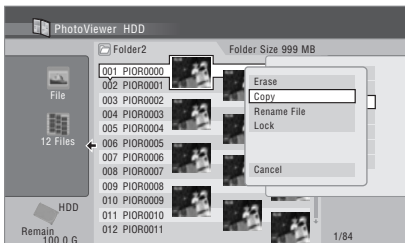

5 Select a folder to copy the folder(s)/file(s) to.



6 Select 'Yes' to confirm, or 'No' to cancel.

- Copying to the HDD will not work if there is insufficient space on the HDD; if there are already the maximum number of files and/or folders on the HDD.

Naming files and folders

1 Select the file or folder you want to rename.

You can't rename files that have been locked.

2 Select 'File Options' or 'Folder Options'.

3 Select 'Rename File' or 'Rename Folder'.

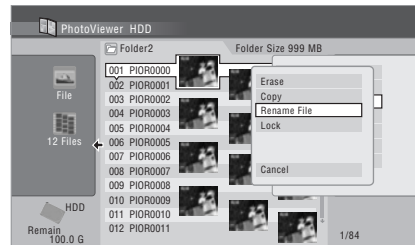

4 Enter a new name for the file/folder.

File names or Folder names can be up to 64 characters long.

See *Using the remote key shortcuts to input a name* and *Using a USB keyboard to enter a name* on page 69 for how to enter a name.

Locking/Unlocking files

Locking files will protect them from accidental erasure and prevent them from being renamed.

Use the same process to both lock and unlock files. Locked files are displayed in the PhotoViewer with a padlock icon.



1 Select the file(s) you want to lock (or unlock).

- To lock/unlock multiple files or folders, use the Multi-Mode; see *Selecting multiple files or folders* on page 93.



2 Display the command menu.



3 Select 'File Options' or 'Folder Options'.



4 Select 'Lock' or 'Lock Folder Contents'.

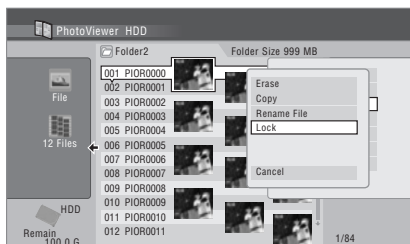

Locked files are shown with a padlock icon next to them. To remove all locks within a given folder, choose **'Folder Option' > 'Unlock Folder Contents'**.

To view detailed information

This feature allows you to check the settings of the camera from which you imported the photos.

1 Choose the file for which you would like to see detailed information.

2 Choose 'Detailed Information'.

When no detailed information is available, nothing is displayed.

Printing file

(DVR-650H-K/DVR-550H-K only)

Connecting a PictBridge-compatible printer to the USB port will enable you to print out picture files¹ stored on the HDD, a CD/DVD or directly from a digital camera.

Make sure that the printer (and your digital camera if you are using that as a source) is connected to the recorder before starting.



1 Select the file(s) you want to print.

- To print multiple files, use the Multi-Mode; see *Selecting multiple files or folders* on page 93.



2 Display the command menu.



3 Select 'Print' from the menu.

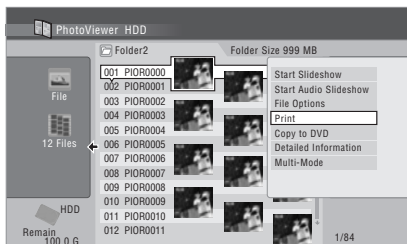

4 Select 'Start' to confirm, or 'Cancel' to cancel.

- Once printing has started, you can cancel by pressing **ENTER**.



Tip

- Paper size and layout can be set; the options available depend on your printer — check the printer manual for details.
- This recorder may not work correctly with all printers.

Note

¹ Picture files should be standard DCF format. Non-standard files may not print properly.

Chapter 12

The Disc Setup menu

From the Disc Setup menu you can name discs, lock the contents to prevent accidental recording and erasure, initialize and finalize discs. The Disc Setup menu is accessed from the Home menu.

Basic settings

Input Disc Name

DVD (VR) DVD (Video) DVD+R DVD+RW DVD-RAM

When you initialize a disc for recording, the recorder automatically assigns a name for the disc ranging from **DISC 1** to **DISC 99**. You can use the Input Disc Name function to change the default disc name to something more descriptive. This name appears when you load the disc and when you display disc information on-screen.

- 1  Select 'Disc Setup' from the Home Menu.



- 2 Select 'Basic' > 'Input Disc Name' > 'Next Screen'.

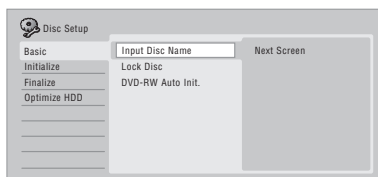

- 3 Input a name for the disc.
The disc name can be up to 64 characters long for a VR mode disc, or 40 for a Video mode discs and DVD+R/+RW.
 - See *Title Name* on page 68 for more on navigating the input screen.

Lock Disc

DVD (VR) DVD-RAM

- Default setting: **Off**

Locking the disc will prevent accidental recording, editing or erasing of the disc.



Important

- A locked disc can still be initialized (which will completely erase the disc).

- 1  Select 'Disc Setup' from the Home Menu.



- 2 Select 'Basic' > 'Lock Disc' then 'On' or 'Off'.

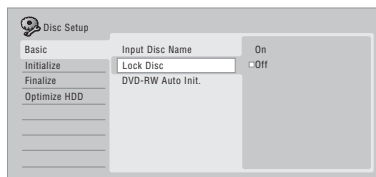

Set to **On** to prevent accidental recording, editing or erasing of the disc loaded. If you need to unlock the disc to make edits, select **Off**.

DVD-RW Auto Initialize

DVD-RW

- Default setting: **VR Mode**

Initialization mode is automatically carried out when you insert a blank DVD-RW. You must set the desired initialization mode before inserting a disc.

See *DVD-RW Auto Initialize* on page 50 for detailed instructions.

The Disc Setup menu

Initialize settings

DVD-R DVD-RW DVD+RW DVD-RAM

You can initialize a recordable DVD-R/-RW disc for either VR mode or Video mode recording.

The first time you load a new DVD-RW disc, it will be automatically initialized for recording according to the DVD-RW Auto Init. setting in the Disc Setup menu (see page 50).

New DVD-R discs are ready for Video mode recording when you load them, but it is also possible to initialize them for VR mode recording.¹

DVD+RW and DVD-RAM discs can also be initialized as a way of erasing the entire disc. When initializing a DVD-RAM disc, select VR mode.

See *Initializing recordable DVD discs* on page 49 for detailed instructions.

Finalize settings

Finalize

DVD-R DVD-RW DVD+R DVD+RW

Finalizing 'fixes' the recordings in place so that the disc can be played on a regular DVD player or computer equipped with a suitable DVD-ROM drive.

It is also possible to finalize DVD+RW discs. This is only necessary if you want to a player to display a title menu for the disc.

See *Playing your recordings on other DVD players* on page 48 for detailed instructions.

Undo Finalize

DVD-RW

You can undo the finalization on DVD-RW discs recorded on this recorder in Video mode. You need to do this if you want to record more material or edit material already on the disc.

You can also undo the finalization of VR mode discs which have been finalized on other DVD recorders. If when you load a disc the message **This disc cannot be recorded. Undo the finalization.** is displayed, use this command to be able to record on the disc using this recorder.

1  Select 'Disc Setup' from the Home Menu.

2  Select 'Finalize' > 'Undo Finalize' then 'Start'.

Optimize HDD

HDD

As you record, erase and edit recordings, the HDD file system gradually becomes fragmented. Periodically, the HDD will need optimizing to 'clean up' all the fragmented files.

When the HDD needs optimizing the recorder will automatically display a message recommending optimization.

Important

- Optimizing the HDD can take as long as eight hours. During optimization, playback and recording are not possible.
- Cancelling optimization mid-way does not undo the optimization already done, so the HDD will be partly optimized.

Note

¹ Once initialized for VR mode recording it is not possible to re-initialize the disc for Video mode recording. Also, once recorded in Video mode, the disc cannot be re-initialized for VR mode recording.

- 1  Select 'Disc Setup' from the Home Menu.

- 2  Select 'Optimize HDD' then 'Start'.

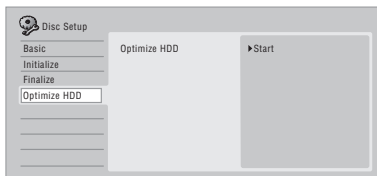

A progress bar indicates how long there is left to go. If no actions are carried out for more than 20 minutes after the optimization process is completed, the unit turns itself off.

Initialize HDD

HDD

When your HDD/DVD recorder is working without a problem this option is not visible in the Disc Setup menu. However, if the HDD file system becomes corrupted for some reason, you can initialize the HDD to fix the problem. Note that initializing the HDD will erase all the data on it.

- 1  Select 'Disc Setup' from the Home Menu.

- 2  Select 'Initialize HDD' then 'Start'.



Chapter 13

The Video Adjust menu

Using the Video Adjust menu you can set up the picture quality for the built-in tuner and external inputs, for disc playback, and for recording.

Setting the picture quality for TV and external inputs

Picture Creation lets you choose a set of picture quality settings for the built-in TV tuner and for each external input. There are several preset settings that suit various sources, or you can create up to three of your own sets.

Choosing a preset

1  With the recorder stopped, press to display the Home Menu.

2  Select 'Video Adjust'.

3  Select a preset.

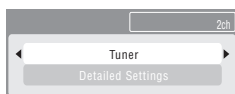

- Use the **INPUT SELECT** button to switch between the built-in TV tuner and the external inputs.
- Use the **PREV/▶▶ NEXT** buttons to change the channel of the built-in TV tuner.

There are six presets available:

- **Tuner** – suitable for general TV broadcasts
- **VCR** – suitable for video cassettes
- **DTV/LDP** – suitable for digital broadcasts and Laserdiscs
- **Memory1** – user preset 1

- **Memory2** – user preset 2
- **Memory3** – user preset 3

You can press **DISPLAY** to see the individual settings for the current preset (**Tuner**, **VCR** or **DTV/LDP**).

Creating your own set

There are three user presets in which you can save your own set of picture quality settings.

1 Follow *Choosing a preset above* and select one of the user presets (**Memory 1, 2 or 3**).

2  Select 'Detailed Settings'.

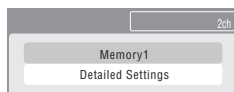

3  Select the setting you want to adjust.

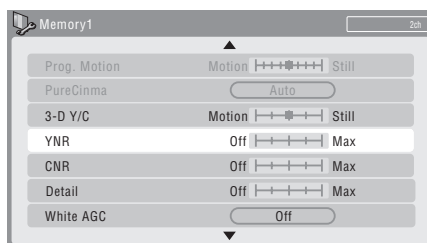

You can adjust the following settings:

- **Prog. Motion** – Adjusts the motion and still picture quality when video output is set to progressive.
- **PureCinema** – This setting optimizes the picture for film material when the video output is set to progressive. Usually set to **Auto**, but try switching to **Off** if the picture appears unnatural.

- **3-D Y/C** – Adjusts the brightness/colour separation.
- **YNR** – Adjusts the amount of noise reduction (NR) applied to the Y (brightness) component.
- **CNR** – Adjusts the amount of noise reduction (NR) applied to the C (colour) component.
- **Detail** – Adjusts how sharp edges appear.
- **White AGC** – Turn on for automatic white level adjustment.
- **White Level** – Adjusts the intensity of white.
- **Black Level** – Adjusts the intensity of black.
- **Black Setup** – Corrects the standard reference black level.
- **Hue** – Adjusts overall balance between red and green.
- **Chroma Level** – Adjusts how rich the colours appear.



- 4 **Adjust the currently selected setting.**



- 5 **Press to exit.**

You can now use the preset for any other input or the built-in TV tuner.



Tip

- To see more of the picture as you adjust different settings, press **ENTER** after selecting the setting you want to adjust.

Setting the picture quality for disc playback

This setting determines how the picture will look when playing discs.

Choosing a preset

- 1 **With a disc playing (or paused), press to display the Home Menu.**



- 2 **Select 'Video Adjust'.**



- 3 **Select a setting.**

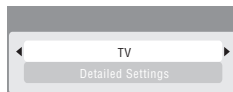

There are six presets available:

- **TV** – suitable for LCD and cathode-ray tube TVs
- **PDP** – suitable for plasma display screens
- **Professional** – suitable for professional monitors
- **Memory1** – user preset 1
- **Memory2** – user preset 2
- **Memory3** – user preset 3

You can press **DISPLAY** to see the individual settings for the current preset (**TV**, **PDP** or **Professional**).

Creating your own set

There are three user presets in which you can save your own set of picture quality settings for disc playback.

- 1 **Follow *Choosing a preset* above and select one of the user presets (Memory 1, 2 or 3).**

The Video Adjust menu

- 2 Move the cursor down and select 'Detailed Settings'.

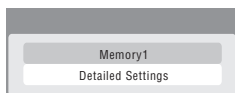

- 3 Select the picture quality setting you want to adjust.

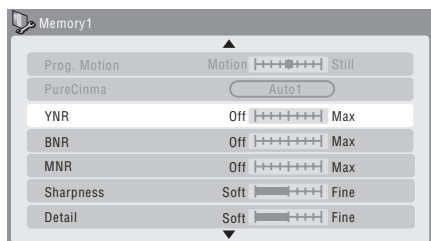

You can adjust the following settings:

- **Prog. Motion** – Adjusts the motion and still picture quality when video output is set to progressive. (Prog. Motion is ineffective when PureCinema is On.)
- **PureCinema** – This setting optimizes the picture for film material when the video output is set to progressive. Usually set to **Auto 1** but try switching to **Auto 2**, **On** or **Off** if the picture appears unnatural.
- **YNR** – Adjusts the amount of noise reduction (NR) applied to the Y (brightness) component.
- **BNR** – Adjusts the amount of noise reduction (NR) applied to the block noise (artefacts visible in areas of flat colour, caused by MPEG compression).
- **MNR** – Adjusts the amount of noise reduction (NR) applied to the mosquito noise (artefacts visible around the edges of an image, caused by MPEG compression).
- **Sharpness** – Adjusts the sharpness of the high-frequency (detailed) elements in the picture. Sharpness is ineffective for HDMI output.
- **Detail** – Adjusts how sharp edges appear.
- **White Level** – Adjusts the intensity of white. White Level is ineffective for HDMI output.
- **Black Level** – Adjusts the intensity of black. Black Level is ineffective for HDMI output.
- **Black Setup** – Corrects the standard reference black level. Black Setup is ineffective for HDMI output.
- **Gamma Correction** – Adjusts the brightness of darker images. Gamma Correction is ineffective for HDMI output.
- **Hue** – Adjusts overall balance between red and green. Hue is ineffective for HDMI output.
- **Chroma Level** – Adjusts how rich the colours appear. Chroma Level is ineffective for HDMI output.

- 4 Use the **←/→** buttons to adjust the currently selected picture quality setting.

- 5 When you have all the settings as you want them, press **HOME MENU** to exit.



Tip

- To see more of the picture as you adjust different settings, press **ENTER** after selecting the setting you want to adjust.

Chapter 14

The Initial Setup menu

Using the Initial Setup menu

The Initial Setup menu is where you can set various recorder options for sound, picture, language and so on.

Some settings can only be changed when the recorder is stopped. During playback and recording these settings are grayed out in the Initial Setup menu.

Except for the Setup Navigator, menu screens are exited automatically after 20 minutes of inactivity.

- **Press HOME MENU and select 'Initial Setup'.**

In the table below, the default option is marked with a •.

Setting	Options	Explanation
Basic		
Clock Setting	Auto	Set the channel that broadcasts a clock signal and the clock will be set automatically.
	Manual •	If there is no channel that broadcasts a clock signal in your area, you can set the time and date manually.
<i>The clock must be set in order to use timer recording.</i>		
HELP Setting	On •	Switches on the automatic Help screens for GUI displays.
	Off	Switches off the automatic Help screens for GUI displays. (Press HELP on the remote to manually display the Help screen.)
Setup Navigator	Start	Select to start the Setup Navigator. See also <i>Switching on and setting up</i> on page 30.
Tuner		
Auto Channel Setting	Antenna •	Select if you receive channels from an antenna. It takes a few moments for the auto tuning to complete.
	Cable	Select if you receive channels via cable. It takes a few moments for the auto tuning to complete.
Manual CH Setting	Next Screen	<p>Proceed to the next screen if you need to adjust any of the settings made by auto tuning.</p> <ul style="list-style-type: none"> • Change channels using the ◀◀ PREV/▶▶ NEXT buttons. • To skip the displayed channel (because there is no station assigned to that channel), change the Skip setting to On. • To manually fine tune the channel, change the AFT setting to Off then adjust the Level setting.

Setting	Options	Explanation
VCR Plus+ CH Setting	Next Screen	<p>Guide channels are used by the VCR Plus+ system so that the channel number specified in the VCR Plus+ programming numbers can be guaranteed to correspond to the correct station. Look in your TV guide to see which channel numbers should be assigned to which guide channels.</p> <ul style="list-style-type: none"> • Use the ↑/↓ buttons to change the guide channel for setting. • Use the ←/→ buttons to change the channel number. • Use the PREV ◀◀/ NEXT ▶▶ button to display the previous/next 10 guide channels. • To return to the Initial Setup menu, press ENTER.

Video Out		
Component Video Out	Interlace •	Select if your monitor/TV is not compatible with progressive-scan video.
	Progressive	Select if your monitor/TV is progressive-scan compatible. Check the operating instructions that came with your monitor/TV if you're not sure.

- If your TV is incompatible with progressive scan video and you select **Progressive**, you will not be able to see any picture at all. In this case, press **▲ OPEN/CLOSE** while holding down the **■ (Stop)** button on the front panel to switch to **Interlace** (this also switches Screen Resolution on page 110 to the default setting).
- When the HDMI signal is output, no video is output from the **COMPONENT VIDEO OUT**.

Audio In		
External Audio	Stereo •	Select if the audio from the currently selected external input is standard stereo.
	Dual Mono	Select if each channel carries a separate soundtrack.

When the external audio is from the DV input, an audio subcode channel within the DV audio tells the recorder whether the audio is stereo or dual mono. This has priority over the setting you make here.

Dual Mono Recording	L •	Select to record the left channel of an external dual mono source when recording to DVD in Video mode, to HDD with HDD Recording Format set to Video Mode On, or in LPCM mode.
	R	As above, but for right channel recording.

When recording dual mono audio to DVD in VR mode (except in **LPCM** mode), or to HDD with HDD Recording Format set to Video Mode Off (except in **LPCM** mode), both audio channels are recorded and you can switch to the one you want on playback.

Setting	Options	Explanation
DV Input (DVR-650H-K/ DVR-550H-K only)	Stereo 1 •	Select to use the 'live' audio track (recorded during the video shoot) from a camcorder that supports two stereo audio tracks.
	Stereo 2	Select to use the overdubbed audio track from a camcorder that supports two stereo audio tracks.
	Mix	Select one of the three settings to use a mix of the two stereo audio tracks.
Audio Out		
Dolby Digital Out	Dolby Digital •	Output a Dolby Digital signal when a Dolby Digital source is being played.
	Dolby Digital → PCM	Convert Dolby Digital sources to Linear PCM output. Use if your connected equipment doesn't have a Dolby Digital decoder.
DTS Out	On •	Output a DTS signal when a DTS source is being played.
	Off	Switch off the digital output when a DTS source is being played. Use when your connected equipment doesn't have a DTS decoder. In this case, use the analog audio outputs.
96 kHz PCM Out	96 kHz → 48 kHz •	Convert 96 kHz digital audio sources to 48 kHz output. Use if your connected equipment doesn't support 96 kHz sampling rate.
	96 kHz	Output 96 kHz digital audio when a 96 kHz source is being played.
MPEG Out	MPEG	Output an MPEG audio signal when a source using MPEG audio is being played.
	MPEG → PCM •	Convert sources with MPEG audio to Linear PCM output. Use if your connected equipment doesn't have an MPEG audio decoder.
Audio DRC	On	Switches on Audio DRC (Dynamic Range Control). Use when listening to Dolby Digital material at low volume.
	Off •	Switches off Audio DRC.
<i>Audio DRC is not effective when listening via the digital output when the Dolby Digital Out setting is set to Dolby Digital.</i>		
Language		
OSD Language	English •	Sets the language of the on-screen displays to English.
	Français	Sets the language of the on-screen displays to French.

Setting	Options	Explanation
Audio Language	English •	Sets the default audio language for DVD-Video playback to English.
	French	Sets the default audio language for DVD-Video playback to French.
	Other	Select to set the default audio language to something other than the ones listed. See <i>Selecting other languages for language options</i> on page 113.

Discs do not necessarily have audio in your selected language. Also, some discs override the Audio Language preference.

Subtitle Language	English •	Sets the default subtitle language for DVD-Video playback to English.
	French	Sets the default subtitle language for DVD-Video playback to French.
	Other	Select to set the default subtitle language to something other than the ones listed. See <i>Selecting other languages for language options</i> on page 113.

Discs do not necessarily have subtitles in your selected menu language. Also, some discs override the Subtitle Language preference.

Auto Language	On •	On this setting: <ul style="list-style-type: none"> • DVD-Video discs whose main audio track is in your default language will play using that language, without subtitles. • Discs whose main audio track is not in your default language but that have a subtitle track in your default language will play the original audio track with subtitles.
	Off	Select to play DVD-Video discs according to your audio and subtitle language preferences.

For Auto Language to be effective, the Audio Language and Subtitle Language options must be set to the same language.

DVD Menu Language	w/Subtitle Language •	Sets the language of DVD-Video menus to the same as that set for the subtitle language.
	English	Sets the language of DVD-Video menus to English.
	French	Sets the language of DVD-Video menus to French.
	Other	Select to set the DVD menu language to something other than the ones listed. See <i>Selecting other languages for language options</i> on page 113.

Discs do not necessarily have menus in your selected menu language.

Setting	Options	Explanation
Subtitle Display	On •	Select to have discs display subtitles according to your Subtitle Language and Auto Language preferences.
	Off	Select to switch off subtitle display.
	Assist Subtitle	Select to display special additional assistive subtitles, where available.

Some discs may override these settings.

Recording

Manual Recording	On (go to setup)	All the standard recording modes, plus MN1 to MN32 , LPCM and XP+ modes can be set.
	Off •	Just the standard recording modes (XP , SP , LP , EP , SLP and SEP) can be set.

See also Manual recording modes on page 115 for detailed information on manual recording levels.

Optimized Rec	On	The recording quality of timer recordings is automatically adjusted to fit on to the selected media if it will not fit at the selected quality setting. If the recording will not fit even at MN1 (MN4 for DVD+R/+RW), then the recording will be made to the HDD in the original quality selected.
	Off •	When a timer recording is set that won't fit on to the selected media, the recording starts but is cut off when no more recording is possible.

Optimized Rec will only compensate for the next scheduled timer recording if more than one is set.

Set Thumbnail	0 seconds •	Sets the default thumbnail picture in the Disc Navigator to the first frame of the title.
	30 seconds	Sets the default thumbnail picture to 30 seconds into the title.
	3 minutes	Sets the default thumbnail picture to three minutes into the title.
Auto Chapter (HDD/VR)	On •	When recording to the HDD or in VR mode to a DVD, chapter marks are added at the black screen between commercials and main programming. When recording in DV, chapter marks can be changed by date/time.
	Off	Automatic chapter marking is switched off.

Setting	Options	Explanation
Auto Chapter (Video)	No Separation	Automatic chapter marking is switched off.
	10 minutes •	When recording in Video mode, chapter markers are inserted every 10 minutes.
	15 minutes	Chapter markers are inserted every 15 minutes.

This settings applies to recording or real-time copying to Video mode DVD-R/-RW discs.

Auto Chapter (DVD+R/+RW)	No Separation	Automatic chapter marking is switched off.
	10 minutes •	When recording in DVD+R/+RW or in real-time copying, chapter markers are inserted every 10 minutes.
	15 minutes	Chapter markers are inserted every 15 minutes.

HDD Recording Format	Video Mode Off	Recordings made to the HDD are made in VR mode. Use this setting if you don't need to transfer the recording later to a DVD-R/-RW (Video mode) or DVD+R/+RW.
	Video Mode On •	Recordings made to the HDD are compatible with Video mode recordings. This setting is convenient if you want to transfer the recording to a DVD-R/-RW (Video mode) or DVD+R/+RW as high-speed copy can be used.

When Video Mode On is used, you must select the audio channel you want to record when recording a broadcast with a SAP channel. On the Video Mode Off setting, both channels will be recorded and you can switch between them on playback. See also Dual Mono Recording on page 105.

*When the recording mode is set to **XP+**, you cannot change HDD Recording Format.*

Playback		
TV Screen Size	4:3 (Letter Box)	Select if you have a standard 4:3 TV and prefer the letter box format presentation for widescreen material.
	4:3 (Pan & Scan)	Select if you have a standard 4:3 TV and prefer the pan and scan presentation for widescreen material.
	16:9 •	Select if you have a widescreen 16:9 TV. Your TV settings determine how 4:3 material will look.

*Selecting **4:3 (Letter Box)** or **4:3 (Pan & Scan)** does not guarantee that all video material will be presented in that format as some discs override this setting.*

Still Picture	Field	Produces a stable, generally shake-free image.
	Frame	Produces sharp image, but may be prone to shake.
	Auto •	Generates a generally less sharp but more stable still image.

Setting	Options	Explanation
Seamless Playback	On	Playback is smooth, but with a trade-off against the accuracy of the edit points.
	Off •	You may notice momentary interruption at edited points during playback of a VR mode Play List.

This setting applies to HDD, DVD-R/-RW (VR) and DVD-RAM playback.

Parental Lock	Set Password	In order to change the parental lock level or change the country/area code, set the password using this option. From the following screen, enter a four-digit number that will be your password.
	Change Password	In order to change the password, first enter your existing password and then a new one from the following screen.
	Change Level	From the following screen, first enter your password and then set a parental lock level.
	Country/Area Code	From the following screen, first enter your password and then set a country/area code. See <i>Country/Area code list</i> on page 124.

*Only certain discs have parental lock and country/area code features. Check the disc packaging to see what features the disc has. If you forget your password you can reset it by resetting the recorder to its factory settings. See *Resetting the recorder on page 127*.*

Angle Indicator	On •	A camera icon appears on-screen during multi-angle scenes on a DVD-Video disc.
	Off	Nothing is indicated on-screen when a multi-angle scene is showing.

HDMI Output (only available when an HDMI device is connected)

Screen Resolution	1920 x 1080p	Constant 1920 x 1080p output.
	1920 x 1080i	Constant 1920 x 1080i output.
	1280 x 720p	Constant 1280 x 720p output.
	720 x 480p	Constant 720 x 480p output.
	720 x 480i	Constant 720 x 480i output.

• If you choose a setting that is incompatible with your TV you may not be able to see any picture at all. In this case, press **▲ OPEN/CLOSE** while holding down the **■ (Stop)** button on the front panel to switch the setting (this also switches Component Video Out on page 105 to the default setting).

• If you have the **Colour** set to **YCbCr 4:2:2**, you cannot select **720 x 480i**.

4:3 Video Output	Full	Select if your HDMI TV allows you to change the aspect ratio.
	Normal	Select if your HDMI TV does not allow you to change the aspect ratio. 4:3 video will be shown with bars on each side.

Setting	Options	Explanation
Colour	RGB (0–255)	Use if colours are weak and black appears to ‘float’ on the RGB (16–235) setting.
	RGB (16–235)	Use this setting if colours appear overly rich and the black too deep on the RGB (0–255) setting.
	YCbCr 4:2:2	The video signal is output as a 10-bit YCbCr 4:2:2 component signal. This is the standard setting for HDMI-compatible devices.
	YCbCr 4:4:4	The video signal is output as a 8-bit YCbCr 4:4:4 component signal.
<ul style="list-style-type: none"> • Depending on the connected device some settings may not be available. • When a DVI device is connected, the YCbCr 4:2:2 and YCbCr 4:4:4 options are not available. • You cannot choose YCbCr 4:2:2 when the Screen Resolution is set to 720 x 480i. 		
Audio Output	Auto •	Dolby Digital, MPEG and DTS sources are output as a bitstream signal. However, depending on the Audio Out setting, number of audio channels, and the HDMI-connected device, Linear PCM audio may be output.
	PCM	All audio signals are converted to Linear PCM (except DTS).
	Bitstream Priority	Select if the connected device is compatible with bitstream audio.
<p><i>This setting is not available when a DVI device is connected.</i></p>		
Options		
On Screen Display	On •	The recorder displays operation displays (Stop , Play , etc.) on-screen.
	Off	Switches off the on-screen operation displays.
Front Panel Display	On •	The time is shown in the front panel display when the recorder is in standby.
	Off	The front panel display is switched off in standby.
Remote Control Mode	Recorder 1–3 (default: Recorder 1)	If you are using more than one recorder in the same room, set them to different IDs. This setting sets the recorder ID; to change the remote controller ID, press and hold RETURN then press 1 , 2 or 3 to set. The remote will only control a recorder with the same ID.
DivX VOD	Registration Code	Use to display the recorder’s DivX registration code. See <i>DivX video compatibility</i> on page 11 and <i>DivX® VOD content</i> on page 12.

Setting	Options	Explanation
Set Preview (HDD only)	Quick Preview •	When in the Disc Navigator, the thumbnail video plays short excerpts from throughout the selected title. (Note that edited titles that will play normally from the beginning.)
	Normal	The thumbnail video plays from the beginning of the title.
Options 2		
USB (DVR-650H-K/ DVR-550H-K only)	Restart USB Device	If the connected USB device does not respond to the recorder, try using this option to restart it. If the device still does not work properly try switching it off then back on, and/or disconnecting then reconnecting the USB cable.
	Confirm Printer	Use this option to confirm the make and model of the printer connected to the recorder (does not work with all printers).
HDD Sleep	Proceed	<p>Puts the HDD to sleep. Using this feature when playing DVDs or CDs allows you to reduce noise produced by the unit, resulting in improved sound quality. When you wake the HDD back up it will take a few seconds to load.</p> <p>The HDD can be taken out of Sleep Mode by any number of actions, including:</p> <ul style="list-style-type: none"> • Turning the power off and on again. • Pressing the HDD/DVD button and choosing the HDD. • When a timer recording begins. • When you try and make any changes to system settings.

Selecting other languages for language options



1 Select 'Other' from the language list.

This option appears in the settings for DVD Menu Language, Audio Language, and Subtitle Language.



2 Select the language you want.



- Select by language name: Use the ←/→ buttons to change the language.
- Select by code number: Press ↓ then use the number buttons to enter the four-digit language code.

See *Language code list* on page 124 for a list of available languages and corresponding codes.

Chapter 15

Additional information

Minimum copying times

The table below shows the minimum HDD to DVD copying time for one hour of video.

Please note that not all discs are compatible with high-speed copying.¹ Check with the disc manufacturer for compatibility.

DVD disc type		Rec mode					
		SEP	SLP	EP	LP	SP	XP
		10 h	8 h	6 h	4 h	2 h	1 h
DVD-R / 1x DVD-RW / 1x	1x	6 mins.	7.5 mins.	10 mins.	15 mins.	30 mins.	60 mins.
DVD-RW / 2x DVD-R DL DVD-RAM / 2x	2x	3 mins.	4 mins.	5 mins.	7.5 mins.	15 mins.	30 mins.
DVD+R / 2.4x DVD+RW / 2.4x DVD+R DL	2.4x	*1	*1	*1	6.3 mins.	12.5 mins.	25 mins.
DVD-RAM / 3x DVD-RAM / 5x	3x	2 mins.	2.5 mins.	3.5 mins.	5 mins.	10 mins.	20 mins.
DVD-R / 4x DVD-RW / 4x DVD+R / 4x DVD+RW / 4x	4x	1.5 mins.*1	2 mins.*1	2.5 mins.*1	4 mins.	7.5 mins.	15 mins.
DVD-R / 8x / 16x DVD+R / 8x / 16x DVD-RW / 6x DVD+RW / 8x	6x	1.25 mins.*1	1.6 mins.*1	2.2 mins.*1	3 mins.	5.5 mins.	11 mins.

Note that all times in the above table are approximate. Also that actual copy speed varies with the part of the disc being recorded.

*1 Titles recorded on DVD+R/+RW in **SEP**, **SLP** or **EP** modes cannot be high-speed copied.

 Note

¹ Depending on the disc, the copy speed may be reduced (for example, although a 6x disc is used, the copy may be made at 2x speed).

Manual recording modes

The table below shows the approximate recording times for different DVD types in each manual recording mode, as well as the standard recording mode equivalents. For recording time on the HDD, see *Specifications* on page 128.

Level	Rec. time		Resolution	
	Single-Layer DVD: DVD-R/-RW DVD+R/+RW DVD-RAM	Dual-Layer DVD: DVD-R DL DVD+R DL	Video mode Off (HDD) VR mode (DVD-R/-RW) DVD-RAM VR mode (DVD-R DL)	Video mode On (HDD) Video mode (DVD-R/-RW) DVD+R/+RW Video mode (DVD-R DL) DVD+R DL
MN 1 *1,2	802 mins.	1440 mins.		
MN 2 *1,2	720 mins.	1292 mins.		
MN 3 *1,2 SEP	600 mins.	1077 mins.	352 x 240	352 x 240
MN 4 *2 SLP	480 mins.	861 mins.		
MN 5 *2	420 mins.	754 mins.		
MN 6 *2 EP	360 mins.	646 mins.		
MN 7	300 mins.	538 mins.	352 x 480	352 x 480
MN 8	270 mins.	484 mins.		
MN 9 LP	240 mins.	431 mins.		
MN 10	230 mins.	413 mins.	480 x 480	
MN 11	220 mins.	395 mins.		
MN 12	210 mins.	377 mins.		
MN 13	200 mins.	359 mins.	544 x 480	
MN 14	190 mins.	341 mins.		
MN 15	180 mins.	323 mins.		
MN 16	170 mins.	305 mins.		
MN 17	160 mins.	287 mins.		
MN 18	150 mins.	269 mins.		
MN 19	140 mins.	251 mins.		
MN 20	130 mins.	233 mins.		720 x 480
MN 21 SP	120 mins.	215 mins.		
MN 22	110 mins.	197 mins.		
MN 23	105 mins.	188 mins.		
MN 24	100 mins.	179 mins.		
MN 25	95 mins.	170 mins.	720 x 480	
MN 26	90 mins.	161 mins.		
MN 27	85 mins.	153 mins.		
MN 28	80 mins.	144 mins.		
MN 29	75 mins.	135 mins.		
MN 30	70 mins.	126 mins.		
MN 31	65 mins.	117 mins.		
MN 32 XP	61 mins.	111 mins.		
LPCM	61 mins.	111 mins.		
XP+ *3	--- mins.	--- mins.		

*1 Modes **MN1** to **MN3** not available when using DVD+R/+RW.

*2 Titles recorded at **MN6** or lower cannot be high-speed copied to DVD+R/+RW.

*3 **XP+** mode is available for HDD recordings only. If set for a DVD recording, the DVD will be automatically recorded in **MN32** mode.

- Levels separated by a bold line show where there is a noticeable change in picture quality.
- Audio recording in all manual recording modes is in Dolby Digital 2 ch format, except for **LPCM** mode, which is in Linear PCM format.
- See also Recording on page 33.

Troubleshooting

Incorrect operation is often mistaken for trouble and malfunction. If you think there is something wrong with this component, please check the points below. Sometimes the trouble may lie in another component. Investigate the other components and electrical appliances being used. If the trouble cannot be rectified even after checking the points below, ask your nearest Pioneer authorized service center or your dealer to carry out repair work.

General

Problem	Remedy
The disc is automatically ejected after closing the disc tray	<ul style="list-style-type: none"> • Check that the disc is not an incompatible format disc (page 8). • Check that the disc is loaded properly (aligned in disc tray and label-side up). • Take out the disc and clean it (page 126). • Check that the disc has a region code compatible with the recorder.
Can't eject a disc	<ul style="list-style-type: none"> • Turn off the power to this device and press and hold ▲ OPEN/CLOSE on the front of the unit for more than three seconds.
Can't play a disc	<ul style="list-style-type: none"> • Check that the disc is a compatible format disc (page 8). • Take out the disc and clean it (page 126). • Check that the disc is loaded properly (aligned in disc tray and label-side up). • Press HDD/DVD to select the DVD. • There may be condensation in the recorder. Leave the recorder for an hour or so for the condensation to evaporate. • DVD+R/+RW discs recorded using another recorder with copy-protected recordings will not play in this recorder.
Can't record a disc	<ul style="list-style-type: none"> • Check that the disc is not an incompatible format disc (page 8). • Some DVD-RAM discs are not recordable until they have been initialized (page 49). This can take up to an hour.
No picture	<ul style="list-style-type: none"> • Check that everything is connected properly (page 15). • Check that the connected TV and/or the AV amp/receiver is set to the correct input. • Make sure the disc format is NTSC. • The recorder may be set to progressive scan with an incompatible TV. Reset to interlace by pressing and holding the front panel ■ (Stop) button then pressing ▲ OPEN/CLOSE. • When the HDMI signal is output, no video is output from the COMPONENT VIDEO OUT.

Problem	Remedy
All settings are reset	<ul style="list-style-type: none"> • If the recorder is unplugged (or there is a power failure) while the recorder is on, all the settings will be lost. • Make sure that you switch the recorder into standby before unplugging the power cord.
Remote control does not work	<ul style="list-style-type: none"> • If you connected this recorder to another Pioneer product using the CONTROL IN jack, point the remote control at the other component to use (page 15). • Set the remote control to the same ID number as the recorder (page 111). (When the batteries run down, the remote mode is automatically reset to Recorder1.) • Use the remote within its operating range (page 7). • Replace the batteries (page 7).
No sound or sound is distorted	<ul style="list-style-type: none"> • Make sure that the amp/receiver or TV is set to the correct input and the volume turned up. • There is no sound when the picture is paused, or during scanning or slow motion play. Press ► PLAY to resume regular playback. • DTS discs can only be played if this recorder is connected to a DTS decoder or DTS compatible amp/receiver. If you have connected a suitable decoder, also make sure that the Initial Setup > Audio Out > DTS Out setting is On. • Some 96 kHz discs do not output audio through the digital jack. In this case, switch the input of your amp/receiver to analog. • Check the audio cable connections (page 15). • If the sound is distorted, try cleaning the cable plugs.
Cannot switch a dual mono programme	<ul style="list-style-type: none"> • During real-time copying it is not possible to switch audio channels. The main and sub channels are both output.
The picture from the external input is distorted	<ul style="list-style-type: none"> • If the video signal from the external component is copy-protected, you cannot connect via this recorder. Connect the component directly to your TV.
Screen is stretched vertically or horizontally	<ul style="list-style-type: none"> • Make sure that the TV Screen Size setting (page 109) is correct for the kind of TV you have (see also page 125). • If you have a widescreen TV, check its aspect ratio settings. • This recorder's input switches into wide mode automatically according to the input signal. When the unit connected is not compatible with VIDEO ID-1 (widescreen signalling), set the connected component to output 4:3 aspect ratio (standard) video.

Problem	Remedy
Can't play a disc recorded using this recorder on another player	<ul style="list-style-type: none"> • If the disc was recorded in DVD-R/-RW (Video mode) or DVD+R, make sure that it's finalized (page 48). • Some players will not play recordable DVD discs, even when recorded in DVD-R/-RW (Video mode) or DVD+R and finalized. • If the disc was recorded in VR mode, the other player must be specifically RW compatible in order to play it (page 8). • Discs recorded with copy-once material cannot be played on non-CPRM compatible players (page 35). • DVD+RW discs containing only a small amount of recorded material may not play on other players. Finalize the disc and try again.
During playback the picture is dark or distorted	<ul style="list-style-type: none"> • When a copy-protected disc is played via a VCR, the picture will not display correctly. Connect the recorder directly to your TV.
Recorded contents are not clear or artefacts appear in areas of flat colour (due to MPEG compression; also known as <i>block noise</i>)	<ul style="list-style-type: none"> • Change the recording mode to XP/SP.
Can't record or does not record successfully	<ul style="list-style-type: none"> • Check that there is some remaining blank space on the DVD/HDD. • For a DVD-R/-RW (Video mode) or DVD+R, check that the disc isn't already finalized. • Check the limits on the number of titles and chapters on a disc: <ul style="list-style-type: none"> – HDD: 999 titles – VR mode: 99 titles, 999 chapters per disc – Video mode disc: 99 titles per disc, 99 chapters per title – DVD+R/+RW: 49 titles per disc, 99 chapters per title (max 254 chapters per disc) • Check that the source you are trying to record is not copy protected. • For a VR formatted disc, check that the disc isn't locked (page 98). • The power may have failed during recording.
Timer programme doesn't record successfully	<ul style="list-style-type: none"> • When setting the recording channel, make sure you set the recorder's built-in TV tuner, not the TV's built-in tuner. • When recording to a DVD-R/-RW (Video mode) or DVD+R/+RW, programmes that are copy-once protected cannot be recorded. Use a VR mode formatted disc for copy-once material (page 35). • Two timer programmes may have overlapped, in which case only the earlier one will record completely. • The power may have failed during recording.

Problem	Remedy
<p>After briefly unplugging or after a power failure the front panel display shows '---:--'</p>	<ul style="list-style-type: none"> • A backup battery inside the recorder keeps the clock and other settings from being reset when there is no power to the recorder. After unplugging or a power failure, the battery keeps all settings for some five years from the date it was shipped from the factory. Reset the clock and other recorder settings to use the recorder again. • To have the battery replaced, please ask your nearest Pioneer-authorized service center or your dealer to carry out repairs.
<p>Front panel display shows 'LOCKED' when a button is pressed</p>	<ul style="list-style-type: none"> • The Child Lock is on; turn off in order to use the recorder (page 45).
<p>Can't use One Touch Copy (HDD to DVD)</p>	<ul style="list-style-type: none"> • Make sure that there is a recordable DVD-R/+RW loaded with some free space for recording and fewer than 99 titles already on the disc. Also make sure that for a DVD-R/+RW (Video mode) or a DVD+R, the disc isn't finalized. • Make sure there is a recordable DVD+R/+RW loaded with some free space for recording and fewer than 49 titles already on the disc. • If you delete a title from a DVD+R/+RW disc, the number of remaining recordable titles may not decrease. • Further recording is not possible on a finalized DVD+R. Check that there isn't a disc menu on the disc you're trying to use. • If the title currently playing contains material that is copy-once protected, One Touch Copy will not work. • If the currently playing HDD content was recorded in XP+ mode, the One Touch Copy feature can't be used. • One Touch Copy can't be used for titles over eight hours long when copying to DVD+R/+RW (though you can use a DVD+R DL). • One Touch Copy can't be used for MN1 to MN6, SEP, SLP or EP titles when copying to DVD+R/+RW. • One Touch Copy doesn't work if the recorder is already recording to DVD.
<p>Can't use One Touch Copy (DVD to HDD)</p>	<ul style="list-style-type: none"> • Make sure that there is space available on the HDD and that there are fewer than 999 titles on the HDD. • One Touch Copy doesn't work if the recorder is already recording to the HDD.
<p>The device connected to the USB port is not recognized (DVR-650H-K/ DVR-550H-K only)</p>	<ul style="list-style-type: none"> • Check that the device is compatible with this recorder (page 24). • Use a USB cable less than 5 m in length. • Check that the USB cable is inserted fully. • Check that the USB device is powered on. • Try switching this recorder into standby mode and then back on. • Try using the Restart USB Device option from the Initial Setup menu (page 112). • If several USB devices (camera, USB memory, card reader, etc.) are connected at the same time, it's possible that only the first device connected to this recorder will be recognized.

HDMI

Problem	Remedy
The connected HDMI or DVI device does not display any picture (and the front panel HDMI indicator does not light)	<ul style="list-style-type: none"> • Try disconnecting then reconnecting the HDMI cable (while the power of both components is on). • Try switching the power of the HDMI/DVI device off then back on. • Try switching off the HDMI/DVI device and this recorder. Next, switch on the HDMI/DVI device and leave it for around 30 seconds, then switch on this recorder. • When you connect an HDMI-compatible device make sure of the following: <ul style="list-style-type: none"> – The connected device's video input is set correctly for this unit. – The cable you're using is fully HDMI-compliant. Using a non-standard cable may result in no picture being output. – Don't use several HDMI cables connected together. Use a single cable to connect devices together. • When you connect a DVI-compatible device make sure of the following: <ul style="list-style-type: none"> – The connected device's video input is set correctly for this unit. – The DVI terminal on the connected device is HDCP-compatible. – The connected device is compatible with NTSC (720 x 480i/p, 1280 x 720p, 1920 x 1080i/p) video input. • If the recorder's internal HDD is damaged or broken, there will be no HDMI output. • Not all HDCP-compatible DVI devices will work with this recorder.
No video from the HDMI output	<p>If you choose a setting that is incompatible with your TV you may not be able to see any picture at all. In this case, press ▲ OPEN/CLOSE while holding down the ■ (Stop) button on the front panel to switch the setting (this also switches <i>Component Video Out</i> on page 105 to the default setting).</p>
There's no sound from the connected HDMI or DVI device	<ul style="list-style-type: none"> • There is no sound when using a DVI terminal. • Some HDMI-compatible devices do not output sound (check with the manual that came with the connected device).

If the unit does not operate normally due to external effects such as static electricity, disconnect the power plug from the outlet and insert again to return to normal operating conditions.

If the picture freezes and the front panel and remote control buttons stop working

- Press **■ (Stop)** then try restarting playback.
- Press the front panel **⏻ STANDBY/ON** button to switch the power off, then switch back on and restart playback. If the power fails to switch off, press and hold **⏻ STANDBY/ON** for five seconds until the power switches off.

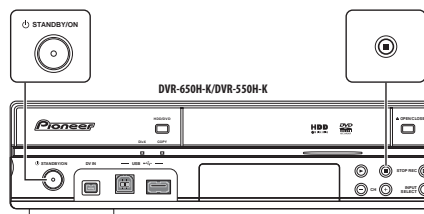

On-screen displays

The table below shows a list of error messages that you may encounter when using the recorder and an explanation of their meaning.

Message	Explanation/Action
<ul style="list-style-type: none"> • Initializing disc. Please wait a moment. 	When you load a blank DVD-RW or DVD+RW disc, the recorder automatically initializes it.
<ul style="list-style-type: none"> • Incompatible region number. 	The disc loaded has an incompatible region number for the recorder and so will not play.
<ul style="list-style-type: none"> • Cannot record any more titles. • No more space for file management data. 	The disc control data limit has been reached, or the maximum number of chapters and/or titles has been reached. Erase titles/chapters or combine chapters.
<ul style="list-style-type: none"> • This disc cannot be recorded. Undo the finalization. 	The disc was finalized on a non-Pioneer DVD recorder. Undo the finalization in order to recording/editing.
<ul style="list-style-type: none"> • Cannot play this disc. • This disc cannot be recorded. • Cannot read the CPRM information. • Could not record the information to the disc. • Cannot edit. • Could not initialize disc. • Could not complete finalization successfully. • Could not undo finalization successfully. • Could not successfully unlock the disc. 	The disc may be dirty or damaged. Take out the disc, clean it and retry. If the error persists, use a new disc. If the error appears even with a new disc, please ask your nearest Pioneer-authorized service center or your dealer to carry out repairs.
<ul style="list-style-type: none"> • Incompatible or unreadable disc. 	The disc loaded is a playback-only disc type. This display may also appear if the disc is dirty or damaged.
<ul style="list-style-type: none"> • Cannot record to a disc that is not CPRM compatible. • Cannot record this content using Video mode recording. • This video cannot be recorded to DVD+R/+RW. 	The video source is copy-once protected. Use a VR mode DVD-R/+RW disc with CPRM for recording.
<ul style="list-style-type: none"> • This content is copy protected. 	The video source is copy-protected and cannot be recorded.
<ul style="list-style-type: none"> • Incorrect CPRM information. 	The recorder could not read the CPRM information. The recorder may be damaged — please ask your nearest Pioneer-authorized service center or your dealer to carry out repairs.

Message	Explanation/Action
<ul style="list-style-type: none"> • Repairing disc. • Repairing the HDD. 	During recording, the power was cut. This display appears when the power is restored.
<ul style="list-style-type: none"> • Could not repair the disc. 	The recorder was unable to repair the disc after a power cut. The contents of the recording will be lost.
<ul style="list-style-type: none"> • Overheating has stopped operation. Press DISPLAY to clear message. 	The internal temperature of the recorder has exceeded the operating limit. If this message reappears, please ask your nearest Pioneer-authorized service center or your dealer to carry out repairs.
<ul style="list-style-type: none"> • HDD optimization is recommended. This can be done using Disc Setup. 	The HDD should be optimized (basically, HDD housekeeping) to maintain playback and recording performance.
<ul style="list-style-type: none"> • Please perform HDD optimization. This can be done using Disc Setup. 	The HDD is in more urgent need of optimization in order to maintain performance.
<ul style="list-style-type: none"> • The HDD has not been sufficiently optimized. Please optimize again. 	If this message appears repeatedly after optimizing the HDD it is likely that there is not enough free space on the HDD for optimization to complete properly. Please erase some titles from the HDD and optimize again.
<ul style="list-style-type: none"> • An error occurred. Please consult the service center. Note that contents on the HDD may be erased when servicing this unit. 	This message is displayed when information from the HDD cannot be read. The HDD may be damaged or broken. Please ask your nearest Pioneer-authorized service center or your dealer to carry out repairs.
<ul style="list-style-type: none"> • The Hard Disk Drive info is incorrect. Use the Disc Setup menu to reinitialize. 	As the HDD info cannot be properly read, no new recordings can be made. Reinitializing the HDD (page 100) may result in your being able to make recording again. Note that reinitializing the HDD will erase all recorded contents, including protected files.
<ul style="list-style-type: none"> • There is no DV input or the input signal is unrecordable. 	No signal was detected at the DV IN jack. This may appear if a blank section of DV tape is playing in the connected camcorder.
<ul style="list-style-type: none"> • No DV camcorder connected. 	The camcorder is not connected properly, or the camcorder is switched off.
<ul style="list-style-type: none"> • You cannot connect more than one DV camcorder at a time. 	This recorder's DV jack supports connection to just one camcorder.
<ul style="list-style-type: none"> • Cannot operate the DV camcorder. 	This recorder cannot operate the DV camcorder. Try switching off the camcorder then turn it back on again.

Message	Explanation/Action
<ul style="list-style-type: none"> • Could not operate the DV camcorder. 	This recorder was not able to operate the DV camcorder.
<ul style="list-style-type: none"> • The DV camcorder is not set for playback. Please select playback mode on the DV camcorder. 	The camcorder is in camera mode. Switch it to playback mode.
<ul style="list-style-type: none"> • The printer is not ready or is not connected. Please check the printer. 	This message is displayed when communication could not be established with the printer. See the <i>Troubleshooting</i> section if you do not know the cause.
<ul style="list-style-type: none"> • Printing has been cancelled because ... 	This message is displayed when there is a printer error during printing. After checking the printer for the cause of the error, either reconnect the printer and start the printing job again, or select "Yes" to resume printing (select "No" to cancel the print job). See also the operating instructions that came with your printer for possible causes of print errors.

Front-panel displays

The table below shows a list of error messages that you may encounter when using the recorder and an explanation of their meaning.

Message	Explanation/Action
<ul style="list-style-type: none"> • E01 	The HDD may be damaged or broken. Please ask your nearest Pioneer-authorized service center or your dealer to carry out repairs.
<ul style="list-style-type: none"> • E02 	As the HDD info cannot be properly read, no new recordings can be made. Reinitializing the HDD (page 100) may result in your being able to make recording again. Note that reinitializing the HDD will erase all recorded contents, including protected files.
HDCP ERR	Displayed when a device that is not HDCP-compatible is connected to the HDMI terminal. Connect a device that is HDCP-compatible.

Language code list

Language (Language code letter), **Language code**

Japanese (ja), 1001	Bhutani (dz), 0426	Kirghiz (ky), 1125	Serbo-Croatian (sh), 1908
English (en), 0514	Esperanto (eo), 0515	Latin (la), 1201	Sinhalese (si), 1909
French (fr), 0618	Estonian (et), 0520	Lingala (ln), 1214	Slovak (sk), 1911
German (de), 0405	Basque (eu), 0521	Laotian (lo), 1215	Slovenian (sl), 1912
Italian (it), 0920	Persian (fa), 0601	Lithuanian (lt), 1220	Samoan (sm), 1913
Spanish (es), 0519	Finnish (fi), 0609	Latvian (lv), 1222	Shona (sn), 1914
Chinese (zh), 2608	Fiji (fj), 0610	Malagasy (mg), 1307	Somali (so), 1915
Dutch (nl), 1412	Faroese (fo), 0615	Maori (mi), 1309	Albanian (sq), 1917
Portuguese (pt), 1620	Frisian (fy), 0625	Macedonian (mk), 1311	Serbian (sr), 1918
Swedish (sv), 1922	Irish (ga), 0701	Malayalam (ml), 1312	Siswati (ss), 1919
Russian (ru), 1821	Scots-Gaelic (gd), 0704	Mongolian (mn), 1314	Sesotho (st), 1920
Greek (el), 0512	Galician (gl), 0712	Moldavian (mo), 1315	Sundanese (su), 1921
Polish (pl), 1612	Guarani (gn), 0714	Marathi (mr), 1318	Swahili (sw), 1923
Czech (cs), 0319	Gujarati (gu), 0721	Malay (ms), 1319	Tamil (ta), 2001
Norwegian (no), 1415	Hausa (ha), 0801	Maltese (mt), 1320	Telugu (te), 2005
Afar (aa), 0101	Hindi (hi), 0809	Burmese (my), 1325	Tajik (tg), 2007
Abkhazian (ab), 0102	Croatian (hr), 0818	Nauru (na), 1401	Thai (th), 2008
Afrikaans (af), 0106	Hungarian (hu), 0821	Nepali (ne), 1405	Tigrinya (ti), 2009
Amharic (am), 0113	Armenian (hy), 0825	Occitan (oc), 1503	Turkmen (tk), 2011
Arabic (ar), 0118	Interlingua (ia), 0901	Oromo (om), 1513	Tagalog (tl), 2012
Assamese (as), 0119	Interlingue (ie), 0905	Oriya (or), 1518	Setswana (tn), 2014
Aymara (ay), 0125	Inupiak (ik), 0911	Panjabi (pa), 1601	Tonga (to), 2015
Azerbaijani (az), 0126	Indonesian (in), 0914	Pashto, Pushto (ps), 1619	Turkish (tr), 2018
Bashkir (ba), 0201	Icelandic (is), 0919	Quechua (qu), 1721	Tsonga (ts), 2019
Byelorussian (be), 0205	Hebrew (iw), 0923	Rhaeto-Romance (rm), 1813	Tatar (tt), 2020
Bulgarian (bg), 0207	Yiddish (ji), 1009	Kirundi (rn), 1814	Twi (tw), 2023
Bihari (bh), 0208	Javanese (jw), 1023	Romanian (ro), 1815	Ukrainian (uk), 2111
Bislama (bi), 0209	Georgian (ka), 1101	Kinyarwanda (rw), 1823	Urdu (ur), 2118
Bengali (bn), 0214	Kazakh (kk), 1111	Sanskrit (sa), 1901	Uzbek (uz), 2126
Tibetan (bo), 0215	Greenlandic (kl), 1112	Sindhi (sd), 1904	Vietnamese (vi), 2209
Breton (br), 0218	Cambodian (km), 1113	Sangho (sg), 1907	Volapük (vo), 2215
Catalan (ca), 0301	Kannada (kn), 1114		Wolof (wo), 2315
Corsican (co), 0315	Korean (ko), 1115		Xhosa (xh), 2408
Welsh (cy), 0325	Kashmiri (ks), 1119		Yoruba (yo), 2515
Danish (da), 0401	Kurdish (ku), 1121		Zulu (zu), 2621





Country/Area code list

Country/Area, **Country/Area code**, Code letter





Argentina, 0118 , ar	Finland, 0609 , fi	Malaysia, 1325 , my	Singapore, 1907 , sg
Australia, 0121 , au	France, 0618 , fr	Mexico, 1324 , mx	Spain, 0519 , es
Austria, 0120 , at	Germany, 0405 , de	Netherlands, 1412 , nl	Sweden, 1905 , se
Belgium, 0205 , be	Hong Kong, 0811 , hk	New Zealand, 1426 , nz	Switzerland, 0308 , ch
Brazil, 0218 , br	India, 0914 , in	Norway, 1415 , no	Taiwan, 2023 , tw
Canada, 0301 , ca	Indonesia, 0904 , id	Pakistan, 1611 , pk	Thailand, 2008 , th
Chile, 0312 , cl	Italy, 0920 , it	Philippines, 1608 , ph	United Kingdom, 0702 , gb
China, 0314 , cn	Japan, 1016 , jp	Portugal, 1620 , pt	USA, 2119 , us
Denmark, 0411 , dk	Korea, Republic of, 1118 , kr	Russian Federation, 1821 , ru	

Screen sizes and disc formats

When viewing on a standard TV or monitor

Screen format of disc	Setting	Appearance
16:9 	4:3 (Letter Box) 	The programme is shown in widescreen with black bars at the top and bottom of the screen.
	4:3 (Pan & Scan) 	The sides of the programme are cropped so that the picture fills the whole screen.
4:3 	4:3 (Letter Box) 4:3 (Pan & Scan) 	The programme is presented correctly on either setting.

When viewing on a widescreen TV or monitor

Screen format of disc	Setting	Appearance
16:9 	16:9 	The programme is presented in widescreen.
4:3 	16:9  	Your TV will determine how the picture is presented — check the manual that came with the TV for details.

Handling discs

When holding discs of any type, take care not to leave fingerprints, dirt or scratches on the disc surface. Hold the disc by its edge or by the center hole and edge.

Damaged or dirty discs can affect playback and recording performance. Take care also not to scratch the label side of the disc. Although not as fragile as the recorded side, scratches can still result in a disc becoming unusable.

Should a disc become marked with fingerprints, dust, etc., clean using a soft, dry cloth, wiping the disc lightly from the center to the outside edge. Do not wipe with a circular motion.



If necessary, use a cloth soaked in alcohol, or a commercially available CD/DVD cleaning kit to clean a disc more thoroughly. Never use benzine, thinner or other cleaning agents, including products designed for cleaning vinyl records.

Storing discs

Although CDs and DVD discs are more durable than vinyl records, you should still take care to handle and store discs correctly. When you're not using a disc, return it to its case and store upright. Avoid leaving discs in excessively cold, humid, or hot environments (including under direct sunlight).

Don't glue paper or put stickers onto the disc, or use a pencil, ball-point pen or other sharp-tipped writing instrument. These could all damage the disc.



For more detailed care information see the instructions that come with discs.

Do not load more than one disc into the recorder.

Damaged discs

Discs spin at high speed inside the recorder. If you can see that a disc is cracked, chipped, warped, or otherwise damaged, don't risk using it; you could end up damaging the recorder.

This recorder is designed for use with conventional, fully circular discs only. Use of shaped discs is not recommended for this product. Pioneer disclaims all liability arising in connection with the use of shaped discs.

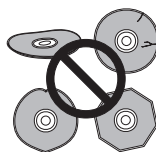

Cleaning the pickup lens

The HDD/DVD recorder's lens should not become dirty in normal use, but if for some reason it should malfunction due to dust or dirt, consult your nearest Pioneer-authorized service center. Although lens cleaners are commercially available, we do not recommend using them since some may damage the lens.

Condensation

Condensation may form inside the recorder if it is brought into a warm room from outside, or if the temperature of the room rises quickly. Although the condensation won't damage the recorder, it may temporarily impair its performance. For this reason you should leave it to adjust to the warmer temperature for about an hour before switching on and using.

Hints on installation

We want you to enjoy using this unit for years to come, so please bear in mind the following points when choosing a suitable location for it:

Do...

- ✓ Use in a well-ventilated room.
- ✓ Place on a solid, flat, level surface, such as a table, shelf or stereo rack.

Don't...

- ✗ Use in a place exposed to high temperatures or humidity, including near radiators and other heat-generating appliances.
- ✗ Place on a window sill or other place where the recorder will be exposed to direct sunlight.
- ✗ Use in a dusty or damp environment or in a room where it will be exposed to excessive cigarette smoke.
- ✗ Place directly on top of an amplifier, or other component in your stereo system that becomes hot in use.
- ✗ Use near a television or monitor as you may experience interference — especially if the television uses an indoor antenna.
- ✗ Use in a kitchen or other room where the recorder may be exposed to smoke or steam.
- ✗ Use on a thick rug or carpet, or cover with cloth — this may prevent proper cooling of the unit.
- ✗ Place on an unstable surface, or one that is not large enough to support all four of the unit's feet.

Moving the recorder

If you need to move the recorder, first remove the disc, if loaded, and close the disc tray. Next, press **⏻ STANDBY/ON** to switch the power to standby, checking that the **POWER OFF** indication in the display goes off. Wait at least two minutes. Lastly, disconnect the power cord. Never lift or move the unit during playback or recording — discs rotate at a high speed and may be damaged.

Resetting the recorder

If you need to, you can reset the recorder to all its factory settings.

- 1 Make sure that the recorder is on.**
- 2 Using the front panel controls, press and hold **■ (Stop)** and press **⏻ STANDBY/ON**.**

The recorder turns off with all settings reset.

Specifications

General

Power requirements	120 V, 60 Hz
Power consumption	
<i>DVR-650H-K</i>	.48 W
<i>DVR-550H-K</i>	.46 W
<i>DVR-450H-S</i>	.42 W
Power consumption in standby mode	0.33 W
	(Front panel display: off)
Weight	
<i>DVR-650H-K</i>	4.1 kg (9 lbs. 1 oz.)
<i>DVR-550H-K</i>	4.1 kg (9 lbs. 1 oz.)
<i>DVR-450H-S</i>	4.1 kg (9 lbs. 1 oz.)
Dimensions	
	.420 mm (W) x 75 mm (H) x 288 mm (D)
	(16 ⁹ / ₁₆ in. (W) x 3 in. (H) 11 ⁶ / ₁₆ in. (D))
Operating temperature	+5 °C to +35 °C
	(+41 °F to +95 °F)
Operating humidity	
	5 % to 85 % (no condensation)
TV system	NTSC

Readable discs

DVD-Video, DVD-RW, DVD-R, DVD+R, DVD+RW,
DVD-RAM, Video CD, Super VCD, CD, CD-R/RW
(WMA, MP3, JPEG, CD-DA, DivX)

Recording discs and formats

DVD-R/RW: VR mode and Video mode
DVD+R/+RW: +VR mode
DVD-RAM: VR mode
DVD-R DL: VR mode and Video mode
DVD+R DL: +VR mode

Video recording format

Sampling frequency 13.5 MHz
Compression format MPEG

Audio recording format

Sampling frequency 48 kHz
Compression format Dolby Digital or Linear PCM
(uncompressed)

Recording time

HDD

DVR-650H-K (250 GB)

XP+	Approx. 36 h
Fine (XP)	Approx. 53 h
Standard Play (SP)	Approx. 106 h
Long Play (LP)	Approx. 212 h
Extended Play (EP)	Approx. 319 h
Super Long Play (SLP)	Approx. 425 h
Super Extended Play (SEP)	Approx. 532 h
Manual Mode (MN)	Approx. 36 h to 711 h

DVR-550H-K/DVR-450H-S (160 GB)

XP+	Approx. 23 h
Fine (XP)	Approx. 34 h
Standard Play (SP)	Approx. 68 h
Long Play (LP)	Approx. 136 h
Extended Play (EP)	Approx. 204 h
Super Long Play (SLP)	Approx. 272 h
Super Extended Play (SEP)	Approx. 340 h
Manual Mode (MN)	Approx. 23 h to 455 h

DVD-R/-RW, DVD+R/+RW, DVD-RAM

Fine (XP)	Approx. 1 h
Standard Play (SP)	Approx. 2 h
Long Play (LP)	Approx. 4 h
Extended Play (EP)	Approx. 6 h
Super Long Play (SLP)	Approx. 8 h
Super Extended Play (SEP)	Approx. 10 h
	(<i>DVD-R/-RW, DVD-RAM only</i>)
Manual Mode (MN)	
DVD-R/-RW-RAM	Approx. 1 h to 13 h
DVD+R/+RW	Approx. 1 h to 8 h

DVD-R DL/DVD+R DL

Fine (XP)	Approx. 1 h 51 m
Standard Play (SP)	Approx. 3 h 35 m
Long Play (LP)	Approx. 7 h 11 m
Extended Play (EP)	Approx. 10 h 46 m
Super Long Play (SLP)	Approx. 14 h 21 m
Super Extended Play (SEP)	Approx. 17 h 57 m
	(<i>DVD-R DL only</i>)

Manual Mode (MN)

DVD-R DL	Approx. 1 h 51 m to 24 h
DVD+R DL	Approx. 1 h 51 m to 14 h 21 m

Timer

Programmes	1 month/32 programmes
Clock	Quartz lock
	(12-hour digital display)

Tuner

Receivable channels

VHF	2 ch to 13 ch
UHF	14 ch to 69 ch
CATV	C1 ch to C125 ch

Input/Output

VHF/UHF antenna input/output terminal

	VHF/UHF set 75 Ω (F-shape connector)
--	---

Video Input	Input 1, 3 (rear), 2 (front)
-------------	------------------------------

Input level	1 Vp-p (75 Ω)
-------------	---------------

Jacks	RCA jack
-------	----------

Video Output	Output 1, 2
--------------	-------------

Output level	1 Vp-p (75 Ω)
--------------	---------------

Jacks	RCA jack
-------	----------

S-Video Input	Input 1, 3 (rear), 2 (front)
---------------	------------------------------

Y (luminance) - Input level	1 Vp-p (75 Ω)
-----------------------------	---------------

C (colour) - Input level	265 mVp-p (75 Ω)
--------------------------	------------------

Jacks	4 pin mini DIN
-------	----------------

S-Video Output	Output 1, 2
----------------	-------------

Y (luminance) - Output level	1 Vp-p (75 Ω)
------------------------------	---------------

C (colour) - Output level	265 mVp-p (75 Ω)
---------------------------	------------------

Jacks	4 pin mini DIN
-------	----------------

Component video output

Output level	Y: 1.0 Vp-p (75 Ω)
--------------	--------------------

	P _B , P _R : 648 mVp-p (75 Ω)
--	--

Jacks	RCA jacks
-------	-----------

Audio Input	Input 1, 3 (rear), 2 (front) L/R
-------------	----------------------------------

During audio input	2 V rms
--------------------	---------

(Input impedance: more than 22 kΩ)

Jacks	RCA jacks
-------	-----------

Audio Output	Output 1, 2 L/R
--------------	-----------------

During audio output	2 V rms
---------------------	---------

(Output impedance: less than 1.5 kΩ)

Jacks	RCA jacks
-------	-----------

Control input	Mini jack
---------------	-----------

Digital audio output	Coaxial
----------------------	---------

DV input (DVR-650H-K and DVR-550H-K only)	
---	--

	4 pin (front)
--	---------------

(i.LINK/IEEE 1394 standard)

USB (DVR-650H-K and DVR-550H-K only)	
--------------------------------------	--

	Type A (front), Type B (front)
--	--------------------------------

HDMI	19 pin
------	--------

Supplied accessories

Remote control	1
Dry cell batteries (AA/R6P)	2
Audio / Video cable (red/white/yellow)	1
RF antenna cable	1
Power cable	1
Operating Instructions	

Note: The specifications and design of this product are subject to change without notice, due to improvement.

This product includes FontAvenue® fonts licenced by NEC Corporation. FontAvenue is a registered trademark of NEC Corporation.

Microsoft product screen shots reprinted with permission from Microsoft Corporation.

Should this product require service in Canada, please contact a Pioneer Canadian Authorized Dealer to locate the nearest Pioneer Authorized Service Company in Canada. Alternatively, please contact the Customer Satisfaction Department at the following address:

Pioneer Electronics of Canada, Inc.
Customer Satisfaction Department
300 Allstate Parkway, Markham, Ontario L3R 0P2
1-877-283-5901
905-479-4411

For warranty information please see the Limited Warranty sheet included with your product.

Si ce produit doit être réparé au Canada, veuillez vous adresser à un distributeur autorisé Pioneer du Canada pour obtenir le nom du Centre de Service Autorisé Pioneer le plus près de chez-vous. Vous pouvez aussi contacter le Service à la clientèle de Pioneer:

Pioneer Électroniques du Canada, Inc.
Service Clientèle
300, Allstate Parkway, Markham, Ontario L3R 0P2
1-877-283-5901
905-479-4411

Pour obtenir des renseignements sur la garantie, veuillez vous reporter au feuillet sur la garantie restreinte qui accompagne le produit.

S018_B_EF

Published by Pioneer Corporation.
Copyright © 2007 Pioneer Corporation.
All rights reserved.

PIONEER CORPORATION

4-1, Meguro 1-Chome, Meguro-ku, Tokyo 153-8654, Japan

PIONEER ELECTRONICS (USA) INC.

P.O. BOX 1540, Long Beach, California 90801-1540, U.S.A. TEL: (800) 421-1404

PIONEER ELECTRONICS OF CANADA, INC.

300 Allstate Parkway, Markham, Ontario L3R 0P2, Canada TEL: 1-877-283-5901, 905-479-4411

PIONEER EUROPE NV

Haven 1087, Keetberglaan 1, B-9120 Melsele, Belgium TEL: 03/570.05.11

PIONEER ELECTRONICS ASIACENTRE PTE. LTD.

253 Alexandra Road, #04-01, Singapore 159936 TEL: 65-6472-7555

PIONEER ELECTRONICS AUSTRALIA PTY. LTD.

178-184 Boundary Road, Braeside, Victoria 3195, Australia, TEL: (03) 9586-6300

PIONEER ELECTRONICS DE MEXICO S.A. DE C.V.

Bldv.Manuel Avila Camacho 138 10 piso Col.Lomas de Chapultepec, Mexico,D.F. 11000 TEL: 55-9178-4270 K002_B_En

Free Manuals Download Website

<http://myh66.com>

<http://usermanuals.us>

<http://www.somanuals.com>

<http://www.4manuals.cc>

<http://www.manual-lib.com>

<http://www.404manual.com>

<http://www.luxmanual.com>

<http://aubethermostatmanual.com>

Golf course search by state

<http://golfingnear.com>

Email search by domain

<http://emailbydomain.com>

Auto manuals search

<http://auto.somanuals.com>

TV manuals search

<http://tv.somanuals.com>