

Operating Instructions | 操作手冊



AUDIO MULTI-CHANNEL RECEIVER SUBWOOFER
多聲道音效接收重低音

SX-LX70W

SATELLITE SPEAKER
衛星揚聲器

SSP-LX70ST

ACCESSORY BOX
配件盒

AS-LX70

5.1 CH SURROUND SYSTEM
5.1 聲道環繞系統

HTP-LX **70**

Thank you for buying this Pioneer product.

Please read through these operating instructions so that you will know how to operate your model properly. After you have finished reading the instructions, put them in a safe place for future reference.

IMPORTANT



The lightning flash with arrowhead symbol, within an equilateral triangle, is intended to alert the user to the presence of uninsulated "dangerous voltage" within the product's enclosure that may be of sufficient magnitude to constitute a risk of electric shock to persons.

CAUTION

**RISK OF ELECTRIC SHOCK
DO NOT OPEN**

CAUTION:

TO PREVENT THE RISK OF ELECTRIC SHOCK, DO NOT REMOVE COVER (OR BACK). NO USER-SERVICEABLE PARTS INSIDE. REFER SERVICING TO QUALIFIED SERVICE PERSONNEL.



The exclamation point within an equilateral triangle is intended to alert the user to the presence of important operating and maintenance (servicing) instructions in the literature accompanying the appliance.

D3-4-2-1-1_En-A

WARNING

This equipment is not waterproof. To prevent a fire or shock hazard, do not place any container filled with liquid near this equipment (such as a vase or flower pot) or expose it to dripping, splashing, rain or moisture.

D3-4-2-1-3_B_En

WARNING

To prevent a fire hazard, do not place any naked flame sources (such as a lighted candle) on the equipment.

D3-4-2-1-7a_A_En

If the AC plug of this unit does not match the AC outlet you want to use, the plug must be removed and appropriate one fitted. Replacement and mounting of an AC plug on the power supply cord of this unit should be performed only by qualified service personnel. If connected to an AC outlet, the cut-off plug can cause severe electrical shock. Make sure it is properly disposed of after removal. The equipment should be disconnected by removing the mains plug from the wall socket when left unused for a long period of time (for example, when on vacation).

D3-4-2-2-1a_A_En

Operating Environment

Operating environment temperature and humidity: +5 °C to +35 °C (+41 °F to +95 °F); less than 85 %RH (cooling vents not blocked)

Do not install this unit in a poorly ventilated area, or in locations exposed to high humidity or direct sunlight (or strong artificial light)

D3-4-2-1-7c_A_En

POWER-CORD CAUTION

Handle the power cord by the plug. Do not pull out the plug by tugging the cord and never touch the power cord when your hands are wet as this could cause a short circuit or electric shock. Do not place the unit, a piece of furniture, etc., on the power cord, or pinch the cord. Never make a knot in the cord or tie it with other cords. The power cords should be routed such that they are not likely to be stepped on. A damaged power cord can cause a fire or give you an electrical shock. Check the power cord once in a while. When you find it damaged, ask your nearest PIONEER authorized service center or your dealer for a replacement.

5002_En

CAUTION

The  STANDBY/ON switch on this unit will not completely shut off all power from the AC outlet. Since the power cord serves as the main disconnect device for the unit, you will need to unplug it from the AC outlet to shut down all power. Therefore, make sure the unit has been installed so that the power cord can be easily unplugged from the AC outlet in case of an accident. To avoid fire hazard, the power cord should also be unplugged from the AC outlet when left unused for a long period of time (for example, when on vacation).

D3-4-2-2-2a_A_En

WARNING

Before plugging in for the first time, read the following section carefully.

The voltage of the available power supply differs according to country or region. Be sure that the power supply voltage of the area where this unit will be used meets the required voltage (e.g., 230 V or 120 V) written on the rear panel.

D3-4-2-1-4_A_En

This product is for general household purposes. Any failure due to use for other than household purposes (such as long-term use for business purposes in a restaurant or use in a car or ship) and which requires repair will be charged for even during the warranty period.

K041_En

VENTILATION CAUTION

When installing this unit, make sure to leave space around the unit for ventilation to improve heat radiation (at least 10 cm at top, 10 cm at rear, and 10 cm at each side).

WARNING

Slots and openings in the cabinet are provided for ventilation to ensure reliable operation of the product, and to protect it from overheating. To prevent fire hazard, the openings should never be blocked or covered with items (such as newspapers, table-cloths, curtains) or by operating the equipment on thick carpet or a bed.

D3-4-2-1-7b_A_En

WARNING

To prevent injury, the receiver subwoofer must be securely attached to the floor in accordance with this operating instructions.

Contents

What's in the box	5
01 Speaker Setup Guide	
Safety precautions when setting up	6
Home theater sound setup	6
Standard surround setup	6
Front surround setup	6
Preparing the speakers	6
Using the supplied speaker bases	6
When not using the supplied speaker bases	7
Connect the speaker system	7
Additional notes on speaker placement	7
02 Connecting up	
Receiver subwoofer	8
Side panel	8
Rear panel	9
Back of display unit	9
Basic connections	10
03 Controls and displays	
Display unit	13
Display	14
Remote control	15
Operating the receiver subwoofer	15
Operating the built-in FM/AM tuner	16
Operating Pioneer plasma televisions and TVs	17
Operating a Pioneer Blu-ray Disc player	18
Operating a Pioneer DVD player	19
Operating a Pioneer HDD/DVD Recorder	20
Putting the batteries in the remote control	21
Using the remote control	22
Operating the remote control	22
Using the LCD touch screen	22
04 Getting started	
Using the Auto MCACC setup for optimal surround sound	23
05 Listening to your system	
Effective Sound (for optimum sound)	24
Auto listening mode	24
Listening in surround sound	24
Dolby Pro Logic II Music settings	25
Center image setting	25
Using Advanced Surround	25
Using Front Stage Surround Advance	26
Listening in stereo	26
Genre Sync Mode	26
Using the Sound Retriever	26
Listening with MCACC Effect	27
Using Midnight, Loudness and Quiet listening modes	27
Adjusting the bass and treble	27
Adjusting sound delay	27
06 Listening to the radio	
Listening to the radio	28
Improving poor FM reception	28
Improving poor AM sound	28
Changing the noise cut mode	28
Memorizing stations	29
Listening to station presets	29
Changing the frequency step	29
07 Surround sound settings	
Using the Sound Setup menu	30
Channel level setting	30
Speaker distance setting1	30
Dynamic Range Control	31
Dual mono setting	31
Using the Virtual Surround Back mode	32
LFE Attenuate	32
Adjusting the channel levels using the test tone	32
08 Other connections	
Connecting auxiliary components	33
Connecting for digital audio	33
Connecting an analog audio component	33
Connecting an iPod	34
Listening to an external audio source	34
Connecting external antennas	35
About control out connections	35
Connecting using HDMI	35
HDMI mode setting	36
About HDMI	36

09 HDMI Control

Making the HDMI Control connections	37
Setting the HDMI options	38
Setting the HDMI Control mode	38
Setting the Auto Delay	39
Audio input settings from plasma televisions (TV Input)	39
Before using synchronization	39
Synchronzied amp mode	39
Synchronized amp mode operations	39
Canceling synchronized amp mode	39

10 Additional information

Dimming the display	40
Setting the sleep timer	40
Setting up the remote to control your TV	40
TV Preset code list	41
Resetting the system	42
Installation and maintenance	42
Hints on installation	42
Surround sound formats	42
Dolby	42
DTS	43
Troubleshooting	44
General	44
Tuner	45
HDMI	45
Displayed Messages	46
Specifications	47

What's in the box

Please confirm that the following items are all supplied.

Accessory box (AS-LX70):

- Remote control (page 15)
- AA/LR6 alkaline batteries x4 (page 21)
- Power cords x3 (page 12)
- Display unit (page 13)
- AM loop antenna (page 11)
- FM wire antenna (page 11)
- Microphone (for Auto MCACC setup) (page 23)
- HDMI cable
- Control cable (page 35)
- Display cable (page 11)
- Optical digital cable (page 12)
- iPod cable (page 34)
- This operating instructions

Receiver subwoofer (SX-LX70W) box:

- Cleaning cloth

Speakers (SSP-LX70ST) box:

- Speakers (front/center x2, surround x2) (page 6, 11)
- Speaker cables x6 (page 11)
- Speaker bases x4 (page 6)
- Non-skid pads x16 (page 6, 7)
- Screws x4 (page 7)

Chapter 1

Speaker Setup Guide

Safety precautions when setting up

When assembling the speakers, lay them down flat on their side to avoid accidents or injury. Make sure to use a stable surface when assembling, setting up, and placing the speakers.

Home theater sound setup

Depending on the size and characteristics of your room, you can place your speakers in one of two ways using this system.

Standard surround setup

This is a standard multichannel surround sound speaker setup for optimal 5.1 channel home theater sound.

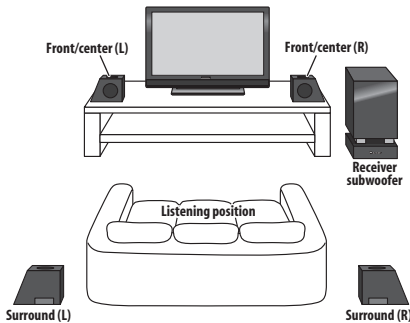

Front surround setup

This setup is ideal when rear surround speaker placement isn't possible or you want to avoid running long speaker cables in your listening area. Use this setup together with the Front Stage Surround Advance modes in page 26.

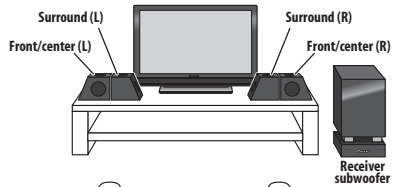

Preparing the speakers

This unit comes with speaker bases that can be used to adjust the speakers to the design of the room in which they are placed.

Using the supplied speaker bases

1 Attach the non-skid pads to the speaker bases, as shown below.

Use the adhesive side of the pads to attach them to the base of each speaker base.

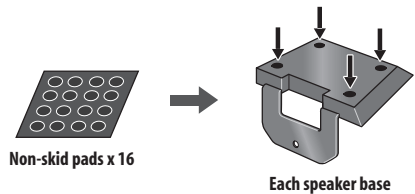

2 Attach the speaker bases.

Place the speaker atop a supplied speaker base, and fix the base in place by using one of the supplied screws.

- The supplied speaker bases come in two different shapes. You can determine the correct base for a speaker by checking if the screw's location lines up correctly when the speaker is placed atop the base. (There are specific bases for the front/center (L) and surround speaker (R), and for the front/center (R) and surround speaker (L), with two of each type included.)

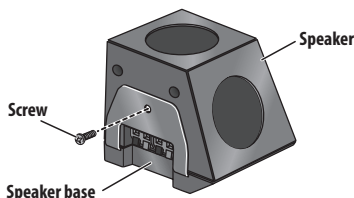

When not using the supplied speaker bases

- Attach the non-skid pads to the base of each of the front/center and surround speakers (as shown).

Use the adhesive side of the pads to attach them to the base of each speaker.

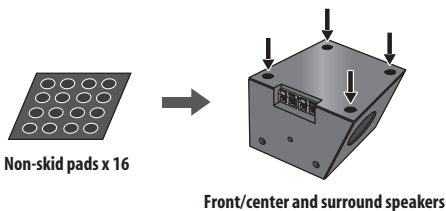

Connect the speaker system

Refer to *Connecting up* to connect the speakers properly. After connecting everything, place the speakers as shown in the diagram above for optimal surround sound. After placing the speakers, run the Auto MCACC setup (page 23) to complete your surround sound setup.

Additional notes on speaker placement

- Install the main front left and right speakers at an equal distance from the TV.
- When using the Standard surround setup, install the surround speakers slightly above ear level for optimum effect.
- When using the Front surround setup, separate the left and right speakers by about 1.5 m for optimum effect.

Precautions:

- Do not place the speaker on an unstable surface, as doing so may cause the speaker to fall and cause damage or bodily injury.
- All speakers supplied with this system are magnetically shielded. However, depending on the installation location, color distortion may occur if a speaker is installed extremely close to the screen of a television set. If this happens, turn the power switch of the television set OFF, and turn it ON after 15 min to 30 min. If the problem persists, place the speaker system away from the television set.
- For safety, make sure that there is no exposed bare speaker wire outside of the speaker terminals.
- Do not connect the supplied speakers with any other amplifier. This may result in malfunction or fire.
- Do not connect any speakers other than those supplied to this system.
- The speaker system grill cannot be removed. Do not try to forcibly remove it since doing so may damage the grille.
- When cleaning the cabinet, use the provided cleaning cloth. Do not allow alcohol, thinner, benzene, or insecticides to come into contact with the surface, since finish discoloration may occur. Also, when using chemically impregnated cleaning cloths, follow their precautions carefully.

Chapter 2

Connecting up

Receiver subwoofer

Side panel

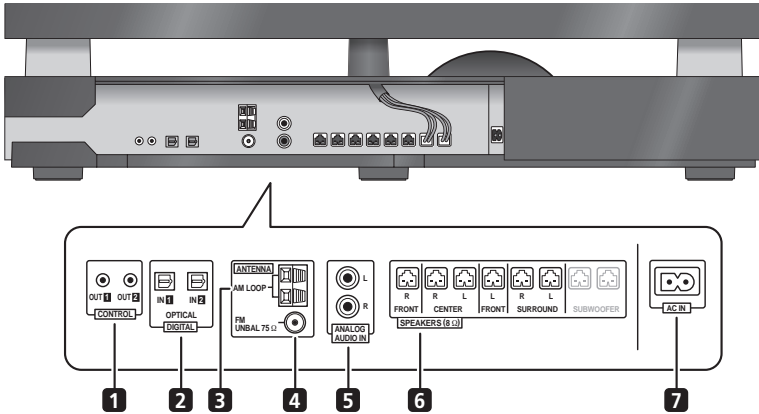

- There is a cover over the connectors on the side panel.
 - A. When making connections, lift the two hooks and remove the cover.
 - B. Once connections are finished, line up the three positions and place the cover back in its original position.

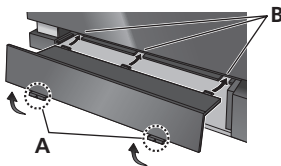
**1 CONTROL OUT jacks (x2)**

Connect other Pioneer components with the supplied control cable.

2 DIGITAL OPTICAL IN jacks (x2)

To listen to optical digital audio, change the input to **Digital 1** or **Digital 2**.

When the digital output jacks of your TV are connected to these jacks, set **'TV Input'** (see page 39).

3 AM LOOP antenna terminal**4 FM antenna socket****5 ANALOG AUDIO IN jacks**

Handle sound from an external component by using stereo audio code. To listen to analog audio, change the input to **Analog**.

When the analog output jacks of your TV are connected to these jacks, set **'TV Input'** (see page 39).

6 SPEAKERS terminals

Match the colors of the speaker cords to their respective connectors.

7 AC IN – Power inlet

Rear panel

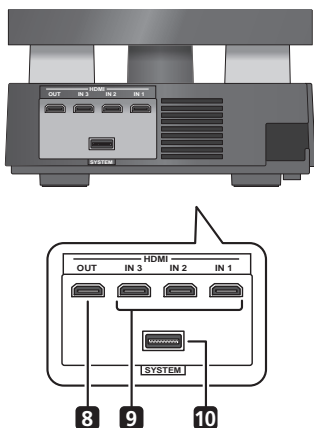

8 HDMI OUT connector

Connect to a television that has an HDMI terminal.

9 HDMI IN connectors (x3)

Use high-quality audio/video connection with compatible HDMI devices.

To select this input, choose **HDMI 1** to **HDMI 3**.

10 SYSTEM connector

Connect to the display unit.

Back of display unit

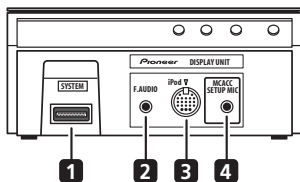

1 SYSTEM connector

Connect to the receiver subwoofer.

2 F.AUDIO input

To listen to audio from an external component, connect with a stereo mini-plug cable. Once connected, the input automatically changes to **Front Audio In**.

3 iPod input terminal

Use to connect your Apple iPod as an audio source.

When you connect an iPod, the input automatically changes to **iPod**.

4 MCACC SETUP MIC jack

Use to connect the supplied microphone for the Auto MCACC setup (see page 23).

Basic connections

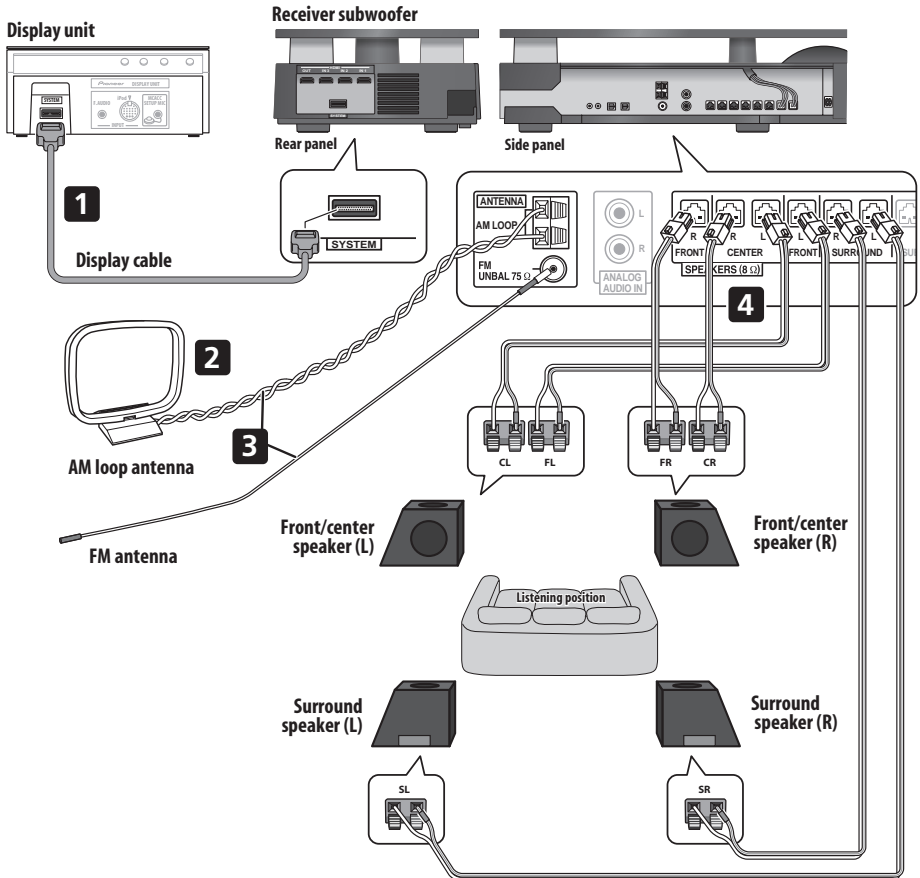

⚠ Important

- When connecting this system or changing connections, be sure to switch power off and disconnect the power cord from the wall socket. After completing all connections, connect the power cords to the wall socket.

⚠ WARNING

- Pioneer bears no responsibility for accidents resulting from faulty assembly or installation, insufficient mounting strength of walls, mounting fixtures (or other building fixtures), misuse or natural disasters.

1 Connect the display unit to the receiver subwoofer.

Plug the display cable into the connector on the rear of the display unit, then plug the other end of the display cable into **SYSTEM** connector on the receiver subwoofer.



Caution

- Do not attempt to attach the display unit to the wall.

2 Assemble the AM loop antenna.

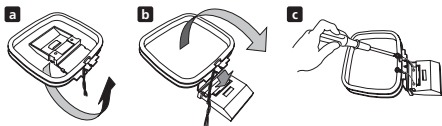

- Bend the stand in the direction indicated by the arrow.
- Clip the loop onto the stand.
- If you want to fix to a wall or other surface, perform step b after first securing the stand with screws.
It is recommended that you determine the reception strength before securing the stand with the screws.

3 Connect the AM and FM antennas¹.

- Connect one wire of the AM loop antenna to each AM antenna terminal².

For each terminal, press down on the tab to open; insert the wire, then release to secure.

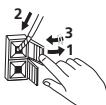

- Push the FM antenna³ plug onto the center pin of the FM antenna socket.

4 Connect each speaker.

- Each speaker cable has a color-coded connector at one end and two wires at the other end.

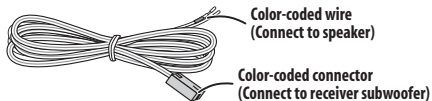

- Twist and pull off the protective shields on each wire.



- Connect the wires to the speaker. Each speaker in the illustration can be identified by means of the color-coded indicator provided on the rear-surface model label. Match the color-coded wire with the color indicator on the model label, then insert the color-coded wire into the red (+) side and the other wire into the black (-) side.

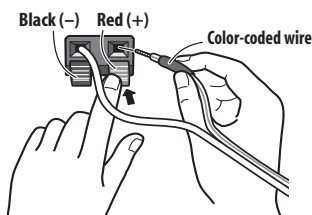

- Connect the other end to the color-coded speaker terminals on the side of the receiver subwoofer. Make sure to insert completely. Be careful when inserting the speaker plug, as it must be inserted in the proper direction when being plugged into one of the terminals. Please make sure to connect correctly.

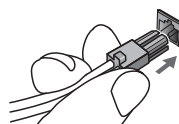

Note

- Keep antenna cables away from other cables, the display unit and receiver subwoofer.
 - If reception with the supplied antenna is poor, see *Improving poor FM reception* and *Improving poor AM sound* on page 28 or *Connecting external antennas* on page 35.
 - Do not attach any antenna other than the provided loop antenna, or an external antenna as described on page 35.
- Don't let it come into contact with metal objects and avoid placing near computers, television sets or other electrical appliances.
 - If radio reception is poor, you may be able improve it by re-inserting each antenna wire into the opposite terminal.
 - For best reception, do not untwist the AM loop antenna wires or wrap them around the loop antenna.
- To ensure optimum reception, make sure the FM antenna is fully extended and not coiled or hanging at the rear of the unit.

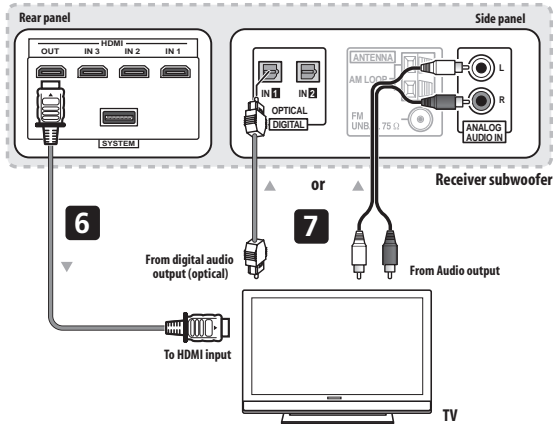

⚠ Caution

- These speaker terminals carry **HAZARDOUS LIVE voltage**. To prevent the risk of electric shock when connecting or disconnecting the speaker cables, disconnect the power cord before touching any uninsulated parts.
- Do not connect any speakers other than those supplied to this system.
- Do not connect the supplied speakers to any amplifier other than the one supplied with this system. Connection to any other amplifier may result in malfunction or fire.
- After connecting the plugs, pull lightly on the cables to make sure that the ends of the cables are securely connected to the terminals. Poor connections can create noise and interruptions in the sound.
- If the cables' wires happen to be pushed out of the terminals, allowing the wires to come into contact with each other, it places an excessive additional load on the amp. This may cause the amp to stop functioning, and may even damage the amp.

5 If you have a DVD player or other source¹ component you want to connect, connect it now before connecting the power cord in the next step.

See page 33 for how to connect a digital source component.

📌 Note

- 1 Make sure to connect a TV or monitor (for video sources) to take advantage of this system's home theater potential. Please refer to the instruction manual supplied with your TV or monitor for connection details.
- 2 Do not use any power cord other than the one supplied with this system.
 - Do not use the supplied power cord for any purpose other than connecting to this system.
 - After connecting this unit to an AC outlet, a 15-second initialization process begins. You cannot carry out any operations during initialization. The HDMI indicator on the display unit blinks during initialization, and you can turn this unit on once it has stopped blinking.

6 Connect the receiver subwoofer to your TV.

- Connect the **HDMI OUT** jack on receiver subwoofer to an HDMI input on your TV.

7 Connect an audio cable from your TV to the receiver subwoofer.

- To listen to TV audio on this unit, you must connect the TV's audio output to an audio input jack on this unit. You can connect by either a digital (optical) or analog audio cable. For digital audio, connect to **DIGITAL OPTICAL IN 1** on the receiver subwoofer. To use the HDMI Control function when you are connected to a supported Pioneer plasma television, you must connect via HDMI.
- You must first set **'TV Input'** to switch the audio from a plasma television with the HDMI Control function or to switch the input source of this unit to TV audio and operate your TV with the supplied remote control. For more information, see *Operating Pioneer plasma televisions and TVs* on page 17 and *Audio input settings from plasma televisions (TV Input)* on page 39.

8 Connect the power cord.²

- Connect each power cord to the AC inlet on the receiver subwoofer. Connect each power cord to a wall socket in the following order.
 1. Receiver subwoofer
 2. TV
- Run the cords that are connected to the side panel of the receiver subwoofer over the back side of the unit, and replace the cover on the side panel.

Chapter 3

Controls and displays

Display unit

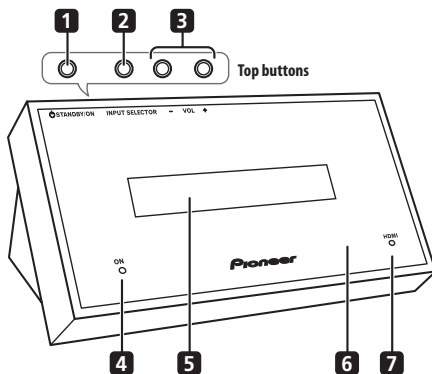

1 STANDBY/ON

Press to switch the receiver subwoofer on/into standby.

2 INPUT SELECTOR (page 33)

Press repeatedly to select one of the external audio inputs (**HDMI 1 to HDMI 3, Digital 1, Digital 2, Analog, iPod or Front Audio In**).

3 VOL +/- buttons

Use to adjust the volume.

4 POWER ON indicator (Blue)

5 Front panel display

See page 14 for details.

6 IR remote sensor (page 22)

7 HDMI indicator (Red)

Lights when this receiver subwoofer is connected to HDMI (HDCP) compatible component.

Also lights during initialization, after you plug this unit into an AC outlet.

Display

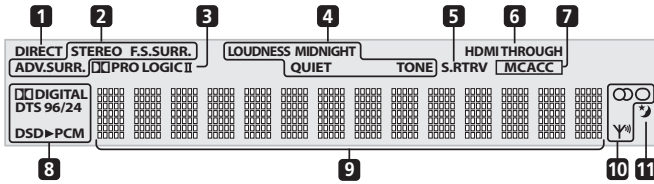
**1 DIRECT**

Lights when Direct Sound is selected (i.e. Effective Sound is off)(page 24).

2 Listening mode indicators**STEREO**

Lights when the Stereo mode is selected or when a stereo source is being played back in the Auto listening mode (page 26).

F.S.SURR.

Lights when one of the Front Stage Surround Advance listening modes is selected (page 26).

ADV.SURR.

Lights when one of the Advanced Surround listening modes is selected (page 25).

3 PRO LOGIC II

Lights during Dolby Pro Logic II decoding (page 25).

4 Sound processing indicators

Lights when any of the Loudness, Midnight, Quiet or tone controls feature is selected (page 27)

5 S.RTRV

Lights when Sound Retriever is active (page 26).

6 HDMI THROUGH

Lights when **HDMI Mode** is set to **Through Mode**.

7 MCACC

Lights when MCACC Effect is switched on (page 27).

Blinks during Auto MCACC Setup (page 23).

8 Digital format indicators**DIGITAL**

Lights during playback of a Dolby Digital source (page 24).

DTS

Lights during playback of a DTS source (page 24).

DTS 96/24

Lights during playback of a DTS 96/24 decoding (page 24).

DSD ▶ PCM

Lights during DSD (Direct Stream Digital) to PCM conversion with SACDs.

PCM

Lights during playback of PCM signals.

9 Character display**10 Tuner indicators**

Lights when a broadcast is being received.



Lights when a stereo FM broadcast is being received in auto stereo mode.



Lights when FM mono reception is selected.

11 Sleep timer indicator

Lights when sleep timer is active (page 40).

Remote control

- For more information on using the remote control, see *Operating the remote control* on page 22.

Operating the receiver subwoofer

This section explains how to operate the remote control for the receiver subwoofer. Note that the controls change when you have chosen the input function for separate connected devices.

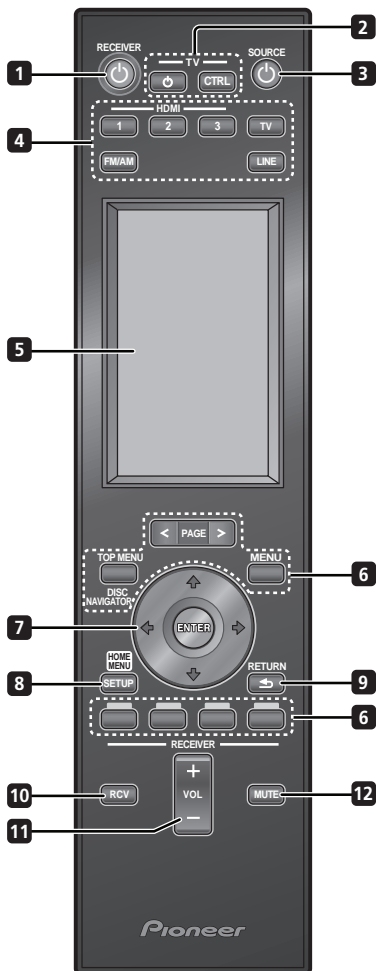

1 RECEIVER

Switches the receiver subwoofer to On/Standby.

2 TV

Switches the TV to On/Standby.

TV CTRL

Switches the remote control to the TV operating mode (no effect on the current input source of this unit).

3 SOURCE

Switches the power for the selected component to On/Standby (page 22).

4 Input select buttons

Change the input for this unit. You will also need to press one of these buttons when operating another connected component via this remote control.

HDMI 1 to HDMI 3

Switch input from **HDMI 1** to **HDMI 3**.

TV

Switches to the input selected at TV Input setup (page 39).

FM/AM (page 28)

Switches between FM and AM bands.

LINE (page 34)

Press repeatedly to select one of the receiver subwoofer's audio inputs (**Digital 1**, **Digital 2**, **Analog**, **iPod** or **Front Audio In**).

5 LCD touch screen

Displays the buttons used to control external components such as a receiver subwoofer, plasma television, DVD player, Blu-ray disc player, and HDD/DVD recorder. The current operating mode is displayed at the top of the remote control's screen.

Although the LCD touch screen disappears if you do not perform any operations for a while, it appears when the screen is touched or a button on the remote control is pressed.

6 Other component button

Use to operate an HDD/DVD recorder or other connected component.

7 (cursor buttons) and ENTER

Use to control receiver functions.

8 SETUP

Use to access the menu system for surround sound setup, tuner settings and so on (page 28, 30, 38, 40).

9 RETURN

Use to cancel settings.

10 RCV

Use to switch to the receiver subwoofer operating mode when this unit is in the other operating modes. Press again to return to the previous operating mode.

11 VOL +/-

Use to adjust the volume of the receiver subwoofer.

12 MUTE

Mutes the sound or restores the sound if it has been muted (adjusting the volume also restores the sound).

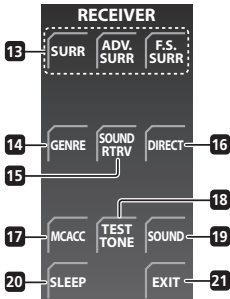
LCD touch screen**13 SURR**

Use to select a Surround mode (page 24).

ADV.SURR

Use to change the audio setting to Pioneer's original Advanced Surround mode (page 25).

F.S.SURR

Use to select a Front Stage Surround Advance mode (page 26).

14 GENRE

Use to listen to audio in Genre Sync mode (page 26). (This button is displayed only when the **RECEIVER** screen is shown during HDD/DVD recorder operation.)

15 SOUND RTRV

Press to restore CD quality sound to compressed audio sources (page 26).

16 DIRECT

Use to switch on/off the Effective Sound mode (page 24).

17 MCACC

Starts the Auto MCACC setup (page 23).

18 TEST TONE

Use to output the test tone (for speaker setup) (page 32).

19 SOUND

Press to access the sound menu, from which you can adjust bass and treble, etc.

20 SLEEP

Press to set the sleep timer (page 40).

21 EXIT

Cancel settings and exit the **RECEIVER** screen.

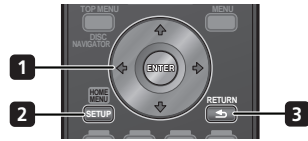
Operating the built-in FM/AM tuner**1 ↑/↓/←/→ (cursor buttons) and ENTER**

Use to control FM/AM tuner functions.

2 SETUP

Use to access the menu system or tuner settings.

3 RETURN

Use to cancel settings.

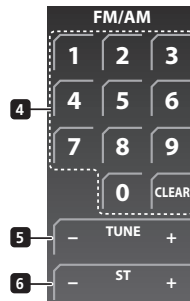
LCD touch screen**4 Number buttons**

Use to directly choose a preset radio station.

CLEAR

Press to clear an entry and start again.

5 TUNE +/-

Use to find radio frequencies.

6 ST +/-

Use to select a station preset.

Operating Pioneer plasma televisions and TVs

First, refer to *Setting up the remote to control your TV* on page 40 for information about setting up your TV's presets. Note that certain buttons may not work with some TVs.

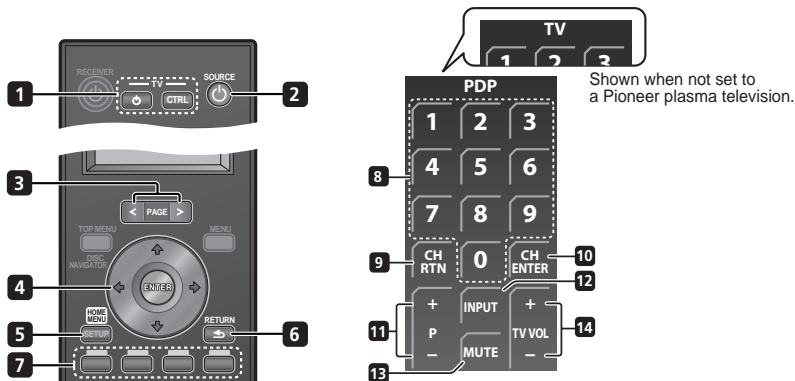

- 1** **TV**
Switches the TV to On/Standby.
TV CTRL
Switches the remote control to the TV operating mode (no effect on the current input source of this unit).
- 2** **SOURCE**
Switches the power for the TV to On/Standby.
- 3** **PAGE </>**
Switches pages on the LCD touch screen.
- 4** **↑/↓/←/→ (cursor buttons) and ENTER**
Use to navigate all on-screen displays. Press **ENTER** to select the currently highlighted option.
- 5** **HOME MENU**
Display the HOME MENU screen.
- 6** **RETURN**
Restores the previous menu screen.
- 7** **Color (RED/GREEN/YELLOW/BLUE) buttons**
Selects a page.

- LCD touch screen**
- 8** **Number buttons**
Selects a channel.
 - 9** **CH RTN**
Returns to the previously selected channel.
 - 10** **CH ENTER**
Executes a channel number.
 - 11** **P +/-**
Selects the channel.
 - 12** **INPUT**
Selects an input source of the TV.
 - 13** **MUTE**
Mutes the sound.
 - 14** **TV VOL +/-**
Sets the volume.

Operating a Pioneer Blu-ray Disc player

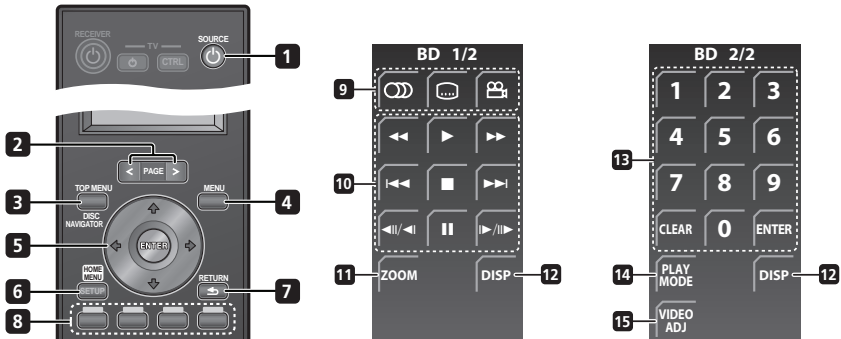

1 SOURCE

Switches the power for a Blu-ray disc player to On/Standby.

2 **PAGE** </>

Switch between pages on the LCD touch screen when multiple pages are present.

3 **TOP MENU / DISC NAVIGATOR**

Press to display the top menu of a BD-ROM or DVD-Video disc.

When playing a DVD-R/-RW disc, press to display/exit the Disc Navigator.

4 **MENU**

BD-ROM: Press to display/hide the pop-up menu.

DVD-Video: Press to display the disc menu (if there is one).

5 (cursor buttons) and **ENTER**

Use to navigate on-screen displays and menus. Press **ENTER** to select an option or execute a command.

6 **HOME MENU**

Press to display the player's Home Menu, access most of the player's functions.

7 **RETURN**

Press to return to a previous screen.

8 **Color (RED/GREEN/YELLOW/BLUE) buttons**

Use to navigate BD-ROM menus.

LCD touch screen

9 (AUDIO)

Press to select the audio channel or language.

(SUBTITLE)

Press to select a subtitle display.

(ANGLE)

Press to change the camera angle during BD-ROM or DVD-Video movie multi-angle scene playback.

10 **Playback controls**



Press to start or resume playback.



Press to stop playback (you can resume playback by pressing).



Press to pause playback; press again to restart.



Press to start reverse/forward scanning.



Press to jump to the start of the previous/next chapter/track.



Use for slow motion and step frame.

11 **ZOOM**

Press to zoom the screen when displaying a still image.

12 **DISP**

Press to display information.

13 **Number buttons**

Use to enter title, chapter or track numbers, etc.

ENTER

Press to select an option or execute a command.

CLEAR

Press to clear a numeric entry, etc.

14 **PLAY MODE**

Press to change the Play Mode (repeat play, for example).

15 **VIDEO ADJ**

Press to display the Video Adjust screen.

Operating a Pioneer DVD player

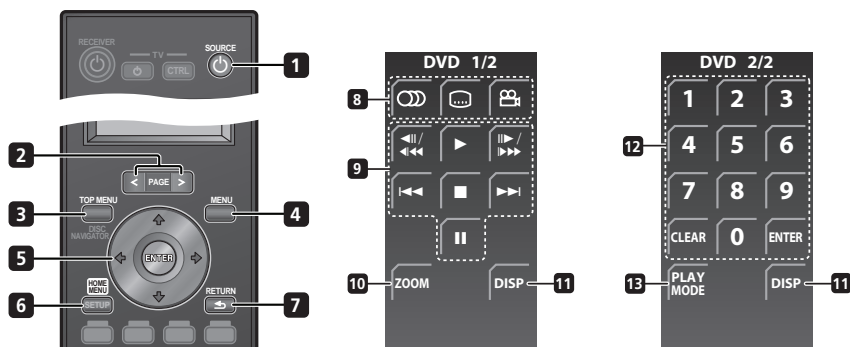

1 SOURCE

Switches the power for a DVD player to On/Standby.

2 PAGE </>

Switch between pages on the LCD touch screen when multiple pages are present.

3 TOP MENU

Press to display the top menu of a DVD-Video disc.

4 MENU

Displays a DVD disc menu – this varies with the disc and may be the same as the 'top menu'.

5 ↑/↓/←/→ (cursor buttons) and ENTER

Moves the cursor around the screen. Press **ENTER** to select the current menu option.

6 HOME MENU

Display/exit the on-screen display.

7 RETURN

Returns to the previously displayed menu screen.

LCD touch screen

8 (AUDIO)

Press to select the audio channel or language.

(SUBTITLE)

Press to select a subtitle display.

(ANGLE)

Press to change the camera angle during DVD-Video movie multi-angle scene playback.

9 Playback controls



Press to start or resume playback.



Press to stop playback (you can resume playback by pressing ▶).



Press to pause playback; press again to restart.



Press to start reverse or forward scanning. Press again to change the speed.

While paused, press and hold to start slow-motion playback. Press repeatedly to change the playback speed.

While paused, press to advance a single frame in either direction.



Press to skip to the previous or next title/chapter/track/folder; or to display the previous or next menu page.

10 ZOOM

Press to zoom the screen when displaying a still image.

11 DISP

Press to display information.

12 Number buttons

Use to enter title, chapter or track numbers, etc.

ENTER

Press to select an option or execute a command.

CLEAR

Press to clear a numeric entry, etc.

13 PLAY MODE

Press to change the Play Mode (repeat play, for example).

Operating a Pioneer HDD/DVD Recorder

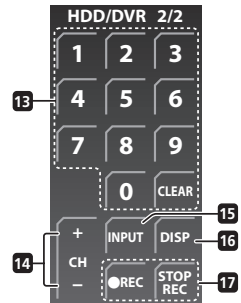
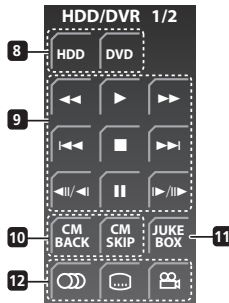
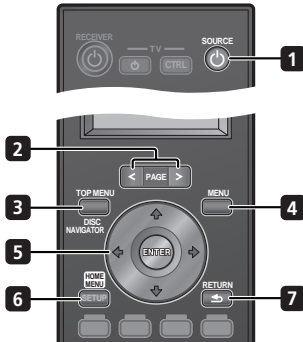

1 SOURCE

Switches the power for a HDD/DVD recorder to On/Standby.

2 **PAGE** </>

Switch between pages on the LCD touch screen when multiple pages are present.

3 **TOP MENU / DISC NAVIGATOR**

Press to display the top menu if a DVD-Video or finalized DVD-R/-RW (Video) disc is loaded, or the Disc Navigator screen.

4 **MENU**

Press to display the disc menu if a DVD-Video, finalized DVD-R/-RW or finalized DVD+R/+RW disc is loaded.

5 (cursor buttons) and **ENTER**

Use to navigate all on-screen displays. Press **ENTER** to select the currently highlighted option.

6 **HOME MENU**

Press to display the Home Menu, from which you can navigate all the functions of the recorder.

7 **RETURN**

Press to go back one level in the on-screen menu or display.

LCD touch screen

8 **HDD**

Press to select the hard disk (HDD) for recording and playback.

DVD

Press to select the DVD for recording and playback.

9 **Playback controls**

Press to start playback.

Press to stop playback.

Press to pause playback or recording.

Press to start reverse or forward scanning. Press again to change the speed.

Press to skip to the previous or next title/ chapter/ track/folder; or to display the previous or next menu page.

While paused, press and hold to start slow-motion playback. Press repeatedly to change the playback speed.

While paused, press to advance a single frame in either direction.

10 **CM BACK (commercial back)**

Press repeatedly to skip progressively backward through the video playing.

CM SKIP (commercial skip)

Press repeatedly to skip progressively forward through the video playing.

11 JUKEBOX

Press to display the Jukebox screen of a HDD/DVD recorder, from which you can copy music to the HDD for playback.

12 (AUDIO)

Press to change the audio language or channel. (When the recorder is stopped, press to change the tuner audio.)

(SUBTITLE)

Press to display/change the subtitles included in multilingual DVD-Video discs.

(ANGLE)

Press to switch camera angles on discs with multi-angle scenes.

13 Number buttons

Use the number buttons for track/chapter/title selection; channel selection, and so on.

CLEAR

Press to clear an entry and start again.

14 CH +/-

Press to change the channel of the built-in TV tuner.

15 INPUT

Press to change a HDD/DVD recorder input to use for recording.

16 DISP

Displays/changes the on-screen information displays.

17 Recording controls

● REC

Press to start recording. Press repeatedly to set the recording time in blocks of 30 mins.

STOP REC

Press to stop recording.

Putting the batteries in the remote control

1 Open the battery compartment cover on the back of the remote control.

2 Insert four AA/LR6 alkaline batteries into the battery compartment following the indications (+, -) inside the compartment.

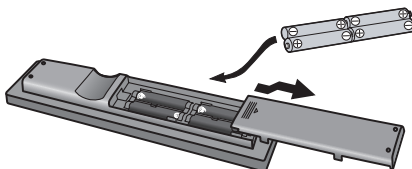

3 Close the cover.



Caution

Incorrect use of batteries can result in hazards such as leakage and bursting. Please observe the following:

- Don't mix new and old batteries together.
- Don't use different kinds of battery together — although they may look similar, different batteries may have different voltages.
- Make sure that the plus and minus ends of each battery match the indications in the battery compartment.
- Remove batteries from equipment that isn't going to be used for a month or more.
- When disposing of used batteries, please comply with governmental regulations or environmental public instruction's rules that apply in your country/area.



WARNING

- Do not use or store batteries in direct sunlight or other excessively hot place, such as inside a car or near a heater. This can cause batteries to leak, overheat, explode or catch fire. It can also reduce the life or performance of batteries.

Using the remote control

Please keep in mind the following when using the remote control:

- Make sure that there are no obstacles between the remote and the remote sensor on the unit.
- Remote operation may become unreliable if strong sunlight or fluorescent light is shining on the unit's remote sensor.
- Remote controllers for different devices can interfere with each other. Avoid using remotes for other equipment located close to this unit.
- Replace the batteries when you notice a fall off in the operating range of the remote.
- Use within the operating range in front of the remote control sensor on the display unit, as shown.

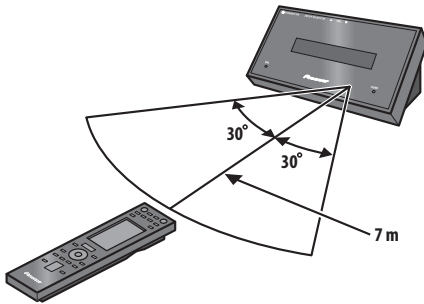

Operating the remote control

The supplied remote control can control not only the receiver subwoofer, but also other Pioneer products such as a plasma television, DVD player, Blu-ray disc player, and HDD/DVD recorder.

To operate these components, orient the remote control toward the display unit.

Operating the receiver subwoofer

- **RCV** Press to display the **RECEIVER** screen. The **RECEIVER** screen is shown on the remote control's LCD screen, and the remote is switched to Receiver mode.



Choosing and operating a source component



1 Press to cycle through connected components.

The selected component changes, and the LCD screen on the remote control changes to that of the appropriate component.

- To select input for **Digital 1**, **Digital 2**, **Analog**, **Front Audio In**, or **iPod**, press the **LINE** button until the desired input function is shown on the display unit.

2 Choose the input source you are using when you have selected HDMI 1 to HDMI 3 or LINE.

The LCD screen changes to that for the selected component, and you can then operate the desired component.

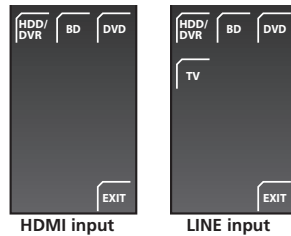

- When the desired source cannot be found, or when you have a component not manufactured by Pioneer connected, press **RCV** to put the remote control into Receiver mode. The input for this unit remains unchanged.

Note

To temporarily control the receiver while listening to audio from a connected component on this unit, press **RCV**. The selected input will not change, and the remote changes to Receiver mode. To return to the previous operating mode, press **RCV** once more.

Using the LCD touch screen

Depending on the type of connected component you are operating (such as DVD player), there may be multiple pages of information for the LCD touch screen. When the component you would like to control is not displayed, press **PAGE** to scroll to the page where the component you would like to control is located.

- When no operations are carried out for over 10 seconds, the display on the LCD touch screen of the remote control is automatically turned off. To have the display shown once again, either touch the LCD or press a button on the remote control.

Chapter 4

Getting started

Important

- **RCV** Press to set the remote control to receiver control mode in order to operate the receiver subwoofer (make sure that the LCD displays the **RECEIVER** screen, as shown below).



Using the Auto MCACC setup for optimal surround sound

The Multichannel Acoustic Calibration (MCACC) system measures the acoustic characteristics of your listening area, taking into account ambient noise, and testing for channel delay and channel level. After you have set up the microphone provided, the system uses the information from a series of test tones to measure standing wave and reverb, optimizing the speaker settings and equalization (MCACC Effect) for your particular room.¹

Important



- The test tones used for Auto MCACC setup are loud; however, do not turn the volume down during setup as this may result in a sub-optimal setup.
- Make sure the microphone and speakers are not moved during the MCACC setup.

1 Connect the microphone to the MCACC SETUP MIC jack on back of the display unit.

2 Place the microphone at your normal listening position.

Place it about ear height, and make sure it is level by using a table or chair.

Make sure there are no obstacles between the speakers and the microphone.

3  If the receiver subwoofer is off, press  RECEIVER to turn the power on.

4  Press MCACC.

Try to be as quiet as possible after pressing **MCACC**. The volume increases automatically and the system outputs a series of test tones.

- To cancel Auto MCACC setup before it has finished, press **MCACC**. The unit will continue to use the previous settings.
- If the ambient noise level is too high, **Noisy!** blinks in the display for five seconds. To exit and check the noise levels², press **MCACC**, or to try again, press **ENTER** when **Retry** shows in the display.
- If you see an **Error MIC!** or **Error Speaker!** message in the display, there may be a problem with your mic or the speaker connections. To try again, press **ENTER**³.

When the MCACC setup is complete, the volume level returns to normal, **Complete**⁴ shows in the display, and MCACC Effect is activated.⁵

- Be sure to disconnect the microphone from this unit upon completion of the Auto MCACC setup.

Note

- 1 You only need to use the Auto MCACC setup once (unless you change the placement of your speakers or your room layout).
- 2 • If the room environment is not optimal for the Auto MCACC setup (too much ambient noise, echo off the walls, obstacles blocking the speakers from the microphone) the final settings may be incorrect. Check for household appliances (air conditioner, fridge, fan, etc.), that may be affecting the environment and switch them off if necessary.
 - Some older TVs may interfere with the operation of the mic. If this seems to be happening, switch off the TV during Auto MCACC setup.
- 3 If this doesn't work, press **MCACC**, turn off the power, and check the problem indicated by the **Error** message, then try the Auto MCACC setup again.
- 4 If **Complete** doesn't appear, it is likely an error occurred during the setup. Please check all connections and try again.
- 5 See *Listening with MCACC Effect* on page 27 to switch on/off MCACC Effect.

Chapter 5

Listening to your system

**Important**

- **RCV** Press to set the remote control to receiver control mode in order to operate the receiver subwoofer (make sure that the LCD displays the **RECEIVER** screen, as shown below).

**Effective Sound (for optimum sound)**

With the uniquely shaped high-quality speakers supplied with this unit, the Effective Sound mode enables the following Pioneer exclusive audio technologies designed to maximize the real experience of sound originally inherent in movies and music.

Turn on the Effective Sound mode under normal circumstances to maximize the capabilities of this unit.

- **Dialogue Enhancement**
Clarifies dialogue in movies to make it stand out from other background sounds.
- **Dynamic Range Compression**
Resuscitates detailed sound susceptible to ambient noise to create an acoustic environment where you feel as if you are right in the action.
- **Original Channel Balance & Channel Mix**
Since the orientation of the supplied speaker units is uniquely designed, channels are mixed down and balanced in a special manner. Also, the optimum balance is automatically achieved according to the contents being played back.
- **Frequency Characteristic Correction**
Realizes the playback characteristic optimized for long hours of listening in addition to the added features of the supplied speaker units.

- **Stereo Playback in Surround**

Outputs audio from the surround speakers while directing vocal sound to the front channels. You can play back stereo sources like CDs in seamless, comfortable surround sound.

This effect is available when you play back stereo sources in the Auto listening mode (see below).

The Effective sound mode can be turned off (activating Direct mode) by doing the following:

- **DIRECT** Press to switch to Direct Sound.
Press this button to switch between Effective Sound and Direct Sound.
 - When Direct Sound is selected, the **DIRECT** indicator lights.

Auto listening mode

The Auto listening mode is the simplest way to listen to any source as it was mastered: the output from the speakers mirrors the channels in the source material.

If you set up the system for Front surround (page 6), the Front Stage Surround modes will give the best results (see page 26).

- **SURR** Press to select the Auto listening mode.

Listening in surround sound

You can listen to stereo or multichannel sources in surround sound. Surround sound is generated from stereo sources using one of the Dolby Pro Logic or DTS Neo:6 decoding modes.¹

If you set up the system for Front surround (page 6), the Front Stage Surround modes will give the best results (see page 26).

- **SURR** Press repeatedly to select a listening mode.
The choices that appear in the display will vary according to the type of source that's playing.²

Note

¹ After the surround back signals of the 6.1/7.1-channel audio represented by DTS-ES are properly decoded, the original virtual surround back function outputs the surround back signals in combination with surround signals.

² You cannot select a mode other than Auto and Stereo while playing back DTS-HD, DTS-Express, or Dolby TrueHD (176.4 kHz/192 kHz). Also, you cannot select DTS Neo:6 for Dolby Digital Plus or Dolby TrueHD (below 96 kHz).

With two channel sources, you can select from:

- **Auto** – Auto listening mode (see page 24)
- **□□PL II Movie** (Dolby Pro Logic II Movie) – 5.1 channel surround sound, especially suited to movie sources
- **□□PL II Music** (Dolby Pro Logic II Music) – 5.1 channel surround sound, especially suited to music sources; see *Dolby Pro Logic II Music settings* below
- **□□PL II Game** (Dolby Pro Logic II Game) – 5.1 channel surround sound, especially suited to video games
- **□□Pro Logic** (Dolby Pro Logic) – 4.1 channel surround sound for use with any two-channel source
- **Neo:6 Cinema** – 6.1 channel sound, especially suited to movie sources
- **Neo:6 Music** – 6.1 channel sound, especially suited to music sources; see *Center image setting* below
- **Stereo** – See *Listening in stereo* on page 26

With multichannel sources, you can select (according to format):

- **Auto** – Auto listening mode (see page 24)
- **StandardDecode** – Listening in Dolby Digital or DTS surround decoding. Plays back multichannel sources like Dolby Digital, DTS, and multichannel PCM with the most standard decoder
- **Stereo** – See *Listening in stereo* on page 26

Dolby Pro Logic II Music settings

When listening in Dolby Pro Logic II Music mode (see above), there are three settings you can adjust: Center Width, Dimension, and Panorama.

- 1  **Press when Dolby Pro Logic II Music mode is active.**



- 2 **Select 'Center Width', 'Dimension' or 'Panorama' then press ENTER.**

- **Center Width**¹ – Provides a better blend of the front speakers by spreading the center channel between the front right and left speakers, making it sound wider (higher settings) or narrower (lower settings).
- **Dimension** – Adjusts the depth of the surround sound balance from front to back, making the sound more distant (minus settings), or more forward (positive settings).

Note

1 As this product uses a dual center speaker system, you should normally use the **C.Width 3** setting.

2 As this product uses a dual center speaker system, you should normally use the **C.Image 3** setting.

3 You cannot use this function for the following audio streams:

- Dolby TrueHD: over 88.2 kHz
- DTS-HD: over 88.2 kHz or with the channel format of 2/0
- DTS-Express: with the channel format of 2/0

- **Panorama** – Extends the front stereo image to include the surround speakers for a 'wraparound' effect.



- 3 **Adjust the setting, then press ENTER to confirm.**

Center image setting

When listening to two channel sources in Neo:6 Music mode (see page 24), you can also adjust the center image effect.

Adjusts the center image to create a wider stereo effect with vocals.²

- 1  **Press when Neo:6 Music mode is active.**



- 2 **Select 'Center Image' then press ENTER.**



- 3 **Adjust the setting, then press ENTER to confirm.**

- Adjust the effect from **0** (all center channel sent to front right and left speakers) to **10** (center channel sent to the center speaker only).

Using Advanced Surround

The Advanced Surround effects can be used with any multichannel or stereo source for a variety of additional surround sound effects. These modes are designed to provide optimum listening effect when using the Standard surround setup described on page 6.

-  **Press to select an Advanced Surround mode.**

The **ADV.SURR.** indicator lights when one of these modes is chosen. You cannot switch between modes for some audio streams.³

Press repeatedly to select:

- **Action** – Designed for action movies with dynamic soundtracks
- **Drama** – Designed for movies with lots of dialog
- **Sci-Fi** – Designed for science fiction with lots of special effects
- **Mono Film** – Creates surround sound from mono soundtracks

- **Ent.Show** – Suitable for musical sources
- **Expanded** – Creates an extra wide stereo field
- **TV Surround** – Provides surround sound for both mono and stereo TV sources
- **Advanced Game** – Suitable for video games
- **Sports** – Suitable for sports programs
- **Classical** – Gives a large concert hall-type sound
- **Rock/Pop** – Creates a live concert sound for rock and/or pop music
- **Unplugged** – Suitable for acoustic music sources
- **Ext.Stereo** – Gives multichannel sound to a stereo source, using all of your speakers

Using Front Stage Surround Advance

The Front Stage Surround Advance modes are effective when you are using the Front surround speaker setup as described on page 6.

-  **Press to select a Front Stage Surround Advance mode.**

The **F.S.SURR** indicator lights.

Press repeatedly to select **Focus 5.1ch**, **Wide 5.1ch** or **Extra Power**. You cannot select a mode other than Extra Power for some audio streams.¹

- **Focus 5.1ch** – Use to provide a rich surround sound effect directed to the center area where the left and right speakers sound projection converges.
- **Wide 5.1ch** – Use to provide a surround sound effect to a wider area than **Focus 5.1ch** mode.
- **Extra Power** – Outputs stereo sound (in the case of multi-channel sources, down-mixed stereo sound) from the surround speakers for powerful stereo effect.

Listening in stereo

You can listen to any source — stereo or multichannel — in stereo. When playing a multichannel source, all channels are downmixed to the front left/right speakers and the subwoofer.

-  **Press repeatedly until STEREO shows in the display.**

Genre Sync Mode

Only when you have this unit connected to an HDMI Control-compatible Pioneer HDD/DVD recorder and are using the HDMI Control function, you can make use of the Genre Sync Mode to have the listening mode automatically change to that which best matches the genre of the contents playing from the recorder.

- Set the **HDMI Mode** to **AMP Mode** (page 36).

-  **Press when listening to media contents from a recorder.**

The most appropriate listening mode is selected and shown in the display. When the related genre could not be determined, **No Genre** or **Can't use** may be displayed and the listening mode remains unchanged.



Tip

- Mainly used with Jukebox and MP3 sources.
- To use this function, you must have an HDMI Control-compatible Pioneer HDD/DVD recorder connected via HDMI, and have the HDMI Control function set to On.

Using the Sound Retriever

When audio data is removed during the MP3 or WMA compression process, sound quality often suffers from an uneven sound image. The Sound Retriever feature employs new DSP technology that helps bring CD quality sound back to compressed two channel audio by restoring sound pressure and smoothing jagged artifacts left over after compression.

-  **Press while listening to a stereo source².**

Press repeatedly to switch between:

- **Retriever On** — Switches the Sound Retriever on.
- **Retriever Off** — Switches the Sound Retriever off.

Note



¹ You cannot use this function for the following audio streams:

- Dolby TrueHD: over 88.2 kHz
- DTS-HD: over 88.2 kHz or with the channel format of 2/0
- DTS-Express: with the channel format of 2/0

² This setting cannot be used with multichannel sources. Also, in case of SACD, DTS-HD, DTS-Express, Dolby TrueHD, Dolby Digital Plus, and PCM (192 kHz/176.4 kHz), even stereo sources cannot be used.

Listening with MCACC Effect

Listen to sound using the corrected acoustic field settings obtained by MCACC.



-  Press to open the sound menu.
-  Select 'MCACC Effect' then press ENTER.
-  Switch 'MCACC On' or 'MCACC Off' then press ENTER to confirm.
 - When **MCACC Effect** is off, equalization, channel delay, channel level and standing wave are set to off.
 - When **MCACC Effect** is off, the channel delay and channel level can be adjusted manually and the settings stored separately from when **MCACC Effect** is on.
 - MCACC Effect is set to on automatically after Auto MCACC setup is used.

Using Midnight, Loudness and Quiet listening modes

The Midnight listening feature allows you to hear effective surround sound of movies at low volume levels.





The Loudness listening feature can be used to get good bass and treble from music sources at low volume levels.

The Quiet listening feature reduces excessive bass or treble in a sound source.

-  Press to open the sound menu.
-  Select 'Tone' then press ENTER.¹
-  Select 'Midnight', 'Loudness' or 'Quiet' then press ENTER to confirm.²
 - To cancel the Midnight, Loudness or Quiet listening modes, select **Bass/Treble**.

Adjusting the bass and treble



Use the bass and treble controls to adjust the overall tone.

-  Press to open the sound menu.
-  Select 'Tone' then press ENTER.¹
-  Select 'Bass/Treble' then press ENTER.
 - Selecting **Bass/Treble** cancels the Midnight, Loudness and Quiet listening modes. These modes cannot be used at the same time.
-  Use the \leftarrow/\rightarrow buttons to select 'Bass' or 'Treble'; use the \uparrow/\downarrow buttons to adjust the sound then press ENTER to confirm.
 - Bass and Treble can be adjusted from **-6dB** to **+6dB**.
 - When the Bass or Treble is set to something other than **0dB**, the **TONE** indicator lights.

Adjusting sound delay

Some monitors have a slight delay when showing video, so the soundtrack will be slightly out of sync with the picture. By adding a bit of delay, you can adjust the sound to match the presentation of the video.

There are a total of 60 steps (levels) that you can adjust, with a total range of 200 msec.

-  Press to open the sound menu.
-  Select 'Sound Delay' then press ENTER.
-  Select the length of the delay in sound, then press ENTER to confirm.
 - This option is deactivated and not displayed if you have AutoDelay set to **On** in HDMI Setup (see *Setting the Auto Delay* on page 39).

Note

¹ While playing back DTS-HD (over 88.2 kHz) or Dolby TrueHD (over 88.2 kHz) audio streams, you cannot select **Tone** if a mode other than **Bass/Treble** is selected.

² While playing back DTS-HD (over 88.2 kHz) or Dolby TrueHD (over 88.2 kHz) audio streams, you cannot select a mode other than **Bass/Treble**.

Chapter 6

Listening to the radio

**Important**

- **FM/AM** To listen to the radio, press the **FM/AM** button to set the remote control to FM/AM control mode. The LCD screen on the remote control changes to the **FM/AM** screen.

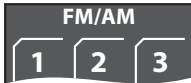
**Listening to the radio**

The tuner can receive both FM and AM broadcasts, and lets you memorize your favorite stations so you don't have to manually tune in every time you want to listen.

- 1 **FM/AM** **Switch to the tuner, then press repeatedly to select the FM or AM band.**

The display shows the band and frequency.

- 2  **Tune to a frequency.**

There are three tuning modes — manual, auto, and high-speed:

- **Manual tuning** – Press **TUNE +/-** repeatedly to change the displayed frequency.
- **Auto tuning** – Press and hold **TUNE +/-** until the frequency display starts to move, then release. The tuner will stop on the next station it finds. Repeat to keep searching.
- **High-speed tuning** – Press and hold **TUNE +/-** until the frequency display starts to move rapidly. Keep the button held down until you reach the frequency you want. If necessary, fine tune the frequency using the manual tuning method.

Improving poor FM reception

If you're listening to an FM station in stereo but the reception is weak, you can improve the sound quality by switching to mono.

- 1  **Press after tuning to an FM radio station.**

- 2  **Select 'Tuner Setup' then press ENTER.**

- 3  **Choose 'FM Auto/Mono' then press ENTER.**

- 4  **Select 'FM Mono' then press ENTER.**

The mono indicator (○) lights when the tuner is in mono reception mode.

Select **FM Auto** above to switch back to auto-stereo mode (the stereo indicator (◐)) lights when receiving a stereo broadcast).

Improving poor AM sound

The simplest way to improve the sound quality of AM radio is to make sure that the TV in the room is switched off. Also try changing the position and direction of the AM loop antenna.

Changing the noise cut mode

If you find that the AM sound quality is bad even after trying the above, you may be able to improve it using a different noise cut mode. Just choose the one that sounds best.

- 1  **Press after tuning to an AM radio station.**

- 2  **Select 'Tuner Setup' then press ENTER.**

- 3  **Choose 'Noise Cut' then press ENTER.**

- 4  **Select a Noise cut mode (1, 2 or 3) then press ENTER.**

Memorizing stations

You can save up to 30 station presets so that you always have easy access to your favorite stations without having to tune in manually each time.

1 Tune to an FM or AM radio station.

Select mono or auto-stereo reception (FM) or the Noise Cut mode (AM) as necessary. These settings are saved along with the preset.

2 Press SETUP.

3 Select 'Tuner Setup' then press ENTER.

4 Choose 'ST.Memory' then press ENTER.

5 Select the station preset you want then press ENTER.

Listening to station presets

1 Make sure the tuner function is selected.

- #### 2 Select a station preset.
- Alternatively, use the number buttons to select a preset directly.

Changing the frequency step

If you find that you can't tune into stations successfully, the frequency step may not be suitable for your country/region.

1 Press SETUP.

2 Select 'System Setup' then press ENTER.

3 Select 'AM9K/10K', then press ENTER.

4 Select a setting then press ENTER to confirm.

- AM 9K** – 9 kHz step for AM;
50 kHz step for FM
- AM 10K** – 10 kHz step for AM;
100 kHz step for FM

Chapter 7

Surround sound settings

**Important**

- **RCV** Press to set the remote control to receiver control mode in order to operate the receiver subwoofer (make sure that the LCD displays the **RECEIVER** screen, as shown below).

**Using the Sound Setup menu**

From the Sound Setup menu you can access all the surround sound settings of the system.

During setup, the speakers are represented by the following letters:

- **L** – Front left speaker
- **C** – Center speaker
- **R** – Front right speaker
- **SR** – Surround right speaker
- **SL** – Surround left speaker
- **SW** – Subwoofer

Channel level setting¹

The Auto MCACC feature (see page 23) should give you the best surround sound setup. However you may find that by further adjustment of the channel levels you can improve the surround sound in your listening room.

This method of setting the channel levels allows you to listen to a source and adjust the levels of each playback channel.

A further method of setting the channel levels is to use the test tone method. See *Adjusting the channel levels using the test tone* on page 32 for more on this.

- 1 Press **SETUP**.



- 2 Select '**Sound Setup**' then press **ENTER**.



- 3 Select '**ChannelLevel**', then press **ENTER**.



- 4 Use the **←/→** buttons to select a channel or the **↑/↓** buttons to adjust the level of that channel.

- You can adjust the level of each channel by ± 10 dB.²



- 5 **Press once when you're finished.**

- If you use the Auto MCACC feature again, it will overwrite the settings you have made here.

Speaker distance setting¹

The Auto MCACC feature (see page 23) should give you the best surround sound setup. However you may find that by further adjustment of the speaker distance settings you can improve the surround sound in your listening room.

Set the distance of each speaker from your normal listening position.

- 1 Open the '**Sound Setup**' menu.



- 2 Select '**Distance**' then press **ENTER**.



- 3 Use the **←/→** buttons to select a speaker or the **↑/↓** buttons to adjust the distance. Each speaker can be adjusted from **0.1m** to **9.0m**.



- 4 **Press ENTER when you're finished.**

- If you use the Auto MCACC feature again, it will overwrite the settings you have made here.

Note



¹ When this function is set while **MCACC Effect** is on, the value for the same function adjusted with the Auto MCACC feature is overwritten. When **MCACC Effect** is off, the value set here is applied, regardless of the value adjusted with the Auto MCACC feature. (The Auto MCACC setting is not overwritten.)

² The range of adjustment is limited when the volume level is set over 51.

Dynamic Range Control

When watching Dolby Digital or DTS material at low volume, low level sounds — including some of the dialog — can be difficult to hear properly. Using one of the Dynamic Range Control (DRC) settings can help by bringing up the low level sounds, while controlling high level peaks.

Dynamic Range Control works only with Dolby Digital soundtracks and some DTS soundtracks.

1   Open the 'Sound Setup' menu.

2  Select 'D.R.C.', then press ENTER.

3  Select a setting.



Select one of the following:

- **D.R.C. Auto** – Only available for Dolby TrueHD signals. Select **D.R.C. High** or **D.R.C. Mid** for signals other than Dolby TrueHD.
- **D.R.C. High** – Dynamic range is reduced (loud sounds are reduced in volume while quieter sounds are increased)
- **D.R.C. Mid** – Mid setting
- **D.R.C. Off** – No dynamic range adjustment (use when listening at higher volume)

4  Press to exit.

Dual mono setting

Specifies how dual mono encoded Dolby Digital soundtracks should be played. You can also use this setting to switch the audio channel on DVD-RW discs recorded with bilingual audio.

1   Open the 'Sound Setup' menu.

2  Select 'Dual Mono', then press ENTER.

3  Select a setting.



Select one of the following:

- **CH1 Mono** – Only channel 1 is played
- **CH2 Mono** – Only channel 2 is played
- **CH1/CH2** – Both channels are played through the front speakers

4  Press to exit.

Using the Virtual Surround Back mode

This mode allows you to hear a virtual surround back channel through your surround speakers. You can choose to listen to sources with no surround back channel information, or if the material sounds better in the format (for example, 5.1) for which it was originally encoded, you can have the receiver only apply this effect to 6.1 encoded sources like Dolby Digital EX or DTS-ES.¹

1   Open the 'Sound Setup' menu.

2  Select 'Virtual SB', then press ENTER.

3  Select a setting.
Select one of the following:

- **Vir.SB On** – Virtual Surround Back is always used (for example, on 5.1 encoded material)
- **Vir.SB Auto** – Virtual Surround Back is automatically applied to 6.1 encoded sources (for example, Dolby Digital EX or DTS-ES), DTS Neo:6 or Advanced Surround mode
- **Vir.SB Off** – Virtual Surround Back mode is switched off



4  Press to exit.

LFE Attenuate

Some Dolby Digital and DTS audio sources include ultra-low bass tones.

Set the LFE attenuator as necessary to prevent the ultra-low bass tones from distorting the sound from the speakers.

The LFE is not limited when set to **0dB**, which is the recommended value. When set to **-5dB**, **-10dB**, **-15dB** or **-20dB**, the LFE is limited by the respective degree. When **Off** is selected, no sound is output from the LFE channel.

1   Open the 'Sound Setup' menu.

2  Select 'LFE ATT', then press ENTER.

3  Adjust the setting then press ENTER to confirm.

Adjusting the channel levels using the test tone

If you prefer, you can set the channel levels using a test tone as a reference, rather than playing a source (see *Channel level setting* on page 30). A test tone is played through each speaker in turn, allowing you to adjust the level as it plays.

You can also adjust the channel levels for surround sound using test tone.

1  Carry out tone testing.

The test tone is output from each speaker in turn. Adjust the volume level below 50.

2  Adjust the channel level of a tune while it is playing.

The aim is to adjust the levels so that you hear the test tone at the same volume from each speaker. You can adjust the level of each channel by ± 10 dB.

- You can adjust the overall volume of test tone output using the **VOL +/-** buttons (this does not affect the channel level settings).
- Because of the ultra low frequencies the subwoofer produces, it may sound quieter than it really is. We suggest adjusting the subwoofer level while listening to a source. See the method described in *Channel level setting* on page 30.

3  Press to exit test tone setup once you have finished.

- If you use the Auto MCACC feature again, it will overwrite the settings you have made here.

Note

¹ Depending on the input signal and the listening mode, the Virtual Surround Back mode may not be effective.

Chapter 8

Other connections

Important

- When making or changing connections on the side panel of this unit, be sure to switch power off and disconnect the power cord from the wall socket. After completing all connections, connect the power cord to the wall socket.

Connecting auxiliary components

You can connect both analog and digital external audio sources to this system. Digital audio sources include digital satellite receivers, CD recorders, etc.

We recommend using an HDMI cable to connect sources that have HDMI terminals. For more information see *Connecting using HDMI* on page 35.

To listen to audio from a TV, connect the TV's audio cable to one of the inputs on this unit.

Connecting for digital audio

This system has optical-type digital inputs. Use these to connect external components, such as your MD or CD recorder.

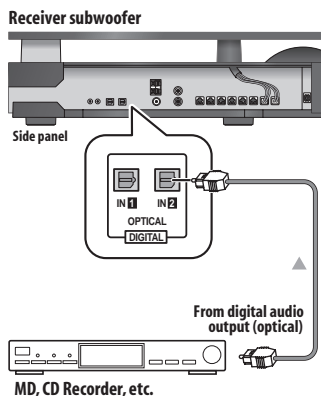

- Connect the **OPTICAL IN 2** jack on the side panel to the optical output of an external playback component. These include digital components such as an MD player, digital satellite, or a game system.

You can also use the **OPTICAL IN 1** jack to connect external components when not using it for sound input from a TV.

Connecting an analog audio component

You can use the **ANALOG AUDIO IN** jacks to connect an analog audio component, such as a tape player.

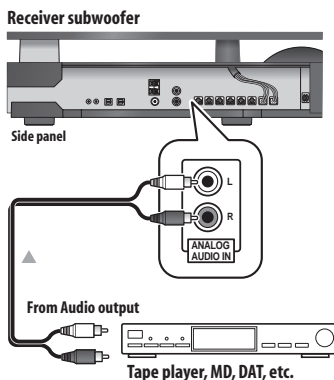

You can use the **F.AUDIO** input jack on the display unit to easily playback audio from a digital audio player or PC. Use a stereo mini-plug cable to connect a source to the display unit.

- When you connect a cable to the **F.AUDIO** jack, this unit's input automatically switches to **Front Audio In**.

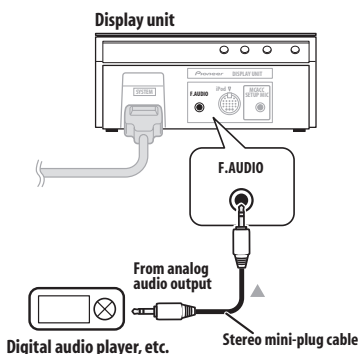

Connecting an iPod

You can use the **iPod** jack on the display unit to playback music from an iPod. All operations can be carried out via the iPod. Use the supplied iPod cable to connect an iPod to this unit.

- When you connect an iPod, this unit's input automatically switches to **iPod**.
- Certain iPod models have connectors that are not compatible with this unit.

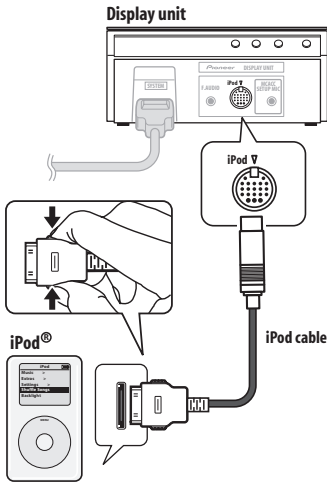

iPod® is a trademark of Apple Inc., registered in the U.S. and other countries.

Listening to an external audio source

To listen to audio from a connected external component on this unit, choose its input function on the remote control. Some Pioneer products can be controlled via this remote.

1 If the system isn't already on, press **⏻ RECEIVER** to switch on.

Also make sure that the external source (TV, satellite receiver, etc.) is switched on.

2 **LINE** Select an audio input source.

Input sources are cycled through as shown below:



The LCD screen changes to that of the selected input source.

3 Press the button for the appropriate connected component.

When a connected component is not displayed on the screen, or when you have connected a component not manufactured by Pioneer, press **RCV** button to put the remote control on the receiver subwoofer operation screen.

4 If necessary, start playback of the external source.

Connecting external antennas

For an external AM antenna, use 5 to 6 meters of vinyl-insulated wire and set up either indoors or outdoors. Leave the loop antenna connected.

For an external FM antenna, use a PAL connector to hook up an external FM antenna.

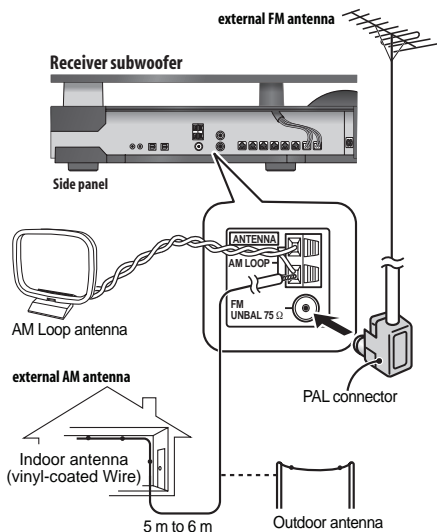

About control out connections

Many Pioneer components support CONTROL connections, by which you can use the remote controls of any connected components by aiming them at the sensor of just one component.

When you use a remote control, the control signal is passed along the chain to the appropriate component.

If you choose to use this feature, you must make sure that you also have at least one set of HDMI or analog audio jacks connected to another component for grounding purposes.

- Using the supplied control cable on either side, connect the CONTROL IN jack on another Pioneer component to the CONTROL OUT jack on the receiver subwoofer.

This will allow you to control the other component by pointing its remote at the display unit supplied with this receiver subwoofer.

Connecting using HDMI

If you have an HDMI or DVI (with HDCP) equipped component, you can connect it to this receiver using a commercially available HDMI cable.¹

The HDMI connection transfers uncompressed digital video, as well as almost every kind of digital audio that the connected component is compatible with, including DVD-Video, DVD-Audio, SACD, Blu-ray Disc, Video CD/Super VCD, CD and MP3, etc.

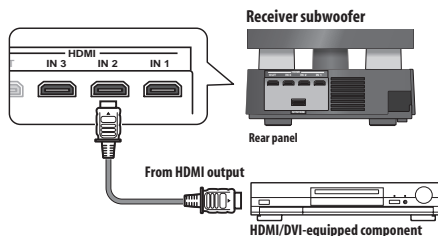

Note

¹ • An HDMI connection can only be made with DVI-equipped components compatible with both DVI and High Bandwidth Digital Content Protection (HDCP). If you choose to connect to a DVI connector, you will need a separate adaptor (DVI → HDMI) to do so. A DVI connection, however, does not support audio signals. Consult your local audio dealer for more information.

- This unit has been designed to be compliant with HDMI (High-Definition Multimedia Interface) Version 1.3a. Depending on the component you have connected, using a DVI connection may result in unreliable signal transfers. Also, when using a component with HDMI version 1.0, it is not possible to output copy-controlled DVD-Audio CPPM sources from the HDMI connection.
- This unit supports SACD, Dolby Digital Plus, Dolby TrueHD and DTS-HD Master Audio. To take advantage of these formats, however, make sure that the component connected to this unit also supports the corresponding format.

1 Use an HDMI cable to connect the HDMI IN 1 to 3 interconnect on this receiver subwoofer to an HDMI output on your HDMI component.

Once this receiver subwoofer is properly connected to your HDMI component, the **HDMI** indicator (red) lights up on the display unit when you watch HDMI contents.

2 Use an HDMI cable to connect the HDMI OUT interconnect on this receiver subwoofer to an HDMI interconnect on a HDMI-compatible display.

- The arrow on the cable connector body should be facing right for correct alignment with the connector on the player.



3 Use the HDMI 1 to 3 button to select the HDMI input you've connected to (for example, HDMI 2).

You can also use the display unit **INPUT SELECTOR** to carry out this operation.

- Set the HDMI Mode in *HDMI mode setting* below to **Through Mode** if you want to hear HDMI audio output from your TV or plasma television (no sound will be heard from this receiver subwoofer).
- If the video signal does not appear on your TV or plasma television, try adjusting the resolution settings on your component or display.

HDMI mode setting

Specifies the routing of the HDMI audio signal out of this receiver subwoofer (amp) or through to a TV or plasma television. You cannot use a number of sound functions of this unit when HDMI Mode is set to **Through Mode**.



Important

- **RCV** Press to set the remote control to receiver control mode in order to operate the receiver subwoofer (make sure that the LCD displays the **RECEIVER** screen).

1 **SETUP** Press **SETUP**.



2 Select '**HDMI Setup**' then press **ENTER**.



3 Select '**HDMI Mode**', then press **ENTER**.



4 Adjust the setting then press **ENTER** to confirm.

- **AMP Mode** – Output an HDMI audio signal from this unit.
- **Through Mode** – Output an HDMI audio signal from a TV or plasma television. The **HDMI THROUGH** indicator lights.

About HDMI

HDMI (High-Definition Multimedia Interface) supports both video and audio on a single digital connection for use with DVD players, DTV, set-top boxes, and other AV devices. HDMI was developed to provide the technologies of High-bandwidth Digital Content Protection (HDCP) as well as Digital Visual Interface (DVI) in one specification. HDCP is used to protect digital content transmitted and received by DVI-compliant displays.

HDMI has the capability to support standard, enhanced, or high-definition video plus standard to multi-channel surround-sound audio. HDMI features include uncompressed digital video, a bandwidth of up to 2.2 gigabytes per second (with HDTV signals), one connector (instead of several cables and connectors), and communication between the AV source and AV devices such as DTVs.

HDMI, the HDMI logo and High-Definition Multimedia Interface are trademarks or registered trademarks of HDMI Licensing LLC.

Chapter 9

HDMI Control

By connecting this unit to an HDMI Control-compatible Pioneer plasma television or the HDD/DVD recorder with an HDMI cable, you can control this unit from the remote control of a connected plasma television, as well as have the connected plasma television automatically change inputs in response to operations carried out on this unit.

Refer to the operating instructions for your plasma television for more information about which operations can be carried out by connecting via HDMI cable.

- You cannot use this function with components that do not support HDMI Control.
- We cannot guarantee this unit will work with HDMI Control-compatible components other than those made by Pioneer.

Important

- RCV** Press to set the remote control to receiver control mode in order to operate the receiver subwoofer (make sure that the LCD displays the **RECEIVER** screen, as shown below).



Making the HDMI Control connections

You can use synchronized operation for a connected plasma television and up to three other components (including a maximum of two recorders or players).

Be sure to connect the plasma television's audio cable to the audio input of this unit.

- If you use a commercially available HDMI cable, check whether the cable supports the HDMI 1.3 standard. Otherwise, the HDMI Control function may not operate properly.

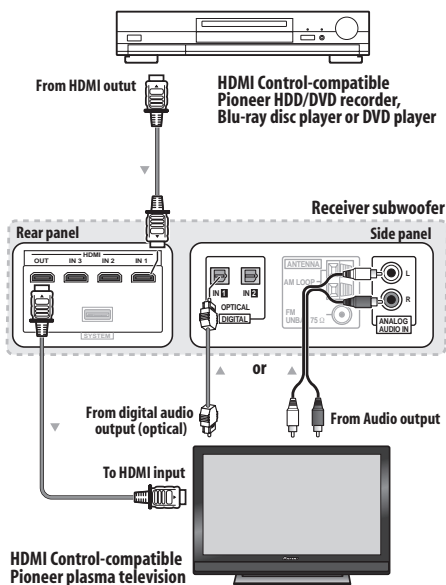

- Connect the plasma television directly to this unit. Interrupting a direct connection with other amps or an AV converter (such as an HDMI switch) can cause operational errors.

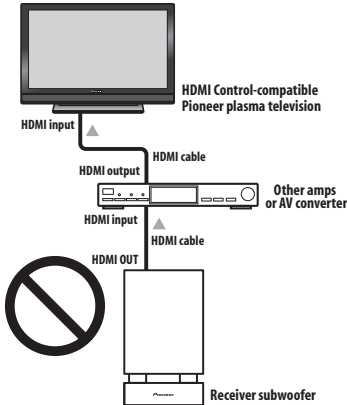

- Only connect components you intend to use as a source to the HDMI input of this unit. Interrupting a direct connection with other amps or an AV converter (such as an HDMI switch) can cause operational errors.

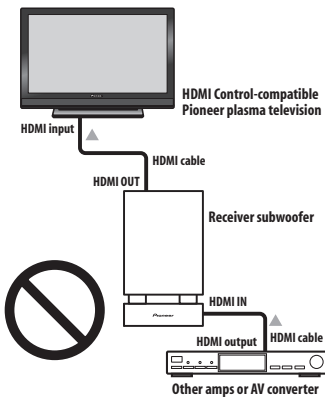

Important

- When connecting this system or changing connections, be sure to switch the power off and disconnect the power cord from the wall socket. After completing all connections, connect the power cords to the wall socket.
- After connecting this unit to an AC outlet, a 15-second initialization process begins. You cannot carry out any operations during initialization. The **HDMI** indicator on the display unit blinks during initialization, and you can turn this unit on once it has stopped blinking.
- To get the most out of this function, we recommend that you connect your HDMI component not to a plasma television but rather directly to the HDMI terminal on this unit.





Setting the HDMI options

You must adjust the settings of this unit as well as HDMI Control-compatible connected components in order to make use of the HDMI Control function. For more information see the operating instructions for each component.

Setting the HDMI Control mode

Choose whether to set this unit's HDMI Control function **On** or **Off**. You will need to set it to **Control On** to use the HDMI Control function.

- When using a TV not manufactured by Pioneer, put this setting to **Control Off**.

- 1  Press **SETUP**.
- 2  Select 'HDMI Setup' then press **ENTER**.
- 3  Select 'HDMI Ctrl', then press **ENTER**.
- 4  Adjust the setting then press **ENTER** to confirm.

- **Control On** – Enables the HDMI Control function. When this unit's power is turned off and you have a supported source begin playback while using the HDMI Control function, the audio and video output from the HDMI connection are output from the plasma television.
- **Control Off** – The HDMI Control is disabled. Synchronized operations cannot be used. When this unit's power is turned off, audio and video of sources connected via HDMI are not output.

Setting the Auto Delay

This feature automatically corrects the audio-to-video delay between components connected with an HDMI cable. The audio delay time is set depending on the operational status of the display connected with an HDMI cable. The audio delay time is automatically adjusted according to the video delay time.

1  Press **SETUP**.



2 Select 'HDMI Setup' then press **ENTER**.



3 Select 'Auto Delay', then press **ENTER**.



4 Select 'A.Delay On' or 'A.Delay Off' then press **ENTER** to confirm.



Tip

- This feature is only available when the connected display supports the automatic audio/video synchronizing capability ('lip-sync') for HDMI or HDMI Control. If you find the automatically set delay time unsuitable, set **A.Delay** to **Off** and adjust the sound delay settings manually (page 27).

Audio input settings from plasma televisions (TV Input)

To listen to audio from a plasma television on this device, you will need to connect an audio cable other than an HDMI cable. From this menu, set the audio input to that which you would like to connect. Press **TV** on the remote control to switch this unit to the input source selected here. This setting is changed to the selected input and the audio from the plasma television is output from this device.

Select from inputs **Digital 1**, **Digital 2** and **Analog**.

1  Press **SETUP**.



2 Select 'System Setup' then press **ENTER**.



3 Select 'TV Input', then press **ENTER**.



4 Adjust the setting then press **ENTER** to confirm.



Important

- You must set this setting to activate the HDMI Control function.

Before using synchronization

Once you have finished all connections and settings, you must:

- Put all components into standby mode.
- Turn the power ON for all components, with the power for the plasma television being turned on last.
- Choose the HDMI input to which the TV is connected to this unit, and see if video output from connected components displays properly on the screen or not.

Synchronized amp mode

Synchronized amp mode begins once you carry out an operation for the plasma television. For more information, see the operating instructions of your plasma television.

Synchronized amp mode operations

By connecting a component to this unit with an HDMI cable you can use synchronized amp mode, which allows you to synchronize the following operations:

- Displays on the plasma television when you mute or adjust the volume of this unit.
- The input of this unit is automatically changed when playback occurs on a connected component.
- Even if you change this unit's input to a device that is not connected by HDMI, the synchronized amp mode remains in effect.
- By pressing **GENRE** when listening to a source from an HDD/DVD recorder, the most appropriate listening mode is automatically selected (page 26).

Canceling synchronized amp mode

If you cancel synchronized amp mode while connected via HDMI to a plasma television or while you are watching a TV programme, the power for this unit is turned off.

Chapter 10

Additional information

 Important

- **RCV** Press to set the remote control to receiver control mode in order to operate the receiver subwoofer (make sure that the LCD displays the **RECEIVER** screen, as shown below).

**Dimming the display**

You can choose to dim the display of the display unit if you find it too bright.¹

- 1 **SETUP** Press **SETUP**.



- 2 Select 'System Setup' then press **ENTER**.



- 3 Select 'Dimmer' then press **ENTER**.



- 4 Select 'Dimmer Light' or 'Dimmer Dark' then press **ENTER** to confirm.

Setting the sleep timer

The sleep timer switches off the receiver subwoofer after a specified time so you can fall asleep without worrying about it.

- **SLEEP** Press to select an option.

Choose between the following options:

- **Sleep On** – Switches off after about an hour
- **Sleep Off** – Cancels the sleep timer

After selecting **Sleep On**, you can press **SLEEP** again to check how much time is left. Each line indicates approximately 12 minutes (remaining):

Sleep - - - - 

 Note

¹ The display of the display unit dims when the sleep timer is set, regardless of this setting.

Setting up the remote to control your TV

You can use the supplied remote to control your TV. To be able to use this feature you first have to program the remote with a maker code from the table on the following page.

- 1 **TV** Set the input to **TV**.

- 2 Press and hold the **TV** button and press **SETUP**.

The TV preset screen is shown on the remote control, and the current maker code is displayed on the LCD screen.

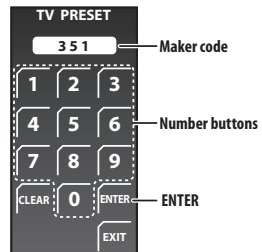

- 3 Use the number buttons to input the maker code for your TV, and press **ENTER**.

See the table on the next page for the list of maker codes. If there is more than one code given for your make, input the first one in the list.

- If the maker's name of your TV doesn't appear in the table, you will not be able to use this remote to control your TV.

- 4 Point the remote towards your TV and press **SOURCE** to check that the remote works with your TV.

If the remote is set up correctly, the TV should switch off. If it doesn't and there is another code given for your maker, repeat step 1 with a new code.

TV Preset code list

Please note that there are cases where only certain functions may be controllable after assigning the proper preset code, or the codes for the manufacturer in the list will not work for the model that you are using.

Manufacturer	Code(s)	Manufacturer	Code(s)
Admiral	003, 004, 005	NEC	128, 129, 130, 131
Aiwa	006, 007, 008	Nokia	086, 087, 132, 133, 134
Akai	009, 010	Nokia Oceanic	135, 136
Alba	011	Nordmende	137, 138, 139
AOC	012	Okano	140
Bell&Howell	013, 014	Onwa	141
Bestar	015	Orion	142
Blaupunkt	016, 017	Panasonic	143, 144, 145, 146, 147, 148, 149, 150
Blue sky	018	Philco	151, 152, 153
Brandt	019	Philips	154, 155, 156
Brocsonic	020, 021	Phonola	157
Bush	022	Portland	158, 159
Clatronic	023	Proscan	160
Craig	024, 025, 026, 027	Quasar	161, 162
Croslex	028	Radio	163
Curtis Mathis	029, 030, 031	Radio Shack	164, 165, 166, 167
Daewoo	032, 033, 034, 035, 036, 037	Radiola	168
Daytron	038	RCA	169, 170, 171, 172, 173, 174, 175
Dual	039, 040	SABA	176, 177, 178, 179, 180
Emerson	041, 042, 043, 044, 045, 046, 047	Samsung	181, 182, 183, 184, 185, 186, 187, 188
Ferguson	048, 049, 050	Sanyo	189, 190, 191, 192, 193, 194, 195, 196, 197, 198
First line	051	Schneider	199, 200, 201, 202
Fisher	052, 053	Scott	203, 204
Fraba	054	Sharp	205, 206, 207, 208, 209, 210, 211
Fujitsu General	055	Siemens	212
Funai	056, 057, 058, 059, 060	Signature	213, 214
GE	061, 062, 063, 064, 065	Sony	215, 216
Goldstar	066, 067, 068, 069, 070	Sylvania	217, 218, 219
Goodmans	071, 072, 073	Symphonic	220
Grundig	074, 075, 076	Tatung	221
Hitachi	077, 078, 079, 080, 081, 082	Telefunken	222, 223, 224, 225
HYUNDAI	083	Thomson	226, 227
ICE	084	Thorn	228
Irradio	085	Toshiba	229, 230, 231, 232, 233, 234
Itt	086, 087	Universum	235
JC Penny	088, 089, 090, 091	Videch	236, 237, 238
JVC	092, 093, 094, 095, 096, 097	W.Whouse	239
Kendo	098	Wards	240, 241, 242, 243
KTV	099, 100, 101	Watson	244
LG	102	Yamaha	245, 246, 247, 248, 249
Loewe	103, 104, 105	Zenith	250, 251
LXI	106, 107, 108, 109, 110, 111	PIONEER	001, 002
Magnavox	112, 113, 114, 115		
Mark	116		
Matsui	117, 118		
Medion	119		
Mitsubishi	120, 121, 122, 123, 124, 125, 126		
Mivar	127		

Resetting the system

Use this procedure to reset all system settings to the factory default.

- 1 **Switch the system on.**
- 2 **Press and hold INPUT SELECTOR then press the  STANDBY/ON button on the display unit.**

The next time you switch on, all the system settings should be reset.

Installation and maintenance

Hints on installation

We want you to enjoy using this system for years to come, so please bear in mind the following points when choosing a location:

Do...

- ✓ Use in a well-ventilated room.
- ✓ Place on a solid, flat, level surface, such as a table, shelf or stereo rack.

Don't...

- ✗ Use in a place exposed to high temperatures or humidity, including near radiators and other heat-generating appliances.
- ✗ Place on a window sill or other place where the system will be exposed to direct sunlight.
- ✗ Use in an excessively dusty or damp environment.
- ✗ Place directly on top of an amplifier, or other component in your stereo system that becomes hot in use.
- ✗ Use near a television or monitor as you may experience interference — especially if the television uses an indoor antenna.
- ✗ Use in a kitchen or other room where the system may be exposed to smoke or steam.
- ✗ Use on a thick rug or carpet, or cover with cloth — this may prevent proper cooling of the system unit.
- ✗ Place on an unstable surface, or one that is not large enough to support all four of the system unit's feet.

Surround sound formats

Below is a brief description of the main surround sound formats you'll find on DVDs, satellite, cable and terrestrial broadcasts, and video cassettes.

Dolby

The Dolby technologies are explained below. See www.dolby.com for more detailed information.



Dolby Digital

Dolby Digital is a multichannel digital audio coding system widely used in cinemas, and in the home for DVD and digital broadcast soundtracks. It can deliver up to six discrete audio channels, comprising five full range channels and a special LFE (low frequency effects) channel used mainly for deep, rumbling sound effects; hence the term "5.1-channel" Dolby Digital.

In addition to the format features above, Dolby Digital decoders offer downmixing for compatibility with mono, stereo and Dolby Pro Logic audio from a number of bit rates and channels. Another feature, called Dialog Normalization, attenuates programs based on the average level of dialog in a program relative to its peak level (also known as Dialnorm) in order to achieve uniform playback level.

Dolby Pro Logic II and Dolby Surround

Dolby Pro Logic IIx is an improved version of the Dolby Pro Logic II (and Dolby Pro Logic) *decoding* system. Using the innovative "steering logic" circuit, this system extracts surround sound from sources as follows:

- **Dolby Pro Logic** – 4.1 channel sound (mono surround) from any stereo source
- **Dolby Pro Logic II** – 5.1 channel sound (stereo surround) from any stereo source

With two channel sources, the ".1" subwoofer channel is generated by bass management in the receiver.

Dolby Surround is an *encoding* system which embeds surround sound information within a stereo soundtrack, which a Dolby Pro Logic decoder can then use for enhanced surround listening with greater sound detail.

Dolby Digital Plus

Dolby Digital Plus is the next-generation audio technology for all high-definition programming and media. It combines the efficiency to meet future broadcast demands with the power and flexibility to realize the full audio potential expected in the upcoming high-definition era. Built on Dolby Digital, the multi-channel audio standard for DVD and HD broadcasts worldwide, Dolby Digital Plus was designed for the next-generation A/V receivers but remains fully compatible with all current A/V receivers.

Dolby Digital Plus delivers multi-channel audio programs of up to 7.1 channels (*) and supports multiple programs in a single encoded bitstream with the maximum bit rate potential of up to 6 Mbps and the maximum bit rate performance of up to 3 Mbps on HD DVD and 1.7 Mbps on Blu-ray Disc, and it outputs Dolby Digital bitstreams for playback on existing Dolby Digital systems. Dolby Digital Plus can accurately reproduce the sound originally intended by directors and producers.

It also features multi-channel sound with discrete channel output, interactive mixing and streaming capability in advanced systems. Supported by High-Definition Media Interface (HDMI), a single-cable digital connection is possible for high-definition audio and video.

Dolby TrueHD

Dolby TrueHD is the next-generation lossless encoding technology developed for high-definition optical discs in the upcoming era. Dolby TrueHD delivers tantalizing sound that is bit-for-bit identical to the studio master, unlocking the true high-definition entertainment experience on high-definition optical discs in the next generation. When coupled with high-definition video, Dolby TrueHD offers an unprecedented home theater experience with stunning sound and high-definition picture.

It supports bit rates of up to 18 Mbps and records up to 8 full-range channels (*) individually with 24-bit/96 kHz audio. It also features extensive metadata including dialogue normalization and dynamic range control. Supported by High-Definition Media Interface (HDMI), a single-cable digital connection is possible for high-definition audio and video.

* HD DVD and Blu-ray Disc standards currently limit their maximum number of audio channels to eight, whereas Dolby Digital Plus and Dolby TrueHD support more than eight audio channels.

Manufactured under license from Dolby Laboratories. "Dolby", "Pro Logic" and the double-D symbol are trademarks of Dolby Laboratories.

DTS

The DTS technologies are explained below. See www.dtstech.com for more detailed information.



DTS Digital Surround

DTS Digital Surround is a 5.1-channel audio coding system from DTS Inc. now widely used for DVD-Video, DVD-Audio, 5.1 music discs, digital broadcasts, and video games. It can deliver up to six discrete audio channels, comprising five full range channels, including an LFE channel. Higher sound quality is achieved through the use of a low compression rate, and high rates of transmittance during playback.

DTS-ES

DTS-ES (the ES stands for Extended Surround) is a decoder that is capable of decoding both DTS-ES Discrete 6.1 and DTS-ES Matrix 6.1 encoded sources. DTS-ES Discrete 6.1 gives 'true' 6.1 channel sound, with a completely separate (discrete) surround back channel. DTS-ES Matrix 6.1 has a surround back channel matrixed into the surround left/right channels. Both sources are also compatible with a conventional DTS 5.1 channel decoder.

DTS Neo:6

DTS Neo:6 can generate 6.1 channel surround sound from any matrixed stereo source (such as video or TV) and from 5.1 channel sources. It uses both the channel information already encoded into the source, as well as its own processing to determine channel localization (with two channel sources, the ".1" subwoofer channel is generated by bass management in the receiver). Two modes (Cinema and Music) are available using DTS Neo:6 with two channel sources.

DTS 96/24

DTS 96/24 is an extension of the original DTS Digital Surround which offers high quality 96 kHz/24-bit audio using a DTS 96/24 decoder. This format is also fully backward compatible with all existing decoders. This means that DVD players can play this software using a conventional DTS 5.1 channel decoder.

DTS-EXPRESS

DTS-EXPRESS is a low-bitrate encoding technology supporting up to 5.1 channels with fixed data transfer rates. This format is incorporated with sub audio on HD DVD and secondary audio on Blu-ray Disc while boasting the potential applicability to upcoming broadcasts and memory audio contents.

DTS-HD Master Audio

DTS-HD Master Audio is a technology that delivers master audio sources recorded in a professional studio to listeners without any loss of data, preserving audio quality. DTS-HD Master Audio adopts variable data transfer rates, facilitating data transfer to the maximum rate of 24.5 Mbps in the Blu-ray disc format, 18.0 Mbps in the HD-DVD format, which by far exceeds that of a standard DVD. These high data transfer rates enable lossless transmission of 96 kHz/24-bit 7.1-channel audio sources without deteriorating the quality of the original sound. DTS-HD Master Audio is an irreplaceable technology that can reproduce sound faithfully as intended by the creator of music or movies.

"DTS" is a registered trademark of DTS, Inc. and "DTS-HD Master Audio" is a trademark of DTS, Inc.

Troubleshooting

Incorrect operations are often mistaken for trouble and malfunctions. If you think that there is something wrong with this component, check the points below. Sometimes the trouble may lie in another component. Investigate the other components and electrical appliances being used. If the trouble cannot be rectified even after exercising the checks listed below, ask your nearest Pioneer authorized service center or your dealer to carry out repair work.

- If the system does not operate normally due to external effects such as static electricity disconnect the plug from the outlet and insert again to return to normal operating conditions.
- For audio-related problems, please also check the settings of the audio playback device. See the operating instructions for the device for detailed information.

General

Problem	Remedy
The power does not turn on, or switches off suddenly (an error message may be displayed at startup). Or, the display disappears suddenly and no sound is output (with the POWER ON indicator (Blue) and the HDMI indicator (Red) lit up).	<ul style="list-style-type: none"> • Leave the unit plugged in, wait for one minute, then switch back on. • Make sure there are no loose strands of wire touching the unit. This could cause the system to shut off automatically. • Check that the speakers are connected correctly. • Make sure there is enough space for ventilation around the receiver subwoofer. • Make sure the voltage of the mains power source is correct for the model. • Try reducing the volume level. • If the problem persists, take it to your nearest Pioneer authorized service center or your dealer for servicing. • Do not block the air intake opening on the bottom as well as the air exhaust opening on the back of this unit.
No sound is output when an input function is selected.	<ul style="list-style-type: none"> • If you're using the line input, make sure the component is connected correctly and the volume level of your external component (i.e. a portable player, etc.) is adjusted (see <i>Connecting auxiliary components</i> on page 33). • Turn up the volume. • No audio is output from the speakers connected to this unit if HDMI Mode is set to Through Mode (page 36). • No audio is output if a DVI component is connected via HDMI. • Press MUTE on the remote control to turn muting off.
No sound from surround speaker.	<ul style="list-style-type: none"> • Refer to <i>Channel level setting</i> on page 30 to check the speaker levels. • Check that you haven't selected the Stereo mode (see <i>Listening in surround sound</i> on page 24). • Connect the speakers properly (refer to <i>Connecting up</i> on page 8). • Verify the audio output and HDMI settings of your external component when connecting an external component via an optical digital cable or HDMI cable.
Can't operate using the remote control.	<ul style="list-style-type: none"> • Replace the batteries (<i>Putting the batteries in the remote control</i> on page 21). • Operate within 7 m, 30° of the remote sensor (<i>Using the remote control</i> on page 22). • Remove any obstacles or operate from another position. • Avoid exposing the remote sensor on the front panel to direct light. • For operating the other Pioneer component connected to the CONTROL OUT jack of this receiver subwoofer, make sure that the control cable and either an HDMI or analog audio cable are connected (page 35).

Tuner

Problem	Remedy
Considerable noise in radio broadcasts.	<ul style="list-style-type: none"> • Connect the AM antenna (refer to <i>Connecting up</i> on page 8) and adjust the direction and position for best reception. You may also connect an additional internal or external AM antenna (refer to <i>Connecting external antennas</i> on page 35). • Fully extend the FM wire antenna, position for best reception, and secure to a wall. You may also connect an outdoor FM antenna (see <i>Connecting external antennas</i> on page 35). • Turn off other equipment that may be causing the noise or move it further away. • The tuning interval is incorrect for your country or region. See <i>Changing the frequency step</i> on page 29 to switch the tuning interval.
Auto tuning does not pick up some stations.	<ul style="list-style-type: none"> • The radio signal is weak. Auto tuning will only detect radio stations with a good signal. For more sensitive tuning, connect an outdoor antenna.

HDMI

Symptom	Remedy
No picture or sound.	<ul style="list-style-type: none"> • This receiver is HDCP-compatible. Check that the components you are connecting are also HDCP-compatible. • Depending on the connected source component, it's possible that it will not work with this receiver (even if it is HDCP-compatible). • If the problem still persists when connecting your HDMI component directly to your monitor, please consult the component or monitor manual or contact the manufacturer for support.
No sound, or sound suddenly ceases.	<ul style="list-style-type: none"> • Check that the HDMI Mode setting is set to AMP Mode/Through Mode. • If the component is a DVI device, use a separate connection for the audio. • Check the audio output settings of the source component.

Displayed Messages

Message	Description
192kHz PCM SACD DTS-HD DTS Express Dolby TrueHD Dolby D+	These messages are displayed when you operate a function incompatible with the audio source being played back.
No MIC	Displays when you press MCACC when the MCACC setup mic is not connected.
Muting	Displays when you press TEST TONE or MCACC while this unit is muted.
2ch Only	An operation is prohibited because it is only applicable to 2 channel sources, while the current source is a multichannel source.
Exit	Appears when a menu is automatically exited after a set period of inactivity.
HDMI Through	Displays when you change the Listening Mode, the volume level, or some sound settings when the HDMI Mode is set to Through Mode.
Unknown	The genre information for contents being played back on the HDD/DVD recorder cannot be obtained.
No Genre	There is no genre set for contents being played back on the HDD/DVD recorder.
HDMI C.ERR 2C*	The connected component is not compatible with synchronized genre mode.
Can't use	<ul style="list-style-type: none"> • You tried to use Genre Sync Mode for a source component that does not support this function. • The source component is in a situation where Genre Sync Mode cannot be used. • You tried to use Genre Sync Mode when the input source of this unit is a source other than HDMI. • The operation is forbidden due to the surround settings. • When the volume level is over 51, some functions are restricted.
HDMI C.ERR 1**	Check if the HDMI cable is properly connected. If the cable is properly connected, this unit may be damaged. In such an event, please contact a Pioneer-authorized service center or your nearest dealer.
Noisy!	Background noise is too high to complete MCACC setup successfully.
Error MIC!	An error occurred during MCACC setup because the microphone is not connected or is not connected properly.
Error Speaker!	An error occurred during MCACC setup because the speakers are not connected or are not connected properly.
Over Temp	Try lowering the volume. If this problem is not fixed by removing and inserting the power cable, this unit may be damaged. In such an event, please contact a Pioneer-authorized service center or your nearest dealer.
OC Error1 OC Error2	Check whether the speaker cables are short-circuited. If the error message continues to be displayed, contact your Pioneer authorized service center or your dealer for servicing.
*** BackUpERR	Contact your Pioneer authorized service center or your dealer for servicing.

Specifications

SX-LX70W Audio Multi-channel Receiver Subwoofer

• Amplifier section

RMS Power Output (8 channel output):

Front (L/R)	100 W (50 W + 50 W)
	(1 kHz, 10 % T.H.D., 8 Ω)
Dual Center (CL/CR)	100 W (50 W + 50 W)
	(1 kHz, 10 % T.H.D., 8 Ω)
Surround (L/R)	100 W (50 W + 50 W)
	(1 kHz, 10 % T.H.D., 8 Ω)
Double Subwoofer (2 channel)	100 W (50 W + 50 W)
	(100 Hz, 10 % T.H.D., 8 Ω)

• FM tuner section

Frequency range	87.5 MHz to 108 MHz
Antenna	75 Ω, unbalanced

• AM tuner section

Frequency range	
With 9 kHz step	531 kHz to 1602 kHz
With 10 kHz step	530 kHz to 1700 kHz
Antenna	Loop antenna

• Subwoofer section

Enclosure	Bass-reflex floor type (magnetically shielded)
System	18 cm 1-way system
Speaker	18 cm cone type x2
Impedance	8 Ω
Frequency range	30 Hz to 500 Hz
Maximum Input Power50 W x2

• Input/Output section

HDMI terminal	
input	19 pin x3
output	19 pin (5 V, 100 mA)
Other connector	
System connector	26 pin
Audio input	Optical x2 (Digital)
	RCA (2 pin) (Analog)
Control output	Mini jack x2
Display unit	
System connector	26 pin
Front Audio input	Mini jack
MCACC input	Mini jack
iPod input	20 pin (12 V, 420 mA)

• Miscellaneous

Power requirements	AC 110 V to 240 V, 50 Hz/60 Hz
Power consumption	69 W
Power consumption in standby039 W (HDMI Control ON)
	0.29 W (HDMI Control OFF)
Dimensions	245 mm (W) x 409 mm (H) x 600 mm (D)
Weight	17.8 kg

SSP-LX70ST Satellite Speaker

(Front/center speakers x2, Surround speakers x2)

• Front/center speakers

Enclosure	Closed-box bookshelf type (magnetically shielded)
System	5.2 cm 1-way system
Speakers	5.2 cm cone type x3
Impedance	
Front channel	8 Ω
Center channel	8 Ω
Frequency range	200 Hz to 20 kHz
Maximum input power	
Front channel50 W
Center channel50 W
Dimensions	122.5 mm (W) x 89.5 mm (H) x 104 mm (D)
Weight	0.5 kg

• Surround speakers

Enclosure	Closed-box bookshelf type (magnetically shielded)
System	5.2 cm 1-way system
Speakers	5.2 cm cone type x2
Impedance	8 Ω
Frequency range	200 Hz to 20 kHz
Maximum input power50 W
Dimensions	122.5 mm (W) x 89.5 mm (H) x 104 mm (D)
Weight	0.44 kg

Accessories

• Accessory box (AS-LX70):

Remote control	1
AA/LR6 alkaline batteries	4
Power cords	3
Display unit	1
AM loop antenna	1
FM wire antenna	1
Microphone (for Auto MCACC setup)	1
HDMI cable	1
Control cable	1
Display cable	1
Optical digital cable	1
iPod cable	1
This operating instructions	1

• Receiver subwoofer (SX-LX70W) box:

Cleaning cloth	1
----------------------	---

• Satellite Speakers (SSP-LX70ST) box:

Speaker cables	6
Speaker bases	4
Non-skid pads	16
Screws	4

Note

- Specifications and design subject to possible modification without notice, due to improvements.

Published by Pioneer Corporation.
Copyright © 2007 Pioneer Corporation.
All rights reserved.

感謝您購買本台先鋒產品。

請徹底閱讀本操作手冊，以便正確地操作您的產品。在您閱讀完手冊後，請妥為保管以便將來參考之用。

重要



等邊三角形內帶有箭頭的閃電符號旨在引起用戶警惕，因本產品機殼內有無絕緣“危險電壓”，可能很大程度造成觸電的危險。

小心

有電擊的危險
請勿打開

注意
為避免觸電危險，請勿拆卸蓋子（或背面板）。機內沒有可供用戶自行修理的零部件。維修事宜交由有資格的維修人員進行。



等邊三角形內的感嘆號旨在提醒用戶注意本機附帶的資料中有關操作和維護（修理）的重要說明。

D3-4-2-1-1_ChH

警告

本機不防水。為防止起火或觸電事故，請勿將本機置放於任何承裝液體的容器（如花瓶或花盆）附近或將其暴露於漏水、濺水、雨中或潮濕環境中。

D3-4-2-1-3_A_ChH

警告

為防止火災，請勿將明火源（如點燃的蠟燭）放置於本機上。

D3-4-2-1-7a_A_ChH

若本機之交流電源插頭與您欲使用的交流電源插座不符，請拆下插頭並換上合適的。僅可由專業技術人員於本機的電源供給電纜上更換及安裝交流電源插頭。若在連接至交流電插座上時切斷插頭，可能導致觸電。請確認插頭於移除後已予妥善處理。

當本機處於長時間未使用之情形（如假期中）時，請將主電源插頭自牆上插頭拔除以切斷電源。 D3-4-2-2-1a_A_ChH

操作環境

操作環境溫度與溼度：

+5 °C 至 +35 °C (+41 °F 至 +95 °F)；小於 85 %RH（勿堵塞冷卻孔）

請勿在通風不良處、暴露於高溼度或陽光直射（或強烈的人造光源）的場所安裝本機。

D3-4-2-1-7c_A_ChH

電源線注意事項

請手持插頭部分挪動電源線。拔下插頭時勿拉拽電源線，且勿用濕手去碰電源線，因為這樣可能會導致短路或電擊。勿將本裝置、家具或其他物件壓在電源線上，或以其他方式擠壓電源線。切勿將電源線打結或和其他的線綁縛。電源線的佈線應防止被人踩在上面。電源線受損可能會導致火災，或造成人員觸電。經常檢查電源線。如果您發現電源線受損，請就近至先鋒公司授權維修中心或銷售商進行更換。

S002_ChH

注意

本機 \odot STANDBY/ON 開關不完全將電源自交流電插座切斷。因電源線為本機主要電源切斷裝置，您需要將插頭拔除以切斷所有電力。因此，請確認本機安裝時電源線可輕易自交流電插座拔除以防止意外。為防止火災，當本機處於長時間未使用之情形（如假期中）時，請將主電源插頭自牆上插座拔除以切斷電源。

D3-4-2-2a_A_ChH

警告

第一次插置電源前，請仔細閱讀下列部分：

電源供給的電壓因國家或地區而異。請確認本機使用之地區的電源供給電壓符合本機後面板上所寫之電壓〔230 V 或 120 V〕要求。

D3-4-2-1-4_A_ChH

本產品只適宜一般家庭用途。如果是由於應用在其他非家庭用途(如做為商業用途而長期使用於餐廳中，或者使用於汽車或船中)而導致發生故障並需要修理，在保用期間必須承擔修理費用。

K041_ChH

警告

為避免受傷，重低音接受器需按照操作手冊說明緊貼地板放置。

通風注意事項

安裝本機時，請確定在本機四周預留足夠的空間以利通風（頂部10 cm、背面10 cm、及兩側10 cm以上）。

警告

機殼上具有之縫隙及開口用於通風，以確保本產品之正常操作並防止過熱。為避免火災，請勿堵塞開口或用物品（如報紙、桌布、簾幕）將其覆蓋，也請勿在厚毯或床上操作本機。

D3-4-2-1-7b_B_ChH

台灣地區專用



「廢電池請回收」

用於台灣地區

台灣雙腳扁平插頭

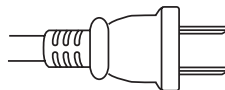

目錄

包裝箱內容物	5	05 聆聽您的系統輸出的音效	
01 揚聲器設定指南		有效聲音（適用於最佳聲音）	24
設定時應注意的安全措施	6	自動聆聽模式	24
家庭劇院音效設定	6	以環繞音效聆聽	24
標準環繞設定	6	Dolby Pro Logic II Music 設定值	25
前環繞設定	6	中央影像設定	25
準備揚聲器	6	使用「先進環繞聲」功能	25
使用隨附的揚聲器支座	6	使用前場前環繞聲模式	26
不使用隨附的揚聲器支座時	7	以立體聲聆聽	26
揚聲器系統接線	7	類型同步化模式	26
關於揚聲器擺設的其他注意事項	7	使用「聲音修正器」功能	26
02 接線		以 MCACC 效果聆聽	27
接收重低音揚聲器	8	使用「午夜」、「響度」及「寂靜」聆聽模式	27
側面板	8	調整低音及高音	27
後面板	9	調整聲音延遲	27
顯示裝置背面	9	06 收聽廣播	
基本連接	10	收聽廣播	28
03 控制與顯示		改善 FM 接收不良	28
顯示裝置	13	改善 AM 音效不佳	28
顯示幕	14	改變雜音抑制模式	28
遙控器	15	記憶電台	29
操作接收重低音揚聲器	15	收聽預設電台	29
操作內建的 FM/AM 調諧器	16	改變頻率間隔	29
操作先鋒電漿電視和一般電視機	17	07 環繞音效設定值	
操作先鋒 Blu-ray Disc 播放機	18	使用「聲音設定」選單	30
操作先鋒 DVD 播放器	19	聲道位準設定值	30
操作先鋒硬碟/DVD 錄影機	20	揚聲器距離設定	30
裝入遙控器電池	21	動態範圍控制	31
使用遙控器	22	雙單聲道設定值	31
操作遙控器	22	使用虛擬後環繞模式	32
使用液晶觸控畫面	22	LFE 衰減	32
04 開始操作		使用測試音調整聲道位準	32
使用「自動 MCACC」設定以達最佳環繞音效	23	08 其他接線	
		連接輔助設備	33
		數位音訊的連接	33
		連接類比音效設備	33
		連接 iPod	34
		聆聽外接音訊來源	34
		連接外接天線	35
		關於控制輸出連接	35
		使用 HDMI 連接	35
		HDMI 模式設定	36
		關於 HDMI	36

09 HDMI Control

進行 HDMI Control 連接.....	37
設定 HDMI 選項.....	38
設定 HDMI Control 模式.....	38
設定自動延遲.....	39
電漿電視的音訊輸入設定 (TV 輸入).....	39
使用同步化之前.....	39
同步化擴大器模式.....	39
同步化擴大器模式操作.....	39
取消同步化擴大器模式.....	39

10 其他資訊

調暗顯示幕亮度.....	40
設定睡眠定時器.....	40
設定遙控器以控制電視機.....	40
電視機預設代碼表.....	41
重設系統.....	42
安裝與維護.....	42
安裝提示.....	42
環繞音效格式.....	42
Dolby.....	42
DTS.....	43
故障排除.....	44
一般.....	44
調諧器.....	45
HDMI.....	45
顯示的訊息.....	46
規格.....	47

包裝箱內容物

請確認包裝箱內有下列項目的物品。

配件盒 (AS-LX70) :

- 遙控器 (第 15 頁)
- AA/LR6 鹼性電池 x4 (第 21 頁)
- 電源線 x3 (第 12 頁)
- 顯示裝置 (第 13 頁)
- AM 迴路天線 (第 11 頁)
- FM 線型天線 (第 11 頁)
- 麥克風 (用於自動 MCACC 設定) (第 23 頁)
- HDMI 連接線
- 控制連接線 (第 35 頁)
- 顯示連接線 (第 11 頁)
- 光學數位連接線 (第 12 頁)
- iPod 連接線 (第 34 頁)
- 本操作手冊

接收重低音揚聲器 (SX-LX70W) 包裝箱 :

- 清潔布

揚聲器 (SSP-LX70ST) 包裝箱 :

- 揚聲器 (前置/中置 x2、環繞 x2) (第 6、11 頁)
- 揚聲器連接線 x6 (第 11 頁)
- 揚聲器支座 x4 (第 6 頁)
- 防滑墊 x16 (第 6、7 頁)
- 螺絲 x4 (第 7 頁)

第 1 章

揚聲器設定指南

設定時應注意的安全措施

組裝揚聲器時，請將揚聲器平放以免發生意外或受傷。請務必在平穩的表面上進行揚聲器的組裝、設定與擺放。

家庭劇院音效設定

您可視房間大小與特性，決定使用這套系統中適用的揚聲器安置方式。

標準環繞設定

此為標準多聲道環繞音效揚聲器設定，適用於 5.1 聲道的家庭劇院音效。

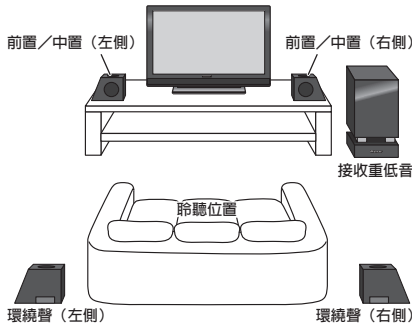

前環繞設定

此設定方式最適合在無法放置後環繞的情況下，或者不希望聆聽區域內擺設過長的揚聲器電線時使用。使用此設定結合在第 26 頁中的前場前環繞聲模式。

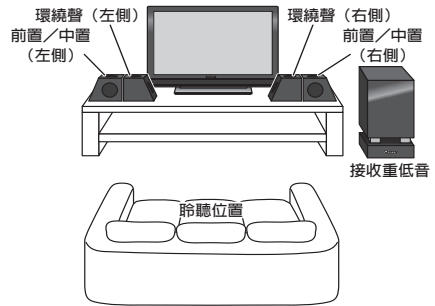

準備揚聲器

本機隨附的揚聲器支座可用於針對在房間內的擺放位置而進行調整。

使用隨附的揚聲器支座

- 如下圖所示，將防滑墊貼在揚聲器支座上。請使用防滑墊有黏性的一邊貼上每個揚聲器支座的底部。

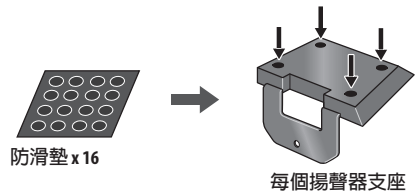

2 裝上揚聲器支座。

將揚聲器放在隨附的揚聲器支座上，然後使用隨附的螺絲將支座固定。

- 隨附的揚聲器支座有兩種形狀。您可以在將揚聲器放在支座上後，檢查螺絲的位置是否正確對齊來判斷是否使用正確的揚聲器支座。（前置／中置（左側）和環繞聲揚聲器（右側）、前置／中置（右側）和環繞聲揚聲器（左側）使用特定的支座，並隨附每個揚聲器的兩種類型支座。）

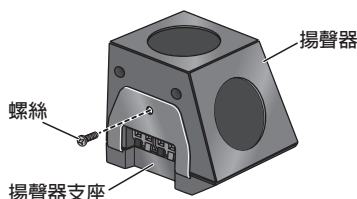

不使用隨附的揚聲器支座時

- 將防滑墊黏貼於每個前置／中置與環繞揚聲器的底部（如圖所示）。請使用防滑墊有黏性的一邊貼上每個揚聲器的底部。

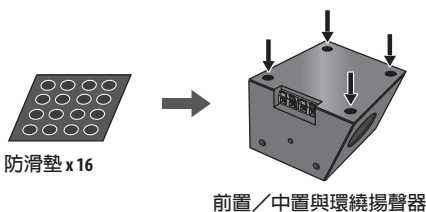

揚聲器系統接線

請參閱接線以便正確連接揚聲器。完成接線後，請依照上圖所示安置揚聲器，以達最佳環繞音效。安置揚聲器後，請執行自動 MCACC 設定（第 23 頁），完成環繞音效的設定。

關於揚聲器擺設的其他注意事項

- 將主要前左右揚聲器安裝在與電視機等距之處。
- 使用標準環繞設定時，請將環繞揚聲器安裝在稍微高於耳朵的位置以得到最佳效果。
- 使用前環繞設定時，使左側與右側揚聲器距離約 1.5 m 以得到最佳效果。

安全須知：

- 請勿將揚聲器放置於不穩定的平面上，這樣可能導致揚聲器傾倒，造成揚聲器損壞或人員受傷。
- 本系統隨附的所有揚聲器都是防磁揚聲器。然而，視安裝位置不同，若揚聲器安裝位置過於接近電視機螢幕，則可能會發生色彩失真的情況。若發生此情況，請先關閉電視機電源，15 分鐘至 30 分鐘後再重新開機。若情況仍未改善，請將揚聲器系統遠離電視機。
- 為安全起見，請確定揚聲器端子外沒有任何未包覆的揚聲器電線。
- 請勿將隨附的揚聲器連接其他擴大器。否則可能造成故障或引起火災。
- 請勿連接此系統外的其他揚聲器。
- 揚聲器系統護網蓋無法取下。請勿試圖強行取下它，否則可能導致護網蓋損壞。
- 請使用隨附的清潔布清潔音箱。請勿讓酒精、稀釋劑、甲苯或殺蟲劑接觸到本機表面，否則表面可能會變色。此外，使用沾有化學藥劑的清潔布時，請小心遵守其注意事項。

第 2 章 接線

接收重低音揚聲器

側面板

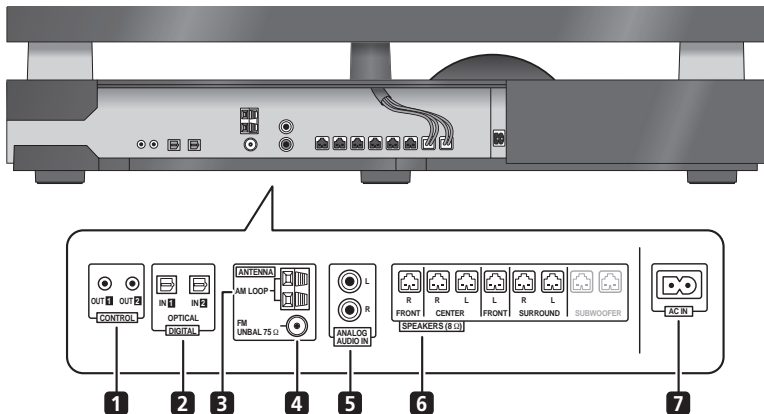

- 側面板的接頭上有蓋子。
 - 接線時，拉起鉤子，然後取下蓋子。
 - 完成接線時，對準三個位置，然後將蓋子放回原始位置。

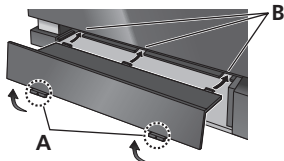

1 CONTROL OUT 插孔 (x2)

使用隨附的控制連接線連接其他先鋒設備。

2 DIGITAL OPTICAL IN 插孔 (x2)

要收聽光學數位音效，請將輸入變更為 **Digital 1** 或 **Digital 2**。

當您的電視機的數位輸出插孔連接到這些插孔時，設定「TV Input」（請參閱第 39 頁）。

3 AM LOOP 天線端子

4 FM 天線插座

5 ANALOG AUDIO IN 插孔

使用立體聲音效代碼處理來自外部設備的聲音。若要收聽類比音效，請將輸入變更為 **Analog**。

當您的電視機的類比輸出插孔連接到這些插孔時，設定「TV Input」（請參閱第 39 頁）。

6 SPEAKERS 端子

比對揚聲器連接線的顏色與各自的接頭顏色。

7 AC IN - 電源插孔

後面板

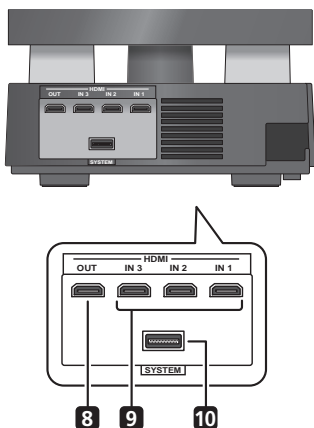
**8 HDMI OUT 接頭**

連接至有 HDMI 端子的電視機。

9 HDMI IN 接頭 (x3)

使用高品質音訊／視訊連接方式連接相容的 HDMI 裝置。

若要選擇此輸入，請選擇 **HDMI 1** 至 **HDMI 3**。

10 SYSTEM 接頭

連接至顯示裝置。

顯示裝置背面

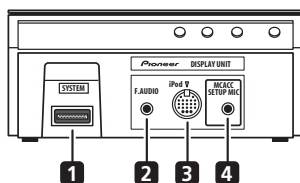
**1 SYSTEM 接頭**

連接至接收重低音揚聲器

2 F.AUDIO 輸入插孔

若要聆聽來自外部設備的音效，請使用立體聲迷你插頭連接線連接。連接後，輸入自動變更為 **Front Audio In**。

3 iPod 輸入端子

用於連接您的 Apple iPod 做為音源。

連接 iPod 時，輸入自動變更為 **iPod**。

4 MCACC SETUP MIC 插孔

用於連接供自動 MCACC 設定使用的隨附麥克風（請參閱第 23 頁）。

基本連接

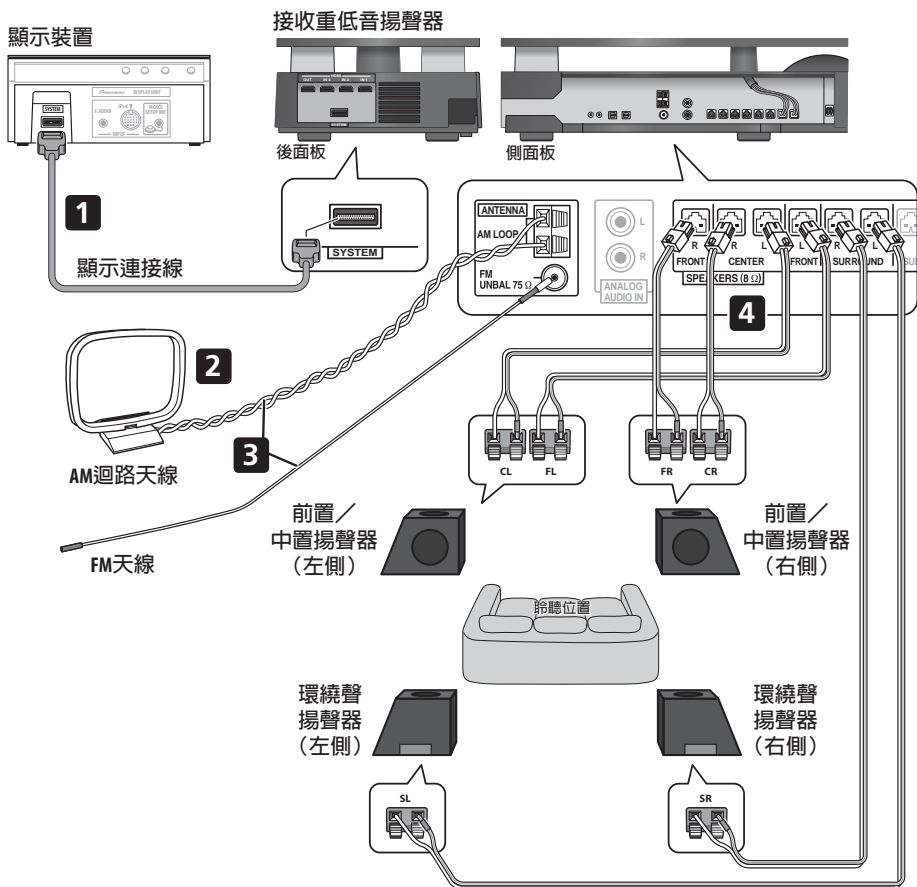

重要

- 對此系統進行接線或變更接線時，請務必關閉電源，並將電源線插頭自牆上電源插座上拔除。完成所有接線後，再將電源線插頭接上電源插座。

警告

- 先鋒對於任何因錯誤組裝或安裝、牆壁固定強度不足、固定裝備（或其他建材）、不當使用或天災所造成之意外，概不負責。

1 連接顯示裝置與接收重低音揚聲器。

將顯示幕連接線插入顯示裝置後方的接頭，然後將顯示幕連接線的另一端插入接收重低音揚聲器的 **SYSTEM** 接頭。



注意

- 請勿嘗試將顯示裝置安裝在牆上。

2 組裝 AM 迴路天線。

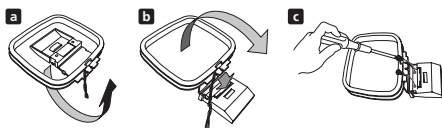

- 依箭頭指示方向彎曲支架。
- 將迴路天線夾在支架上。
- 若要固定在牆壁或其他表面上，先以螺絲固定支架後，再執行步驟 b。

我們建議您以螺絲固定支架前，先確認接收強度。

3 連接 AM 和 FM 天線¹。

- 將 AM 迴路天線的其中一條電線連接到每個 AM 天線端子上²。

按下卡舌便可開啓端子，開啓後插入電線，鬆開卡舌便可將電線夾住固定。

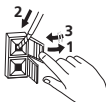

- 將 FM 天線³ 插頭推入 FM 天線插槽的中央接腳。

4 連接所有揚聲器。

- 每個揚聲器連接線的其中一端都有含顏色代碼的接頭，另一端則有兩條電線。



- 扭開並拉出每個電線的保護層。



- 將電線連接至揚聲器上。使用後表面型號標籤上提供的顏色代碼指示可以識別圖中的每一個揚聲器。比對顏色代碼線與型號標籤上顏色指示，然後將顏色代碼線插入紅色 (+) 端，另一條線插入黑色 (-) 端。

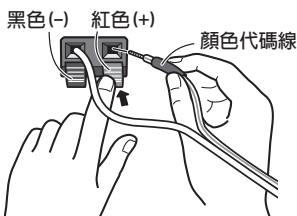

- 將另一端接上接收重低音揚聲器側面有顏色代碼的揚聲器端子。請確定將電線完全插入。請小心插入揚聲器插頭，因此在插入其中一個端子時必須朝正確方向插入。請確定接線正確。

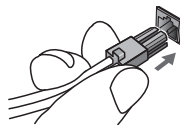

附註

- 請將天線遠離其他連接線、顯示裝置以及接收重低音揚聲器。
 - 若隨附天線的接收訊號不良，請參閱第 28 頁上的改善 FM 接收不良以及改善 AM 音效不佳，或第 35 頁上的連接外接天線。
 - 不可安裝隨附的迴路天線以外的天線，或如第 35 頁所述的外接天線。
- 請勿使天線接觸金屬物體，並避免將其安置在電腦、電視機或其他電器用品附近。
 - 若無線電收訊不良，可重新將每個天線電線裝至相反的端子以求改善。
 - 為達最佳收訊，請勿將 AM 迴路天線電線朝反方向扭開，或將其繞在迴路天線周圍。
- 為確保最佳收訊，請確定 FM 天線完全展開，且未纏繞或懸掛於裝置後方。

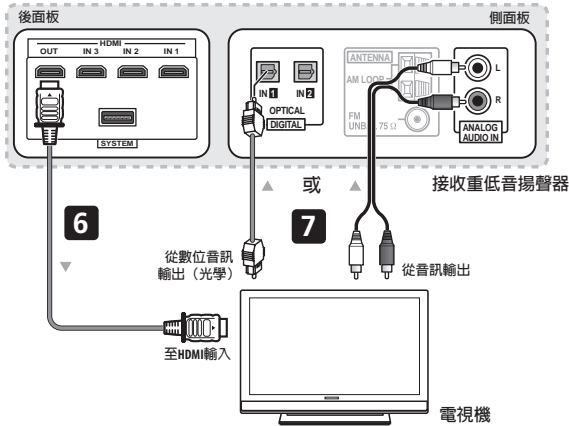

注意

- 這些揚聲器端子均帶有**危險電壓**。為避免在連接或脫離揚聲器線時發生電擊危險，在觸摸任何未絕緣部分之前，請先將電源線插頭拔離。
- 請勿連接此系統外的其他揚聲器。
- 請勿將隨附的揚聲器連接此系統以外的擴大器。若連接其他擴大器可能導致故障或引起火災。
- 連接插頭後，輕輕拉動連接線，以確定連接線的線端已經與端子牢牢地連接。連接不良可能產生噪音並造成聲音中斷。
- 如果纜線的芯線意外被拉出端子外並導致芯線互相接觸，將會對放大器產生過量的額外負載。這樣可能造成成放大器停止作用，甚至損壞放大器。

5 若有其他要連接的 DVD 播放器或影音來源¹設備，請先進行連接，稍後再插上電源。
關於連接數位來源設備的方式，請參閱第 33 頁。

6 將重低音揚聲器連接至電視機。

- 將接收重低音揚聲器的 HDMI OUT 插孔連接至電視機的 HDMI 輸入插孔。

7 將電視機的音訊連接線連接至接收重低音揚聲器。

- 若要使用本機聆聽電視機的聲音，您必須將電視機的音訊輸出插孔連接至本機的音訊輸入插孔。您可以使用數位（光學）或類比音訊連接線連接。如要聆聽數位音效，請連接至接收重低音揚聲器上的 **DIGITAL OPTICAL IN 1**。若要在連接至支援的先鋒電漿電視時使用 HDMI Control 功能，您必須透過 HDMI 連接。
- 您必須先設定「TV Input」以切換來自電漿電視（具有 HDMI Control 功能）的音訊，或將本機的輸入來源切換至電視機音訊，然後使用隨附的遙控器操作您的電視機。如需詳細資訊，請參閱第 17 頁上的**操作先鋒電漿電視和一般電視機**和第 39 頁上的**電漿電視的音訊輸入設定 (TV 輸入)**。

8 接上電源線²

- 將電源線連接至接收重低音揚聲器的 AC 電源插孔。依下列順序將每條電源線連接至牆上電源插座。
 - 接收重低音揚聲器
 - 電視機
- 將連接至接收重低音揚聲器側面板的電源線繞過本機背面，然後更換側面板的蓋子。

附註

- 請務必連接電視機或顯示器（若有視訊來源），以便發揮此系統的家庭劇院功能。請參閱電視機或顯示器隨附的操作手冊，以了解連接的詳細資訊。
- 請勿使用本系統隨附以外的其他電源線。
 - 除連接本系統外，請勿將隨附的電源線作為其他用途使用。
 - 將本機連接至 AC 電源插座後，開始 15 秒的初始化程序。初始化期間不可以執行任何操作。顯示裝置上的 HDMI 指示燈在初始化期間閃爍，您可以在此 HDMI 指示燈一停止閃爍時即開啓本機電源。

第 3 章

控制與顯示

顯示裝置

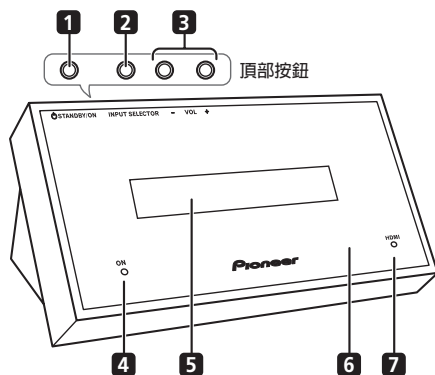

1 STANDBY/ON

按下可開啓接收重低音揚聲器電源或切換至待機狀態。

2 INPUT SELECTOR (第 33 頁)

反覆按下可選擇其中一個外部音訊輸入插孔 (HDMI 1 至 HDMI 3、Digital 1、Digital 2、Analog、iPod 或 Front Audio In)。

3 VOL +/- 按鍵

用於調整音量。

4 POWER ON 指示燈 (藍色)

5 前面板顯示

詳情請參閱第 14 頁。

6 紅外線遙控感應器 (第 22 頁)

7 HDMI 指示燈 (紅色)

當此接收重低音揚聲器連接至 HDMI (HDCP) 相容設備時指示燈會亮起。

在將本機電源插頭插入 AC 電源插座後的初始化期間指示燈也會亮起。

顯示幕

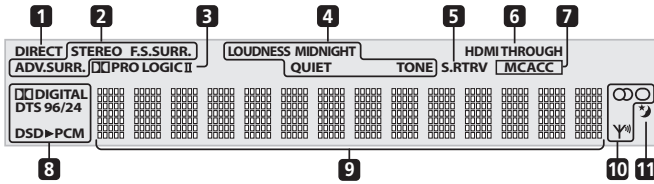
**1 DIRECT**

選擇直接聲音時（即關閉有效聲音時）指示燈會亮起（第 24 頁）。

2 聆聽模式指示燈**STEREO**

選擇立體聲模式或在「自動聆聽」模式中播放立體聲音源時指示燈會亮起（第 26 頁）。

F.S.SURR.

選擇其中一種前場前環繞聲聆聽模式時指示燈會亮起（第 26 頁）。

ADV.SURR.

選擇其中一種先進環繞聲聆聽模式時指示燈會亮起（第 25 頁）。

3 PRO LOGIC II

在 Dolby Pro Logic II 解碼時指示燈會亮起（第 25 頁）。

4 聲音處理指示燈

在選擇「響度」、「午夜」、「寂靜」或音調控制功能時指示燈會亮起（第 27 頁）。

5 S.RTRV

聲音修正器啟動時指示燈會亮起（第 26 頁）。

6 HDMI THROUGH

HDMI Mode 設定為 Through Mode 時指示燈會亮起。

7 MCACC

MCACC 特效開啓時指示燈會亮起（第 27 頁）。

自動 MCACC 設定期間會閃爍（第 23 頁）。

8 數位格式指示燈**DIGITAL**

播放 Dolby Digital 來源時指示燈會亮起（第 24 頁）。

DTS

播放 DTS 來源時指示燈會亮起（第 24 頁）。

DTS 96/24

播放 DTS 96/24 解碼時指示燈會亮起（第 24 頁）。

DSD > PCM

以 SACD 將 DSD（Direct Stream Digital，直接流數位）轉換為 PCM 時指示燈會亮起。

PCM

播放 PCM 訊號時指示燈會亮起。

9 字元顯示幕**10 調諧器指示燈**

接收廣播時指示燈會亮起。



在自動立體聲模式中接收立體聲 FM 廣播時指示燈會亮起。



選擇 FM 單聲道接收時指示燈會亮起。

11

睡眠定時器啟動時指示燈會亮起（第 40 頁）。

遙控器

- 如需使用遙控器的詳細資訊，請參閱第 22 頁上的操作遙控器。

操作接收重低音揚聲器

本節說明如何操作接收重低音揚聲器的遙控器。請注意，當您為各個連接的裝置選擇輸入功能時，控制按鍵會有所不同。

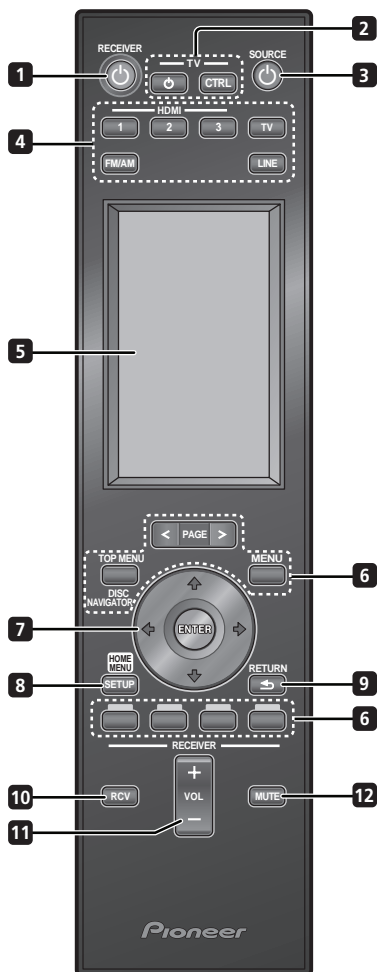

1 接收機

將接收重低音揚聲器切換至「開啓/待機」。

2 TV

將電視機電源切換至「開啓/待機」。

TV CTRL

將遙控器切換至電視機操作模式（不會影響本機的目前輸入來源）。

3 SOURCE

將所選擇設備的電源切換至「開啓/待機」（第 22 頁）。

4 輸入選擇按鍵

變更本機的輸入。使用本遙控器操作另一個連接設備時，必須按下這些按鍵的其中之一。

HDMI 1 至 HDMI 3

將輸入從 HDMI 1 切換至 HDMI 3。

TV

切換至在電視機輸入設定選擇的輸入（第 39 頁）。

FM/AM（第 28 頁）

切換 FM 和 AM 波段。

LINE（第 34 頁）

反覆按下可選擇其中一個接收重低音揚聲器的音訊輸入（Digital 1、Digital 2、Analog、iPod 或 Front Audio In）。

5 液晶觸控畫面

顯示用於控制接收重低音揚聲器、電漿電視、DVD 播放器、Blu-ray Disc 播放機和硬碟/DVD 錄影機等外部設備的按鍵。目前的操作模式顯示在遙控器螢幕的最上方。雖然液晶觸控畫面在一段時間未執行任何操作後會消失，但只要碰觸螢幕或按下遙控器上的按鍵時，它就會出現。

6 其他設備按鍵

用於操作硬碟/DVD 錄影機或其他連接的設備。

7 上/下/左/右（游標按鍵）和 ENTER

用於控制接收重低音揚聲器功能。

8 SETUP

用於存取環繞聲設定、調諧器設定等的選單系統（第 28、30、38、40 頁）。

9 RETURN

用於取消設定。

10 RCVR

用於當本機在其他操作模式時切換至接收重低音揚聲器。再按一次可返回之前的操作模式。

11 VOL +/-

用於調整接收重低音揚聲器的音量。

12 MUTE

靜音或恢復播放已靜音的聲音（調整音量也使聲音恢復播放）。

液晶觸控畫面

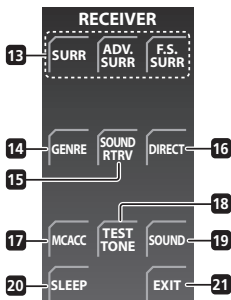
**13 SURR**

用於選擇環繞聲模式（第 24 頁）。

ADV.SURR

用於將音訊設定變更為先鋒原始的先進環繞聲模式（第 25 頁）。

F.S.SURR

用於選擇前場前環繞聲模式（第 26 頁）。

14 GENRE

用於在「類型同步化」模式中聆聽音效（第 26 頁）。
（此按鍵僅在操作硬碟 /DVD 錄影機期間出現 RECEIVER 畫面時顯示。）

15 SOUND RTRV

按下可將 CD 品質音效恢復成壓縮的音效來源（第 26 頁）。

16 DIRECT

用於開啓／關閉有效聲音模式（第 24 頁）。

17 MCACC

開始自動 MCACC 設定（第 23 頁）。

18 TEST TONE

用於輸出測試音（以便進行揚聲器設定）（第 32 頁）。

19 SOUND

按下可進入音效選單，進而調整低音與高音等。

20 SLEEP

按下可設定睡眠定時器（第 40 頁）。

21 EXIT

取消設定並退出 RECEIVER 畫面。

操作內建的 FM/AM 調諧器

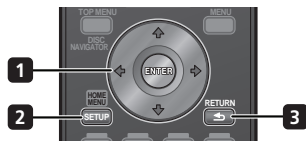

1 ↑/↓/←/→（游標按鍵）和 ENTER
用於控制 FM/AM 調諧器功能。

2 SETUP

用於存取選單系統或調諧器設定。

3 RETURN

用於取消設定。

液晶觸控畫面

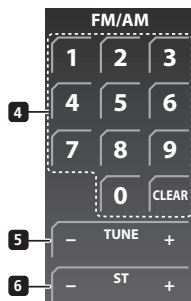
**4 數字按鍵**

用於直接選擇預設廣播電台。

CLEAR

按下可清除任何輸入的內容並重新輸入。

5 TUNE +/-

用於搜尋電台頻率。

6 ST +/-

用於選擇預設電台。

操作先鋒電漿電視和一般電視機

請先參閱第 40 頁上的 **設定遙控器以控制電視機** 中有關設定電視機預設電台的資訊。請注意，有些按鍵無法搭配某些電視機使用。

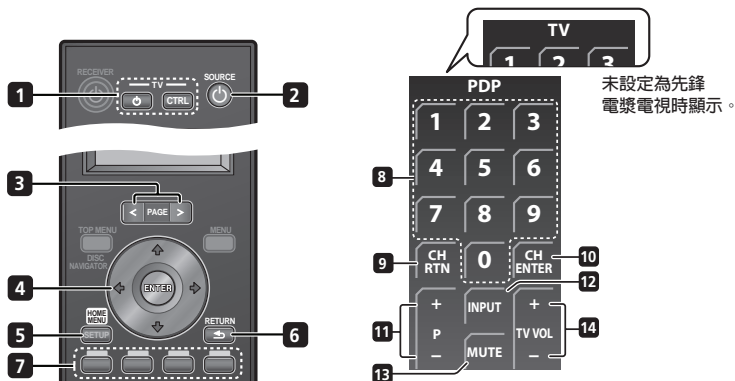

1 TV

將電視機電源切換至「開啓/待機」。

TV CTRL

將遙控器切換至電視機操作模式（不會影響本機的目前輸入來源）。

2 SOURCE

將電視機的電源切換至「開啓/待機」。

3 PAGE </>

切換液晶觸控畫面上的頁面。

4 ↑/↓/←/→（游標按鍵）和 ENTER

用於導覽所有螢幕功能選單。按下 **ENTER** 選擇目前反白的選項。

5 HOME MENU

顯示 HOME MENU 畫面。

6 RETURN

回到前一個選單畫面。

7 彩色（紅/綠/黃/藍）按鍵

選擇頁面。

液晶觸控畫面

8 數字按鍵

選擇頻道。

9 CH RTN

回到前一個選擇的頻道。

10 CH ENTER

播放所選擇的頻道號碼。

11 P +/-

選擇頻道。

12 INPUT

選擇電視機的輸入來源。

13 MUTE

靜音。

14 TV VOL +/-

設定音量。

操作先鋒 Blu-ray Disc 播放機

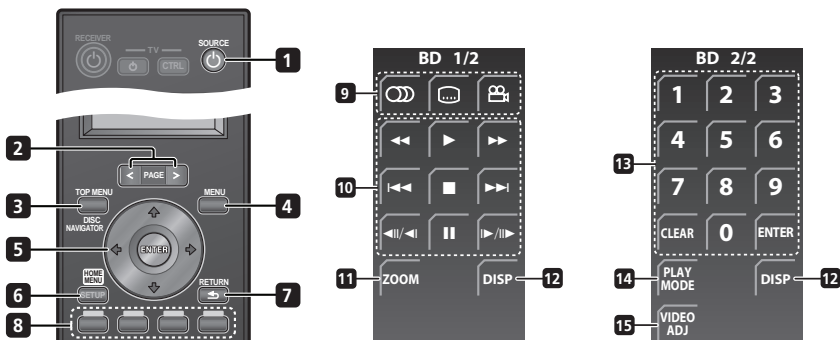
**1** **SOURCE**

將 Blu-ray Disc 播放機的電源切換至「開啓/待機」。

2 **PAGE </>**

液晶觸控畫面顯示多個頁面時，切換頁面。

3 **TOP MENU / DISC NAVIGATOR**

按下可顯示 BD-ROM 或 DVD-Video 碟片的最上層選單。
播放 DVD-R/RW 時，按下可顯示/退出「碟片導向」。

4 **MENU**

BD-ROM：按下可顯示/隱藏彈出式選單。
DVD-Video：按下可顯示碟片選單（如果有）。

5 **↑/↓/←/→（游標按鍵）和 ENTER**

用於導覽螢幕功能和選單。按下 **ENTER** 選擇選項或執行指令。

6 **HOME MENU**

按下可顯示播放器的 Home Menu，進入 Home Menu 可使用大部分的播放器功能。

7 **RETURN**

按下可回到前一個畫面。

8 **彩色（紅/綠/黃/藍）按鍵**

用於導覽 BD-ROM 選單。

液晶觸控畫面**9** **AUDIO**

按下可選擇聲道或語言。

SUBTITLE

按下可選擇字幕的顯示。

ANGLE

播放 BD-ROM 或 DVD-Video 影片的多角度場景時，
按下可變更拍攝角度。

10 **播放控制按鍵**

▶ 按下可開始或繼續播放。

■ 按下可停止播放（您可以按 ▶ 繼續播放）。

⏸ 按下可暫停播放，再按一次即可重新開始播放。

◀▶ 按下可開始倒退/快轉掃描。

◀◀▶▶ 按下可跳到上一個/下一個章節/曲目。

◀◀/▶▶ 用於慢動作格階梯式格放。

11 **ZOOM**

按下可在播放靜態影像時縮放畫面。

12 **DISP**

按下可顯示資訊。

13 **數字按鍵**

用於輸入標題、章節或曲目編號等。

ENTER

按下可選擇選項或執行指令。

CLEAR

按下可清除輸入的數字等。

14 **PLAY MODE**

按下可切換播放模式（例如重播）。

15 **VIDEO ADJ**

按下可顯示「調整視訊」畫面。

操作先鋒 DVD 播放器

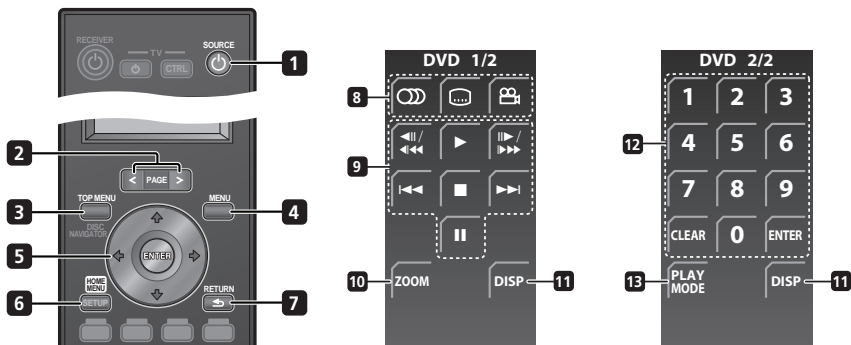

1 SOURCE

將 DVD 播放器的電源切換至「開啓/待機」。

2 PAGE </>

液晶觸控畫面顯示多個頁面時，切換頁面。

3 TOP MENU

按下可顯示 DVD-Video 碟片的最上層選單。

4 MENU

顯示 DVD 碟片選單—本功能視碟片而異，而且可能顯示相同的「最上層選單」。

5 ↑/↓/←/→ (游標按鍵) 和 ENTER

在螢幕四周移動游標。按下 ENTER 選擇目前的選單選項。

6 HOME MENU

顯示/退出螢幕功能選單。

7 RETURN

回到前一個顯示的選單畫面。

液晶觸控畫面

8 (AUDIO)

按下可選擇聲道或語言。

(SUBTITLE)

按下可選擇字幕的顯示。

(ANGLE)

播放 DVD-Video 影片的多角度場景時，按下可變更拍攝角度。

9 播放控制按鍵

▶
按下可開始或繼續播放。

■
按下可停止播放 (您可以按 ▶ 繼續播放)。

||
按下可暫停播放，再按一次即可重新開始播放。

◀||/◀|◀◀, ||/▶|▶▶
按下可開始倒退或快轉掃描。再按一次可變更速度。

暫停時，按住可開始慢動作播放。反覆按可以變更播放速度。

暫停時，按下可往前或往後移動一格。

◀◀/▶▶

按下可跳到上一個或下一個標題/章節/曲目/資料夾，或顯示上一個或下一個選單頁面。

10 ZOOM

按下可在播放靜態影像時縮放畫面。

11 DISP

按下可顯示資訊。

12 數字按鍵

用於輸入標題、章節或曲目編號等。

ENTER

按下可選擇選項或執行指令。

CLEAR

按下可清除輸入的數字等。

13 PLAY MODE

按下可切換播放模式 (例如重播)。

操作先鋒硬碟 / DVD 錄影機

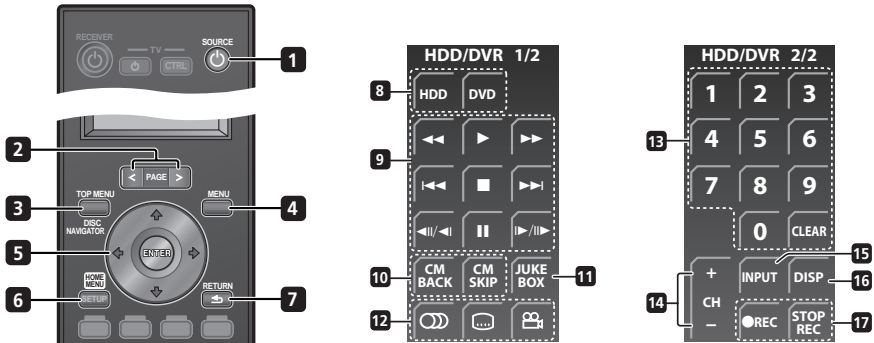
**1** SOURCE

將硬碟 / DVD 錄影機的電源切換至「開啓／待機」。

2 PAGE </>

液晶觸控畫面顯示多個頁面時，切換頁面。

3 TOP MENU / DISC NAVIGATOR

如果已載入 DVD-Video 或最終化的 DVD-R/RW (視訊) 碟片，按下可顯示最上層選單或「碟片導向」畫面。

4 MENU

如果已載入 DVD-Video、最終化的 DVD-R/RW 或最終化的 DVD+R/RW 碟片，按下可顯示最上層選單。

5 ↑/↓/←/→ (游標按鍵) 和 ENTER

用於導覽所有螢幕功能選單。按下 **ENTER** 選擇目前反白的選項。

6 HOME MENU

按下可顯示 Home Menu，您可以在其中導覽錄影機的所有功能。

7 RETURN

按下可返回上一層的螢幕功能選單或顯示畫面。

液晶觸控畫面

8 HDD

按下可選擇用於錄製和播放的硬碟。

DVD

按下可選擇用於錄製和播放的 DVD。

9 播放控制按鍵

▶
按下可開始播放。

■
按下可停止播放。

||
按下可停止播放或錄製。

◀◀/▶▶
按下可開始倒退或快轉掃描。再按一次可變更速度。

|◀◀/▶▶|
按下可跳到上一個或下一個標題／章節／曲目／資料夾，或顯示上一個或下一個選單頁面。

◀||/||▶, ||▶/▶||
暫停時，按佳可開始慢動作播放。反覆按可以變更播放速度。

暫停時，按下可往前或往後移動一格。

10 CM BACK (返回廣告)

反覆按下可逐漸往後跳經視訊播放過程。

CM SKIP (略過廣告)

反覆按下可逐漸往前跳經視訊播放過程。

11 JUKEBOX

按下可顯示硬碟 /DVD 錄影機的點唱機畫面，在此畫面中可以将要播放的音樂複製到硬碟中。

12 (AUDIO)

按下可變更聲音語言或聲道。（停止錄影機時，按下可變更調諧器音效。）

(SUBTITLE)

按下可顯示／變更多語 DVD-Video 碟片中內建的字幕。

(ANGLE)

按下可切換有多角度場景的碟片之拍攝角度。

13 數字按鍵

使用數字按鍵選擇曲目／章節／標題或選擇頻道等。

CLEAR

按下可清除任何輸入的內容並重新輸入。

14 CH +/-

按下可變更內建電視調諧器的頻道。

15 INPUT

按下可變更用於錄製的硬碟 /DVD 錄影機輸入。

16 DISP

顯示／變更顯示的螢幕功能資訊。

17 錄製控制按鍵

● REC

按下可開始錄製。反覆按可以 30 分鐘為區段來設定錄製時間。

STOP REC

按下可停止錄製。

裝入遙控器電池

- 1 打開遙控器背面的電池槽蓋。
- 2 請依照電池槽內的極性指示（ \oplus ， \ominus ），將兩顆 AA/LR6 鹼性電池放入電池槽中。

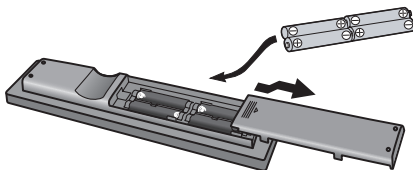

- 3 關上電池蓋。

注意

使用錯誤的電池可能引起危險，如漏液及爆炸。請遵守以下事項：

- 請勿混合新舊電池使用。
- 請勿混合不同的電池使用 — 雖然外觀類似，但不同的電池可能含不同的電壓。
- 請確定電池的正負兩端與電池槽中的指示相符。
- 若設備不使用的時間超過一個月，請取出電池。
- 處理廢舊電池時，請遵守政府條例或適用於貴國或地區的環境公共指令規則。

警告

- 請勿在陽光直射或其他過熱的地方使用或存放電池，如車內或暖爐旁。否則電池可能漏液、爆炸或起火。同時也會縮短電池的壽命或效能。

使用遙控器

使用遙控器時，請務必記住下列事項：

- 請確定遙控器與裝置上的遙控感應器間無阻礙物。
- 若有強光或螢光燈照射在裝置的遙控感應器上，則可能無法使用遙控操作。
- 不同裝置的遙控器可能會互相干擾。請避免在此裝置附近使用其他設備的遙控器。
- 若發現遙控器在操作範圍內無法操作時，請更換電池。
- 請如下圖所示，在顯示裝置的遙控感應器操作範圍前方使用遙控器。

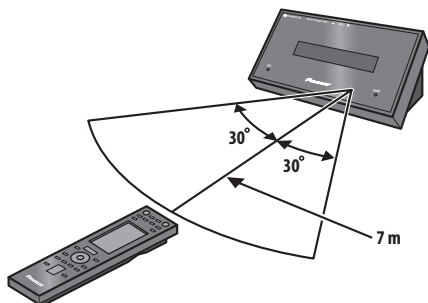

操作遙控器

隨附的遙控器除了能控制接收重低音揚聲器外，還可以控制先鋒的電漿電視、DVD 播放器、Blu-ray Disc 播放機和硬碟 / DVD 錄影機等其他產品。

若要操作這些設備，請將遙控器指向顯示裝置。

操作接收重低音揚聲器

- RCV** 按下可顯示 RECEIVER 畫面。
- RECEIVER 畫面顯示在遙控器的液晶螢幕上，而且遙控器切換至「接收」模式。



選擇與操作來源設備



1 按下可切換連接的設備。

所選擇的設備改變，而且遙控器的液晶螢幕變成該適用設備的控制畫面。

- 若要選擇用於 **Digital 1**、**Digital 2**、**Analog**、**Front Audio In** 或 **iPod** 的輸入，請按 **LINE** 按鍵，直到所需的輸入功能顯示在顯示裝置上為止。

2 選擇 HDMI 1 至 HDMI 3 或 LINE 時，選取您正在使用的輸入來源。

液晶螢幕變成所選擇設備的控制畫面，然後您可以操作所需的設備。

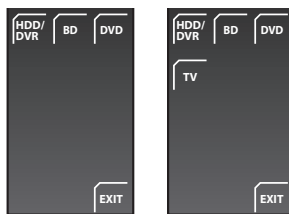

- 找不到所需的音源，或連接不是先鋒製造的設備時，按下 **RCV** 讓遙控器進入「接收」模式。本機的輸入保持不變。

備註

若要在透過本機聆聽來自連接設備的音效時暫時控制接收，請按 **RCV**。所選擇的輸入不會改變，但遙控器變更為「接收」模式。若要返回前一個操作模式，請再按一次 **RCV**。

使用液晶觸控畫面

液晶觸控畫面是否有多個資訊頁面視您操作的連接設備類型（例如 DVD 播放器）而定。您要控制的設備未顯示時，按 **PAGE** 捲動至您要控制的設備所在的頁面。

- 超過 10 秒沒有執行任何操作時，顯示在遙控器上的液晶觸控畫面會自動關閉。若要使此畫面再次顯示，請觸碰遙控器的液晶螢幕或按任何按鍵。

第 4 章 開始操作

重要

- **RCV** 按下可將遙控器設定為操作接收重低音揚聲器的接收控制模式（確定液晶螢幕顯示以下所示的 RECEIVER 畫面）。



使用「自動 MCACC」設定以達最佳環繞音效

多聲道音場自動補正（MCACC）系統可測量聆聽區域內的音場特性，將週遭環境的雜音納入考量，並測試聲道延遲與聲道音量。完成系統附贈的麥克風設定後，系統將會利用一系列的測試音資訊測量駐波與迴響，使特定房間內的揚聲器設定值與等化效果（MCACC 效果）達最佳化。¹

重要

- 用於自動 MCACC 設定的測試音音量極大，但請勿在設定期間將音量轉小，否則可能無法達到最佳設定狀態。
- 請勿在 MCACC 設定期間移動麥克風與揚聲器。

1 將麥克風連接至顯示裝置背面的 MCACC SETUP MIC 插孔。

2 請將麥克風置於正常的聆聽位置。請放在耳朵高度，並使用桌椅確保麥克風保持水平位置。

請確定麥克風與揚聲器間無障礙物。

3  若接收重低音揚聲器關閉，按下 **RECEIVER** 將其電源開啓。

4  按下 MCACC。

按下 **MCACC** 後，請盡可能保持安靜。音量將會自動變大，系統會輸出一連串的測試音。

- 若要在完成前取消自動 MCACC 設定，按下 **MCACC**。裝置將會繼續使用之前的設定值。
- 若週遭的雜音過多，**Noisy!**（雜音太大）將會在顯示幕中持續閃爍五秒。若要結束並檢查雜音等級²，按下 **MCACC** 或再試一次，顯示幕中顯示 **Retry** 時，按下 **ENTER**。
- 若顯示幕中出現 **Error MIC!**（麥克風發生錯誤！）或 **Error Speaker!**（揚聲器發生錯誤！）訊息，則表示麥克風或揚聲器的連接可能出現問題。若要重試，請按下 **ENTER**³。

MCACC 設定完成後，音量將會恢復為正常音量，顯示幕中出現 **Complete**⁴ 並啓動音場自動補正等化功能。⁵

- 完成「自動 MCACC」設定時，務必將麥克風從本機上拔下。

附註

- 1 您只需進行一次自動 MCACC 設定（除非您變更揚聲器擺設或房間佈置）。
- 2 若房間的環境不適合進行最佳的自動 MCACC 設定（週遭雜音過多、牆壁迴音、含阻礙揚聲器與麥克風的物體），則最後的設定值可能會發生錯誤。請檢查可能影響室內環境的家電用品（冷氣機、冰箱、電扇等），如有必要，請關閉其電源。
 - 部分舊型的電視機可能會與麥克風互相產生干擾。若發生此情形，請在自動 MCACC 設定期間關閉電視機。
- 3 若仍無法解決問題，按下 **MCACC**、關閉電源，並根據 **Error** 訊息檢查問題，然後重試自動 MCACC 設定。
- 4 若未顯示 **Complete**，很可能在設定期間發生錯誤。請檢查所有接線並再試一次。
- 5 請參閱第 27 頁上的以 MCACC 效果聆聽以開啓/關閉 MCACC 效果。

第 5 章

聆聽您的系統輸出的音效

重要

- **RCV** 按下可將遙控器設定為操作接收重低音揚聲器的接收控制模式（確定液晶螢幕顯示以下所示的 **RECEIVER** 畫面）。



有效聲音（適用於最佳聲音）

有效聲音模式藉由本機提供的特殊形狀高品質揚聲器，帶來下列針對極致的影片與音樂原音體驗而設計的先鋒獨家專有效音技術。

在一般情況下開啓有效聲音模式，使本機發揮最大的功能。

- **對話增強**
影片中的清晰對話，與背景聲音相較之下更顯突出。
- **動態範圍壓縮**
重現易受周遭雜音影響的細部聲音，建立讓您感覺身歷其境的聲音環境。
- **原始聲道平衡與聲道混合**
由於隨附揚聲器的方向經過特別設計，因此以特殊方式縮混和平衡聲道。此外，本機也根據播放的內容達到最佳平衡。
- **頻率特性修正**
除了隨附揚聲器的新增功能外，實現為了長時間聆聽而最佳化的播放特性。

• 以環繞聲播放的立體聲

由前聲道輸出人聲時，從環繞聲揚聲器輸出音效。您可以播放例如 CD 等無縫、舒適的環繞立體聲音源。在自動聆聽模式中播放立體聲音源時，可使用此效果（請參閱下列說明）。

依下列操作可以關閉有效聲音模式（啓動直接模式）：

- **DIRECT** 按下可切換至「直接聲音」。
- 按下此按鍵切換「有效聲音」和「直接聲音」。
- 選擇「直接聲音」時，**DIRECT** 指示燈亮起。

自動聆聽模式

自動聆聽模式是聆聽系統控制任何來源的最簡單方式：揚聲器的輸出會反映出來源資料的聲道。

若您將系統設定為前環繞聲（第 6 頁），則前場前環繞聲模式將會提供最佳的輸出結果（請參閱第 26 頁）。

- **SURR** 按下可選擇 **Auto** 聆聽模式。

以環繞音效聆聽

您可以在環繞音效下，聆聽立體聲或多聲道來源。環繞音效是以取自使用其中一種 Dolby Pro Logic 或 DTS Neo:6 解碼模式的立體聲音源所產生。¹

若您將系統設定為前環繞聲（第 6 頁），則前場前環繞聲模式將會提供最佳的輸出結果（請參閱第 26 頁）。

- **SURR** 反覆按下可選擇任一聆聽模式。
- 顯示幕中出現的選項視播放的來源類型而有所不同。²

附註

¹ 在適當解碼由 DTS-ES 呈現的 6.1/7.1 聲道音效後環繞聲訊號後，原始虛擬後環繞功能輸出結合環繞聲訊號的後環繞聲訊號。

² 播放 DTS-HD、DTS-Express 或 Dolby TrueHD（176.4 kHz/192 kHz）時，無法選擇自動和立體聲以外的模式。此外，您無法選擇使用於 Dolby Digital Plus 或 Dolby TrueHD（低於 96 kHz）的 DTS Neo:6。

聆聽您的系統輸出的音效

搭配雙聲道來源時，您可以選擇：

- **Auto** — 自動聆聽模式（請參閱第 24 頁）
- **Dolby II Movie** (Dolby Pro Logic II Movie) — 5.1 聲道環繞音效，特別適合影片來源
- **Dolby II Music** (Dolby Pro Logic II Music) — 5.1 聲道環繞音效，特別適合音樂來源，請參閱下文的 *Dolby Pro Logic II Music 設定值*
- **Dolby II Game** (Dolby Pro Logic II Game) — 5.1 聲道環繞音效，特別適合電視遊戲
- **Pro Logic** (Dolby Pro Logic) — 4.1 聲道環繞音效，適用於雙聲道來源
- **Neo:6 Cinema** — 6.1 聲道來源，特別適合影片來源
- **Neo:6 Music** — 6.1 聲道音效，特別適合音樂片來源，請參閱下文的 *中央影像設定*
- **Stereo** — 請參閱第 26 頁上的 *以立體聲聆聽*

搭配多聲道音源時，您可以選擇（依格式）：

- **Auto** — 自動聆聽模式（請參閱第 24 頁）
- **StandardDecode** — 以 Dolby Digital 或 DTS 環繞聲解碼聆聽。播放有最標準解碼器的 Dolby Digital、DTS 多聲道 PCM 等多聲道音源。
- **Stereo** — 請參閱第 26 頁上的 *以立體聲聆聽*

Dolby Pro Logic II Music 設定值

以 Dolby Pro Logic II Music 模式（如上述）聆聽時，您可調整三種設定值：中置寬度、尺寸及全景。

- 1  在啓用 **Dolby Pro Logic II Music** 模式時按下。

- 2  選擇「Center Width」、「Dimension」或「Panorama」，然後按下 **ENTER**。

- **Center Width**¹ — 提升前置揚聲器的混音效果，將右前與左前揚聲器的中央聲道擴散出來，音域聽起來更廣（較高設定值）或更窄（較低設定值）。
- **Dimension** — 由前而後調整環繞音效平衡的深度，使聲音聽起來更遠（負設定值）或更近（正設定值）。
- **Panorama** — 可將前置立體聲音像延伸，使環繞揚聲器產生更「全面」的音效。

- 3  調整設定值，然後按下 **ENTER** 確認。

中央影像設定

在 Neo:6 Music 模式中聆聽雙聲道音源時（請參閱第 24 頁），您也可以調整中央影像效果。

調整中央影像，以人聲建立更寬廣的立體聲效果。²

- 1  在啓用 **Neo:6 Music** 模式時按下。

- 2  選擇「Center Image」，然後按下 **ENTER**。

- 3  調整設定值，然後按下 **ENTER** 確認。

- 調整從 **0**（所有傳送到右前置與左前置揚聲器的中央聲道）到 **10**（僅傳送到中置揚聲器的中央聲道）的效果。

使用「先進環繞聲」功能

「先進環繞聲」效果適用於任何多聲道或立體聲音源，提供各種多樣的環繞音效。這些模式是以使用第 6 頁上所述的標準環繞設定時提供最佳聆聽效果而設計。

-  按下可選擇「先進環繞聲」模式。選擇其中一個模式時，**ADV.SURR** 指示燈亮起。您無法切換適用於某些音訊流的模式。³

反覆按下可選擇：

- **Action** — 針對有動態音軌的動作片而設計
- **Drama** — 針對有很多對話的影片而設計
- **Sci-Fi** — 針對有很多特效的科幻片而設計
- **Mono Film** — 建立來自單聲道音軌的環繞聲

附註

- 1 由於本產品使用雙重中置揚聲器系統，因此正常來說您應該使用 **C.Width 3** 設定。
- 2 由於本產品使用雙重中置揚聲器系統，因此正常來說您應該使用 **C.Image 3** 設定。
- 3 您無法將此功能使用於下列音訊流：
 - Dolby TrueHD：超過 88.2 kHz
 - DTS-HD：超過 88.2 kHz 或擁有 2/0 的聲道格式
 - DTS-Express：擁有 2/0 的聲道格式

- **Ent.Show** —適用於音樂音源
- **Expanded** —創造特寬的立體聲音場
- **TV Surround** —為單音和立體聲電視來源提供環繞聲
- **Advanced Game** —適用於電視遊戲
- **Sports** —適合用於觀賞體育節目
- **Classical** —提供大型音樂廳的音效
- **Rock/Pop** —創造適合搖滾樂和/或流行樂的現場演奏音效
- **Unplugged** —適用於樂聲音源
- **Ext.Stereo** —使用所有揚聲器為立體聲音源提供多聲道聲音

使用前場前環繞聲模式

如第 6 頁所述使用前環繞揚聲器設定時，可以使用「前場前環繞聲」模式。

-  按下可選擇前場前環繞聲模式。
F.S.SURR 指示燈亮起。

反覆按下可選擇 **Focus 5.1ch**、**Wide 5.1ch** 或 **Extra Power**。您無法為某些音訊流選擇「額外功率」以外的模式。¹

- **Focus 5.1ch** —用於提供引導到左側與右側揚聲器的聲音投射聚集中央區域的豐富環繞音效。
- **Wide 5.1ch** —用於提供比 **Focus 5.1ch** 模式音域更寬廣的環繞音效。
- **Extra Power** —從環繞揚聲器輸出立體聲（多聲道音源、向下混合立體聲）以提供強大的環繞音效。

以立體聲聆聽

您可以使用立體聲聽取任何來源 — 立體聲或多聲道。播放多聲道來源時，所有聲道經過縮混後傳送到左前置/右前置揚聲器和重低音中。

-  反覆按下，直到顯示幕中出現 **STEREO**。

類型同步化模式

只有在本機連接至 HDMI Control 相容先鋒硬碟 /DVD 錄影機和使用 HDMI Control 功能時，您才能運用類型同步化模式將聆聽模式自動變更為最符合錄影機播放內容之類型的聆聽模式。

- 將 **HDMI Mode** 設定為 **AMP Mode**（第 36 頁）。
-  在聆聽來自錄音器的媒體內容時按下。選擇最適當的聆聽模式並顯示在顯示畫面中。無法判斷相關類型時，可能顯示 **No Genre** 或 **Can't use**，而且聆聽模式維持不變。

提示

- 主要搭配點唱機和 MP3 來源使用。
- 若要使用此功能，您必須有透過 HDMI 連接的 HDMI Control 相容先鋒硬碟 /DVD 錄影機，並且將 HDMI Control 功能設定為「開啓」。

使用「聲音修正器」功能

若在 MP3 或 WMA 壓縮過程中移除音效資料，聲音品質通常會出現不平均的音像。「聲音修正器」功能採用新的 DSP 技術，可藉由還原聲壓及修整壓縮後的人工缺陷，將 CD 的音效品質恢復至壓縮的雙聲道音效。

-  在聆聽立體聲音源時按下²。
反覆按下可在以下兩項功能間進行切換：
 - **Retriever On** — 開啓「聲音修正器」。
 - **Retriever Off** — 關閉「聲音修正器」。

附註

¹ 您無法將此功能使用於下列音訊流：

- Dolby TrueHD：超過 88.2 kHz
- DTS-HD：超過 88.2 kHz 或擁有 2/0 的聲道格式
- DTS-Express：擁有 2/0 的聲道格式

² 此設定無法搭配多聲道音源使用。此外，如果是搭配 SACD、DTS-HD、DTS-Express、Dolby TrueHD、Dolby Digital Plus 和 PCM（192 kHz/176.4 kHz），甚至無法使用立體聲音源。

聆聽您的系統輸出的音效

以 MCACC 效果聆聽

使用以 MCACC 取得的修正音場設定聆聽聲音。

- 1  按下可開啓音效選單。

- 2  選擇「MCACC Effect」，然後按下 ENTER。

- 3  選擇「MCACC On」或「MCACC Off」，然後按下 ENTER 確認。
 - 當 MCACC Effect 關閉時，等化、聲道延遲、聲道位準和駐波也會關閉。
 - MCACC Effect 關閉時，您可以手動控制聲道延遲和聲道位準，MCACC Effect 開啓時，您可以手動個別儲存設定值。
 - 「MCACC 效果」在使用「自動 MCACC 設定」後自動設定為開啓。

使用「午夜」、「響度」及「寂靜」聆聽模式

「午夜」聆聽功能可讓您以低音量收聽實際的環繞音效。使用「響度聆聽」功能可以在低音量時，取得來自音樂音源的良好低音與高音。

「寂靜」聆聽功能可降低音源中過量的低音或高音。

- 1  按下可開啓音效選單。

- 2  選擇「Tone」，然後按下 ENTER。¹

- 3  選擇「Midnight」、「Loudness」或「Quiet」，然後按 ENTER 以確認。²
 - 若要取消「午夜」、「響度」及「寂靜」聆聽模式，請選擇 Bass/Treble。

調整低音及高音

使用低音及高音控制調整整體音調。

- 1  按下可開啓音效選單。

- 2  選擇「Tone」，然後按下 ENTER。¹

- 3  選擇「Bass/Treble」，然後按 ENTER。
 - 選擇 Bass/Treble 以取消「午夜」、「響度」及「寂靜」聆聽模式。您無法同時使用這些模式。

- 4  使用 ←/→ 按鍵，選擇「Bass」或「Treble」。使用 ↑/↓ 按鍵調整音效，然後按 ENTER 確認。
 - 低音和高音的調整範圍在 -6dB 至 +6dB 之間。
 - 低音或高音設定在 0dB 以外時，TONE 指示燈亮起。

調整聲音延遲

有些顯示器在播放視訊時會有稍微的延遲，因此音軌會與畫面稍微沒有同步。新增一點延遲可以調整聲音，使聲音的播放符合畫面的顯示。

您可以調整的間隔（位準）共有 60 個，總範圍是 200 msec。

- 1  按下可開啓音效選單。

- 2  選擇「Sound Delay」，然後按下 ENTER。

- 3  選擇聲音的延遲長度，然後按 ENTER 確認。
 - 如果在 HDMI 設定中將「自動延遲」設定為 On，此選項會關閉且不顯示（請參閱第 39 頁上的設定自動延遲）。

附註

- 1 播放 DTS-HD（超過 88.2 kHz）或 Dolby TrueHD（超過 88.2 kHz）音訊流時，如果已選擇 Bass/Treble 以外的模式，則您無法選擇 Tone。
- 2 播放 DTS-HD（超過 88.2 kHz）或 Dolby TrueHD（超過 88.2 kHz）音訊流時，您無法選擇 Bass/Treble 以外的模式。

第 6 章

收聽廣播

 重要

- **FM/AM** 若要收聽廣播，按下 **FM/AM** 按鍵將遙控器設定為 FM/AM 控制模式。遙控器上的液晶螢幕切換至 FM/AM 畫面。

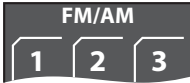

收聽廣播

調諧器可接收 FM 與 AM 廣播，並讓您能將最愛收聽的電台記憶下來，如此便不需在每次收聽時進行手動調選。

- 1 **FM/AM** 切換至調諧器，然後反覆按可選擇 FM 或 AM 波段。
顯示幕會顯示波段及頻率。

- 2 **TUNE +/-** 調選需要的頻率。

共有三種調諧模式可供選擇 – 手動、自動及高速：

- **手動調諧** – 反覆按 **TUNE +/-** 可變更顯示的頻率。
- **自動調諧** – 按住 **TUNE +/-** 直到頻率顯示開始移動後放開。調諧器會停在下一個搜尋到的電台。持續此動作便可繼續搜尋。
- **高速調諧** – 按住 **TUNE +/-** 直到頻率顯示開始快速移動。繼續按住按鍵，直到找到要收聽的頻率為止。必要時，請使用手動調諧微調頻率。

改善 FM 接收不良

若您正以立體聲收聽 FM 電台，但收訊不佳，可切換至單聲道以便改善音效品質。



- 1 **SETUP** 調到 FM 廣播電台後按下。
- 2  選擇「Tuner Setup」，然後按下 **ENTER**。
- 3  選擇「FM Auto/Mono」，然後按下 **ENTER**。
- 4  選擇「FM Mono」，然後按下 **ENTER**。
調諧器處於單聲道接收模式時，單聲道指示燈 (○) 會亮起。
選取上述的 **FM Auto**，便可切換回自動立體聲模式 (接收立體聲廣播時，立體聲指示燈 (⊙) 會亮起)。

改善 AM 音效不佳

改善 AM 收音機音效品質最簡單的方式就是確定房間內的電視機是否關機。您也可以試著改變 AM 迴路天線的位置與方向。

改變雜音抑制模式

進行上述動作後，若仍無法改善 AM 音質，您可使用不同的雜音抑制模式獲得改善。只要選擇聽起來最好的音效即可。

- 1 **SETUP** 調到 AM 廣播電台後按下。
- 2  選擇「Tuner Setup」，然後按下 **ENTER**。
- 3  選擇「Noise Cut」，然後按下 **ENTER**。
- 4  選擇雜訊抑制模式 (1、2 或 3)，然後按下 **ENTER**。

記憶電台

您可以儲存高達 30 個預設電台，如此便可輕鬆收聽喜愛的電台，不必每次進行手動調選。

1 調諧至 FM 或 AM 廣播電台。

視需要選擇單聲道或自動立體聲接收（FM）或雜訊抑制模式（AM）。這些設定值與預設設定一併儲存。

2 按下 SETUP。

3 選擇「Tuner Setup」，然後按下 ENTER。

4 選擇「ST.Memory」，然後按下 ENTER。

5 選擇您要收聽的預設電台，然後按下 ENTER。

收聽預設電台

1 請確定已選取調諧功能。

2 選擇預設電台。

- 或者使用數字按鍵直接選取預設電台。

改變頻率間隔

若發現無法調諧電台，則本系統的頻率間隔可能不適用於您所在的國家／地區。

1 按下 SETUP。

2 選擇「System Setup」，然後按下 ENTER。

3 選擇「AM9K/10K」，然後按下 ENTER。

4 選擇設定值，然後按下 ENTER 以確認。

- **AM 9K** — AM 為 9 kHz 間隔；
FM 為 50 kHz 間隔
- **AM 10K** — AM 為 10 kHz 間隔；
FM 為 100 kHz 間隔

第 7 章

環繞音效設定值

 重要

- **RCV** 按下可將遙控器設定為操作接收重低音揚聲器的接收控制模式（確定液晶螢幕顯示以下所示的 RECEIVER 畫面）。



使用「聲音設定」選單

從「聲音設定」選單中，您可以使用系統全部的環繞聲設定。

設定時，以下字母各自代表的揚聲器為：

- **L** – 左前置揚聲器
- **C** – 中置揚聲器
- **R** – 右前置揚聲器
- **SR** – 右環繞揚聲器
- **SL** – 左環繞揚聲器
- **SW** – 重低音揚聲器

聲道位準設定值¹

自動 MCACC 功能（請參閱第 23 頁）應能提供最佳的環繞音效設定。然而您可能發現，更進一步調整聲道位準可提升房間內的環繞音效。

這種設定聲道位準的方式可讓您收聽來源並調整每個播放聲道的位準。

更進階的聲道位準設定方式則是使用測試音。詳情請參閱第 32 頁上的使用測試音調整聲道位準。

- 1 **SETUP** 按下 **SETUP**。



- 2 選擇「Sound Setup」，然後按下 **ENTER**。



- 3 選擇「ChannelLevel」，然後按下 **ENTER**。



- 4 使用 **←/→** 按鍵選擇聲道，或使用 **↑/↓** 按鍵調整該聲道的位準。

- 每個聲道的位準調整範圍為 $\pm 10 \text{ dB}$ 。²

- 5 **ENTER** 在完成時按下。

- 若再次使用自動 MCACC 功能，將會取代此處所做的設定。

揚聲器距離設定¹

自動 MCACC 功能（請參閱第 23 頁）應能提供最佳的環繞音效設定。然而您可能發現，進一步調整揚聲器距離設定值可提升房間內的環繞音效。

從正常的聆聽位置設定每個揚聲器的距離。



- 1 **SETUP** 開啟「Sound Setup」選單。



- 2 選擇「Distance」，然後按下 **ENTER**。



- 3 使用 **←/→** 按鍵選擇揚聲器，或使用 **↑/↓** 按鍵調整距離。

每個揚聲器的距離調整範圍為 **0.1m 至 9.0m**。



- 4 **ENTER** 完成時按下 **ENTER**。

- 若再次使用自動 MCACC 功能，將會取代此處所做的設定。

 附註

¹ 在開啟 **MCACC Effect** 後設定此功能時，以自動 MCACC 功能調整之相同功能的值會遭到取代。

關閉 **MCACC Effect** 時，套用在這裏設定的值，與使用自動 MCACC 調整的值無關。（不會取代自動 MCACC 設定。）

² 音量設定超過 51 時，調整範圍會受到限制。

動態範圍控制

以低音量觀賞 Dolby Digital 或 DTS 資料時，您可能無法清楚聽到低位準音效 — 包括部分對白。使用其中一項動態範圍控制（DRC）設定值便可提高低位準音效，同時控制高位準高音。

動態範圍控制僅適用於 Dolby Digital 音軌及部分 DTS 音軌。

1   開啓「Sound Setup」選單。

2  選擇「D.R.C.」，然後按下 ENTER。

3  選擇設定。

請選擇以下其中一個設定：

- **D.R.C. Auto** — 僅適用於 Dolby TrueHD 訊息。選擇 **D.R.C. High** 或 **D.R.C. Mid** 用於 Dolby TrueHD 以外的訊號。
- **D.R.C. High** — 減少動態範圍（降低大聲音量並提高較小聲的音效）
- **D.R.C. Mid** — 中等設定
- **D.R.C. Off** — 無動態範圍調整（以較高音量聆聽時請使用此設定）

4  按下可結束。

雙單聲道設定值

指定雙單聲道 Dolby Digital 音軌的播放方式。您也可以使用此設定值，切換使用雙語音效錄製的 DVD-RW 碟片聲道。

1   開啓「Sound Setup」選單。

2  選擇「Dual Mono」，然後按下 ENTER。

3  選擇設定。

請選擇以下其中一個設定：

- **CH1 Mono** — 僅播放聲道 1
- **CH2 Mono** — 僅播放聲道 2
- **CH1/CH2** — 兩個聲道皆由前置揚聲器播放

4  按下可結束。

使用虛擬後環繞模式

本模式可讓您透過您的環繞聲揚聲器聽到虛擬後環繞聲道。您可以選擇聆聽沒有後環繞聲道資訊的音源，或如果聲音以原始編碼格式（例如 5.1）聽起來較佳，您可以讓接收重低音揚聲器將此效果套用到 Dolby Digital EX 或 DTS-ES 等 6.1 編碼音源中。¹

- 1   開啟「Sound Setup」選單。
- 2  選擇「Virtual SB」，然後按下 ENTER。
- 3  選擇設定。
請選擇以下其中一個設定：
 - **Vir.SB On** — 一定使用虛擬後環繞（例如 5.1 編碼資料）
 - **Vir.SB Auto** — 虛擬後環繞自動套用到 6.1 編碼音源中（例如 Dolby Digital EX 或 DTS-ES、DTS Neo:6 或先進環繞聲模式）
 - **Vir.SB Off** — 虛擬後環繞模式關閉
- 4  按下可結束。



LFE 衰減

有些 Dolby Digital 和 DTS 音源包括極低的低音。視需要設定 LFE 衰減器，以避免揚聲器的極低音失真。LFE 設定為建議值 **0dB** 時不受限制。設定為 **-5dB**、**-10dB**、**-15dB** 或 **-20dB** 時，LFE 受到各等級的限制。選擇 **Off** 時，LFE 聲道不會輸出任何聲音。

- 1   開啟「Sound Setup」選單。
- 2  選擇「LFE ATT」，然後按下 ENTER。
- 3  調整設定值，然後按下 ENTER 確認。

使用測試音調整聲道位準

您也可以使用測試音作為參考設定聲道位準，而不需播放來源（請參閱第 30 頁上的聲道位準設定值）。每個揚聲器會輪流播放測試音，以供您在播放時調整位準。您也可以使用測試音來調整環繞聲的聲道位準。

- 1  執行音調測試。
每個揚聲器會輪流播放測試音。
將音量調到 50 以下。
- 2  播放時，調整聲道位準。
此目的在於調整位準，確保您從每個揚聲器聽到的測試音音量皆相同。每個聲道的位準調整範圍為 ±10 dB。
 - 您也可以使用 **VOL +/-** 按鍵調整測試音輸出的整體音量（不會影響聲道位準設定值）。
 - 由於重低音會產生超低頻率，其實際音效可能更大聲。我們建議聆聽來源時，調整重低音位準。請參閱第 30 頁上的聲道位準設定值。
- 3  完成時，按下可結束測試音設定。
 - 若再次使用自動 MCACC 功能，將會取代此處所做的設定。

附註

¹ 虛擬後環繞聲模式是否有效視輸入訊息和聆聽模式而定。

第 8 章 其他接線

重要

- 在本機的側面板上進行接線或變更接線時，請務必關閉電源，並將電源線插頭自牆上電源插座上拔除。完成所有接線後，再將電源線插頭接上電源插座。

連接輔助設備

您也可以將類比和數位的外接音訊來源連接至本系統。數位音訊來源包括數位衛星接收器、CD 錄音器等。

建議您使用 HDMI 連接線來連接有 HDMI 端子的音訊來源。如需詳細資訊，請參閱第 35 頁上的 *使用 HDMI 連接*。

若要聆聽來自電視機的音效，請將電視機的音訊連接線連接至本機的其中一個輸入插孔。

數位音訊的連接

本系統有光學數位輸入插孔。使用這些插孔連接 MD 和 CD 錄音器等外接設備。

接收重低音揚聲器

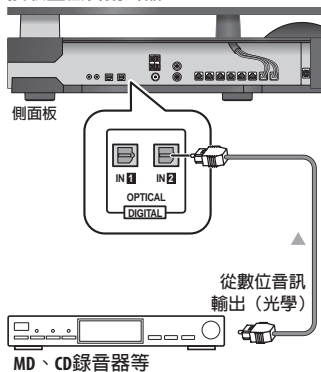

- 將側面板的 **OPTICAL IN 2** 插孔連接至外接播放設備的光學輸出插孔。這些設備包括 MD 播放器、數位衛星接收器或遊戲機等數位設備。

不使用 **OPTICAL IN 1** 輸入電視機的聲音時，您也可以使用它連接外部設備。

連接類比音效設備

您可以使用 **ANALOG AUDIO IN** 插孔連接錄音機等類比音效設備。

接收重低音揚聲器

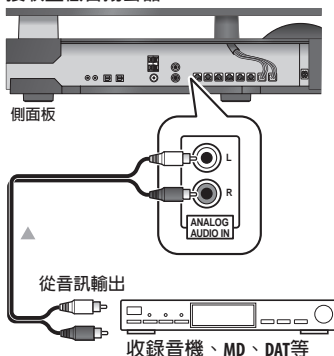

使用顯示裝置的 **F.AUDIO** 輸入插孔可輕易播放數位音訊播放器或 PC 的音效。使用立體聲迷你插頭連接線將音訊來源連接至顯示裝置。

- 將連接線接上 **F.AUDIO** 插孔時，本機的輸入自動切換至 **Front Audio In**。

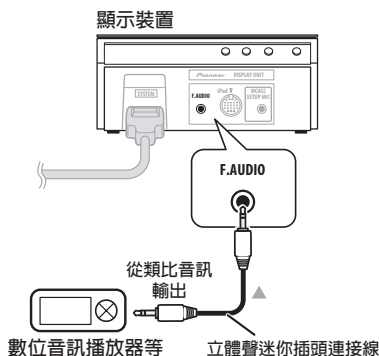

連接 iPod

您可以使用顯示裝置上的 iPod 插孔播放來自 iPod 的音樂。所有操作都可以透過 iPod 執行。使用隨附的 iPod 連接線將 iPod 連接至本機。

- 連接 iPod 時，本機的輸入自動切換到 iPod。
- 有些 iPod 機種的接頭跟本機不相容。

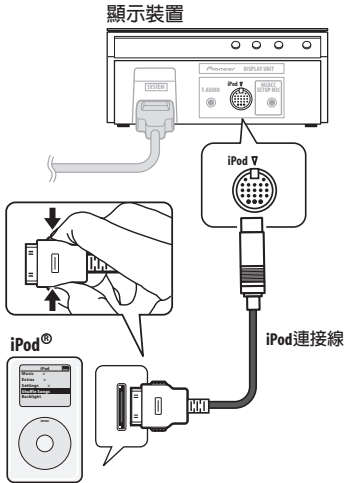

iPod® 是 Apple Inc. 在美國及其他國家已經註冊之商標。

聆聽外接音訊來源

若要使用本機聆聽來自所連接外部設備的音效，請在遙控器上選擇該設備的輸入功能。使用此遙控器可以控制某些先鋒產品。

1 若系統尚未開機，按下 **⏻ RECEIVER** 便可開機。同時請確定外接來源（電視機、衛星接收器等）的電源已開啓。

2 **LINE** 選擇音訊輸入來源。
輸入來源的顯示順序如下所示：



液晶螢幕切換至該選擇輸入來源的畫面。

3 按下所連接設備的按鍵。

連接的設備未顯示在畫面上，或連接不是先鋒製造的設備時，按下 **RCV** 按鍵使遙控器顯示在接收重低音揚聲器操作畫面上。

4 必要時，開始播放外接來源。

連接外接天線

若為外接 AM 天線，請使用 5 至 6 米的乙烯基絕緣電線，並安裝於室內或室外。請保持迴路天線的接線。

若為外接 FM 天線，請使用 PAL 接頭連接外接的 FM 天線。

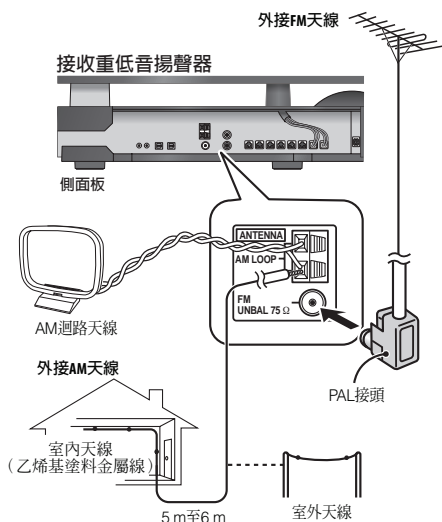

關於控制輸出連接

有多種先鋒設備支援 CONTROL 連接，將這些連接設備的遙控器對準其中一個設備的感應器即可使用。

使用遙控器時，控制訊號會沿著電路傳達至適當的設備。

如果您選擇使用此功能，請確定至少將一組 HDMI 或類比音效插孔連接至其他設備上，作為接地用途。

- 在任一側使用隨附的控制連接線，將另一個先鋒設備上的 CONTROL IN 插孔連接至接收重低音揚聲器上的 CONTROL OUT 插孔。

將遙控器指向本接收重低音揚聲器隨附的顯示裝置可控制其他設備。

使用 HDMI 連接

如果您有配備 HDMI 或 DVI (有 HDCP) 的設備，您可以使用市售的 HDMI 連接線將它連接至本接收重低音揚聲器。¹

HDMI 連接傳送未壓縮的數位視訊，以及幾乎每一種與連接的設備相容的數位音訊，包括 DVD-Video、DVD-Audio、SACD、Blu-ray Disc、VCD、超級 VCD、CD 和 MP3 等。

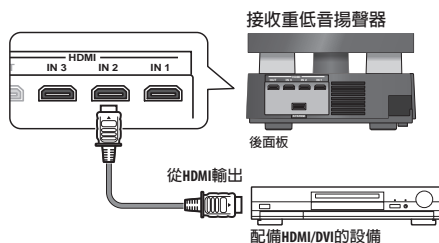

附註

- 1 僅限使用配備 DVI 並和 DVI 與高頻寬數位內容保護 (HDCP) 相容的設備進行 HDMI 連接。如果您選擇連接 DVI 接頭，您需要一個獨立的轉接器 (DVI → HDMI) 才能進行連接。但 DVD 連接不支援音訊訊號。如需詳細資訊，請洽詢當地的音訊裝置經銷商。
- 本機設計符合 HDMI (高傳真多媒體介面) 1.3a 版。使用 DVI 連接是否導致傳送不可靠的訊息視您連接的設備而定。使用配備 HDMI 1.0 版功能的設備時，無法從 HDMI 連接輸出防盜拷控制 DVD-Audio CPM 音源。
- 本機支援 SACD、Dolby Digital Plus、Dolby TrueHD 和 DTS-HD Master Audio。若要運用這些格式，請確定連接至本機的設備也支援相應的格式。

1 使用 HDMI 連接線，將本接收重低音揚聲器的 HDMI IN 1 至 3 內部接線連接至 HDMI 設備的 HDMI 輸出插孔。

將本接收重低音揚聲器連接至您的 HDMI 設備後，在您觀賞 HDMI 內容時，顯示裝置上的 HDMI 指示燈（紅色）亮起。

2 使用 HDMI 連接線，將本接收重低音揚聲器的 HDMI OUT 內部接線連接至 HDMI 相容顯示裝置的 HDMI 內部接線。

- 連接線接頭上的箭頭應該朝右，與播放器的接頭對齊。

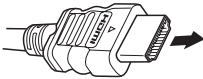

3 使用 HDMI 1 至 3 按鍵選擇您要連接的 HDMI 輸入（例如 HDMI 2）。

您可以使用顯示裝置的 **INPUT SELECTOR** 執行此操作。

- 如果想要聽到您的電視機或電漿電視輸出的 HDMI 音效（本接收重低音揚聲器將不會輸出任何聲音），在下文的 *HDMI 模式設定* 中將 HDMI 模式設定為 **Through Mode**。
- 如果視訊未出現在電視機或電漿電視上，請嘗試調整您的設備或顯示器上的解析度設定。

HDMI 模式設定

指定 HDMI 音訊的傳送路徑是來自接收重低音揚聲器（擴大器）或經由電視機或電漿電視。HDMI 模式設定為 **Through Mode** 時，無法使用多個本機的聲音功能。



重要

- **RCV** 按下可將遙控器設定為可操作接收重低音揚聲器的接收控制模式（確定液晶螢幕顯示 **RECEIVER** 畫面）。

1 **SETUP** 按下 **SETUP**。



2 選擇「HDMI Setup」，然後按下 **ENTER**。



3 選擇「HDMI Mode」，然後按下 **ENTER**。



4 調整設定值，然後按下 **ENTER** 確認。

- **AMP Mode** — 輸出來自本機的 HDMI 音訊訊號。
- **Through Mode** — 輸出來自一般電視機或電漿電視的 HDMI 音訊訊號。
HDMI THROUGH 指示燈亮起。

關於 HDMI

HDMI（高傳真多媒體介面）視訊支援單一數位連接的視訊與音訊，可搭配 DVD 播放器、DTV、機上盒與其他影音裝置使用。HDMI 的開發是為了以單一規格提供高頻寬數位內容保護（HDCP）與數位影像介面（DVI）技術。HDCP 用於保護 DVI 相容顯示器傳送和接收的數位內容。

HDMI 有支援標準、增強或高傳真視訊 + 標準到多聲道環繞聲音效的功能。HDMI 功能包括解壓縮視訊、高達每秒 2.2 GB 的頻寬、一個接頭（取代多條連接線和多個接頭）、在影音來源與 DTV 等影音裝置之間通訊。

HDMI、*HDMI* 標誌及 *High-Definition Multimedia Interface* 均為 *HDMI Licensing LLC* 的商標或註冊商標。

第 9 章 HDMI Control

使用 HDMI 連接線將本機連接至 HDMI Control 相容先鋒電漿電視或硬碟 /DVD 錄影機後，您可以透過所連接電漿電視的遙控器控制本機，以及讓所連接的電漿電視自動變更輸入以回應在本機上執行的操作。

如需有關透過 HDMI 連接線連接可執行哪些操作的詳細資訊，請參閱電漿電視的操作手冊。

- 您無法使用此功能搭配不支援 HDMI Control 功能的設備。
- 我們不保證本機可以搭配非先鋒公司製造的 HDMI Control 相容設備使用。

重要

- **RCV** 按下可將遙控器設定為操作接收重低音揚聲器的接收控制模式（確定液晶螢幕顯示以下所示的 RECEIVER 畫面）。



進行 HDMI Control 連接

您可以對連接的電漿電視和最多三個其他設備（包括最多兩台錄影機或播放器）。

確定將電漿電視的音訊連接線連接至本機的音訊輸入插孔。

- 如果您使用市售的 HDMI 連接線，請檢查該連接線是否支援 HDMI 1.3 標準。否則，HDMI Control 功能可能無法正常作用。

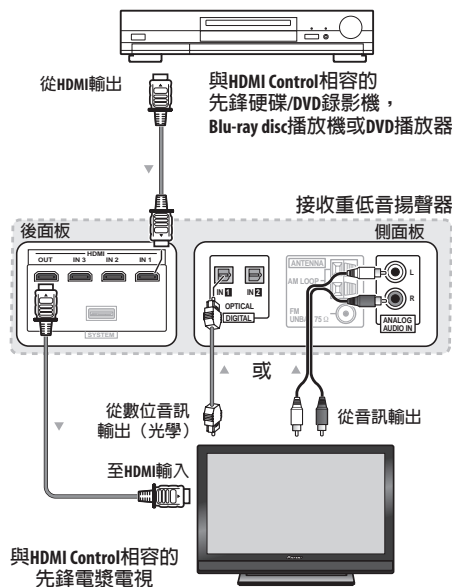

- 將電漿電視直接連接至本機。中斷與其他擴大器或影音轉換器（例如 HDMI 開關）的直接連接可能導致操作上的錯誤。

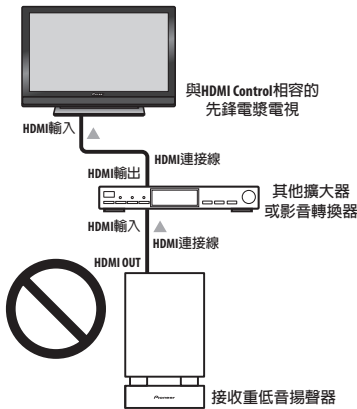

- 僅限連接您打算做為本機 HDMI 輸入來源的設備。中斷與其他擴大器或影音轉換器（例如 HDMI 開關）的直接連接可能導致操作上的錯誤。

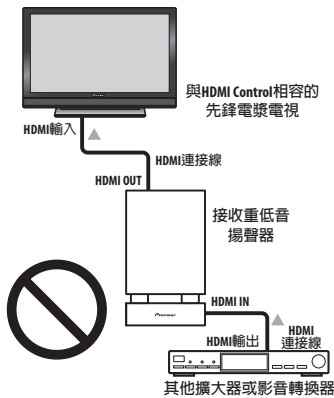

重要

- 對此系統進行接線或變更接線時，請務必關閉電源，並將電源線插頭自牆上電源插座上拔除。完成所有接線後，再將電源線插頭接上電源插座。
- 將本機連接至 AC 電源插座後，開始 15 秒的初始化程序。初始化期間不可以執行任何操作。顯示裝置上的 **HDMI** 指示燈在初始化期間閃爍，您可以在此指示燈一停止閃爍時即開啓本機電源。
- 若要使本功能發揮最大效用，建議您不要將 HDMI 設備連接至電漿電視，而是直接連接至本機的 HDMI 端子。

設定 HDMI 選項

若要充分運動 HDMI Control 功能，您必須調整本機的設定與 HDMI Control 相容連接設備。如需詳細資訊，請參閱每個設備的操作手冊。

設定 HDMI Control 模式

選擇是否將本機的 HDMI Control 功能設定為 **On** 或 **Off**。若要使用 HDMI Control 功能，必須將它設定為 **Control On**。





- 使用非先鋒製造的電視機時，將此設定切換至 **Control Off**。

- 按下 **SETUP**。
- 選擇「HDMI Setup」，然後按下 **ENTER**。
- 選擇「HDMI Ctrl」，然後按下 **ENTER**。
- 調整設定值，然後按下 **ENTER** 確認。

- Control On** — 啓用 HDMI Control 功能。在本機電源關閉，且在使用 HDMI Control 功能期間開始播放支援的來源時，從電漿電視輸出來自 HDMI 連接的音訊與視訊。
- Control Off** — 已停用 HDMI Control 功能。無法使用同步化操作。本機電源關閉後，不會輸出透過 HDMI 連接的音訊和視訊來源。

設定自動延遲

本功能自動修正以 HDMI 連接的設備之間的音訊至視訊延遲。音訊延遲時間的設定是以 HDMI 連接線連接的顯示器操作狀態而定。本機根據視訊延遲時間自動調整音訊延遲時間。





- 1  按下 **SETUP**。
- 2  選擇「HDMI Setup」，然後按下 **ENTER**。
- 3  選擇「Auto Delay」，然後按下 **ENTER**。
- 4  選擇「A.Delay On」或「A.Delay Off」，然後按下 **ENTER** 以確認。

提示

- 本功能僅在連接的顯示器支援適用於 HDMI 或 HDMI Control 的自動音訊／視訊同步化功能（唇形同步）時才能使用。如果您找到不適當的自動設定延遲時間，將 **A.Delay** 設定為 **Off**，然後手動調整聲音延遲設定（第 27 頁）。

電漿電視的音訊輸入設定（TV 輸入）

若要使用本裝置收聽來自電漿電視的音效，您必須接上 HDMI 連接線以外的音訊連接線。在此選單中，將音訊輸入設定為您想要連接的音訊輸入。按下遙控器上的 **TV** 將本機切換至在此選擇的輸入來源。此設定值變成所選擇的輸入，並且從本裝置輸出來自電漿電視的音效。選擇來自 **Digital 1**、**Digital 2** 和 **Analog** 的輸入。

- 1  按下 **SETUP**。
- 2  選擇「System Setup」，然後按下 **ENTER**。
- 3  選擇「TV Input」，然後按下 **ENTER**。
- 4  調整設定值，然後按下 **ENTER** 確認。

重要

- 您必須設定此設定值才能啟動 HDMI Control 功能。

使用同步化之前

完成所有連接與設定後，您必須：

- 1 使所有設備進入待機模式。
- 2 開啓所有設備的電源，但在最後才開啓電漿電視的電源。
- 3 選擇電視機與本機連接的 HDMI 輸入，然後查看來自連接設備的視訊輸出是否正常顯示在螢幕上。

同步化擴大器模式

同步化擴大器模式在您執行電漿電視的操作時開始。如需詳細資訊，請參閱電漿電視的操作手冊。

同步化擴大器模式操作

使用 HDMI 連接線將設備連接至本機後，您可以使用同步化擴大器模式來同步化下列操作：

- 使本機靜音或調整本機音量時，顯示在電漿電視上。
- 連接的設備開始播放時，自動變更本機的輸入。
- 即使您將本機的輸入變更為不是以 HDMI 連接的裝置，同步化擴大器模式仍然有效。
- 在聆聽來自硬碟 /DVD 錄影機的音源時，按下 **GENRE** 可自動選擇最適合的聆聽模式（第 26 頁）。

取消同步化擴大器模式

如果您在透過 HDMI 連接至電漿電視或觀賞電視節目時取消同步化擴大器模式，本機電源關閉。

第 10 章

其他資訊



重要

- **RCV** 按下可將遙控器設定為操作接收重低音揚聲器的接收控制模式（確定液晶螢幕顯示以下所示的 **RECEIVER** 畫面）。



調暗顯示幕亮度

若您覺得太亮，可調暗顯示裝置的顯示亮度。¹

- 1 **SETUP** 按下 **SETUP**。



- 2 選擇「System Setup」，然後按下 **ENTER**。



- 3 選擇「Dimmer」，然後按下 **ENTER**。



- 4 選擇「Dimmer Light」或「Dimmer Dark」，然後按下 **ENTER** 以確認。

設定睡眠定時器

睡眠定時器經過特定時間後將會切斷接收重低音的電源，您可放心入睡。

- **SLEEP** 按下可選擇選項。

有以下選項可供選擇：

- **Sleep On** —約一小時後關閉電源
- **Sleep Off** —取消睡眠定時器

選擇 **Sleep On** 後，再按一次 **SLEEP** 可檢查剩餘的時間。每條線代表約 12 分鐘（剩餘時間）：



附註

¹ 設定睡眠定時器時，不論此設定值為何，顯示裝置的顯示幕都會變暗。

設定遙控器以控制電視機

您可以使用隨附的遙控器操控電視機。若要使用此功能，您必須先使用下頁表中的標記碼設定遙控器。

- 1 **TV** 將輸入設定為電視機。

- 2 按住 **TV** 按鍵，然後按下 **SETUP**。

電視機預設畫面顯示在遙控器上，而目前製造商代碼顯示在液晶螢幕上。

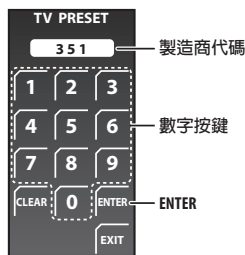

- 3 使用數字按鍵輸入電視機的製造商代碼，然後按 **ENTER**。

關於製造商代碼清單，請參閱下一頁的表格。如果提供一個以上的電視機一個以上的製造商代碼，請輸入清單中的第一個。

- 若表中沒有您電視機的製造商名稱，則無法使用此遙控器操控電視機。

- 4 將遙控器對準電視機，按下 **⏻** **SOURCE**，確認遙控器是否可用。

若遙控器的設定正確，電視機應會關機。若未關機，且出現其他標記，請使用新代碼並重複步驟 1。

電視機預設代碼表

請注意，指定正確預設代碼後，可能只有特定功能可供控制，或者表中的製造商代碼無法用於您目前的機種。

製造商代碼	製造商代碼
Admiral 003, 004, 005	NEC 128, 129, 130, 131
Aiwa 006, 007, 008	Nokia 086, 087, 132, 133, 134
Akai 009, 010	Nokia Oceanic 135, 136
Alba 011	Nordmende 137, 138, 139
AOC 012	Okano 140
Bell&Howell 013, 014	Onwa 141
Bestar 015	Orion 142
Blaupunkt 016, 017	Panasonic 143, 144, 145, 146, 147, 148, 149, 150
Blue sky 018	Philco 151, 152, 153
Brandt 019	Philips 154, 155, 156
Broscronic 020, 021	Phonola 157
Bush 022	Portland 158, 159
Clatronic 023	Proscan 160
Craig 024, 025, 026, 027	Quasar 161, 162
Croslex 028	Radio 163
Curtis Mathis 029, 030, 031	Radio Shack 164, 165, 166, 167
Daewoo 032, 033, 034, 035, 036, 037	Radiola 168
Daytron 038	RCA 169, 170, 171, 172, 173, 174, 175
Dual 039, 040	SABA 176, 177, 178, 179, 180
Emerson 041, 042, 043, 044, 045, 046, 047	Samsung 181, 182, 183, 184, 185, 186, 187, 188
Ferguson 048, 049, 050	Sanyo 189, 190, 191, 192, 193, 194, 195, 196, 197, 198
First line 051	Schneider 199, 200, 201, 202
Fisher 052, 053	Scott 203, 204
Fraba 054	Sharp 205, 206, 207, 208, 209, 210, 211
Fujitsu General 055	Siemens 212
Funai 056, 057, 058, 059, 060	Signature 213, 214
GE 061, 062, 063, 064, 065	Sony 215, 216
Goldstar 066, 067, 068, 069, 070	Sylvania 217, 218, 219
Goodmans 071, 072, 073	Symphonic 220
Grundig 074, 075, 076	Tatung 221
Hitachi 077, 078, 079, 080, 081, 082	Telefunken 222, 223, 224, 225
HYUNDAI 083	Thomson 226, 227
ICE 084	Thorn 228
Irradio 085	Toshiba 229, 230, 231, 232, 233, 234
Itt 086, 087	Universum 235
JC Penny 088, 089, 090, 091	Videch 236, 237, 238
JVC 092, 093, 094, 095, 096, 097	W.Whouse 239
Kendo 098	Wards 240, 241, 242, 243
KTV 099, 100, 101	Watson 244
LG 102	Yamaha 245, 246, 247, 248, 249
Loewe 103, 104, 105	Zenith 250, 251
LXI 106, 107, 108, 109, 110, 111	PIONEER 001, 002
Magnavox 112, 113, 114, 115	
Mark 116	
Matsui 117, 118	
Medion 119	
Mitsubishi 120, 121, 122, 123, 124, 125, 126	
Mivar 127	

重設系統

使用此程序可將所有系統設定值恢復至出廠設定。

- 1 開啓系統電源。
- 2 按住 INPUT SELECTOR，然後按下顯示裝置上的 **⏻ STANDBY/ON** 按鍵。
下次開啓電源時，所有系統的設定值都會重新設定。

安裝與維護

安裝提示

我們希望您能夠在日後享受本系統所帶來的樂趣，因此選擇安裝地點時，請記住以下要點：

請...

- ✓ 在通風良好的房間內使用本系統。
- ✓ 將本系統放在穩固、平坦的水平面，如桌子、置物櫃或音響架上。

請勿...

- ✗ 於高溫或濕氣重的地方使用本系統，包括放射物及其他會產生熱源的電器產品。
- ✗ 將本系統放在窗台或其他可能受陽光直射之處。
- ✗ 在灰塵過多或過於潮濕的環境中使用本系統。
- ✗ 將本系統直接放在擴大器上方，或放在其他使用時會變熱的立體聲系統裝置上。
- ✗ 在電視機或顯示器附近使用本系統，否則可能會產生干擾—尤其是使用室內天線的電視機。
- ✗ 在廚房或其他可能使系統暴露於油煙或蒸氣的地方使用本系統。
- ✗ 將本系統放在厚重的地毯上或用布蓋住—以免阻礙系統的散熱。
- ✗ 將系統放在不平穩的表面，或其他面積無法支撐系統四個腳架的表面上。

環繞音效格式

以下是您在 DVD 上可以找到的有關 DVD、衛星接收器、連接線、陸地廣播和錄影帶的主要環繞聲格式簡要說明。

Dolby

Dolby 技術的說明如下所示。如需詳細資訊，請造訪 www.dolby.com。



Dolby Digital

Dolby Digital 為電影院和家中播放 DVD 與數位廣播音軌常用的多聲道數位音訊編碼技術。它提供六個獨立的聲道，由五個全音域聲道和一個主要供深沈、隆隆的音效使用的特殊 LFE（低頻率效果）聲道所組成，因此成為 Dolby Digital 「5.1 聲道」一詞的由來。

除了上述的格式特點之外，Dolby Digital 解碼器提供與單音、立體聲和來自多種位元率與聲道的 Dolby Pro Logic 音訊相容的縮混功能。另一個特點稱為 Dialog Normalization（對話正常化），本特點根據相對於其峰值位準的節目中之平均位準來減小節目的聲音，以便達到一致的播放位準。

Dolby Pro Logic II 和 Dolby Surround

Dolby Pro Logic IIx 是 Dolby Pro Logic II（和 Dolby Pro Logic）解碼系統的改良版。由於採用創新的「動向邏輯」電路，本系統可以從以下的來源中擷取出環繞音效：

- **Dolby Pro Logic**—取自任何立體聲來源之 4.1 聲道音效（單聲道）
- **Dolby Pro Logic II**—取自任何立體聲來源之 5.1 聲道音效（立體環繞聲）

使用雙聲道來源時，由接收重低音揚聲器中的低音管理產生「.1」重低音聲道

Dolby Surround 是在立體聲音軌內嵌入環繞聲資訊的編碼系統，Dolby Pro Logic 解碼器使用此系統提供更細緻的增強環繞聲聆聽效果。

Dolby Digital Plus

Dolby Digital Plus 是使用於所有高傳真節目和媒體的下一代音訊技術。這種技術結合了效率，以符合未來需要強大功能與使用彈性的廣播需求，落實了未來高傳真世代中所期待的全方位音效潛力。Dolby Digital Plus 以全球的 DVD 與 HD 廣播的多聲道標準 Dolby Digital 為建立基礎，並針對下一代的影音接收器而設計，但仍然能與目前所有的影音接收器相容。

Dolby Digital Plus 提供多達 7.1 聲道 (*) 的多聲道音訊編序能力，並以最大可能的 6 Mbps 潛在位元率、HD DVD 上高達 3 Mbps 和藍光碟片上高達 1.7 Mbps BD 上的最大位元率效能支援單一編碼位元率中的多種編序，並且在現有的 Dolby Digital 系統上輸出用於播放的 Dolby Digital 位元流。Dolby Digital Plus 可以精準地重現指揮和製作人想要的原音。

它也擁有具備獨立聲道輸出的多聲道音效、互動式混音與先進系統中的串流功能。高傳真多媒體介面 (HDMI) 支援的單線式數位連接可用於高傳真音訊和視訊。

Dolby TrueHD

Dolby TrueHD 是針對下個世代的高傳真光碟片而開發的新一代無損失編碼技術。Dolby TrueHD 帶來震撼人心且位元等級媲美錄音室製作的聲音，並以下一代的高傳真光碟片傳達出真實的高傳真娛樂體驗。結合高傳真視訊時，Dolby TrueHD 以令人驚豔的音效和高傳真影像，提供前所未有的家庭電影院體驗。

它支援高達 18 Mbps 的位元率，而且可錄製高達八個全音域聲道 (*)，每個聲道都是 24 位元 /96 kHz 音訊。它擁有廣泛的中繼資料，包括對話正常化和動態範圍控制。高傳真多媒體介面 (HDMI) 支援的單線式數位連接可用於高傳真音訊和視訊。

* HD DVD 和藍光碟片標準目前將它們的最大聲道數限制在八個，而 Dolby Digital Plus 和 Dolby TrueHD 支援超過八個聲道。

由 Dolby Laboratories 授權製造。「杜比」、「Dolby」、「Pro Logic」和雙 D 標誌是 Dolby Laboratories 的商標。

DTS

Dolby 技術的說明如下所示。如需詳細資訊，請造訪網站 www.dtstech.com。



DTS Digital Surround

DTS Digital Surround 是來自 DTS Inc. 的 5.1 聲道音訊編碼系統，目前廣泛使用於 DVD-Video、DVD-Audio、5.1 聲道音樂碟片、數位廣播和電視遊戲。它可以提供六個獨立的聲道，由五個全音域聲道加上一個 LFE 聲道所組成。使用低壓縮率得到較好的音質，並在播放時以較高的速率傳送聲音。

DTS-ES

DTS-ES (ES 代表擴展環繞聲) 是一種可以將 DTS-ES Discrete 6.1 和 DTS-ES Matrix 6.1 編碼來源解碼的解碼器。DTS-ES Discrete 6.1 以完全分離 (獨立) 的環繞聲後聲道提供「真實的」6.1 聲道聲音。DTS-ES Matrix 6.1 擁有與環繞聲左/右聲道形成矩陣的環繞聲後聲道。這兩種音源都與傳統的 DTS 5.1 聲道解碼器相容。

DTS Neo:6

DTS Neo:6 可以產生取自任何矩陣式立體聲音源 (例如視訊或電視) 與 5.1 聲道音源的 6.1 聲道環繞聲。而且它使用已編碼在音源中的聲道資訊，並自行處理以判斷聲道的定位 (使用雙聲道來源時，由接收重低音揚聲器中的低音管理產生「L1」重低音聲道)。如果使用兩個聲道來源，使用 DTS Neo:6 時提供兩個模式 (電影院與音樂)。

DTS 96/24

DTS 96/24 是原始 DTS Digital Surround 的延伸，使用 DTS 96/24 解碼器提供高品質 96 kHz/24 位元音訊。此格式也完全向後相容於所有目前的解碼器。這表示 DVD 播放器可以使用傳統的 DTS 5.1 聲道解碼器播放此軟體。

DTS-EXPRESS

DTS-EXPRESS 是一種低位元率解碼技術，支援固定資料傳輸率的 5.1 聲道。此格式與 HD DVD 的子音訊和藍光碟片的次要音訊整合，對將來的廣播和記憶音訊內容提升潛在的適用性。

DTS-HD Master Audio

DTS-HD Master Audio 技術為聆聽者帶來在專業錄音室中錄製的主要音源，不但未損失任何資料且保留了音質。DTS-HD Master Audio 採用可變資料傳輸率，以遠超過標準 DVD 的藍光碟片格式 (最大傳輸率 24.5 Mbps) 和 HD-DVD 格式 (最大傳輸率 18.0 Mbps) 的速率傳送資料。這些高資料傳輸速率在沒有任何資料損失的情況下傳送 96 kHz/24 位元的 7.1 聲道音源，而且完全無損及原始的音質。DTS-HD Master Audio 是一種無可取代的技術，它可以依音樂或影片創作人的需要完整重現出真實的聲音。

“DTS”是 DTS, Inc. 的註冊商標，“DTS-HD Master Audio”是 DTS, Inc. 的商標。

故障排除

人們經常錯將不正確之操作當成系統故障或異常。如果您認為本機有任何異常之處，請按以下各點進行檢查。有時候問題可能出在其他設備上。請仔細檢查其他使用中的設備和電器。如果在檢查以下各點後仍無法改善問題，請就近洽詢您的先鋒授權服務中心或經銷商，前來代為維修。

- 如果本系統是因為受到靜電等外來效應致無法正常操作，請將電源插頭從輸出插座上拔下再插回去，以回復正常的操作狀態。
- 若是與音效相關的問題，請也一併檢查音效播放裝置的設定。如需詳細資訊，請參閱裝置的操作手冊。

一般

問題	解決辦法
電源無法開啓或突然關機（啓動時可能顯示一錯誤訊息）或顯示幕突然熄滅，而且沒有輸出任何聲音（ POWER ON 指示燈亮起（藍色）和 HDMI 指示燈亮起（紅色））。	<ul style="list-style-type: none"> • 接通本機電源，等待一分鐘，然後重新開機。 • 確定主機上的線束無鬆脫的情形。如有鬆脫，可能會造成系統自動關機。 • 檢查揚聲器連接是否正確。 • 請確定接收重低音周圍是否有足夠的通風空間。 • 確定主電源的電壓確實適用於本機種。 • 試著降低音量。 • 如果仍無法解決問題，請將本機攜至最近的先鋒授權服務中心或您的經銷商處接受維修。 • 請勿堵住底部的進氣口和本機背面的排氣口。
選擇輸入功能後，沒有聲音輸出。	<ul style="list-style-type: none"> • 如果您正在使用線路輸入插孔，請確定設備的接線方式正確並調整外部設備（例如可攜式播放器）的音量（請參閱第 33 頁上的連接輔助設備）。 • 調高音量。 • HDMI 模式設定為 Through Mode（第 36 頁）時，與本機連接的揚聲器沒有輸出任何聲音。 • 使用 HDMI 連接 DVI 設備後，沒有輸出任何聲音。 • 按下遙控器上的 MUTE 以關閉靜音功能。
環繞聲揚聲器未輸出任何聲音。	<ul style="list-style-type: none"> • 請參閱第 30 頁上的聲道位準設定值以檢查揚聲器位準。 • 檢查您是否選擇 Stereo 模式（請參閱第 24 頁上的以環繞音效聆聽）。 • 正確地將揚聲器接上（請參閱第 8 頁上的接線）。 • 使用光學數位連接線連接外部設備時，檢查外部設備的音訊輸出與 HDMI 設定。
無法使用遙控器進行操控。	<ul style="list-style-type: none"> • 更換電池（請參閱第 21 頁上的裝入遙控器電池）。 • 請在 7 m 內的範圍，以 30° 的角度對準遙控感應器操作（請參閱第 22 頁上的使用遙控器）。 • 移除障礙物或從其他位置操作。 • 避免前面板上的遙控感應器受到陽光直射。 • 操作連接至 CONTROL OUT 插孔的其他先鋒設備時，請確定已接上控制連接線和 HDMI 或類比音訊連接線（第 35 頁）。

調諧器

問題	解決辦法
收聽電台廣播時有明顯的雜音。	<ul style="list-style-type: none">請接上 AM 天線（請參閱第 8 頁上的 <i>接線</i>）並加以調整方向及位置，以得到最佳的接收效果。您也可以另外接一條內部或外部 AM 天線（請參閱第 35 頁上的 <i>連接外接天線</i>）。完全伸展開 FM 線型天線，調整最佳接收的位置，然後固定於牆上。您也可以另外接一組外接 FM 天線（請參閱第 35 頁上的 <i>連接外接天線</i>）。關閉其他可能造成雜訊的設備或將其移走。調諧間隔不適用於您所在國家或地區。若要切換調諧間隔，請參閱第 29 頁上的 <i>改變頻率間隔</i>。
自動調諧功能無法接收到某些電台。	<ul style="list-style-type: none">電台訊號微弱。自動調諧功能僅能偵測到訊號發射良好的無線電台。若要獲得更加靈敏的調諧條件，可接上一組室外天線。

HDMI

故障現象	解決辦法
沒有影像或聲音。	<ul style="list-style-type: none">本接收重低音揚聲器是 HDCP 相容設備。檢查您正在連接的設備是否為 HDCP 相容設備。是否可以搭配本接收重低音揚聲器使用（即使是 HDCP 相容設備）視連接的來源設備而定。如果將 HDMI 設備直接連接至顯示器時，問題仍然存在，請參閱設備或顯示器的手冊，或聯絡製造商以尋求支援。
沒有聲音，或聲音突然消失。	<ul style="list-style-type: none">檢查 HDMI 模式是否設定為 AMP Mode/Through Mode。如果設備是 DVI 裝置，請使用另外的連接方式連接音訊。檢查來源設備的音訊輸出設定。

顯示的訊息

訊息	說明
192kHz PCM SACD DTS-HD DTS Express Dolby TrueHD Dolby D+	這些訊息在您操作與正在播放的音訊來源不相容的功能時顯示。
No MIC	未接上 MCACC 設定麥克風時，按下 MCACC 會顯示本訊息。
Muting	本機靜音時，按下 TEST TONE 或 MCACC 會顯示本訊息。
2ch Only	操作僅適用於雙聲道來源，因目前來源為多聲道來源而無法進行。
Exit	此訊息會在選單閒置一段時間後自動退出時出現。
HDMI Through	當 HDMI 模式變為直通模式時，變更聆聲模式、音量或某些聲音設定會顯示本訊息。
Unknown	無法取得硬碟 /DVD 錄影機正在播放內容的類型資訊。
No Genre	未設定硬碟 /DVD 錄影機正在播放內容的類型。
HDMI C.ERR 2C*	連接的設備與同步化類型模式不相容。
Can't use	<ul style="list-style-type: none"> 您嘗試對不支援的此功能的來源設備使用類型同步化模式。 來源設備正處於無法使用類型同步化模式的情況。 您嘗試在本機輸入來源是 HDMI 以外的來源時使用類型同步化模式。 操作因環繞聲設定而遭到禁止。 音量超過 51 時，有些功能會受到限制。
HDMI C.ERR 1**	檢查連接 HDMI 連接線的方式是否正確。如果連接的方式正確，表示本機可能已損壞。如果發生這種情況，請洽詢先鋒授權服務中心或就近的經銷商。
Noisy!	因背景雜音太大而無法順利完成 MCACC 設定。
Error MIC!	在 MCACC 設定期間，因未將麥克風接上或連接不正確而發生錯誤。
Error Speaker!	在 MCACC 設定期間，因未將揚聲器接上或連接不正確而發生錯誤。
Over Temp	請降低音量。如果拔下電源線再重新插入後無法解決這個問題，表示本機可能已損壞。如果發生這種情況，請洽詢先鋒授權服務中心或就近的經銷商。
OC Error1 OC Error2	檢查揚聲器連接線是否短路。如果本錯誤訊息持續顯示，相關維修事宜請洽詢您的先鋒授權服務中心或經銷商。
*** BackUpERR	相關維修事宜請洽詢您的先鋒授權服務中心或經銷商。

規格

SX-LX70W 音效多聲道接收重低音

• 擴大器部分

RMS 功率輸出 (8 聲道輸出) :

前置 (L/R)	100 W (50 W + 50 W)
	(1 kHz, 10 % T.H.D., 8 Ω)
雙重中置 (CL/CR)	100 W (50 W + 50 W)
	(1 kHz, 10 % T.H.D., 8 Ω)
環繞聲 (L/R)	100 W (50 W + 50 W)
	(1 kHz, 10 % T.H.D., 8 Ω)
雙重低音 (雙聲道)	100 W (50 W + 50 W)
	(100 Hz, 10 % T.H.D., 8 Ω)

• FM 調諧器部分

頻率範圍	87.5 MHz 至 108 MHz
天線	.75 Ω, 不平衡式

• AM 調諧器部分

頻率範圍	
以 9 kHz 間隔	531 kHz 至 1602 kHz
以 10 kHz 間隔	530 kHz 至 1700 kHz
天線	迴路天線

• 重低音部分

音箱	低音反射落地型
	(防磁)
系統	.18 cm, 單向系統
揚聲器	.18 cm 圓錐型 x2
阻抗	.8 Ω
頻率範圍	30 Hz 至 500 Hz
最大輸入功率	50 W x2

• 輸入/輸出部分

HDMI 端子	
輸入	19 接腳 x3
輸出	19 接腳 (5 V, 100 mA)
其他接頭	
系統接頭	26 接腳
音訊輸入	光學 x2 (數位)
	RCA (2 接腳) (類比)
控制輸出	迷你插孔 x2
顯示裝置	
系統接頭	26 接腳
前音訊輸出	迷你插孔
MCACC 輸入	迷你插孔
iPod 輸入	20 接腳 (12 V, 420 mA)

• 其他

電源需求	AC 110 V 至 240 V, 50 Hz/60 Hz
消耗功率	69 W
待機狀態的消耗功率	
	0.39 W (HDMI Control 開)
	0.29 W (HDMI Control 關)
尺寸	245 mm (寬) x 409 mm (高) x 600 mm (深)
重量	17.8 kg

SSP-LX70ST 衛星揚聲器

(前置/中置揚聲器 x2, 環繞聲揚聲器 x2)

• 前置/中置揚聲器

音箱	封閉式書架型
	(防磁)
系統	5.2 cm, 單向系統
揚聲器	5.2 cm 圓錐型 x3
阻抗	
前聲道	.8 Ω
中央聲道	.8 Ω
頻率範圍	200 Hz 至 20 kHz
最大輸入功率	
前聲道	50 W
中央聲道	50 W
尺寸	.122.5 mm (寬) x 89.5 mm (高) x 104 mm (深)
重量	.0.5 kg

• 環繞聲揚聲器

音箱	封閉式書架型
	(防磁)
系統	5.2 cm, 單向系統
揚聲器	5.2 cm 圓錐型 x2
阻抗	.8 Ω
頻率範圍	200 Hz 至 20 kHz
最大輸入功率	50 W
尺寸	.122.5 mm (寬) x 89.5 mm (高) x 104 mm (深)
重量	.0.44 kg

配件

• 配件盒 (AS-LX70) :

遙控器	.1
AA/LR6 鹼性電池	.4
電源線	.3
顯示裝置	.1
AM 迴路天線	.1
FM 線型天線	.1
麥克風 (用於自動 MCACC 設定)	.1
HDMI 連接線	.1
控制連接線	.1
顯示連接線	.1
光學數位連接線	.1
iPod 連接線	.1
本操作手冊	

• 接收重低音揚聲器 (SX-LX70W) 包裝箱 :

清潔布	.1
-----	----

• 衛星揚聲器 (SSP-LX70ST) 包裝箱 :

揚聲器連接線	.6
揚聲器支座	.4
防滑墊	.16
螺絲	.4

備註

- 因產品改良, 規格與設計如有變更, 恕不另行通知。

PIONEER CORPORATION

4-1, Meguro 1-Chome, Meguro-ku, Tokyo 153-8654, Japan

PIONEER ELECTRONICS (USA) INC.

P.O. BOX 1540, Long Beach, California 90801-1540, U.S.A. TEL: (800) 421-1404

PIONEER ELECTRONICS OF CANADA, INC.

300 Allstate Parkway, Markham, Ontario L3R 0P2, Canada TEL: 1-877-283-5901, 905-479-4411

PIONEER EUROPE NV

Haven 1087, Keetberglaan 1, B-9120 Melsele, Belgium TEL: 03/570.05.11

PIONEER ELECTRONICS ASIACENTRE PTE. LTD.

253 Alexandra Road, #04-01, Singapore 159936 TEL: 65-6472-7555

PIONEER ELECTRONICS AUSTRALIA PTY. LTD.

178-184 Boundary Road, Braeside, Victoria 3195, Australia, TEL: (03) 9586-6300

PIONEER ELECTRONICS DE MEXICO S.A. DE C.V.

Bldv.Manuel Avila Camacho 138 10 piso Col.Lomas de Chapultepec, Mexico,D.F. 11000 TEL: 55-9178-4270

K002_B_En

Published by Pioneer Corporation.

Copyright © 2007 Pioneer Corporation.

All rights reserved.

Free Manuals Download Website

<http://myh66.com>

<http://usermanuals.us>

<http://www.somanuals.com>

<http://www.4manuals.cc>

<http://www.manual-lib.com>

<http://www.404manual.com>

<http://www.luxmanual.com>

<http://aubethermostatmanual.com>

Golf course search by state

<http://golfingnear.com>

Email search by domain

<http://emailbydomain.com>

Auto manuals search

<http://auto.somanuals.com>

TV manuals search

<http://tv.somanuals.com>