

Pioneer *sound.vision.soul*

CX303

DVD/CD Receiver

XV-CX303

Speaker System

S-CX303

CX505

DVD/CD Receiver

XV-CX505

Speaker System

S-CX505

CX500

DVD/CD Receiver

XV-CX500

Speaker System

S-CX500

Operating Instructions



IMPORTANT



The lightning flash with arrowhead symbol, within an equilateral triangle, is intended to alert the user to the presence of uninsulated "dangerous voltage" within the product's enclosure that may be of sufficient magnitude to constitute a risk of electric shock to persons.

CAUTION

**RISK OF ELECTRIC SHOCK
DO NOT OPEN**



CAUTION:
TO PREVENT THE RISK OF ELECTRIC SHOCK, DO NOT REMOVE COVER (OR BACK). NO USER-SERVICEABLE PARTS INSIDE. REFER SERVICING TO QUALIFIED SERVICE PERSONNEL.

The exclamation point within an equilateral triangle is intended to alert the user to the presence of important operating and maintenance (servicing) instructions in the literature accompanying the appliance.

D3-4-2-1_En-A

CAUTION

This product is a class 1 laser product, but this product contains a laser diode higher than Class 1. To ensure continued safety, do not remove any covers or attempt to gain access to the inside of the product. Refer all servicing to qualified personnel. The following caution label appears on your unit.

Location: top of the main unit

Taiwan model

CAUTION : CLASS 3B VISIBLE AND INVISIBLE LASER RADIATION WHEN OPEN, AVOID EXPOSURE TO THE BEAM.

注意：打開時會有CLASS 3B可見和不可見雷射輻射，請勿受雷射束輻射。

VRW2159

All other models

CAUTION CLASS 3B VISIBLE AND INVISIBLE LASER RADIATION WHEN OPEN, AVOID EXPOSURE TO THE BEAM.
ATTENTION RADIATIONS LASER VISIBLES ET INVISIBLES DE CLASSE 3B QUAND OUVREZ. EVITEZ TOUT EXPOSITION AU FUSIL/BEAM.
ADVARSEL KLASSE 3B SYNLIG OG USYNLIG LASERSTRÅLING VED ÅBNING. UNDGÅ UDSÆTTELSE FOR STRÅLING.
VARNING KLASSE 3B SYNLIG OCH OSYNLIG LASERSTRÅLING ÅR DENNA DEL ÄR ÖPPNAD. UNDVÄJ ATT UTSÄTTAS FÖR STRÅLEN.
VORSICHT BEI GEFÄHRLICHER ABDECKUNG IST SICHTBARE UND UNSICHTBARE LASERSTRAHLUNG DER KLASSE 3B IN GEWISSEN BEREICHEN VORHANDEN. NICHT DEM LASERSTRAHLUNGSEXIZIERT.
PRECAUCIÓN CUANDO SE ABRE HAY RADIACIÓN LASER DE CLASE 3B VISIBLE E INVISIBLE. EVITE LA EXPOSICIÓN A LOS RAYOS LASER.
VARO! KATKESKÄ OLET ALTIMA NÄYVÄLLE JÄNNÄYMATTOMALLE LUKKAN 3B LASERBÄTELTYLLE ÄLÄ KATSO SÄTEESEN. VRW2257-A

Location: bottom of the main unit

**CLASS 1
LASER PRODUCT**

D3-4-2-1-8_A_En

WARNING

This equipment is not waterproof. To prevent a fire or shock hazard, do not place any container filled with liquid near this equipment (such as a vase or flower pot) or expose it to dripping, splashing, rain or moisture.

D3-4-2-1-3_A_En

WARNING

Before plugging in for the first time, read the following section carefully.

The voltage of the available power supply differs according to country or region. Be sure that the power supply voltage of the area where this unit will be used meets the required voltage (e.g., 230 V or 120 V) written on the rear panel.

D3-4-2-1-4_A_En

WARNING

To prevent a fire hazard, do not place any naked flame sources (such as a lighted candle) on the equipment.

D3-4-2-1-7a_A_En

Operating Environment

Operating environment temperature and humidity:
+5 °C to +35 °C (+41 °F to +95 °F); less than 85 %RH
(cooling vents not blocked)

Do not install this unit in a poorly ventilated area, or in locations exposed to high humidity or direct sunlight (or strong artificial light)

D3-4-2-1-7c_A_En

VENTILATION CAUTION

When installing this unit, make sure to leave space around the unit for ventilation to improve heat radiation (at least 30 cm at top, 15 cm at rear, and 15 cm at each side).

WARNING

Slots and openings in the cabinet are provided for ventilation to ensure reliable operation of the product, and to protect it from overheating. To prevent fire hazard, the openings should never be blocked or covered with items (such as newspapers, table-cloths, curtains) or by operating the equipment on thick carpet or a bed.

D3-4-2-1-7b_A_En

For Australia Model



C67-7-3_En

CAUTION : USE OF CONTROLS OR ADJUSTMENTS OR PERFORMANCE OF PROCEDURES OTHER THAN THOSE SPECIFIED HEREIN MAY RESULT IN HAZARDOUS RADIATION EXPOSURE.

CAUTION : THE USE OF OPTICAL INSTRUMENTS WITH THIS PRODUCT WILL INCREASE EYE HAZARD. **D6-8-2-1_En**

Information to User

Alteration or modifications carried out without appropriate authorization may invalidate the user's right to operate the equipment. **D8-10-2_En**

CAUTION

The STANDBY/ON switch on this unit will not completely shut off all power from the AC outlet. Since the power cord serves as the main disconnect device for the unit, you will need to unplug it from the AC outlet to shut down all power. Therefore, make sure the unit has been installed so that the power cord can be easily unplugged from the AC outlet in case of an accident. To avoid fire hazard, the power cord should also be unplugged from the AC outlet when left unused for a long period of time (for example, when on vacation). **D3-4-2-2a_A_En**

This product is for general household purposes. Any failure due to use for other than household purposes (such as long-term use for business purposes in a restaurant or use in a car or ship) and which requires repair will be charged for even during the warranty period. **K041_En**

For Taiwan exclusively

Taiwanese two pin flat-bladed plug

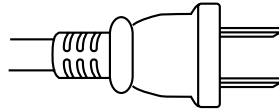

If the AC plug of this unit does not match the AC outlet you want to use, the plug must be removed and appropriate one fitted. Replacement and mounting of an AC plug on the power supply cord of this unit should be performed only by qualified service personnel. If connected to an AC outlet, the cut-off plug can cause severe electrical shock. Make sure it is properly disposed of after removal. The equipment should be disconnected by removing the mains plug from the wall socket when left unused for a long period of time (for example, when on vacation). **D3-4-2-2-1a_A_En**

Thank you for buying this Pioneer product.

Please read through these operating instructions so that you will know how to operate your model properly. After you have finished reading the instructions, put them in a safe place for future reference.

Contents

01 Before you start

Checking what's in the box	6
Loading the batteries	6
Range of the remote control unit	7
Attaching the non-skid pads	7
Placing the subwoofer	7
Removing the speaker grilles	7
Attaching the brackets	8
Wall-mounting the speakers	9

02 Connecting up

Connecting the speaker terminals	10
Multichannel speaker connections	12
Hints on speaker placement	12
Connecting the radio antennas	13
Connecting external antennas	13
Connecting to your TV	14
Connecting using the component video output	14
Connecting auxiliary components	15
Connecting the power	15

03 Controls and displays

Front panel	16
Display	17
Remote control	17

04 Getting started

Using the on-screen displays	20
Playing discs	20
Basic playback controls	21
Resume and Last Memory	21
DVD-Video disc menus	21
Video CD/Super VCD PBC menus	21
Listening to the radio	22
Improving FM stereo sound	22
Reducing AM reception noise	22
Memorizing stations	23
Manually saving station presets	23
Automatically saving station presets	23
Listening to station presets	23
Listening to other sources	23
Dimming the display	23

05 Setting up for surround sound

Home theater sound setup	24
Setting the channel levels	25

06 Home theater sound

About the listening modes	26
Auto listening mode	26
Listening in surround sound	26
Using Front Surround	27
Using the Front Surround mode	27
Using the Extra Power mode	27
Listening in stereo	27
Listening with headphones	27

07 Disc playback features

Scanning discs	28
Playing in slow motion	28
Frame advance/frame reverse	28
Playing a JPEG slideshow	28
Browsing DVD or Video CD/Super VCD discs with the Disc Navigator	29
Browsing WMA, MP3, MPEG-4 AAC, DivX video and JPEG files with the Disc Navigator	30
Looping a section of a disc	30
Using repeat play	30
Using random play	31
Creating a program list	31
Using the OSD	31
Other functions available from the program menu	32
Using the front panel display	32
Using Playlists	32
Programming playlists	32
Listening to playlists	33
Clearing files from a playlist	33
Searching a disc	33
Switching subtitles	33
Switching language/audio channels	34
Zooming the screen	34
Switching camera angles	34
Displaying disc information	34

08 USB playback

Using the USB interface	35
Basic playback controls.....	35
Scanning files	36
Playing a JPEG slideshow	36
Browsing files with the Navigator	36

09 Singing karaoke

Singing karaoke	37
Changing the vocal mix	37
Changing the backing track	37

10 Adjusting the sound

Using the Sound menu	38
Using the Sound Field Control.....	38
Boosting the bass level	39
Muting the sound	39

11 Audio Settings and Video Adjust menu

Audio Settings menu.....	40
Audio DRC	40
Virtual Surround	40
Video Adjust menu	40

12 Initial Settings menu

Using the Initial Settings menu.....	42
Video Output settings	42
Language settings	42
Display settings	43
Options settings	43
Parental Lock	43
About DivX® VOD content	44
Speaker Distance	45

13 Additional information

Optional system settings	46
System Setup menu options in standby	46
Setting the sleep timer.....	47
Disc/content format playback compatibility	47
Disc compatibility table.....	48
About DVD+R/DVD+RW compatibility.....	48
About DivX	48
About MPEG-4 AAC.....	49
About WMA	49
Using and taking care of discs.....	49
DVD Video regions	49
Handling discs	50
Storing discs	50
Discs to avoid	50
Installation and maintenance	50
Hints on installation	50
Cleaning the pickup lens.....	50
Problems with condensation.....	51
Moving the system unit	51
Screen sizes and disc formats	51
Resetting the system	51
Troubleshooting.....	52
General	52
DVD/CD/Video CD player.....	53
WMA/MP3/MPEG-4 AAC/JPEG discs	54
Tuner.....	54
USB connection	54
Error Messages.....	55
Using the language code list	55
Language code list.....	56
Country/Area code list	56
Specifications	57

Chapter 1

Before you start

Checking what's in the box

Please check that you've received the following supplied accessories:

- Remote control
- AA/R6 dry cell batteries (to confirm system operation) x2
- Video cord
- AM loop antenna
- FM antenna
- Power cord:
 - Duty free model x2
 - Argentine (CX303 only), Taiwan, Philippines models x2
 - All other models x1
- Power plug adapter x1 (CX303 Argentine model only)
- Speaker cables x5 (S-CX500 only)
- Brackets x2 (S-CX500 only)
- Screw x8 (S-CX500 only)
- Non-skid pads for center speaker x4 (S-CX505 only) / for front, center, surround speaker x24 (S-CX500 only)

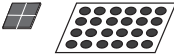

- Non-skid pads for front speaker x8 (S-CX505, S-CX303)



- Non-skid pads for surround speaker (S-CX505 only) x8



- Non-skid pads for subwoofer x4



- Spiral wrap x2 (S-CX500 only)
- These operating instructions

Loading the batteries

Use AA/R6 batteries with the supplied remote control. Make sure to follow the indications (+, -) inside the compartment.

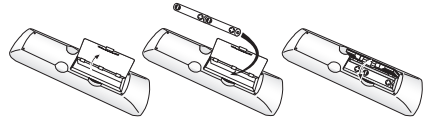

Important

Incorrect use of batteries may result in such hazards as leakage and bursting. Observe the following precautions:

- Never use new and old batteries together.
- Insert the plus and minus sides of the batteries properly according to the marks in the battery case.
- Batteries with the same shape may have different voltages. Do not use different batteries together.
- When disposing of used batteries, please comply with governmental regulations or environmental public instruction's rules that apply in your country or area.
- Do not use or store batteries in direct sunlight or other excessively hot place, such as inside a car or near a heater. This can cause batteries to leak, overheat, explode or catch fire. It can also reduce the life or performance of batteries.

Range of the remote control unit

The remote control has a range of about 7 meters. It may not work properly if:

- There are obstacles between the remote control and this unit's remote sensor.
- Direct sunlight or fluorescent light is shining onto the remote sensor.
- This system is located near a device that is emitting infrared rays.
- This unit is operated simultaneously with another infrared remote control unit.

Attaching the non-skid pads

Use the self-adhesive non-skid pads to provide a stable base for the speakers. Attach four to each speaker as shown below.

The illustration shows the CX505.

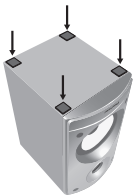

Front speaker

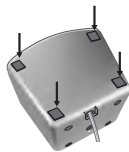

Surround speaker

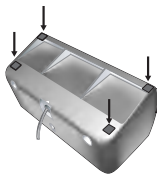

Center speaker

- *CX500 model only* – Attach the non-skid pads to four corners on the bottom surface of each speaker. (The shape of the speaker is different from the CX505 model)

- *CX303 model only* – Attach the non-skid pads to four corners on the bottom surface of the Front speaker.

Placing the subwoofer

The subwoofer supplied with this system can be placed upright or on its side (flat). Choose the position that works best for your room, then attach the non-skid pads as shown below.



Subwoofer



Caution

- Do not place other speakers (front/center/surround) on top of the subwoofer. There is a risk that they will fall and cause injuries.

Removing the speaker grilles

CX505/CX303 model only

If necessary, remove the front speaker grilles as described below.

1 Gently ease the grille loose by gripping the bottom and pulling towards you.

2 Pull the top free in the same way.

When reattaching, start from the top then push the bottom in until secure.

- It is not recommended (due to dirt and dust) to leave the speaker grilles removed.
- Do not install your speakers overhead on the ceiling or wall. If improperly attached, the speaker grille can fall and cause damage or personal injury.

Attaching the brackets

CX500 model only

Attach the brackets as described below. Before attaching, make sure to check which Home theater sound setup you want to use.¹

- **Stack the speakers and fix with the brackets.**

Each speaker is provided with a color-coded indicator on the model label on the rear side to assist identification. Refer to the color indicators and install the speakers correctly.

Standard surround/Front surround setup (Front surround mode):

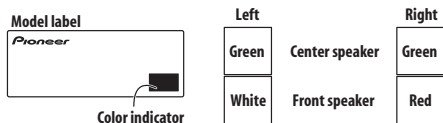

Front surround setup (Extra Power mode):

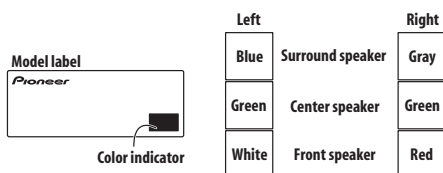

As shown in the illustration, stack the speakers. Align the bracket with the respective upper screw hole on the back of the front speaker and fasten the screws securely.

Standard surround/Front surround setup (Front surround mode):

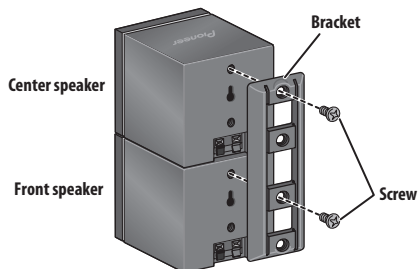

Front surround setup (Extra Power mode):

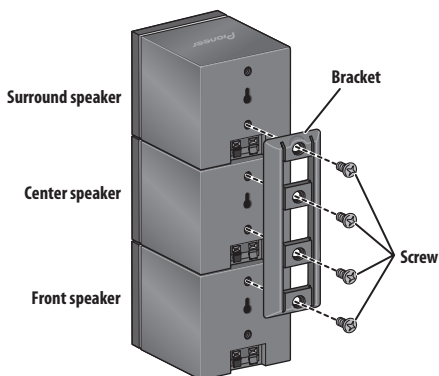

Caution

- Do not attempt to carry the speakers when they are connected with the bracket. Doing so may cause damage to the bracket or worsen damage to the bracket and speakers in the event they are dropped.

Note

¹ • Refer to *Home theater sound setup* on page 24 for details on how to place your speakers.

• Standard surround/Front surround setup (Front surround mode) only - Attaching brackets is necessary only when mounting center speakers to right and left.

Wall-mounting the speakers

CX505 – Center speaker, Surround speakers only

CX500 – Front speakers, Center speakers, Surround speakers

Depending on the speaker setup you choose, you can wall-mount the front, center and surround speakers. (When using Front surround setup, you can only wall-mount the center speaker.)

The illustration shows the CX505.

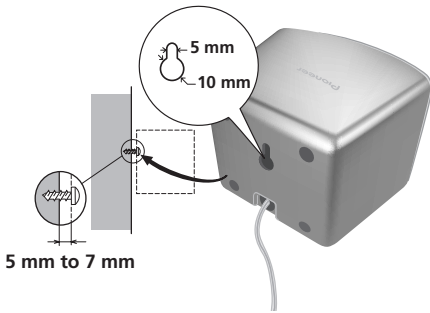

Caution

- If you are unsure of the qualities and strength of the walls, consult a professional for advice.
- Pioneer is not responsible for any accidents or damage that result from improper installation.
- *Subwoofer and (CX303/CX505 model only) front speakers only* – Do not attach these speakers to the wall or ceiling. They may fall off and cause injury.

Before mounting (see above), keep in mind the following points:

- Remember that the speaker system is heavy and that its weight could cause the screws to work loose, or the wall material to fail to support it, resulting in the speaker falling. Make sure that the wall you intend to mount the speakers on is strong enough to support them. Do not mount on plywood or soft surface walls.
- Mounting screws are not supplied. Use screws suitable for the wall material and support the weight of the speaker.

Chapter 2

Connecting up

Important

- Before making or changing any connections, switch off the power and unplug the power cord from the AC outlet.
- When making cable connections, make sure not to bend the cables over the top of this unit. This may cause a humming noise from the speakers.

Connecting the speaker terminals

Connect the wires from the speakers to the terminals on the main unit rear panel as shown below. Before connecting, you may want to consider the placement options available in your room, and when using this system:¹

- *CX303 model only* – Place the front left and right speakers at equal distances from the TV, then connect them as shown below.
- *CX505/CX500 model only* – A color-coded system is provided for speaker connections (see *Multichannel speaker connections* below). See *Home theater sound setup* on page 24 for surround placement options.

Caution

- Do not connect this speaker to any amplifier other than the one supplied with this system. Connection to any other amplifier may result in a malfunction or fire.
- Make sure that the bare speaker wires cannot touch each other, or come into contact with other metal parts once the unit is switched on.

- **Match the color-coded speaker plugs to the colored speaker terminals on the rear of the unit (as shown below).**

Make sure to insert completely. The small lug at the wire-end of the speaker plug should face up or down depending on whether it's being plugged into one of the upper or lower three speaker terminals. Please make sure to connect correctly.

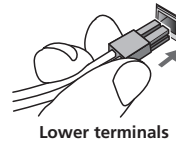
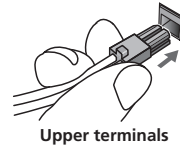

- **CX500 only: The front and surround speaker cables have a color-coded connector at one end and two bare wires at the other end.**

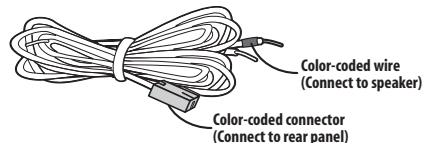

Note

¹ The speakers supplied with this system are magnetically shielded. However, placing them extremely close to a television may result in color distortion on the screen. If this happens, move the speakers a little further away and switch off the television for 15 to 30 minutes.

- Since there is only one terminal to connect the two center speakers, you will need to use the supplied Y-cable for the connection.
- Twist and pull off the protective shields on each wire.



- Connect the wires to the speaker. Each speaker in the illustration can be identified by means of the color-coded indicator provided on the rear-surface model label. Match the color-coded wire with the color indicator on the model label, then insert the color-coded wire into the red (+) side and the other wire into the black (-) side.

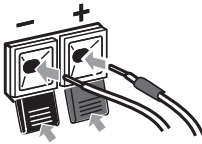

- When connecting the center speakers, connect the Y-cable dual end to the two center speakers in the same way.

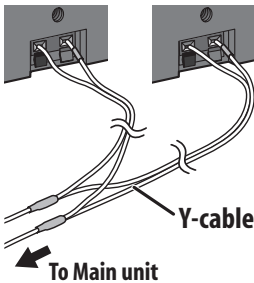

- When connections are completed, adjust the cable placements. If the speakers have been fixed with the brackets, fix the cable to the groove in the brackets as shown.

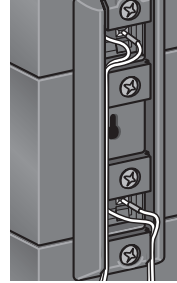

- Fasten the cables together with the spiral wrap. Hold multiple cables together and place the wrap over the cables from the end. Wrap the spiral wrap with the cables in the center. The spiral wrap may be cut at a desired length.

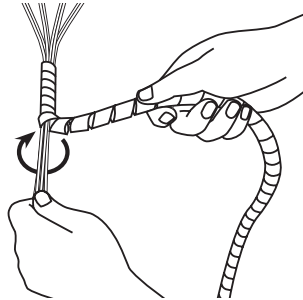

Multichannel speaker connections

CX505/CX500 model only

Connect each speaker using the color-coded speaker cable. Match them to the colored labels above the speaker terminals (see illustration below).

The illustration shows the CX505.

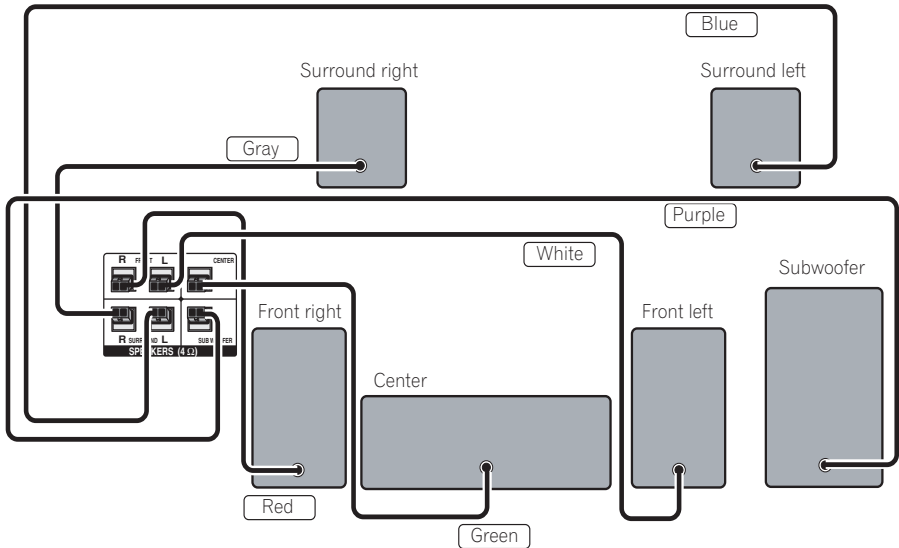

Hints on speaker placement

The following guidelines will help you to get the best performance from your speaker system. See *Home theater sound setup* on page 24 for surround placement options with this system.

- Place the front left and right speakers at equal distances from the TV.
- Place the center speaker above or below the TV so that the sound of the center channel is localized at the TV screen.
- If possible, place the surround speakers slightly above ear level.



Caution

- These speaker terminals carry **HAZARDOUS LIVE VOLTAGE**. To prevent the risk of electric shock when connecting or disconnecting the speaker cables, disconnect the power cord before touching any uninsulated parts.
- If you choose to install the center speaker on top of the TV, be sure to secure it with putty, or by other suitable means, to reduce the risk of damage or injury resulting from the speaker falling from the TV in the event of external shocks such as earthquakes.

- Try not to place the surround speakers further away from the listening position than the front and center speakers. Doing so can weaken the surround sound effect.
- Make sure all speakers are installed securely to prevent accidents and improve sound quality.
- *Subwoofer and (CX505 model only) front speakers only* – Do not attach these speakers to the wall or ceiling. They may fall off and cause injury.

Connecting the radio antennas

Connecting the supplied antennas will allow you to listen to both AM and FM radio broadcasts. If you find that reception quality is poor, an outdoor antenna should give you better sound quality — see *Connecting external antennas* below for more on how to do this.

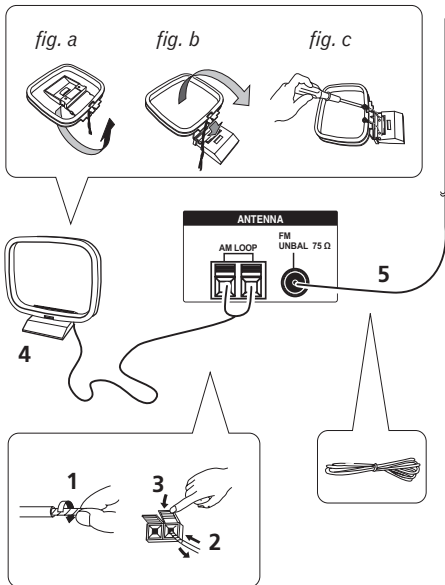

1 Pull off the protective shields of both AM antenna wires.

2 Push open the tabs, then insert one wire fully into each terminal, then release the tabs to secure the AM antenna wires.

3 Fix the AM loop antenna to the stand.

To fix the stand to the antenna, bend in the direction indicated by the arrow (*fig. a*) then clip the loop onto the stand (*fig. b*).

- If you plan to mount the AM antenna to a wall or other surface, secure the stand with screws (*fig. c*) before clipping the loop to the stand. Make sure the reception is clear.

4 Place the AM antenna on a flat surface and point in the direction giving the best reception.

Don't let it come into contact with metal objects and avoid placing near computers, television sets or other electrical appliances.

5 Connect the FM wire antenna in the same way as the AM loop antenna.

For best results, extend the FM antenna fully and fix to a wall or door frame. Don't drape loosely or leave coiled up.

Connecting external antennas

External AM antenna

Use 5 to 6 meters of vinyl-insulated wire and set up either indoors or outdoors. Leave the AM loop antenna connected.

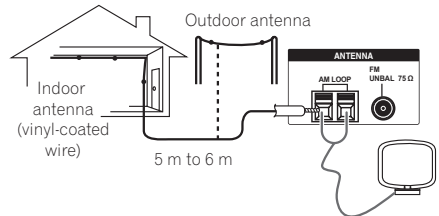

External FM antenna

Use a PAL connector to hook up an external FM antenna.

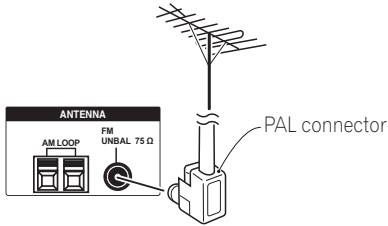

Connecting to your TV

This system offers three types of video connections. If your TV has component video inputs, see *Connecting using the component video output* below.

- 1 Use the supplied yellow video cable to connect the VIDEO OUT jack to a video input on your TV.



- 2 **Optionally:** Use a stereo audio cable to connect the audio outs of your TV (or VCR) to the LINE IN jacks on the rear of this unit.

This will enable you to hear the TV (or VCR) sound through this system. See *Connecting auxiliary components* below for more on this.

Connecting using the component video output

If your TV has component video inputs, you can use these instead of the standard video output to connect this system to your TV.¹ This should give you the best quality picture from the three types of video output available.

- Use a component video cable to connect the COMPONENT VIDEO OUT to a set of component inputs on your TV.

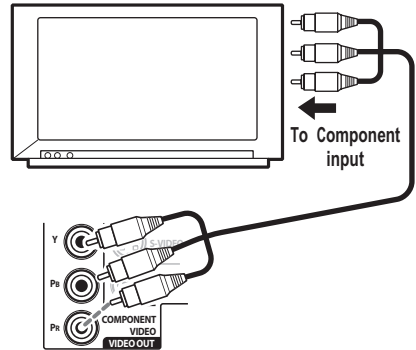

About progressive scan video

Compared to interlace video, progressive scan video effectively doubles the scanning rate of the picture, resulting in a very stable, flicker-free image. Progressive scan video is available only from the component video output.

Compatibility of this player with progressive-scan and high-definition TVs.

This player is compatible with progressive video Macro Vision System Copy Guard.²

Note

¹ The component video output is switchable between interlaced and progressive formats. See *Video Output settings* on page 42.
² Consumers should note that not all high-definition television sets are fully compatible with this product and may cause artifacts to be displayed in the picture. In case of 525 progressive scan picture problems, it is recommended that the user switch the connection to the 'standard definition' output (Interlace). If there are questions regarding our TV set compatibility with this model, please contact our customer service center.

Connecting auxiliary components

This system has a front panel audio input as well as stereo analog inputs on the rear panel.

- See *Using the USB interface* on page 35 to connect the front panel **USB INPUT**.
- **Connect the LINE IN jacks on the rear panel to an auxiliary playback component.** These include components such as a VCR, cassette deck, or your TV. Connect using RCA pin-plug stereo cables.
- **Connect the front panel AUDIO IN mini-plug jack to an auxiliary playback component.**

These include components like a digital audio player or the analog audio output of a PC. Connect using a 1/4" stereo mini-plug cable.

Connecting the power

After making sure that everything is connected properly, connect the Media unit and the Power unit with attached cord, then plug in the power cord to the AC inlet, and the other end to a mains power outlet.

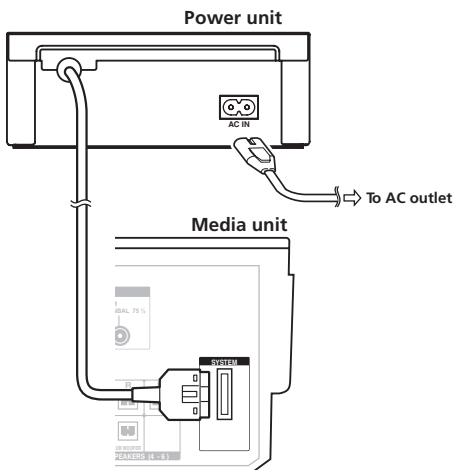

Congratulations! You're done setting up.

POWER-CORD CAUTION

Handle the power cord by the plug. Do not pull out the plug by tugging the cord and never touch the power cord when your hands are wet as this could cause a short circuit or electric shock. Do not place the unit, a piece of furniture, etc., on the power cord, or pinch the cord. Never make a knot in the cord or tie it with other cords. The power cords should be routed such that they are not likely to be stepped on. A damaged power cord can cause a fire or give you an electrical shock. Check the power cord once in a while. When you find it damaged, ask your nearest PIONEER authorized service center or your dealer for a replacement.

Chapter 3

Controls and displays

Front panel

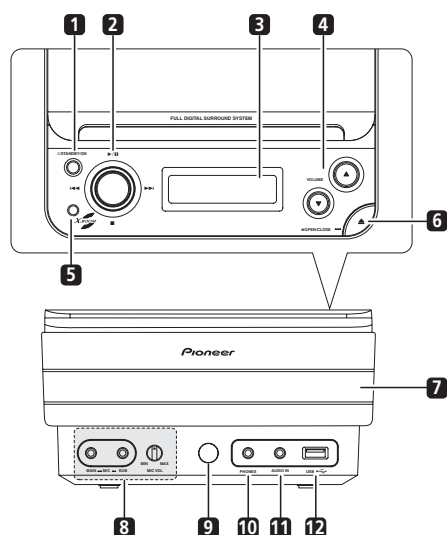
**1** **STANDBY/ON**

Switches the player on or into standby.

2 **Playback controls**

The skip buttons are used for skipping on discs. The playback control buttons are used for playing, pausing and stopping playback.

3 **Display**

See *Display* on page 17.

4 **VOLUME**

Adjusts the volume level.

5 **X.BOOM button**

Switches on the bass boost (page 39).

6 **OPEN/CLOSE**

Opens/closes the disc tray.

7 **Disc tray****8** **MIC VOL and MIC input jacks**

Controls the volume of the karaoke mics (**MAIN** and **SUB**) (page 37).

9 **Remote sensor****10** **PHONES jack**

Headphone jack.

11 **AUDIO IN**

Connect an auxiliary component using a stereo mini-jack cable (see *Connecting auxiliary components* on page 15).

12 **USB interface**

Connect a USB device for playback (see *USB playback* on page 35).

Display

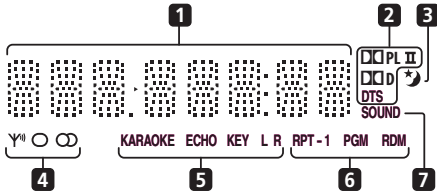

1 Character display

2 Format indicators

PL II (CX505/CX500 only) – Lights during Dolby Pro Logic II decoding.

D – Lights during playback of a Dolby Digital source.

DTS – Lights during playback of a DTS source.

3 *

Lights when the sleep timer is active.

4 Tuner indicators

Y – Lights when a broadcast is being received.

○ – Lights when FM mono reception is selected.

∞ – Lights when a stereo FM broadcast is being received in auto stereo mode.

5 Karaoke indicators

KARAOKE (Vocal cancel) – Vocals in the backing track are partially eliminated using EQ.

ECHO – Lights when the Karaoke **ECHO** effect is selected.

KEY – Lights when the Karaoke pitch control is selected.

L – Left channel only. Use for tracks that have a vocal recorded in the right channel.

R – Right channel only. Use for tracks that have a vocal recorded in the left channel.

L R – Use to put a single-channel vocal track into the center of the mix.

6 Playback mode indicators

RPT-1 – **RPT** lights during repeat play (**RPT-1** lights during repeat one-track play).

PGM – Lights during program play.

RDM – Lights during random playback.

7 SOUND

Lights when the SFC modes, **XBOOM**, bass, treble, **ST.WIDE**, **MP3 EXP.** (MP3 Expander) or **VOICE. E.** (Voice Enhancer) are active.

Remote control

The illustration shows the CX505/CX500.

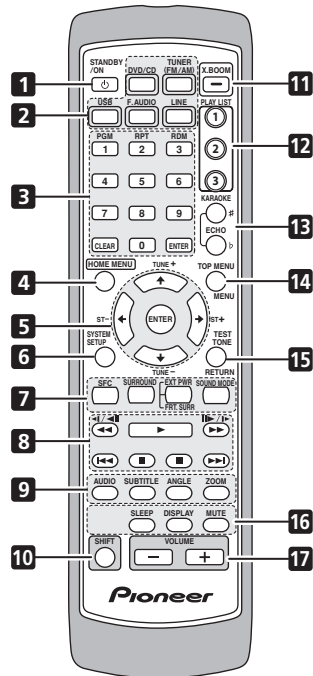

1 ⏻ STANDBY/ON

Switches the player on or into standby.

2 Input source function select

Selects the source you want to listen to.

3 Number buttons and SHIFT functions

The number buttons can be used for selecting tracks directly, the functions above the buttons are accessed by pressing **SHIFT** at the same time as the button.

PGM (SHIFT + 1) – Use to program/play a program list (page 31).

RPT (SHIFT + 2) – Selects a repeat play mode (page 30).

RDM (SHIFT + 3) – Selects a random play mode (page 31).

CLEAR – Clears an entry.

ENTER – Selects menu options, etc.

4 HOME MENU

Press to display (or exit) the on-screen menu for Initial Settings, Play Mode functions, etc.

5 ENTER, TUNE & cursor control buttons

Navigates on-screen displays and menus.

ENTER selects an option or executes a command.

6 SYSTEM SETUP

Use to make various system settings (page 46). Also used when saving station presets when using the tuner (page 23).

7 Sound Field/listening mode buttons

SFC – Selects sound modes or custom settings from the Sound Field Control (page 38).

SURROUND (CX505/CX500 only) – Selects a surround listening mode (page 26).

EXT PWR (CX505/CX500 only) – Switches on the Extra Power mode (page 27).

FRT.SURR (CX505/CX500 only) – Switches on the Front Surround mode (page 27).

SOUND MODE – Accesses settings in the Sound menu, such as the tone controls (page 38).

8 Playback controls

▶ – Starts/resumes playback.

◀◀ and ◀I/◀II – Use for reverse slow motion playback, frame reverse and reverse scanning.

▶▶ and II▶/II – Use for forward slow motion playback, frame advance and forward scanning.

▶▶▶ – Jumps to the next chapter or track.

I◀◀ – Jumps to the beginning of the current chapter or track, then to previous chapters/tracks.

II – Pauses playback; press again to restart.

■ – Stops playback.

9 DVD controls

AUDIO – Selects the audio channel or language (page 34).

SUBTITLE – Selects a subtitle display (page 33).

ANGLE – Changes the camera angle during DVD multi-angle scene playback (page 34).

ZOOM – Changes the zoom level (page 34).

10 SHIFT

Press to access the functions/commands written in green on the remote.

11 X.BOOM

Switches the bass boost on or off (page 39).

12 PLAY LIST buttons

Adds tracks to (during playback), or selects the playlist (while stopped) (page 32).

13 KARAOKE controls

KARAOKE – Selects audio channels for karaoke (page 37).

ECHO – Changes the echo level on the karaoke mics (page 37).

/ b – Raises/lowers the pitch of the backing track (page 37).

14 MENU

Displays the DVD menu (for Video CD/Super VCDs, DivX video and WMA/MP3/MPEG-4 AAC/JPEG discs, the Disc Navigator screen appears).

TOP MENU (SHIFT + MENU)

Displays the top menu of a DVD disc.

15 RETURN

Press to return to a previous menu screen.

TEST TONE (SHIFT+RETURN)

(CX505/CX500 only) – Press to output the test tone for speaker setup (page 25).

16 SLEEP

Press to set the sleep timer (page 47).

DISPLAY

Switches between information displays (page 34).

MUTE

Mutes the volume (page 39).

17 VOLUME

Adjusts the volume level.

Chapter 4

Getting started

Using the on-screen displays

For ease of use, this system makes extensive use of graphical on-screen displays (OSDs).

All the screens are navigated in basically the same way, using the cursor buttons (↑, ↓, ←, →) to change the highlighted item and pressing **ENTER** to select it.¹



Important

- Throughout this manual, 'Select' means use ↑/↓/←/→ to highlight an item on-screen, then press **ENTER**.

Button	What it does
HOME MENU	Displays/exits the on-screen display
← ↑ ↓ →	Changes the highlighted menu item
ENTER	Selects the highlighted menu item
RETURN	Returns to the main menu without saving changes



Tip

- You can change the On-Screen Display Language to Traditional Chinese (see *OSD Language* on page 43)
- The button guide at the bottom of every OSD screen shows you which buttons you'll need to use for that screen.

Playing discs

The basic playback controls for DVD, CD, Video CD/Super VCD, DivX video and WMA/MP3/MPEG-4 AAC discs are covered here. Further functions are detailed in chapter 7.

Note

¹ The screen saver will appear after five minutes of inactivity.

1 If the player isn't already on, switch it on.

If you're playing a disc with video, also turn on your TV and make sure that it is set to the correct video input.

2 Press ▲ OPEN/CLOSE on the front panel to load a disc.

Load a disc with the label side facing up, using the disc tray guide to align the disc (if you're loading a double-sided DVD disc, load it with the side you want to play face down).



3 Press ► (play) to start playback.

If you're playing a DVD or Video CD/Super VCD, a menu may appear. See *DVD-Video disc menus* and *Video CD/SuperVCD PBC menus* on page 21 to navigate these.

If you loaded a disc containing JPEGs, a slideshow will start. See *Playing a JPEG slideshow* on page 28 for more on this.

- If a disc contains a mixture of DivX video and other media file types (MP3, for example), first select whether to play the DivX video files (**DivX**) or the other media file types (**MP3/WMA/MPEG-4 AAC/JPEG**) from the on-screen display.

4 Adjust the volume.

Use the **VOLUME** control.

Basic playback controls

The following table shows the basic controls on the remote for playing discs¹. You can find other playback features in the chapter 7.

Button	What it does
▶	Starts/resumes normal playback. <ul style="list-style-type: none"> • If the display shows RESUME or LAST MEM playback starts from the resume or last memory point (see <i>Resume and Last Memory</i> below).
⏏	Pauses/unpauses a disc.
■	Stops playback or cancels the resume function (if the display shows RESUME).
⏮	Press to start fast reverse scanning.
⏭	Press to start fast forward scanning.
⏮⏮	Skips to the start of the current track or chapter, then previous tracks/chapters.
⏭⏭	Skips to the next track or chapter.
Numbers	Use to enter a title/chapter/track number. Press ENTER to select. <ul style="list-style-type: none"> • If the disc is stopped, playback starts from the selected title (for DVD) or track (for CD/Video CD/Super VCD). • If the disc is playing, playback jumps to the start of the selected title (VR mode DVD-R/-RW), chapter (DVD-Video) or track (CD/Video CD/Super VCD).

Resume and Last Memory

When you stop playback of a disc, **RESUME** shows in the display indicating that you can resume playback from that point.

With DVDs and Video CD/Super VCDs, even if ejected, the play position is stored in memory.² The next time you load the disc, the display shows **LAST MEM** and you can resume playback.

Note

¹ You may find with some DVD discs that some playback controls don't work in certain parts of the disc.

² • The Last Memory function may not work with some discs.

• For DVD-Video discs (except VR mode DVD-R/-RW), the player stores the play position of the last five discs.

If you want to clear the resume point, press ■ (stop) while **RESUME** is displayed.

DVD-Video disc menus

Many DVD-Video discs contain menus from which you can select what you want to watch. Sometimes DVD-Video menus are displayed automatically when you start playback; others only appear when you press **MENU** or **TOP MENU (SHIFT+MENU)**.

Button	What it does
TOP MENU (SHIFT+MENU)	Displays the 'top menu' of a DVD disc — this varies with the disc.
MENU	Displays a DVD disc menu — this varies with the disc and may be the same as the 'top menu'.
← ↑ ↓ →	Moves the cursor around the screen.
ENTER	Selects the current menu option.
RETURN	Returns to the previously displayed menu screen.
Numbers	Highlights a numbered menu option (some discs only). Press ENTER to select.

Video CD/Super VCD PBC menus

Some Video CD/Super VCDs have menus from which you can choose what you want to watch. These are PBC (Playback control) menus.

You can play a PBC Video CD/Super VCD without having to navigate the PBC menu by starting playback using a number button to select a track, rather than the ▶ (play) button.

Button	What it does
RETURN	Displays the PBC menu.

Button	What it does
Numbers	Selects numbered menu options. Press ENTER to select.
◀◀	Displays the previous menu page (if there is one).
▶▶	Displays the next menu page (if there is one).

Listening to the radio

The tuner can receive both FM and AM broadcasts, and lets you memorize your favorite stations so you don't have to manually tune in every time you want to listen (see *Memorizing stations* on page 23 for more on this).

1 Press **TUNER (FM/AM)** to switch to the tuner, then press repeatedly to select the **AM** or **FM** band.

The display shows the band and frequency.

2 Tune to a frequency.

There are three tuning modes — manual, auto, and high-speed:

- **Manual tuning:** Press **TUNE +/-** repeatedly to change the displayed frequency.
- **Auto tuning:** Press and hold **TUNE +/-** until the frequency display starts to move, then release. The tuner will stop on the next station it finds. Repeat to keep searching.
- **High-speed tuning:** Press and hold **TUNE +/-** until the frequency display starts to move rapidly. Keep the button held down until you reach the frequency you want. If necessary, fine tune the frequency using the manual tuning method.

Improving FM stereo sound

If you're listening to an FM station in stereo but the reception is weak, you can improve the sound quality by switching to mono.

1 Tune to an FM radio station then press **SYSTEM SETUP**.

2 Use **◀/▶** to choose **FM MODE** then press **ENTER**.

3 Use **↑/↓** to select **FM MONO** then press **ENTER**

The **MONO** indicator lights when the tuner is in mono reception mode.

Select **FM AUTO** above to switch back to auto-stereo mode (the **◉** indicator lights when receiving a stereo broadcast).

Reducing AM reception noise

If AM reception seems particularly poor, or the AM radio station you're listening to seems noisy, try using the Noise Cut feature for better sound quality.

1 Tune to an AM radio station then press **SYSTEM SETUP**.

2 Use **◀/▶** to choose **NOISECUT** then press **ENTER**.

3 Use **↑/↓** to select the noise cut mode then press **ENTER**.

Select an effect level between 1 and 3.

Memorizing stations

You can save up to 30 station presets so that you always have easy access to your favorite stations without having to tune in manually each time.

Manually saving station presets

- 1 Tune to an AM or FM radio station.**
Select mono or auto-stereo reception (FM) or the Noise Cut mode (AM) as necessary. These settings are saved along with the preset.
- 2 Press SYSTEM SETUP and use ◀/▶ to choose 'ST.MEM.' then press ENTER.**
- 3 Use ↑/↓ to select the station preset you want then press ENTER.**

Automatically saving station presets

- 1 Press SYSTEM SETUP, use ◀/▶ to choose 'A. PRESET' then press ENTER.**
Auto tuning starts in the FM band, stopping when a strong signal is received.
- 2 When auto tuning stops at a station, press ENTER to save the station as a preset, or press ↑/↓ to continue without saving.**
Auto tuning resumes. After the FM band is finished, auto tuning continues in the AM band. Press ■ (stop) anytime to exit.
Auto tuning stops automatically after the AM band is finished, or after the limit of 30 presets has been reached. When this happens, the tuner automatically switches to preset **ST-1**.

Listening to station presets

- 1 Make sure the TUNER function is selected.**
- 2 Use ◀/▶ to select a station preset.**
 - You can also use the number buttons and **ENTER** to do this.

Listening to other sources

You can connect an external source for playback through this system's speakers. See *Connecting auxiliary components* on page 15 for more on this.

- To connect a USB device to the USB terminal, see *USB playback* on page 35.
- 1 Make sure that the external source (TV, MD player, etc.) is switched on.**
 - 2 Press LINE to select the source connected to the rear panel LINE input and F. AUDIO to select the source connected to the front panel AUDIO-IN input.**
 - 3 If necessary, start playback of the source.**

Dimming the display

You can choose one of two brightness settings for the front panel display.

- 1 Press SYSTEM SETUP and use ◀/▶ to choose DIMMER then press ENTER.**
- 2 Use ↑/↓ to adjust then press ENTER to confirm and exit.**
 - DIMMER 1:** Front panel display dims.
 - DIMMER 2:** Front panel display dims and automatically turns the display off after the unit has been left for two minutes.¹
 - OFF:** Front panel display returns to the original brightness.

Note

¹ When any key is pressed, the display turns on.

Chapter 5

Setting up for surround sound

CX505/CX500 model only

Home theater sound setup

Depending on the size and characteristics of your room, you can place your speakers in one of two ways using this system:¹

- **Standard surround setup** – This is a standard multichannel surround sound speaker setup for optimal 5.1 channel home theater sound.

CX505 model speaker configuration:

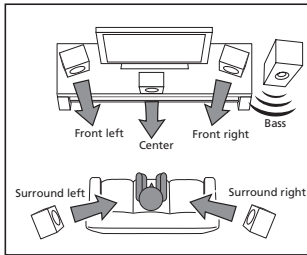

CX500 model speaker configuration:

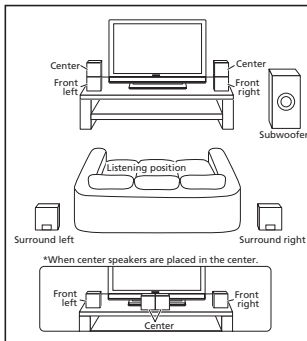

- **Front surround setup** – This setup is ideal when rear surround speaker placement isn't possible or you want to avoid running long speaker cables in your listening area. Use this setup together with the Front Surround modes to take advantage of wall and ceiling reflections for a very realistic surround effect.

CX505 model speaker configuration:

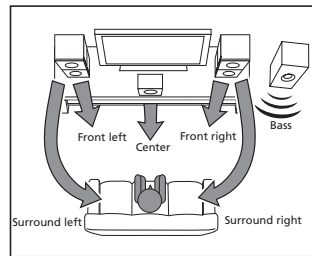

CX500 model speaker configuration:

For Front surround mode

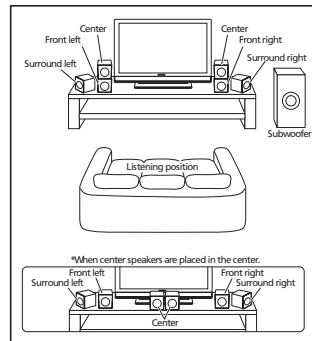

Note

¹ See *About the listening modes* on page 26 for more on using the different listening modes with each speaker setup.

For Extra Power mode

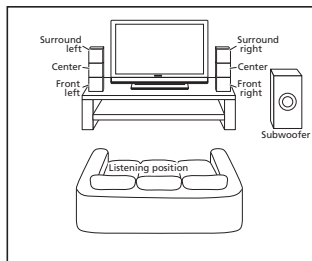

After placing your speakers, complete *Setting the channel levels* then refer to *Speaker Distance* on page 45 to complete your surround sound setup.

Setting the channel levels

Set the relative channel levels from your main listening position.¹

1 Switch to the DVD/CD or USB input source.

2 Press TEST TONE (SHIFT+RETURN).

The test tone is output in the following order (from the speakers active in the current listening mode):

- **L** – Front left speaker
- **C** – Center speaker
- **R** – Front right speaker
- **SR** – Surround right speaker
- **SL** – Surround left speaker
- **SW** – Subwoofer²

3 Use the VOLUME +/- button to adjust the volume to an appropriate level.

You can also use the front panel volume button.

4 Use the ↑/↓ buttons to adjust the speaker levels in turn.

You should hear the test tone at the same volume from each speaker when seated in the main listening position. The channel level range is ± 10 dB.

5 When you're done, press TEST TONE (SHIFT+RETURN) to exit test tone setup.

Note

¹ • Make sure headphones are unplugged.

• The channel balance can be adjusted (independently for each listening mode) while listening to any sound source you want: Press **SYSTEM SETUP** and use **←/→** to choose **CH LEVEL** then press **ENTER**, then use **←/→** to select channels and **↑/↓** to adjust the level. Press **ENTER** when you're finished.

² Since the subwoofer produces ultra-low frequencies its sound may seem quieter than it actually is.

Chapter 6

Home theater sound

CX505/CX500 model only

About the listening modes

As explained in *Home theater sound setup* on page 24, there are two basic surround speaker setup options available. Of course you can select any of the listening modes regardless of how you place your speakers, but you will achieve the best surround effect by using the listening modes in conjunction with your speaker setup:

- **Standard surround setup** – Use the Standard (*Listening in surround sound* below) surround listening modes with this setup.
- **Front surround setup** – See *Using Front Surround* on page 27 for the options available with this speaker setup.

Make sure you have completed *Setting the channel levels* on page 25.

Auto listening mode

The Auto listening mode is the simplest way to listen to any source as it was mastered: the output from the speakers mirrors the channels in the source material.

- **Press SURROUND to select the AUTO listening mode.**¹

Listening in surround sound

You can listen to stereo or multichannel sources in surround sound. Surround sound is generated from stereo sources using one of the Dolby Pro Logic decoding modes.

1 Switch to the DVD/CD or USB input source.

2 Press SURROUND repeatedly to select a listening mode.

The choices that appear in the display will vary according to the type of source that's playing.

- **AUTO** – Auto listening mode (see above)
- **DOLBY PL** (Dolby Pro Logic) – 4.1 channel surround sound for use with any two-channel source
- **MOVIE** (Dolby Pro Logic II Movie) – Pro Logic II 5.1 channel surround sound, especially suited to movie sources (use with any two-channel source)
- **MUSIC** (Dolby Pro Logic II Music) – Pro Logic II 5.1 channel surround sound, especially suited to music sources, for use with any two-channel source
- **STEREO** – See *Listening in stereo* below

Note

¹ If the source is Dolby Digital or DTS, the corresponding indicator lights in the front panel display.

Using Front Surround

The Front Surround mode and Extra Power mode are effective when **DVD/CD** or **USB** is selected as the input source and you are using the Front surround speaker setup as described in *Home theater sound setup* on page 24.

Using the Front Surround mode

- *CX505 model* – The surround speakers should be placed *on top* of the front speakers and oriented (about 60°) towards the walls.

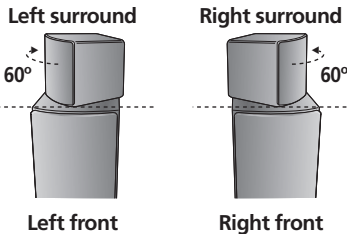

- *CX500 model* – The surround speakers should be placed *beside* the front speakers and oriented (about 60°) towards the walls.

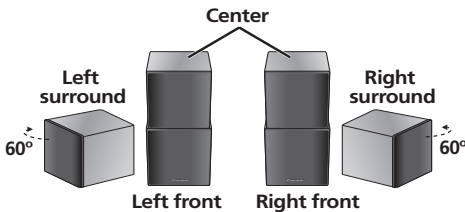

- Press **EXT PWR/FRT.SURR** to select the **Front Surround mode**.
- **FRT.SURR** – Use to provide rich surround sound effect.
- **OFF** – Switches the Front Surround mode off.

Using the Extra Power mode

The Extra Power mode uses the Front surround setup as described in *Home theater sound setup* on page 24, but the surround speakers and (CX500 only) center speakers should be pointed in the same direction as the front speakers (towards the listening position).

- Press **EXT PWR/FRT.SURR** to select the **Extra Power mode**.
- **EXT POWER** – Outputs stereo sound (in the case of multi-channel sources, down-mixed stereo sound) from the surround speakers for powerful stereo effect.
- **OFF** – Switches the Extra Power mode off.

Listening in stereo

You can listen to any source — stereo or multichannel — in stereo. When playing a multichannel source, all channels are downmixed to the front left/right speakers and the subwoofer.

- Press **SURROUND** repeatedly until **STEREO** shows in the display.

Listening with headphones

When headphones are connected, only the **STEREO** mode is available.¹

Note

¹ When you disconnect them it reverts to the previous mode.

Chapter 7

Disc playback features



Important

- Many of the functions covered in this chapter apply to DVD discs, Video CDs/Super VCDs, CDs, DivX video and WMA/MP3/MPEG-4 AAC/JPEG discs, although the exact operation of some varies slightly with the kind of disc loaded.
- Some DVDs restrict the use of some functions (random or repeat, for example) in some or all parts of the disc. This is not a malfunction.
- When playing Video CD/Super VCDs, some of the functions are not available during PBC playback. If you want to use them, start the disc playing using a number button to select a track.

Scanning discs

You can fast-scan discs forward or backward at various different speeds.¹

- **During playback, press ◀◀ or ▶▶ to start scanning.**

Press repeatedly to increase the scanning speed (shown on-screen).

- To resume playback, press ▶ (play).²

Playing in slow motion

You can play DVDs, Video CD/Super VCDs and DivX video at four different forward slow motion speeds. DVD discs can also be played in reverse slow motion.

Note

¹ Only one speed is available for DivX video discs.

² Depending on the disc, normal playback may automatically resume when a new chapter is reached on a DVD disc.

• For Video CDs/Super VCDs in PBC mode and WMA/MP3/MPEG-4 AAC tracks (in Scan Mode only), normal playback resumes when you reach the beginning or the end of a track.

³ The time it takes for the player to load a file increases with large file sizes.

• Discs can contain up to 299 folders and up to 648 folders and files combined.

- 1 **During playback, press II (pause).**

- 2 **Press and hold ◀/◀II or II/▶ until slow motion playback starts.**

Press repeatedly to change the slow motion speed (shown on-screen).

- To resume playback, press ▶ (play).²

Frame advance/frame reverse

With DVD discs, you can move advance/back frame-by-frame. With Video CD/Super VCDs and DivX video you can only use frame advance.

- 1 **During playback, press II (pause).**

- 2 **Press ◀/◀II or II/▶ to reverse or advance a frame at a time.**

- To resume playback, press ▶ (play).²

Playing a JPEG slideshow

After loading a disc containing JPEG pictures, press ▶ to start a slideshow from the first folder/picture on the disc.³ The player displays the pictures in each folder in alphabetical order.

- If the disc contains WMA/MP3/MPEG-4 AAC files, playback of the slideshow and audio files repeats. During audio playback, you can still use the skip (I◀◀/▶▶I), scan (◀◀/▶▶) and pause (II) functions.

Pictures are automatically adjusted so that they fill as much of the screen as possible.

While the slideshow is running:

Button	What it does
	Pauses the slideshow (or audio); press again to restart.
⏮	Jumps to the previous picture (or audio file with audio playback).
⏭	Jumps to the next picture (or audio file with audio playback).
⏪/⏩/⏴/⏵	Pauses the slideshow and rotates/flips the displayed picture (Press ▶ (play) to restart slideshow).
ZOOM	Pauses the slideshow and zooms the picture. Press again to toggle between 1x, 2x and 4x zoom (Press ▶ (play) to restart slideshow).
MENU	Displays the Disc Navigator screen (see below).

Browsing DVD or Video CD/ Super VCD discs with the Disc Navigator

Use the Disc Navigator to browse through the contents of a DVD or Video CD/Super VCD disc to find the part you want to play.

1 During playback, press HOME MENU and select 'Disc Navigator' from the on-screen menu.



2 Select a view option.

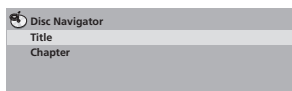

The options available depend on the kind of disc loaded and whether the disc is playing or not, but include:

- **Title** – Titles from a DVD-Video disc.
- **Chapter** – Chapters from the current title of a DVD-Video disc.
- **Track** – Tracks from a Video CD/Super VCD disc.
- **Time** – Thumbnails from a Video CD/Super VCD disc at 10 minute intervals.
- **Original: Title** – Original titles from a VR mode DVD-R/-RW disc.
- **Playlist: Title** – Playlist titles from a VR mode DVD-R/-RW disc.
- **Original: Time** – Thumbnails from the Original content at 10 minute intervals.
- **Playlist: Time** – Thumbnails from the Playlist at 10 minute intervals.

The screen shows up to six moving thumbnail images displayed one after another. To display the previous/next six thumbnails, press ⏮/⏭.

3 Select the thumbnail image for what you want to play.

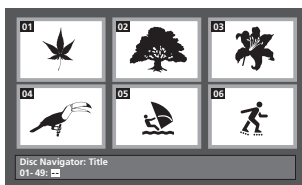

You can use either the ⏴/⏵/⏪/⏩ and **ENTER** to select a thumbnail, or the number buttons.

To select using the number buttons, enter a two-digit number then press **ENTER**.

Browsing WMA, MP3, MPEG-4 AAC, DivX video and JPEG files with the Disc Navigator

Use the Disc Navigator to find a particular file or folder by filename.

1 Press HOME MENU and select 'Disc Navigator' from the on-screen menu.

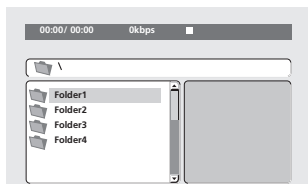

2 Use ↑/↓/←/→ and ENTER to navigate.

Use ↑/↓ to move up/down the folder/file list.

Use ← to return to the parent folder.¹

Use ENTER or → to open a highlighted folder.

- When a JPEG file is highlighted, a thumbnail image is displayed on the right.

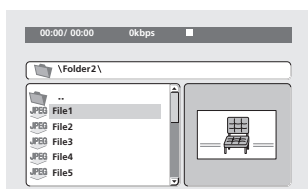

3 To play the highlighted track or DivX video file or display the highlighted JPEG file, press ENTER.

- When a WMA/MP3/MPEG-4 AAC or DivX video file is selected, playback begins from that file, and continues until the end of the folder.
- When a JPEG file is selected, a slideshow begins, starting with that file, and continues to the end of the folder.



Tip

- You can also play a JPEG slideshow while listening to WMA/MP3/MPEG-4 AAC playback. Simply select the audio file you want to listen to followed by the JPEG from which you want the slideshow to start. Playback of both the slideshow and the audio files repeats. Playback controls are effective for the JPEG slideshow only.
- To play the contents of the whole disc rather than just the current folder, exit the Disc Navigator and start playback using the ► (play) button.

Looping a section of a disc

The A-B Repeat function allows you to specify two points (A and B) within a track (CD, Video CD/Super Video CD) or title (DVD) that form a loop which is played over and over.

1 During playback, press HOME MENU and select 'Play Mode'.

2 Select 'A-B Repeat'.

3 Press ENTER on 'A (Start Point)' to set the loop start point.

4 Press ENTER on 'B (End Point)' to set the loop end point.

After pressing ENTER, playback jumps back to the start point and plays the loop.

5 To resume normal playback, select 'Off'.

Using repeat play

In addition to various repeat play options, it's also possible to use repeat play together with program play (see *Creating a program list* on page 31).

1 During playback, press HOME MENU and select 'Play Mode'.

Note

¹ You can also do this by going to the '..' folder at the top, then pressing ENTER.

2 Select 'Repeat' then select a repeat play option.¹

If program play is active, select **Program Repeat** to repeat the program list, or **Repeat Off** to cancel.

- For DVD discs, select **Title Repeat** or **Chapter Repeat**.
- For CDs and Video CD/Super VCDs, select **Disc Repeat** or **Track Repeat**.
- For DivX video discs, select **Title Repeat** (or **Repeat Off**).



Tip

- You can also use the **RPT (SHIFT+2)** button on the remote to select a repeat play option. The repeat modes available are the same as those from the **Play Mode** menu.

Using random play

Use this function to play titles or chapters (DVD-Video) or tracks (CD and Video CD/Super VCD) in a random order.²

1 During playback, press HOME MENU and select 'Play Mode'.

2 Select 'Random' then select an option.

- For DVD discs, select **Random Title** or **Random Chapter**.
- For CDs and Video CD/Super VCDs, select **On** or **Off** to switch random play on or off.



Tip

- Use the following controls during random play:

Button	What it does
▶▶I	Selects a new track/title/chapter at random.
I◀◀	Returns to the beginning of the current track/title/chapter; further presses select another random track/title/chapter.

- You can also use the **RDM (SHIFT+3)** button on the remote to select a random play mode. The random modes available are the same as when choosing from the **Play Mode** menu. Press **ENTER** to start random play.
- Random play remains in effect until you select **Random Off** from the random play menu options.

Creating a program list

This feature lets you program the play order of titles/chapters/tracks on a disc.³

Using the OSD

1 During playback, press HOME MENU and select 'Play Mode'.

2 Select 'Program' then select 'Create/Edit' from the list of program options.

3 Use ↑/↓/←/→ and ENTER to select a title, chapter or track for the current step in the program list.

For a DVD disc, you can add a title or a chapter.

Note

¹ You can't use repeat play with WMA/MP3/MPEG-4 AAC discs.

² • You can set the random play option when a disc is playing or stopped. However, you can't use random play together with program play.

• You can't use random play with VR format DVD-R/-RW discs, WMA/MP3/MPEG-4 AAC discs, DivX video discs, or while a DVD disc menu is being displayed.

³ You can't use Program play with VR format DVD-R/-RW discs, WMA/MP3/MPEG-4 AAC discs, DivX video discs, or while a DVD disc menu is being displayed.

- For a CD or Video CD/Super VCD, select a track to add to the program list.

After pressing **ENTER** to select the title/chapter/track, the step number automatically moves down one.

4 Repeat step 3 to build up a program list.

A program list can contain up to 24 steps.

- You can insert steps by just highlighting the position where you want the new step to appear and entering a title/chapter/track number.
- To delete a step, highlight it and press **CLEAR**.

5 To play the program list, press ► (play).

Program play remains active until you turn off program play (see below), erase the program list (see below), eject the disc or switch off.



Tip

- Use the following controls during program play:

Button	What it does
HOME MENU	Save the program list and exit without starting playback.
▶▶	Skip to the next step in the program list.

Other functions available from the program menu

There are a number of other options in the program menu in addition to Create/Edit.

- **Playback Start** – Starts playback of a saved program list
- **Playback Stop** – Turns off program play, but does not erase the program list
- **Program Delete** – Erases the program list and turns off program play

Using the front panel display

Even though the OSD is available for CDs, the front panel display provides information to make a program list easily. If a disc is playing, stop it first.

1 Press PGM (SHIFT+1).

You're prompted to enter a track for the first step in the program list.

2 Use the number buttons to select a track, then press ENTER.

If you make a mistake, press **CLEAR** to delete the last (most recently) programmed track.

3 Repeat step 2 to build up a program list.

A program list can contain up to 24 steps.

4 To play the program list, press ► (play).

- Program play remains active until you press ■ (stop), clear the playlist (see tip above), eject the disc or switch off the player.

Using Playlists

With this feature, you can make up to three playlists of 30 files each for discs containing WMA, MP3, MPEG-4 AAC and JPEG files. Since this unit will remember all playlists for the last ten discs you have loaded, this is useful for if you have a large number of files that you want to organize quickly and easily.¹

Programming playlists

1 With the disc stopped, press HOME MENU and select 'Disc Navigator' from the on-screen menu.

2 Select the file you want to add to the playlist.

See *Browsing WMA, MP3, MPEG-4 AAC, DivX video and JPEG files with the Disc Navigator* on page 30 if you don't know how to do this.

Note

¹ The disc must be loaded for the files in your playlist to play back.

3 Press PLAY LIST 1, 2 or 3.

The file is added to the playlist you select.

4 Repeat steps 2 and 3 until you're done.**Tip**

- To add files without the on-screen display, simply press **PLAY LIST 1, 2 or 3** during normal playback of the file you want (except when a JPEG slideshow is playing at the same time as audio).

Listening to playlists**• With playback stopped, press PLAY LIST 1, 2 or 3.**

During playback, **PGM** lights in the front panel display.

- If no playlist has been programmed, **NO LIST** shows in the front panel display.
- If the playlist contains both JPEG and audio files, playback of the slideshow and audio files starts.

Clearing files from a playlist**1 Start playback of your playlist.****2 Press HOME MENU and select 'Disc Navigator'.****3 From the 'Disc Navigator' screen, select the file you want to remove from the playlist and press CLEAR.****Searching a disc**

You can search DVD discs by title or chapter number, or by time; CDs and Video CD/Super VCDs by track number or time; DivX video discs by time.

1 Press HOME MENU and select 'Play Mode'.**2 Select 'Search Mode'.**

The search options that appear depend on the kind of disc loaded.

3 Select a search mode.

- The disc must be playing in order to use time search.

4 Use the number buttons to enter a title, chapter or track number, or a time.

- For a time search, enter the number of minutes and seconds into the currently playing title (DVD/ DivX video) or track (CD/ Video CD/Super VCD) you want playback to resume from. For example, press **4, 5, 0, 0** to have playback start from 45 minutes into the disc. For 1 hour, 20 minutes and 30 seconds, press **8, 0, 3, 0**.

5 Press ENTER to start playback.**Switching subtitles**

Some DVD discs and DivX video discs have subtitles in one or more languages; the disc box will usually tell you which subtitle languages are available. You can switch subtitle language during playback.¹

• Press SUBTITLE repeatedly to select a subtitle option.

- To set subtitle preferences, see *Language settings* on page 42.
- See *Displaying DivX subtitle files* on page 49 for more on DivX subtitles.

Note

¹ Some discs only allow you to change subtitle language from the disc menu. Press **TOP MENU (SHIFT+MENU)** or **MENU** to access.

Switching language/audio channels

When playing discs recorded with dialog in two or more languages, or with dual-mono audio¹ you can switch these during playback.²

- **Press AUDIO repeatedly to select an audio language option.**
 - To set audio language preferences, see *Language settings* on page 42.

Zooming the screen

Using the zoom feature you can magnify a part of the screen by a factor of 2 or 4, while watching a DVD, DivX video title or Video CD/ Super VCD or playing a JPEG disc.

1 During playback, use the ZOOM button to select the zoom factor (Normal, 2x or 4x).

2 Use ↑/↓/←/→ to change the zoomed area.

You can change the zoom factor and the zoomed area freely during playback.³

Switching camera angles

Some DVD discs feature scenes shot from two or more angles — check the disc box for details.

When a multi-angle scene is playing, a  icon appears on screen (this can be switched off if you prefer — see *Display settings* on page 43).

- **During playback (or when paused), press ANGLE to switch angle.**

Note

1 Some Super VCDs have two soundtracks. With these discs you can switch between the two soundtracks as well as individual channels in each.

2 Some discs only allow you to change audio language from the disc menu. Press **TOP MENU (SHIFT+MENU)** or **MENU** to access.

3 • Since DVD, Video CD/Super VCD, DivX video title and JPEG pictures have a fixed resolution, picture quality will deteriorate, especially at 4x zoom. This is not a malfunction.

- If the navigation square at the top of the screen disappears, press **ZOOM** again to display it.

Displaying disc information

Various track, chapter and title information can be displayed on-screen during playback.

- **To show/switch/hide the information displayed, press DISPLAY repeatedly.**

Limited disc information also appears in the front panel display. Press **DISPLAY** to change the displayed information.

Chapter 8

USB playback

Using the USB interface

It is possible to listen to two-channel audio¹ and watch JPEG files using the USB interface on the front of this unit. Connect a USB mass storage device² as shown below.

1 With the player switched on, press **USB**.

Make sure your TV is on and set to the correct video input.

2 Connect your USB device.

The USB terminal is located on the front panel.

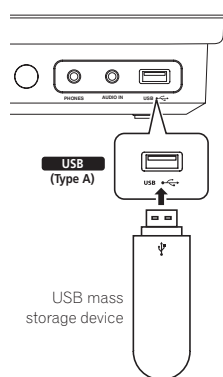

3 Press **▶ (play)** to start playback.

If your USB device contains JPEGs, a slideshow will start. See *Playing a JPEG slideshow* on page 36 for more on this.

- Make sure **USB DATA** is showing in the front panel display (or the system is in standby) when disconnecting.

Important







If a **USB ERR** message lights in the display, it may mean that the power requirements of the USB device are too high for this player, or that the device is incompatible. Try the following:

- Switch the player off, then on again.
- Reconnecting the USB device with the player switched off.
- Selecting to another input source (like **DVD/CD**), then back to **USB**.
- Using a dedicated AC adapter (supplied with the device) for USB power.

If this doesn't remedy the problem, it is likely your USB device is incompatible.

Basic playback controls

The following table shows the basic controls on the remote for USB playback.

Button	What it does
	Starts normal playback.
	Pauses/unpauses playback.
	Stops playback.
	Press to start fast reverse scanning.
	Press to start fast forward scanning.
	Skips to the start of the current file, then previous files.
	Skips to the next file.

Note

¹ This includes playback of WMA/MP3/MPEG-4 AAC files (except files with copy-protection or restricted playback). It is not possible to play DivX files through the USB terminal.

² • Compatible USB devices include external magnetic hard drives, portable flash memory (particularly keydrives) and digital audio players (MP3 players) of format FAT16/32. It is not possible to connect this unit to a personal computer for USB playback.

• Pioneer cannot guarantee compatibility (operation and/or bus power) with all USB mass storage devices and assumes no responsibility for any loss of data that may occur when connected to this unit.

- With large amounts of data, it may take longer for the system to read the contents of a USB device.

Scanning files

You can fast-scan forward or backward at various different speeds.

- **During playback, press ◀◀ or ▶▶.** Press repeatedly to increase the scanning speed (shown on-screen).
 - To resume playback, press ▶ (play).¹

Playing a JPEG slideshow

Press ▶ to start a slideshow from the first folder/picture.² The pictures in each folder are displayed in order.

- If the device contains WMA/MP3/MPEG-4 AAC files, playback of the slideshow and audio files repeats. During audio playback, you can still use the skip (◀◀/▶▶), scan (◀◀/▶▶) and pause (||) functions.

Pictures are automatically adjusted so that they fill as much of the screen as possible.

While the slideshow is running:

Button	What it does
	Pauses the slideshow (or audio); press again to restart.
◀◀	Jumps to the previous picture (or audio file with audio playback).
▶▶	Jumps to the next picture (or audio file with audio playback).
◀/→/↑/↓	Pauses the slideshow and rotates/flips the current picture (Press ▶ to restart slideshow).
ZOOM	Pauses the slideshow and zooms the picture. Press again to toggle between 1x, 2x and 4x zoom (Press ▶ to restart slideshow).

Note

- ¹ With WMA/MP3/MPEG-4 AAC tracks, playback automatically resumes at the end or beginning of the track.
- ²
 - The time it takes for the player to load a file increases with large file sizes.
 - USB devices can contain up to 299 folders and up to 648 folders and files combined.
- ³ Filenames may be displayed incorrectly with some digital audio players.
- ⁴ You can also do this by going to the '..' folder at the top, then pressing **ENTER**.

Button	What it does
MENU	Displays the Navigator screen (see below).

Browsing files with the Navigator

Use the Navigator to find WMA, MP3, MPEG-4 AAC and JPEG files or folders by name.³

1 Press MENU then use ↑/↓/←/→ and ENTER to navigate.

Use ↑/↓ to move up/down the folder/file list.

Use ← to return to the parent folder.⁴

Use **ENTER** or → to open a highlighted folder.

- When a JPEG file is highlighted, a thumbnail image is displayed on the right.

2 To play the highlighted track or display the highlighted JPEG file, press ENTER.

- When a WMA/MP3/MPEG-4 AAC file is selected, playback begins from that file, and continues until the end of the folder.
- When a JPEG file is selected, a slideshow begins, starting with that file, and continues to the end of the folder.

Tip

- You can also play a JPEG slideshow while listening to WMA/MP3/MPEG-4 AAC playback. Simply select the audio file you want to listen to followed by the JPEG from which you want the slideshow to start. Playback of both the slideshow and the audio files repeats. Playback controls are effective for the JPEG slideshow only.
- To play all of the contents, rather than just the current folder, exit the Navigator and start playback using the ▶ (play) button.

Chapter 9

Singing karaoke

Singing karaoke

Using the karaoke features you can plug in a microphone and mix the sound of your own voice with a backing track¹. You can select a backing track from audio sources such as CDs, DVDs, VCDs or USB devices. Adjust the microphone level relative to the backing track.

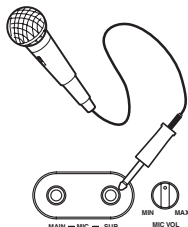

1 Set the MIC VOL knob (front panel) to minimum.

2 Plug in the microphone(s).

If you're only using one mic, plug it into the **MIC (MAIN)** jack. The **MIC (SUB)** jack can be used only if **MIC (MAIN)** is also connected.

- If the microphone has an on/off switch, make sure it's on.

3 Load a karaoke backing disc.

4 To change the mix (CD or Video CD/Super VCD only), press KARAOKE.

Press to switch between these options:²

- **KARAOKE** (Vocal cancel) – Backing track vocals are partially eliminated using EQ.

- **L CH** – Left channel only. Use for tracks that have a vocal recorded in the right channel.
- **R CH** – Right channel only. Use for tracks that have a vocal recorded in the left channel.
- **L+R CH** – Use to put a single-channel vocal track into the center of the mix.
- **OFF** – Switches the Karaoke mode off.

5 Play the backing track.

6 Adjust the MIC VOL knob.

To avoid unpleasant feedback, make sure you don't point the microphone(s) at the speakers.³

7 Sing!

Changing the vocal mix

Adding some effects to the microphone mix can sometimes improve the overall sound.⁴ You can choose between three echo levels.

• **To add effects to the microphone mix, press ECHO.**

Pressing repeatedly switches between echo levels 1 to 3 and off.

Changing the backing track

You may want to lower or raise the pitch of the backing track to match your vocal range.⁵

- Press **KEY CONTROL # (SHIFT+KARAOKE)** or **b (SHIFT+ECHO)** to raise or lower the pitch of the backing track.

Note

¹ • These features are only possible when a microphone is connected. If you try to use **KARAOKE**, **ECHO**, **# (SHIFT+KARAOKE)**, or **b (SHIFT+ECHO)** when no mic is connected, a 'NO MIC' error message is displayed. Also note that during DVD playback, when you connect a mic sound settings are automatically switched to **STEREO** playback and downmixes multichannel sources to 2.1 channels.

- These features are only available with the **DVD/CD** or **USB** input functions.

² The current setting is first shown in the display.

³ Depending on the microphone level, the sound of the disc may distort. If this happens, turn down the volume.

⁴ You cannot adjust Sound menu, SFC modes or bass boost controls when a microphone is plugged in.

⁵ This feature is not compatible with DTS signals.

Chapter 10

Adjusting the sound

Using the Sound menu

There are several optional sound settings you can make from the sound menu.

1 Press **SOUND MODE**.

2 Use **←/→** to choose the setting you want to adjust.

The current setting is shown for each option (in the order shown in step 3, with the defaults in **bold**) as you cycle through the display.

3 Use **↑/↓** to adjust.

Make adjustments to the following settings:

Setting	What it does	Option(s)
MP3 EXP. ¹ (2 channel source only)	Reproduce the comfortable sound for compressed music (MP3, WMA, MPEG-4 AAC).	OFF ON
BASS	Adjusts the amount of bass.	-4 to +4
TREBLE	Adjusts the amount of treble.	-4 to +4
ST. WIDE (CX303 only)	Makes the stereo spread appear wider than it really is.	OFF ON
VOICE. E. ² (CX505/CX500 only)	Enhances the dialog away from the background sounds.	ON OFF

4 Repeat steps 2 and 3 for other settings.

5 When you're done, press **ENTER** to leave the Sound menu.



Tip

- You can store your current bass, treble as a preset. Simply hold **ENTER** for three seconds, then press **ENTER** again to confirm when **USER** shows in the display. You can now select this preset from the **SFC** menu (see *Using the Sound Field Control* below).

Using the Sound Field Control

Depending on the source you're listening to, you may want to use the Sound Field Control to match the source you're listening to.

• Press **SFC** repeatedly to select a mode.

The options are as follows:

- ROCK** – Live concert sound for rock music.
- POP** – Live concert sound for pop music.
- DANCE** – Good for music with lots of bass.
- CLASSIC** – Large concert hall type sound.
- DRAMA** – Good for movies with lots of dialog.
- ACTION** – Good for movies with dynamic sound tracks.
- USER** – See *Tip* above.
- OFF**

Note

- When turned on, the SFC mode will turn off.
- When turned on, the SFC mode and Extra Power mode will turn off.
 - For multichannel DVD disc only.

Boosting the bass level

If you want to bring up the low end for certain kinds of music or sound sources, you can use the bass boost to do so.

- Press **X.BOOM** repeatedly to select a mode.

The options are as follows (the **X.BOOM** LED lights as indicated in parantheses):

- **AUTO** – Automatically selects **XBOOM MS** or **XBOOM MV** (depending on the source). For DVD video/Video CD/SuperVCD/DivX disc, **XBOOM MV** will be selected.
For other sources, **XBOOM MS** will be selected.
- **XBOOM MS** – Good for music with lots of bass (blue).
- **XBOOM MV** – Boosts low frequency (bass) sounds in movies (orange).
- **OFF** – Switches the bass boost off.

Muting the sound

- Press **MUTE** to switch off the volume.

To switch the sound back on, adjust the volume or press **MUTE** again.

Chapter 11

Audio Settings and Video Adjust menu

Audio Settings menu

The Audio Settings menu offers features for adjusting the way discs sound.

1 Press HOME MENU and select 'Audio Settings' from the on-screen display.



2 Select and change settings using ↑/↓/←/→ and ENTER.

Audio DRC

- Settings: **High, Medium, Low, Off** (default)

When watching Dolby Digital DVDs at low volume, it's easy to lose the quieter sounds completely — including some of the dialog. Switching Audio DRC (Dynamic Range Control) to on can help by bringing up the quieter sounds, while controlling loud peaks.

How much of a difference you hear depends on the material you're listening to. If the material doesn't have wide variations in volume, you may not notice much change.¹

Virtual Surround

CX303 only

- Settings: **On, Off** (default)

Switch on Virtual Surround to enjoy realistic surround sound effects from just three speakers.²

Video Adjust menu

From the Video Adjust screen you can adjust various settings that affect how the picture is presented.

1 Press HOME MENU and select 'Video Adjust' from the on-screen display.

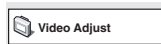

2 Make settings using ↑/↓/←/→ and ENTER.

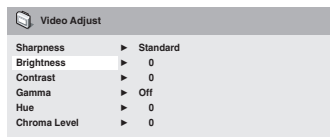

You can adjust the following settings:

- **Sharpness** – Adjusts the sharpness of edges in the picture (**Fine, Standard, Soft**)
- **Brightness** – Adjusts the overall brightness (**-20 to +20**)

Note

- Audio DRC is only effective with Dolby Digital audio sources.
 - The effect of Audio DRC also depends on your speakers and settings.
- 96 kHz Linear PCM audio is automatically downsampled to 48 kHz if Virtual Surround is switched on.
 - How good the surround effect is varies with the disc.

- **Contrast** – Adjusts the contrast between light and dark (**-16 to +16**)
- **Gamma** – Adjusts the 'warmth' of the picture (**High, Medium, Low, Off**)
- **Hue** – Adjusts the red/green balance (**Green 9 to Red 9**)
- **Chroma Level** – Adjusts how saturated colors appear (**-9 to +9**)

Adjust the Brightness, Contrast, Hue and Chroma Level settings using **←/→**.



3 Press ENTER to return to the Video Adjust screen, or HOME MENU to exit.

Chapter 12

Initial Settings menu

Using the Initial Settings menu

The Initial Settings menu provides audio and video output settings, parental lock settings, and display settings, among others.

If an option is grayed out it means that it cannot be changed at the current time. This is usually because a disc is playing. Stop the disc, then change the setting.

- 1 Press DVD/CD.
- 2 With playback stopped, press HOME MENU and select 'Initial Settings'.



- 3 Use ↑/↓/←/→ and ENTER to select the setting and option you want to set. All the settings and options are explained on the following pages.¹

Video Output settings

Setting	Option	What it means
TV Screen (See also <i>Using the language code list</i> on page 55.)	4:3 (Letter Box)	Set if you have a conventional 4:3 TV. Widescreen movies are shown with black bars top and bottom.
	4:3 (Pan & Scan)	Set if you have a conventional 4:3 TV. Widescreen movies are shown with the sides cropped so that the image fills the screen.
	16:9 (Wide)	Set if you have a widescreen TV.
Component Out (See also <i>Connecting using the component video output</i> on page 14.)	Interlace	Set if your TV is not compatible with progressive scan video.
	Progressive	Set if your TV is compatible with progressive scan video (see your TV's instruction manual for details). Press ENTER once more to confirm (or RETURN to cancel). <i>Note that progressive scan video is only output from the component video jacks.</i>

Language settings

Setting	Option	What it means
Audio Language	English	If there is an English soundtrack on the disc, it is played.
	<i>Languages as displayed</i>	If there is a language selected on the disc, it is played.
	<i>Other Language</i>	Select to choose a language other than the ones displayed (see <i>Using the language code list</i> on page 55).

Note

¹ In the table, the default setting is shown in **bold**; other settings are shown in *italics*.

- Some settings, such as **TV Screen**, **Audio Language** and **Subtitle Language** may be overridden by the DVD disc. Often these settings can also be made from the DVD disc menu.
- The **Component Out** setting only needs to be set if you have connected this player to your TV using component video.

Setting	Option	What it means
Subtitle Language	English	If there are English subtitles on the disc they are displayed.
	<i>Languages as displayed</i>	The subtitle language selected on the disc is displayed.
	<i>Other Language</i>	Select to choose a language other than the ones displayed (see <i>Using the language code list</i> on page 55).
DVD Menu Language	w/Subtitle Lang.	DVD disc menus are displayed in the same language as your selected subtitle language, if possible.
	<i>Languages as displayed</i>	DVD menus are displayed in the selected language, if possible.
	<i>Other Language</i>	Select to choose a language other than the ones displayed (see <i>Using the language code list</i> on page 55).
Subtitle Display	On	Subtitles are displayed in your selected subtitle language.
	<i>Off</i>	Subtitles are always off by default when you play a DVD disc.

Display settings

Setting	Option	What it means
OSD Language	English	On-screen displays of the player are in English.
	<i>Languages as displayed</i>	On-screen displays are shown in the language selected.
Angle Indicator	On	A camera icon is displayed on-screen during multi-angle scenes on a DVD disc.
	<i>Off</i>	No multi-angle indication is shown.

Options settings

Setting	Option	What it means
Parental Lock	–	See <i>Parental Lock</i> below.
DivX(R) VOD	Display	See <i>About DivX® VOD content</i> below.

Parental Lock

- Default level: **Off**; Default password: *none*;
Default Country/Area code: **us (2119)**

To give you some control over what your children watch on your DVD player, some DVD-Video discs feature a Parental Lock level. If your player is set to a lower level than the disc, the disc won't play.

Some discs also support the Country/Area Code feature. The player does not play certain scenes on these discs, depending on the Country/Area Code you set.

Registering a new password

Register a password to change the Parental Lock level or enter a Country/Area code.¹

Note

- Not all discs use Parental Lock, and will play without requiring the password first.
 - If you forget your password, you'll need to reset the player to register a new password (see *Resetting the system* on page 51).

1 Select 'Password'.

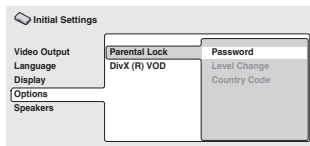

2 Use the number buttons to input a 4-digit password then press ENTER.

Changing your password

To change your password, confirm your existing password then enter a new one.

1 Select 'Password Change'.

2 Input your existing password, then press ENTER.

3 Enter a new password and press ENTER.

Setting/changing the Parental Lock

1 Select 'Level Change'.

2 Use number buttons to enter your password, then press ENTER.

3 Select a new level and press ENTER.

- Press ← repeatedly to lock more levels (more discs will require the password); press → to unlock levels. You can't lock level 1.

Setting/changing the Country/Area code

You can find the *Country/Area code list* on page 56.

1 Select 'Country Code'.

2 Input your password, then press ENTER.

3 Select a Country/Area code then press ENTER.

There are two ways you can do this:

- Select by code letter: Use ↑/↓ to change the Country/Area code.
- Select by code number: Press → then use the number buttons to enter the 4-digit Country/Area code.

The new Country/Area code takes effect after ejecting the disc once.

About DivX® VOD content

In order to play DivX VOD (video on demand) content on this player, you first need to register the player with your DivX VOD content provider. You do this by generating a DivX VOD registration code, which you submit to your provider.¹



Important

- DivX VOD content is protected by a DRM (Digital Rights Management) system. This restricts playback of content to specific, registered devices.
- If you load a disc that contains DivX VOD content not authorized for your player, the message **Authorization Error** is displayed and the content will not play.

Displaying your DivX VOD registration code

1 Press HOME MENU and select 'Initial Settings'.

2 Select 'Options', then 'DivX(R) VOD'.

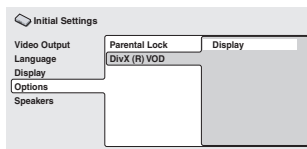

3 Select 'Display'.

Your 8-digit registration code is displayed.

Note

¹ Resetting the player (as described in *Resetting the system* on page 51) will not cause you to lose your registration code.

Make a note of the code as you will need it when you register with a DivX VOD provider.

Playing DivX® VOD content

Some DivX VOD content may only be playable a fixed number of times. When you load a disc containing this type of DivX VOD content, the remaining number of plays is shown on-screen and you then have the option of playing the disc (thereby using up one of the remaining plays), or stopping. If you load a disc that contains expired DivX VOD content (for example, content that has zero remaining plays), the message **Rental Expired** is displayed.

If your DivX VOD content allows an unlimited number of plays, then you may load the disc into your player and play the content as often as you like, and no message will be displayed.

Speaker Distance

CX505/CX500 model only

- Default setting: **3.0m**

To get the best surround sound from your system, you should set up the speakers equal distances from your listening position.

1 Press HOME MENU and select 'Initial Settings'.

2 Select 'Speakers', then 'Speaker Distance'.

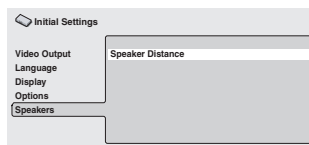

3 Use ↑/↓ to select a speaker.

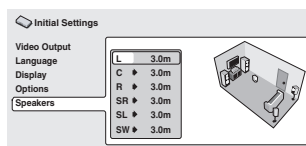

4 Press → to change the speaker distance for the highlighted speaker.

5 Use ↑/↓ to change the distance.

- When you change the distance settings of the front left (**L**) or front right (**R**) speakers, all the other speaker distances change relative to it.
- Front left/right (**L/R**) speaker distances can be set from 30 cm to 9 m in 30 cm increments.¹
- The center speaker (**C**) can be set from -2.1 m to 0 m relative to the front left/right speakers.
- Surround left/right (**SL/SR**) speakers can be set from -6.0 m to 0 m relative to the front left/right speakers.²
- The subwoofer (**SW**) can be set from -2.1 m to 0 m relative to the front left/right speakers.

6 Press ← to go back to the speaker list if you want to modify another speaker, or press ENTER to exit the Speaker Distance screen.

Note

- ¹ The **L** and **R** speakers are paired; you can't set them differently.
- ² Make sure to set them the same distance when using Front Surround (*Using Front Surround* on page 27).

Chapter 13

Additional information

Optional system settings

These settings are accessed by using the System Setup menu while in standby.

- 1 **Switch the system into standby.**
- 2 **Press SYSTEM SETUP.**
- 3 **Use ←/→ to choose the setting then press ENTER.**

The current setting is shown for each option as you cycle through the display. See below for a full list and description of each.

- 4 **Use ↑/↓ to adjust the setting then press ENTER to confirm.**
- 5 **Repeat steps 2 to 4 to make other settings.**

System Setup menu options in standby

Below are all the available settings in the setup menu. The first setting in each is the default.

System demo setting

Switches the automatic demo feature on or off (this starts when you plug in for the first time):

- **DEMO ON** – Switches the demo feature on.
- **DEMO OFF** – Switches the demo feature off.

Frequency step setting

If you find that you can't tune into stations successfully, the frequency step may not be suitable for your country/region.

- **AM 9K** – AM 9 kHz/FM 50 kHz
- **AM 10K** – AM 10 kHz/FM 100 kHz

TV system setting

The default setting of this system is **AUTO**, and unless you notice that the picture is distorted when playing some discs, you should leave it set to **AUTO**. If you find picture distortion with some discs, set the TV system to match your country or region's system. However, this may restrict the kinds of disc you can watch.

See the table for the kinds of discs compatible with each setting (**AUTO**, **PAL** and **NTSC**).¹

- **After selecting TV SYS in step 3 above, press ENTER to change the TV system.**

The TV system as follows:

- **AUTO → NTSC**
- **NTSC → PAL**
- **PAL → AUTO**

The system automatically switches on and you'll see the new TV system setting in the display after seeing **WELCOME**.²

Disc		Player setting		
Type	Format	NTSC	PAL	AUTO
DVD/Super VCD/ Video CD/DivX Video	NTSC	NTSC	PAL	NTSC
	PAL	NTSC	PAL	PAL
CD/MP3/WMA/ MPEG-4 AAC/ JPEG/no disc	—	NTSC	PAL	NTSC or PAL

Note

¹ Most models of the newly developed countdown PAL TV system detect 50 Hz (PAL)/60 Hz (NTSC) and automatically switch vertical amplitude, resulting in a display without vertical shrinkage. However, in some cases, the image may appear without color. If your PAL TV does not have a V-Hold control, you may not be able to watch NTSC discs because of picture roll. If the TV has a V-Hold control, adjust it until the picture stops rolling. On some TVs, the picture may shrink vertically, leaving black bands at the top and bottom of the screen.

² You have to switch the player into standby (press **STANDBY/ON**) before each change.

Key lock setting

- **LOCK ON** – Makes the front panel buttons and controls inoperative.
- **LOCK OFF** – Restores regular use of the front panel buttons and controls.

Volume mode setting

If you want to make finer adjustments of the volume.

- **FINE** – 60 steps
- **NORMAL** – 30 steps

Setting the sleep timer

The sleep timer switches off the system after about an hour so you can fall asleep without worrying about it.¹

- **Press SLEEP repeatedly to select an option.**

Choose between the following options:

- **SLP ON** – Switches off after about an hour
- **SLP OFF** – Cancels the sleep timer

After selecting **SLP ON**, you can press **SLEEP** again to check how much time is left. Each line indicates approximately 12 minutes (remaining):





Disc/content format playback compatibility

This player is compatible with a wide range of disc types (media) and formats. Playable discs will generally feature one of the following logos on the disc and/or disc packaging. Note however that some disc types, such as recordable CD and DVD, may be in an unplayable format.

See the *About DualDisc playback* below for more information.



Fujicolor CD

- This unit will play DVD+R/+RW discs.
-  is a trademark of FUJIFILM Corporation.
-  is a trademark of DVD Format/Logo Licensing Corporation.
- Also compatible with KODAK Picture CD.

This player supports the IEC's Super VCD standard for superior picture quality, dual soundtracks, and widescreen support.



Super Video CD (Super VCD)

About DualDisc playback

A DualDisc is a new two-sided disc, one side of which contains DVD content video, audio, etc. while the other side contains non-DVD content such as digital audio material.

The non-DVD, audio side of the disc is not compliant with the CD Audio specification and therefore may not play.

The DVD side of a DualDisc plays in this product. DVD-Audio content will not play.

For more detailed information on the DualDisc specification, please refer to the disc manufacturer or disc retailer.

Note

¹ The Front panel display dims when the sleep timer is set and the sleep indicator turns on.

Disc compatibility table

Media	Compatible formats
CD-R/-RW	<ul style="list-style-type: none"> • CD-Audio, Video CD/Super VCD, ISO 9660 CD-ROM* * ISO 9660 Level 1 or 2 compliant. CD physical format: Mode1, Mode2 XA Form1. Romeo and Joliet file systems are both compatible. • Multi-session playback: No • Unfinalized disc playback: No
DVD-R/-RW	<ul style="list-style-type: none"> • DVD-Video (Video mode), Video Recording (VR)*, UDF Bridge DVD-ROM * Edit points may not play exactly as edited; screen may go momentarily blank at edited points. • Multi Border playback: No • Unfinalized playback: No
PC-created disc	<ul style="list-style-type: none"> • Discs recorded using a PC may not be playable due to the setting of the software used to create the disc. In these instances, check the DVD-R/-RW or CD-R/-RW software manual or disc boxes for more on compatibility. • Discs recorded in packet write mode are not compatible.
Compressed audio	<ul style="list-style-type: none"> • MPEG-1 Audio Layer 3 (MP3), Windows Media Audio (WMA), MPEG-4 AAC • Sampling rates: 32 kHz/44.1 kHz/48 kHz • Bit-rates: Any (128 kbps or higher recommended) • VBR (variable bit rate) MP3/WMA/MPEG-4 AAC playback: No • WMA lossless encoding: No • DRM (Digital Rights Management) compatible: Yes (DRM-protected audio files will <i>not</i> play in this player) • File extensions: .mp3, .wma, .m4a (these must be used for the player to recognize MP3/WMA/MPEG-4 AAC files) • File structure (may differ): Up to 299 folders on a disc; up to 648 folders and files (combined) within each folder

Media	Compatible formats
JPEG file	<ul style="list-style-type: none"> • Baseline JPEG and EXIF 2.2* still image files up to a resolution of 3072 x 2048. *File format for digital still cameras • Progressive JPEG compatible: No • File extensions: .jpg (must be used for the player to recognize JPEG files) • File structure (may differ): Up to 299 folders on a disc; up to 648 folders and files (combined) within each folder

About DVD+R/DVD+RW compatibility

Only DVD+R/DVD+RW discs recorded in 'Video Mode (DVD Video Mode)' which have been finalized, can be played back. However, some editing made during the recording may not be played back accurately.

About DivX



DivX is a compressed digital video format created by the DivX[®] video codec from DivX, Inc. This player can play DivX video files burned on CD-R/-RW and DVD-R/-RW/-ROM discs. Keeping the same terminology as DVD-Video, individual DivX video files are called 'Titles'. When naming files/titles on a CD-R/-RW or DVD-R/-RW disc prior to burning, keep in mind that by default they will play in alphabetical order.

DivX video compatibility

- Official DivX[®] Certified product.
- Plays all versions of DivX[®] video (including DivX[®]6) with standard playback of DivX[®] media files.¹

Note

¹ Playback of .avi video files larger than 4 GB is not possible.

- File extensions: .avi and .divx (these must be used for the player to recognize DivX video files). *Note that all files with the .avi extension are recognized as MPEG4, but not all of these are necessarily DivX video files and therefore may not be playable on this player.*

Displaying DivX subtitle files

The font sets listed below are available for DivX external subtitle files. You can see the proper font set on-screen by setting the **Subtitle Language** (in *Language settings* on page 42) to match the subtitle file.¹

Group 1: Albanian (sq), Basque (eu), Catalan (ca), Danish (da), Dutch (nl), English (en), Faroese (fo), Finnish (fi), French (fr), German (de), Icelandic (is), Irish (ga), Italian (it), Norwegian (no), Portuguese (pt), Rhaeto-Romanic (rm), Scottish (gd), Spanish (es), Swedish (sv)

Group 2: Albanian (sq), Croatian (hr), Czech (cs), Hungarian (hu), Polish (pl), Romanian (ro), Slovak (sk), Slovenian (sl)

Group 3: Bulgarian (bg), Byelorussian (be), Macedonian (mk), Russian (ru), Serbian (sr), Ukrainian (uk)

Group 4: Hebrew (iw), Yiddish (ji)

Group 5: Turkish (tr)

DivX, DivX Certified, and associated logos are trademarks of DivX, Inc. and are used under license.

About MPEG-4 AAC

Advanced Audio Coding (AAC) is at the core of the MPEG-4 AAC standard, which incorporates MPEG-2 AAC, forming the basis of the MPEG-4 audio compression technology. The file format and extension used depend on the application used to encode the AAC file. This unit plays back AAC files encoded by iTunes® bearing the

extension **'m4a'**. DRM-protected files will not play, and files encoded with some versions of iTunes® may not play, or filenames may display incorrectly.

Apple and iTunes are trademarks of Apple Inc., registered in the U.S. and other countries.

About WMA

This player can playback Windows Media Audio content.

WMA is an acronym for Windows Media Audio and refers to an audio compression technology developed by Microsoft Corporation. WMA content can be encoded by using Windows Media® Player version 7.7.1, Windows Media® Player for Windows® XP, or Windows Media® Player 9 series.

Windows Media is either a registered trademark or trademark of Microsoft Corporation in the United States and/or other countries.

This product includes technology owned by Microsoft Corporation and cannot be used or distributed without a license from Microsoft Licensing, Inc.

Using and taking care of discs

DVD Video regions

All DVD Video discs carry a region mark that indicates which region(s) of the world the disc is compatible with. Your DVD system also has a region mark (on the rear panel). Discs from incompatible regions will not play in this player. Discs marked **ALL** play in any player.

Note

¹ • For external subtitle files the following subtitle format filename extensions are supported (please note that these files are not shown within the disc navigation menu): .srt, .sub, .ssa, .smi

- Some external subtitle files may be displayed incorrectly or not at all.
- The filename of the movie file has to be repeated at the beginning of the filename for the external subtitle file.
- The number of external subtitle files which can be switched for the same movie file is limited to a maximum of 10.

Handling discs

Hold the disc by its edges when handling so as not to leave fingerprints, dirt or scratches on either side of the disc. Damaged or dirty discs can affect playback performance.

If a disc becomes marked with fingerprints, dust, etc., clean using a soft, dry cloth.

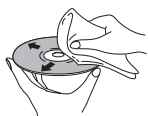

Wipe lightly from the center of the disc using straight strokes. Don't wipe the disc surface with circular strokes.

If necessary, use a cloth soaked in alcohol, or a commercially available CD/DVD cleaning kit to clean a disc more thoroughly. Never use benzene, thinner or other cleaning agents such as those designed for cleaning vinyl records.

Storing discs

Avoid leaving discs in excessively cold, humid, or hot environments (including under direct sunlight). Don't glue paper or put stickers onto the disc, or use a pencil, ball-point pen or other sharp-tipped writing instrument. These could all damage the disc.

Discs to avoid

Discs spin at high speed inside the player. If a disc is cracked, chipped, warped, or otherwise damaged, don't risk using it in your player — you could end up damaging the unit.

This unit is designed for use with conventional, fully circular discs only. Pioneer disclaims all liability arising in connection with the use of shaped discs.

Installation and maintenance

Hints on installation

We want you to enjoy using this system for years to come, so please bear in mind the following points when choosing a location:

Do...

- ✓ Use in a well-ventilated room.
- ✓ Place on a solid, flat, level surface, such as a table, shelf or stereo rack.

Don't...

- ✗ Use in a place exposed to high temperatures or humidity, including near radiators and other heat-generating appliances.
- ✗ Place on a window sill or other place where the system will be exposed to direct sunlight.
- ✗ Use in an excessively dusty or damp environment.
- ✗ Place directly on top of an amplifier, or other component in your stereo system that becomes hot in use.
- ✗ Use near a television or monitor as you may experience interference — especially if the television uses an indoor antenna.
- ✗ Use in a kitchen or other room where the system may be exposed to smoke or steam.
- ✗ Use on a thick rug or carpet, or cover with cloth — this may prevent proper cooling of the system unit.
- ✗ Place on an unstable surface, or one that is not large enough to support all four of the system unit's feet.

Cleaning the pickup lens

The DVD player's lens should not become dirty in normal use, but if for some reason it should malfunction due to dust or dirt, consult your nearest Pioneer authorized service center. Although lens cleaners are commercially available, we do not recommend using them since some may damage the lens.

Problems with condensation

Condensation may form inside the player if it is brought into a warm room from outside, or if the temperature of the room rises quickly. Although this won't damage the player, it may temporarily impair performance. You should leave it to adjust to the warmer temperature for about an hour before switching on.

Moving the system unit

If you need to move the main unit, first remove a disc if there's one in the player, then press **⏻ STANDBY/ON** on the front panel to turn the system off. Wait for **GOOD BYE** to disappear from the display, then unplug the power cord.¹ Never lift or move the unit during playback — discs rotate at high speeds and may be damaged.

Screen sizes and disc formats

DVD-Video discs come in different screen aspects, ranging from TV programs, which are generally 4:3, to CinemaScope widescreen movies², with an aspect ratio of up to about 7:3. Televisions also come in different aspect ratios; 'standard' 4:3 and widescreen 16:9.³



Set to **4:3 (Letter Box)**, widescreen discs are shown with black bars top and bottom.



Set to **4:3 (Pan&Scan)**, widescreen discs are shown with the left and right sides cropped. Although the picture looks larger, you don't actually see the whole picture.

Resetting the system

Use this procedure to reset all system settings to the factory default. Use the front panel controls to do this.

- 1 **Switch the system on.**
- 2 **Press the DVD/CD button and select DVD.** Make sure the disc tray is empty.
- 3 **Press and hold the **⏮** button for about eight seconds until the display shows 'MEM CLR?'.**
- 4 **Press the **▶/II** button.** **MEM CLR** will be displayed in the front panel display and the player switches into standby.
- 5 **Press the **⏻ STANDBY/ON**.** All the system's settings are now reset.

Note

- 1 Unplugging the unit before **GOOD BYE** disappears from the display may cause the system to return to the factory settings.
- 2 Many widescreen discs override the system's settings so that the disc is shown in letterbox format regardless of the setting.
- 3
 - Using the **16:9 (Wide)** setting with a standard 4:3 TV, or one of the **4:3** settings with a widescreen TV, will result in distortion.
 - When you watch discs recorded in 4:3 format, you can use the TV controls to select how the picture is presented. Your TV may offer various zoom and stretch options; see the instructions that came with your TV for details.
 - Some movie aspect ratios are wider than 16:9, so even with a widescreen TV, these discs will still play in a 'letterbox' style.

Troubleshooting

Incorrect operations are often mistaken for trouble and malfunctions. If you think that there is something wrong with this component, check the points below. Sometimes the trouble may lie in another component. Investigate the other components and electrical appliances being used. If the trouble cannot be rectified even after exercising the checks listed below, ask your nearest Pioneer authorized service center or your dealer to carry out repair work.

- If the unit does not operate normally due to external effects such as static electricity disconnect the power plug from the outlet and insert again to return to normal operating conditions.

General

Problem	Remedy
The power does not turn on.	<ul style="list-style-type: none"> • Connect the power plug to the wall outlet. • Disconnect the power plug from the outlet, and insert again. • Make sure the power source is the right voltage for the AC inlet.
The power does not turn on, or switches off suddenly (an error message may be displayed at startup).	<ul style="list-style-type: none"> • Wait for one minute before switching back on. • Make sure there are no loose strands of wire touching the unit. This could cause the system to shut off automatically. • Check that the speakers are connected correctly. • Make sure the voltage of the mains power source is correct for the model. • Try reducing the volume level. • If the problem persists, take it to your nearest Pioneer authorized service center or your dealer for servicing.
No sound is output when a function is selected.	<ul style="list-style-type: none"> • If you're using the F.AUDIO/LINE input, make sure the component is connected correctly (see <i>Connecting auxiliary components</i> on page 15). • Press MUTE on the remote control to turn muting off. • Adjust the volume.
No image is output when watching discs.	<ul style="list-style-type: none"> • Make sure the TV is connected correctly (see <i>Connecting to your TV</i> on page 14).
Can't operate the remote control.	<ul style="list-style-type: none"> • Replace the batteries (see <i>Loading the batteries</i> on page 6). • Operate within 7 m, 30° of the remote sensor on the front panel (see <i>Range of the remote control unit</i> on page 7). • Remove the obstacle or operate from another position. • Avoid exposing the remote sensor on the front panel to direct light.
The microphone can't be heard.	<ul style="list-style-type: none"> • You are only using one microphone and it's plugged into the MIC (SUB) jack. The MIC (SUB) jack can only be used if there is also a microphone plugged into the MIC (MAIN) jack. • Adjust the MIC VOL.
Feedback noise when mic is switched on.	<ul style="list-style-type: none"> • The mic is pointing toward the speakers. Keep the mic pointed away from the speakers. • The microphone level is set too high. Turn down the mic control level.

Problem	Remedy
SND. DEMO shows in the display and the unit can't be controlled.	<ul style="list-style-type: none"> Press and hold ■ (stop) on the front panel for about five seconds. The disc tray ejects automatically to indicate the Sound Demo mode is disabled.
TRAYLOCK shows in the display and the tray can't be ejected.	<ul style="list-style-type: none"> Press and hold ▲ OPEN/CLOSE on the front panel for about eight seconds. Then the tray can be opened/closed using ▲ OPEN/CLOSE.

DVD/CD/Video CD player

Problem	Remedy
The disc is ejected automatically after loading.	<ul style="list-style-type: none"> Clean the disc and align the disc properly in the disc guide. If the region number on a DVD-video disc does not match the number on the player, the disc cannot be used (see <i>DVD Video regions</i> on page 49). In this case, the message "Incompatible disc region number/Can't play disc." appears on-screen. Allow time for any condensation inside the player to evaporate. Avoid using the player near an air-conditioning unit.
Playback is not possible.	<ul style="list-style-type: none"> Disc may be loaded upside down. Reload the disc with the label side face up.
Picture playback stops and the operation buttons cannot be used.	<ul style="list-style-type: none"> Press ■, then start playback again (▶). Switch the power off once, then on again using the front panel ⏻ STANDBY/ON button.
Settings are canceled.	<ul style="list-style-type: none"> If the power is cut during operation, settings may be canceled.
No picture/No color.	<ul style="list-style-type: none"> Check that connections are correct and that plugs are inserted fully. Check the instruction manual of the TV/monitor to make sure the TV/monitor settings are incorrect. If the Progressive setting is selected and you have used component video cables to connect a TV that is not compatible with a progressive scan signal, you will not be able to see any picture at all. With your TV connected using either the composite or S-video terminals, change the Component Out setting to Interlace (see <i>Video Output settings</i> on page 42).
Screen is stretched or aspect does not change.	<ul style="list-style-type: none"> The TV Screen setting is incorrect. Set the TV Screen option to match the TV/monitor you're using (see <i>Video Output settings</i> on page 42).
When recorded on a VCR or passed through an AV selector, there is disturbance in the playback picture.	<ul style="list-style-type: none"> This system uses copy-protection technology which may prevent recording or cause picture problems when connected through a VCR or AV selector. This is not a malfunction.
Picture disturbance during playback or dark.	<ul style="list-style-type: none"> This player is compatible with Macro-Vision System copy guard. Some discs include a copy prevention signal, and when this type of disc is played back, stripes etc., may appear on some sections of the picture depending on the TV. This is not a malfunction. Discs respond differently to particular player functions. This may result in the screen becoming black for a brief instant or shaking slightly when the function is executed. These problems are largely due to differences between discs and disc content and are not malfunctions of this player.

Problem	Remedy
Noticeable difference in DVD and CD volume.	<ul style="list-style-type: none"> DVDs and CDs use different recording methods. This is not a malfunction.

WMA/MP3/MPEG-4 AAC/JPEG discs

Problem	Remedy
CD-ROM disc is not recognized by the system.	<ul style="list-style-type: none"> Make sure that the CD-ROM was recorded using the ISO 9660 disc format. See <i>Disc compatibility table</i> on page 48 for other disc compatibility information.
DVD-ROM disc is not recognized.	<ul style="list-style-type: none"> Make sure that the DVD-ROM was recorded using the UDF bridge format. See <i>Disc compatibility table</i> on page 48 for more on disc compatibility.
Files don't show up in the Disc Navigator/Photo Browser.	<ul style="list-style-type: none"> The files on the disc must be named with the correct file extension: .mp3 for MP3 files; .wma for WMA files; .m4a for MPEG-4 AAC files; .jpg for JPEG files (upper or lower-case is OK). See <i>Disc compatibility table</i> on page 48.
Can't play WMA or MPEG-4 AAC files.	<ul style="list-style-type: none"> The files were recorded using DRM (digital rights management). This is not a malfunction.

Tuner

Problem	Remedy
Considerable noise in radio broadcasts.	<ul style="list-style-type: none"> Connect the AM antenna (see <i>Connecting the radio antennas</i> on page 13) and adjust the direction and position for best reception. You may also connect an additional internal or external AM antenna (refer to <i>Connecting external antennas</i> on page 13). Fully extend the FM wire antenna, position for best reception, and secure to a wall. You may also connect an outdoor FM antenna (see <i>Connecting external antennas</i> on page 13). Turn off other equipment that may be causing the noise or move it further away. The tuning interval is incorrect for your country or region. See <i>Frequency step setting</i> on page 46 to switch the tuning interval.
Auto tuning does not pick up some stations.	<ul style="list-style-type: none"> The radio signal is weak. Auto tuning will only detect radio stations with a good signal. For more sensitive tuning, connect an outdoor antenna.
Sound is mono only.	<ul style="list-style-type: none"> Check that the tuner is not set to FM mono (see <i>Improving FM stereo sound</i> on page 22).

USB connection

Problem	Remedy
USB mass storage device is not recognized by the system.	<ul style="list-style-type: none"> Make sure you have completely inserted the USB connector to this unit. Check that the memory format is FAT16 or FAT32. USB devices with an internal USB hub are not supported.
Can't play WMA or MPEG-4 AAC files.	<ul style="list-style-type: none"> The files were recorded using DRM (digital rights management). This is not a malfunction.

Problem	Remedy
Files don't show up in the Navigator/Photo Browser.	<ul style="list-style-type: none"> • The files must have the correct file extension: .mp3 for MP3 files; .wma for WMA files; .m4a for MPEG-4 AAC files; .jpg for JPEG files (upper or lower-case is OK). • Make sure the file permission hasn't been restricted (through a password, etc.).

Error Messages

Message	Description
KEY LOCK	• This message appears when the front panel buttons are pressed when the Key lock feature is active. See <i>Optional system settings</i> on page 46 for more on switching on/off the Key lock.
PHONESIN	• An operation is prohibited because headphones are connected.
MUTING	• An operation is prohibited because the sound is muted.
EXIT	• Appears briefly when a menu is automatically exited when the microphone or headphone are inserted.
USB ERR	• See <i>Important in Using the USB interface</i> on page 35 for more on this.
NO MIC	• A karaoke feature is prohibited because no mic is connected.
MIC IN	• An operation is prohibited because the mic is connected.
SND. DEMO	• The sound demo is on. See <i>General in Troubleshooting</i> on page 52.
TRAYLOCK	• The tray lock is on. See <i>General in Troubleshooting</i> on page 52.
EEP ERR	• Contact your Pioneer authorized service center or your dealer for servicing.
CANNOT	• An operation is prohibited because DVD/CD or USB isn't selected, headphones are connected, or TEST TONE (SHIFT+RETURN) is pressed during disc playback.

Using the language code list

Some of the language options (see *Language settings* on page 42) allow you to set your preferred language from any of the 136 languages listed in the *Language code list*.

- 1 **Switch the system on.**
- 2 **Press the DVD/CD button and select DVD.**
Make sure the disc tray is empty.
- 3 **Use ←/→ to select either a code letter or a code number.**
- 4 **Use ↑/↓ to select a code letter or a code number.**

See the *Language code list* below for a complete list of languages and codes.

Language code list

Language (Language code letter), **Language code**

Japanese (ja), 1001	Estonian (et), 0520	Lingala (ln), 1214	Slovak (sk), 1911
English (en), 0514	Basque (eu), 0521	Laothian (lo), 1215	Slovenian (sl), 1912
French (fr), 0618	Persian (fa), 0601	Lithuanian (lt), 1220	Samoan (sm), 1913
German (de), 0405	Finnish (fi), 0609	Latvian (lv), 1222	Shona (sn), 1914
Italian (it), 0920	Fiji (fj), 0610	Malagasy (mg), 1307	Somali (so), 1915
Spanish (es), 0519	Faroese (fo), 0615	Maori (mi), 1309	Albanian (sq), 1917
Dutch (nl), 1412	Frisian (fy), 0625	Macedonian (mk), 1311	Serbian (sr), 1918
Russian (ru), 1821	Irish (ga), 0701	Malayalam (ml), 1312	Siswati (ss), 1919
Chinese (zh), 2608	Scots-Gaelic (gd), 0704	Mongolian (mn), 1314	Sesotho (st), 1920
Korean (ko), 1115	Galician (gl), 0712	Moldavian (mo), 1315	Sundanese (su), 1921
Greek (el), 0512	Guarani (gn), 0714	Marathi (mr), 1318	Swedish (sv), 1922
Afar (aa), 0101	Gujarati (gu), 0721	Malay (ms), 1319	Swahili (sw), 1923
Abkhazian (ab), 0102	Hausa (ha), 0801	Maltese (mt), 1320	Tamil (ta), 2001
Afrikaans (af), 0106	Hindi (hi), 0809	Burmese (my), 1325	Telugu (te), 2005
Amharic (am), 0113	Croatian (hr), 0818	Nauru (na), 1401	Tajik (tg), 2007
Arabic (ar), 0118	Hungarian (hu), 0821	Nepali (ne), 1405	Thai (th), 2008
Assamese (as), 0119	Armenian (hy), 0825	Norwegian (no), 1415	Tigrinya (ti), 2009
Aymara (ay), 0125	Interlingua (ia), 0901	Occitan (oc), 1503	Turkmen (tk), 2011
Azerbaijani (az), 0126	Interlingue (ie), 0905	Oromo (om), 1513	Tagalog (tl), 2012
Bashkir (ba), 0201	Inupiak (ik), 0911	Oriya (or), 1518	Setswana (tn), 2014
Byelorussian (be), 0205	Indonesian (in), 0914	Panjabi (pa), 1601	Tonga (to), 2015
Bulgarian (bg), 0207	Icelandic (is), 0919	Polish (pl), 1612	Turkish (tr), 2018
Bihari (bh), 0208	Hebrew (iw), 0923	Pashto, Pushto (ps), 1619	Tsonga (ts), 2019
Bislama (bi), 0209	Yiddish (ji), 1009	Portuguese (pt), 1620	Tatar (tt), 2020
Bengali (bn), 0214	Javanese (jw), 1023	Quechua (qu), 1721	Twi (tw), 2023
Tibetan (bo), 0215	Georgian (ka), 1101	Rhaeto-Romance (rm), 1813	Ukrainian (uk), 2111
Breton (br), 0218	Kazakh (kk), 1111	Kirundi (rn), 1814	Urdu (ur), 2118
Catalan (ca), 0301	Greenlandic (kl), 1112	Romanian (ro), 1815	Uzbek (uz), 2126
Corsican (co), 0315	Cambodian (km), 1113	Kinyarwanda (rw), 1823	Vietnamese (vi), 2209
Czech (cs), 0319	Kannada (kn), 1114	Sanskrit (sa), 1901	Volapük (vo), 2215
Welsh (cy), 0325	Kashmiri (ks), 1119	Sindhi (sd), 1904	Wolof (wo), 2315
Danish (da), 0401	Kurdish (ku), 1121	Sangho (sg), 1907	Xhosa (xh), 2408
Bhutani (dz), 0426	Kirghiz (ik), 1125	Serbo-Croatian (sh), 1908	Yoruba (yo), 2515
Esperanto (eo), 0515	Latin (la), 1201	Sinhalese (si), 1909	Zulu (zu), 2621

Country/Area code list

Country/Area, Country/Area code, **Country/Area code letter**

Argentina, 0118, ar	Hong Kong, 0811, hk	Philippines, 1608, ph
Australia, 0121, au	India, 0914, in	Portugal, 1620, pt
Austria, 0120, at	Indonesia, 0904, id	Russian Federation, 1821, ru
Belgium, 0205, be	Italy, 0920, it	Singapore, 1907, sg
Brazil, 0218, br	Japan, 1016, jp	Spain, 0519, es
Canada, 0301, ca	Korea, Republic of, 1118, kr	Switzerland, 0308, ch
Chile, 0312, cl	Malaysia, 1325, my	Sweden, 1905, se
China, 0314, cn	Mexico, 1324, mx	Taiwan, 2023, tw
Denmark, 0411, dk	Netherlands, 1412, nl	Thailand, 2008, th
Finland, 0609, fi	New Zealand, 1426, nz	United Kingdom, 0702, gb
France, 0618, fr	Norway, 1415, no	United States of America, 2119, us
Germany, 0405, de	Pakistan, 1611, pk	

Specifications

• Amplifier section

CX505/CX500 model

Continuous power output:

Front	100 W per channel (1 kHz, 10 % T.H.D., 4 Ω)
Center	100 W (1 kHz, 10 % T.H.D., 4 Ω)
Surround	100 W per channel (1 kHz, 10 % T.H.D., 4 Ω)
Subwoofer	100 W (100 Hz, 10 % T.H.D., 4 Ω)

CX303 model

Front	100 W per channel (1 kHz, 10 % T.H.D., 4 Ω)
Subwoofer	100 W (100 Hz, 10 % T.H.D., 4 Ω)

• Disc section

Digital audio characteristics

Type	DVD fs: 96 kHz, 24-bit DVD system, Video CD/Super VCD system and Compact Disc digital audio system
Frequency response	20 Hz to 44 kHz
S/N ratio	88 dB
Dynamic range	83 dB
Total harmonic distortion	0.01 %
Wow and Flutter	Limit of measurement (±0.001 % W.PEAK) or less (JEITA)

• FM tuner section

Frequency range	87.5 MHz to 108 MHz
Antenna	75 Ω, unbalanced

• AM tuner section

Frequency range:	
With 9 kHz step	531 kHz to 1602 kHz
With 10 kHz step	530 kHz to 1700 kHz
Antenna	Loop antenna

• Miscellaneous

Power requirements

Australia, New Zealand model	AC 240 V, 50 Hz/60 Hz
Singapore, Malaysia, Indonesia, Philippines, Argentine model	AC 220 V to 240 V, 50 Hz/60 Hz
Taiwanese model	AC 110 V, 50 Hz/60 Hz

Power consumption:

CX505/CX500 model	66 W
-------------------	------

CX303 model	43 W
Power consumption in standby mode	0.5 W

Dimensions:

DVD/CD Receiver	210 mm (W) x 112 mm (H) x 336 mm (D)
Power unit	197 mm (W) x 65 mm (H) x 162 mm (D)

Weight:

DVD/CD Receiver:	
CX505/CX500 model	2.9 kg
CX303 model	2.8 kg
Power unit	1.1 kg

• Accessories (DVD/CD receiver)

Remote control	1
Power cord:	
Duty free model	2
Argentine (CX303 only), Taiwan, Philippines models	2
All other models	1
Power plug adapter (CX303 Argentine model only)	1
Video cord	1
AM loop antenna	1
FM antenna	1
AA/R6 dry cell batteries (to confirm system operation)	2
These operating instructions	

S-CX303 Speaker system

• Front speakers

Enclosure	Closed-box bookshelf type (magnetically shielded)
System	10 cm 2-way system
Speakers:	
Woofer	10 cm cone type
Tweeter	2.6 cm semi-dome type
Nominal impedance	4 Ω
Frequency range	40 Hz to 20 kHz
Maximum input power	100 W
Dimensions	130 mm (W) x 221 mm (H) x 172 mm (D)
Weight	1.7 kg

• Subwoofer

Enclosure	Bass-reflex floorstanding type (magnetically shielded)
System	14 cm 1-way system

Speaker	14 cm cone type x 2
Nominal impedance	4 Ω
Frequency range	32 Hz to 6 kHz
Maximum input power	100 W
Dimensions	190 mm (W) x 444 mm (H) x 220 mm (D)
Weight	5.7 kg

- **Accessories**

Non-skid pads for front speakers	8
Non-skid pads for subwoofer	4

S-CX505 Speaker system

- **Front speakers**

Same as **S-CX303** Front speakers (see above).

- **Center speaker**

Enclosure	Closed-box bookshelf type (magnetically shielded)
System	7.7 cm 1-way system
Speaker	7.7 cm cone type
Nominal impedance	4 Ω
Frequency range	75 Hz to 18 kHz
Maximum input power	100 W
Dimensions	200 mm (W) x 108 mm (H) x 101 mm (D)
Weight	0.75 kg

- **Surround speakers**

Enclosure	Closed-box bookshelf type (magnetically shielded)
System	7.7 cm 1-way system
Speaker	7.7 cm cone type
Nominal impedance	4 Ω
Frequency range	75 Hz to 18 kHz
Maximum input power	100 W
Dimensions	130 mm (W) x 100 mm (H) x 110 mm (D)
Weight	0.68 kg

- **Subwoofer**

Same as **S-CX303** Subwoofer (see above).

- **Accessories**

Non-skid pads for front and surround speakers	16
Non-skid pads for center speaker	4
Non-skid pads for subwoofer	4

S-CX500 Speaker system

- **Front speakers**

Enclosure	Closed-box bookshelf type (magnetically shielded)
System	7.7 cm 1-way system
Speaker	7.7 cm cone type
Nominal impedance	4 Ω
Frequency range	80 Hz to 20 kHz
Maximum input power	100 W
Dimensions	100 mm (W) x 100 mm (H) x 103 mm (D)
Weight	0.55 kg

- **Center speaker**

Enclosure	Closed-box bookshelf type (magnetically shielded)
System	7.7 cm 1-way system
Speaker	7.7 cm cone type
Nominal impedance	8 Ω
Frequency range	80 Hz to 20 kHz
Maximum input power	50 W
Dimensions	100 mm (W) x 100 mm (H) x 103 mm (D)
Weight	0.55 kg

- **Surround speakers**

Enclosure	Closed-box bookshelf type (magnetically shielded)
System	7.7 cm 1-way system
Speaker	7.7 cm cone type
Nominal impedance	4 Ω
Frequency range	80 Hz to 20 kHz
Maximum input power	100 W
Dimensions	100 mm (W) x 100 mm (H) x 103 mm (D)
Weight	0.55 kg

- **Subwoofer**

Same as **S-CX303** Subwoofer (see above).

- **Accessories**

Speaker cables	5
Brackets	2
Screws	8
Spiral wrap	2
Non-skid pads for front, center and surround speakers	24
Non-skid pads for subwoofer	4



Note

- Specifications and design subject to possible modification without notice, due to improvements.

This product includes FontAvenue® fonts licenced by NEC corporation. FontAvenue is a registered trademark of NEC Corporation.

This product incorporates copyright protection technology that is protected by method claims of certain U.S. patents and other intellectual property rights owned by Macrovision Corporation and other rights owners. Use of this copyright protection technology must be authorized by Macrovision Corporation, and is intended for home and other limited uses only unless otherwise authorized by Macrovision Corporation. Reverse engineering or disassembly is prohibited.

DRM (digital rights management) copy protection is a technology designed to prevent unauthorized copying by restricting playback, etc. of compressed audio files on devices other than the PC (or other recording equipment) used to record it. For detailed information, please see the instruction manuals or help files that came with your PC and/or software.

Manufactured under license from Dolby Laboratories. "Dolby", "Pro Logic" and the double-D symbol are trademarks of Dolby Laboratories. "DTS", "DTS Digital Surround" and "DTS 2.0" are registered trademarks of DTS, Inc.

Published by Pioneer Corporation.
Copyright © 2007 Pioneer Corporation.
All rights reserved.

PIONEER CORPORATION

4-1, Meguro 1-Chome, Meguro-ku, Tokyo 153-8654, Japan

PIONEER ELECTRONICS (USA) INC.

P.O. BOX 1540, Long Beach, California 90801-1540, U.S.A. TEL: (800) 421-1404

PIONEER ELECTRONICS OF CANADA, INC.

300 Allstate Parkway, Markham, Ontario L3R 0P2, Canada TEL: 1-877-283-5901, 905-479-4411

PIONEER EUROPE NV

Haven 1087, Keetberglaan 1, B-9120 Melsele, Belgium TEL: 03/570.05.11

PIONEER ELECTRONICS ASIACENTRE PTE. LTD.

253 Alexandra Road, #04-01, Singapore 159936 TEL: 65-6472-7555

PIONEER ELECTRONICS AUSTRALIA PTY. LTD.

178-184 Boundary Road, Braeside, Victoria 3195, Australia, TEL: (03) 9586-6300

PIONEER ELECTRONICS DE MEXICO S.A. DE C.V.

Blvd.Manuel Avila Camacho 138 10 piso Col.Lomas de Chapultepec, Mexico,D.F. 11000 TEL: 55-9178-4270

K002_B_En

Free Manuals Download Website

<http://myh66.com>

<http://usermanuals.us>

<http://www.somanuals.com>

<http://www.4manuals.cc>

<http://www.manual-lib.com>

<http://www.404manual.com>

<http://www.luxmanual.com>

<http://aubethermostatmanual.com>

Golf course search by state

<http://golfingnear.com>

Email search by domain

<http://emailbydomain.com>

Auto manuals search

<http://auto.somanuals.com>

TV manuals search

<http://tv.somanuals.com>