

Pioneer *sound.vision.soul*

Home Entertainment Guide 2001-2002





DIGITAL HOME CINEMA SYSTEMS



DJ PRODUCTS

sound.vision.soul

Seeing and hearing is believing! Imagine freeing your mind and soul any moment of the day, anywhere you happen to be. That's what the Pioneer spirit is all about. And there are a lot of different ways for you to make sure your life is more rewarding, vivid and most of all — fun! If you want to push the limits, opt for Pioneer. It is a great way to discover the intense world of personal entertainment. With Pioneer, you'll really start living...your way!

The choice is a tough one: from exciting in-car multimedia systems to digital DVD home cinema systems with plasma displays to top-of-the-line DJ products. With DVD taking centre stage as the new cross-platform Audio Visual digital standard for home entertainment, digital storage and computer-based playback and writing, Pioneer forges ahead and makes their mark as a leader in DVD. You'll find a complete selection of DVD options, including the latest in DVD-Audio/Video players, a ground-breaking DVD writer and — coming soon — a DVD recorder. That's just the start of the fun. So take your pick. And live life to the fullest.

Pioneer *sound.vision.soul*



IN-CAR MULTIMEDIA SYSTEMS

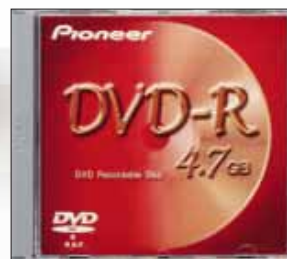

COMPUTER HARDWARE

The excitement's all there – and more – @

<http://www.pioneer-eur.com>

Drop by soon!

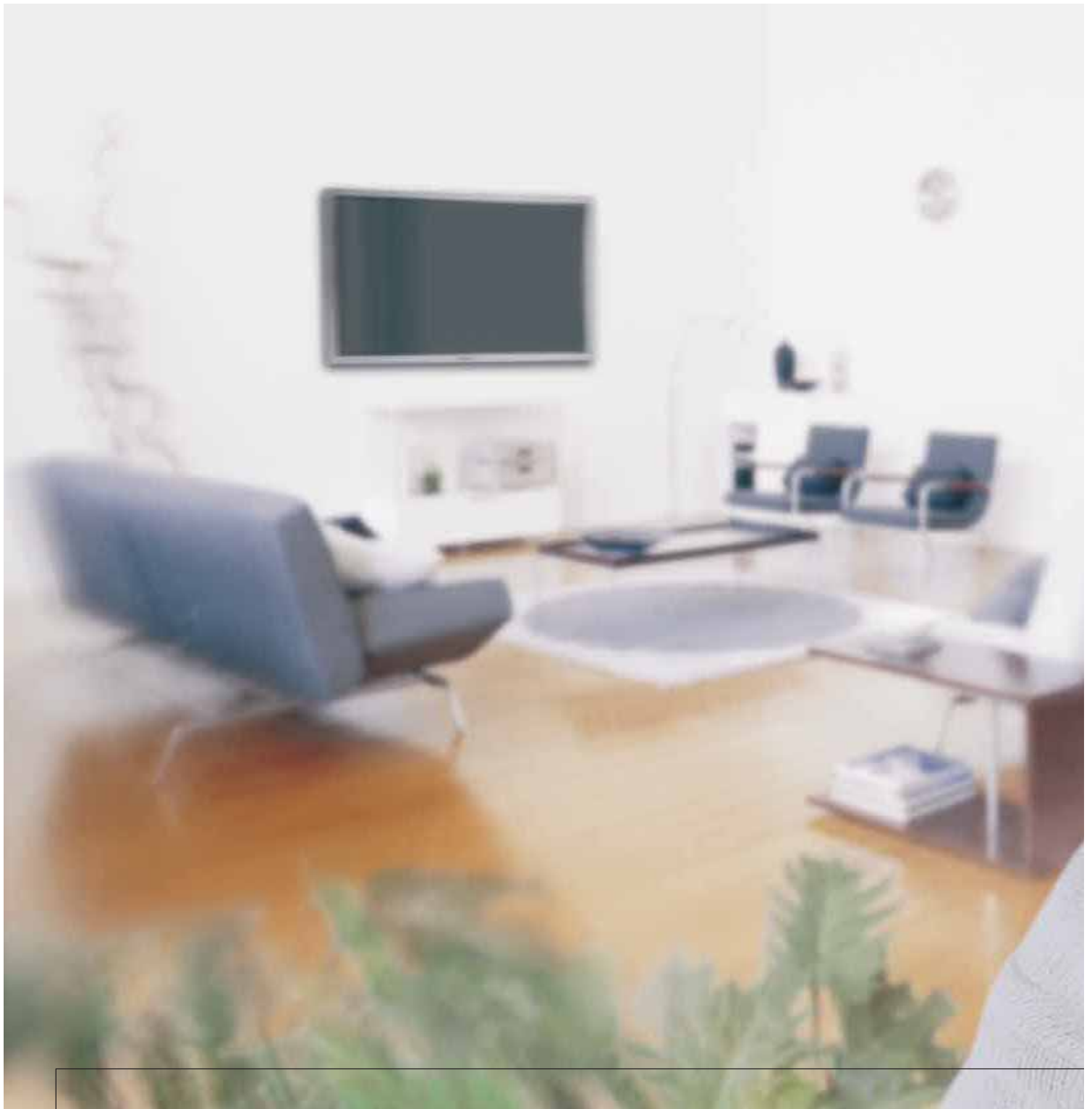

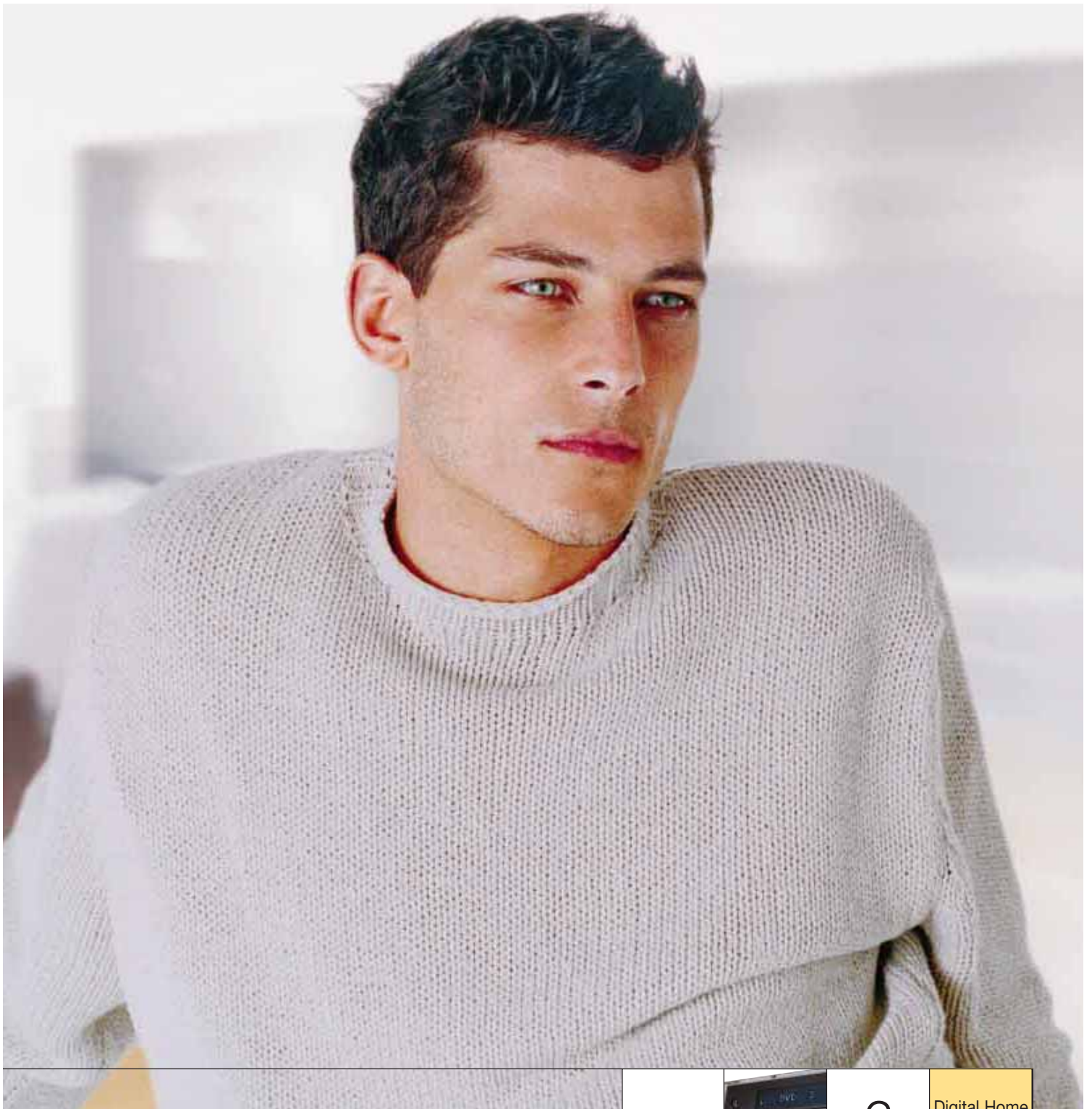

A moment to experience

You know that moment of anticipation before you hit play? It's like the start of a race. Just before the sound starts rushing around your room from your surround sound system. Before the sharper-than-sharp images and vivid colours jump off your plasma screen. It feels like an experience of a lifetime is about to happen. And with Pioneer, it will. There's a full range of lean DVD players for whatever you had in mind: upgrade to a DVD-Audio/Video player; or splurge on a digital home cinema system. Visually speaking, you'll seriously consider the practical wall placement of the hot new plasma screen. Or maybe you find yourself pondering the latest design audio system for your bedroom. From a specific DVD player to an entire home entertainment system, Pioneer is ready to help you experience the excitement of home entertainment.



Contents

Digital Home Cinema	6
Hi-Fi Components	34
Design Audio Systems	48
Hi-Fi Systems	54
Technology	58
Features and Specifications	60

	6	Digital Home Cinema
	34	Hi-Fi Components
48		Design Audio Systems
	54	Hi-Fi Systems

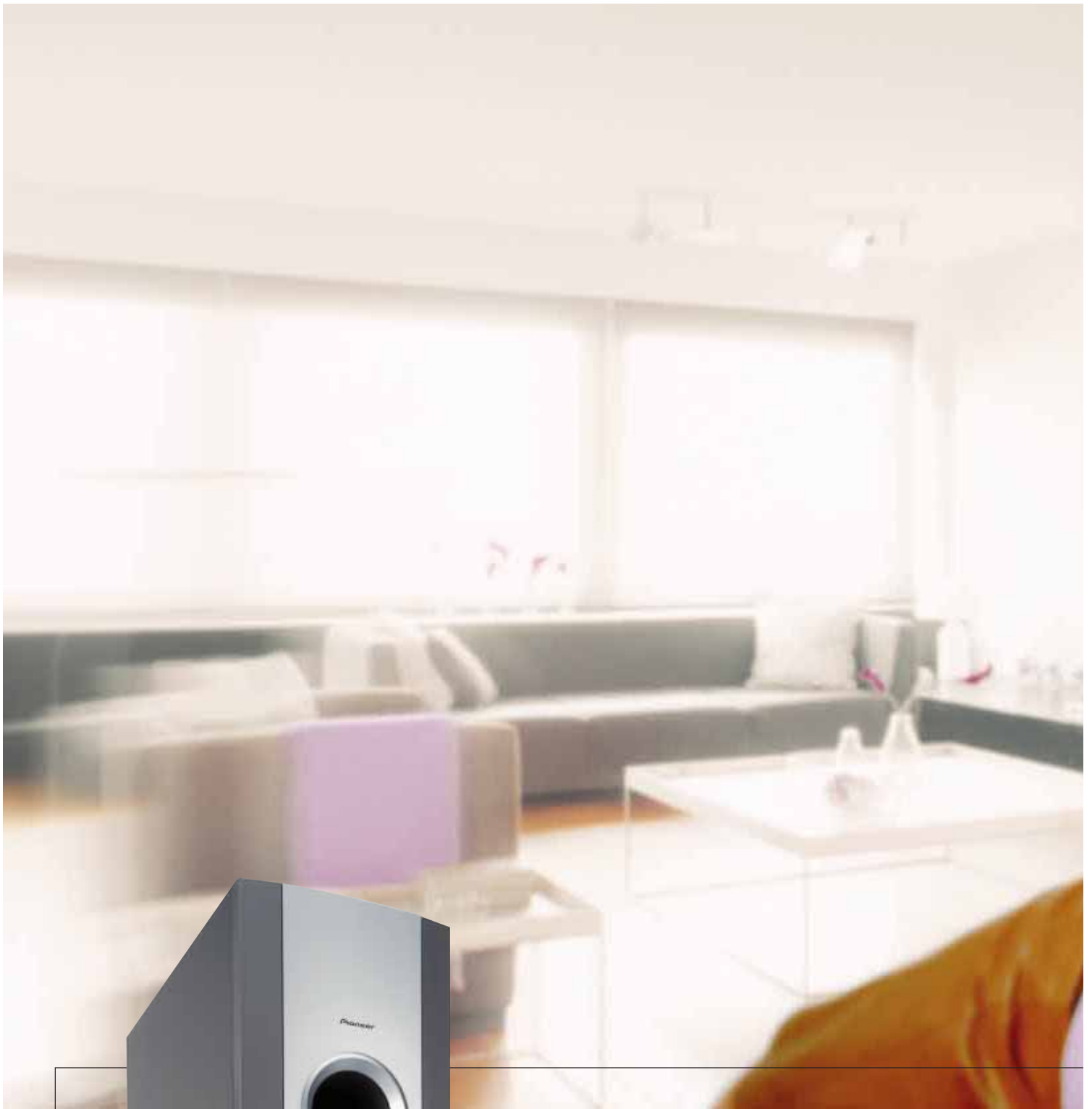

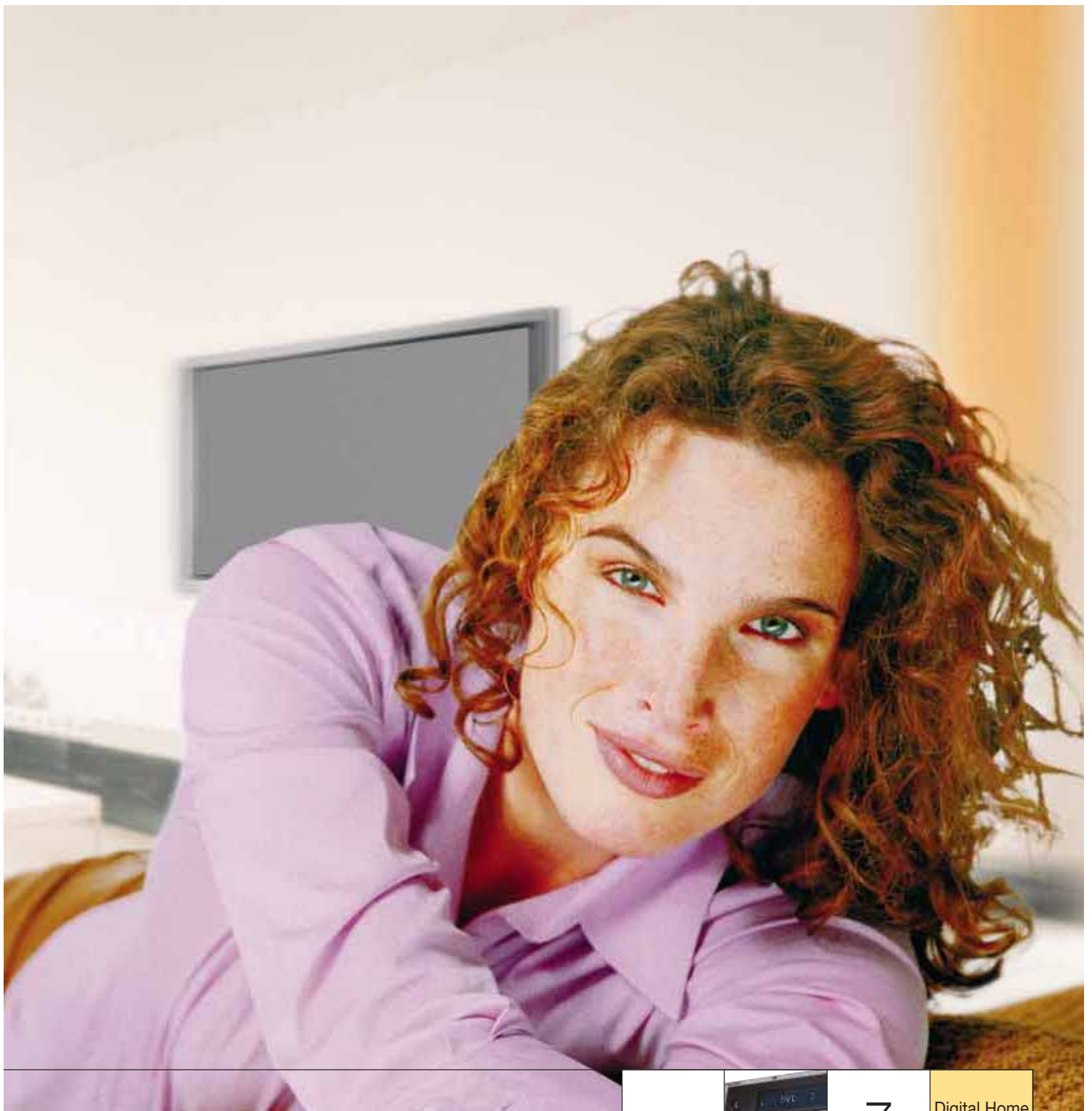

A moment to thrill



7

Digital Home
Cinema

Pioneer brings joy right into your living room with the latest in digital home cinema. This total movie experience adds the full benefit of DVD and sumptuous surround sound to your favourite films, from old classics to the latest special-effects megahits. You have never experienced personal cinema as "live" as this right from your own sofa. And with Pioneer, home cinema is easy! Whether you are looking for the entire experience in one stylish package or are in the process of upgrading your current system step-by-step, just pick the option that suits your style. You might decide to subtly impress with a superb Slimline system or knock their socks off with the latest DVD-Audio/Video player or cool plasma screen. From compact, easy-to-install, all-in-one solutions to the freshest selection of components, Pioneer digital home cinema is designed to overwhelm your senses.



Make a style statement



EXPANDED CONNECTION POSSIBILITIES (NS-DV88/NS-DV77/DCS-100)

More than design elements, the NS-DV88, NS-DV77 and DCS-100 offer numerous connection possibilities. Feel free to connect your VCR to integrate your videotape library into your home entertainment centre, or maybe connect an optional MiniDisc to the NS-DV88 or NS-DV77. And, of course, the television sound can be connected as well. In preparation for the future, these systems feature an optical digital and coaxial* digital input so that the digital audio output of a broadcasting receiver can easily be connected, enabling you to enjoy future digital broadcasts. The connection flexibility is there – all you have to do is decide how to personalise your system.

*DCS-100 is equipped with an optical digital input only.

COLOUR-CODED TERMINALS AND SPEAKER CABLES (NS-DV88/NS-DV77/DCS-100/HTD-5)

Pioneer takes the guessing game out of installation with colour co-ordinated cables and connection points. Just match the colours and you're ready to enjoy your new DVD system in minutes!

TOUCH SENSOR KEYS (NS-DV88/NS-DV77)

So seductive. The touch sensitive keys on the central component just scream to be caressed. For your convenience, you'll hear a beep that confirms you've hit the button.

Understated sophistication is your style statement. Then you'll love the luxury of the latest Pioneer slim design home cinema systems. From seductive touch keys to a choice of sleek silver or wooden satellite speakers to colour-coded cables for easy installation, Pioneer has respected every aesthetic detail without overlooking the fact that super sharp images and zoom-around-the-room sound is what a DVD home cinema system is all about. They've even made a perfectly matching MiniDisc recorder and cassette deck. With all this technology, you're in for pure cinema pleasure in a classy package – appropriate anywhere.

NS-DV88



40 W x 5 + 65 W RMS

NEW

DIGITAL HOME CINEMA SYSTEM

Functional yet contemporary, this all-in-one, super-sleek-designed digital home cinema system includes finishing touches like a separate ice blue display that you can place where you prefer. You won't believe such amazing sound and image quality flies out of the sleek central unit housing the DVD/VCD/CD/tuner. It can even playback your CD-R and CD-RW discs. Plus it's packed with Dolby Digital, DTS and MP3 decoders as well as a plethora of connections for components like your TV, VCR, CD recorder or even a set-top box with digital audio output. Completing this package are the wooden centre and satellite speakers and a subwoofer that carries the 5.1 channel surround amplifier. Count on 265 watts of astounding surround sound power and lots of stylish character.



NS-DV77



40 W x 5 + 65 W RMS

NEW

DIGITAL HOME CINEMA SYSTEM

You like your digital home cinema sophisticated and stylish. Then, this all-in-one silver design package has your name on it. With its silver tones, this superb home cinema surround sound set is a work of art. The package includes: a centre speaker and 4 silver satellite speakers, a subwoofer power-packed with 5.1 channel surround amplifier, a central unit housing the high-tech DVD/VCD/CD/tuner with Dolby Digital, DTS and MP3 decoders and CD-R/RW playback capability. The finishing detail: a separate ice blue display that can be placed where it suits you best... Don't hesitate to try out its wide range of connections to integrate all kinds of components to your system, such as your TV, VCR, CD recorder or even a set-top box with digital audio output.



MJ-L11



NEW



MINIDISC RECORDER FOR NS-DV88, NS-DV77, NS-11-Q AND NS-11-S (optional)

A match made in heaven, this slim model is a perfect way to record and edit MiniDiscs. Create your own compilations right in your entertainment centre so that you can take your personalised collection everywhere you go. With its special MD LP* (Long Play) feature, you'll have four times the recording time!

*Please see page 39 for more information.

CT-L11

NEW



CASSETTE DECK FOR NS-DV88, NS-DV77, NS-11-Q AND NS-11-S (optional)

Can't part with your favourite tapes? Not to worry. They'll still be stylish in the matching cassette deck. Just slide them into the chic slot-in deck and play.

JC-L11

NEW

EXTENSION CORD FOR NS-DV88, NS-DV77, NS-11-Q AND NS-11-S (optional)

Add the optional 5 metre extension cord – in case you decide to move the separate display further from the main unit.

CP-F50

NEW

SPEAKER STAND FOR NS-DV88 AND NS-DV77 (optional)

Please see page 31 for more information.



For full product features and specifications, please see pages 60 to 61 and 65.

SLIMLINE DIGITAL HOME CINEMA SYSTEMS



Face it. You are a rather practical person. You want the flexibility and expandability of components with convenient versatile connections, but you definitely don't want bulky units. Not to mention the fact that you'd like an elegant, good-looking component system that makes a subtle statement. Then Pioneer's new Slimline digital home cinema system – available in black or silver finish – is the way you want to think DVD. With matching thin speakers, the super-sleek DVD-Video player and A/V receiver components are your key to an overwhelming digital home cinema experience. A total solution loaded with features, these fabulous design components go anywhere – on a shelf, in a TV rack or stylishly placed on a cabinet.

SLIMLINE



30 W x 5 + 110 W DIN

NEW

DIGITAL HOME CINEMA COMBINATION

A featured-packed component system that's ultra-thin yet still delivers fantastic home cinema. That's the definition of the Slimline digital home cinema system. Thanks to the redesigned drive mechanism, the stylish DV-444-S/DV-444-K only measures an incredible 5.5 cm in height. Add on the 6.5 cm high VSX-C300/VSX-C300-S receiver – with its multiple front connection terminals it's a perfect A/V system manager – and the subtle S-V50-K/S-V50-QL 5.1 surround speaker system, and you'll discover how incredible home cinema can be. With the Slimline system's easy-to-use set-up features, the digital home cinema experience has reached new levels of convenience!

Available as HC-50SK (DV-444-S and VSX-C300-S in silver finish with S-V50-K, an A/V speaker set with black subwoofer). Available as HC-50SQL (DV-444-S and VSX-C300-S in silver finish with S-V50-QL, an A/V speaker set with light wood-tone subwoofer). Available as HC-50K (DV-444-K and VSX-C300 in black finish with S-V50-K, an A/V speaker set with black subwoofer). Available as HC-50KQL (DV-444-K and VSX-C300 in black finish with S-V50-QL, an A/V speaker set with light wood-tone subwoofer).



For full product features and specifications, please see pages 62 to 67.

DCS-100 DIGITAL HOME CINEMA SYSTEM



DCS-100



25 W x 6 RMS

NEW

DIGITAL HOME CINEMA SYSTEM

Keep it simple is your motto. Then you'll certainly be attracted to the stylishly compact DCS-100. It starts with an extremely slim, 7.5 cm high unit that handles everything you'll need: a DVD/CD/VCD player with MP3 playback, RDS tuner and 5.1 channel amplifier. Forget about complicated programming and features. All main functions and controls can easily be operated via the buttons on the slanted front panel or via the remote control. Just slip it on a shelf or TV rack, connect the silver centre and satellite speakers using the handy colour coordinated terminals and cables, find a nook for the compact 16 cm subwoofer, and hook up any other components like a TV, VCR, a CD recorder or a digital broadcasting receiver. Then, you're ready to enjoy fantastic home cinema.



THEATER BASS

A 16 cm subwoofer. Fantastic, but how can it possibly pump out powerful bass? Well, the secret is a great new technology called Theater Bass, which uses highly advanced amplitude and phase control to generate the richest bass possible from this little compact subwoofer.

HTD-5 DIGITAL HOME CINEMA SYSTEM



HTD-5



80 W x 3 + 30 W x 3 RMS

NEW

DIGITAL HOME CINEMA SYSTEM

This full-featured, power-packed home cinema solution has everything on your checklist: a 5-disc DVD/CD/VCD carousel so you can play a selection of CDs and a built-in 5.1 channel, 330 watt RMS amplifier for explosive sound. Of course, there are Dolby Digital and DTS decoders. And with so much power you'll need a dynamic set of speakers. Well, check that off your list too. For extra sound dimension, the front speakers in this system are 2-way and the centre speaker is vertically re-sized for crisper cinematic dialogue. An 80 watt, 16 cm subwoofer completes the package and ensures an overwhelming home cinema experience.



5-DISC CAROUSEL

Just hit random play to enjoy the same functionality as a CD changer. DVDs in the carousel are not a problem because the component just skips over them.



For full product features and specifications, please see pages 60 to 61 and 65.

Going digital: Create your own home cinema set-up

A digital home cinema set-up may seem like a huge change, but it is not. Take a look at the simple steps below, and discover how easy it is to create your very own home cinema system.

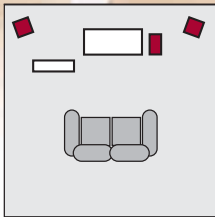

STARTING OUT

Start with what you have: your VCR, TV, stereo hi-fi system speakers, CD player and amplifier.



1

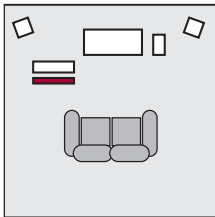

STEP 1: ADD A DVD PLAYER

To start, add a DVD player – choose from a standard unit, design models or even a trendy portable – to your TV/VCR combination. Besides outstanding image quality and superb sound, DVD lets you view films in various languages with a selection of soundtracks and enjoy other easy and convenient features, such as viewing per chapter and movie angle selection.



OR



2

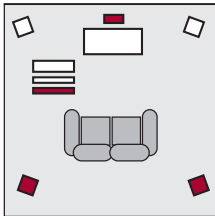

STEP 2: ADD AN A/V SURROUND RECEIVER OR AMPLIFIER + CENTRE/REAR SPEAKERS

Then, add a Pioneer A/V surround amplifier or receiver as well as centre and rear speakers to experience supreme surround sound. Choose carefully because the A/V amplifier or receiver is the central component in any home cinema system, connecting all the units and amplifying sound from your TV, DVD, CD or MiniDisc. A Pioneer A/V amplifier or receiver not only provides powerful sound, but you can connect a variety of image sources, such as a video camera. This is especially easy if your A/V unit has input terminals on its front panel.



3

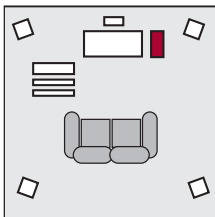

STEP 3: ADD A SUBWOOFER

The final touch. Add a quality subwoofer to create perfect 5.1 channel surround sound. With 6 speakers in total – 2 front, 2 rear, 1 centre and 1 subwoofer, you'll be able to enjoy Dolby Digital or DTS surround sound. The subwoofer guarantees sonorous bass reproduction. Just like in the cinema. Or, if your existing speakers seem a bit tired, treat yourself to a completely new 5.1 channel A/V speaker set!



4

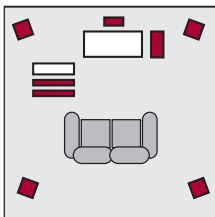

ONE-STEP SOLUTION: DIGITAL HOME CINEMA SYSTEMS

You just want a simple solution? Then, forget the step-by-step programme and go straight for an all-in-one digital home cinema system, like Pioneer's Slimline set. You'll discover a great-looking DVD-Video player, sleek A/V receiver and ultra-modern centre and satellite speakers with a black or wood-toned subwoofer. Interested in more of Pioneer's total home cinema solutions? Look to the next page...



Your choice: Total solutions for digital home cinema

Sometimes it is hard to make up your mind. Well, maybe this will help. We've made a selection of four of our leading home cinema solutions. This way all you have to decide is which one suits you best, according to your taste and technical requirements. Stylish and sophisticated? Then, check out the NS-DV88. Want to enjoy a full-fledged system in half the space? Slimline, maybe. Keep it compact yet stylish? DCS-100 is probably the direction you want. Do you tend to dream about A/V equipment? Then check out the Starter Component Combination. You get the idea. So, what are you waiting for?

ALL-IN-ONE DESIGN SYSTEM

NS-DV88 DIGITAL HOME CINEMA SYSTEM

You'll love the luxury of the NS-DV88. Everything you need comes in one simple system: a DVD/CD tuner unit and a 5.1 surround sound speaker system. Not only is it stylishly designed, but everything matches perfectly. Plus you can install it in a few minutes. What a pleasant experience! With sensual touch buttons and smooth, wooden speakers, this home cinema system has more than enough subtle style to impress you and your guests. You'll spoil yourself. We guarantee it.

Also available as NS-DV77 with silver-tone speakers.



DESIGN COMPONENT COMBINATION

SLIMLINE: DV-444-S + VSX-C300-S + S-V50-K (HC-50SK)

You are thinking about an all-out home cinema system. But the thought of bulky components in your living room is holding you back. Well, your problems are solved with the Slimline package. The super-thin, stylish DV-444-S DVD-Video player and VSX-C300-S A/V receiver slip into your TV rack and the sleek S-V50-K 5.1 surround sound speaker system subtly blends around the room. This is the perfect centre for all your A/V entertainment: hook up your digital video camera or the latest game using the handy front digital audio input. Thanks to Slimline, you'll certainly own the most streamlined home cinema system.

Also available as HC-50SQL (DV-444-S and VSX-C300-S in silver finish with S-V50-QL, an A/V speaker set with light wood-tone subwoofer). Available as HC-50K (DV-444-K and VSX-C300 in black finish with S-V50-K, an A/V speaker set with black subwoofer). Available as HC-50KQL (DV-444-K and VSX-C300 in black finish with S-V50-QL, an A/V speaker set with light wood-tone subwoofer).



ALL-IN-ONE COMPACT SYSTEM

DCS-100 DIGITAL HOME CINEMA SYSTEM

You love it simple. No fuss. Then, give the DCS-100 digital home cinema system a shot. It has all you want in one package. A space-saving main unit with easily accessible buttons on the slanted front panel that fits right into your TV rack. No more complicated procedures. Simple buttons control the main functions. Just hook up the all-in-one DVD/CD player, RDS tuner and 5.1 channel amplifier to the centre and satellite speakers and an innovative ultra-compact subwoofer and enjoy! Quality home cinema can't get any easier than this.



STARTER COMPONENT COMBINATION

DV-343 + VSX-D510 + S-V31-W

Are you dreaming of putting together your own quality home cinema system, but not sure where to start? And you're dying to try out all those extra features, dials and buttons. Then you are a prime candidate for a component-based system. So, let us make a home cinema suggestion: the DV-343 DVD-Video player, VSX-D510 A/V receiver featuring Dolby Digital and DTS and the S-V31-W 5.1 surround sound A/V speaker set including the S-W80S-K active subwoofer. You'll get home cinema that knocks your socks off, without breaking your budget.



To find out even more about Pioneer's digital home cinema systems or combinations, ask your local Pioneer dealer. They will be pleased to give you a live demonstration and answer any questions.

For full product features and specifications, please see pages 60 to 67.



Record on DVD



At Pioneer you could say that we wrote the book on optical disc technology. It all began way back in 1980 when we introduced the first laser disc player to the market (a full two years before the introduction of the audio CD). In 1996 we bested the competition with the introduction of the first DVD player and now we are proud to announce the launch in the coming months of the home DVD Recorder which boasts twice the video resolution of conventional VHS or S-VHS tapes, high quality digital sound, and a convenient size. Recordable DVD is the next giant leap. A home entertainment revolution that you either join or find yourself left behind!



DVR-7000

COMING SOON

At Pioneer we develop cutting edge equipment that is easy to use. The Pioneer DVD Recorder is no exception. A combination of user-friendly controls and highly advanced technology, our DVD Recorder enables everyone, young and old alike, to enjoy the highest standard of digital video recording.

KNOW YOUR DISCS AND RECORDING OPTIONS*

Two kinds of recordable discs were developed to be used in combination with the DVD Recorder:

DVD-R: a disc that can be recorded only once. It is less expensive and used for "Video" mode recording, which lets you record digitally but with limited editing facilities.

DVD-RW discs: costs slightly more but can be used to record up to 1,000 times without any deterioration in picture nor in sound quality. With this disc you can record in:

"DVD Video Recording" mode, which lets you edit your movies as you wish thanks to its advanced editing features and easy navigation and, of course, record or erase at your convenience.



"Video" mode, to record a whole programme or movie, for one time watching being able to re-use the disc again and again for same or different use.



To guarantee its commitment to DVD technology, Pioneer supports recording on DVD-Forum endorsed DVD-R (for general) discs and DVD-RW discs. And it also provides a "Video" mode compliant with DVD Forum specifications enabling playback** of recorded DVD-R and DVD-RW discs on many existing DVD players and DVD-ROM drives.

* TV broadcast reception of the integrated tuner may not be supported in all countries.

** The DVD Forum in 2000 approved the use of the DVD-Video format for recording on DVD-R/DVD-RW discs. On Pioneer's DVD Recorders this is referred to as recording in "Video Mode". Supporting playback of DVD-R/DVD-RW discs with this type of content is optional for manufacturers of DVD playback devices, and there are DVD-Video players, DVD-ROM drive equipped PCs or other DVD playback devices that do not play DVD-R or DVD-RW discs recorded in Video Mode. For details, please refer to the following Homepage: www.pioneer-eur.com (for European market only).



CD (650 MB)		DVD (4.7 Gbytes)
CD-ROM Video CD CD-DA	→	DVD-ROM DVD-Video DVD-Audio 
CD-R Write-once	→	DVD-R Write-once 
CD-RW Re-writable (≥1,000)	→	DVD-RW Re-writable (≥1,000) 

	DVD-R for General Ver. 2.0	DVD-RW Ver. 1.1
		
Capacity (12 cm discs)	• 4.7 Gbytes/side	• 4.7 Gbytes/side
Technology	• Write-once • Organic Dye	• Re-writable (≥ 1,000) • Phase Change

CREATIVE DVD RECORDING



No QUALITY LOSS/PERFECT AND EASY STORAGE

The safest place to store your most valuable possessions – your memories. Did you know your life's most precious moments are slowly disappearing? It is true. As you read this, all the football matches, birthday parties, weddings and celebrations you've documented on videotape are deteriorating. DVDs, on the other hand, can store up to six hours of footage and have a lifespan of many decades with no degradation in audio and video quality.



No MORE REWINDING

Imagine never having to fast forward or rewind again. With Pioneer's DVD Recorder those days are gone. Every time a new programme is burned to a DVD-RW disc in "DVD Video Recording" mode, the recorder automatically creates a thumbnail image of the opening scene on an easy-to-use menu page. As each new recorded event is given its own numbered sequence, jumping to your favourite scene is a snap. No more hunting through six hours of VHS videotape to find what you're looking for – with DVD Recording everything happens at the touch of a button.



QUALITY CONTROL

In the old days of VCR recording, you were faced with the choice of sacrificing video quality for longer playing time. We have the solution: variable bit rate recording. The Pioneer DVD Recorder can use this innovative feature to calculate the remaining space on a DVD-RW disc and then select the highest possible recording quality for the amount of time needed to capture your programme.

EDITING POSSIBILITIES: EDIT YOUR FAVOURITE MEMORIES

And the award for the best editing goes to...You!
 Fancy editing hasn't traditionally been a hallmark of the average home movie. Who hasn't sat through fifteen minutes of the back of someone's head while watching a wedding video? With the Pioneer DVD Recorder, creating an entertaining home movie is a piece of cake for even novice directors!
 For starters, you can seamlessly cut and edit camcorder footage directly in the digital domain, so there is no degradation of footage. The Pioneer DVD Recorder includes an i.LINK input (it is equipped with a DV in/out terminal for easy DV camcorder recording on a DVD-R or DVD-RW disc, to meet user demands) that connects directly to your camera. This way you can make all your edits and then simply hit "record". You'll have a high-resolution DVD of your family event that doesn't send your friends to sleep.

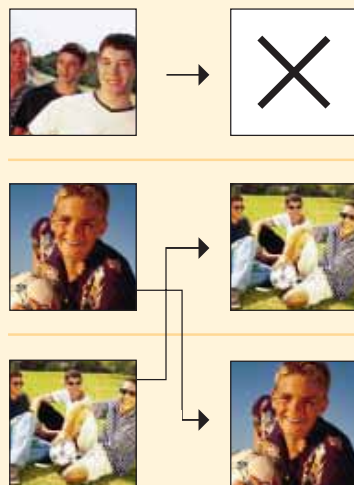



Brilliantly digital DVD diversity



DVD-AUDIO: A NEW FORMAT IS BORN (DV-939A/DV-646A)

MULTI-CHANNEL SURROUND SOUND

For true music lovers, nothing equals a live concert experience. Until now. As well as the best-ever 2 channel stereo, DVD-Audio delivers total-immersion 6 channel surround sound using a significantly higher definition linear PCM (Pulse Code Modulation), far exceeding the frequency range of CDs. This fuller, more expressive performance makes every sound come alive.

Multi-channel sources play beautifully also in 2 channel stereo – tracks are automatically downmixed and the DVD-Audio format even offers the flexibility to the producer to steer how this will be done by the player.

ADVANCED INFORMATION AND INTERACTIVE CAPABILITY

Just like DVD-Video, DVD-Audio discs feature more than the performance. In fact, your DVD-Audio disc can be crammed full of artist bios, background information, lyrics, liner notes and more. If you want, you can even highlight different sections of the music – that's just one of several options, all easily accessed via the interactive menus. Some discs even come with videos, still photos, and connections to related websites.

STAGGERING SOUND REALISM

With CDs, it's not unusual to lose definition in fast-paced passages or with high-pitched instruments. DVD-Audio solves that problem. With a sampling frequency 4.3 times higher and a resolution 256 times finer than CDs, DVD-Audio captures the highest frequency range and separates individual notes for richer, cleaner and astoundingly true-to-life sound. DVD-Audio's ultra-high resolution and dynamic range (up to 144 dB compared to CD's 96 dB) is a result of up to 24-bit quantisation and 192 kHz sampling, a significant advance over the 16-bit and 44.1 kHz of CDs.

ULTRA-HIGH VOLUME STORAGE

Imagine an audio disc that can play continuously 400 minutes of 2 channel stereo sound at 44.1 kHz/16-bit (audio CD resolution). Or more than 1 hour of 6 channel 96 kHz/24-bit or 2 channel 192 kHz/24-bit audio. A DVD-Audio disc can. Because discs can hold so much data – 4.7 Gbytes or almost seven times a CD when using the single side/single layer format.

Note: Actual DVD-Audio options will depend on the DVD discs' contents.

DVD PLAYERS

Compact. Design. Component-based. Super-portable. Pioneer DVD players cover it all. Looking for the latest exceptional DVD-Audio/Video player? We've got it. Thinking about a basic DVD-Video model? We've got that, too. No matter what your DVD criteria are, Pioneer, the leader in DVD technology, meets even the most discriminating tastes. Talking crème de la crème, the choice is difficult. With the DV-939A and DV-646A, Pioneer offers two superb DVD-Audio/Video players to enjoy the crystal-clear, super high-fidelity sound of DVD-Audio as well as the sharp images of DVD-Video. Want to make a statement? Then consider one of the new ultra-slim DVD-Video players. So sleek you wouldn't dare call it compact! And if you're looking for a starter model, you'll find those as well. If you see travel in your future, you might consider a portable DVD-Video player to take your movies anywhere. So, if you are looking for the perfect DVD solution for your system, you found the right place.

DV-939A



If you are looking for a true reference source, look no further than this DVD-Audio/Video player for pure crystal-clear audio from DVD-Audio discs and realistic image quality from DVD-Video discs. Its 192 kHz/24-bit twin D/A converter flawlessly reproduces DVD-Audio pure stereo music through the left and right front channel. Another two 2 channel 96 kHz/24-bit D/A converters guarantee the utmost surround sound quality. The triple-layered chassis and acoustic damper tray keep the unit and loading tray respectively stable for exceptional sound performance. And there's more. For hyper-realistic video images count on the Dual Stage Video Quality Enhancer to bring out the finest colours and sharpest picture possible. Its progressive scan circuit produces smooth and detailed images, just like on the silver screen. Of course, the DV-939A handles all the basic formats: DVD-Audio, DVD-Video, CD, VCD, CD-R, CD-RW and DVD-R/DVD-RW ("Video" mode playback only). And no, you're not dreaming!



192 kHz/24-bit TWIN D/A CONVERTER FOR DVD-AUDIO (DV-939A)

To meet the unprecedented potential of the DVD-Audio format, the DV-939A features two high quality and high performance 192 kHz/24-bit D/A converters, one for each front channel. In addition, another two 2 channel 96 kHz/24-bit D/A converters guarantee the utmost surround sound quality. DVD-Audio's full specification formats are flawlessly reproduced: wide-range 2 channel sound at 192 kHz/24-bit and 6 channel surround sound at 96 kHz/24-bit, as well as anything in between. A wider range of music sources can be faithfully reproduced based on the original sound, yielding spectacularly realistic audio.

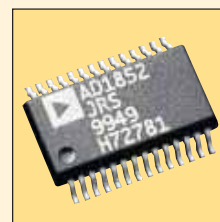

For full product features and specifications, please see pages 62 to 63.



This clean-cut DVD-Video player equally delivers high quality images and the purest sound. We know that sound is important to you, which is why this forward thinking DVD-Video player has separately designed audio circuits that perfectly complement its video enhancing features. Combined, this means pure perfection in audio and visual design... and it looks good, too.

DV-737 shown above. Also available as DV-737-K with black finish.

DUAL STAGE VIDEO QUALITY ENHANCER SYSTEM (DV-939A/DV-737(-K))

The Dual Stage Video Quality Enhancer System is every DVD fan's dream. It allows the DV-939A and DV-737(-K) to bring out the finest colours and the sharpest images from your DVD-Video discs. In the first stage, the Mosquito Noise and Block Noise Reduction (VQE-5) reduce noise generated during the MPEG encoding process. During the second stage, video quality is improved even more thanks to the Component Frame DNR PRO, Progressive Scan (VQE-3). The 54 MHz Fine Focus Digital Filter and 54 MHz/10-bit D/A Converter (VQE-5) realise high resolution and low noise for component output and RGB out.

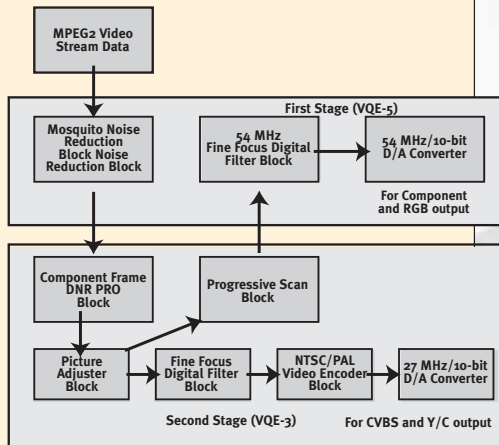

BLOCK NOISE REDUCTION:

Block noise is a visible annoyance caused by image compression. It is noticeable as discontinuities of intensity between adjacent blocks, especially in low detail areas of the image. New Block Noise Reduction makes the noise invisible.

MOSQUITO NOISE REDUCTION:

Mosquito noise is a distortion characterised by moving artefacts around edges – spatial distortion concentrated near the edge of objects. They are visible as the fluctuations of luminance and chrominance levels especially in smooth textured regions. Mosquito Noise Reduction cuts the noise out to present you a consistently smooth image.

COMPONENT FRAME DNR PRO:

With advanced Component Frame DNR PRO, optimum parameters are individually set for the video signals – Y (luminance) and Pb/Pr (chrominance) – to detect noise with higher precision. The DV-939A and DV-737(-K) deliver pictures that are closer than ever to the original film.

FINE FOCUS DIGITAL FILTER:

The newly-developed digital filter allows noise reduction without compromising high resolution. Video signals recorded in the 4:2:2 format are upsampled in the 4:4:4 format with high precision. As a result, digital video signals read from a disc are accurately reproduced down to the minutest detail for a cleaner, smoother image.



DV-646A

DVD VIDEO DIGITAL DOLBY DIGITAL DTS DIGITAL AUDIO COMPATIBLE RW Hi-bit TruSurround SRS PAL/NTSC SR

NEW

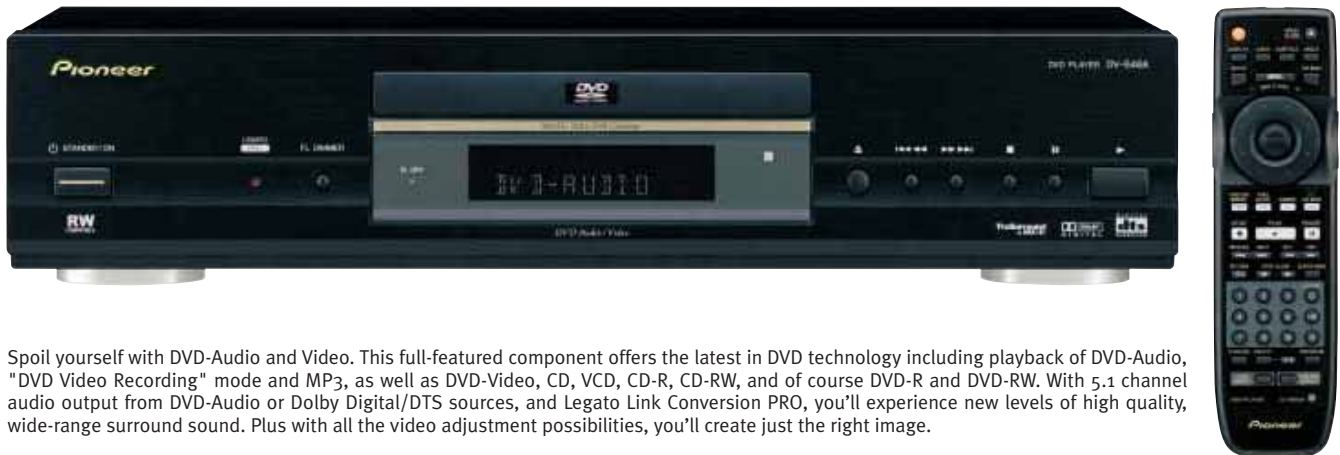

Spoil yourself with DVD-Audio and Video. This full-featured component offers the latest in DVD technology including playback of DVD-Audio, "DVD Video Recording" mode and MP3, as well as DVD-Video, CD, VCD, CD-R, CD-RW, and of course DVD-R and DVD-RW. With 5.1 channel audio output from DVD-Audio or Dolby Digital/DTS sources, and Legato Link Conversion PRO, you'll experience new levels of high quality, wide-range surround sound. Plus with all the video adjustment possibilities, you'll create just the right image.

DV-545

DVD VIDEO DIGITAL DOLBY DIGITAL DTS DIGITAL AUDIO COMPATIBLE RW Hi-bit TruSurround SRS PAL/NTSC SR

NEW



Super-slim, thanks to the redesigned drive mechanism, it is certain to make a statement and a space-saving one at that. With full playback of "DVD Video Recording" discs and MP3 files, this smooth DVD-Video unit is equipped for the future. And more high-tech goodies include 2 Scart terminals for RGB-through, to display RGB signals from your DVD and another component like a set-top box. Thanks to the new Legato Link Conversion PRO, you soak up high quality, wide-range sound with the possibility to select 5 different sound settings.

FULL PLAYBACK COMPATIBILITY (DV-646A)

Expand your entertainment boundaries with the DV-646A DVD-Audio/Video player! Full playback compatibility means you can play the full range of digital discs: DVD-Audio, DVD-Video, DVD-RW, DVD-R, CD, VCD, CD-R and CD-RW. You'll be in awe of material recorded on DVD-RW discs – this model can play discs recorded in "DVD Video Recording" and "Video" mode. Then enjoy the crystal-clear sounds of DVD-Audio. You can even play MP3 files that have been recorded on CD-R and CD-RW discs. All these options, plus amazing sound and supreme image quality, are yours through this player's full playback compatibility.

"DVD VIDEO RECORDING" PLAYBACK COMPATIBILITY (DV-646A/DV-545)

The recording format of the future is coming soon. All new Pioneer DVD players can play back DVD-R and DVD-RW discs recorded in "Video" mode. But these players can also handle discs recorded in "DVD Video Recording" mode, which combines many high quality, easy-to-use recording and editing functions to make recording, editing and disc navigation a breeze.

RW COMPATIBLE

Note: DVD players which have this mark can play discs recorded in "DVD Video Recording" mode, and of course DVD-R and DVD-RW discs recorded in "Video" mode.

DVD VIDEO

For full product features and specifications, please see pages 62 to 63.

DV-444-S/DV-444-K

DVD VIDEO DIGITAL DOLBY DIGITAL DTS TruSurround SRS PAL/NTSC SR

NEW

"I need this" is all you can think! So sleek and stylish it will work anywhere – thanks to the new drive mechanism placement. DVD-Video home cinema has never been so tantalising! You'll get a kick out of playing your MP3 files, and then be amazed how easy it is to arrange and find all those files, with many playback functions and an on-screen display for easy file navigation. It's loaded with the latest technology like SRS TruSurround, which creates a virtual sound field to give the impression of surround sound. Plus, it's a perfect match for the slim VSX-C300/VSX-C300-S A/V receiver.

DV-444-S shown here. Also available as DV-444-K with black finish.



DV-343

DVD VIDEO DIGITAL DOLBY DIGITAL DTS PAL/NTSC SR

NEW

Thinking about DVD-Video? Then consider the sleek DV-343 with superb high quality images and purely perfect sound – thanks to separated audio and video signal processing. And this practical unit plays CD-R* and CD-RW* discs too. An improved dot-matrix-type display matches the displays of A/V receivers, like the VSX-D510.

*Note: Please see page 58 for more information regarding CD-R and CD-RW disc playback.



DV-340

DVD VIDEO DIGITAL DOLBY DIGITAL DTS PAL/NTSC SR

NEW

Not only will the special colour finish of the DV-340 DVD-Video player blend in nicely with the latest generation of design TV sets, the sharp looking new display will certainly get noticed. You'll be amazed at the incredible images and sound. And there's no fuss about complicated settings with the easy Set-up Navigator.



SLIM AND STREAMLINED STRUCTURE (DV-545/DV-444-K/DV-444-S)

Pioneer's new slim DVD-Video players have a redesigned internal construction and slim loading mechanism, which results in an extremely thin component (only 5.5 cm high) – still delivering fantastic DVD quality entertainment! Designed with you and your living room in mind, they don't take up much room, which leaves you with a more streamlined interior and more space for any additional components you might want to add to the TV cabinet.

DIGITAL OUTPUT SOCKETS (FOR DVD/CD)

All Pioneer DVD players have both optical* and coaxial digital output terminals that can stream Dolby Digital, MPEG audio, DTS and linear PCM data to allow for full system integration with all manner of audio and A/V components.

*Note: The DV-343 and DV-340 only feature a coaxial digital output terminal. The PDV-LC20 and PDV-20 only feature an optical output terminal.



For full product features and specifications, please see pages 62 to 63.

PORTABLE DVD-VIDEO PLAYERS

Aeroplane. Party. Train. Road trip. Pioneer portable DVD truly goes everywhere with hyper-thin dimensions. The DVD part takes care of super sharp images and superb sound. Functionality covers features like improved interface and key placement that redefines easy-to-use. This smart design is enhanced by its sexy looks. Certainly modern, unquestionable trendy, it's got "get one" printed all over it. A long-haul lithium battery means that Pioneer portable DVD really goes the distance for work...or play.

PDV-20

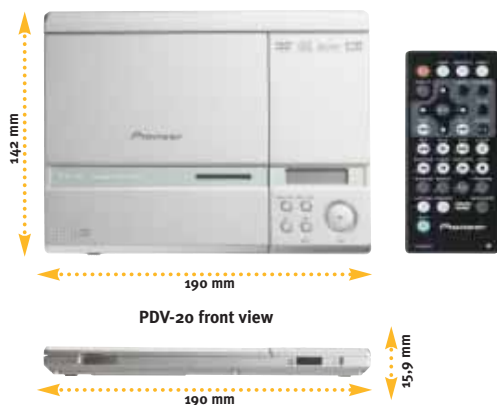

PDV-20 front view

PDV-LC20



PDV-LC20 side view with battery

Count on technology like DTS and Dolby Digital to make this stylish, space-saving DVD-Video unit really sing. Extremely thin (15,9 mm) and light (300 g), it guarantees years packed with home cinema entertainment. Simply plug it into any TV and A/V amplifier or receiver for pure DVD pleasure.

Portable DVD takes on a whole new meaning – with sleek 870 g and 35,4 mm measurements (player + battery) – thanks to the new ultra-thin lithium battery and streamlined player design. With a 7.0-inch wide LCD display, built-in speaker and 3 hours playback time, the PDV-LC20 offers fantastic DVD-Video on the road or at home...anywhere you might be.

PLUG AND PLAY

With its easy connection, just plug your Pioneer portable DVD-Video player into a TV or AV monitor in any room to watch your favourite films. Why put up with a big, bulky home entertainment system, when you can have something more your style in a sleek, compact and subtle package? This system offers you second-to-none picture quality and sound including S-video output and state-of-the-art digital audio transfer.



THE SLIM CHOICE

Pioneer DVD portables are certainly the slim choice with their new feather-light design. Both the PDV-20 and PDV-LC20 are super streamlined; and to top it off, there's a new 8.5 mm thin and 260 g light lithium battery. These are the thinnest and lightest players (and battery) around! Slip it into your bag and take your Pioneer DVD wherever you go. It's made to fit your lifestyle.



FORM MEETS FUNCTION

Pioneer DVD portables redefine the idea of style. A perfect match with any ensemble, their sleek profile and elegant silhouette will definitely get you noticed. And more than a pretty face, Pioneer portable DVD-Video players are extremely easy to use with a simple graphical user interface (GUI) as well as separate operating keys.

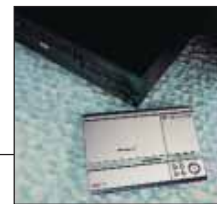

IN-CAR DVD!

Pioneer has a wide selection of DVD entertainment components including single DVD players and a multi-DVD changer. Try a full in-car A/V system that includes a multi-DVD player for movies in your car, plus easy-to-mount wide screens and complete 5.1 channel surround sound. Now you can have your own in-car drive-in movie theatre.

Wide screen in-dash colour display with built-in DVD player AVX-P7300DVD and headrest-mounted wide screen LCD colour displays AVD-W6000

For more information about Pioneer in-car DVD entertainment, please check out "www.pioneer-eur.com" or ask your local Pioneer car audio dealer.



For full product features and specifications, please see pages 62 to 63.



Digital home cinema sound at your fingertips



THX SURROUND EX

THX Surround EX is a joint development of Dolby Laboratories and the THX division of Lucasfilm Ltd. This phenomenal new technology was first heard in George Lucas' long awaited "Star Wars: Episode I-The Phantom Menace". In the movie theatre, film soundtracks reproduced with THX Surround EX technology are able to reproduce an extra "Surround Back" channel, which has been added during the mixing of the programme. Now applied to home cinema, the THX Surround EX process decodes the surround back channel from the left and right surround channels on specially encoded DVD movie releases. There are a total of 7 channels – front left and right, surround left and right, centre, surround back, plus subwoofer. This additional surround back channel allows more detailed imaging behind the listener – sound appears to zoom over your head – and brings more depth, spacious ambience and sound localisation than ever before.

By connecting an external amplifier (M-10X or A-509R) and surround back speakers with the VSA-Eo8, VSX-909RDS(-G) or VSX-859RDS(-G) – featuring two-channel surround back pre-out terminals – THX Surround EX sources can be faithfully reproduced in the home with magnificent three dimensional sound movement.

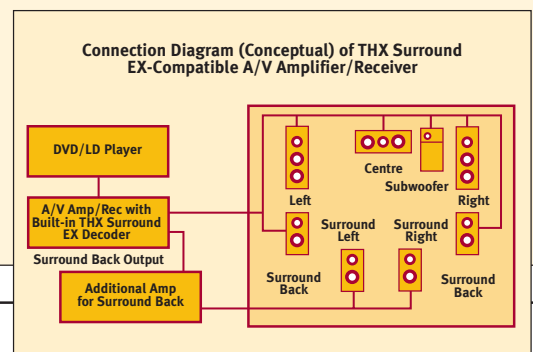
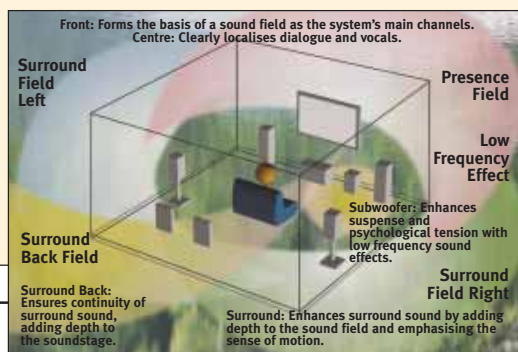

VSX-909RDS-G/VSX-909RDS



110 W x 5 DIN

This top-of-the-line, feature-packed A/V receiver has everything, and we mean everything you'd expect: THX Ultra certification, THX Surround EX and DTS-ES compatible, plus an RDS tuner. On top of this, thanks to top-of-the-line THX Ultra certification, this quality system produces 110 watts of quality cinema surround sound with 7.1 channels in/pre-out – perfect even in larger rooms. Pioneer's Direct Energy MOSFET assures the amplifier runs cool and clean, while assuring higher power and rich bass, for improved overall sound.



VSX-909RDS-G Front Panel Open

VSX-909RDS-G shown here. Also available as VSX-909RDS with black finish.



THX ULTRA

A THX theatre is recognised as the highest class of movie theatre. THX Ultra is an acoustic program to reproduce its high quality sound in your home. Comparing the average home cinema room with a movie theatre, there are different capacity levels and environmental problems. For example, there are differences in phonetic characteristics, represented in sound reflection and reverberation. THX Ultra solves these kinds of problems, and offers the ideal sound field. Lucasfilm Ltd. has established certain standards that components have to meet to become THX certified – e.g. passing a rigorous series of quality and performance tests, including frequency response, distortion, power output and stability. This certification is bestowed upon Pioneer's VSA-Eo8 and VSX-909RDS(-G) models. These THX Ultra A/V amplifier/receivers achieve a higher level of amplifier performance in areas like sound field reproduction and speaker drivability. THX Ultra essentially mirrors the performance and quality created in the original sound mix.



DTS-ES (MATRIX 6.1)

Thrilling theatrical sound that makes you feel like you're in the movies, not just watching them, is only one benefit of DTS-ES – the latest cinema surround sound format. Using low data compression and a high data transfer rate, DTS-ES adds an additional sound channel, allowing filmmakers to be even more creative with sound. The extra rear channel, called "Surround Back", is placed behind you and puts you right in the middle of the action and offers better special effects. A word of warning: when you watch a scary movie with DTS-ES, don't be afraid of the footsteps you hear coming up from behind. They're just part of the package.

7.1 CHANNEL SURROUND ADD-ON AMPLIFIERS

M-10X

For **THX**

120 W x 2 DIN



A-509R

For **THX**

90 W x 2 DIN



You're probably thinking THX Surround EX, right? This is why we've designed this golden amplifier specifically to enhance the additional Surround Back channel, in the THX Surround EX system. And the gold finish perfectly matches the other components – VSA-Eo8, VSX-909RDS-G and VSX-859RDS-G. Just the extra touch you'd expect.

If you are looking for a black model to do the same job of amplifying the extra channel which creates the THX Surround EX sound, you might want to consider the A-509R. This model can be used with the VSX-909RDS and VSX-859RDS.

VSX-859RDS/VSX-859RDS-G



100 W x 5 DIN

This A/V receiver is ready for what the future brings. Completely versatile, this unit can handle the latest and future digital sources – up to 7.1 channels in/out. Plus, there's THX Surround EX and its DTS-ES compatible. Its THX Select certification makes it the perfect choice for your digital home cinema centre, today and tomorrow.

Pioneer's Direct Energy MOSFET assures the amplifier runs cool and clean, while assuring higher power and rich bass, for improved overall sound.



VSX-859RDS Front Panel Open

VSX-859RDS shown here. Also available as VSX-859RDS-G with gold finish.



VSX-839RDS



100 W x 5 DIN

THX Select certified, this A/V receiver is a top quality "5.1" surround system. Universal DVD player ready, it has a 5.1 channel input for stereophonic surround sound. And it can decode Dolby Digital and DTS encoded digital audio data streams for a great digital home cinema experience.



VSX-839RDS Front Panel Open



THX SELECT

The VSX-859RDS(-G) and VSX-839RDS THX Select certified A/V receivers deliver the same quality and experience as THX Ultra. These THX Select receivers, however, have power requirements which are better suited to smaller living rooms – up to 2,000 cubic feet (56.6 cubic meter), compared to 3,000+ cubic feet (85+ cubic meter) for THX Ultra. They accurately reflect the demands of modern programme material, based on examining the requirements of multi-channel digital audio.

FRONT OPTICAL DIGITAL AUDIO INPUT (VSX-859RDS(-G))

The optical digital audio input terminal featured on the VSX-859RDS(-G) front panel enables easy connection of a portable DVD, MiniDisc or CD player, for the utmost convenience. This terminal accepts all mainstream digital formats, e.g. Dolby Digital, DTS, PCM and MPEG. So you can enjoy the total digital home cinema experience, even with a portable DVD player.

Front Optical Digital Audio Input VSX-859RDS(-G)



ASSIGNABLE COMPONENT VIDEO INPUTS (VSX-859RDS(-G))

The VSX-859RDS(-G) has two component video inputs: for example, in the initial setting you can choose DVD/LD for Input 1 and TV/SAT for Input 2. You can also assign other functions, choosing from all video inputs (except for front video input), if you want to connect other sources, like a second DVD player. Yet another convenient feature from Pioneer!

FUNCTION RENAME (VSX-859RDS(-G)/VSX-839RDS)

For more convenience, you can change the name of each function (except TAPE2), e.g. DVD/LD, CD-R, to a name you choose, of up to 10 characters. It's so simple, just enter the characters by using the remote control or multi-jog dial and view your entry on the on-screen display* or FL display.

*Not available with VSX-839RDS

For full product features and specifications, please see pages 64 to 66.

VSX-D810S



100 W x 6 DIN

NEW

Future bound, the VSX-D810S can take on all surround formats with its 7.1 channel input – including DTS-ES compatibility to deliver the utmost home cinema experience. A unique new feature in this model is the 6 channel equal power amp, to ensure stunningly accurate sound for all channels and surround formats. With the new 6D Theater Mode, the VSX-D810S gives a wider, more spacious surround effect for newly introduced 6.1 surround formats and also for current formats such as Dolby Digital and Dolby Pro Logic. The 7.1 channel input ensures compatibility with all current and future surround formats. A wide range of inputs and outputs makes this a superb choice for those interested in an overwhelming home cinema experience.



VSX-D810S Front Panel Open



VSX-D710S



100 W x 5 DIN

NEW

Redefine your system with this top quality A/V receiver. Digital audio in and out terminals assure maximum system expandability with exceptional sound quality. Connection is made easy thanks to the large screw-type speaker terminals. The combined effect of features, including 5 channel equal power for accurate amplification of 5.1 channel sources, creates a captivating sound experience. An added element of style, the front panel door subtly covers inputs and buttons.



VSX-D710S Front Panel Open



VSX-D510-S/VSX-D510



80 W x 5 DIN

NEW

Be prepared for the digital future with this new A/V receiver. It features a built-in Dolby Digital/DTS decoder, 3 digital inputs and 1 digital output, plus a 5.1 channel input for fantastic surround sound from externally decoded 5.1 channel sources. You'll find it a perfect companion for any DVD-Video player, especially with its quality design, improved looks and highly visible semi dot-matrix FL display.

Available as VSX-D510-S with silver finish (shown below). Also available as VSX-D510 with black finish (shown above).



VSX-C300-S/VSX-C300



30 W x 5 DIN

NEW

This ultra-slim A/V receiver is the perfect manager with multiple front connection terminals. It's got the flexibility to hook up a variety of units. A solid performer with 30 watt x 5 continuous output, it is easy to select one of the pre-defined surround modes or listening modes to suit the moment. Add easy installation features like auto speaker configuration and one-touch room set-up and home cinema has never been so appealing!

VSX-C300-S shown here. Also available as VSX-C300 with black finish.



VSX-409RDS



80 W x 5 DIN

Looking for Dolby Pro Logic surround at an affordable price? Then this A/V receiver with its 5.1 channel input is designed for you. And it's a perfect partner for a DVD player which has built-in Dolby Digital and DTS decoders.



6 x 100 W CONTINUOUS POWER OUTPUT (VSX-D810S)

If you crave astonishingly realistic surround sound, Pioneer has got what you're looking for. The VSX-D810S A/V Receiver offers a 6 channel equal power amplifier, a unique feature in Pioneer's lineup. You get equal power for all 6 channels, to properly reproduce 6.1 channels of audio and to ensure stunningly accurate sound for all channels and formats. A clear step up from 5.1 channel surround sound, it features an additional channel for surround back speakers. So you can enjoy the latest 6.1 formats, like DTS-ES Matrix 6.1, in full splendour.



SPACE-CONSCIOUS DESIGN AND VERSATILE CONNECTIVITY (VSX-C300/VSX-C300-S)

The new VSX-C300/VSX-C300-S A/V receiver features a super-sleek 6.5 cm (height) design that complements the slim DV-444-K/DV-444-S and DV-545 DVD-Video players, allowing for a component-type home cinema system that doesn't take up a lot of space. However elegant and streamlined it looks, this receiver is fully-featured and extremely flexible! A front optical digital audio input allows you to easily plug in games or a portable DVD player at a moment's notice. The VSX-C300/VSX-C300-S and a slim DVD player can be used in a variety of A/V settings, giving you a total home entertainment experience made to measure.

USER-FRIENDLY SURROUND AND LISTENING MODES (VSX-C300/VSX-C300-S)

The new super-slim VSX-C300/VSX-C300-S A/V receiver features a wide range of pre-defined easy-to-use surround and listening modes that work with a variety of A/V sources. At the touch of a button, **TV Surround Mode** creates the effect of 5.1 channel surround sound, even for monophonic sources, such as news broadcasts, sports coverage, classic films... **Game Mode** puts players in the centre of action games where, thanks to powerful bass and a close-set soundstage, they can feel explosions and other sounds with stunning reality. For users with only 2 front speakers, Pioneer offers **Virtual Surround Mode** for channel separation that leads to a surround sound feeling. Or, if you want the effect of surround sound but must wear headphones to keep sound levels down, use the new **Phones Surround Mode**. It feels like the soundstage is outside – rather than inside – your head. The **Pre-set Tone Mode** lets the family control tone with ease. You can easily switch between the two tone curve pre-sets. If you feel the sound is too harsh or too sharp, **Quiet Mode** reduces the bass and treble in the signal to smooth the sound. Finally, if you want the full strength of bass, the **S Bass Mode** delivers a powerful performance. All these features combine to make the VSX-C300/VSX-C300-S an excellent choice for the full impact of home cinema, without fussing with complicated settings.

For full product features and specifications, please see pages 64 to 66.



Premium surround sound



WRAP-AROUND SOUND

Wrap yourself in the most overwhelming surround sound reproduction and be amazed how sound can colour your home cinema experience. So pure and realistic, it makes you feel like part of the action. Dolby Digital and DTS – they paint your walls and ceilings with sound.

A/V SPEAKERS

Your home cinema experience deserves the sensational sound effects of Pioneer A/V speakers. The perfect companion to superb components, all front, centre and rear speakers, and powerful subwoofers, are designed to deliver the best possible sound. Continuously expanding their wide selection of colours and designs, Pioneer offers the look and feel that you are searching for in your living room. From the booming bass of action special effects, musical scores than put you in the centre of a symphony, to crisp cinematic dialogue, you won't believe your ears.

The entire line of Pioneer speakers presented here in packages is also available separately. So feel free to choose a fabulous set for your brand new digital home cinema experience or just add rear and centre speakers to your existing front speakers to create dynamic surround sound.

S-V70

NEW

Thinking about a futuristic home cinema system? Then this hyper-modern speaker set is a superior choice – and a perfect match. This trendy system does double duty in the realm of space-saving and powerful cinema sound, with five 130 watt satellite speakers and a 110 watt light wood-tone active subwoofer. The S-V70 consists of S-ST70-F (front satellite speakers), S-ST70-CR (centre and rear satellite speakers) and the S-W80S-QL (powered subwoofer), and comes with 3 coloured grilles (black, white and burgundy) for central and satellite speakers.

130 W (SATELLITE) DIN
110 W (SUBWOOFER) DIN



S-V50-K/S-V50-QL

NEW

Make a splash with this speaker set: five 100 watt metallic-look satellite speakers and an option between a light wood-tone or black 110 watt active subwoofer. This home cinema speaker set is the perfect complement to any modern interior. The S-V50-K is ideally suited for Pioneer's new Slimline systems (see page 10). The S-V50-K consists of S-F50 (front satellite speakers), S-CR50 (centre and rear satellite speakers) and the S-W80S-K (black* powered subwoofer).

100 W (SATELLITE) DIN
110 W (SUBWOOFER) DIN

*Also available as S-V50-QL with the S-W80S-QL (light wood-tone powered subwoofer).



For full product features and specifications, please see page 67.

S-V59-K

NEW

An excellent choice for any room, these five stylishly compact satellite speakers are the ideal match for the new high performance subwoofer with built-in amplifier. The S-V59-K combines the S-F59 (front satellite speakers) and S-CR59 (centre and rear satellite speakers) with the new S-W80S-K (powered subwoofer).



S-V39

Compact size for subtle and easy placement and superb sound – all at an affordable price. This complete A/V speaker system brings intense surround sound to anyone considering the digital home cinema experience. The S-V39 consists of S-F39 (front satellite speakers), S-CR39 (centre and rear satellite speakers) and S-W39 (subwoofer).



S-V31

NEW



Shelf or wall-mounted? Either way, this light wood-tone system offers spectacular home cinema sound, cloaked in a contemporary finish. And you can count on the 110 watt active subwoofer for dynamic bass reproduction – as well as streamlined looks. The S-V31 combines S-F31 (front satellite speakers), S-CR31 (centre and rear satellite speakers) and S-W80S-QL (powered subwoofer).

S-V31-W

NEW



Another colour option, this set features satellite speakers with a warm wood-tone finish and a sleek-designed black 110 watt active subwoofer to reproduce the full range of home cinema sounds. The S-V31-W combines S-F31-W (front satellite speakers), S-CR31-W (centre and rear satellite speakers) and S-W80S-K (powered subwoofer).

S-V510

100 W DIN

NEW



Sit back and relax as the sound swirls around you from three powerful cone woofers in these stylish new floor-standing front speakers. And cinematic surround sound sweeps in from the centre and rear satellite speakers. The complete S-V510 speaker system consists of S-H510V (floor-standing front speakers) combined with the S-CR59 (centre and rear satellite speakers).

S-V310

100 W (FRONT) DIN
80 W (REAR, CENTRE) DIN

NEW



Immerse yourself in the amazing sounds of home cinema with these redesigned front speakers set on a stylish yet sturdy base. Rear and centre satellite speakers complete the system – all in black to match your components. The S-V310 combines S-H310V (floor-standing front speakers) and S-CR39 (centre and rear satellite speakers).

S-V310-W

100 W (FRONT) DIN
80 W (REAR, CENTRE) DIN

NEW



Add a touch of class to your high-tech home cinema set-up with this warm wood-toned speaker system. A sturdy base has been added to the front speakers for an extra element of style and stability. The set is rounded off by modern rear and centre satellite speakers. The complete S-V310-W package consists of S-H310V-W (floor-standing front speakers) and S-CR31-W (centre and rear satellite speakers).

For full product features and specifications, please see page 67.

S-V220

80 W DIN

NEW

Looking for something a little lighter and brighter? The subtle light wood-tone finish on these 3-way front speakers blend into modern spaces. And the compact rear and centre satellite units easily slide on a shelf or wall. The S-V220 combines S-H220V (floor-standing front speakers) and S-CR31 (centre and rear satellite speakers) for a high performance design set.



S-V220-W

80 W DIN

NEW

If traditional warm wood is more your style, opt for the S-V220-W. With a warm wood-tone finish, these redesigned 3-way speakers deliver quality sound to all corners of the room. The S-V220-W, consisting of S-H220V-W (floor-standing front speakers) and S-CR31-W (centre and rear satellite speakers), produces outstanding audio for any home entertainment system.



S-W80S-QL

110 W DIN

NEW



S-W80S-K

110 W DIN

NEW



A mastermind of an active subwoofer in a very pretty package. Delivering 110 watts, this unit really packs the power for your home cinema surround sound experience. Part of several Pioneer speaker packages, this light wood-toned subwoofer is also available separately for those of you thinking about upgrading.

Or maybe you'd rather have black? No problem. Redesigned with you in mind, this 110 watt active subwoofer is super seductive in black. Not to mention what it does for your home cinema experience. Available separately or in several Pioneer speaker packages.

CP-F50

NEW

SPEAKER STAND

This stylish speaker stand will elevate your speakers to new heights of design. They can be used with most new and older Pioneer satellite speakers – at least those which feature a vertical fixing structure at the rear of the cabinet (a hole, bosc nut or wall bracket) – including S-V70, S-V50-K/S-V50-QL, S-V59-K, S-V39, S-V31/S-V31-W, and the satellite speakers of the NS-DV88, NS-DV77 and DCS-100.



CP-HC10

SPEAKER STAND

Pioneer design goes beyond just the speakers. Perfect for the satellite speakers of any of the following speaker systems – S-V59-K and S-V39.

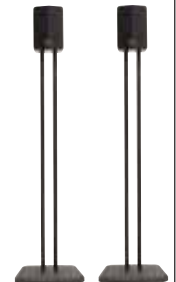

For full product features and specifications, please see page 67.

A little luxury goes a long way



PDP-503HDE

COMING SOON

TV FEATURES

- Teletext
- Nicam stereo
- Child Lock
- Dual Screen display (the screen can be split in two 27-inch to enjoy 2 inputs at the same time)
- AV selection (Programmed picture quality mode selection)
- Five pre-set screen modes (4:3, Full, Zoom, Cinema 14:9, Wide)
- Colour temperature adjustment
- PureCinema (NTSC only)
- FOCUS* and SRS* create a completely immersive sound image
- Built-in amplifier for optional speakers
- 100 Hz flicker-free, progressive scanning

PLASMA FEATURES

- Large 50-inch screen
- Wide screen 16:9 aspect ratio
- 160-degree viewing angle – no one misses the action
- Ultra-slim – ideal to hang on the wall – less than 10 cm deep
- Outstanding brightness (900 cd/m²) and stunning picture quality
- Dramatically improved contrast: 900:1
- Noise-free: there is no fan, so nothing disturbs the silence of film scenes

CONVENIENCES

- Easy to set up: 1 cable connection between display and receiver
- Auto installation (Auto channel pre-set, etc.)
- Smart OSD (On-Screen Display)
- PC Input up to XGA
- Energy save mode and Auto power off
- i/oLink.A system for easy and advanced operation of external video recording equipment

*FOCUS and SRS are trademarks of SRS Labs, Inc.



More than the world's largest plasma TV, the sleek Pioneer PDP-503HDE is a lifestyle statement. It says you go for the absolute finest technology. Mega-bright, ultra-crisp pictures. Whatever digital toy takes your fancy. And pleasure so enormous you can't measure it – a long way into tomorrow.

9.8 cm



SHAPED TO PLEASE YOUR ROOM

Although very large – 50-inches (127 cm) diagonal – the PDP-503HDE plasma display is surprisingly light (38.9 kg) and super-slim (9.8 cm). Hang it on a wall or ceiling – it fits seamlessly anywhere, without taking up floor space. With over a 160-degree viewing angle, both vertically and horizontally, the PDP-503HDE guarantees picture-perfect images from any seat in the room, even off to the side.

SHAPED FOR TODAY – AND TOMORROW

The PDP-503HDE plasma TV brings new – and up-coming – multimedia systems to life. For high-definition broadcasts, plasma is equipped with a 980,000 pixel (1280 x 768 dots) high-resolution panel. It also accepts a full range of standard computer signals from VGA (640 x 480 dots) to Wide XGA (1280 x 768 dots). For the best of movies, games, surfing the web, and more, Pioneer plasma is all you need.

THE CLEAREST, BRIGHTEST SHAPES

Premium technology is the key to superior images: sharp, vibrant and distortion-free. The PDP-503HDE incorporates such cutting-edge advances as 100 Hz progressive scan, a waffle shaped rib structure and pure colour filter in its display panel. You'll recognise the difference immediately. Thanks to its crystal clear brightness, your ordinary living room can easily be turned into a movie theatre, even in the daytime.

SHAPELY, FRIENDLY AND ALL-ENCOMPASSING

Because we perceive the world with greater width than height, Pioneer plasma TV features a 16:9 wide aspect ratio for the display. Easy to see and to use, the PDP-503HDE further enhances your enjoyment with functions like Teletext, Dual screen and SCART terminals for easy connectivity.

HOW TO ENJOY PLASMA

The world-class Pioneer plasma outstands as one of the new lifestyle design approaches shaping the convergence of digital and information technologies.



PLASMA & HOME CINEMA

For a truly superb digital home cinema experience, integrate the PDP-503HDE in your DVD home cinema set-up. The 50-inch wide flat screen provides super-fine picture details in movie-theatre screen proportions taking an absolute minimum of space. Combined with multi-channel surround sound, Pioneer plasma TV offers you the ultimate cinematic experience.



PLASMA & DIGITAL BROADCASTING

Pioneer's PDP-503HDE is definitely the most suitable display to watch large images and text information provided through digital terrestrial, satellite or cable broadcasts. Since these popular interfaces are the long-term future of home-based communications, including the Internet, Pioneer plasma is virtually future-proof. And because the PDP-503HDE is the first consumer plasma TV with real XGA resolution, you're ready right now for High Definition television.



PLASMA & GAMES CONSOLES

Connect the PDP-503HDE to a games console and experience a new sensation in games play – high-definition high-quality moving images. Just one way Pioneer makes your favourite action games more exciting than ever.



PLASMA & INTERNET

Set up a true media room. Now, you can view the growing number of large, moving images on the Internet. Even video programmes are about to be broadcasted through the Internet. You'll truly appreciate the versatility and high-resolution of the PDP-503HDE. High-speed net surfing in "the Broadband era" is coming now with CATV, ADSL* and optical fibre cable.



PLASMA & VIDEO CAMERAS/DIGITAL CAMERAS

Hook up to a digital video camera and re-live cherished happenings or footage just shot. Or connect to a digital still camera and thrill to favourite shots. Both ways, you'll be dazzled by the nearly life-size images and brilliant colours, including whiter whites and blacker blacks.

*ADSL: Asymmetric Digital Subscriber Line

For full product features and specifications, please see page 68.

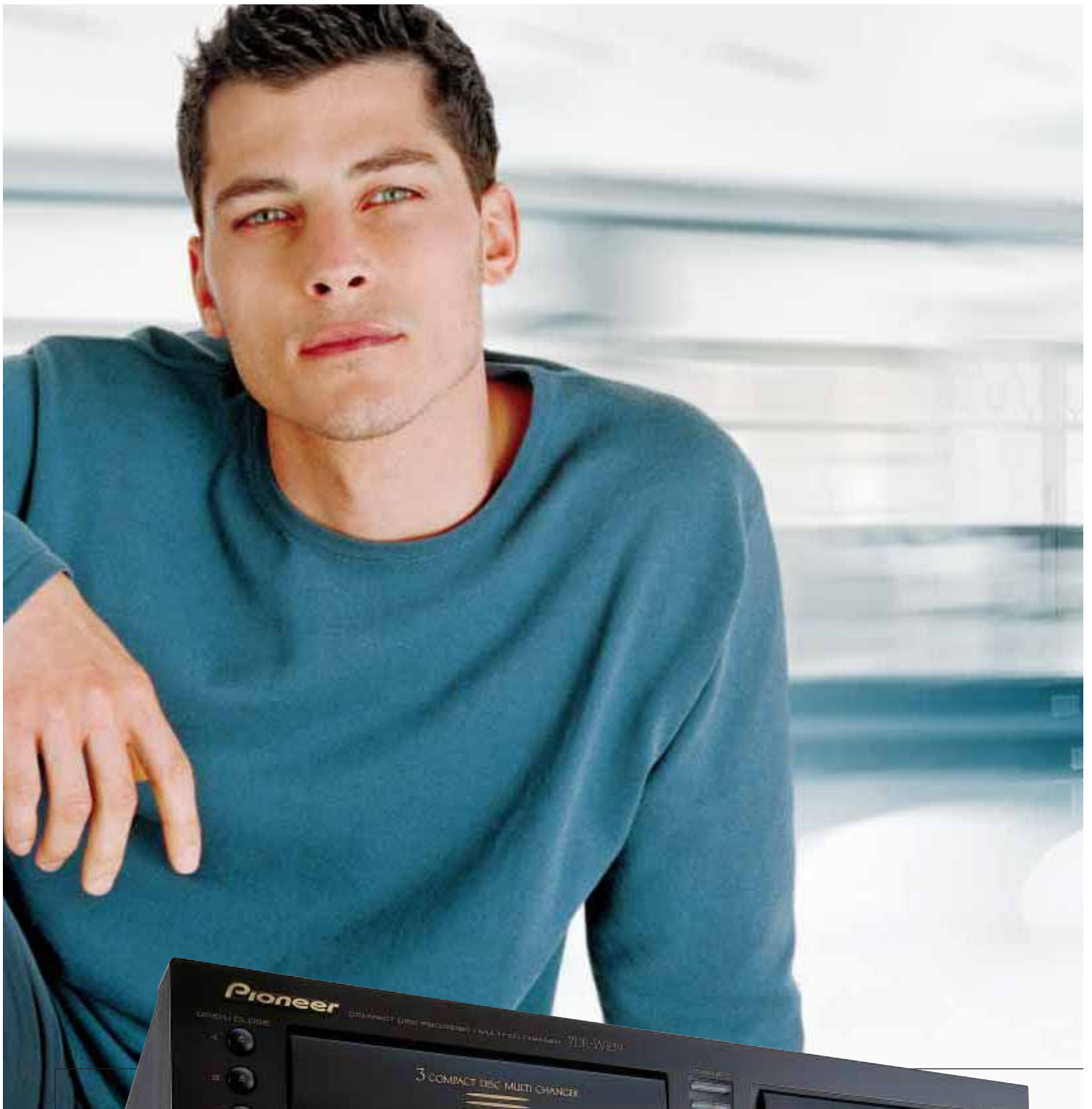



A moment just for you

REC/
REC MUTE



35

Hi-Fi
Components

You are a big fan of the perfect component. Always have been. A couple of years ago, it was a top-of-the-line cassette deck. Then, it was the multi-CD player. Now you're considering a CD recorder. There is something very satisfying about knowing that everything fits exactly the way you want it. Not to mention that you have the latest technology trends covered. Thanks to Pioneer, there's a tremendous selection of exceptional quality components, from CD recorders and MiniDisc recorders to CD players and cassette decks to amplifiers and speakers. Whatever you're aiming for, Pioneer can help you find exactly what you need.

All your personal favourites

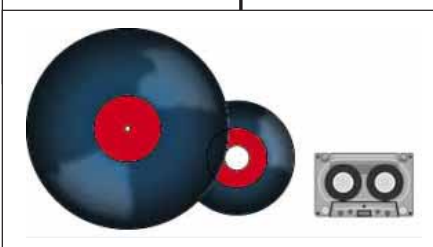
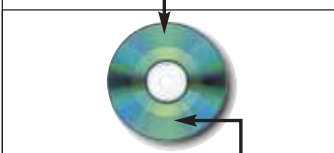

3-To-1 TECHNOLOGY

With a Pioneer CD recorder, you can build a music collection that reflects your own personal style in no time. Select the desired tracks from one to three CDs, press the "Copy Start" button and record your selections onto one CD. It's that easy to digitally record selections from three CDs to one. You'll never have to settle for a mass-produced compilation CD or struggle with complex programming ever again.



1 Insert the pre-recorded music CD or CDs.



2 Place the recordable disc in the CD recorder.



3 Choose the selections you want to record from up to 3 separate CDs. (Up to 60 or 74 minutes of total recording time.) Push 'Record' and get on with your life. When the recording is finished...

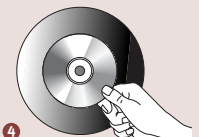

4 ...you have your own customised CD for playback over and over again!

CD RECORDERS

Make a mix for every situation with Pioneer's CD recorder: relaxing, reading, driving, partying, jogging, working...the list goes on. Thanks to the latest digital technology breakthroughs, customising your own CDs has never been easier or more fun! From any source in any order, simply select your favourite tracks, record them onto a CD-R or CD-RW and take them anywhere – in your car, to a party, in a portable player or even the office.

PDR-W839

LEGATO LINK CONVERSION **CD TEXT** **SR**



Record from one to three CDs onto your own personalised CD. Just select the tracks you want to record and press the "Copy Start" button. It is easy! The new "Rec This" button automatically records the track you are listening to at the touch of a button and stops when ready. The improved 2 x finalisation process and double speed dubbing enables fast recording. The front panel input connection for a keyboard makes creating and editing personalised CD Text a breeze.



PDR-609

LEGATO LINK CONVERSION **CD TEXT** **SR**



Quality CD recording and playback at its finest – thanks to a 24-bit A/D converter and Legato Link Conversion. This technology includes double speed finalisation, analogue sync recording for easy vinyl or cassette recording and automatic level adjustment. Of course, there is CD Text display and input possibilities.



For full product features and specifications, please see pages 69 to 70.



Perfectly matched, this CD recorder adds an extra element of art, and recording capabilities, to your sleek NS-F10 CD system. The PDR-F10 records only in combination with the XC-F10.



NS-F10 with PDR-F10



TAKE IT ANYWHERE

Takin' it to the street! ...or any place you want to be. Once you've recorded your compilation discs, take them anywhere you want to go. You can play them at home, on your PC, in the car, in your portable CD or DVD player, or at a party.



NEVER ENDING PARTY

Want to expand your possibilities? Then hook up your CD recorder to a File-Type CD player and select from up to 301 CDs. Build a unique library of compilation CDs. CD recording – you're on your way.



CD TEXT

CD Text is a neat new feature found on the PDR-W839, PDR-609 and PDR-F10. Add CD titles, track titles and artist names to the audio CD. CD Text reads and records the information on the disc itself, making it easy to find the track or artist you want to play later.

RDD-74B

CD-RECORDABLE AUDIO 74 MIN.

Reach the highest performance with a Pioneer CD recorder.



RDW-74

CD-REWRITABLE AUDIO 74 MIN.

Make your own musical mock-up with this 74 min. Rewritable Compact Disc. Compatible with audio recorders carrying the symbol identification.



For Consumer or For Consumer Use: Recording is not possible on a CD-R/CD-RW disc without the above marks, which means it is a disc for professional use.

Compatible with SCMS (Serial Copy Management System): SCMS makes possible digital direct CD-R recording of CD, MD or DAT audio sources. However, such CD-R recordings cannot be used as source material for digital re-recording (in order to restrict digital dubbing).

MINIDISC RECORDERS

Permission to record to your heart's content. For compact convenience, you can't beat the MiniDisc. And it gets even better with Pioneer's pure digital MiniDisc recorders. Record your favourite tracks from your CDs and other sources and play them back on any MiniDisc player or portable. Check out the MJ-L11, a new design MiniDisc recorder that matches the NS-11-Q/NS-11-S, NS-DV77 and NS-DV88.



MJ-D508



Pioneer's advanced parameter processing, which controls ATRAC compressed data increasing the music signal information to provide audio recordings of the highest quality, the Pioneer Z-concept, and digital noise reduction mean a superior quality MiniDisc recorder. The convenient editing modes and features like "name clip" and "medley playback" let you get the most out of your music.



MJ-L11



NEW

A MiniDisc recorder with looks to kill. This is more than tempting for MiniDisc fans. Perfectly co-ordinated with the NS-11-S and NS-11-Q audio systems, and the NS-DV77 and NS-DV88 digital home cinema systems, this compact component is a simple way to add the pleasure of editing and recording those take-anywhere MiniDiscs to your design system. And just to twist your arm, its special MD LP (Long Play) feature gives you four times the recording time!



NS-DV77 with MJ-L11



MD LONG PLAY

How would you feel about 40 - 80 of your favourite songs on one disc? It's possible with Pioneer's new MD Long Play feature. You can record up to 4 times longer: up to 160 minutes

in stereo or 320 minutes of joint stereo. You might worry that, with this many songs on one disc, it could be hard to find exactly the track you're looking for, but Pioneer's got you covered with the Group Management function. It's a filing system for your disc that allows you to arrange tracks into groups and then give each group a name. Use "group search" to play the first song of a group; "group play" to play all the songs in a group.

Note: MD LP discs will only play on MD LP compatible players.



NS-11-Q with MJ-L11

For full product features and specifications, please see page 71.

FILE-TYPE CD PLAYERS

With File-Type CD Players that offer you the possibility of 301 CDs in a compact space, it's clear that Pioneer doesn't believe in limiting your listening pleasure. Enjoy the reproduction of the original sound, more faithful than ever before, thanks to Legato Link Conversion. It's like having a jukebox in your home – except you can't lean on it.

Your CD collection in one spot

PD-F1009

With its unique loading roulette rack system and single loader, easily store 301 CDs in a surprisingly compact unit for immediate playing of your collection. A selection of listening modes, CD Text and CD-RW playback capability, low power consumption and Legato Link Conversion make this component an excellent choice for quality and convenient CD enjoyment.



PD-F1007

More than 301 CDs? No problem. This CD player is connectable to another 301-CD changer for a grand total of 602 CDs. Almost a month of continuous listening pleasure. Organise your collection using the custom filing system and input your text via a keyboard or the remote control.



PD-F958

Store up to 101 CDs in this compact CD player. Its single loader means a track within moments. It is easy to keep your favourite CDs organised using custom filing for up to 3 CD groups and the component can handle CD Text.



For full product features and specifications, please see page 72.

PD-F706

A compact unit, this rolling rack system stores 25+1 discs. Almost a full day of audio enjoyment. Plus you can programme 24 tracks from 24 different discs for the perfect mix.



PD-F607

Just a bit smaller for easy placement, load this CD player with 25 discs and enjoy your favourite music continuously. You'll be surprised at its price tag as well as its features, which include CD Text.



MULTI CD PLAYERS

PD-M603*

This CD player offers six disc capacity with excellent sound performance thanks to Pioneer's 1-bit DLC (Direct Linear Conversion) featuring a high speed and high density pulseflow D/A converter. With automatic digital level control, the sound level is automatically adjusted. Plus the 6 disc key on the remote lets you access any one of the six CDs directly.

* Only available in the U.K.



PD-M426*

Put sets of your favourite CDs in separate loaders and off you go. This multiple Compact Disc player stores 6 discs per loader and features anti-resonance and anti-vibrating design and last disc memory. Just press the remote to start playing your selection.

* This product is not available in the U.K.



PD-M406*

With a six disc storage capacity, this multi Compact Disc player offers superb sound with anti-resonance, anti-vibration design and last disc memory. A system remote terminal is also available.

* This product is not available in the U.K.



JD-M300

6-CD MAGAZINE

Sort your favourite CDs into separate loaders to use with the PD-M426*, PD-M406* and PD-M603 multi Compact Disc players. It couldn't be easier.

* These products are not available in the U.K.



For full product features and specifications, please see page 72.

CD PLAYERS

Sure. The CD has been around for more than 15 years. But just like vinyl, it doesn't mean that we need stop enjoying them. Pioneer is still pushing the limits of CD technology. Thanks to hi-bit conversion and Legato Link Conversion, you'll be enjoying the pure studio sound of your CDs for years to come.

Beyond excellent sound

PD-S707*



This top model features everything a demanding listener requires. Perfect digital audio sound is present thanks to Pioneer's Z-concept and anti-resonance and anti-vibration features. And it is easy to use with a convenient jog dial.

* This product is not available in the U.K.



PD-S507*



This quality CD player has a wealth of features like Legato Link Conversion, and exceptional quality for this price range thanks to the Pioneer Z-concept. This highly accurate transmission system, stable platter mechanism and acoustic damper tray mechanism significantly reduce jitter noise inside and out for the ultimate music enjoyment.

* This product is not available in the U.K.



PD-207



Easy-to-use, this CD player operates at a touch of a button. Its extremely affordable price tag makes it even more attractive.



For full product features and specifications, please see page 73.

INTEGRATED AMPLIFIERS, RECEIVERS & TUNERS

A great amplifier or receiver can make your music and your home entertainment system sound better. Count on Pioneer to produce innovative high performance components with extra features and additional connections for all types of speakers and audio systems. Pioneer design means powerful amplification without distortion and solidly stable sound localisation throughout the range to deliver what you want: pure sound. Got an amplifier? Might want to check out Pioneer's fully-loaded RDS tuner to enjoy the latest radio programmes.



Toroidal transformer

A-607R



120 W x 2 DIN

Packed with power – 120 watts + 120 watts DIN, this integrated amplifier pumps out pure sound with a superb low frequency range and exceptionally low noise thanks to the toroidal transformer. The high quality Direct Energy MOSFET circuit drives low impedance loudspeakers and its wide range linear circuit delivers clean hi-fi sound throughout the frequency range. Its symmetrical design adds to the perfect stereo sound.



A-509R



90 W x 2 DIN

The new look of this 90 watt integrated amplifier brings powerful performance to any system. Its wide-range linear circuit means a wider frequency response and its short signal path translates to a pure natural sound. It can be combined with the black VSX-909RDS or VSX-859RDS to drive the surround sound back speakers for a full 7.1 THX Surround EX* experience.

* When in the Surround Back mode, the A-509R does not accept any remote control signals, including those from the main amplifiers, VSX-909RDS or VSX-859RDS.



A-307R



80 W x 2 DIN

The symmetrical construction of this 80 watt integrated amplifier brings perfect stereo sound to your ears. And the short signal path adds to the reality of the experience.



For full product features and specifications, please see pages 73 to 74.



Pure power perfect tones

A-209R



60 W x 2 DIN

The new design features of this 60 watt integrated amplifier include a stabiliser for the transformer and chassis. Add this to the other features, such as a wide-range linear circuit and short signal path, for excellent sound performance.



A-109



40 W x 2 DIN

The new design of this 40 watt integrated amplifier adds a stabiliser for the transformer and chassis. And its symmetrical design results in excellent stereo imagery.



SX-209RDS



50 W x 2 DIN

Less is more. This RDS quartz-synthesiser receiver does double duty – a convenient tuner with RDS functions and a high quality 50 watt amplifier.



F-208RDS



An RDS-EON tuner with all the works. Store up to 30 AM/FM stations in this sleek unit. RDS provides a wide variety of information services and automatic tuning functions, including automatic traffic and news reports, displaying the station name and text messages, and searching and displaying programme types.



CASSETTE DECKS

Who says cassettes are out of style? We all still have our highly sentimental collections tucked away somewhere. So get them out of the shoebox and take a stroll down memory lane or liven up a party. By translating digital developments like digital noise reduction and digital TDNS (Tape Duplication Noise Suppression) to the analogue format, Pioneer's flexible range of cassette decks pulls every last bit of superior sound performance from your cassettes.

CT-W8o6DR

Applying the latest digital developments to the analogue format results in surprising quality sound. This double cassette deck has everything you need for high performance recording and playback, including a digital processing system for lower signal deterioration, a digital input terminal and easy ALCA (Automatic Level Control - Performed In Digital Domain) and TDNS (Tape Duplication Noise Suppression) digital dubbing.

DIGITAL PROCESSING SYSTEM LEGATO LINK COMPRESSION SUPER AUTO BLE XD FLEX FREQUENCY LEVEL EXPANDER 5RN



CT-W7o6DR*

A great idea. This double cassette deck uses digital technology such as digital noise reduction and digital TDNS (Tape Duplication Noise Suppression) to obtain the best possible results from your cassettes.

* This product is not available in the U.K.

DIGITAL PROCESSING SYSTEM LEGATO LINK COMPRESSION SUPER AUTO BLE XD FLEX FREQUENCY LEVEL EXPANDER 5RN



CT-W6o6DR

A double cassette deck with Pioneer's advanced digital processing system and Legato Link pulls every last bit of sound from your cassettes.

DIGITAL PROCESSING SYSTEM SUPER AUTO BLE XD FLEX FREQUENCY LEVEL EXPANDER 5RN



CT-W5o5R*

The very best of analogue sound reproduction, this double cassette deck uses ALCA (Automatic Level Control - Performed In Digital Domain) for a constant recording level and TDNS (Tape Duplication Noise Suppression) for deleting bias noise.

* This product is not available in the U.K.

FLEX FREQUENCY LEVEL EXPANDER (AUTO BLE) 5RN



CT-W2o8R

This quality double cassette deck is a perfect addition to any system.

5RN



CT-S25o

Of course, you still want to play all those favourite cassettes. So why not add this affordable single cassette player to your system?

FLEX FREQUENCY LEVEL EXPANDER 5RN



For full product features and specifications, please see page 75.

Deciding on a set of speakers is simple thanks to Pioneer's wide selection of fantastic, high performance sets designed for all types of systems up to 7.1 channel surround sound. Whatever your musical preference, the quality of Pioneer speakers lets you experience the full spectrum of sound. Now available in new colours and designs, you can really enjoy your music the way you like it.

Superior sound

S-H510V

100 W DIN

NEW

With a refreshed design, these stately speakers are the perfect accessories. As a set, the elegant, 2-way, 100 watt speakers bring high performance sound to any living space. They are also magnetically shielded to prevent interference so they can double as A/V speakers.



S-H310V-W

100 W DIN

NEW

Finding that you have too much black? Then opt for these stylish, redesigned, 2-way, 100 watt speakers with a base for extra support. This exclusive set in Calvados wood finish spells class.



S-H310V

100 W DIN

NEW

Newly designed, seductive black, 2-way floor speakers with a sturdy base for stability. Can you go wrong? No, especially when you add features like 100 watts of power and a magnetic shield to prevent interference.



S-H220V-W

80 W DIN

NEW

Maybe darker tones suit your taste and your interior? Then, try out these three-way floor-standing speakers in warm wood-tone finish. They're equipped with 80 watts of power for fantastically engineered sound.



S-H220V

80 W DIN

NEW

Perfect for contemporary living spaces, the subtle light wood-tone finish on these three-way floor-standing speakers is certainly a modern statement. And don't forget the power with 80 watts of superior sound.



CS-9070

220 W DIN

Crystal clear sound is what you'll hear from these super powerful 3-way, 220 watt speakers. They are also magnetically shielded so you can forget about interference with other electronics and use them as A/V speakers.

**CS-7070**

190 W DIN

Maximum music at 190 watts. These quality 3-way speakers are also magnetically shielded to prevent interference and can be used as A/V speakers.

**CS-5070**

140 W DIN

Designed for sound, these 3-way 140 watt speakers are an excellent choice for any hi-fi system.

**CS-3070**

120 W DIN

Something slightly smaller? Then you'll want these subtle 120 watt, 3-way speakers for your system.

**ADD-ON EQUIPMENT & ACCESSORIES****PL-990****TURNTABLE**

Sometimes you can't beat a vinyl classic. This high-tech, fully automatic stereo turntable features a low-mass straight tone arm, precise DC servo motor and built-in phono equaliser. Simply connect to any auxilliary/line input on your amplifier or mini system.

**GR-209****GRAPHIC EQUALISER**

Its updated design and LED in the slider tips makes it easy to monitor your sound blend on this 7-band graphic equaliser.

**HEADPHONES**

When you need sound privacy, nothing beats a quality pair of headphones for a total sound experience. Looking for a completely closed model? Then consider the deep resonating sounds of the silver SE-M370 or the comfortable fit of the SE-M270 with oval soft pads. Or if you want to look super-trendy while you're enjoying rich, vibrant sounds, then opt for the light, open-type SE-A250.



For full product features and specifications, please see page 76.

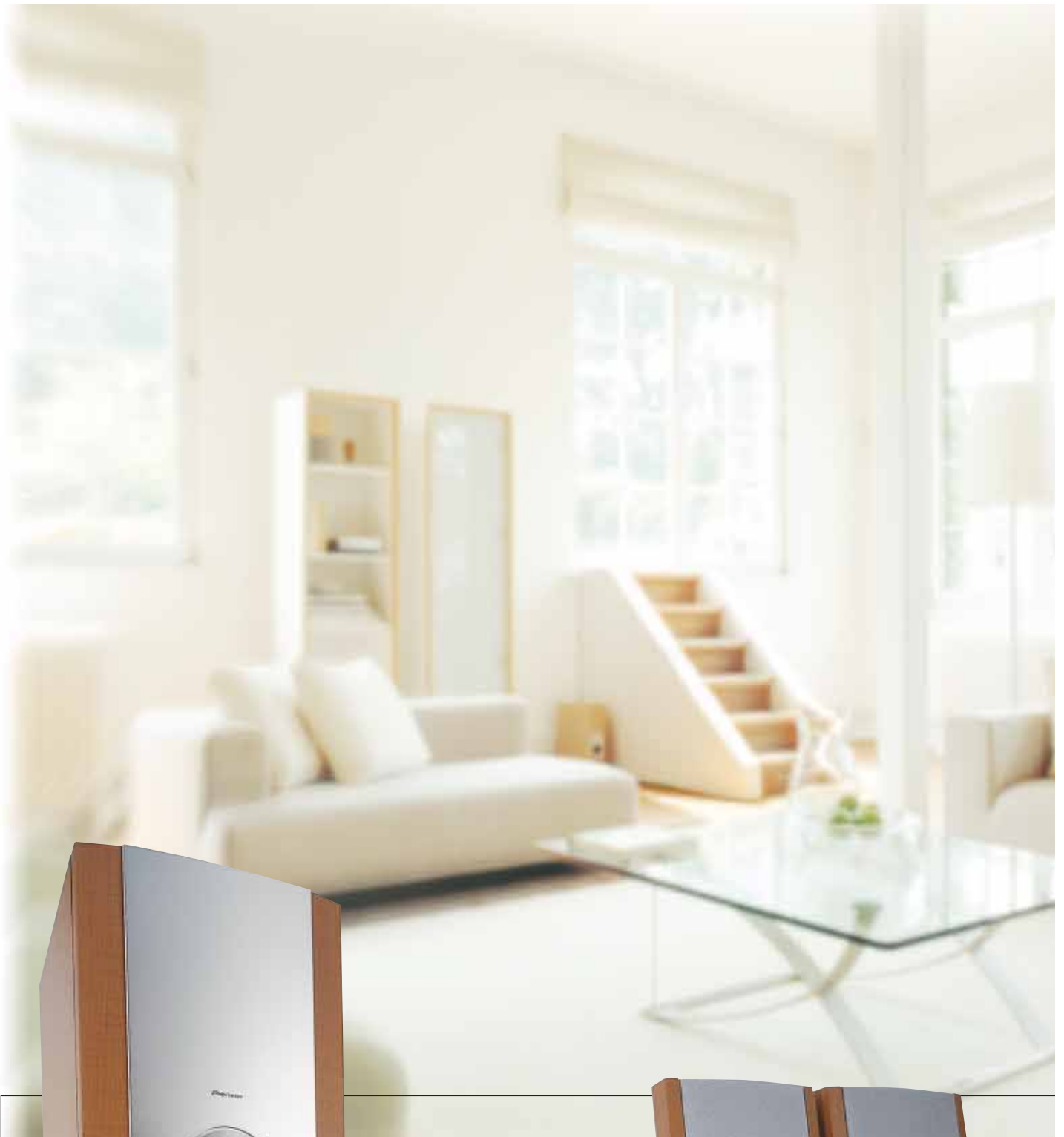

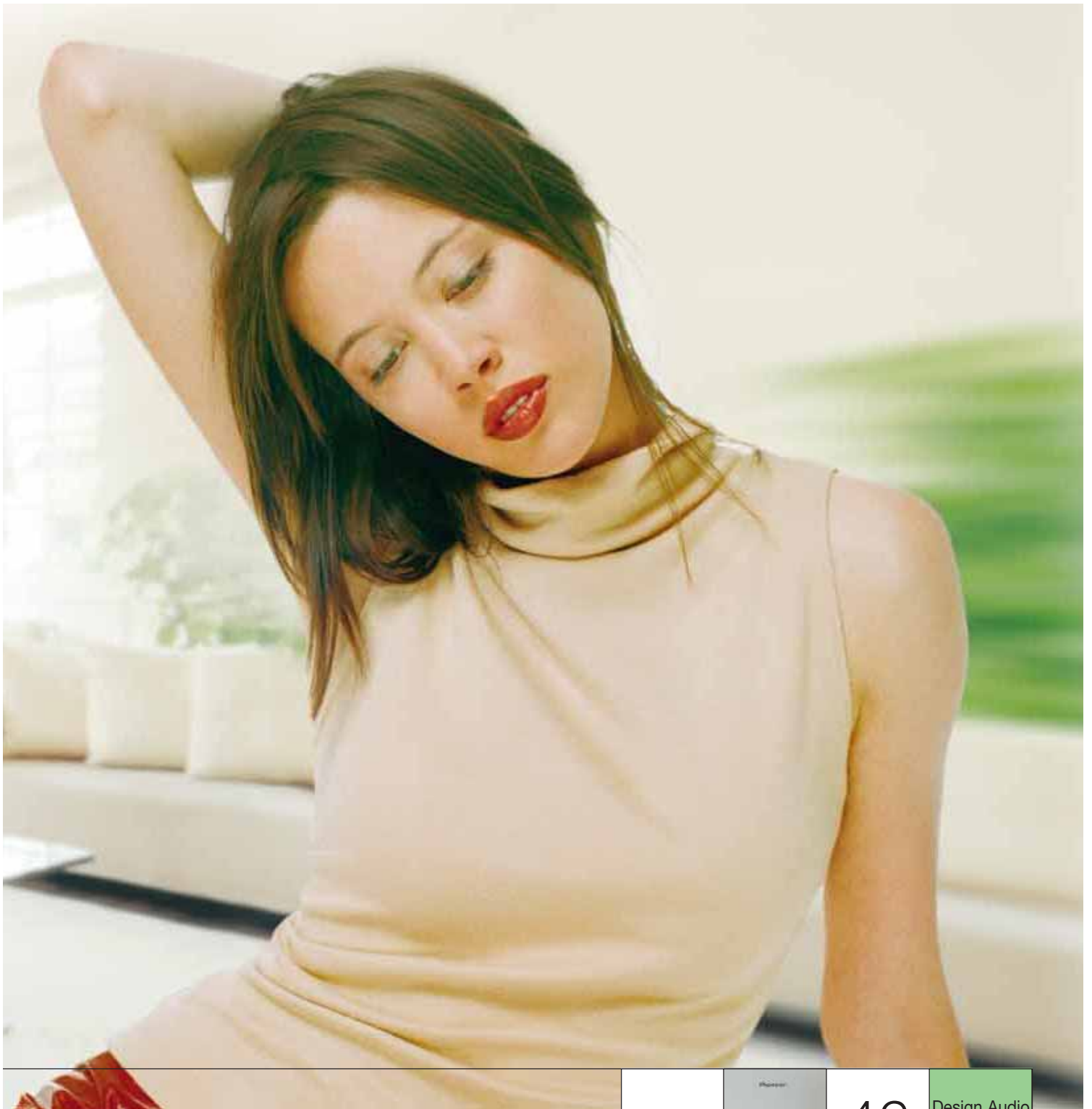

A moment to relax



49

Design Audio
Systems

Home. This is your place to kick back and relax. Which is why your sound statement doesn't need to be complicated either. Just like the NS series aesthetic, you'd rather keep it simple. This doesn't mean that you'll scrimp on sound quality or design. Then, definitely take a look. Packed with neat, convenient technology, these design audio systems look perfect and even get better when you discover the amazing sound. Pioneer design systems truly bridge the worlds of functional sound and stylish design.

Experience pure style



The NS Series keeps it simple. Subtly sleek and compact with just enough curve to be noticed. A separate ice blue display for a splash of cool colour anywhere you place it. And with such superb sound, all you have to do is decide if you prefer the design speakers in silver (the NS-11-S) or wood (the NS-11-Q). Delight in the extras, like touch sensor keys. Just a slight touch and you've made your selection. These design packages come with a CD tuner, an amplifier and 3D speaker system with a powerful subwoofer for detailed bass sounds. Don't forget the optional MiniDisc recorder and cassette deck. Now all you have to decide is where to put it.



NS-11-Q



30 W x 2 + 50 W RMS

NEW



DESIGN AUDIO SYSTEM

So you're considering the wooden 3D speaker system with its matching subwoofer? With such slim yet strong design lines, it'll make a statement. And the separate blue display adds the perfect touch. With 110 watts of total power, you'll delight in the spectacular strains of music that soar through your space. The system has everything you'll need: a CD tuner, amplifier, a separate display that can be positioned where you want, two satellite speakers and a subwoofer. A great design feature, the amplifier fits right under the subwoofer. You don't even notice it is there.

NS-11-S



30 W x 2 + 50 W RMS

NEW



DESIGN AUDIO SYSTEM

More inclined towards the sleek silver 3D speaker system with its corresponding subwoofer? No problem. You'll love the flash of the separate cool blue display and the highly addictive touch keys that beep to confirm you've hit them. With the slim silver design system, you still get everything you need: a CD tuner, a subwoofer for more bass, two satellite speakers, amplifier and a separate display that can be placed for convenient viewing. With 110 watts of total power output, this is a sophisticated yet powerful design system.

MJ-L11



NEW



MINIDISC RECORDER FOR NS-11-Q, NS-11-S, NS-DV88 AND NS-DV77

(optional)

You're a MiniDisc addict? Then you'll be happy to hear that you can create your own MiniDisc compilations on your NS-11 system with this matching MD LP* compatible MiniDisc recorder. Creating your own personal MiniDisc compilations to take anywhere has never been more stylish.

*Please see page 39 for more information.

CT-L11

NEW



CASSETTE DECK FOR NS-11-Q, NS-11-S, NS-DV88 AND NS-DV77

(optional)

Or would you rather revive your old cassette collection? Go ahead and do it with a bit of flair. Just slide your cassettes into this matching cassette deck. Your friends won't believe it!

JC-L11

NEW

EXTENSION CORD FOR NS-11-Q, NS-11-S, NS-DV88 AND NS-DV77

(optional)

Add the optional 5 metre extension cord – in case you decide to move the separate display further from the main unit.

For full product features and specifications, please see pages 77 to 78.



Create a work of art



Could a design sound system be this cool? Well, when you wave your hand in front of it, it opens automatically. Very tempting. The NS-F10 audio system is a visual feast with ultra-modern vertical components that you can opt to mount on the wall like a work of art, tucking the subwoofer and amp subtly in a corner. Or it looks just stunning placed on a shelf. Don't forget to turn it on. That's when you'll really be impressed.

NS-F10



30 W x 2 + 50 W RMS



DESIGN AUDIO SYSTEM

The entire NS-F10 audio system is art in itself. Especially, when it is displayed gracefully on your wall. Its clean vertical line is the perfect portrait of modern sound. The head unit features an RDS tuner with a CD player and a slim stylish remote. When displayed vertically with the CD recorder, the stand easily hides the additional connection cables. The powerful amplifier fits perfectly underneath the subwoofer to produce the best audio performance in its class. The two trendy matching satellite speakers come with black or grey changeable grilles. You can change shades with your mood. So aesthetically pleasing, it is hard to remember that it's designed for pure musical pleasure.

PDR-F10

CD RECORDER

(optional)

Create your own compilation CDs with a unique Pioneer CD recorder to enjoy your personal CD recordings wherever you go. This optional component adds yet another panel to the cool, clean line of the NS-F10. Don't even hesitate to add it to the system.



CT-F10

CASSETTE DECK

(optional)

Want to enjoy your favourite cassettes in this stylish package? Don't worry! It comes with an optional slot-in cassette player for the ultimate in convenience.



JC-F10

EXTENSION CORD

(optional)

Connect the optional 5 metre extension cord – in case you decide to move the main CD unit further from the amplifier.

For full product features and specifications, please see pages 77 to 78.





A moment to express

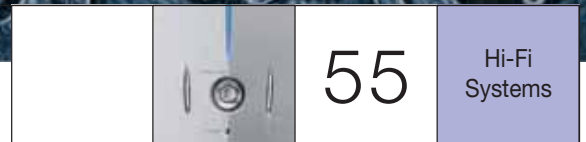

Music is all about fun. And with the new IS Series and hi-fi systems from Pioneer, you can definitely enjoy whatever type of music you're looking for – from chillin' techno grooves to blaring rock tunes. Whether you like it blasting or rather mellow, the super sound and cool design of these sets will impress all your friends...even when you plug in your games console or MiniDisc player. So you get maximum fun in all situations.

IS SERIES



Feel like throwing a party? Then, crank up the volume with the new members of the IS Series. With 100 watt x 2, you'll have bass that packs the power to get the party going! A sharp system in a silver techno-styled package, it screams style and functionality. There's a cool vertical CD player with a motorised door, plus, a handy front panel connection for a game console or a portable MD player. And with separate IS components, you decide. Point.

IS-22



100 W x 2 RMS

NEW



The perfect system! The IS-22 includes a vertical CD player, horizontal tray-type cassette deck, tuner, separate amplifier and 3-way loudspeaker system.



PLUG IT IN!

Limitless connections! Plug your games console into the front panel connection port for games with bombastic sound. Or hook up a portable MD recorder to create personalised MD discs from CDs, cassettes and even the radio, and then listen to those discs through the system's speakers. With new separate music playback and game sound modes, you'll experience sound like never before.

IS-22S



100 W x 2 RMS

NEW

Or opt for this system which has speakers the same height as the main unit (and the same features as the IS-22).



Motorised CD door

For full product features and specifications, please see page 79.

HI-FI SYSTEM

Pioneer's mini-systems are compact and powerful enough to handle all types of crowds. Built to pump out the big beats and groove mixes, you'll love the sound that flies from this baby. With a cooler-than-cool display and a techno design, you'll certainly want to show it off. So invite your friends and get the party going. Your sound is ready to go!

N-A4900RDS

RDS

100 W x 2 RMS

NEW



Try out this tantalising unit packed with 100 watts x 2 output power, a 3 CD carousel-type player for longer listening sessions, a double cassette deck with double auto-reverse, and an RDS tuner with 24 pre-sets and auto tuning. You'll be able to rattle the walls with all this power in the three-way speakers.

MICRO SYSTEM

Pure class in a small package. The sultry silver finish will appeal to modern tastes, and its compact size will satisfy those practical instincts – a perfect fit for your bookshelf or kitchen cabinet. The cool light blue EL display is super easy to read and the well-thought key placement means easy operation. Its all-in-one CD player, cassette player and RDS tuner give you more than enough easy options to enjoy your favourite tunes in a functional fashion. What can we say? Enjoy!

X-NM1

RDS

25 W x 2 RMS

NEW

Just because it's tiny doesn't mean it's missing important points. On the contrary, everything is covered: a tray-type CD player, pop-up cassette player with auto reverse, an RDS tuner with 24 pre-sets, a 2 x 25 watt amplifier and speakers with blue grilles make sure that you have quality music in any room from the office to the bedroom.



For full product features and specifications, please see page 79.

TECHNOLOGY



DVD-VIDEO

The latest in multimedia digital technology, DVD, guarantees second-to-none picture quality and sound. The digital picture is twice as sharp as standard VHS videotape. Home cinema ready, DVD enables surround sound as impressive as in the cinema, right in your home. The media itself is more durable than VHS tape and doesn't need to be rewound. Plus DVD is packed with useful features – multiple language and soundtracks and subtitles, support for various multi-channel audio encoding technologies such as DTS and Dolby Digital, multiple camera angle viewing selection, parental blocking, return-to-pause and view-per-chapter and support for both virtual or digital surround sound. With all of this, DVD is clearly the future.



DOLBY DIGITAL

The current surround sound quality encoding standard, Dolby Digital means movie theatre sound performance for your home cinema. Its 5.1 channel audio sound compression technology wraps you in sound. The front left and right, centre, rear left and right speakers span frequencies from 20 Hz – 20 kHz and there is a dedicated subwoofer channel for additional low frequency sound effects. Extra features mean not only stunning soundtracks but also additional language tracks on one disc. And Dolby Digital has gone a step further with THX Surround EX – a co-development between Dolby Digital and THX – which adds another audio channel to the soundtrack behind the listener, meaning more depth and localisation for even more sound perfection.



DTS

DTS 5.1 channel playback encoding technology is rapidly gaining popularity thanks to its dynamic sound impact that flies at the listener from left, right and centre surround sound speakers. Open up the doors of digital home cinema and super surround sound with any Pioneer DVD player and A/V amplifier/receiver* because they can handle DTS encoded digital audio data streams.

*Except VSX-409RDS



DTS-ES (MATRIX 6.1)

Early this year, DTS introduced a new cinema decoder: DTS-ES. Using low data compression and a high data transfer rate, DTS-ES adds an additional sound channel, allowing filmmakers to be even more creative with sound.



DOLBY PRO LOGIC

The forerunner to the increasingly popular Dolby Digital format, Dolby Pro Logic Surround uses five speakers to create a cinematic surround sound ambience. By decoding sound data contained in Dolby Surround, it produces four distinct outputs: front left, front right, centre and rear (2 speakers).



PLAYBACK COMPATIBILITY (DVD PLAYERS)

All Pioneer DVD players can play CD-R and CD-RW* discs, thanks to Pioneer's Twin-Wave Laser Pick-up, in addition to DVD-Video, audio CD and video CD discs.

All new Pioneer DVD players can play back DVD-R and DVD-RW discs recorded in "Video" mode. The DV-646A and DV-545 players can also handle discs recorded in "DVD Video Recording" mode, which combines many high quality, easy-to-use recording and editing functions to make recording, editing and disc navigation a breeze.

RW COMPATIBLE Note: DVD players which have this mark can play discs recorded in "DVD Video Recording" mode, and of course DVD-R and DVD-RW discs recorded in "Video" mode.

* Note: CD-R and CD-RW discs may be read on the condition that they comply to the applicable Orange Book standards, and have been recorded with data that adhere to the applicable Red Book (CD-DA) or White Book (Video CD; version 2.0) formats. Both CD-R and CD-RW discs which are recorded by music CD format can be reproduced. Disc may not be reproduced because of following reasons: recording characteristics of recorder/characteristics of disc/ scratch and dust on disc/dust and condensation on pickup lens. Unfinalised discs can be reproduced (however because the TOC (table-of-contents) information is lacking, time display may not be shown).



MP3 PLAYBACK COMPATIBILITY (DV-646A/DV-545/DV-444-K/DV-444-S)

Pioneer's DVD players with MP3 playback capability and easy-to-use features keep up with the wave of the future. These players are capable of reading MP3 files recorded onto CD-R or CD-RW discs. Because MP3 files occupy less space on a disc, you can create CDs with up to 10 hours of compressed audio – that's a lot of listening in a small package. And Pioneer has made finding your way through a sea of up to 250 MP3 directories and files as easy as a day at the beach, by using the on-screen display (you can view on your TV) for navigation and for programming or selecting files.

MP3 Navigation On-Screen Display



Set-up Navigator On-Screen Display

ADVANCED GUI WITH BASIC/EXPERT MODES AND SET-UP NAVIGATOR (ALL DVD PLAYERS)

Pioneer's Advanced GUI (Graphical User Interface) simplifies control of a wide range of player settings, allowing many operations to be carried out even as a disc plays. Several modes are available. Basic mode keeps settings simple, with the function descriptions displayed on-screen (On-Screen Information). Expert mode allows audio and video enthusiasts to select among more detailed settings. The Set-up Navigator function simplifies complicated operations by presenting an interactive interface that extends to your existing A/V system. You answer the questions, and complicated DVD settings will be completed automatically.

DIGITAL SIGNAL PROCESSING (DSP) (A/V AMPLIFIERS & RECEIVERS)

The DSP (Digital Signal Processing) modes transform your living room into a variety of different sonic environments when playing either two-channel or multi-channel sources. Pioneer's DSP digitally simulates sound fields by precisely creating and controlling the effects of reverberation, reflection and delay that nature and architecture impose upon our perception of sound. The featured sound fields include (except for VSX-C300/VSX-C300-S):



- **Hall 1** simulates the acoustic effects of a large concert hall. A long delay time of reflected sounds, coupled with reverb effects, let the listener enjoy the dynamic and rich sounds characteristic of concert halls and powerful orchestral performances.
- **Hall 2** simulates the acoustic environment of a very resonant concert hall. Rich in reverberation and a full sound create the impression of a lively performance space.
- **Jazz** simulates the acoustic effects of a jazz club. Reflected sound is virtually below 100 ms so that the listener can enjoy a live band effect.
- **Dance** simulates the acoustic effects of a dance club, featuring a strong bass sound. Reflected sound delay time is virtually below 50 ms for the listener to enjoy the visceral power of dance music.
- **Theatre 1** reproduces sound field effects without losing the localisation of each channel. Theatre effects can be enjoyed without losing Dolby Digital/Dolby Pro Logic effects when used in combination with those formats (with movies bearing the Dolby Surround trademark).
- **Theatre 2** simulates the acoustic environment of a theatre while maintaining proper localisation of each channel.
- **5/7 Channel Stereo** (VSA-E08/VSX-909RDS(-G)/VSX-859RDS(-G)/VSX-839RDS/VSX-D810S) processes the sound of regular stereo sources while using all the speakers in the system to induce a rich, all-around sound. 7 Channel* mode will be in effect when Surround Back speakers are switched on; when switched off, 5 Channel mode will be used.
- **6 Channel Stereo** (VSX-D810S) processes sound into front left, front right, centre, rear left, rear right and rear centre, for an all-encompassing blanket of sound that fills the room and fills your senses.
- In the slim-type VSX-C300/VSX-C300-S, a series of pre-defined easy-to-use surround and listening modes are available. See page 27 for details.

*Not available with VSX-D810S.



MIDNIGHT LISTENING MODE (ALL A/V AMPLIFIERS & RECEIVERS, EXCEPT VSX-409RDS)

If others are sleeping or studying, trying to enjoy a programme quietly shouldn't compromise such sound qualities as surround effects or dialogue clarity. Midnight Listening Mode is the solution. It adjusts subwoofer, rear and centre speaker levels, while enhancing delay and compressing dynamic range, for greater enjoyment of cinema-like sound at low volume.



ADVANCED THEATER (ALL A/V AMPLIFIERS & RECEIVERS, EXCEPT VSX-409RDS)

The Advanced Theater function takes advantage of discrete multi-channel information provided with DTS, Dolby Digital and Dolby Pro Logic encoded sources. Working with the surround decoder, it enhances the sound field with optimised reverberation levels, frequency response, and other DSP parameters, based on the type of movie you're watching. Three basic sound fields are available: Musical, Drama and Action. 7-D Theater, 6-D Theater, 5-D Theater and Expanded Theater are available for certain models only.

- **Musical** mode creates a 360-degree sound field around the viewer, creating the sensation of sitting at the centre of an acoustically perfect theatre with no unwanted reflections. Ideal for music videos and musicals. (9 effect levels)
- **Drama** mode is optimised for drama and romance movies, creating the acoustics of a medium-sized cinema. The sound field spreads at ear level to heighten the sense of being there. (9 effect levels)
- **Action** mode creates a wall of sound behind you to create an enveloping sound field up front. You enjoy a heightened sense of power and speed, especially from action-packed movies. (9 effect levels)



- **5-D Theater** mode (VSA-E08/VSX-909RDS(-G)/VSX-859RDS(-G)/VSX-839RDS/VSX-D810S) allows you to enjoy popular Dolby Pro Logic sources (LDs, video tapes, TV and satellite broadcasts, etc.) as fully as if they were the latest 5.1 channel digital programmes.



- **6-D Theater** (VSX-D810S) uses up to six speakers and a subwoofer to create 6.1 surround sound that is more realistic than ever before – even if the original track wasn't recorded that way (e.g. for Dolby Pro Logic or stereo sources). This mode also enhances DTS and Dolby Digital-encoded signals. Don't worry, though! That aeroplane you see on the screen isn't really landing in your living room. It just sounds that way.



- **7-D Theater** (VSA-E08/VSX-909RDS(-G)/VSX-859RDS(-G)) works with Dolby Pro Logic, Dolby Digital and DTS sources to emulate stereo imaging in the additional surround channels. It's as if you were listening to 7.1 channels! When used with 7.1 channel software, the surround effect is further improved. This sound field programme abounds with three dimensional presence.



- **Expanded Theater** (VSX-D710S/VSX-D510/VSX-D510-S) broadens the soundstage and dramatically enhances surround effects when listening to Dolby Pro Logic or stereo sources. If you use it when viewing a restaurant scene, you might just be able to eavesdrop on the conversations going on outside of the main action or the subtle banging of pots and pans in the kitchen. This mode also enhances DTS and Dolby Digital-encoded signals, for amazing surround sound.

Digital Home Cinema Systems Features - 1

	NS-DV88	NS-DV77	DCS-100	HTD-5
SYSTEM				
Display	FL (Separate)	FL (Separate)	FL	FL
Dimmer Control	5 step	5 step	2 step	5 step
Remote Control Unit	Preset	Preset	Preset	•
AMPLIFIER				
Surround (DIN)				
Front	30 W per channel (8 Ω, 1% THD)	30 W per channel (8 Ω, 1% THD)	18 W per channel (6 Ω, 1% THD)	60 W per channel (8 Ω, 1% THD)
Centre	30 W (8 Ω, 1% THD)	30 W (8 Ω, 1% THD)	18 W (6 Ω, 1% THD)	20 W (8 Ω, 1% THD)
Surround	30 W per channel (8 Ω, 1% THD)	30 W per channel (8 Ω, 1% THD)	18 W per channel (6 Ω, 1% THD)	20 W per channel (8 Ω, 1% THD)
Subwoofer	50 W (4 Ω, 1% THD)	50 W (4 Ω, 1% THD)	18 W (6 Ω, 1% THD)	60 W (8 Ω, 1% THD)
Surround (RMS)				
Front	40 W x 2 (8 Ω, 10% THD)	40 W x 2 (8 Ω, 10% THD)	25 W per channel (6 Ω, 10% THD)	80 W per channel (8 Ω, 10% THD)
Centre	40 W (8 Ω, 10% THD)	40 W (8 Ω, 10% THD)	25 W (6 Ω, 10% THD)	30 W (8 Ω, 10% THD)
Surround	40 W x 2 (8 Ω, 10% THD)	40 W x 2 (8 Ω, 10% THD)	25 W per channel (6 Ω, 10% THD)	30 W per channel (8 Ω, 10% THD)
Subwoofer	65 W (4 Ω, 10% THD)	65 W (4 Ω, 10% THD)	25 W (6 Ω, 10% THD)	80 W (8 Ω, 10% THD)
SURROUND SOUND				
Dolby Pro Logic Surround	•	•	•	•
Dolby Digital	•	•	•	•
DTS Digital Surround	•	•	•	•
DSP Mode				
HALL 1, 2	•	•	•	•
JAZZ	•	•	•	•
DANCE	•	•	•	•
THEATER 1 & 2	•	•	•	•
SIMULATED STEREO	•	•	•	•
Advanced Theater				
STANDARD	•	•	•	•
MUSICAL	•	•	•	•
DRAMA	•	•	•	•
ACTION	•	•	•	•
VIRTUAL SURROUND 1, 2	•	•	•	•
REAR WIDE	•	•	•	•
AUDIO FEATURES				
Midnight Listening Mode	•	•	•	•
QUIET MODE	•	•	•	•
THEATER BASS	•	•	•	•
P-Bass	•	•	•	•
Bass/Treble Tone Control	•	•	•	•
Subwoofer Level Control	•	•	•	•
TUNER				
RDS Tuner	•	•	•	•
Band (FM/AM)	•	•	•	•
Presets	30	30	30	30
Auto Tuning	•	•	•	•
Timer	• (3-mode)	• (3-mode)	Wake up/Sleep	Wake up/Sleep
DVD				
Playback Discs	DVD/VCD/CD/ CD-R*1/CD-RW*1	DVD/VCD/CD/ CD-R*1/CD-RW*1	DVD/VCD/CD/ CD-R*1/CD-RW*1	DVD/VCD/CD/ CD-R*1/CD-RW*1
Twin-Wave Laser Pickup	•	•	•	•
Dual System (PAL/NTSC) (Video output)	•	•	•	•
10-bit Video Signal D/A Converter	•	•	•	•
96kHz/24-bit D/A Converter	•	•	•	•
CONVENIENCES				
Advanced GUI (Graphical User Interface)	•	•	•	•
Basic/Expert Mode Selection	•	•	•	•
Guide Indication	•	•	•	•
Set-Up Navigator	•	•	•	•
On-Screen Information	•	•	•	•
SPECIAL PLAY FUNCTIONS				
Programme Memory (Title or Chapter)	•	•	•	•
Resume Function (Stop Key)	•	•	•	•
Condition Memory (DVD, 15 discs)	•	•	•	•
Continue Play Memory (Last Memory)(5 DVD's, 1 VCD)	•	•	•	•
Repeat Mode (All, Title/Chapter, A-B)	•	•	•	•
Programme Play (CD/Track, Video/Chapter, Title)	24	24	24	24
Still Play (Field/Frame)	•	•	•	•
Still/Step Play	•	•	•	•
(Forward/Reverse, except VCD reverse)	•	•	•	•
Slow Play (except VCD reverse)	•	•	•	•
Random Play	•	•	•	•
Scan/Search Functions				
10-Key Direct Search and Play (Chapter/Track)	•	•	•	•
Title Search	•	•	•	•
Track/Time search	•	•	•	•
Other Special Functions				
Accurate Digital Servo with Automatic Jitter Adjustment (DVD)	•	•	•	•
Viter-bi RF Decoding Process (DVD)	•	•	•	•
Quick Start	•	•	•	•
Transfer Bit Rate Indicator	•	•	•	•

*1) Note: CD-R and CD-RW discs may be read on the condition that they comply to the applicable Orange Book standards, and have been recorded with data that adhere to the applicable Red Book (CD-DA) or White Book (Video CD; version 2.0) formats. Both CD-R and CD-RW discs which are recorded by music CD format can be reproduced. Disc may not be reproduced because of following reasons: recording characteristics of recorder/characteristics of disc/ scratch and dust on disc/dust and condensation on pickup lens. Unfinalised discs can be reproduced (however because the TOC (table-of-contents) information is lacking, time display may not be shown).

Digital Home Cinema Systems Features - 2

	NS-DV188	NS-DV177	DCS-100	HTD-5
TERMINALS				
Digital Input				
Coaxial	•	•		•
Optical	•	•	•	
Digital Output (Optical)	•	•		
Audio (TUNER Included)/Video Inputs	AUX x 3 / -	AUX x 3 / -	TV x 1 / AUX x 1	TV x 1 / AUX x 1
Audio/Video Output	for system cable / AUX x 1	for system cable / AUX x 1	AUX OUT x 1	AUX OUT x 1
S-Video Input/Output	- / •	- / •	- / •	- / •
S2 Compatibility	•	•	•	•
SATELLITE AND SUBWOOFER SPEAKER SYSTEM				
Magnetically Shielded (Satellite)	•	•	•	
Magnetically Shielded (Subwoofer)	•	•		

Digital Home Cinema Systems Specifications

	NS-DV188	NS-DV177	DCS-100	HTD-5
SYSTEM				
Cable length				
DVD Tuner—Display	1.5 m	1.5 m		
DVD Tuner—Subwoofer	5 m	5 m		
Display Unit				
Dimensions	206 x 65 x 50 mm	206 x 65 x 50 mm		
Weight	0.2 kg	0.2 kg		
Remote Control Unit				
Dimensions (W x H x D)	55 x 26 x 190 mm	55 x 26 x 190 mm	58 x 190 x 23.2 mm	59 x 190 x 23 mm
Weight	0.08 kg (without battery)	0.08 kg (without battery)	0.09 kg (without battery)	0.09 kg (without battery)
Power Requirements	220 - 230 V/50 - 60 Hz	220 - 230 V/50 - 60 Hz	220 - 240 V/50 - 60 Hz	220 - 230 V/50 - 60 Hz
Power Consumption In Use / Standby	166 W / 1 W	166 W / 1 W	118 W / 1 W	136 W / 1 W
Dimensions (W x H x D)	220 x 65 x 317 mm	220 x 65 x 317 mm	360 x 332 x 75 mm	420 x 150 x 411.6 mm
Weight	2.5 kg	2.5 kg	5.1 kg	9.8 kg
AMPLIFIER SECTION				
DIN Continuous Power Output (8 Ω)				
Front (1 kHz, 1 % THD)	30 W per channel (8 Ω, 1 % THD)	30 W per channel (8 Ω, 1 % THD)	18 W per channel (6 Ω, 1 % THD)	60 W per channel (8 Ω, 1 % THD)
Centre (1 kHz, 1 % THD)	30 W (8 Ω, 1 % THD)	30 W (8 Ω, 1 % THD)	18 W (6 Ω, 1 % THD)	20 W (8 Ω, 1 % THD)
Rear (1 kHz, 1 % THD)	30 W per channel (8 Ω, 1 % THD)	30 W per channel (8 Ω, 1 % THD)	18 W per channel (6 Ω, 1 % THD)	20 W per channel (8 Ω, 1 % THD)
Subwoofer (100 Hz, 1 % THD)	50 W (4 Ω, 1 % THD)	50 W (4 Ω, 1 % THD)	18 W (6 Ω, 1 % THD)	60 W (8 Ω, 1 % THD)
RMS Power Output (8 Ω)				
Front (1 kHz, 1 % THD)			25 W per channel (6 Ω, 10 % THD)	80 W per channel (8 Ω, 10 % THD)
Centre (1 kHz, 1 % THD)			25 W (6 Ω, 10 % THD)	30 W (8 Ω, 10 % THD)
Rear (1 kHz, 1 % THD)			25 W per channel (6 Ω, 10 % THD)	30 W per channel (8 Ω, 10 % THD)
Subwoofer (100 Hz, 1 % THD)			25 W (6 Ω, 10 % THD)	80 W (8 Ω, 10 % THD)
CD/DVD PLAYER SECTION				
S/N Ratio (Audio)	100 dB	100 dB	95 dB	115 dB
Dynamic Range	97 dB	97 dB	95 dB	100 dB
Distortion	0.004 %	0.004 %	0.004 %	0.004 %
Frequency Response				
48 kHz Sampling	4 — 22,000 Hz	4 — 22,000 Hz	4 — 22,000 Hz	4 — 22,000 Hz
96 kHz Sampling	4 — 44,000 Hz	4 — 44,000 Hz	4 — 44,000 Hz	4 — 44,000 Hz
SPEAKER SECTION				
Front Satellite	8.7 cm	8.7 cm	8.7 cm	10 cm woofer, 5.2 cm tweeter
Impedance	8 Ω	8 Ω	6 Ω	8 Ω
Frequency Range	100 — 20,000 Hz	100 — 20,000 Hz	100 — 20,000 Hz	50 — 20,000 Hz
Maximum Input Power	40 W	40 W	40 W	100 W
Sensitivity (1 m/W)	86 dB	86 dB	84 dB	85.5 dB
Dimensions (W x H x D)	110 x 154 x 78 mm	110 x 154 x 78 mm	110 x 155 x 76 mm	150 x 270 x 178 mm
Weight	0.81 kg	0.81 kg	0.75 kg	2.0 kg
Centre Satellite	8.7 cm	8.7 cm	8.7 cm	8.7 cm
Impedance	8 Ω	8 Ω	6 Ω	8 Ω
Frequency Range	100 — 20,000 Hz	100 — 20,000 Hz	100 — 20,000 Hz	80 — 20,000 Hz
Maximum Input Power	40 W	40 W	40 W	34 W
Sensitivity (1 m/W)	85 dB	85 dB	84 dB	86.5 dB
Dimensions (W x H x D)	210 x 110 x 78 mm	210 x 110 x 78 mm	200 x 110 x 76 mm	370 x 120 x 130 mm
Weight	0.92 kg	0.92 kg	0.8 kg	1.8 kg
Rear Satellite	8.7 cm	8.7 cm	8.7 cm	8.7 cm
Impedance	8 Ω	8 Ω	6 Ω	8 Ω
Frequency Range	100 — 20,000 Hz	100 — 20,000 Hz	100 — 20,000 Hz	110 — 20,000 Hz
Maximum Input Power	40 W	40 W	40 W	33 W
Sensitivity (1 m/W)	86 dB	86 dB	84 dB	86 dB
Dimensions (W x H x D)	110 x 154 x 78 mm	110 x 154 x 78 mm	110 x 155 x 76 mm	115 x 150 x 96 mm
Weight	0.81 kg	0.81 kg	0.75 kg	0.8 kg
Subwoofer	16 cm	16 cm	16 cm	16 cm
Impedance	4 Ω	4 Ω	6 Ω	8 Ω
Frequency Range	31 — 300 Hz	31 — 300 Hz	30 — 300 Hz	30 — 200 Hz
Maximum Input Power	65 W	65 W	50 W	100 W
Sensitivity (1 m/W)	81 dB	81 dB	78 dB	82 dB
Dimensions (W x H x D)	190 x 420 x 420 mm	190 x 420 x 420 mm	190 x 282 x 267 mm	190 x 360 x 327 mm
Weight	14.2 kg	14.2 kg	3.8 kg	4.8 kg

See page 65 for rear panels of Digital Home Cinema Systems.

DVD Players Features - 2

	<i>DV-939A</i>	<i>DV-737/ DV-737-K</i>	<i>DV-646A</i>	<i>DV-545</i>	<i>DV-444-K/ DV-444-S</i>	<i>DV-343</i>	<i>DV-340</i>	<i>PDV-LC20</i>	<i>PDV-20</i>
TERMINALS									
Euro-SCART	2 (In/Out)	2 (In/Out)	2 (In/Out)	2 (In/Out)	1	1	1		
RGB-Y/C Video Output (on Euro-Scart)	•	•	•	•	•				
S-Video Output	2*4	2*4	2	1	1	1	1	1*5	1*5
Video Output	2*4	2*4	2	1	1	1	1	(yes)	(yes)
5.1-Channel Audio Output	1*4		1						
Audio Output	2*4	2*4	2	1	1	1	1	(yes)	(yes)
Coaxial Digital Output	1*4	1*4	1	1	1	1	1		
Optical Digital Output	1	1	1	1	1			1*6	1*6
Audio/Video Input (in AV-IN Mode)								1	
Headphone Jack								2	1
CONTROL TERMINALS									
Pioneer System Remote	2 (In/Out)	•	2 (In/Out)	•	•	•	•	•	•

*1) Note: CD-R and CD-RW discs may be read on the condition that they comply to the applicable Orange Book standards, and have been recorded with data that adhere to the applicable Red Book (CD-DA) or White Book (Video CD; version 2.0) formats. Both CD-R and CD-RW discs which are recorded by music CD format can be reproduced. Disc may not be reproduced because of following reasons: recording characteristics of recorder/characteristics of disc/ scratch and dust on disc/dust and condensation on pickup lens. Unfinalised discs can be reproduced (however because the TOC (table-of-contents) information is lacking, time display may not be shown).

*2) NTSC is converted into artificial PAL format for output. AV input only functions with PAL system.

*3) With illumination

*4) Gold-plated

*5) Unified with Video Out

*6) Unified with Audio Out

Note: DVD-Video players and DVD-Video discs have regional code classifications that determine their market area and compatibility. Discs and players must have matching codes in order to be played. All DVD-Video players featured in this catalogue are classified as regional code 2.

DVD Players Specifications

	<i>DV-939A</i>	<i>DV-737/ DV-737-K</i>	<i>DV-646A</i>	<i>DV-545</i>	<i>DV-444-K/ DV-444-S</i>	<i>DV-343</i>	<i>DV-340</i>	<i>PDV-LC20</i>	<i>PDV-20</i>
VIDEO CHARACTERISTICS									
Horizontal Resolution (Lines) (DVD)	Over 500	Over 500	540	540	540	Over 500	Over 500	Over 500	Over 500
DIGITAL AUDIO CHARACTERISTICS									
Total Harmonic Distortion	0.001 %	0.0010 %	0.0015 %	0.0016 %	0.0016 %	0.0016 %	0.0016 %	0.03 %	0.03 %
Frequency Response									
48 kHz	4 – 22,000 Hz	4 – 22,000 Hz	4 – 22,000 Hz	4 – 22,000 Hz	4 – 22,000 Hz	4 – 22,000 Hz	4 – 22,000 Hz	4 – 22,000 Hz	4 – 22,000 Hz
96 kHz	4 – 44,000 Hz	4 – 44,000 Hz	4 – 44,000 Hz	4 – 44,000 Hz	4 – 44,000 Hz	4 – 44,000 Hz	4 – 44,000 Hz	4 – 44,000 Hz	4 – 44,000 Hz
192 kHz	4 – 88,000 Hz		4 – 88,000 Hz						
Signal-to-Noise Ratio	115 dB	115 dB	118 dB	118 dB	118 dB	118 dB	118 dB	108 dB	108 dB
Dynamic Range	110 dB	109 dB	108 dB	103 dB	103 dB	103 dB	103 dB	88 dB	88 dB
MISCELLANEOUS									
Power Requirements	220 – 240 V/ 50/60 Hz	220 – 240 V 50/60 Hz	220 – 240 V 50/60 Hz	220 – 240 V 50/60 Hz	220 – 240 V 50/60 Hz	220 – 240 V 50/60 Hz	220 – 240 V 50/60 Hz	100 – 240 V 50/60 Hz (AC Adaptor)	100 – 240 V 50/60 Hz (AC Adaptor)
Power Consumption	32 W	27 W	15 W	14 W	13 W	11 W	11 W	10 W (Player)	5 W (Player)
Dimensions (W x H x D)	420 x 130 x 371 mm	420 x 128 x 370 mm	420 x 97.5 x 277 mm	420 x 55 x 279 mm	420 x 55 x 279 mm	420 x 95.5 x 278 mm	420 x 95.5 x 282 mm	190 x 25.9 x 142 mm	190 x 15.9 x 142 mm
Weight	9.2 kg	6.9 kg	2.9 kg	2.6 kg	2.6 kg	2.7 kg	2.7 kg	630 g	300 g

A/V Amplifiers & Receivers Features

	VSA-E08	V SX-909RDS/ V SX-909RDS-5-G	V SX-859RDS/ V SX-859RDS-5-G	V SX-859RDS	V SX-DB810S	V SX-D710S	V SX-D510/ V SX-D510-S	V SX-C300/ V SX-C300-S	V SX-409RDS	M-10X
POWER OUTPUT										
Maximum Power (1 kHz, 10 % THD, RMS, Per Channel)										
Stereo (DIN)	130 W x 2 (6 Ω, 1 % THD)	110 W x 2 (8 Ω, 1 % THD)	100 W x 2 (8 Ω, 1 % THD)	100 W x 2 (8 Ω, 1 % THD)	100 W x 2 (8 Ω, 1.0 % THD)	100 W x 2 (8 Ω, 1.0 % THD)	80 W x 2 (8 Ω, 1.0 % THD)	30 W + 30 W	80 W x 2 (8 Ω, 0.9 % THD)	120 W x 2 (4 Ω), 75 W x 2 (8 Ω)
SURROUND										
Front	130 W x 2 (6 Ω, 1 % THD)	110 W x 2 (8 Ω, 1 % THD)	100 W x 2 (8 Ω, 1 % THD)	100 W x 2 (8 Ω, 1 % THD)	100 W/ch* x 2 (8 Ω, 1.0 % THD)	100 W/ch* x 2 (8 Ω, 1.0 % THD)	80 W/ch* x 2 (8 Ω, 1.0 % THD)	30 W/ch	80 W/ch* x 2 (8 Ω, 0.9 % THD)	
Centre	130 W (6 Ω, 1 % THD)	110 W (8 Ω, 1 % THD)	100 W (8 Ω, 1 % THD)	100 W (8 Ω, 1 % THD)	100 W (8 Ω, 1.0 % THD)	100 W (8 Ω, 1.0 % THD)	80 W (8 Ω, 1.0 % THD)	30 W	80 W (8 Ω, 0.9 % THD)	
Rear (Surround)	130 W x 2 (6 Ω, 1 % THD)	110 W x 2 (8 Ω, 1 % THD)	100 W x 2 (8 Ω, 1 % THD)	100 W x 2 (8 Ω, 1 % THD)	100 W/ch* x 2 (8 Ω, 1.0 % THD)	100 W/ch* x 2 (8 Ω, 1.0 % THD)	80 W/ch* x 2 (8 Ω, 1.0 % THD)	30 W/ch	80 W/ch* x 2 (8 Ω, 0.9 % THD)	
Surround Back					100 W (8 Ω, 1.0 % THD)					
SURROUND SOUND										
Dolby Pro Logic Surround	•	•	•	•	•	•	•	•	•	
Dolby Digital	•	•	•	•	•	•	•	•	•	
DTS Digital Surround	•	•	•	•	•	•	•	•	•	
MPEG	• (BC)	• (BC)	• (BC)	• (BC)				• (BC)		
THX	• (THX Ultra)	• (THX Ultra)	• (THX Select)	• (THX Select)						
Surround EX	•	•	•	•						
DTS ES	• (Compatible)	• (Compatible)	• (Compatible)		• (Compatible)					
Digital Signal Processor (DSP)	• (Dual LSI)	• (Dual LSI)	• (Dual LSI)	• (Dual LSI)	• (Dual LSI)			•		
DSP Mode (**=Advanced Theater)	7+4**	7+4**	7+4**	7+4**	7+4**	6+4**	6+4**		6+4**	
DSP Mode										
HALL 1, 2	•	•	•	•	•	•	•			
JAZZ	•	•	•	•	•	•	•			
DANCE	•	•	•	•	•	•	•			
THEATER 1 & 2	•	•	•	•	•	•	•			
HALL										•
6-CHANNEL STEREO										•
5-CHANNEL STEREO	•	•	•	•	•					
Advanced Theater										
MUSICAL	•	•	•	•	•	•	•	•	•	
DRAMA	•	•	•	•	•	•	•	•	•	
ACTION	•	•	•	•	•	•	•	•	•	
7-D THEATER	•	•	•	•	•	•	•	•	•	
6-D THEATER										•
5-D THEATER	•	•	•	•	•	•	•	•	•	
Expanded THEATER						•	•			
Accurate Imaging System (5 channel Equal Power)	•	•	•	•				•	•	
AUDIO FEATURES										
96 kHz/24-Bit D/A Converter	•	•	•	•	•			•		
Direct Energy MOS FET Amplification	•	•	•	•						•
Pioneer Hybrid Amplification					•	•	•		•	
Digital Noise Reduction	•	•	•	•	•	•	•	•	•	
Midnight Listening Mode	•	•	•	•	•	•	•	•	•	
SOURCE DIRECT Switch	•	•	•	•	•	•	•	•	•	
Bass/Treble Tone Controls	•	•	•	•	•	•	•	•	•	
Loudness	•	•	•	•	•	•	•	•	•	
Super Bass								•	•	
Motor-Driven Volume Control	•	• (Electronic)	• (Electronic)	• (Electronic)	• (Electronic)	• (Electronic)	• (Electronic)	• (Electronic)	• (Electronic)	
CONVENIENCES										
On-Screen Display (GUI)	•	•	•	•	•	•	•	•	•	
Remote Control	LCD Touch Panel	Presel & Smart	Presel & Smart	Presel & Smart	Presel & Smart	Presel & Smart	Presel	Presel	SR	
Multi-Operation (Macro)	•	•	•	•	•	•	•	•	•	
Flexible Macro	•	•	•	•	•	•	•	•	•	
DVD Control	•	•	•	•	•	•	•	•	•	
Remote Key Illumination	LCD	ALL Key	ALL Key							
Video Signal Selector	•	•	•	•	•	•	•	•	•	
Function Rename	•	•	•	•	•	•	•	•	•	
FL Dimmer (steps)	• (4)	• (4)	• (4)	• (4)	• (4)	• (4)	• (4)	•	•	
TUNER										
RDS (Radio Data System)		•	•	•	•	•	•	•	•	
EON Link		•	•	•	•	•	•	•	•	
Random Preset Stations		30	30	30	30	30	30	30	30	
3-Speed Accelerated Tuning		•	•	•	•	•	•	•	•	
TERMINALS										
Multi-Channel Input	7.1 ch (External)	7.1 ch (External)	7.1 ch (External)	5.1 ch (External)	7.1 ch (DVD)	5.1 ch (DVD)	5.1 ch (DVD)		5.1 ch (DVD)	
RF Input for Dolby Digital (Demodulator)	•	•	•							
Digital Input	5 (assign)	5 (assign)	5 (assign)	4 (assign)	4 (assign)	3 (assign)	3 (assign)	3		
Coaxial	2	2	2	2	1	1	1			
Optical	3	3	3	2	3	2	2	3 (front 1)		
Digital Output (Optical)	2	2	2	1	1	1	1			
Audio (TUNER Included)/Video Inputs	5***/5	5/5	5/5	4/5	4/4	4/4	3/3	1/4	3/3	1/0
Audio/Video Output	2A/2AV +1V +1V	2A/2AV+1V+1V	2A/2AV+2V	2A/2AV+1V	1A/1AV+1V	1A/1AV+1V	1A/1AV+1V	1AV+2V	1A/1AV+1V	
Phono Input	•	•	•							
S-Video Input/Output	5/3	5/3	5/3	5/3	4/2	4/2				
Component Video Input/Output	2/1	2/1	2/1(Assign)		2/1 (Assign)	2/1 (Assign)				
Preamp Output	• All (7.1 ch)	• All (7.1 ch)	• All (7.1 ch)	• All (5.1 ch)	• All (6.1 ch)	• (C/SW)	• (SW)	• (SW)	• (SW)	
A/V Input on Front										
SR (System Remote) Terminal	• (In/Out)	• (In/Out)	• (In/Out)	• (In/Out)	• (Out)	• (Out)	• (Out)	• (In/Out)	• (Out)	• (In)
Speaker A/B	Parallel	Parallel	Parallel	Parallel	Independent	Independent	A only	A only	A only	A only
Large Speaker Terminals	• (All)	• (All)	• (All)	• (All)	• (All)	• (All)	• (All)			• (All)

*Total using one channel.

*** Tuner optional

A/V Amplifiers & Receivers Specifications

	VSA-E08	V SX-909RDS / V SX-909RDS-G	V SX-859RDS / V SX-859RDS-G	V SX-839RDS	V SX-D810S	V SX-D710S	V SX-D510 / V SX-D510-S	V SX-C300 / V SX-C300-S	V SX-409RDS	M-10X
AMPLIFIER SECTION										
DIN Continuous Power Output (1 kHz, THD 1%)										
Stereo (4 Ω)										120 W x 2
Stereo (6 Ω)	130 W x 2									
Stereo (8 Ω)		110 W x 2 (THD 1%)	100 W x 2 (THD 1%)	100 W x 2 (THD 1%)	100 W x 2 (THD 1%)	100 W x 2 (THD 1%)	80 W x 2 (THD 1%)	30 W + 30 W	80 W x 2 (THD 0.9%)	75 W x 2
Surround										
Front Channels	130 W x 2 (6 Ω)	110 W x 2 (8 Ω, THD 1%)	100 W x 2 (8 Ω, THD 1%)	100 W x 2 (8 Ω, THD 1%)	100 W/ch* x 2 (8 Ω, THD 1%)	100 W/ch* x 2 (8 Ω, THD 1%)	80 W/ch* x 2 (8 Ω, THD 1%)	30 W/ch	80 W/ch* x 2 (8 Ω, THD 0.9%)	
Centre Channel	130 W (6 Ω)	110 W (8 Ω, THD 1%)	100 W (8 Ω, THD 1%)	100 W (8 Ω, THD 1%)	100 W (8 Ω, THD 1%)	100 W (8 Ω, THD 1%)	80 W (8 Ω, THD 1%)	30 W	80 W (8 Ω, THD 0.9%)	
Rear Channels	130 W x 2 (6 Ω)	110 W x 2 (8 Ω, THD 1%)	100 W x 2 (8 Ω, THD 1%)	100 W x 2 (8 Ω, THD 1%)	100 W/ch* x 2 (8 Ω, THD 1%)	100 W/ch* x 2 (8 Ω, THD 1%)	80 W/ch* x 2 (8 Ω, THD 1%)	30 W/ch	80 W/ch* x 2 (8 Ω, THD 0.9%)	
Surround Back Channel					100 W (8 Ω, THD 1%)					
Total Harmonic Distortion (20 - 20,000 Hz, 8 Ohms)	0.09 %	0.09 %	0.09 %	0.09 %						0.05 %
Input (Sensitivity/Impedance)										
PHONO (MM)	4.7 mV/47 kΩ	4.7 mV/47 kΩ	4.7 mV/47 kΩ							
CD, TUNER, AUX, TAPE	335 mV/47 kΩ									
CD, LINE, TAPE, VCR, LD (LDP)		335 mV/47 kΩ	335 mV/47 kΩ	335 mV/47 kΩ	200 mV/47 kΩ	200 mV/47 kΩ	200 mV/47 kΩ		200 mV/47 kΩ	0.7 V/50 kΩ
DVD, VCR, TV/SAT, FRONT								200 mV/47 kΩ		
Frequency Response										
PHONO (MM)	20-20,000 Hz ±0.3 dB	20-20,000 Hz ±0.3 dB	20-20,000 Hz ±0.3 dB							
CD, TUNER, AUX, TAPE	5-100,000 Hz, +0 dB, -3 dB									
CD, LINE, TAPE		5-100,000 Hz, +0 dB, -3 dB	5-100,000 Hz, +0 dB, -3 dB	5-100,000 Hz, +0 dB, -3 dB	5-100,000 Hz, +0 dB, -3 dB	5-100,000 Hz, +0 dB, -3 dB	5-100,000 Hz, +0 dB, -3 dB		5-100,000 Hz, +0 dB, -3 dB	5-100,000 Hz, +0 dB, -3 dB
DVD, VCR, TV/SAT, FRONT								5 Hz-100,000 Hz, +0 dB, -3 dB		
Signal-to-Noise Ratio (DIN; continuous rated power output/50 mW)										
PHONO (MM)	68/61 dB	68/61 dB	68/61 dB							
CD, TUNER, AUX, TAPE	92/65 dB									
DVD, VCR, TV/SAT, FRONT		92/65 dB	92/65 dB	92/65 dB	88/64 dB	88/64 dB	88/64 dB	88/64 dB	88/64 dB	
FM TUNER SECTION										
Usable Sensitivity (Mono)										
		15.2 dBf, IHF (1.6 μV/75 Ω)	15.2 dBf, IHF (1.6 μV/75 Ω)	15.2 dBf, IHF (1.6 μV/75 Ω)	15.2 dBf, IHF (1.6 μV/75 Ω)	15.2 dBf, IHF (1.6 μV/75 Ω)	15.2 dBf, IHF (1.6 μV/75 Ω)	15.2 dBf, IHF (1.6 μV/75 Ω)	15.2 dBf, IHF (1.6 μV/75 Ω)	15.2 dBf, IHF (1.6 μV/75 Ω)
Sensitivity (DIN)										
Mono (26 dB S/N, 75 Ω)		1.1 μV	1.1 μV	1.1 μV	1.1 μV	1.1 μV	1.1 μV	1.1 μV	1.1 μV	1.1 μV
Stereo (46 dB S/N, 75 Ω)		50 μV	50 μV	50 μV	50 μV	50 μV	50 μV	50 μV	50 μV	50 μV
Signal-to-Noise Ratio										
Mono (DIN)		62 dB	62 dB	62 dB	62 dB	62 dB	62 dB	62 dB	62 dB	62 dB
Stereo (DIN)		58 dB	58 dB	58 dB	58 dB	58 dB	58 dB	58 dB	58 dB	58 dB
Stereo Separation (1 kHz)		40 dB (1kHz)	40 dB (1kHz)	40 dB (1kHz)	40 dB (1kHz)	40 dB (1kHz)	40 dB (1kHz)	40 dB	40 dB (1kHz)	40 dB (1kHz)
VIDEO SECTION										
Input (Sensitivity/Impedance)										
	1 V p-p/75 Ω	1 V p-p/75 Ω	1 V p-p/75 Ω	1 V p-p/75 Ω	1 V p-p/75 Ω	1 V p-p/75 Ω	1 V p-p/75 Ω	1 V p-p/75 Ω	1 V p-p/75 Ω	1 V p-p/75 Ω
MISCELLANEOUS										
Power Requirements										
	AC 220 - 230 V (UK 230 V) 50/60 Hz	AC 220 - 230 V (UK 230 V) 50/60 Hz	AC 220 - 230 V (UK 230 V) 50/60 Hz	AC 220 - 230 V (UK 230 V) 50/60 Hz	AC 220 - 230 V (UK 230 V) 50/60 Hz	AC 220 - 230 V (UK 230 V) 50/60 Hz	AC 220 - 230 V (UK 230 V) 50/60 Hz	AC 220 - 230 V (UK 230 V) 50/60 Hz	AC 220 - 230 V (UK 230 V) 50/60 Hz	AC 220 - 230 V (UK 230 V) 50/60 Hz
Power Consumption	500 W	400 W	400 W	400 W	280 W	250 W	220 W	130 W	220 W	220 W
Dimensions (W x H x D)	420 x 173 x 470 mm	420 x 173 x 470 mm	420 x 173 x 463 mm	420 x 173 x 463 mm	420 x 158 x 401 mm	420 x 158 x 401 mm	420 x 158 x 391 mm	420 x 65 x 300 mm	420 x 158 x 391 mm	420 x 128 x 319 mm
Weight	18.0 kg	16.2 kg	17.6 kg	16.2 kg	10.5 kg	9.5 kg	8.7 kg	5.2 kg	8.4 kg	7.6 kg

*Total using one channel.

Digital Home Cinema Systems Rear Panels

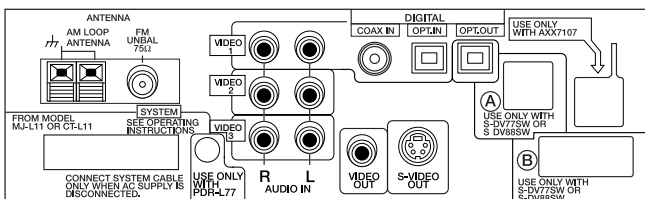

NS-DV88/NS-DV77

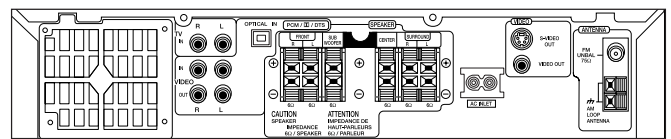

DCS-100

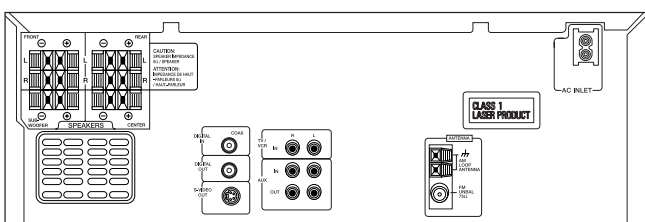

HTD-5

A/V Amplifiers & Receivers Rear Panels

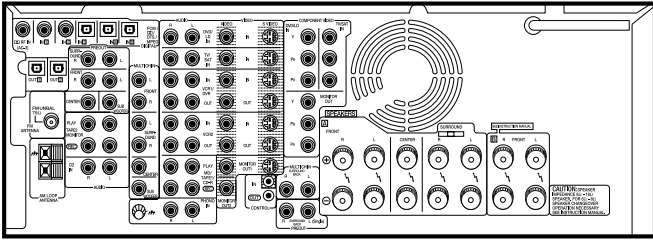

VSX-909RDS/VSX-909RDS-G - U.K. ONLY

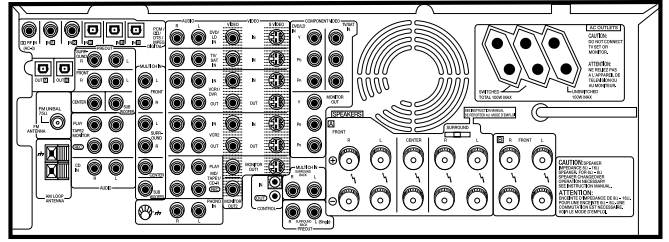

VSX-909RDS/VSX-909RDS-G - ALL EXCEPT U.K.

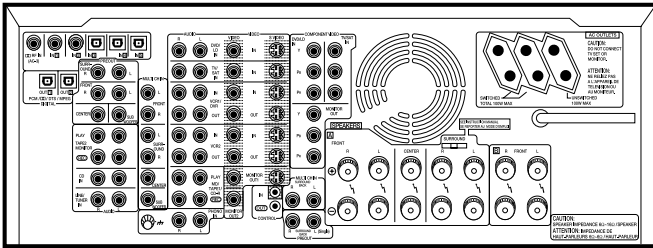

VSA-E08

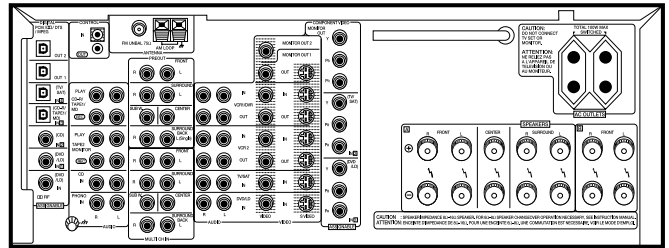

VSX-859RDS/VSX-859RDS-G

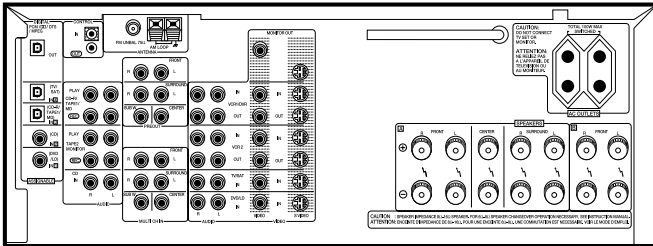

VSX-839RDS

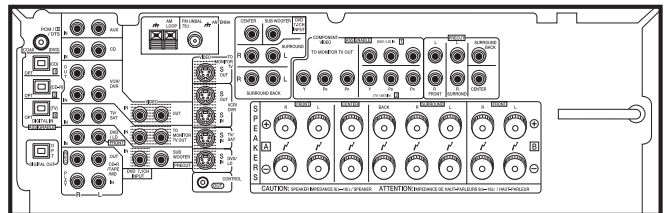

VSX-D810S

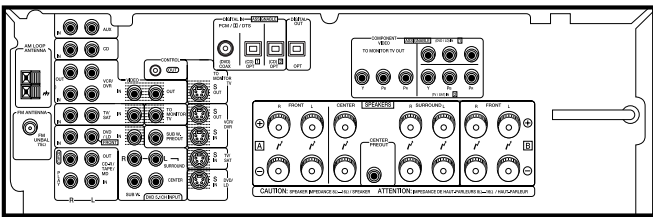

VSX-D710S

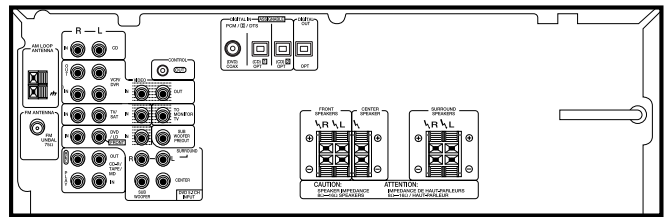

VSX-D510/VSX-D510-S

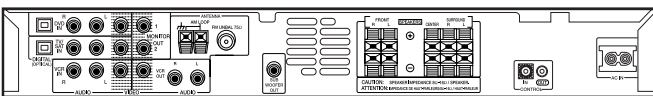

VSX-C300/VSX-C300-S

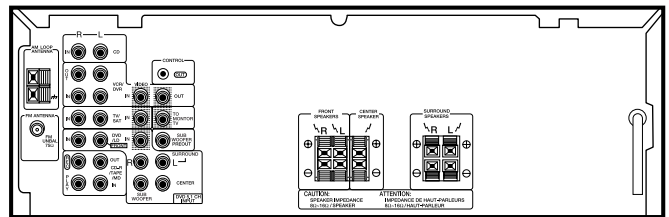

VSX-409RDS

A/V Speakers Specifications

	S-V310	S-V320	S-V310-W	S-V220/ S-V220-W	S-V70	S-V59-K
SYSTEM						
Centre speakers	compact	compact	compact	compact	compact	compact
Front speakers	floor-standing	floor-standing	floor-standing	floor-standing	satellite	satellite
Rear speakers	satellite	satellite	satellite	satellite	satellite	satellite
Magnetically shielded for video use	•	•	•	•	•	•
Front	14 cm cone woofer (x3), 2.5 cm dome tweeter	14 cm cone woofer (x2), 2.5 cm dome tweeter	14 cm cone woofer (x2), 2.5 cm dome tweeter	13 cm cone woofer, 7 cm cone midrange, 2.5 cm dome tweeter	7.7 cm cone woofer (x2), 2 cm dome tweeter	10 cm dual-cone
Centre	10 cm cone woofer (x2), 2.5 cm dome tweeter	10 cm dual-cone (x2)	8.3 cm cone woofer (x2), 2.5 cm dome tweeter	8.3 cm cone woofer (x2), 2.5 cm dome tweeter	7.7 cm cone woofer (x2), 2 cm dome tweeter	10 cm cone woofer (x2), 2.5 cm dome tweeter
Rear	10 cm dual-cone	10 cm dual-cone	8.3 cm cone type	8.3 cm cone type	7.7 cm cone woofer (x2), 2 cm dome tweeter	10 cm dual-cone
Subwoofer Module					22 cm cone woofer	22 cm cone woofer
Front Bass-reflex type enclosure	•	•	•	•	•	•
Built-in Amplifier	•	•	•	•	•	•
Stereo (Screw Terminal)	•	•	•	•	•	•
Mono (Pin Jack)	•	•	•	•	•	•
Power Consumption (for max. output power)					65.5 W	65.5 W
Power Requirements					AC 220 — 230 V 50/60 Hz	AC 220 — 230 V 50/60 Hz
Input Sensitivity/Impedance (100 Hz)					1.6 V + 1.6 V/15 kΩ*	1.6 V + 1.6 V/15 kΩ*
Speaker level					160 mV/50 kΩ	160 mV/50 kΩ
Line level (RCA Jack)						
Impedance	8 Ω	8 Ω	8 Ω	8 Ω		
Frequency Range	30 — 35,000 Hz (front) 60 — 20,000 Hz (rear) 60 — 35,000 Hz (centre)	35 — 35,000 Hz (front) 60 — 20,000 Hz (rear) 60 — 20,000 Hz (centre)	35 — 35,000 Hz (front) 120 — 20,000 Hz (rear) 70 — 21,000 Hz (centre)	40 — 20,000 Hz (front) 120 — 20,000 Hz (rear) 70 — 21,000 Hz (centre)	60 — 40,000 Hz (front) 60 — 40,000 Hz (rear) 62 — 42,000 Hz (centre) 50 — 200 Hz (subw)	60 — 20,000 Hz (front) 60 — 20,000 Hz (rear) 60 — 35,000 Hz (centre) 50 — 200 Hz (subw)
Sensitivity (1 m/W)	90 dB/W	90 dB/W	90 dB/W (front) 89 dB/W (rear, centre)	89 dB/W	89 dB/W	90 dB/W
Music Power (DIN)	100 W	100 W (front) 80 W (rear, centre)	100 W (front) 80 W (rear, centre)	80 W	130 W (satellite) 110 W (subw)	100 W (satellite) 110 W (subw)
DIMENSIONS (W x H x D)						
Front	251 x 1,030 x 422 mm (with base) 185 x 1,000 x 390 mm (without base)	240 x 925 x 345 mm (with base) 184 x 900 x 318 mm (without base)	240 x 925 x 345 mm (with base) 184 x 900 x 318 mm (without base)	180 x 850 x 230 mm	150 x 300 x 70 mm	150 x 190 x 90 mm
Rear	150 x 190 x 90 mm	158 x 202 x 140 mm	126 x 126 x 136 mm	126 x 126 x 136 mm	300 x 150 x 70 mm	150 x 190 x 90 mm
Centre	440 x 150 x 110 mm	390 x 158 x 140 mm	330 x 106 x 165 mm	330 x 106 x 165 mm	150 x 300 x 70 mm	440 x 150 x 110 mm
Subwoofer					250 x 480 x 384 mm	250 x 480 x 384 mm
WEIGHT						
Front	18.5 kg	11.5 kg	11.5 kg	6 kg	2.7 kg	1.3 kg
Rear	1.3 kg	1.3 kg	1 kg	1 kg	2.7 kg	1.3 kg
Centre	3 kg	2.4 kg	2.5 kg	2.5 kg	2.7 kg	3 kg
Subwoofer					14 kg	14 kg

* Both channel in phase

A/V Speakers Specifications

	S-V50-K/ S-V50-QL	S-V59	S-V31/ S-V31-W	S-W80S-K/ S-W80S-QL
SYSTEM				
Centre speakers	compact	compact	compact	
Front speakers	satellite	satellite	satellite	
Rear speakers	satellite	satellite	satellite	
Magnetically shielded for video use	•	•	•	•
Front	5.2 cm cone woofer (x2)	10 cm dual-cone	10 cm cone woofer, 2.5 cm dome tweeter	
Centre	5.2 cm cone woofer (x2)	10 cm dual-cone (x2)	8.3 cm cone woofer (x2), 2.5 cm dome tweeter	
Rear	5.2 cm cone woofer (x2)	10 cm dual-cone	8.3 cm cone type	
Subwoofer Module	22 cm cone woofer	14 cm cone woofer (x2)	22 cm cone woofer	22 cm cone woofer
Front Bass-reflex type enclosure	•	•	•	•
Built-in Amplifier	•	•	•	•
Stereo (Screw Terminal)	•	•	•	•
Mono (Pin Jack)	•	•	•	•
Power Consumption (for max. output power)	65.5 W		65.5 W	65.5 W
Power Requirements	AC 220 — 230 V 50/60 Hz		AC 220 — 230 V 50/60 Hz	AC 220 — 230 V 50/60 Hz
Input Sensitivity/Impedance (100 Hz)				
Speaker level	1.6 V + 1.6 V/15 kΩ*		1.6 V + 1.6 V/15 kΩ*	1.6 V + 1.6 V/15 kΩ*
Line level (RCA Jack)	160 mV/50 kΩ		160 mV/50 kΩ	160 mV/50 kΩ
Impedance		8 Ω		
Frequency Range	90 — 20,000 Hz (front) 90 — 20,000 Hz (rear) 80 — 20,000 Hz (centre) 50 — 200 Hz (subw)	120 — 20,000 Hz (front) 60 — 20,000 Hz (rear) 60 — 35,000 Hz (centre) 50 — 200 Hz (subw)	100 — 23,000 Hz (front) 120 — 20,000 Hz (rear) 70 — 21,000 Hz (centre) 50 — 200 Hz (subw)	50 — 200 Hz
Sensitivity (1 m/W)	88 dB/W	90 dB/W (sat) 80 dB/W (subw)	89 dB/W	
Music Power (DIN)	100 W (satellite) 110 W (subw)	80 W	80 W (satellite) 110 W (subw)	110 W
DIMENSIONS (W x H x D)				
Front	130 x 200 x 59 mm	158 x 202 x 140 mm	140 x 200 x 152 mm	
Rear	130 x 200 x 59 mm	158 x 202 x 140 mm	126 x 126 x 136 mm	
Centre	240 x 94 x 97 mm	390 x 158 x 140 mm	330 x 106 x 165 mm	
Subwoofer	250 x 480 x 384 mm	185 x 400 x 256 mm	250 x 480 x 384 mm	250 x 480 x 384 mm
WEIGHT				
Front	0.9 kg	1.3 kg	1.8 kg	
Rear	0.9 kg	1.3 kg	1 kg	
Centre	0.9 kg	2.4 kg	2.5 kg	
Subwoofer	14 kg	5 kg	14 kg	14 kg

* Both channel in phase

Plasma TV Features

PDP-503HDE

PICTURE	
Screen Size	50 inch
Aspect Ratio	16:9
Number of Pixels	1,280 (Hor) x 768 (Ver)
Brightness	900 cd/m ²
Contrast Ratio	900:1
Viewing Angle	more than 160° (Hor/Ver)
3 Line Digital Comb Filter	PAL/NTSC-M (Main & Sub)
Video Signals	PAL/SECAM/NTSC3.58/NTSC4.43/PAL60
PC Signals	VGA/SVGA/XGA/Wide XGA
Dual Screen	•
Still Picture (Sub Screen)	•
Digital Enhancer Hor / Ver	• / •
100 Hz Progressive Scan	•
CTI (Colour Transient Improvement)	•
Dynamic Gamma Correction	•
Black Level Expansion	• (3 steps)
Colour Temperature Adjustment	• (5 steps)
PureCinema*	• (On / Off)
Black & White Mode	• (On / Off)
AV Selection (Programmed Picture)	• (STD/Dynamic/Movie/Game/User)
TUNER	
Reception System	B/G, I, D/K, L, L'
Stereo / Dual Sound	NICAM UK/SK/FR, CCIR A2 B/G, D/K
Auto Channel Preset	•
Auto Channel Labeling	•
Auto Channel Sort	•
Number of Preset Channels	99
Teletext	CEEFAX/FLOF/TOP (with TOP Over View Page)
Number of Languages	25
Page Memory	252 pages
Picture and Text (Dual Screen)	•
CONTROL	
OSD	High Quality Font
Number of Languages	12 (GB/D/F/NL/I/E/P/S/FIN/GR/TR/RUS)
Remote Controller	SR
Energy Save mode (for AV and PC)	•
Auto Power Off (for AV)	•
Power Management (for PC)	•
i/oLink.A	•
AUDIO	
Audio Output Power	12 W + 12 W (Music Power, 8 ohms)
Tone Control	Bass, Treble, Balance
Surround Sound	FOCUS**, SRS**
CONNECTION TERMINALS	
Input 1 (SCART)	AV In, RGB In, TV Out
Input 2 (SCART)	AV In/Out, S Input, i/oLink.A
Input 3 (SCART/ Component)	AV In/Out, RGB In, S in, Y/Pb/Pr In (RCA pin)
Monitor Out (RCA pin)	AV Out, S Out
Input 4 (Front)	AV Input, S Input
PC (Front)	D-sub15 In, Stereo Mini jack (Audio)
SR Control In/Out	Mini Jack x 2
Others	Antenna terminal (DIN) System Connection x 2 (for connecting PDP-503PE and media receiver) Speaker Out L/R (Display Rear, 8 – 16 ohms)
GENERAL	
Dimensions	
Display (W x H x D)	1218 x 714 x 98 mm
Media Receiver (W x H x D)	420 x 70 x 330 mm
Weight	
Display	38.9 kg
Media Receiver	4.4 kg
Power Consumption	395 W
Power Requirements	AC 220-240 V, 50/60 Hz

*NTSC only

**FOCUS and SRS are trademarks of SRS Labs, Inc.

Options: Optional fitted side-mount speakers: PDP-So6-LR and Mounting brackets for flexible installation available (Table top stand: PDK-TSo1, Angled wall bracket: PDK-5011 and Wall bracket: PDK-5013)

CD Recorders Features - 1

	PDR-W839	PDR-609	PDR-F10
DRIVE			
CD-R	Single-tray	Single-tray	Self Chuck type
CD	3-CD	—	—
Applicable Discs	CD/CD-R/CD-RW	CD/CD-R/CD-RW	CD/CD-R/CD-RW
DIGITAL FEATURES			
D/A Converter	24-bit D/A Converter	24-bit D/A Converter	Digital Filter D/A Converter
A/D Converter	24-bit A/D Converter	24-bit A/D Converter	
Legato Link Conversion	•	•	
Sampling Rate Converter	•	•	•
STRUCTURAL FEATURES			
High Rigidity Chassis	•	•	
Clean Laser Pickup Circuit	•	•	
Three-Beam Differential Push-Pull Pickup	•	•	
RECORDING FEATURES			
Z-Concept	•	•	•
Erase (CD-RW disc)			
Last Track	•	•	•
All-Track	•	•	•
Multi Track	•	•	•
Disc	•	•	•
TOC (Unfinalise)	•	•	•
Track Skip ID Input	•	•	•
Digital Recording Level Control (dB)	• (-∞ ~ +20)	• (-∞ ~ +20)	• (-86 ~ +20)
Digital Recording Balance Control	•	•	
Digital Synchro Recording (Ext. Input)			
1-Track	•	•	
All-Track	•	•	
All-Track + Auto Finalise	•	•	
DAT ID Synchro	•	•	
Category Code Display (Digital input)	•	•	•
Analogue Synchro Recording (Ext. Input)			
1-Track	•	•	
All-Track	•	•	
All-Track + Auto Finalise	•	•	
Auto Synchro Start Level Adjustment	•	•	
Audio Buffer	•	•	•
Auto Stop Delay	•	•	•
Rec Mute	•	•	
Auto Track Increment	•	•	•
Auto Track Increment Level Adjustment(Digital)	-24 ~ 78 dB (6 dB Step)	-24 ~ 78 dB (6 dB Step)	
Auto Track Increment Level Adjustment(Analogue)	-24 ~ 66 dB (6 dB Step)	-24 ~ 66 dB (6 dB Step)	
Auto Time Increment	• (1, 3, 5 Seconds)	• (1, 3, 5 Seconds)	• (1, 3, 5 Seconds)
Manual Track Increment	•	•	•
Input Selector (Digital [Coaxial/Optical]/Analogue)	• (Coax/Opt/Analogue)	• (Coax/Opt/Analogue)	• (Optical/Analogue)
Finalise (TOC Write)	•	•	•
Sampling Monitor	•	•	
Fade-in/Fade out	• (1 ~ 125sec)	• (1 ~ 125sec)	
SCMS (Serial Copy Management System)	•	•	•
Previous Monitor	•	•	
Copy (Internal)			
1 x Copy: Digital/Analogue	•/•	•/•	•/•
2 x Copy: Digital/Analogue	•/•	•/•	•/•
Auto SCMS Copy	•	•	•
One Touch Copy	•	•	•
1-Track	•	•	•
1-Disc	•	•	•
Program	•	•	•
REC THIS	•	•	•
Auto Space	•	•	•
Rec Volume Control	•	•	•
Rec Balance Control	•	•	•
Playback Before Copy Executing	•	•	•
CD Text Display	•	•	•
CD Text Input			
Characters	Caps/Small/Mark/Numeric	Caps/Small/Mark/Numeric	Caps/Small/Mark/Numeric
Disc Name	•	•	•
Artist Name	•	•	•
Track Name	•	•	•
Name Clip	• (3 Names)	• (3 Names)	• (3 Names)
Name Memory	• (3 Discs)	• (3 Discs)	• (3 Discs)

CD Recorders Features - 2

	<i>PDR-W839</i>	<i>PDR-609</i>	<i>PDR-F10</i>
PLAYBACK FUNCTIONS			
Z-Concept	•	•	•
Direct Track Search	•	•	•
Manual/Track Search	•	•	•
Index Search	•	•	•
Direct Song Selection	•	•	•
Random Play	• (Multi Disc OK)	•	•
Programmed Play	•	•	•*
Talk-Back Input	•	•	•
Direct Program	•	•	•
Programme Check	•	•	•
Programme Clear	•	•	•
Repeat Play	•	•	•
1-Track, All-Track	•	•	•
Programmed, Random	•	•	•
Relay play	• (CD1/CD2/CD3/CD-R)	•	•
Skip Play	•	•	•
Fade-In/Fade-Out	• (1 ~ 12sec)	• (1 ~ 12sec)	•
Timer Play	•	•	•
DISPLAY			
Level Meter	• (14 seg/ch)	• (14 seg/ch)	•
Remaining Recording Time	•	•	•
Display On/Off (Dimmer)	•	•	•
Time Display Switching	•	•	•
TERMINALS			
Optical Digital Input/Output	1/1	1/1	1/1
Coaxial Digital Input/Output	1/1	1/1	1/1
Line Input/Output	1/1	1/1	1/1
Headphone Jack	1	1	1
Keyboard Terminal	1	1	1
Control Input	1	1	1
TEXT Control	1	1	1

* With Remote Control

CD Recorders Specifications

	<i>PDR-W839</i>	<i>PDR-609</i>	<i>PDR-F10</i>
COMPACT DISC RECORDER			
Number of Channels	2	2	2
Frequency Response	2 – 20,000 Hz	2 – 20,000 Hz	2 – 20,000 Hz
Sampling Frequency (Recording/Playback)	44.1 kHz	44.1 kHz	44.1 kHz
Signal-to-Noise Ratio			
Recording	92 dB	92 dB	92 dB
Playback	112 dB	112 dB	110 dB
Dynamic Range (EIA)			
Recording	92 dB	92 dB	92 dB
Playback	98 dB	98 dB	98 dB
Total Harmonic Distortion (1 kHz)			
Recording	0.004 %	0.004 %	0.005 %
Playback	0.0017 %	0.0017 %	0.002 %
MISCELLANEOUS			
Power Requirements			
Power Consumption	17 W	13 W	
Dimensions (W x H x D)	420 x 128 x 380 mm	420 x 105 x 295 mm	205,5 x 68 x 268 mm
Weight	5,7 kg	3,5 kg	2 kg
COMPACT DISC PLAYER			
Frequency Response	2 – 20,000 Hz		
Signal-to-Noise Ratio	112 dB		

MiniDisc Recorders Features

	MJ-D508	MJ-L11
DIGITAL FEATURES		
Legato Link Conversion	•	
RECORDING FUNCTIONS		
Recording Volume Control		
Analogue	• (single)	
Digital	• (full fs)	
Fader (5 sec.)	• (full fs)	
Digital REC Volume Memory	•	
Sampling Rate Converter	•	
Advanced Parameter Processing	•	
Digital NR (Noise Reduction)	•	
Monaural Long Time Mode	•	
Level Synchro Recording (1-Track/All)	•	
Space Cut	•	
Automark (3-step)	•	
Recovery Recording (6 sec.)	•	
Timer Recording	•	
PLAYBACK OPTIONS		
Digital NR (Noise Reduction)	•	
Fader (5 sec.)	•	
DAC Mode (Digital Volume/Digital NR)	•	
Monaural x 2 Playback	•	
Time Skip (60/15 sec.)	•	
Medley Playback (Fade-out: 2 sec/Cut: 10 sec.)	•	
Programme Play	30	24
Random Play	•	•
Repeat Play (1/All/A-B)	•	•
A-B Repeat	•	
Timer Play (Fader/Programme)	•	
EDIT FUNCTIONS		
Title Input (Name Input)	• (40 x 3 names)	
Move (Track/Programme)	•	
Combine (Track/A-B)	•	
Divide	•	
Erase (All/1-track/A-B)	•	
Undo	•	
UTOC Write	•	
TERMINALS		
Analogue Input (RCA Pin Jack)	1	
Digital Input (Optical/Coaxial)	1/1	1/0
Analogue Output (RCA Pin Jack)	1	
Digital Output (Optical)	1	
Headphone Output (with Volume)	1	

MiniDisc Recorders Specifications

	MJ-D508	MJ-L11
Frequency Response	8 — 20,000 Hz	20 — 20,000 Hz
Signal-to-Noise Ratio (EIA)	100 dB	96 dB
Power Requirements	220 — 230 V 50 — 60 Hz	220 — 230 V 50 — 60 Hz
Power Consumption	15 W	11 W
Dimensions (W x H x D)	420 x 105 x 294 mm	220 x 65 x 313 mm
Weight	3.5 kg	2.5 kg

Note: MD LP discs will only play on MD LP compatible players.

CD File-Type Players & Multi CD Players Features

	PD-F1009	PD-F1007	PD-F958	PD-F706	PD-F607	PD-M426	PD-M406	PD-M603 (UK only)
FORMAT								
Separate Single-Disc Slot (S = Single Loader)	• (S)	• (S)	• (S)	•				
Disc Capacity	301	301	101	25+1	25	6	6	6
WIDE-RANGE TECHNOLOGY								
Legato Link Conversion	•	•						
DIGITAL FEATURES								
1-Bit DLC with Pulseflow D/A Converter	•**	•**	•	•	•	•	•	•
LOW-NOISE DESIGNS								
Low-Loss Laser Pickup	•	•	•	•	•	•	•	•
PLAYBACK OPTIONS								
Playback Modes								
Single Disc	•	•	•	•	•			
All Discs	•	•	•	•	•	•	•	•
"Custom File" Discs	•	•	•	•	•			
Random Play Modes								• (2)
Single Disc	•	•	•	•	•			
All Discs	•	•	•	•	•			
"Custom File" Discs	•	•	•	•	•			
Programmed Play (Tracks/Discs)	36	36	36	24	32	32	32	32
Total Time Display	•	•	•	•	•			
Repeat Modes	8	8	8	8	8	4	4	7
Single Track	•	•	•	•	•	•	•	
Single Disc	•	•	•	•	•			
All Discs	•	•	•	•	•	•	•	
"Custom File" Discs	•	•	•	•	•			
Single Disc Random	•	•	•	•	•			
All Discs Random	•	•	•	•	•	•	•	
"Custom File" Discs Random	•	•	•	•	•			
Programmed Tracks	•	•	•	•	•	•	•	
CONVENIENCES								
"Custom Filing"	• (5)	• (10)	• (3)	• (3)	• (3)			
CD Text	•	•	•	•	•			
Title Input	•	•	•	•	•			
CD-Deck Synchro	•	•	•	•	•			•
Full Function Remote Control with Power On/Off	•	•	•	•	•	•	•	•
Previous Disc Scan	• (20)	• (20)	• (20)	• (15)	• (15)			
Best Selection Memory	• (20)	• (50)	• (20)	• (15)	• (15)			
Hi-Lite Scan with Programmed Play	•	•	•	•	•			
Memory Backup	•	•	•	•	•			
Memory Hold	•	•	•	•	•			•
Last Disc Memory	•	•	•	•	•	•	•	•
Magazine Hi-Lite Scan	•	•	•	•	•	•	•	•
Jog Dial	•	•	•	•	•			
Powered Door	•	•	•	•	•			
Direct Track Access by Number Keypad	•	•*	•*	•*	•*			•
Timer Play (Timer Optional)								•
Auto Power-On/Power-Down Eject (Single Disc Slot)				•			•	
Liner-Notes File			1	1	1			
TERMINALS								
Optical Digital Output	•	•	•	•	•			•
SR (System Remote) Terminal	• (In)		• (In)					
One More 300CD's Connect		•						
I/O Interface Terminals			•					
Headphone Output with Volume Control		•	•	•	•			•
Keyboard Input		•						
ANTI-RESONANCE AND ANTI-VIBRATION DESIGNS								
Honeycomb Chassis						•	•	•
Large Insulators	•	•	•	•	•	•	•	•

* Remote control

** Without pulseflow

CD File-Type Players & Multi CD Players Specifications

	PD-F1009	PD-F1007	PD-F958	PD-F706	PD-F607	PD-M426	PD-M406	PD-M603 (UK only)
Frequency Response	2 – 20,000 Hz	2 – 20,000 Hz	2 – 20,000 Hz	2 – 20,000 Hz	2 – 20,000 Hz	2 – 20,000 Hz	2 – 20,000 Hz	2 – 20,000 Hz
Signal-to-Noise Ratio (EIA)	105 dB	98 dB	98 dB	98 dB	98 dB	98 dB	98 dB	102 dB
Dynamic Range (EIA)			96 dB	96 dB	95 dB	95 dB	96 dB	
Channel Separation (EIA)							95 dB	
Distortion (EIA)			0.003 %	0.003 %	0.005 %	0.005 %	0.003 %	
Power Requirements			220 – 240 V, 50 – 60 Hz	220 – 240 V, 50 – 60 Hz	220 – 240 V, 50 – 60 Hz	220 – 240 V, 50 – 60 Hz	220 – 240 V, 50 – 60 Hz	
Power Consumption	12 W			14 W	13 W	12 W	12 W	13 W
Dimensions (W x H x D)	420 x 193 x 433 mm	420 x 193 x 433 mm	420 x 193 x 402 mm	420 x 190 x 316 mm	420 x 193 x 312 mm	420 x 105 x 294 mm	420 x 105 x 294 mm	420 x 105 x 299 mm
Weight	7.5 kg	8 kg	6.5 kg	5 kg	4.8 kg	3.7 kg	3.7 kg	3.8 kg

CD Players Features

	PD-S707	PD-S507	PD-207
FORMAT			
Disc Capacity	1	1	1
WIDE-RANGE TECHNOLOGY			
Hi-bit Legato Link Conversion	•	•	
DIGITAL FEATURES			
DAC 24 (Jitter Proof 24-bit D/A Converter)	•	•	
1-Bit DLC with D/A Converter			•
STRUCTURAL DESIGNS			
Stable Platter Mechanism	•	•	
Centre Tray Mechanism	•	•	•
LOW-NOISE DESIGNS			
Accurate Transmission System	•	•	
Low-Loss Laser Pickup	•	•	•
Display Off Switch	•	•	•
PLAYBACK OPTIONS			
Edit Modes			
Compu-PGM	•	•	•
Auto Programme	•	•	•
Random Play Modes	•*	•*	•
Programmed Play (Tracks/Discs)	24	24	24
Repeat Modes	• (6)	• (6)	• (6)
CONVENIENCES			
Time Location	•*	•*	
CD-Deck Synchro	•	•	•
Remote Control Unit with Power On/Off	•	•	•
Talk-Back Input	•	•	•
Memory Hold	•	•	•
Digital Level Control	•*	•*	•
Hi-Lite Scan	•	•	•
Jog Dial Track Search	•	•	•
Direct Track Access by Number Keypad	•*	•*	•
Timer Play (Timer Optional)	•	•	•
Music Calendar	•	•	•
TERMINALS			
Digital Output (O = Optical/C = Coaxial)	0	0	0
Digital Output On/Off	•	•	•
Headphone Output with Volume Control	•	•	•
ANTI-RESONANCE AND ANTI-VIBRATION DESIGNS			
Double Layered Chassis	•	•	•
Honeycomb Chassis	•	•	•
Large Insulators	•	•	•

* Remote control

CD Players Specifications

	PD-S707	PD-S507	PD-207
Frequency Response	2 – 20,000 Hz	2 – 20,000 Hz	2 – 20,000 Hz
Frequency Range Capability	2 – 40,000 Hz*	2 – 40,000 Hz*	
Signal-to-Noise Ratio (EIA)	110 dB	110 dB	98 dB
Dynamic Range (EIA)	99 dB	99 dB	96 dB
Distortion (EIA)	0.002 %	0.002 %	0.003 %
Power Requirements	220 – 230 V, 50 – 60 Hz	220 – 230 V, 50 – 60 Hz	220 – 230 V, 50 – 60 Hz
Power Consumption	14 W	13 W	12 W
Dimensions (W x H x D)	420 x 128 x 374 mm	420 x 112 x 283 mm	420 x 267 x 103 mm
Weight	7.2 kg	3.8 kg	2.7 kg

*With Hi-bit Legato Link Conversion

Integrated Amplifiers & Receivers Features - 1

	A-607R	A-509R	A-307R	A-209R	A-109	SX-209RDS
POWER OUTPUT						
DIN Continuous Power Output (1 kHz)						
4 Ω	120 W x 2	90 W x 2	80 W x 2	60 W x 2		50 W x 2
8 Ω	75 W x 2	60 W x 2	55 W x 2	45 W x 2	40 W x 2	
WIDE-RANGE TECHNOLOGY						
Wide-Range Linear Circuit	•	•	•	•	•	•
High Channel Separation Design	•	•	•	•	•	•
AUDIO FEATURES						
Direct Energy MOSFET Circuit	•	•	•	•	•	•
Low-Impedance Driving Capability	•	•	•	•	•	•

Integrated Amplifiers & Receivers Features - 2

	A-607R	A-509R	A-307R	A-209R	A-109	SX-209RDS
Muting	•					
Tone Controls	•	•	•	•	•	•
Loudness	•	•	•	•	•	•
ALL SOURCE DIRECT Switch						•
Large Insulators	•	•	•	•	•	•
CONSTRUCTION						
Advanced Direct Connection	•	•				
Symmetrical Construction	•	•	•	•	•	
Sound Stabilisers	•	•		•	•	
LOW-NOISE DESIGNS						
Toroidal Transformer	•					
Aero Wing Chassis	•	•	•	•	•	•
"Silent" Microprocessor System	•	•	•	•		
"DIRECT" Switch	•	•	•	•		
Local Off Circuit (Tone/Phono)	•	•	• (Phono)	• (Phono)	• (Phono)	
HIGH-QUALITY PARTS						
Complementary Capacitor Pair	•	•	•	•	•	
Speaker A/B Switching Relay	•	•	•	•	• (only A)	
Motor-Driven Volume Control	•	•	•	•		
Input Switching Relay	CD, TAPE 1/MD	TAPE 1/ CD-R/MD				•
Gold-Plated CD/Phono Inputs	•					
RDS (RADIO DATA SYSTEM)						
EON information						•
TUNER						
Random Preset Stations						30
Direct Access Tuning						•
3-Speed Accelerated Tuning						•
CONVENIENCES						
SR (System Remote) Control Unit	•	•	•	•		•
Record Selector	•	•				
Two-Way Dubbing	•	•	•	•	•	
4-letter Station Memory						•
TERMINALS						
Audio Inputs	6	6	6	6	6	5
SR (System Remote) Terminal	•	•	•	•	•	•
Headphone Output	•	•	•	•	•	•
Speaker Outputs	2	2	2	2	1	
Discrete Outputs (All Channels)	•	•	•	•	•	•
A+B (Parallel)	•	•	•	•		•
A/B or A+B						•

Integrated Amplifiers & Receivers Specifications

	A-607R	A-509R	A-307R	A-209R	A-109	SX-209RDS
AMPLIFIER SECTION						
Power Output						
DIN (1 kHz, 4 Ω)	120 W x 2	90 W x 2	80 W x 2	60 W x 2		50 W x 2
DIN (1 kHz, 8 Ω)	75 W x 2	60 W x 2	55 W x 2	45 W x 2	40 W x 2	
Continuous Power Output						
20 — 20,000 Hz, 4 Ω	90 W x 2*	65 W x 2*	65 W x 2*	45 W x 2*		40 W x 2
20 — 20,000 Hz, 8 Ω	80 W x 2*	45 W x 2*	45 W x 2*	35 W x 2*	30 W x 2*	80 W/50 W
Dynamic Power Output (4/8 Ω)						
Total Harmonic Distortion (20 — 20,000Hz, 8 Ω, at -3 dB)	0.06 %*	0.05 %*	0.08 %*	0.08 %*	0.08 %*	0.09 %
Input (Sensitivity/Impedance)						
PHONO (MM)	2.8 mV/50 kΩ	2.8 mV/50 kΩ	2.8 mV/50 kΩ	2.8 mV/50 kΩ	2.8 mV/50 kΩ	2.5 mV/47 kΩ
CD, TUNER, AUX, TAPE	200 mV/50 kΩ	200 mV/50 kΩ	200 mV/50 kΩ	200 mV/50 kΩ	200 mV/50 kΩ	
CD, LINE, TAPE, VCR, LD (LDP)						200 mV/47 kΩ
Frequency Response						
CD, TUNER, AUX, TAPE	5 — 100,000 Hz* +0 dB, -3 dB	5 — 100,000 Hz* +0 dB, -3 dB	5 — 100,000 Hz* +0 dB, -3 dB	5 — 100,000 Hz* +0 dB, -3 dB	5 — 100,000 Hz* +0 dB, -3 dB	
CD, LINE, TAPE						5 — 100,000 Hz +0 dB, -3 dB
Signal-to-Noise Ratio (DIN; continuous rated power output/50 mW)						
PHONO (MM)	71 dB/67 dB*	71 dB/67 dB*	71 dB/67 dB*	71 dB/67 dB*	71 dB/67 dB*	67 dB/61 dB*
CD, TUNER, AUX, TAPE	95 dB/71 dB*	95 dB/71 dB*	91 dB/71 dB*	91 dB/71 dB*	91 dB/71 dB*	
CD, LINE, TAPE						82 dB/62 dB
FM TUNER SECTION						
Usable Sensitivity (Mono)						14.2 dBf (1.4 μV, 75 Ω)
Sensitivity (DIN)						
Mono (26 dB S/N, 75 Ω)						1.0 μV
Stereo (46 dB S/N, 75 Ω)						50 μV
Signal-to-Noise Ratio Mono/Stereo (DIN)						62 dB/58 dB
Stereo Separation (1 kHz)						40 dB
MISCELLANEOUS						
Power Requirements	220 — 230 V, 50 — 60 Hz	220 — 230 V, 50 — 60 Hz	220 — 230 V, 50 — 60 Hz	220 — 230 V, 50 — 60 Hz	220 — 230 V, 50 — 60 Hz	220 — 230 V, 50 — 60 Hz
Power Consumption	220 W	160 W	140 W	130 W	80 W	370 W (max)
Dimensions (W x H x D)	420 x 128 x 335 mm	420 x 128 x 335 mm	420 x 114 x 307 mm	420 x 114 x 307 mm	420 x 114 x 307 mm	420 x 140 x 313 mm
Weight	7 kg	6.9 kg	5.9 kg	4.7 kg	4.3 kg	5.4 kg

* Direct switch on

** On EIA test signal

Tuner Features

F-208RDS

AUDIO FEATURES	
RF Attenuator	•
FM Mono/Stereo Switch	•
ANTI-RESONANCE AND ANTI-VIBRATION DESIGNS	
Large Insulators	•
CONVENIENCES	
Rotary Tuning	•
Random Preset Stations	30
Class Memory	•
Memory Scan	•
4-Letter Station Name Memory	• (30)
Direct Access Tuning	•
SR (System Remote) Terminal	•

Tuner Specifications

F-208RDS

FM TUNER SECTION	
Usable Sensitivity (Mono)	14.2 dBf (1.4 µV, 75 Ω)
Sensitivity (DIN)	
Mono (26 dB S/N 75 Ω)	1.0 µV
Stereo (46 dB S/N 75 Ω)	35 µV
Signal-to-Noise Ratio	
Mono/Stereo (DIN)	62 dB/58 dB
Alternate Channel Selectivity	
±400 Hz	70 dB
Stereo Separation (1 kHz)	40 dB
MISCELLANEOUS	
Power Requirements	220 – 230V, 50 – 60Hz
Power Consumption	15W
Dimensions (W x H x D)	420 x 105 x 294 mm
Weight	3.5 kg

Cassette Decks Specifications

	CT-W806DR	CT-W706DR	CT-W606DR	CT-W505R	CT-W208R	CT-S250
Number of Motors	4	4	2	2	2	1
Type of Heads						
Playback Head		1	1	1	1	
Recording/Playback Head	2	1	1	1	1	1
Erasing Head	2	1	1	1	1	1
Wow and Flutter						
WRMS	0.09 %	0.09 %	0.09 %	0.09 %	0.09 %	0.07 %
DIN	±0.19 %	±0.19 %	±0.19 %	±0.19 %	±0.19 %	±0.18 %
Frequency Response (-20 dB)						
Type IV (Metal Tape)	2 – 20,000 Hz	20 – 20,000 Hz	20 – 20,000 Hz	20 – 16,500 Hz	20 – 16,500 Hz	20 – 18,000 Hz
Type II (Chrome Tape)	20 – 19,000 Hz	20 – 19,000 Hz	20 – 19,000 Hz	20 – 16,000 Hz	20 – 16,000 Hz	20 – 17,000 Hz
Type I (Normal Tape)	20 – 18,000 Hz	20 – 18,000 Hz	20 – 18,000 Hz	20 – 16,000 Hz	20 – 16,000 Hz	20 – 17,000 Hz
Signal-to-Noise Ratio						
Digital NR (with Dolby B/C NR)	90 dB	90 dB	90 dB			
Digital NR (without Dolby NR)	82 dB	82 dB	82 dB			
Digital NR/Dolby NR Off	57 dB	57 dB	57 dB	57 dB	57 dB	57 dB
Power Requirements	220 – 230 V, 50 – 60 Hz	220 – 230 V, 50 – 60 Hz	220 – 230 V, 50 – 60 Hz	220 – 230 V, 50 – 60 Hz	220 – 230 V, 50 – 60 Hz	220 – 230 V, 50 – 60 Hz
Power Consumption	25 W	19 W	19 W	17 W	16 W	16 W
Dimensions (W x H x D)	420 x 125 x 250 mm	420 x 125 x 250 mm	420 x 125 x 250 mm	420 x 125 x 250 mm	420 x 125 x 250 mm	420 x 125 x 280 mm
Weight	4.7 kg	4.4 kg	4.4 kg	4 kg	3.8 kg	3.5 kg

Cassette Decks Features

	CT-W806DR	CT-W706DR	CT-W606DR	CT-W505R	CT-W208R	CT-S250
WIDE-RANGE TECHNOLOGY						
20-bit A/D-D/A Converter	•	•	•			
Legato Link Conversion	•	•				
MECHANICAL FEATURES						
Centre Mount Design						•
AUDIO FEATURES						
Digital Noise Reduction	•	•	•			
FLEX (Frequency Level Expander)	• (digital)	• (digital)	• (digital)	•		•
ALCA (Auto Level Control with Tape Analysis)	• (digital)			•		
TDNS (Tape Duplication Noise Suppressor)	• (digital)	• (digital)	• (digital)	•		
Super Auto BLE XD	• (digital)	• (digital)	• (digital)			
Auto BLE				•		
Dolby Noise Reduction	B/C	B/C	B/C	B/C	B/C	B/C
Dolby HX Pro	•	•	•	•		
LOW-NOISE FEATURES						
Display Off Switch						•
ANTI-RESONANCE AND ANTI-VIBRATION DESIGNS						
Honeycomb Chassis	•	•	•	•	•	•
CONVENIENCES						
Double Cassette Conveniences	•	•	•	•	•	
Auto-Reverse (R = Record, P = Play)	Deck I/II (R/P)	Deck II (R/P)/I (P)	Deck II (R/P)/I (P)	Deck II (R/P)/I (P)	Deck II (R/P)/I (P)	
Digital Synchro (O = Optical)	• (O)					
CD-Deck Synchro	•	•	•	•		
Powered Loading/Eject	•	•				
Timer Record/Play (Timer Optional)	•					
Relay Record/Play (R = Record, P = Play)	• (R/P)	• (P)	• (P)	• (P)	• (P)	
Parallel Recording	•	•	•	•		
Normal/High-Speed Dubbing	•	•	•	•	•	
Last Memory	•	•	•	•	•	
Music/Skip Search	•	•	•	•	•	•
Auto Space Rec Mute	•	•	•	•	•	•
Headphone Output (V = with Volume Control)	•	•	•	•	•	•
SR (System Remote) Terminal	•	•	•	•	•	•
Microphone Input	•					
DISPLAY						
Electronic Counter	2-Mode	2-Mode	2-Mode	2-Mode		2-Mode
Fluorescent Peak-Hold Level Meter	•	•	•	•	• (LED)	•

Speakers Specifications

	<i>S-H310V</i>	<i>S-H310V/ S-H310K-W</i>	<i>S-H220V/ S-H220K-W</i>	<i>CS-9070</i>	<i>CS-7070</i>	<i>CS-5070</i>	<i>CS-3070</i>
Enclosure	Rear-duct bass-reflex floor-standing type	Front-duct bass-reflex floor-standing type	Front-duct bass-reflex floor-standing type	Rear-duct bass-reflex bookshelf type	Rear-duct bass-reflex bookshelf type	Rear-duct bass-reflex bookshelf type	Rear-duct bass-reflex bookshelf type
Speakers							
Woofer	14 cm cone woofer (x3)	14 cm cone type (x2)	13 cm cone type	30 cm cone type	25 cm cone type	20 cm cone type	20 cm cone type
Midrange			7 cm cone type	7.7 cm cone type	7.7 cm cone type	7.7 cm cone type	7.7 cm cone type
Tweeter	2.5 cm dome type	2.5 cm dome type	2.5 cm dome type	6.6 cm cone type	6.6 cm cone type	6.6 cm cone type	6.6 cm cone type
Impedance	8 Ω	8 Ω	8 Ω	8 Ω	8 Ω	8 Ω	8 Ω
Frequency Range	30 – 35,000 Hz	35 – 35,000 Hz	40 – 20,000 Hz	33 – 20,000 Hz	35 – 20,000 Hz	40 – 20,000 Hz	45 – 20,000 Hz
Sensitivity (1 m/W)	90 dB/W	90 dB/W	89 dB/W	92 dB/W	90 dB/W	90 dB/W	90 dB/W
Operation power to get 96 dB SPL at 1 m distance (DIN)	4 W	4 W	5 W	2.5 W	4 W	4 W	4 W
Music Power (DIN)	100 W	100 W	80 W	220 W	190 W	140 W	120 W
Dimensions (W x H x D)	251 x 1,030 x 422 mm (with base) 185 x 1,000 x 390 mm (without base)	240 x 925 x 345 mm (with base) 184 x 900 x 318 mm (without base)	180 x 850 x 230 mm	385 x 748 x 287 mm	334 x 695 x 273 mm	298 x 624 x 243 mm	258 x 540 x 234 mm
Weight	18.5 kg	11.5 kg	6.5 kg	12 kg	10.5 kg	8.3 kg	6.1 kg

PL-990



FULL AUTOMATIC STEREO TURNTABLE

- Full automatic operation : To provide easy hands-off operation
- Low-mass straight tone arm: Highly sensitive and resistant to resonance, track records better
- Precision DC servo motor: Pioneer Stable Hanging Rotor ends spindle wobble for smoother and more accurate platter rotation
- Universal-type cartridge connector
- Phono EQ included
- Dimensions (W X H x D): 420 x 100 x 342 mm
- Weight: 2.65kg

GR-209



7-BAND GRAPHIC EQUALISER

- 7-band equalisation
- LEDs in slider tips
- Equalisation on/off switch
- Dimensions (W X H x D): 420 x 60 x 221 mm
- Weight: 2.2 kg

Headphones Specifications

	<i>SE-M370</i>	<i>SE-M270</i>	<i>SE-A250</i>
Type	Closed	Closed	Open-air
Frequency Response	5-28,000 Hz	10-23,000 Hz	15-22,000 Hz
Impedance	35 Ω	35 Ω	35 Ω
Max. Input Power	1,000 mW	1,000 mW	100 mW
Sensitivity	102 dB	100 dB	98 dB
Driver Unit	∅ 38 mm	∅ 38 mm	∅ 38 mm
Plug	Mini / Standard Gold-plated	Mini / Standard Gold-plated	Mini / Standard Gold-plated
Cord Length	3.5 m (Single) (OFC)	3.5 m (Y-type) (OFC) (OFC)	3.5 m (Y-type) (OFC) (OFC)
Net Weight (w/o cord)	240 g	210 g	150 g
Head Band	Leather type	Wide width	Free adjust

Design Audio Systems Features

	<i>NS-11-Q</i>	<i>NS-11-S</i>	<i>NS-F10</i>
	XC-L11 / M-L11	XC-L11 / M-L11	XC-F10 / M-F10
SYSTEM			
Remote Control Unit	•	•	•
DISPLAY			
Separate type	•	•	•
Main Operation Buttons	•	•	•
Dimmer Control	•	•	•
Remote Control Sensor	•	•	•
AMPLIFIER SECTION	M-L11	M-L11	M-F10
Power (RMS, 1 kHz, 6 Ω)			
Front	30 W x 2	30 W x 2	30 W x 2
Subwoofer	50 W	50 W	50 W
Subwoofer Level Control	• (3-step)	• (3-step)	• (3-step)
Stereo Wide	•	•	•
Bass/Treble Control	•	•	•
L/R Balance Control	•	•	•
TUNER SECTION	XC-L11	XC-L11	XC-F10
RDS Tuner	•	•	•
Band (FM/AM)	•	•	•
Presets	30	30	30
Auto Tuning	•	•	•
Timer	• (3-mode)	• (3-mode)	• (3-mode)
CD PLAYER SECTION	XC-L11	XC-L11	XC-F10
Mechanism	Single Tray	Single Tray	Self-chuck Type
Motorised Door	•	•	•
Random/Repeat Play	•/•	•/•	•/•
PGM No.	24	24	24
Optical Digital Output	•	•	•
OPTIONAL MINIDISC RECORDER	MJ-L11	MJ-L11	
MDLP	•	•	
Mechanism	Single slot-in	Single slot-in	
Disc and Song and GROUP Title Input	•	•	
Edit modes	•	•	
Mono LP	•	•	
Random/Repeat Play	•	•	
PGM No.	24	24	
Synchro REC	•	•	
Digital/Analogue Input Selector	•	•	
FS Converter	• (32, 44.1, 48 kHz)	• (32, 44.1, 48 kHz)	
Optical Digital Input	•	•	
OPTIONAL CASSETTE DECK	CT-L11	CT-L11	CT-F10
Horizontal Loading	Slot-in	Slot-in	Slot-in
Auto-Reverse	•	•	•
Reverse Mode Select	•	•	•
Dolby B NR	•	•	•
Music Search	•	•	•
Auto-tape selector (Normal/Chrome)	•	•	•
Tape Counter	•	•	•
Auto Record Level Control	•	•	•
Synchro REC	•	•	•
A.S.E.S. (Auto Synchro Editing System)	•	•	•
OPTIONAL CD RECORDER	PDR-L77	PDR-L77	PDR-F10
Applicable Discs	CD/CD-R/CD-RW	CD/CD-R/CD-RW	CD/CD-R/CD-RW
D/A Converter	Digital Filter DAC	Digital Filter DAC	Digital Filter DAC
Sampling Rate Converter	•	•	•
Erase CD-RW disc with 5 erase modes	•	•	•
Digital Recording Level control (dB)	• (-48 – +12)	• (-48 – +12)	• (-86 – +20)
Programmed Play	• (24-step)	• (24-step)	• (24-step)
Manual/Track Search	•	•	•
SPEAKERS	S-L11-Q-LRW	S-L11-S-LRW	S-F10-LRW
Cone Size			
Satellite	8.7 cm	8.7 cm	7 cm
Subwoofer	16 cm	16 cm	16 cm
Maximum Power			
Satellite	30 W	30 W	30 W
Subwoofer	50 W	50 W	50 W

Design Audio Systems Specifications

	<i>MS-11-Q</i>	<i>MS-11-S</i>	<i>MS-F10</i>
STEREO CD RECEIVER			
STEREO CD TUNER/STEREO POWER AMPLIFIER	XC-L11 / M-L11	XC-L11 / M-L11	XC-F10 / M-F10
Amplifier section	M-L11	M-L11	M-F10
Continuous power output			
Stereo			
(RMS)	30 W x 2	30 W x 2	30 W x 2
(DIN)	23 W x 2	23 W x 2	23 W x 2
Subwoofer (RMS) (DIN)	50/43 W	50/43 W	50/43 W
Power Requirements	220 – 230 V (UK 230 V), 50/60 Hz	220 – 230 V (UK 230 V), 50/60 Hz	220 – 240 V, 50/60 Hz
Power consumption: In use/standby	102/0.9 W	102/0.9 W	127/0.9 W
Dimensions (W x H x D)	190 x 80 x 267 mm	190 x 80 x 267 mm	190 x 80 x 267 mm
Net weight	4 kg	4 kg	4 kg
Tuner section	XC-L11	XC-L11	XC-F10
FM Usable Sensitivity (IHF Mono)	18.3 dBf (2.2 µV, 75 Ω)	18.3 dBf (2.2 µV, 75 Ω)	18.3 dBf (2.2 µV, 75 Ω)
FM S/N ratio (DIN) (Mono/Stereo)	66/60 dB	66/60 dB	66/60 dB
CD Player section	XC-L11	XC-L11	XC-F10
Frequency Response	4 – 20,000 Hz	4 – 20,000 Hz	4 – 20,000 Hz
S/N ratio (EIA)	110 dB	110 dB	110 dB
Dimensions (W x H x D)	220 x 65 x 317 mm	220 x 65 x 317 mm	170 x 268 x 66 mm
Net weight	2.2 kg	2.2 kg	1.5 kg
OPTIONAL MINIDISC RECORDER			
Frequency Response	MJ-L11 20 – 20,000 Hz	MJ-L11 20 – 20,000 Hz	
S/N Ratio (EIA)	96 dB	96 dB	
Power consumption	11 W	11 W	
Dimensions (W x H x D)	220 x 65 x 313 mm	220 x 65 x 313 mm	
Net weight	2.5 kg	2.5 kg	
OPTIONAL CASSETTE DECK			
Wow & Flutter (WRMS)	CT-L11 0.15 % (WRMS)	CT-L11 0.15 % (WRMS)	CT-F10 0.07 % (WRMS), ± 0.14 (DIN)
Frequency Response			
Type I (Normal) (± 6 dB)	20 – 16,000 Hz	20 – 16,000 Hz	20 – 16,000 Hz
Type II (Chrome) (± 6 dB)	20 – 16,000 Hz	20 – 16,000 Hz	20 – 16,000 Hz
S/N ratio			
Dolby NR OFF	53 dB	53 dB	56 dB
Dolby B NR ON (at 5 kHz)	improved by 10 dB	improved by 10 dB	improved by 10 dB
Dimensions (W x H x D)	220 x 65 x 313 mm	220 x 65 x 313 mm	170 x 268 x 66 mm
Net weight	2.7 kg	2.7 kg	1.5 kg
OPTIONAL CD RECORDER			
Frequency Response	PDR-L77 2 – 20,000 Hz	PDR-L77 2 – 20,000 Hz	PDR-F10 2 – 20,000 Hz
S/N ratio: Rec/Play (EIA)	88/110 dB	88/110 dB	92/110 dB
Dynamic Range: Rec/Play			92/98 dB
Dimensions (W x H x D)	220 x 70 x 310 (334 with adapter) mm	220 x 70 x 310 (334 with adapter) mm	205.5 x 268 x 68 mm
Net weight	3 kg	3 kg	2 kg
SATELLITE AND SUBWOOFER			
SPEAKER SYSTEM	S-L11-Q-LRW	S-L11-S-LRW	S-F10-LRW
Cone Size	Satellite & subwoofer system	Satellite & subwoofer system	Satellite & subwoofer system
Satellite	8.7 cm	8.7 cm	7 cm
Subwoofer	16 cm	16 cm	16 cm
Frequency Range			
Satellite	110 – 20,000 Hz	110 – 20,000 Hz	125 – 20,000 Hz
Subwoofer	25 – 800 Hz	25 – 800 Hz	22 – 3,000 Hz
Sensitivity (1 m/W)			
Satellite	84 dB	84 dB	87 dB
Subwoofer	80.5 dB	80.5 dB	83 dB
Maximum Power			
Satellite	30 W	30 W	30 W
Subwoofer	50 W	50 W	50 W
Dimensions (W x H x D)			
Satellite	125 x 228 x 70 mm	125 x 228 x 70 mm	130 x 265 x 65 mm
Subwoofer	190 x 281 x 255 mm	190 x 281 x 253 mm	190 x 282.5 x 253 mm
Net weight			
Satellite	1.0 kg	1.0 kg	0.7 kg
Subwoofer	3.8 kg	3.7 kg	3.5 kg
OPTIONAL CABLE			
Cable Length	JC-L11 5 m	JC-L11 5 m	JC-F10 5 m

Hi-Fi Systems Features

	IS-22	IS-22S	N-A4900RDS	X-MM1
SYSTEM				
Remote Control Unit	•	•	•	•
DISPLAY				
Dimmer Control	•	•		
AMPLIFIER SECTION	M-IS22	M-IS22		
Power (RMS, 1 kHz, 6 Ω)	100 W x 2	100 W x 2	100 W x 2	25 W x 2
Enhance	•	•		
Sound Morphing			•	Sound Controller
Bass/Treble Control	• (± 4-step)	• (± 4-step)		
L/R Balance Control	•	•		
TUNER SECTION	Included in XC-IS22CD	Included in XC-IS22CD		
RDS Tuner	•	•	•	•
Band (FM/AM)	•	•	•	•
Presets	30	30	24	24
Auto Tuning	•	•	•	•
Timer	• (3-mode)	• (3-mode)	• (3-mode)	• (3-mode)
CD PLAYER SECTION	Included in XC-IS22CD	Included in XC-IS22CD		
Mechanism	Vertical	Vertical	3-disc Carousel	Single Tray
Motorised Door	•	•		•
Random/Repeat Play	•/•	•/•	•/•	•/•
PGM No.	24	24	32	32
Optical Digital Output	•	•	•	•
CASSETTE DECK SECTION	Included in XC-IS22CD	Included in XC-IS22CD	Included in XR-A4900*	Included in XR-NM1
Horizontal Loading	•	•	•	•
Auto-Reverse	•	•		•
Double Auto-Reverse			•	
Reverse Mode Select	•	•		•
Dolby B NR	•	•		•
Music Search	•	•	•	•
Tape Counter	•	•	•	•
Auto Record Level Control	•	•	•	•
A.S.E.S. (Auto Synchro Editing System)	•	•	•	Synchro REC
SPEAKERS	S-IS22	S-IS22S	S-A4900	S-NM1
3-Way Speaker	•	•	•	•
2-Way Speaker				•
Woofer/Midrange/Tweeter Size	17/6.6/2 cm	17/6.6/2 cm	16/5.2/2 cm	10/2 cm
Maximum Power	100 W	100 W	100 W	25 W

*Featuring 2 Karaoke Mic Inputs.

Hi-Fi Systems Specifications

	IS-22	IS-22S	N-A4900RDS	X-MM1
STEREO CD RECEIVER				
STEREO CD TUNER/STEREO POWER AMPLIFIER	XC-IS22CD / M-IS22	XC-IS22CD / M-IS22	XR-A4900*	XR-NM1
Amplifier section	M-IS22	M-IS22		
Continuous power output				
Stereo				
(RMS)	100 W x 2	100 W x 2	100 W x 2	25 W x 2
(DIN)	65 W x 2	65 W x 2	65 W x 2	17 W x 2
(DIN MUSIC)	150 W	150 W	146 W	23 W x 2
Power Requirements	220 – 230 V, 50 – 60 Hz	220 – 230 V, 50 – 60 Hz	220 V – 230 V (UK 230 V), 50 – 60 Hz	
Power consumption: In use/standby	140/1 W	140/1 W	125 W	
Dimensions (W x H x D)	160 x 300 x 237 mm	160 x 300 x 237 mm	270 x 320 x 339 mm	166 x 243 x 315 mm
Net weight	4.1 kg	4.1 kg	8.3 kg	6.4 kg
Tuner section	XC-IS22CD	XC-IS22CD		
FM Usable Sensitivity (IHF Mono)	14.3 dBf (1.4 μV, 75 Ω)	14.3 dBf (1.4 μV, 75 Ω)	14.3 dBf (1.4 μV, 75 Ω)	14.3 dBf
FM S/N ratio (DIN) (Mono/Stereo)	60 dB	60 dB	60 dB	60 dB
CD Player section	XC-IS22CD	XC-IS22CD		
Frequency Response	20 – 20,000 Hz	20 – 20,000 Hz	20 – 20,000 Hz	20 – 20,000 Hz
S/N ratio (EIAJ)	96 dB	96 dB	96 dB	96 dB
Dimensions (W x H x D)	204 x 300 x 237 mm	204 x 300 x 237 mm		
Net weight	2.7 kg	2.7 kg		
CASSETTE DECK	XC-IS22CD	XC-IS22CD		
Wow & Flutter (WRMS)	0.1 %	0.1 %	0.2 %	0.2 %
Frequency Response				
Type I (Normal) (± 6 dB)	35 – 14,000 Hz	35 – 14,000 Hz	35 – 14,000 Hz	35 – 14,000 Hz
Type II (Chrome) (± 6 dB)	35 – 15,000 Hz	35 – 15,000 Hz		
S/N ratio				
Dolby NR OFF	56 dB	56 dB	56 dB	56 dB
Dolby B NR ON (at 5 kHz)	improved by 10 dB	improved by 10 dB		
Dimensions (W x H x D)	included in amp section	included in amp section		
Net weight	included in amp section	included in amp section		
SPEAKERS (STEREO)	S-IS22	S-IS22S	S-A4900	S-NM1
Cone Size: Woofer/Midrange/Tweeter	17/6.6/2 cm	17/6.6/2 cm	16/5.2/2 cm	10/2 cm
Frequency Range	40 – 20,000 Hz	40 – 20,000 Hz	40 – 20,000 Hz	55 – 20,000 Hz
Sensitivity (1 m/W)	85 dB/W	85 dB/W	86 dB/W	85 dB/W
Maximum Power	100 W	100 W	100 W	25 W
Dimensions (W x H x D)	215 x 372 x 274 mm	195 x 301.5 x 331 mm	230 x 320 x 253.5 mm	130 x 240 x 235 mm
Net Weight	4.1 kg	3.9 kg	3.7 kg	1.9 kg

*Featuring 2 Karaoke Mic Inputs.

GREAT BRITAIN:
PIONEER GB Limited
Pioneer House, Hollybush Hill
Stoke Poges, Slough
Buckinghamshire SL2 4QP.
Tel. +44/1753 789 789

<http://www.pioneer.co.uk>

ICELAND: BRÆDURNIR ORMSSON HF
Lágmúli 8, P.O. Box 8760
128 Reykjavík
Tel. +354/55 32 800

IRELAND: AUDIO VISION IMPORT
John F. Kennedy Drive
Dublin 12
Tel. +353/1 240 5600

MALTA: CACHIA & GALEA Ltd.
Standard Bldgs., C. De Brockdorf Street
Msida MSD-02
Tel. +356/33 38 61

MILITARY: PIONEER ELECTRONICS DEUTSCHLAND GmbH
Military Sales Dept.
Hanns-Martin-Schleyer-Str. 35
47877 Willich
Tel. +49/21 54 91 34 22

LATVIA: BALTIC MULTI MEDIA SIA
Kr Barona Iela 16/18
1050 Rīga
Tel. +371/761 01 11 (new office +371/728 62 96)

ESTONIA: ULKOKAUPAT EESTI AS.
Kanali tee 1
10 112 Tallinn
Tel. +372/6 060 670

"Dolby", the double-D symbol, "Dolby Surround", "Pro Logic", "AC-3" and "Dolby Digital", are trademarks of Dolby Laboratories Licensing Corporation. "DTS", "DTS-ES" and "DTS Digital Surround" are trademarks of Digital Theater Systems, Inc.  Pioneer incorporates TruSurround technology under license from SRS Labs, Inc. Lucasfilm and THX are registered trademarks of Lucasfilm Ltd.

Infringement of copyright: Copying of prerecorded copyright material without appropriate authorisation or licence may be unlawful and you are advised to check the laws applicable in the jurisdiction to which you are subject.

Published by:

PIONEER EUROPE NV
HAVEN 1087, KEETBERGLAAN 1, B-9120 MELSELE
TEL. + 32 (0)3 570 05 11
Copyright 2001 by Pioneer Europe NV
All rights reserved.

Your local Pioneer dealer

Trade descriptions act:

Products offered for sale may differ from those described in this catalogue due to later production changes in specifications, components or place of manufacture. The information contained in this catalogue may contain technical inaccuracies or typographical errors. Consequently any such information is not to be treated as representations as to the current availability of products as described or as to products actually offered for sale.

<http://www.pioneer-eur.com>

Pioneer *sound.vision.soul*

Free Manuals Download Website

<http://myh66.com>

<http://usermanuals.us>

<http://www.somanuals.com>

<http://www.4manuals.cc>

<http://www.manual-lib.com>

<http://www.404manual.com>

<http://www.luxmanual.com>

<http://aubethermostatmanual.com>

Golf course search by state

<http://golfingnear.com>

Email search by domain

<http://emailbydomain.com>

Auto manuals search

<http://auto.somanuals.com>

TV manuals search

<http://tv.somanuals.com>