

HTP-2920 Quick Start Guide

1 Check that you have all the accessories.

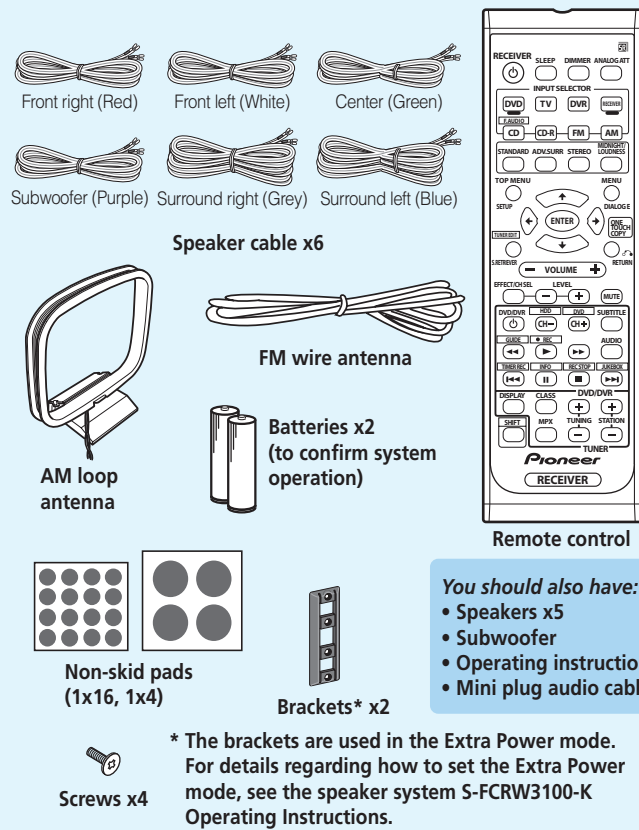

2 Put the batteries in the remote control and stick the non-skid pads to the base of the speakers.

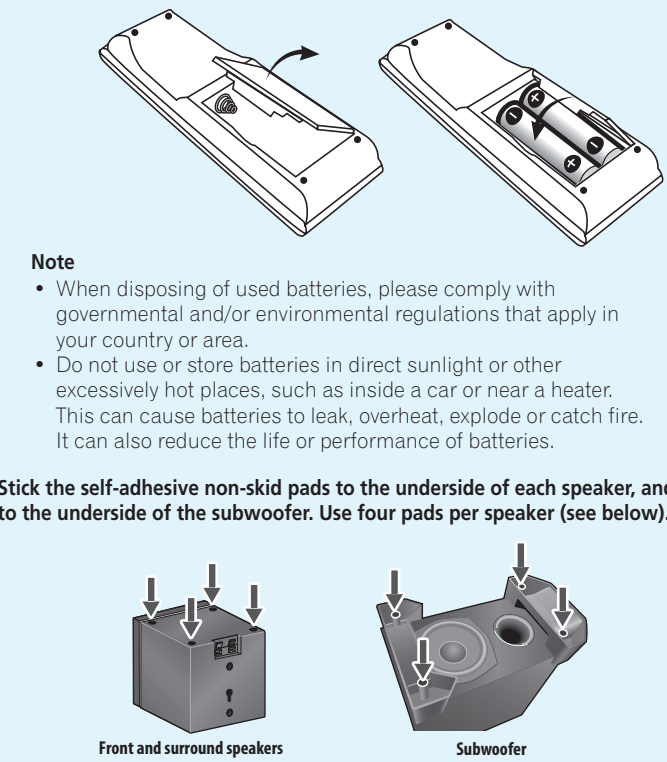

3 Connect each speaker to the receiver using the supplied speaker wires.

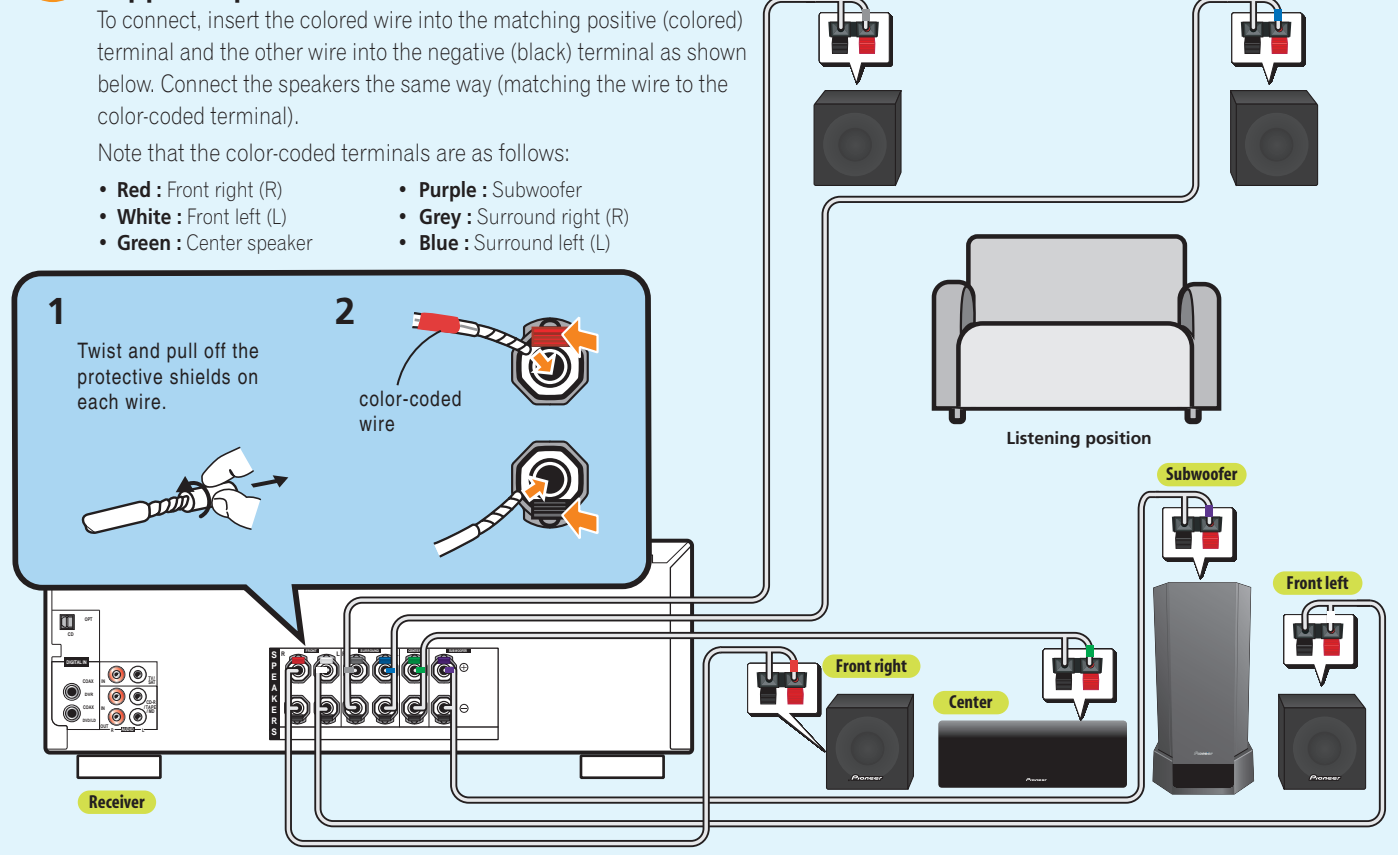

4 Connect the antennas.

- Connect the FM wire antenna and fully extend along a window frame or another suitable place that receives good reception.
- To connect the AM loop antenna, twist the exposed wire strands together and insert into the terminal, then snap the connector shut as shown below.

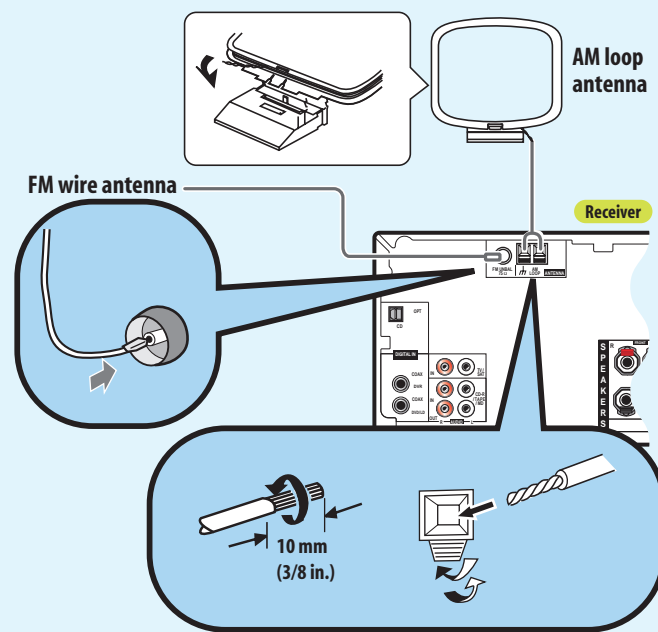

5 Connect your DVD player/recorder (optional-not supplied) to the receiver.

- Use a coaxial digital cord (not supplied) to connect the digital output of your DVD player/recorder to the DIGITAL INPUT (COAXIAL) DVD/DVR jack.
 - Use a red/white stereo audio cord (not supplied) to connect the AUDIO TV IN jack on the receiver to the audio output on your TV.* This will allow you to listen to your TV through this speaker system.
- * Note that you must also connect the DVD player/recorder's video output to your TV's video input to watch a DVD video (video cable is not supplied).

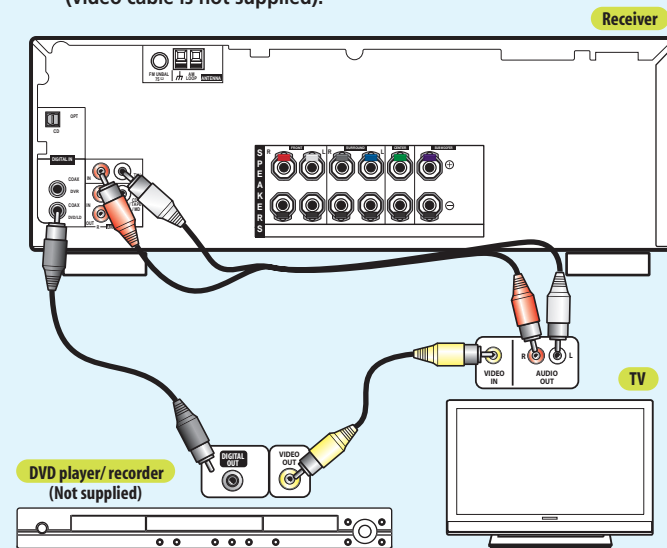

6 Plug the receiver, DVD player/recorder and TV into a convenient AC outlet.

- Press **STANDBY/ON** to turn on the receiver.
- Turn on your DVD player/recorder and TV, and set the TV to the correct video input.

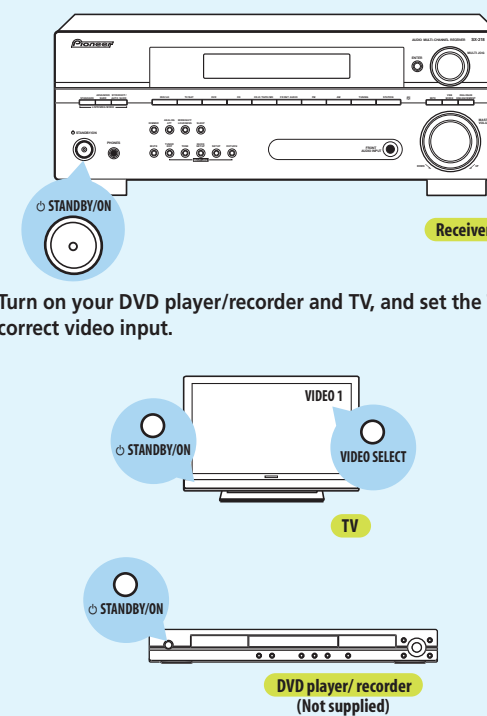

7 After turning on, make any necessary settings required by the DVD player/recorder, then you're ready to start enjoying your home theater system.

Refer to the receiver's operating instructions for a detailed explanation of this system's surround sound features.

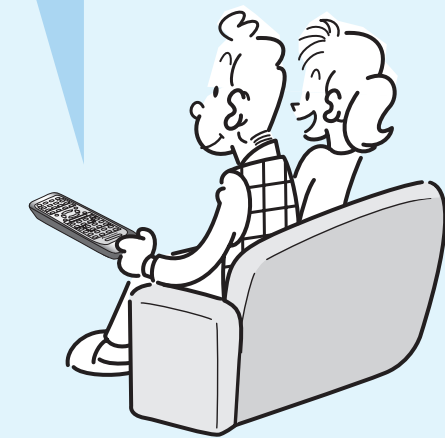
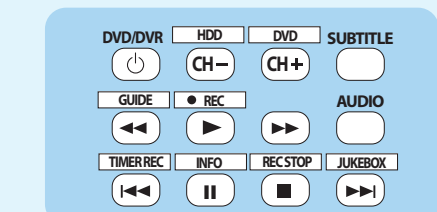

Setting Up Your HTP-2920 Home Theater System At-a-Glance

Refer to the following diagram when making system connections for a full surround sound setup. Note that the TV, DVD player/recorder and some accessories are not included. Refer to the reverse side of this sheet to check what's supplied with the HTP-2920.

Using the front panel audio input

Use the supplied mini-plug cable to connect an audio device (portable audio player, etc.) to the front panel audio input for playback through this system.

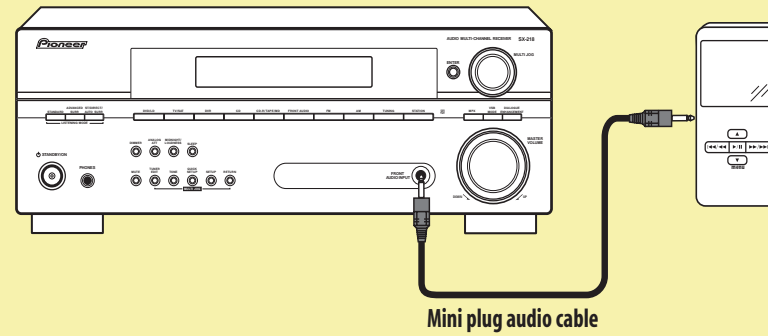

Wall mounting the speakers

The front, center and surround speakers has a mounting hole which can be used to mount the speaker on the wall.

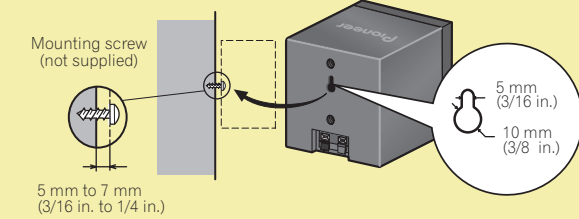

Before mounting (see above), keep in mind the following points:

- Remember that the speaker system is heavy and that its weight could cause the screws to work loose, or the wall material to fail to support it, resulting in the speaker falling. Make sure that the wall you intend to mount the speakers on is strong enough to support them. Do not mount on plywood or soft surface walls.
- Mounting screws are not supplied. Use screws that are suitable for the wall material and can support the weight of the speaker.

Caution

- If you are unsure of the qualities and strength of the walls, consult a professional for advice.
 - Pioneer is not responsible for any accidents or damage that result from improper installation.
 - Do not hang the subwoofer on the wall or from the ceiling as they might fall and cause injury.
 - When placing this unit, ensure that it is firmly secured and avoid areas where it may be likely to fall and cause injury in the event of a natural disaster (such as an earthquake).
- For more information about speaker installation, please see the instructions that come with the speakers.

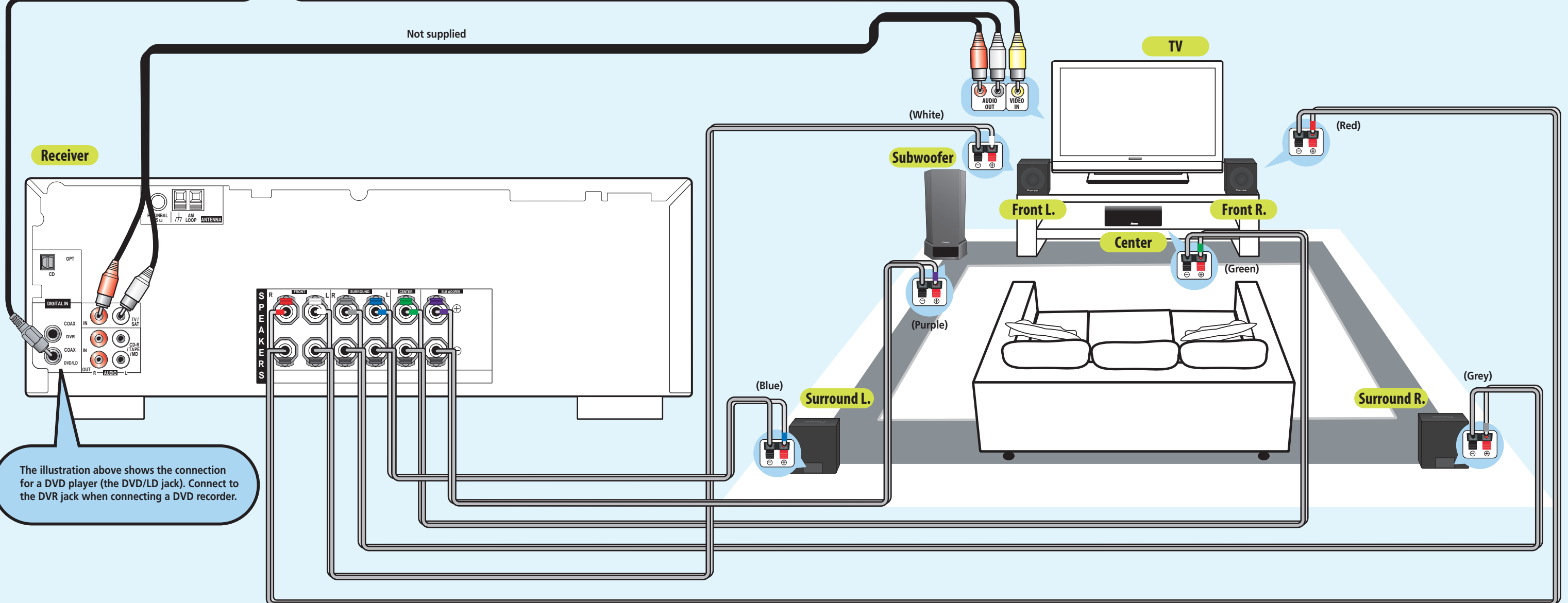
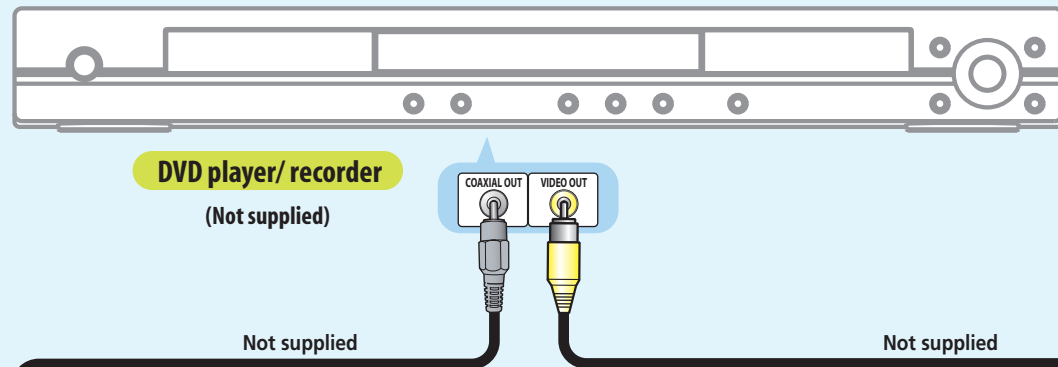

For detailed instructions, see the Operating Instructions supplied and/or contact one of our knowledgeable Pioneer Customer Service Representatives at 1-800-421-1404.

Free Manuals Download Website

<http://myh66.com>

<http://usermanuals.us>

<http://www.somanuals.com>

<http://www.4manuals.cc>

<http://www.manual-lib.com>

<http://www.404manual.com>

<http://www.luxmanual.com>

<http://aubethermostatmanual.com>

Golf course search by state

<http://golfingnear.com>

Email search by domain

<http://emailbydomain.com>

Auto manuals search

<http://auto.somanuals.com>

TV manuals search

<http://tv.somanuals.com>