

Setting up your DVD/CD Receiver

Caution When connecting this system or changing connections, be sure to switch the power off with the **STANDBY/ON** button, and disconnect the power cord from the AC outlet. Do not use these speakers with any other system or amplifier as this may result in damage or fire.

1 Check that you have all the accessories, then put the batteries in the remote control.

Power cord*
* In some countries or regions, the shape of the power plug may sometimes differ from that shown in the explanatory drawings.

Batteries and remote control

Video cord

AM loop antenna

FM antenna

2 Connect the AM and FM antennas to the rear panel of the DVD/CD receiver.

1 Pull off the protective shields of both AM antenna wires.

2 Push open the tabs, then insert one wire fully into each terminal.

3 Release the tabs to secure the AM antenna wires.

4 Fix the AM loop antenna to the attached stand.
To fix the stand to the antenna, bend in the direction indicated by the arrow (fig. A) then clip the loop onto the stand (fig. B).

Note: If you plan to mount the AM antenna to a wall or other surface, secure the stand with screws (fig. C) before clipping the loop to the stand. Make sure the reception is clear.

5 Place the AM antenna on a flat surface and point in the direction giving the best reception.
Don't let it come into contact with metal objects and avoid placing near computers, television sets or other electrical appliances.

6 Connect the FM wire antenna to the FM UNBAL 75Ω antenna terminal.
For best results, extend the FM antenna fully and fix to a wall or door frame. Don't drape loosely or leave coiled up.

Note: The signal earth (+) is designed to reduce noise that occurs when an antenna is connected. It is not an electrical safety earth.

Using the remote control
The remote control can be used within a range of about 7 meters from the remote sensor on the front panel, and within a 30 degree angle.

Precautions:

- The remote control may not work if there is an obstacle between the remote control and the display unit, or if the remote control is not directed towards the remote sensor of the display unit at the correct angle.
- The remote control may not work properly if strong light such as direct sunlight or fluorescent light is shining onto the unit's remote sensor.
- The remote control may not work properly when this unit is used near devices emitting infrared rays, or when remote controls of other devices which use infrared rays are used. Also, the use of this remote control may cause other devices to work improperly.
- When the operating range of the remote becomes too short, replace the batteries.

Remote control battery caution
Incorrect use of batteries may cause leakage or rupture.
Always be sure to follow these guidelines:

- Always insert batteries into the battery compartment correctly matching the positive (+) and negative (-) polarities, as shown by the display inside the compartment.
- Never mix new and used batteries.
- Batteries of the same size may have different voltages, depending on brand. Do not mix different brands of batteries.
- When disposing of used batteries, please comply with governmental regulations or environmental public instruction's rules that apply in your country or area.
- In order to prevent battery leakage, remove the batteries when not using the remote control for an extended period (one month or more). If leakage occurs, carefully wipe away any battery fluid inside the compartment, and replace the batteries with new ones.
- Do not allow books or other objects to rest on top of the remote control, since the buttons may be depressed, causing faster exhaustion of the batteries.

Additional notes on connecting antennas

- Keep antenna cables away from the main unit and other cables.
- To assure optimum reception, pull the FM antenna so that it is fully extended and not coiled or hanging at the rear of the unit.
- If reception with the supplied antenna is poor, see the *Other connections* section in the main operating instructions for details on connecting other antennas.

Additional notes on speaker placement
If your listening room is of adequate size, place the speakers as shown in step 3 to achieve the optimum surround sound effect. If you are listening in a fairly small room and a typical surround speaker setup is not possible, see *Home theater sound setup* in the instruction manual and the *Speaker Setup Guide* for information on the Front Surround 3-spot setup option. When using the standard surround speaker setup as shown in step 3, please observe the following guidelines:

- Install the main front left and right speakers at an equal distance from the TV.
- For optimum effect, install the rear speakers slightly above ear level.
- Install the center speaker above or below the TV so that the sound of the center channel is localized at the TV screen.

Precautions:

- When installing the center speaker on top of the TV, be sure to secure it with tape or some other suitable means.
- The subwoofer is not magnetically shielded and so should not be placed near a TV or monitor. Magnetic storage media (such as floppy discs and tape or video cassettes) should also not be kept close to the subwoofer.
- Do not fix the front, center speakers and subwoofer to the wall or ceiling; they could cause injury if they fell.

3 Connect each speaker using the color-coded speaker cords. Match them to the colored speaker terminals on the rear panel of the DVD/CD receiver.

Connect each speaker as shown below.
(Subwoofer connections start from step 3)

Color-coded wire (Connect to speaker)

Color-coded connector (Connect to rear panel)

- Twist and pull off the protective shields on each wire.
- Connect the wires to the speaker. Match the colored wire with the color-coded label (above the tabs), then insert the colored wire into the red (+) tab and the other wire with the black (-) tab.
- Connect the other end of the color-coded speaker terminals on the rear of the DVD/CD receiver (as shown at left). Make sure to insert completely. The small lug at the wire-end of the speaker plug should face up or down depending on whether it's being plugged into one of the upper or lower three speaker terminals. Please make sure to connect correctly.

For the best surround sound, setup your speakers as above. The front left and right speakers should be about 1.8–2.7 m apart.

Caution
These speaker terminals can be hazardous when live. When you connect or disconnect the speaker cables, to prevent the risk of electric shock, do not touch uninsulated parts before disconnecting the power cord.

4 Connect the DVD/CD receiver to your TV, then connect the supplied power cord.

- Connect one end to a video input on your TV. Use the supplied video cord.
- Connect the other end to the video output of the DVD/CD receiver. This player is equipped with copy protection technology. Do not connect this player to your TV via a VCR using AV cables, as the picture from this player will not appear properly on your TV.
- Connect the power cord to the AC inlet.

Congratulations! You're done setting up.

Printed in <ARE7358-A>

Speaker Setup Guide

What's in the box

- Front speakers x 2
- Center speaker x 1
- Surround speakers x 2
- Subwoofer x 1
- Speaker cords: Red/White (Front speakers) 4m x 2
- Green (Center speaker) 4m x 1
- Blue/Grey (Surround speakers) 10m x 2

- Non-skid pads (small) x 4
- Non-skid pads (large) x 4
- Front speaker stand bases x 2
- Screws (for bases) x 6
- Brackets x 2
- Screws (for brackets) x 4
- Mounting brackets x 2*
- Screws (for mounting brackets) x 2*

*Please refer to *Wall-mounting the front and surround speaker system* in the operating instructions for installation.

Safety precautions when setting up

When assembling the speakers, lay them down flat on their side to avoid accidents or injury. Make sure to use a stable surface when assembling, setting up, and placing the speakers.

Assembling the speaker stands and securing your front speakers

Attach the speaker stand bases to the stems using the screws provided.
Before securing the base to the stand, thread the speaker wire through the holes provided on the base as shown below. Then, once you have aligned the stem and base, secure with the small screws at the points shown at right.

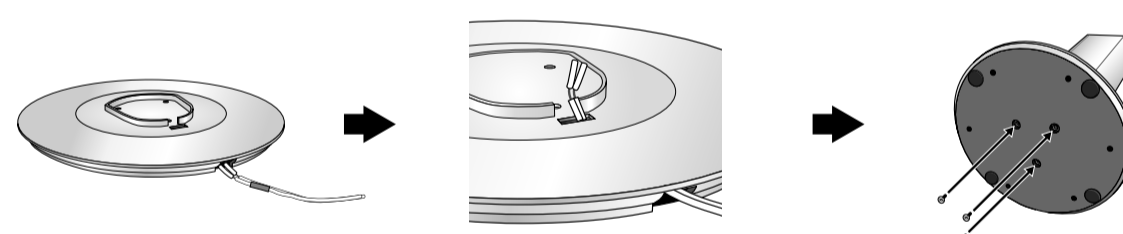

Standard surround 5-spot setup

This is a standard multichannel surround sound speaker setup for optimal 5.1 channel home theatre sound.

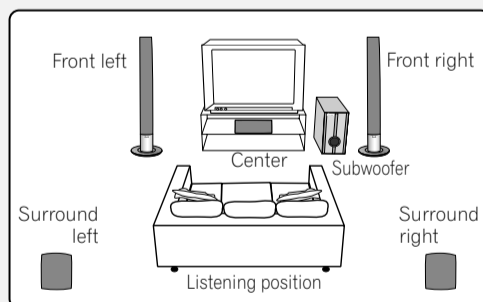

1 Attach the smaller non-skid pads to the base of the center speaker. The four large non-skid pads are for the subwoofer (as shown).
Use the supplied adhesive to attach 4 pads to the base of center speaker and subwoofer.

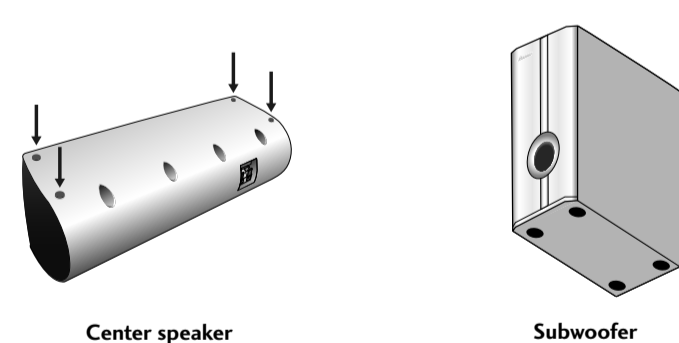

2 Connect the speaker system.
Refer to the *Setting up your DVD/CD Receiver* (the other part of this setup guide) to connect the speakers properly. Place them as shown in the diagram at far left optimal surround sound.

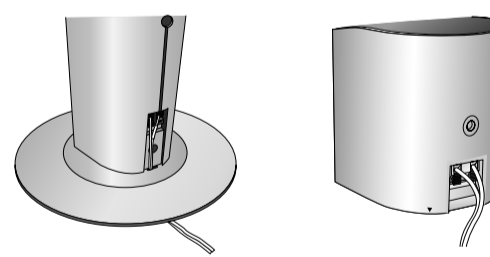

3 Switch Front Surround MODE OFF for 5-spot set up.
See the operating instructions for more on using Front Surround.

Caution
Please don't use the any attachments with the front speakers other than the brackets provided.

Front surround 3-spot setup

This setup is ideal when rear surround speaker placement isn't possible or you want to avoid running long speaker cables in your listening area.

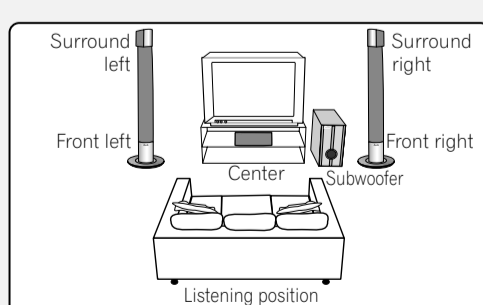

1 Attach the smaller non-skid pads to the base of the center speaker. The four large non-skid pads are for the subwoofer (as shown).
Use the supplied adhesive to attach 4 pads to the base of center speaker and subwoofer.

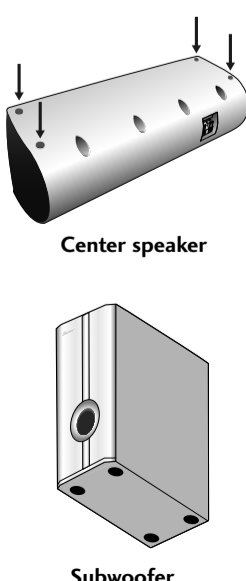

2 Place the surround speakers on top of the front speakers, turn the surround speakers towards the closest wall, lining the arrows up for optimal Front Surround.
Turn each surround speaker so that the **▼** arrow at the base is lined up with the **▲ (FRONT SURROUND)** arrow on the front speaker. This is only necessary when you are using the Front Surround mode (**MODE ON**). See the operating instructions for more on using Front Surround.

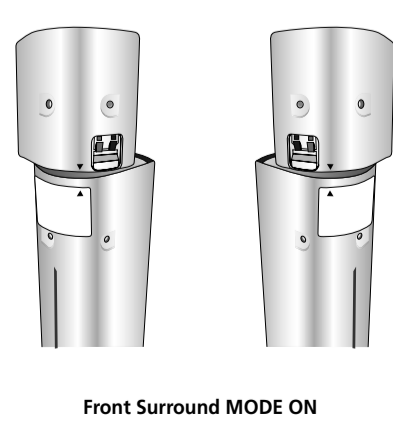

3 Secure in position with the brackets provided.
Line up the holes in the bracket with the holes in the speakers, then secure with two screws at the points shown below. Make sure you've matched the right and left brackets with the speakers (as shown).

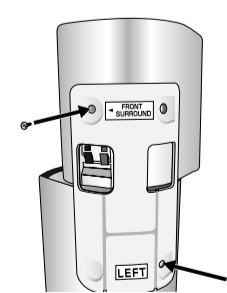

4 Connect the speaker system.
Refer to the *Setting up your DVD/CD Receiver* (the other part of this setup guide) to connect the speakers properly.

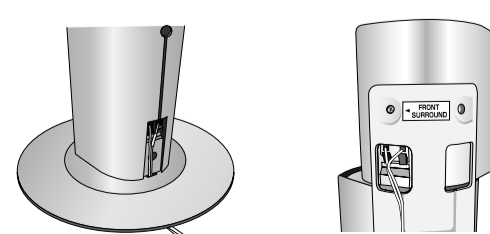

5 Secure the speaker wire.
When you're finished, thread the surround speaker cords through the outlet on the back of the speaker stand and through the base of the brackets as shown below.

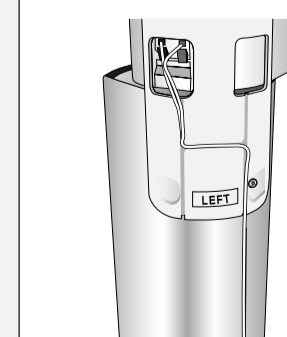

Caution
Please don't use the any attachments with the front speakers other than the brackets provided.

設定您的DVD/CD接收機

注意 連接本系統或變更接線方式時，請確實利用STANDBY/ON按鍵先將電源關閉，並將電源線自AC電源插座上脫離。切勿將這些揚聲器搭配其他的系統或擴大機使用，此種作法可能會導致損壞或引起火災。

1 檢查所有配件並無短缺，接著再將電池裝入遙控器內。

電源線* 電池及遙控器

*在某些國家或地區中，電源接頭的型狀可能與說明圖中所示者有所不同。

視頻線

AM環型天線 **FM天線**

1 2 3

2 將AM及FM天線裝設至DVD/CD接收機的背面板。

1 扯下AM天線兩條導線上的保護外皮。

2 將凸耳推開，接著將每條導線完全插入每個端子內。

3 將凸耳放回以固定AM天線導線。

4 將AM環型天線固定在安裝底座上。

欲將底座固定在天線上，則請對準箭頭所指的方向折彎(圖A)，接著將環型天線繫於腳座上(圖B)。

附註：若您打算將AM天線裝於牆上或其他的表面上，則請在將環型天線繫於腳座之前，先利用螺絲將腳座上緊(圖C)。完成安裝後請確定收聽情形清晰良好。

5 將AM天線置於平坦的表面上，並對準收聽狀況最佳的方向。切勿讓天線觸及金屬物體，同時遠離電腦、電視機或其他電氣設備的範圍擺設。

6 將FM線型天線裝設到FM UNBAL 75Ω天線端子上。

為得到最佳的收聽效果，請將FM天線完全展開固定於牆上或門框上。切勿放鬆垂下或捲成圈狀。

附註：信號地線(⊕)在設計上，主要是減少天線在裝設後所產生的雜訊。此線不作為電氣安全地線用途。

應用遙控器

遙控器所可使用的範圍是與前面板上的感應器相差7公尺的距離，角度則在30度以內。

安全注意事項：

- 當遙控器與顯示裝置之間存在障礙物，或遙控器並非以正確的角度，直接對準顯示裝置上的遙控感應器，遙控器便無法操作。
- 當有日光或強光等強光對準本機上的遙控感應器直接照射，遙控器便無法正常的操作。
- 當本機在有發射紅外線裝置附近使用，或有其他裝置的遙控器以紅外線在操作，遙控器便會無法正常操作。同樣，本遙控器在使用時亦會造成其他設備無法正常運作。
- 當發現遙控器的操作範圍縮小，請立即更換電池。

遙控器電池使用注意事項

電池不當使用易造成電池液外漏或電池破裂。請隨時遵照下列規定：

- 請依照電池室內的標示，對照正(⊕)負(⊖)，以正確方式將電池裝入電池室內。
- 不得將舊電池與新電池混合使用。
- 規格相同的電池，品牌不同電壓可能亦不盡相同。切勿混合使用不同品牌的電池。
- 勿將廢棄使用過的電池時，請遵照個人所在國家或地區之政府法規或環境公共事務的規定處理。
- 為了避免電池液外漏，長時間(乙個月以上)不使用遙控器時，請將電池取出。發生洩漏時，請小心將電池室內的電池液擦乾淨，同時更換新的電池。
- 勿將廢棄使用過的電池時，請遵照個人所在國家或地區之政府法規或環境公共事務的規定處理。
- 為了避免電池液外漏，長時間(乙個月以上)不使用遙控器時，請將電池取出。發生洩漏時，請小心將電池室內的電池液擦乾淨，同時更換新的電池。
- 勿將廢棄使用過的電池時，請遵照個人所在國家或地區之政府法規或環境公共事務的規定處理。

裝設天線之其餘注意事項

- 裝設天線線應儘可能遠離主機及其他機件。
- 為確保最佳的接收能力，請將FM天線完全展開，切勿捲成圈形或懸掛於本機的背面。
- 若隨附的天線接收能力不良，則請參閱主要操作手冊中「其他接線」乙節，以求詳細了解如何的連接室外天線。

揚聲器佈置之其餘注意事項

若您居住於於大小適中的規格，則請您按照步驟3當中的方式來佈置揚聲器，便能享受到最佳的環繞音響效果。

如果您居住於於相當狹小的房間內，那麼您不可能採用典型的環繞揚聲器設置方式。有關環繞音響3點式設置的資訊，請參閱操作手冊內的「家庭劇院音效設定」乙節及「揚聲器設定指南」。在採用步驟3中所述之標準環繞揚聲器設置時，請遵照下列指示：

- 請將左前置及右前置揚聲器，與電視機相隔同等距離來安裝。
- 為求產生最佳的效果，安裝時請置於較耳朵高度稍高的位置。
- 請將中置揚聲器置於電視機上方或下方，可讓您感受有如電視螢幕直接發出聲音之效果。

安全注意事項：

- 將中置揚聲器置於電視機上方時，請確實以膠布或其他適當的方式來固定揚聲器。否則，揚聲器會因地震等外力震動而從電視機上掉落，危及居住的人們或造成揚聲器損壞。
- 切勿將隨附的揚聲器接用其他的擴大機。此種作法會導致功損壞或起火。
- 隨本機附上之前置、中置及環繞揚聲器均已經過防磁處理。然而，當其所安裝的位置，色彩失真在揚聲器如果安裝得太靠近電視機螢幕時，則有可能發生。如果發生，請「關閉」電視機電源，然後15到30分鐘後再打開。如果問題仍在，請將揚聲器或移轉電視機。
- 重低音並未經過防磁處理，亦因此擺設時不得靠近電視機或顯示器。
- 磁性儲存媒體(像是軟碟、錄音帶或錄影帶等)所放位置不可太過靠近重低音。
- 請勿將前置、中置揚聲器及重低音安裝在牆上或天花板上，以免萬一掉落使人受傷。

3 使用標示顏色的揚聲器插頭接至每只揚聲器上。將這些插頭對照DVD/CD接收機後面板上的顏色端子接上。

請依照下列步驟連接每只揚聲器。(從步驟3開始連接重低音。)

1 將每條導線上的保護外皮扭轉後扯下。

2 將導線接至揚聲器上。將標示顏色的導線對照著標示顏色的標識(凸耳上方)，接著將有色導線插入紅色(+)的凸耳內，而另一條導線則插入黑色(-)的凸耳內。

3 將另一端連接至DVD/CD接收機後面板上的顏色端子(如左圖所示)。請確實完全插入。在揚聲器插頭線端處的小型接頭應視其為連接上方或下方三個當中的端子，再行決定應正面朝上或朝下。請確實正確接上。

上方三個端子
下方三個端子

為產生最佳的環繞音響，請照上圖方式佈置個人的揚聲器。左前置及右前置揚聲器二者應相距1.8-2.7公尺。

注意 這些揚聲器端子在導電時是具有危險性的。在您將線接上或脫離時，為避免受到電擊的危險，切勿在脫離電源線之前，觸及到未絕緣的部份。

4 將DVD/CD接收機接至個人電視機上，然後接上隨附的電源線。

1 將接收機一端接至個人電視機上的視頻輸入。連接時利用隨附的視頻線。

2 將接收機另一端接至DVD/CD接收機的視頻輸出。本機採用防盜持技術。切勿使用AV傳輸線將本機透過VCR的方式接至個人的電視機，如此一來，經由本機所傳送的畫面便有可能無法正常的在電視上顯示。

3 將電源線接上AC電源插座。

恭喜！現在您已設定完成。

至AC電源插座

揚聲器設定指南

- 請清點所有揚聲器配件**
- 前置揚聲器 x 2
 - 中置揚聲器 x 1
 - 環繞揚聲器 x 2
 - 重低音 x 1
 - 揚聲器線：紅線/白線(前置揚聲器) 4公尺 x 2
 - 綠線(中置揚聲器) 4公尺 x 1
 - 藍線/灰線(環繞揚聲器) 10公尺 x 2
 - 防滑墊(小) x 4
 - 防滑墊(大) x 4
 - 前置揚聲器基座 x 2
 - 螺絲(基座用) x 6
 - 托架 x 2
 - 螺絲(托架用) x 4
 - 安裝托架 x 2*
 - 螺絲(安裝托架用) x 2*
- * 關於 牆壁安裝前置及環繞揚聲器系統的安裝請參考操作手冊
- 設置時之安全注意事項**
- 在組裝揚聲器時，請側放在平坦的表面上以免發生意外或受傷。組裝、設置及擺設揚聲器時，請確實利用平穩的表面。

組裝揚聲器支架及固定您的前置揚聲器

使用隨機附贈的螺絲將揚聲器基座安裝到支柱上。

在將基座固定到支柱上時，捲起揚聲器線穿過基座上的孔(如下圖)。接著，在您將支柱對準基座後，將小的螺絲鎖上右圖所示的位置。

標準環繞立體聲5點設置

採用此標準方式放置多聲道環繞立體聲揚聲器，可享受理想的5.1聲道家庭影院音響效果。

1 將小的防滑墊貼到中置揚聲器的基座上。四片重低音專用的大型防滑墊(如圖所示)。

使用隨機附贈的黏著劑將四片防滑墊貼到中置揚聲器和重低音的基座上。

2 連接揚聲器系統。

請參閱設置您的DVD/CD接收機的內容(其他設置指南的部份)，以正確連接揚聲器。請按照最左圖中所示方式擺置，以獲得最佳的環繞音響效果。

3 關閉環繞音響模式以進行5點設置。

關於更多的使用前置環繞音響，請參閱操作手冊。

注意

- 請勿使用非隨托架附上的安裝配件來安裝前置揚聲器。

前置式環繞立體聲3點設置

如果無法將環繞立體聲揚聲器放置在收聽位置後方，或避免在收聽範圍內鋪設太長的揚聲器電纜，這種設置方式就最適合。

1 將小的防滑墊貼到中置揚聲器的基座上。四片重低音專用的大型防滑墊(如圖所示)。

使用隨機附贈的黏著劑將四片防滑墊貼到中置揚聲器和重低音的基座上。

2 將環繞揚聲器放前置揚聲器上，將環繞揚聲器轉向最近一面牆壁，對齊箭頭標示，以產生最佳前置環繞音響。

轉動每只環繞揚聲器使基座上的▼箭頭標示對齊前置揚聲器上的▲FRONT SURROUND箭頭標示。這作法只有在前置環繞音響模式(MODE ON)時才有必要。請參閱操作手冊以更多關於Front Surround模式的資訊。

Front Surround MODE ON

3 利用所附的托架固定於位置上。

將托架上的孔對齊揚聲器上的孔，然後利用兩顆螺絲鎖上圖所示的位置。請確實將右和左托架對準揚聲器接上(如圖示)。

4 連接揚聲器系統。

請參閱設置您的DVD/CD接收機的內容(其他設置指南的部份)，以正確連接揚聲器。

注意

- 請勿使用非隨托架附上的安裝配件來安裝前置揚聲器。

Free Manuals Download Website

<http://myh66.com>

<http://usermanuals.us>

<http://www.somanuals.com>

<http://www.4manuals.cc>

<http://www.manual-lib.com>

<http://www.404manual.com>

<http://www.luxmanual.com>

<http://aubethermostatmanual.com>

Golf course search by state

<http://golfingnear.com>

Email search by domain

<http://emailbydomain.com>

Auto manuals search

<http://auto.somanuals.com>

TV manuals search

<http://tv.somanuals.com>