

Pioneer *sound.vision.soul*

HDTV PROJECTION MONITOR

PRO-730HDI

PRO-530HDI

ELITE

Operating Instructions

FEATURES

Progressive Scan/HDTV monitor

All SDTV and HDTV signals are converted to 1080i and displayed at high resolution.

HDMI (High-Definition Multimedia Interface) with Copy Protection system

The combination of High-Definition Multimedia Interface (HDMI) and High-bandwidth Digital Content Protection (HDCP) is important for viewing copy-protected digital contents through SAT/CATV BOX or DVD player. DIGITAL input terminal receives the signal in the form of digital information. In this way, all signals coming into this interface have a very high resolution and less noise compared to an analog interface.

Dual System Component Input for NTSC/Progressive

Connection to a DVD player using the component output terminals makes possible a high picture-quality display, superior to that of a S-VIDEO terminal connection. This also handles high resolution component input (1080i, 480p), which will function as an interface for high-quality images in future.

Dual Tuner (Split Screen and CH Search screen function)

Two TV tuners are provided, making it possible to split the screen vertically in two areas in order to display moving images simultaneously on each of them. In addition, the channel search function makes it possible to check and perform other functions etc., on the program that you choose to run in the background, while viewing the foreground program. This adds remarkable convenience when you are concerned with viewing two programs.

Pioneer PureCinema III Format Converter

An advanced and exclusive I/P (Interlace/Progressive) third generation format converter called "PureCinema III", delivers a high-resolution progressive picture (480p) or Interlaced picture(1080i). *This is USER SELECTABLE

It reproduces film material in a very smooth and film-like image. This is perfect technology for movie lovers.

Anti-Reflective Tinted Protection Panel

The accompanying protective panel is AR (Anti-Reflective) coated and tinted.

This is not only to protect the screen, but to present a more natural and high contrast image with less light reflection. This AR coating is very durable against scratching.

Lens System for HDTV

The adoption of a specialized lens system for high-resolution HDTV which faithfully reproduces HDTV 1080i signals allows for highly color-saturated images to be displayed at high resolution. Also, by incorporating an "achromatic coated" lens for the blue CRT, the picture image is reproduced with less halo and appears sharp.



This HDTV monitor has the capability to display an HDTV (1080i) picture in its 16 x 9 viewing area.

Reference Theater mode and PRO mode

<Reference Theater Mode>

This mode reproduce film material just like a real film image. By cutting video enhancement circuits, the picture becomes more natural and looks film-like.

<PRO Mode>

This mode offers pro level video adjustment to the user. You can go into several areas such as: LTI (Luminance Transient Improvement), Gamma, CONTRAST EXP, SHARP MODE, White Balance.

Fully Illuminated Remote Control Unit

A fully illuminated universal remote control is used that makes it possible to operate other devices. Remote operations can thus be performed easily even in dark rooms and similar environments.

Multi-Point Convergence System

Convergence of the red, green, blue guns* in the TV is critical to a good picture. Thanks to new convergence system digital technology, not only can the center of the screen be adjusted, so can an amazing 72 other points across the entire viewing area. This ensures color accuracy throughout the screen. The adjustment is easily done from the remote control. (*guns = cathode ray tubes)

Program Block (V-CHIP)

You can block selected programs based on the established rating system for television programs and movies. The rating systems are defined below:

<U.S.A. RATING SYSTEM>

The TV parental Guidelines are used to rate television programming: <TV-Y>, <TV-Y7>, <TV-G>, <TV-PG>, <TV-14> and <TV-MA>.

The Motion Picture Association of America(MPAA) guidelines are used to rate movies: <G>, <PG>, <PG-13>, <R>, <NC-17>, <X> and <NR>.

<CANADIAN RATING SYSTEM>

The Canadian English Language Rating System is used to rate television programming: <C>, <C8+>, <G>, <PG>, <14+> and <18+>.

The Canadian French Language Rating system is used to rate television programming: <G>,<8+>,<13+>,<16+> and <18+>.

In order to block programming you feel is inappropriate, rating limits can be set on both systems using the remote control and a password.

Definitions:

SDTV Standard Definition Television

HDTV High Definition Television

CH TV channel

Read and understand these 'Operating Instructions' before operating your Monitor.

Follow the 'IMPORTANT SAFETY INSTRUCTIONS AND WARNINGS' section and all the warnings on the product.



HDMI™
HIGH-DEFINITION MULTIMEDIA INTERFACE

HDMI, the HDMI logo and High-Definition Multimedia Interface are trademarks or registered trademarks of HDMI Licensing LLC.

Thank you for purchasing this PIONEER HDTV Projection Monitor.

Please read the precautionary instructions enclosed with these operating instructions please do so before proceeding.

After learning how to operate the Projection Monitor, be sure to keep this manual handy for future reference.

[For U.S. model]

IMPORTANT NOTICE

H006AEn

The serial number for this equipment is located in the Rear panel. Please write this serial number on your enclosed warranty card and keep it in a secure area. This is for your security.

In this manual, we refer to the 'HDTV PROJECTION MONITOR', as the 'Projection Monitor' or the 'Monitor'.

Note on the SPLIT screen and SEARCH screen functions

The SPLIT screen and SEARCH screen functions provided in this monitor are intended for private viewing only.

Use of the above video processing functions for profitmaking purpose or for public viewing (clubs, hotels, etc.) without prior authorization from the transmitter and/or owner of the video program (s) may be an infringement of existing copyright laws.

WARNING: THE APPARATUS IS NOT WATERPROOF, TO PREVENT FIRE OR SHOCK HAZARD, DO NOT EXPOSE THIS APPARATUS TO RAIN OR MOISTURE AND DO NOT PUT ANY WATER SOURCE NEAR THIS APPARATUS, SUCH AS VASE, FLOWER POT, COSMETICS CONTAINER AND MEDICINE BOTTLE ETC.

H001AEn

WARNING: Handling the cord on this product or cords associated with accessories sold with the product will expose you to lead, a chemical known to the State of California and other governmental entities to cause cancer and birth defects or other reproductive harm.

Wash hands after handling.

Note to CATV system installer

This reminder is provided to call the CATV system installer's attention to article 820-40 of the NEC that provides guidelines for proper grounding and, in particular, specifies that the cable ground shall be connected to the grounding system of the building, as close to the point of cable entry as practical.

H008 En

[For Canadian model]

CAUTION: TO PREVENT ELECTRIC SHOCK, DO NOT USE THIS (POLARIZED) PLUG WITH AN EXTENSION CORD, RECEPTACLE OR OTHER OUTLET UNLESS THE BLADES CAN BE FULLY INSERTED TO PREVENT BLADE EXPOSURE.

ATTENTION: POUR PREVENIR LES CHOCS ELECTRIQUES NE PAS UTILISER CETTE FICHE POLARISEE AVEC UN PROLONGATEUR UNE PRISE DE COURANT OU UNE AUTRE SORTIE DE COURANT, SAUF SI LES LAMES PEUVENT ETRE INSEREES A FOND SANS EN LAISSER AUCUNE PARTIE A DECOUVERT.

H007A2L

NOTE: This equipment has been tested and found to comply with the limits for a Class B digital device, pursuant to Part 15 of the FCC Rules. These limits are designed to provide reasonable protection against harmful interference in a residential installation. This equipment generates, uses, and can radiate radio frequency energy and, if not installed and used in accordance with the instructions, may cause harmful interference to radio communications. However, there is no guarantee that interference will not occur in a particular installation. If this equipment does cause harmful interference to radio or television reception, which can be determined by turning the equipment off and on, the user is encouraged to try to correct the interference by one or more of the following measures:

- Reorient or relocate the receiving antenna.
-Increase the separation between the equipment and receiver.
-Connect the equipment into an outlet on a circuit different from that to which the receiver is connected.
-Consult the dealer or an experienced radio/TV technician for help.

H010 En

Information to User

Alteration or modifications carried out without appropriate authorization may invalidate the user's right to operate the equipment.

H011 En

IMPORTANT



The lightning flash with arrowhead symbol, within an equilateral triangle, is intended to alert the user to the presence of uninsulated 'dangerous voltage' within the product's enclosure that may be of sufficient magnitude to constitute a risk of electric shock to persons.



CAUTION: TO PREVENT THE RISK OF ELECTRIC SHOCK, DO NOT REMOVE COVER (OR BACK). NO USER-SERVICEABLE PARTS INSIDE. REFER SERVICING TO QUALIFIED SERVICE PERSONNEL.



The exclamation point within an equilateral triangle is intended to alert the user to the presence of important operating and maintenance (servicing) instructions in the literature accompanying the appliance.

H002 En

NOTICE ON ADVERSE EFFECTS TO TV TUBE

Image Burn-in : Displaying the same images on your Monitor (such as still or paused images, TV/video games, close-captioning, computer programs, on-screen displays, or other images with static or virtually static portions) for a prolonged period of time may cause permanent residual images to appear on your Monitor.

Avoid displaying the same image continuously over a long period of time. If the same image is displayed continuously for several hours, or for shorter periods of time over several days, a permanent after-image may remain on the screen due to burning of the phosphorous materials contained in your Monitor. Such images may become less noticeable if moving images are later displayed, but they will not disappear completely. For Games, please select the Game Mode (page 52), and do not view static or virtually static images on your Monitor for more than two hours. After displaying static or virtually static images on your Monitor, it is recommended that you view a normal moving picture in the "WIDE" or "FULL" screen setting for three (3) times longer than the time the static or virtually static images were displayed.

The following symbols are found in this manual and on the labels on the product. They alert the operators and service personnel of this equipment to potentially dangerous conditions.

 This symbol indicates an action that is prohibited.

⚠ WARNING

This symbol refers to a hazard or unsafe practice which can result in severe personal injury or death.

⚠ CAUTION

This symbol refers to a hazard or unsafe practice which can result in personal injury or property damage.

⚠ WARNING

IMPORTANT SAFETY INSTRUCTIONS AND WARNINGS

- Read all of these instructions.
- Keep these instructions for later use.
- Follow all warnings and instructions marked on the Monitor.

FOR YOUR PERSONAL SAFETY

1. This Monitor is equipped with a polarized alternating current line plug (a plug having one blade wider than the other). This plug will fit into the power outlet only one way. This is a safety feature.



If you are unable to insert the plug fully into the outlet, try reversing the plug. If the plug should still fail to fit, contact your electrician to replace your obsolete outlet. Do not defeat the safety purpose of the polarized plug.

2. If the power cord or plug becomes damaged or frayed, unplug this Monitor from the wall outlet and refer to qualified service personnel for servicing.

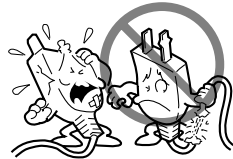

3. Do not overload wall outlets and extension cords as this can result in fire or electrical shock.



4. Do not allow anything to rest on or roll over the power cord, and do not place the Monitor where the power cord may be subject to traffic or abuse. This may result in electrical or fire hazard.



5. Do not attempt to service this Monitor yourself as opening or removing covers may expose you to dangerous voltage or other hazards. Refer all servicing to qualified personnel.



6. Never push the objects of any kind into this Monitor through cabinet slots as they may touch dangerous voltage points or short out parts that could result in a fire or electric shock. Never spill liquid of any kind on the Monitor.



7. If the Monitor has been dropped or the cabinet has been damaged, unplug this Monitor from the wall outlet and refer to qualified service personnel for servicing.



8. If liquid has been spilled into the Monitor, unplug the Monitor from the wall outlet and refer servicing to qualified service personnel.



9. Do not subject your Monitor to impact of any kind. Be particularly careful not to damage the screen surface.

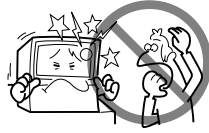

10. Unplug the Monitor from the wall outlet before cleaning. Do not use liquid cleaners or spray-type cleaners. Use a damp cloth for cleaning.



11-1. Do not place this Monitor on an unstable, uneven or an inclined location. The Monitor may overturn, causing serious injury (to a person), and serious damage to the appliance.

11-2. Be careful when placing the Monitor on a cart to move it. Quick stops, excessive force, and uneven surfaces may cause the Monitor and cart to overturn.



PROTECTION AND LOCATION OF YOUR HDTV PROJECTION MONITOR

12. • Do not use the Monitor near water, for example, near a bathtub, washbowl, kitchen sink, or laundry tub, in a wet basement, or near a swimming pool, etc.



• Never expose the Monitor to rain water.
If the Monitor system has been exposed to rain or water, unplug the Monitor from the wall outlet and refer servicing to qualified service personnel.



13. Choose a place where light (artificial or sunlight) does not shine directly on the screen.

14. Avoid dusty places since the buildup of dust inside the Monitor's chassis may result in the malfunctioning, when high humidity persists.



15. • The Monitor has slots, or openings in the cabinet for ventilation purposes to ensure the reliable operation of the Monitor, and to protect it from overheating. These openings must not be blocked or covered.



• Never cover the slots or openings with cloth or other material.
• Never block the bottom ventilation slots of the Monitor by placing it on a bed, sofa, rug, etc.
• Never place the Monitor near or over a radiator or heat register.
• Never place the Monitor in a built-in enclosure such as a bookcase, unless proper ventilation is provided.



16. If an outside antenna is connected through other equipment, be sure the antenna system is grounded so as to provide protection against voltage surges and built-up static charges. In the U. S. A., section 810 of the National Electrical Code, ANSI/NFPA 70, provides information on proper grounding of the mast and supporting structure, grounding of the lead-in wire to an antenna-discharge unit, size of grounding conductors, location of antenna-discharge unit, connection to grounding electrode, and requirements for the grounding electrode.

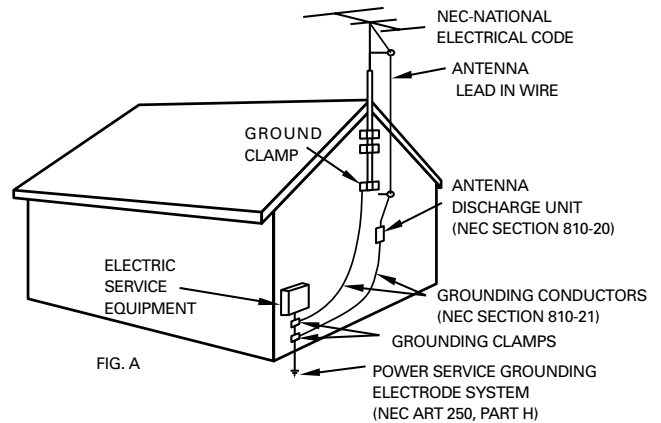
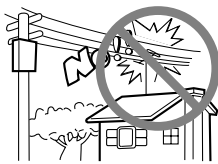
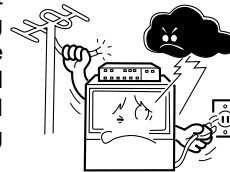

FIG. A
EXAMPLE OF ANTENNA GROUNDING IN NATIONAL ELECTRICAL CODE INSTRUCTIONS

17. An outdoor antenna system should not be located in the vicinity of overhead power lines/ electric lights or power circuits, or where it can fall onto such power lines or circuits. When installing an outdoor antenna system, extreme care should be taken to keep it from touching such power lines or circuits as contact with them might be fatal.



18. For added protection during a lightning storm, or when it is left unattended and unused for long periods of time, unplug the Monitor from the wall outlet and disconnect the antenna. This will prevent damage due to lightning and power-line surges.



OPERATION OF YOUR HDTV PROJECTION MONITOR

19. The Monitor should be operated only from the type of power source indicated on the marking label. If you are not sure of the type of power supply at your home, consult your dealer or local power company.

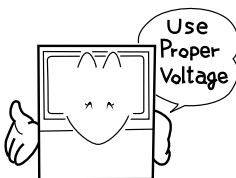

24. It is normal for some Monitor to make occasional snapping or popping sounds, particularly when being turned on or off. If the snapping or popping is continuous or frequent, unplug the Monitor and consult your dealer or service technician.

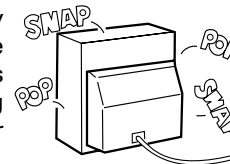

20. If you are unable to restore normal operation by following the detailed procedure in your operating instructions, unplug it from the wall outlet and refer to qualified service personnel for servicing. Do not adjust other controls than those described in this manual. Improper adjustments may result in damage and will often require extensive work by a qualified technician to restore the Monitor to normal operation.



FOR SERVICING AND MODIFICATION

25. Do not use attachments not recommended by the Monitor's manufacturer as they may result in the risk of fire, electrical shock or injury to persons.

26. When replacement parts are required, be sure the service technician uses replacement parts specified by the manufacturer that have the same characteristics as the original part. Unauthorized substitutions may result in fire, electrical shock, or injury.

21. If your Monitor is to remain unused for a period of time, for instance, when you go on a holiday, turn the Monitor 'off' and unplug it from the wall outlet.



27. Upon completion of any service or repairs to the Monitor, ask the service technician to perform routine safety checks to determine that the Monitor is in a safe operating condition.

TV SERVICE DEPT.



IF THE HDTV PROJECTION MONITOR DOES NOT OPERATE PROPERLY

22. If you are unable to restore normal operation by following the detailed procedure in your operating instructions, do not attempt any further adjustment. Unplug the Monitor and call your dealer or service technician.



23. Whenever the Monitor is damaged or fails, or there is a distinct change in performance, unplug the Monitor and have it checked by a professional service technician.

CONTENTS

INTRODUCTION

HOW TO USE THESE OPERATING INSTRUCTIONS	8
INSTALLING THE MONITOR	9
HOW TO ATTACH THE PROVIDED FRAME COVER	10
HOW TO REMOVE THE PROTECTIVE SCREEN	11

BASIC OPERATIONS

BEFORE USE	12
CONNECTING THE ANTENNA	14
CONNECTING VIDEO/AUDIO EQUIPMENT	16
FRONT PANEL FUNCTIONS	20
REMOTE CONTROL UNIT FUNCTIONS	22
TO WATCH TV	24
CHECKING THE MENU	26
AUTO CHANNEL PRESET	28
CONVERGENCE ADJUSTMENT	30

BASIC FUNCTIONS

PROGRAM BLOCK (V. CHIP) FUNCTION	32
CHANGING PASSWORD	39
CHANGING SCREEN SIZE	41
MULTI-SCREEN FUNCTION	44
CLOSED CAPTION DECODE FUNCTION	46
CHANGING CHANNEL SET UP	47
PICTURE ADJUSTMENTS	52
CHANGING SCAN MODE	63
SOUND ADJUSTMENTS	64
DIGITAL INTERFACE	68
MULTI-POINT CONVERGENCE ADJUSTMENT	73

VARIOUS FUNCTIONS

CONNECTION WITH RECEIVER (1)	75
CONNECTION WITH RECEIVER (2)	78
CONNECTING THE SYSTEM REMOTE CONTROL	80
REMOTE CODE SET UP	81

OTHERS

MENU INDEX	92
TROUBLESHOOTING	94
SPECIFICATIONS	96

HOW TO USE THESE OPERATING INSTRUCTIONS

The following page is an example of the way that basic operating instructions are shown in this manual. The explanation method varies from page to page.

* The screen illustrations may be different from the actual screen display.

AUTO CHANNEL PRESET

The broadcast frequencies that can be received depend on your area. Memorize the broadcast stations that can be received in your area in the presets.

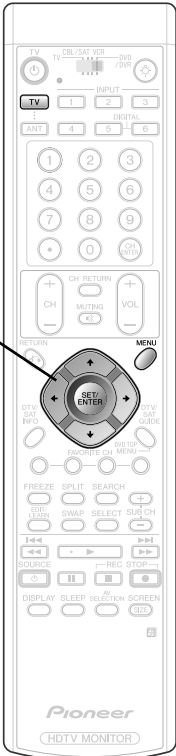



The button(s) that is/are used is/are shown in dark gray.

- 1 Select TV.** 
- 2 Press MENU and select SET UP by using the ← or → button and then pressing ↓ button. (Refer to page 26.)**
- 3 Select CHANNEL SET UP in the same way.**

- 4 Select AUTO CHANNEL PRESET .**

- 5 Select ANTENNA , then select A or B.**

NOTES:

- The CHANNEL SET UP cannot be selected unless the function is set up for TV.
- Failure to connect antenna cable in this procedure will result in selection of a single TV channel.

Precautions etc. 28

Buttons used

Explanation of the function on this page.

Operating procedure

Screen during operation

INSTALLING THE MONITOR

INSTALLATION PRECAUTIONS:

- **Keep away from magnetic fields**
The picture may be distorted if strong magnetic fields are nearby. External speakers should be set at least 2 feet (60cm) away from the Projection Monitor. Electric fans and other motor driven appliances and toys may also be sources of magnetism.
- Bright light or direct sunlight will dull the picture. Position the Projection Monitor so that the screen faces away from windows.
- While the Projection Monitor is operating, it is cooled by airflow through ventilation holes in the rear and bottom. Therefore, avoid placing it in a location where the cooling airflow is hindered (e. g. against a wall).
- Avoid places subject to extremely high temperatures or humidity, or to temperatures of 41°F (5°C) or lower. Also avoid dusty places.
- If setting the Projection Monitor on a floor made of soft material, make sure that the floor will not be damaged by the weight of the Projection Monitor.
- Do not put the Projection Monitor on a surface that is tilted, unsteady or prone to shake or vibrate. A shaky or slanted platform is dangerous.
- Cover shiny surfaces (floor and walls) with non reflective materials (carpet, rugs, wallpaper, etc.).

OPERATING PRECAUTIONS

Optimum viewing distance

10 to 23 feet is the range recommended for viewing comfort.

Adjust room illumination

Excessively bright or dim lighting may strain your eyes. Draw the curtains if necessary to shut out direct sunlight.

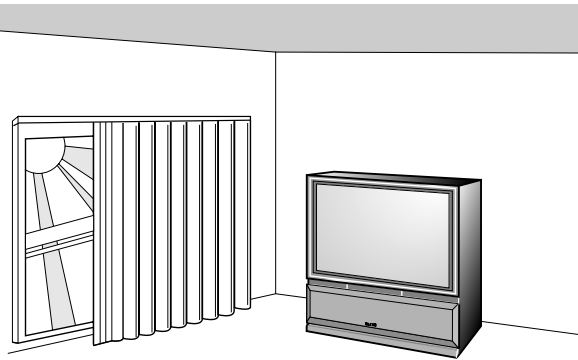

Condensation and picture blurring

- If the room temperature suddenly rises (or if the Projection Monitor is moved from a cool place to a hot place), condensation may form on the lenses resulting in picture distortion or color fading. If this occurs, simply wait a while (with the power switch ON) and the condensation will disappear.
- A gradual change in temperature can prevent condensation from forming.

CARE OF YOUR PROJECTION MONITOR

DO NOT:

- Do not use strong cleansers, solvents, polishes, or chemically treated cloths to clean the screen or cabinet.
- Do not touch or scratch the screen.
- Do not fasten or place rubber or vinyl items on the Monitor.
- Do not stick adhesive tape onto the Monitor.
- Do not put any object on the Monitor.

DO:

- Use a soft cloth to dust the screen and cabinet.
- Handle the screen with care to avoid scratches or damages.
- Ask your dealer or a Pioneer authorized service center to clean the interior of the monitor in your area if the picture brightness is too low even with the max. level. This may be caused by dust buildup inside.

USAGE GUIDELINES & PRECAUTIONS

All phosphor-based screens can be affected by displaying static or virtually static images for a prolonged period of time. After-image and permanent effects on the screen can be avoided by taking some basic precautions. By following the recommendations listed below, you can ensure longer and satisfactory results from your television.

- Whenever possible, avoid continuously displaying static or virtually static images on your Monitor (e.g., still images, TV/video games, close-captioning, computer programs, or other images with static or virtually static portions).
- Avoid viewing the On-Screen Display for extended periods from a digital tuner, DVD player, VCR and all other components.
- Do not leave the same picture freeze-framed or paused continuously over a long period of time when using the still picture mode from VCR, DVD player, or other component.
- Images which have very bright areas and very dark areas side by side should not be displayed for a prolonged period of time.
- When playing a game, the "GAME" mode setting (page 52) within "Picture Adjustment Settings" is strongly recommended. It is also recommended that such be limited to less than two (2) hours at a time.
- After displaying static or virtually static images on your Monitor, it is recommended that you view a normal moving picture in the "WIDE" or "FULL" screen setting for three (3) times longer than the time the static or virtually static images were displayed.

HOW TO ATTACH THE PROVIDED FRAME COVER

ATTACH THE FRAME COVER BEFORE USING THE MONITOR.

PARTS INCLUDED FOR FRAME COVER INSTALLATION:

- 2 SIDE FRAME COVERS (L, R) (TRIMS) (short)
- 2 FRAME COVERS (TRIMS) (long)

HOW TO ATTACH THE FRAME COVER

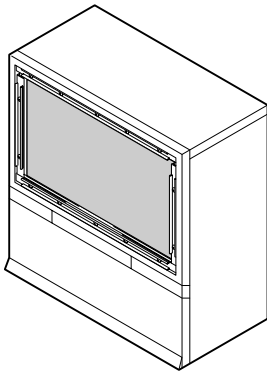

1. Attaching the side frame covers.
Push in the side frame cover from the outside along the groove on the panel frame until you hear a click.

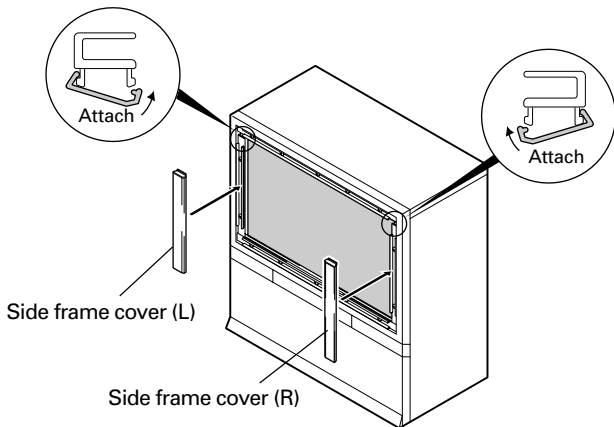

Attach side frame cover along the aluminium edge guards leaving a space of approximately 0 to 1/32 in. (0 to 1 mm) from the upper panel frame.

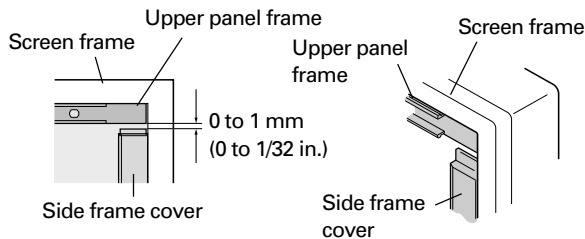

2. Attaching the upper and lower frame covers
Push in the upper and lower frame covers from the outside along the groove on the panel frame until you hear a click.

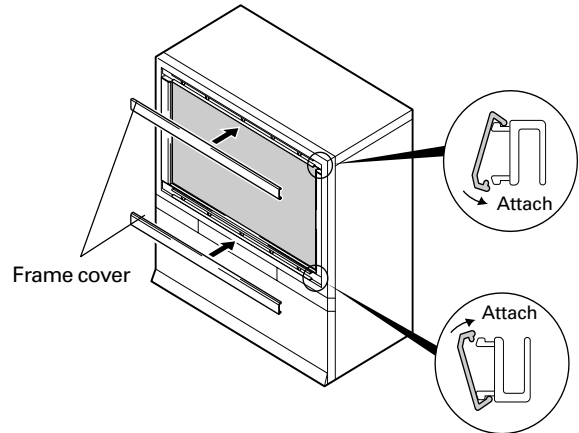

NOTES FOR CARE AND CLEANING OF SCREEN:

- Do not hit or throw anything onto the protective screen, as a damaged protective screen may cause injury.
- If the protective screen surface is dirty, wipe it with a cloth dipped in warm water and then wrung out. Wipe it dry with a soft, dry cloth.
- Never use paint thinner or other cleaners to clean the protective screen as they may contain harmful chemicals that will damage the finish of the screen.

HOW TO REMOVE THE FRAME COVER

Remove the frame cover by the following procedure.

- ① Prepare a flat-blade screw driver (large) and a small and thick cloth.
- ② Wrap the flat-blade screw driver into the end of the side frame covers (left and right) and remove it using a lever principle. Be sure to remove them from the bottom as shown in the figure.

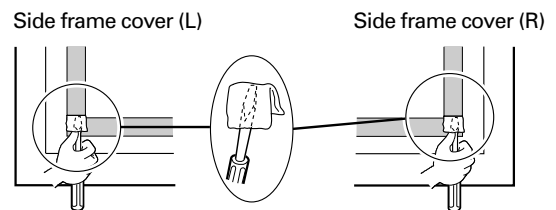

- ③ Remove the upper and lower frame covers by the same procedure as in ②, gently.

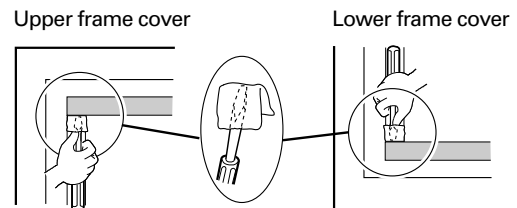

HOW TO REMOVE THE PROTECTIVE SCREEN

The protective screen is attached when the monitor is shipped to protect the display. We do not recommend that you remove it, but if you have to remove it, do so following the procedure shown below.

If you decide remove the protective screen.

1. Remove the left, right, upper, and lower frame covers.
2. Remove the screws from the upper panel frame and side panel frames. (Not remove the screw from the lower panel.)

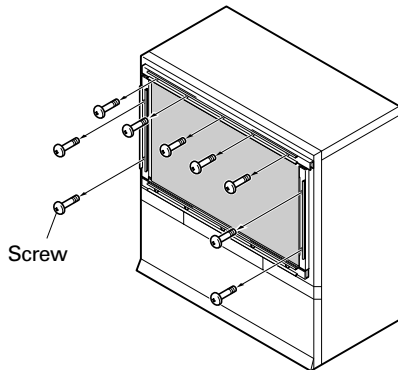

3. While holding the screen in place, remove the upper panel frame and side panel frames.

CAUTION: The panel frames are made of aluminum, so to protect them from scratches, be extremely careful not to strike them with the rim of the screen frame.

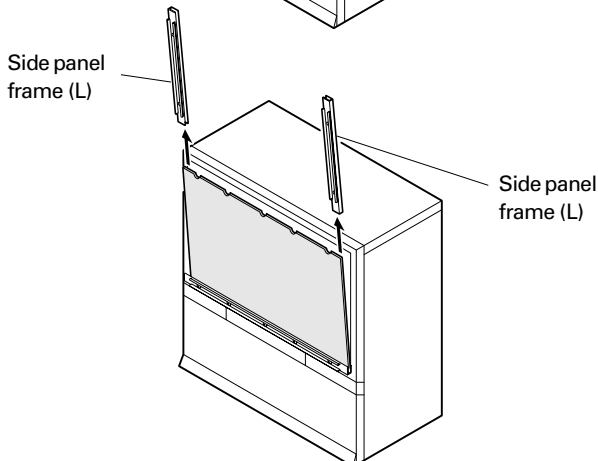
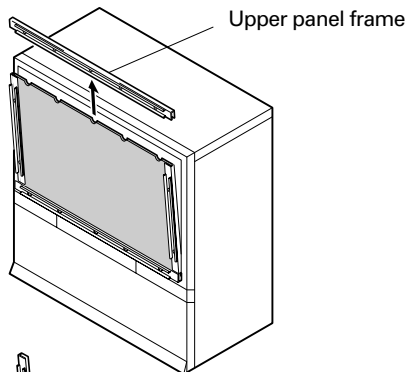

4. Remove the protective screen from the lower panel frame.

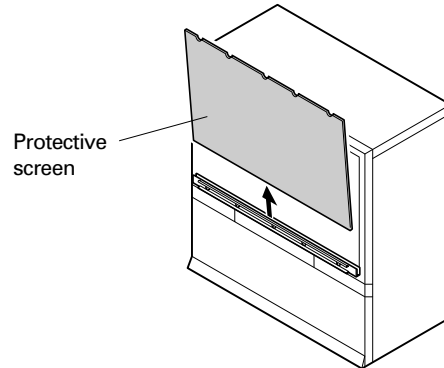

5. Remove the screws from the lower panel frame.

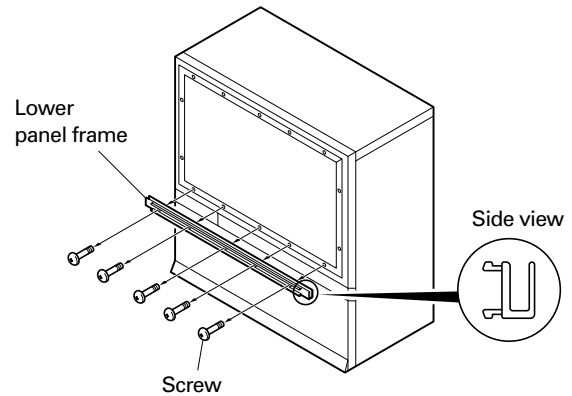

6. Reattach upper, lower and side panel frames as indicated then follow on HOW TO ATTACH THE FRAME COVER.

<UPPER SIDE VIEW>

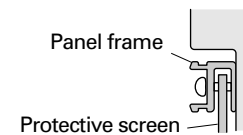

When the protective screen is attached.

<UPPER SIDE VIEW>

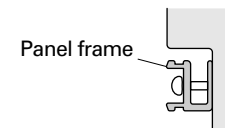

When the protective screen is not attached.
(Attach the panel frames reversed as shown in the figure.)

BEFORE USE

Before you watch the TV, perform the following procedure.

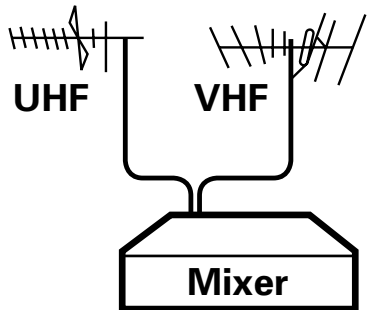

1

Connect the cables of the VHF antenna and UHF antenna to the ANTENNA A terminal. (See pages 14 and 15)

2

Connect the CATV converter to the ANTENNA B terminal. (See pages 14 and 15)

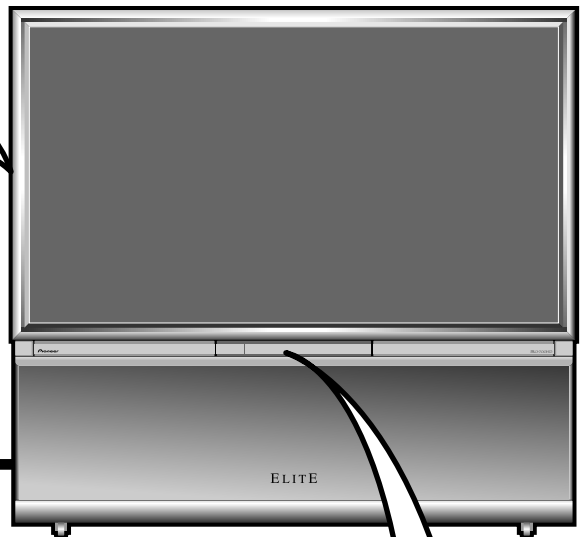
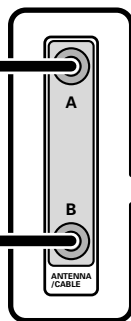
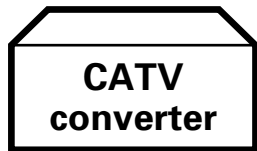

3

Connect the power cord to the AC wall socket.

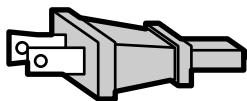

4

Turn on the MAIN POWER button.

When the MAIN POWER is on, the red STANDBY indicator lights up. In this state, the POWER STANDBY/ON button or the TV Power button of the remote control unit can be used to turn on and off the Monitor.

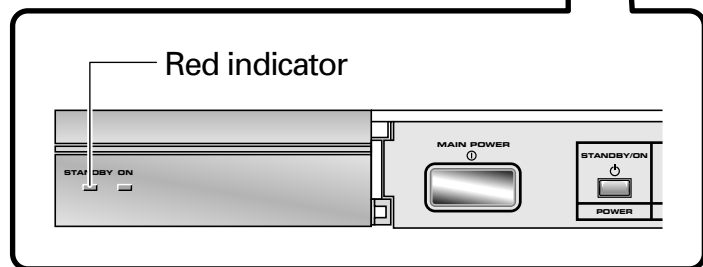

5

Inserting batteries into the remote control unit

1. Open the battery cover.

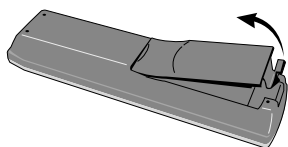

2. Insert batteries (two AA size batteries supplied with the product).

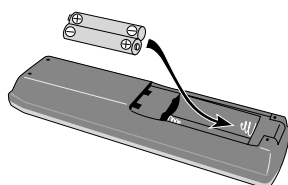

- Place batteries with their terminals corresponding to the (+) and (-) indicators in the battery compartment.

3. Close the battery cover.

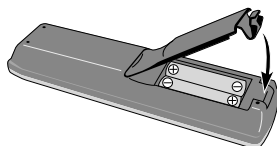

⚠ CAUTION

Incorrect use of batteries may lead to leakage or rupture. Always be sure to follow these instructions.

- A. Never mix new and used batteries.
- B. Batteries of the same size may have different voltages depending on their type. Do not mix different types of batteries.
- C. Insert batteries so that the plus (+) and minus (-) sides are aligned according to the markings in the battery case.
- D. When not using the remote control unit for a long period of time (1 month or more), remove the batteries from the remote control unit to prevent leaking of battery fluid. If battery liquid has leaked, thoroughly wipe the inside of the case unit all liquid is removed, and then insert new batteries.
- E. Do not charge, short, disassemble or throw the provided batteries in a fire.
- F. When disposing of used batteries, please comply with governmental regulations or environmental public instruction's rules that apply in your country or area.

Remote control operation range

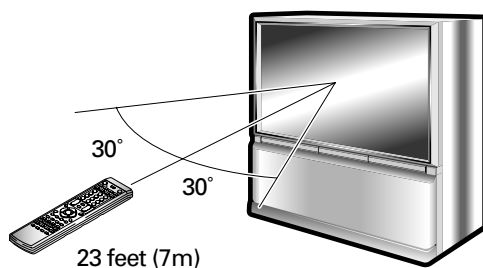

- Furniture and other obstacles may block the infrared light beam so that it cannot reach the sensor behind the Projection Monitor's screen.
- Performance of the remote control unit is adversely affected by strong fluorescent light. Keep such lights away from the screen.

Battery replacement

Replace the batteries when any of the following phenomena is observed.

- The transmitting LED does not blink even when the TV Power button is pressed.
- The remote control operation range has reduced.

When replacing the batteries, prepare new batteries before removing the old batteries.

Be sure to close the battery case cover after battery replacement.

NOTE:

- Even when batteries are removed, learned commands remain in memory for about 15 minutes.
- If you remove the batteries, and press any button, the memory is erased in a few seconds.

CONNECTING THE ANTENNA

- A good color picture depends on a good TV signal. So does good multichannel (stereo program and SAP) sound. Ask your dealer for advice on how to install your external antenna to receive the best possible signal.
- If you subscribe to Cable TV or have a central antenna for your building, you will not need an external antenna.

Connect the TV signal source to your Monitor properly. Use a 75-ohm coaxial cable with an F-type connector and connect the cable as shown in the illustration.

Connecting VHF/UHF antenna

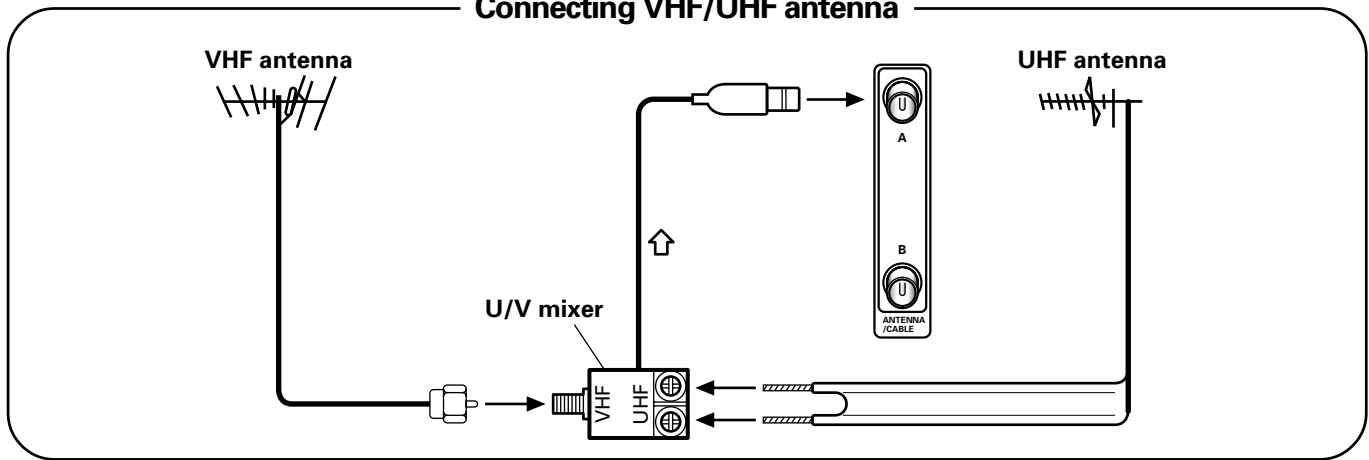

Connecting VHF/UHF antenna with VCR

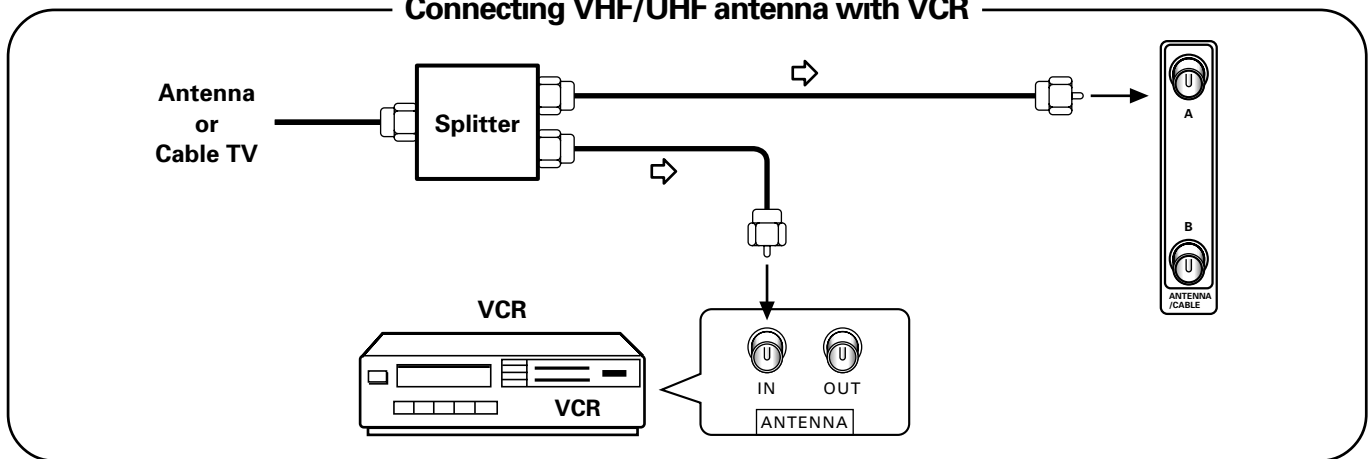

Connecting the CATV converter

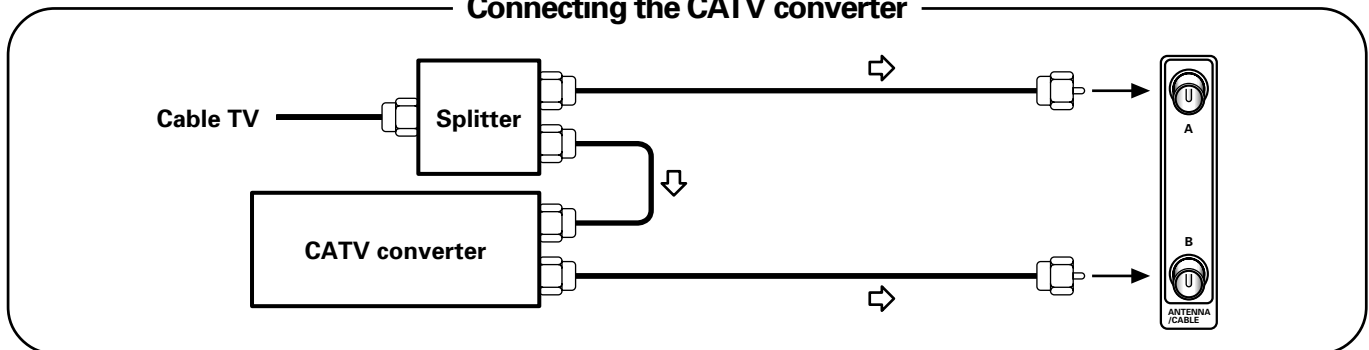

Connecting the CATV converter with VCR

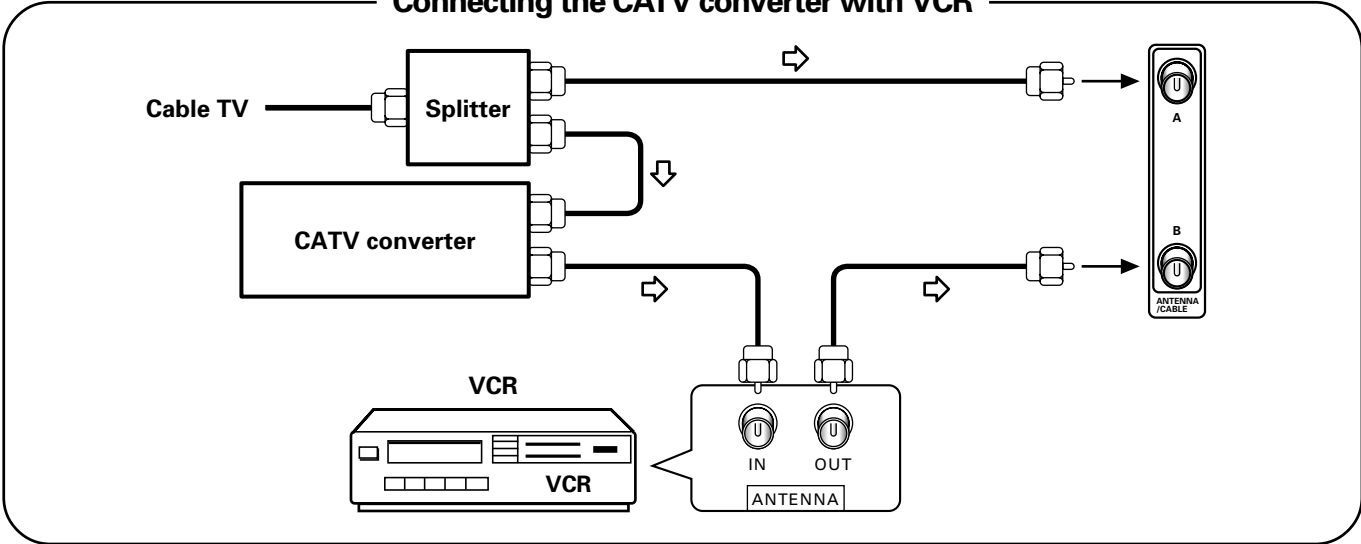

Connecting VHF/UHF antenna and CATV converter

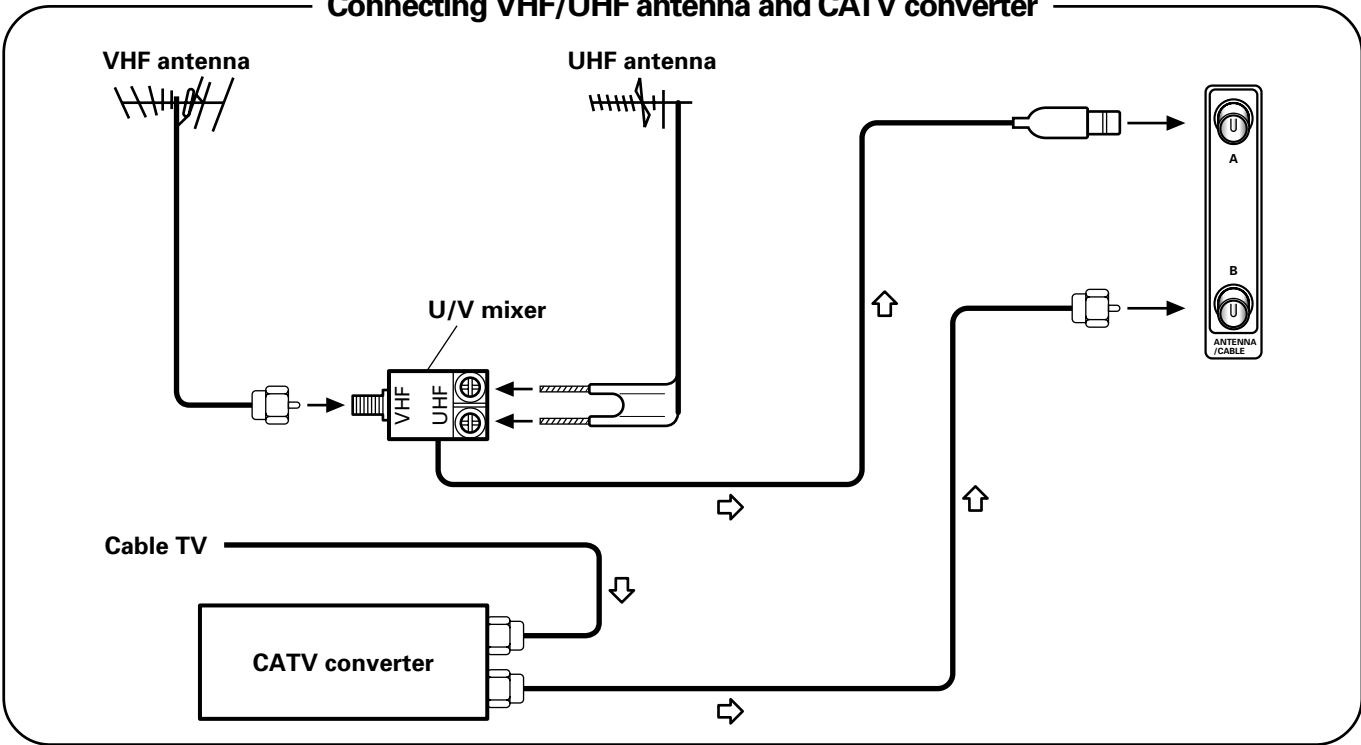

CONNECTING VIDEO/AUDIO EQUIPMENT

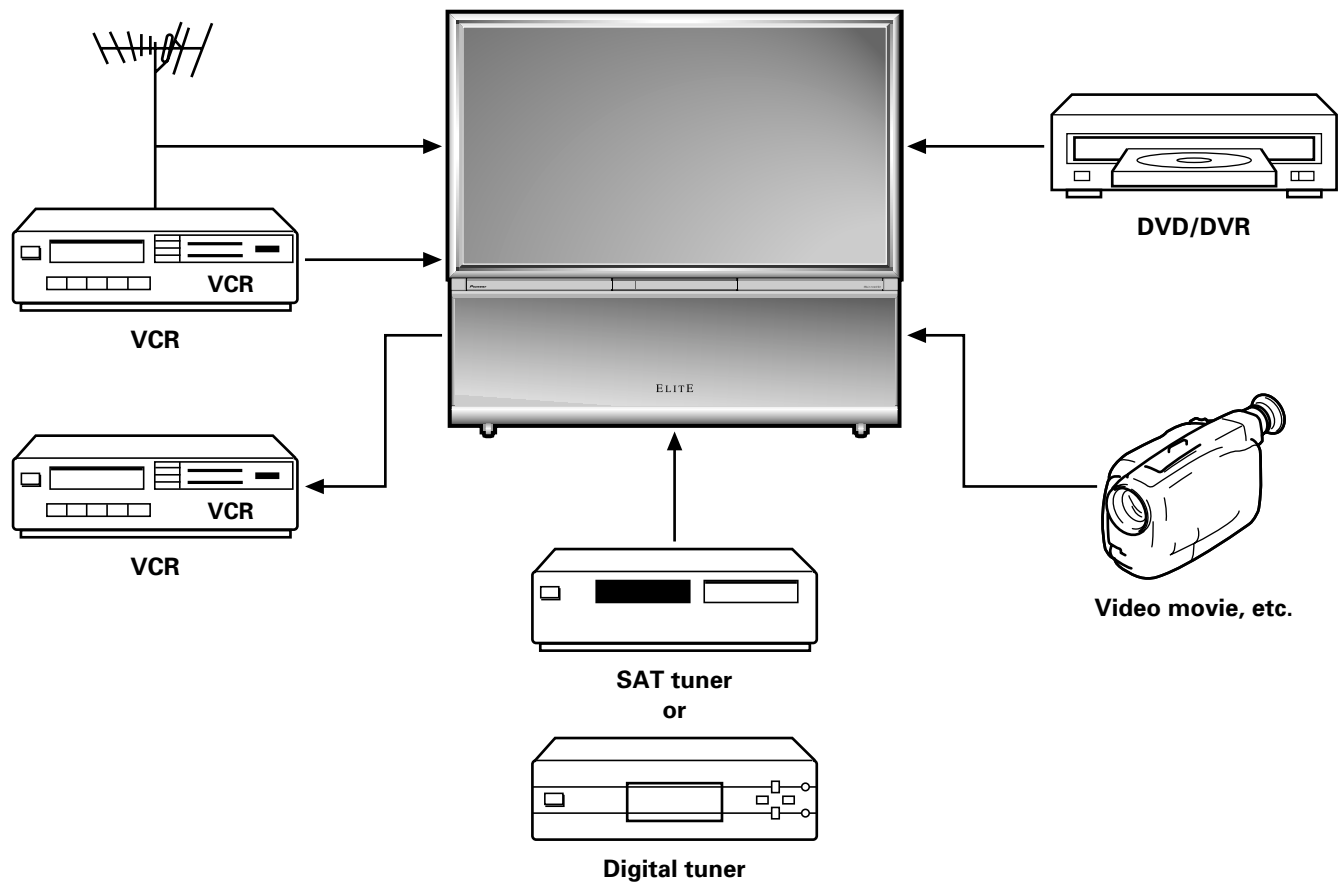

- Refer to the instructions of your VCR or DVD/DVR for the detailed connections.
- Before making or changing connections, set the power switch to off and unplug the power cord from the AC outlet.
- If both the VIDEO terminal (pin-jack type) and S-VIDEO terminal are connected, the signals from the S-VIDEO terminal will have priority.

- Only the INPUT 1 and INPUT 2 jacks can input the component video signal.
- When the component signal and other signals are input to the INPUT 1 or INPUT 2 jacks, the component signal will be given priority.

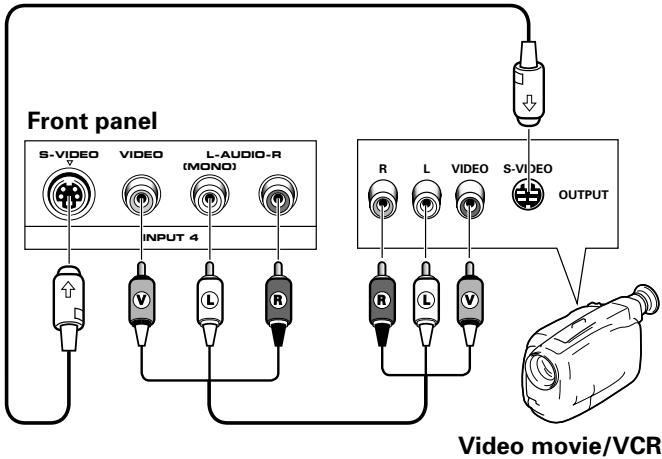

RGB INPUT jack

Inputs five signals – R, G, B, H and V – output from digital tuners and the like.

Input format in which images can be received.

	Format	Horizontal frequency	Vertical frequency
Digital tuner	1080 i	33.75 kHz	60 Hz

NOTES:

- SPLIT screen, FREEZE screen and SEARCH screen functions cannot be used when 1080i or 720p component signals are input.
- Signals from MONITOR/TV OUTPUT jacks will not be output when component signals or RGB signals are input.
- The RGB input jack is designed for use in connecting a digital tuner with RGB signal output, and it should accordingly never be used for connecting to a personal computer or other device.

INPUT jacks

The monitor is equipped with input jacks 1 to 6. Refer to the following explanation for information about each jack.

COMPOSITE VIDEO INPUT jacks

There are 4 sets of inputs for VCR and DVD/DVR. Use RCA-type pin plug cords (the same as those used in Hi-Fi systems) for connections. When the audio source to be connected is mono, connect the source to the L-(MONO) jack.

S-VIDEO INPUT jacks

- Inputs signals from a DVD/DVR that has an S-VIDEO output jack.
- When the signal input from the S-VIDEO INPUT jack is output from the MONITOR/TV OUTPUT jack, the output signal will be a composite of Y and C.

COMPONENT VIDEO INPUT jack

Inputs three signals – Y, P_B/ C_B and P_R/ C_R – output from DVD players and the like.

Input formats in which images can be received.

	Format	Horizontal frequency	Vertical frequency
DVD player, etc.	480 i	15.734 kHz	60 Hz
	480 p	31.468 kHz	60 Hz
Digital tuner, etc.	720 p	45.00 kHz	60 Hz
	1080 i	33.75 kHz	60 Hz
	480 p	31.468 kHz	60 Hz

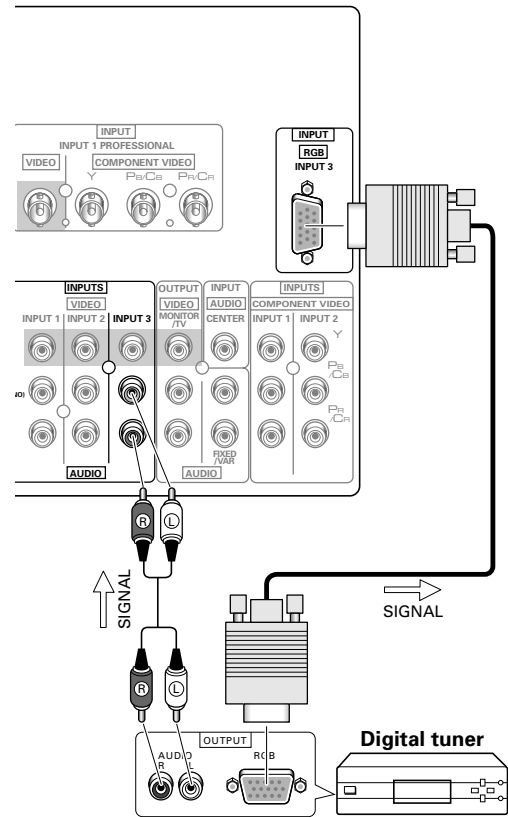

NOTE:

When the 3 signals, RGB signal, composite signal, and S signal, are simultaneously input to INPUT 3, the RGB signal will be displayed on screen.

DIGITAL INPUT jacks

This jack is used to connect devices with digital video output (digital set top box, DVD player, etc.) compatible with HDCP. Before attempting to connect one of these devices, read its operating instructions to make sure that it can be connected. (HDCP = High-bandwidth Digital Content Protection)

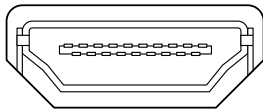

NOTES:

- This jack is used only for 1080i and 480p video signals.
- It is not a jack intended to be used with a personal computer.
- A separate conversion cable is required when attaching devices with a DVI connector.

MONITOR/TV OUTPUT jacks

These are used for connecting the monitor to a VCR for recording, or for linking it to another monitor. These jacks output the video and audio signals of the source currently selected by the INPUT SELECT. Connect these output jacks to your VCR's inputs. Connect the VCR's outputs to the monitor's VIDEO inputs.

When the system connection is ON, the jack is TV OUTPUT (refer to page 78).

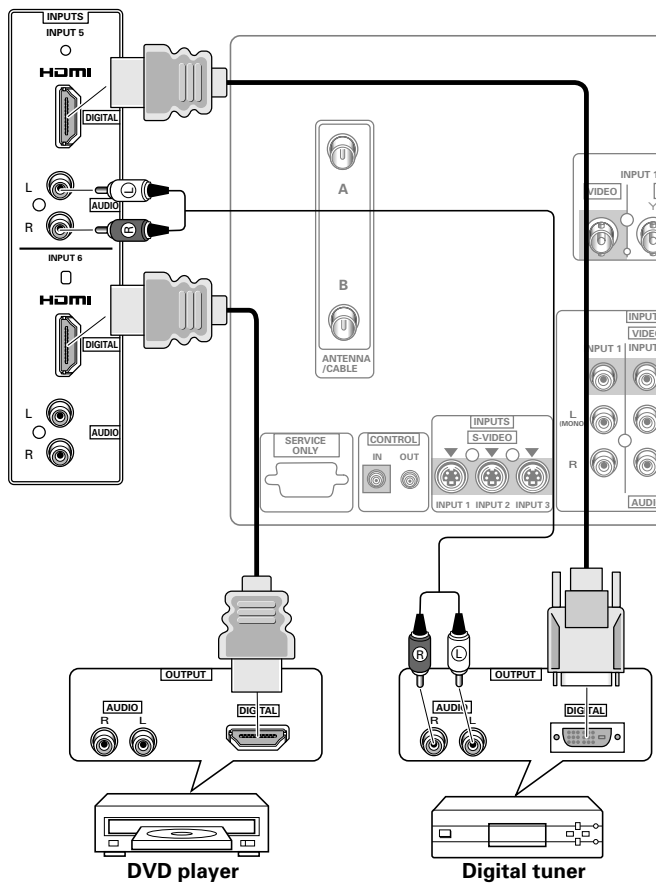

FRONT PANEL FUNCTIONS

A flip-down door conceals the INPUT 4 jacks. Push gently and release, to open the door. To close the door, lift it back up into place.

NOTE:

If you accidentally pull the door, it may not shut properly. Push the door back in to shut it.

① POWER STANDBY/ON indicators

red: STANDBY
green: when lit; ON
when flashing; power management in operation



② MAIN POWER ① (OFF/ON) button

If the button is OFF, the power of the monitor is shut off and ③ STANDBY/ON button on the monitor or TV power on the remote control will not function. Pressing the button again will turn the monitor ON and the monitor enters the standby mode. In the standby mode, you can turn on the monitor using the ③ STANDBY/ON button on the monitor or TV power on the remote control.

③ POWER (⏻) STANDBY/ON) button

Switches the monitor between on and standby (note that the monitor consumes a small amount of power (0.5W) in standby mode).

④ INPUT SELECT and SET button

Press to select your program source. Each press of the INPUT SELECT button changes the selection to the next source.

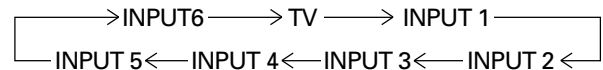

While the menu is displayed, it performs the same operation as the SET/ENTER button on the remote control.

⑤ CHANNEL +, - and ←, → buttons

Press plus (+) or minus (-) to tune to a higher or lower channel. Only the preset channels can be tuned in using these buttons. Press to select or adjust items on the menu screen.

⑥ MENU button

Press to turn the menu on.
Press again to return to normal TV screen.

⑦ VOLUME +, - and ↑, ↓ buttons

Press plus (+) button to increase the volume, press minus (-) button to decrease it.
Press to select or adjust items on the menu screen.

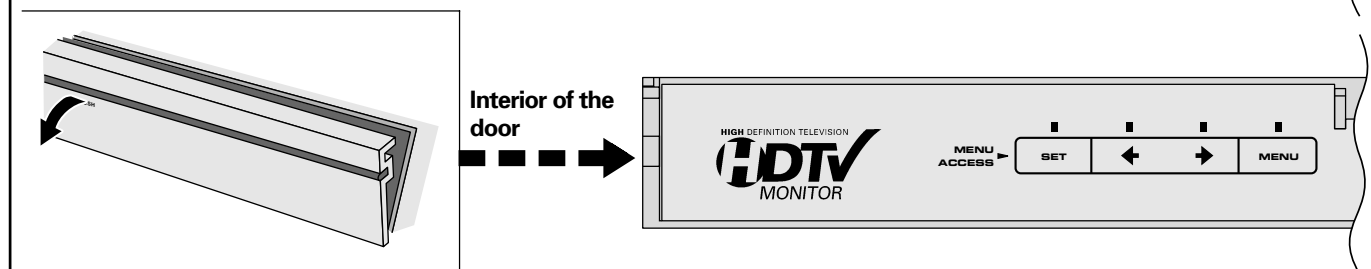
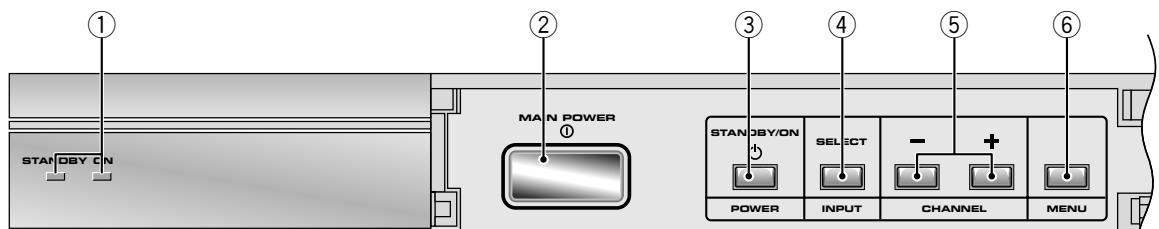

⑧ RESET button

Press to set the Projection Monitor to its initial mode.

Initial mode

Input selector:	Set to TV.
TV channel:	Remains at the last channel set.
VOLUME:	Remains at the last setting.
MUTING:	OFF
PICTURE	
MODE:	STD
Parameters:	Set to 0.
PureCinema:	OFF
COLOR TEMP:	STD
3D Y/C LEVEL:	3
3D NR LEVEL:	3
SVM:	HIGH
FLESH TONE:	ON
BLACK ENHANCE:	ON
SHARP EFFECT:	ON
SOUND	
MTS:	MAIN
Parameters:	Set to 0.
SURROUND:	OFF
STABLE VOLUME:	OFF
SCREEN	
SCAN MODE:	1080i
MODE:	NATURAL WIDE
CC:	OFF
SYSTEM IN/OUT	
SPEAKER:	NORMAL
AUDIO OUT:	FIXED
SYSTEM MODE:	OFF

NOTE:

When this button is pressed while adjusting the MULTI-POINT convergence, the MULTI-POINT convergence returns to the initial mode.

⑨ INPUT 4 jacks

These inputs are for Video Movie and VCR. Use RCA-type pin plug cords (the same as those used in Hi-Fi systems) and S-VIDEO cords for connections. When the audio source to be connected is mono, connect the source to the L-(MONO) jack.

CAUTION:

Do not press any operation button on the Projection Monitor or the remote control unit while recording. Signals from the MONITOR/TV OUTPUT jacks may be temporarily interrupted when a button is pressed.

ATTENTION

The Projection Monitor will not function properly in the following cases.

- An electrical discharge in the CRT.
- Lightning storms.
- High static electricity environment.
- Poor voltage regulation in the power source.

If the Projection Monitor does not operate properly, reset it as follows:

1. Turn off the power of the unit with the ② MAIN POWER button.
2. After approximately 1 minute, turn on the power with ② MAIN POWER button and ③ POWER (⏻ STANDBY/ON) button.

If the normal operation cannot be restored after the above treatment, immediately unplug the power cord and call your nearest PIONEER-authorized service center.

NOTES:

- On rare occasions, an electrical discharge may occur inside the CRT*. It makes a short, sharp pop and either no sound is produced or the volume level changes by itself. The SPLIT screen and SEARCH screen functions will be cancelled automatically if an electrical discharge occurs when this function is engaged.
*CRT: Cathode-ray Tube
- When an electrical discharge distorts the screen and the TV power has been automatically shut off, it can turn on. If you notice any abnormality of the screen, turn off the MAIN POWER button for a few minutes then turn it on. This is not a malfunction.

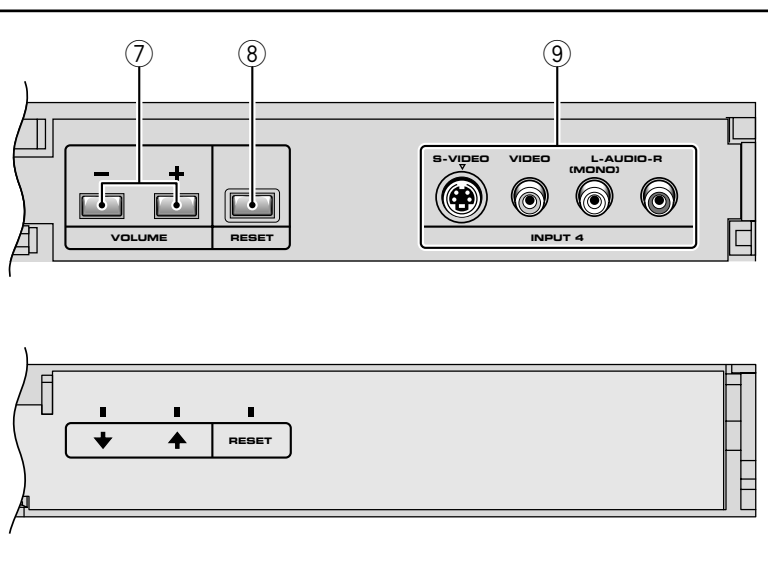

REMOTE CONTROL UNIT FUNCTIONS

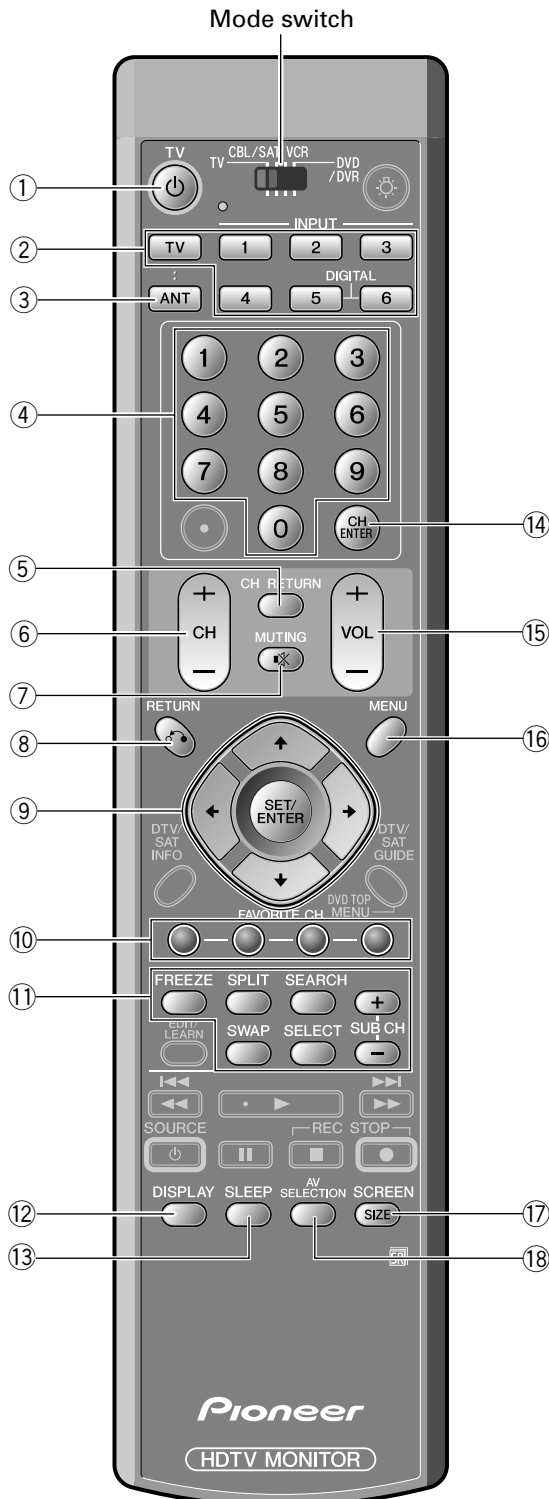

Set the mode switch to TV.

- ① **TV Power button (STANDBY/ON)**
Turns the power of the monitor on and off.
- ② **INPUT Selector buttons (TV, INPUT 1 to INPUT 6)**
Press the button to select the source you wish to watch. The screen will display your selection.
- ③ **ANT (antenna selector) button**
Press to switch between ANTENNA-A and ANTENNA-B when you wish to watch TV.
- ④ **Direct channel selection buttons**
Press the button (or buttons) that corresponds to the channel that you wish to watch.
- ⑤ **CH RETURN (channel return) button**
Press to switch between the current channel and the channel you were watching immediately before.
- ⑥ **CH (channel) +, - button**
Press plus (+) or minus (-) to tune in a higher or lower channel. Only the preset channels can be tuned in using these buttons.
- ⑦ **MUTING button**
Press to temporarily turn off the sound. Press again to return to the previous volume level.
- ⑧ **RETURN button**
Returns to the previous menu screen.
- ⑨ **Select/Adjust/Set buttons (SET/ENTER, ←, →, ↑, ↓)**
←, →, ↑, ↓: Press to select or adjust items on the menu screen.
SET/ENTER: Press to activate the selected function.
- ⑩ **FAVORITE CH buttons**
These buttons call up the channels that have been assigned to them.

⑪ **SPLIT/SEARCH screen buttons**

- FREEZE:** When this button is pressed with the regular screen, the screen will change to the SPLIT screen and the picture at the time the button was pressed will become the sub-picture, displayed as a frozen image.
- SPLIT:** Press to turn the SPLIT screen function on and off.
- SEARCH:** Press to select the SEARCH screen mode.
- SWAP:** Press to switch the main picture and sub picture when in SPLIT or 3-SEARCH screen mode.
- SELECT:** Selects the screen for switching the channel or input source.*
- SUB CH +, -:** Used to switch the channel for the sub-picture of the SPLIT screen.

⑫ **DISPLAY button**

Press to display the input source, channel, setting and other screen indicators for a few seconds.

⑬ **SLEEP timer button**

Each time this button is pressed, the display will change as follows.
The display varies according to the remaining time.

Example:

If the remaining time is 100 minutes

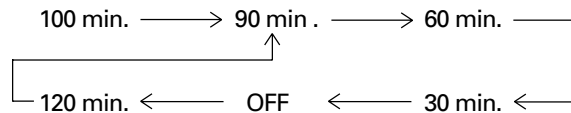

If the remaining time is 45 minutes

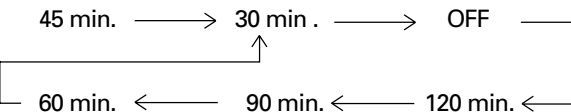

⑭ **CH ENTER button**

Fix the selected channel with the direct channel selection buttons.

⑮ **VOL (volume) +, - buttons**

Press plus (+) button to increase the volume, press minus (-) button to decrease it.
Volume level will appear on the screen as numbers and a bar graph. The maximum volume level is "63".
The display will disappear from the screen after 2 seconds.

⑯ **MENU button**

Press to turn on the menu screen for use in function selection.
Press again to return to normal TV screen.

⑰ **SCREEN SIZE button**

Press to select the SCREEN MODE. (Refer to page 41.)

⑱ **AV SELECTION button**

Selects on video setting. (PICTURE MODE: STD, REF, THEATER, GAME, USER, PRO)

* With the 9 screen, the search picture's input source and channel cannot be switched.

TO WATCH TV

Best Horizontal and Vertical Viewing Angle

- The optimum viewing angle is 140° in horizontal and 45° in vertical.
- Watch from at least 10 feet (3m) away from the screen (optimum viewing distance is 10 to 23 feet).

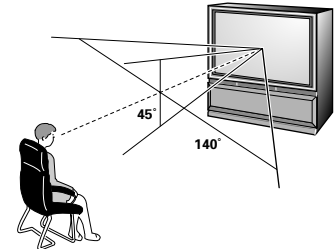

Remote control unit

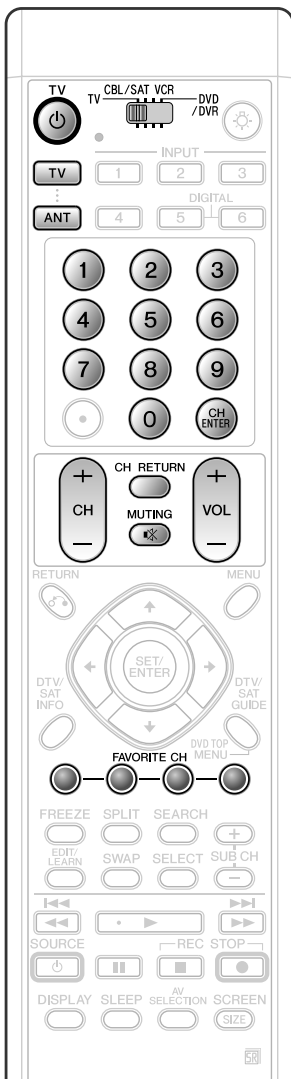

Control panel of the monitor

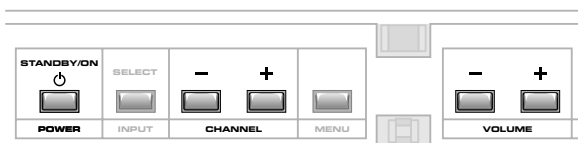

Turn on the MAIN POWER button.

1 Turn on the POWER.

The green ON indicator lights up.

Remote control unit

Control panel of the monitor

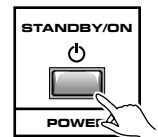
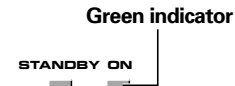

2 Set the mode switch to TV and then press the TV button.

Remote control unit

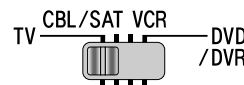

3 Select antenna A or B.

Check the input signals at the ANTENNA A and B terminals.

Remote control unit

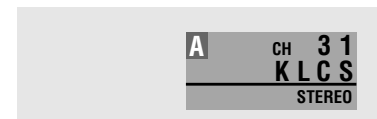

4 Select a channel.

There are three methods for this.

① Select by pressing the number button

(Example)

Channel 5



(Or press 0 and then press 5 within 2 seconds of during so.)

Channel 12

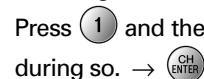

Press 1 and then press 2 within 2 seconds of during so. →

- After pressing a number button, even if you do not press the CH ENTER button, the channel will be switched to the one selected within 2 seconds.
- Depending on the channel, this switch may occur immediately after the number button is pressed.

	VHF L	MID	VHF H	SUPER	HYPER									UHF	
TV	2-6	—		7-13	—									14-69	
CATV	2-6 (STD)	A-5(95)	A(14)	7-13	J(23) Q(30)	W+1(37)	W+11(47)	W+21(57)	W+31(67)	W+41(77)	W+51(87)	W+61(102)	W+71(112)	W+81(122)	—
		A-4(96)	B(15)		K(24) R(31)	W+2(38)	W+12(48)	W+22(58)	W+32(68)	W+42(78)	W+52(88)	W+62(103)	W+72(113)	W+82(123)	
		A-3(97)	C(16)		L(25) S(32)	W+3(39)	W+13(49)	W+23(59)	W+33(69)	W+43(79)	W+53(89)	W+63(104)	W+73(114)	W+83(124)	
		A-2(98)	D(17)		M(26) T(33)	W+4(40)	W+14(50)	W+24(60)	W+34(70)	W+44(80)	W+54(90)	W+64(105)	W+74(115)	W+84(125)	
		A-1(99)	E(18)		N(27) U(34)	W+5(41)	W+15(51)	W+25(61)	W+35(71)	W+45(81)	W+55(91)	W+65(106)	W+75(116)		
		F(19)	O(28) V(35)		W+6(42)	W+16(52)	W+26(62)	W+36(72)	W+46(82)	W+56(92)	W+66(107)	W+76(117)			
		G(20)	P(29) W(36)		W+7(43)	W+17(53)	W+27(63)	W+37(73)	W+47(83)	W+57(93)	W+67(108)	W+77(118)			
		H(21)			W+8(44)	W+18(54)	W+28(64)	W+38(74)	W+48(84)	W+58(94)	W+68(109)	W+78(119)			
		I (22)			W+9(45)	W+19(55)	W+29(65)	W+39(75)	W+49(85)	W+59(100)	W+69(110)	W+79(120)			
					W+10(46)	W+20(56)	W+30(66)	W+40(76)	W+50(86)	W+60(101)	W+70(111)	W+80(121)			

CABLE (CATV) CHANNEL ASSIGNMENT TABLE

In the cable tuning mode, channels can only be assigned to numbers 01 to 125. The specific channel number assignments and the corresponding alphabet designation are shown at the bottom left of the channel table.

For example: Channel number '14' corresponds to midband cable channel 'A'.

NOTE:

Cable (CATV) services can vary according to area. The channel number assignments shown in the channel table may not correspond with the channel numbers used by your local cable company. Direct tuning to cable channels without using the cable company converter 'or preselector' will depend on the specific channels in use by the cable company. Direct tuning to cable channels is limited to unencoded (unscrambled) channels only. Check with your local cable company for compatibility requirements.

To turn off the sound

Press the MUTING button.



When mute is turned on, a volume indicator will appear in red on the screen (and will disappear in a few seconds).

When you have selected ON IF MUTE on menu screen, if the MUTING is pressed while a closed caption signal is being received, CC/TEXT will be displayed. (Refer to page 46.)

Press MUTING again to return to the previous volume level.

Auto power off function

If the monitor is receiving no input signals in TV mode, its power will turn off (go on standby) after some time has passed.

② Select using the TV CH+/- button

The channels will switch according to the order set by channel preset. (See page 28.)

Remote control unit

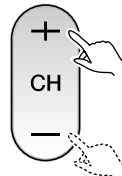

Control panel of the monitor

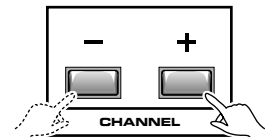

③ Select using the FAVORITE CH button

Select your desired channel from the 4 in the memory of each button: blue, green, red and yellow.

Remote control unit



- Each time the button is pressed, the channel will be changed in order of the 4 channels in that button's memory.
- The desired channels can be set. (See page 50.)
- When you select a channel using the FAVORITE CH button, step 3 (Select antenna A or B) is not necessary.

5 Adjust the volume.

Remote control unit

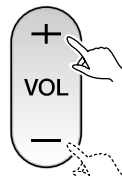

Control panel of the monitor

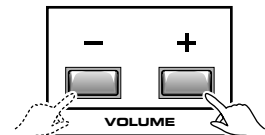

CHECKING THE MENU

Press MENU on the remote control unit.
 The MAIN MENU will be displayed on the screen.
 Select the desired menu item using ← or → button of the remote control unit, and press ↑ or ↓ button to perform the desired operations or mater settings.
 It can also be operated using the buttons on the front of the monitor.

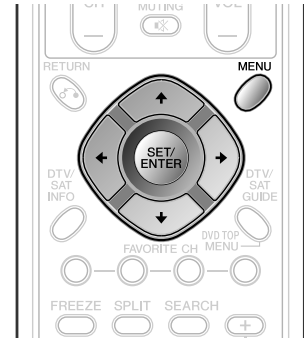

PICTURE adjustment menu (See page 52)

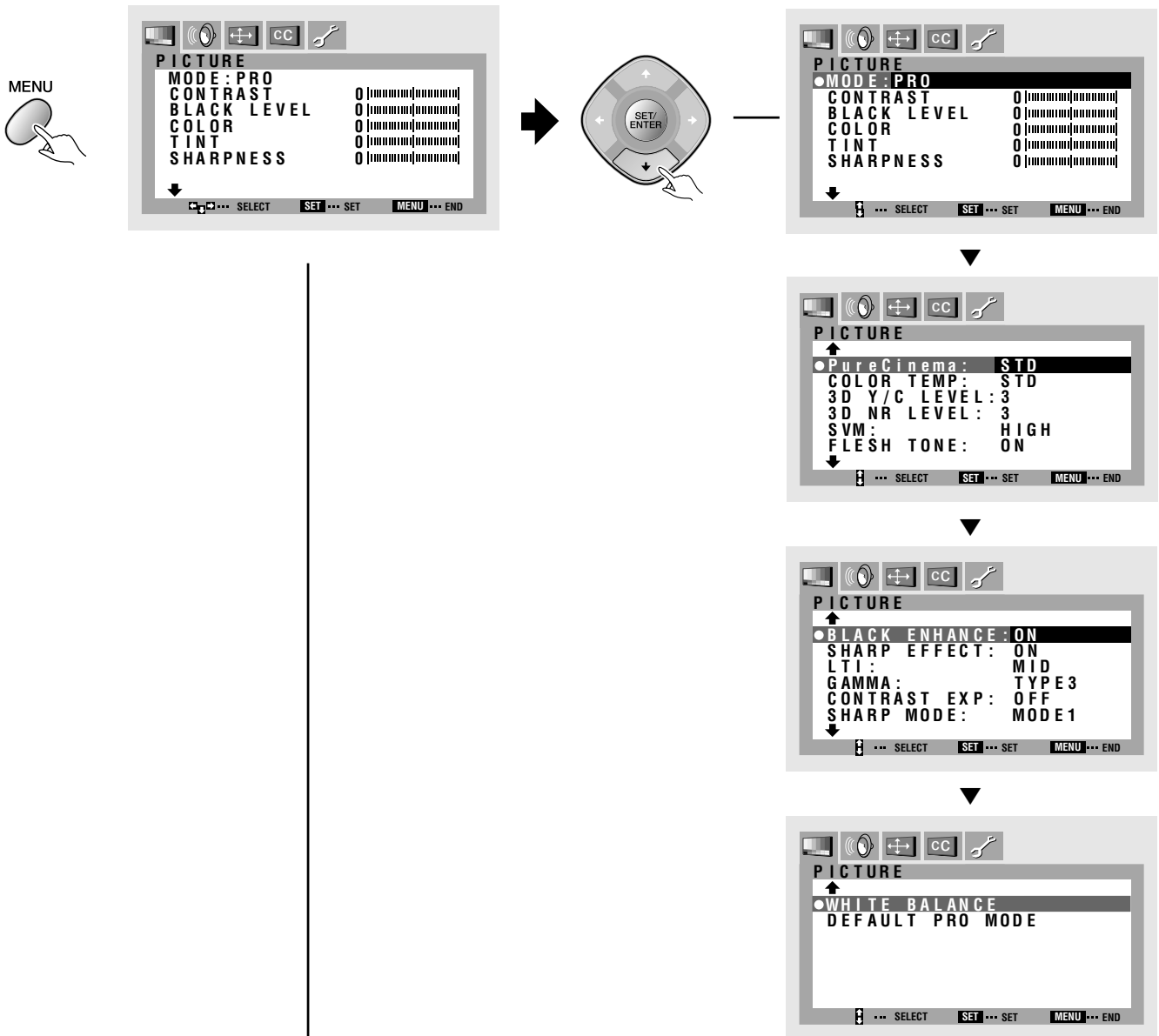

SOUND adjustment menu (See page 64)

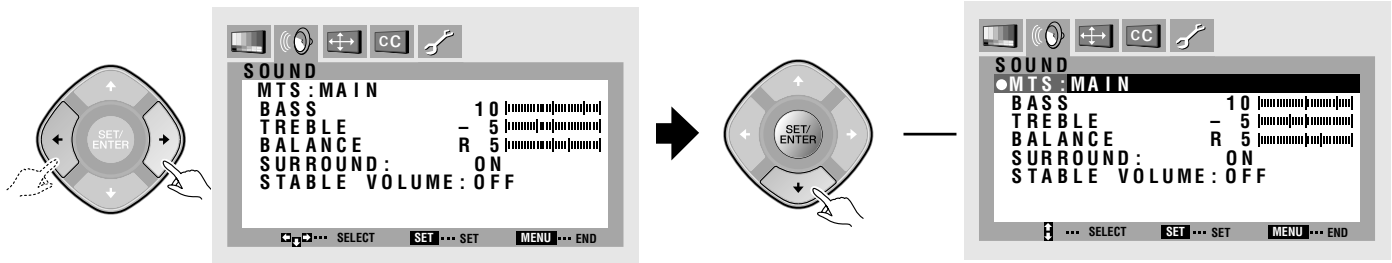
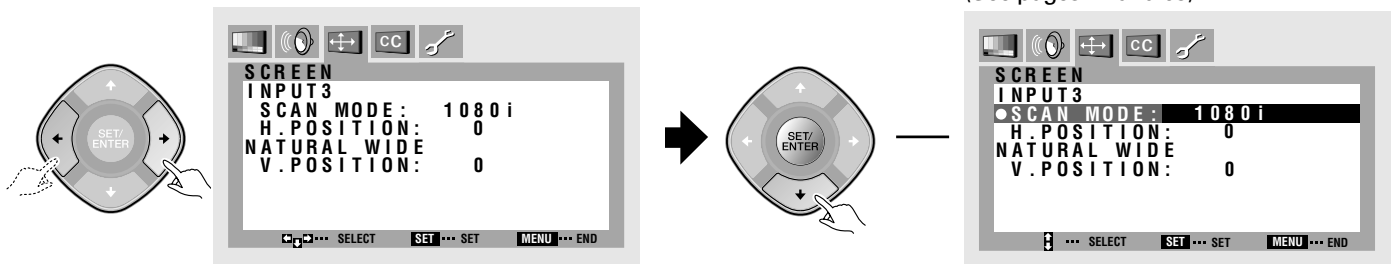
SCREEN setting menu
(See pages 42 and 63)

Closed Caption menu (See page 46)

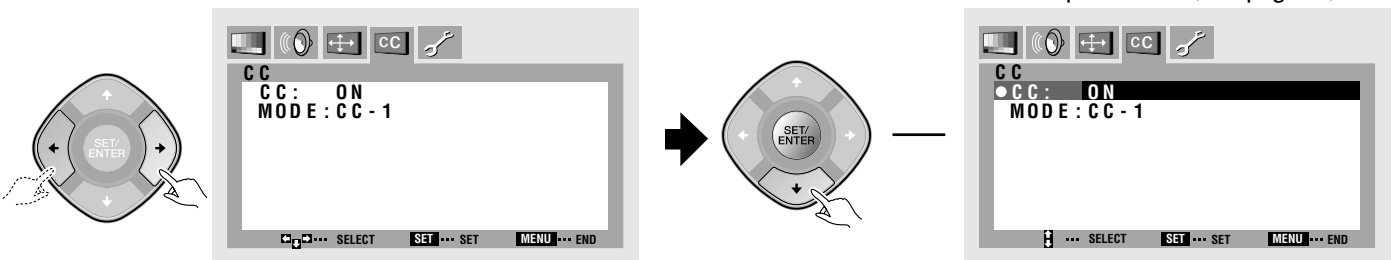
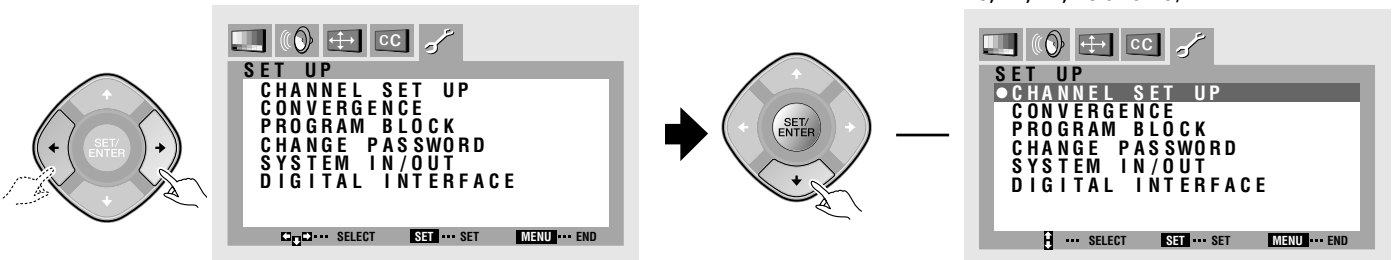
SET UP menu
(See pages 28, 30, 34, 39, 47, 50, 68, 69, 70, 71, 72, 76 and 79)**On screen indicators**

SELECT: Use arrow key to switch function on menu screen.

SET: Press SET/ENTER to select the desired function on menu screen.

END: End is for turning off the menu screen by pressing the MENU button.

EXIT: To return to the previous menu screen, use the **↑** or **↓** button to move to EXIT and then press SET/ENTER.

AUTO CHANNEL PRESET

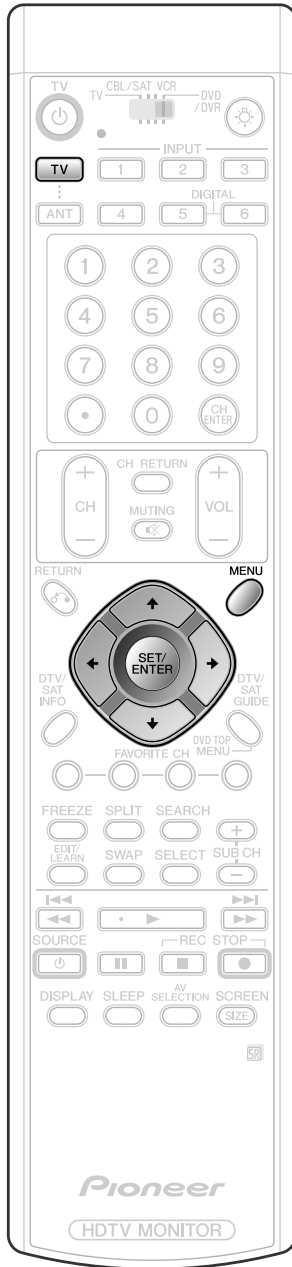

The broadcast frequencies that can be received depend on your area. Memorize the broadcast stations that can be received in your area in the presets.

1 Select TV.



2 Press MENU and select SET UP by using the ← or → button and then pressing ↓ button. (Refer to page 26.)

3 Select CHANNEL SET UP in the same way.

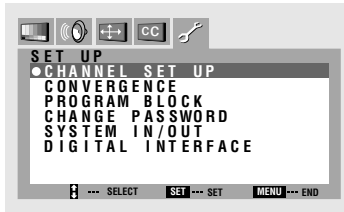
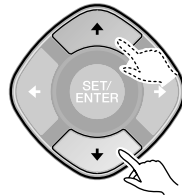

4 Select AUTO CHANNEL PRESET .

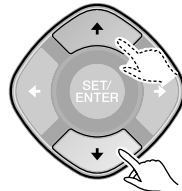

5 Select ANTENNA , then select A or B.

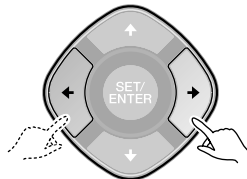
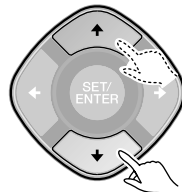

NOTES:

- The CHANNEL SET UP cannot be selected unless the function is set up for TV.
- Failure to connect antenna cable in this procedure will result in selection of a single TV channel.

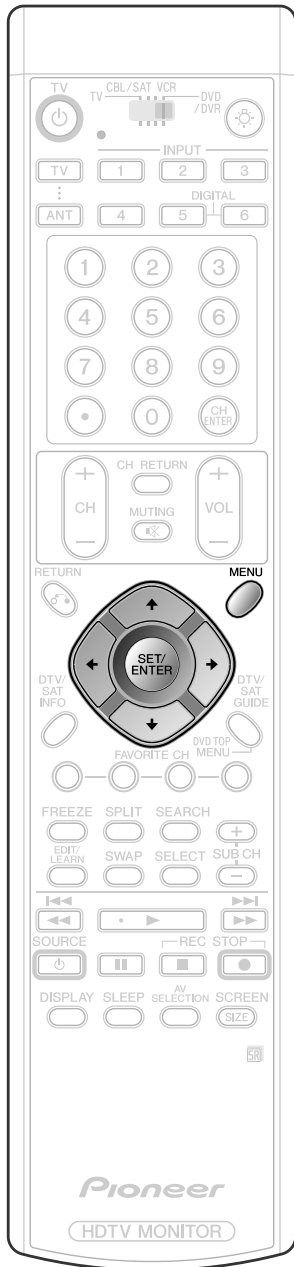

NOTE:
If AUTO CHANNEL PRESET is not performed, refer to the steps on page 47 and onwards to preset channels.

6 Select TV/CABLE MODE , then select the broadcast system to be received from AIR or CATV.

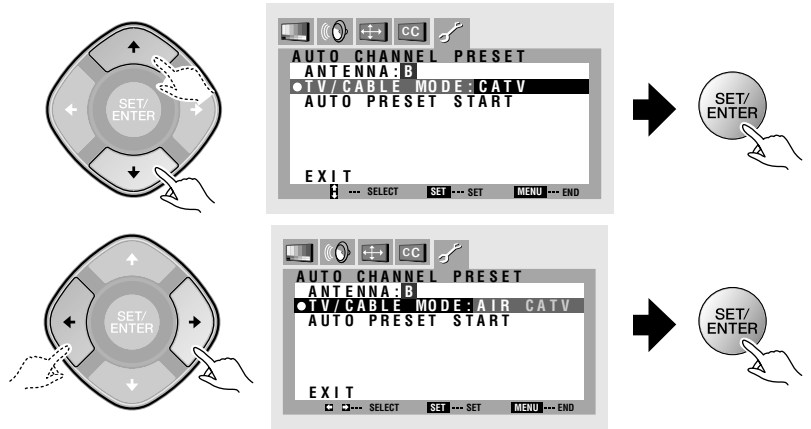

7 Select AUTO PRESET START .

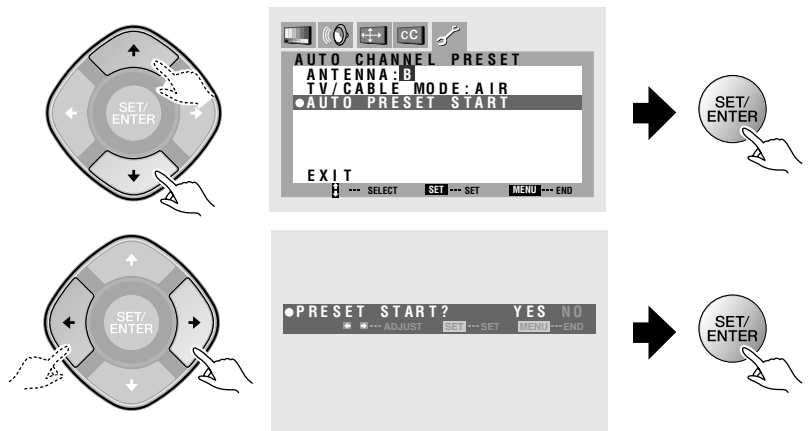

- AUTO CHANNEL PRESET starts.

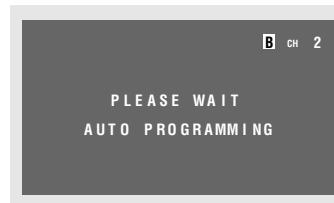

- When AUTO CHANNEL PRESET ends, the Monitor will return to step 5. Perform steps 5 through 7 if the other antenna is also used.
- You can give a name to broadcast channels that have been stored in memory with AUTO CHANNEL PRESET. (Refer to page 47 to 49.)

8 After setting, press MENU to turn the menu off.

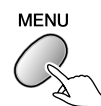

CONVERGENCE ADJUSTMENT

Before convergence adjustment*¹, please choose a stabilized input signal*² in order to display a stable cross pattern.

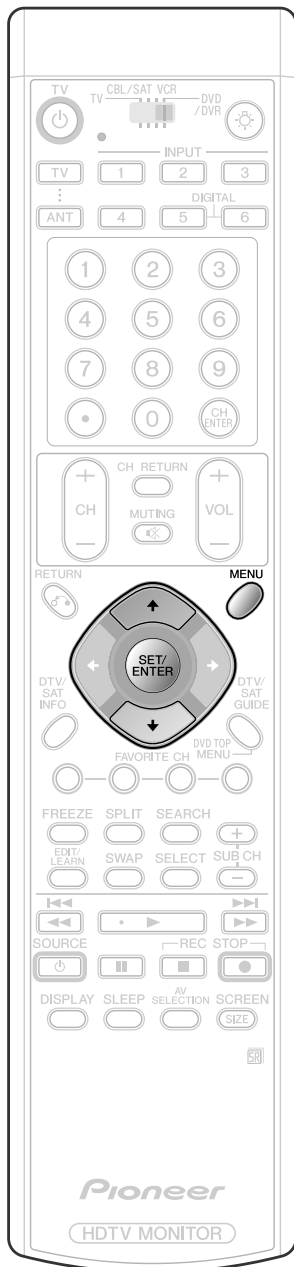

*1 Convergence adjustment Color deviation adjustment

*2 Stabilized input signal Examples, DVD player, digital tuner, etc.

Due to the differing magnetic fields in different locations, you may experience color deviation, that is inaccurate colors. This is called misconvergence. If your colors seem inaccurate, realign the color convergence with the method below. Before doing this make sure you warm up the TV for at least 30 minutes. A color convergence for each of 2 scan mode is necessary 480p and 1080i.

1 Press **MENU** and select **SET UP** by using the **←** or **→** button and then pressing **↓** button. (Refer to page 26.)

2 Select **CONVERGENCE** in the same way.

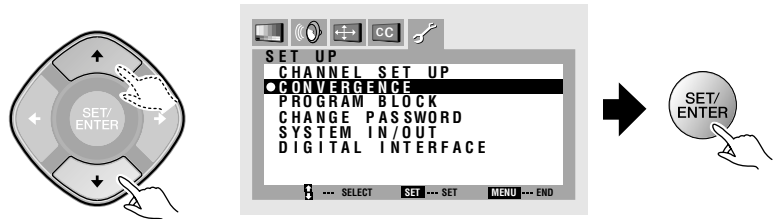

3 Select scan mode.

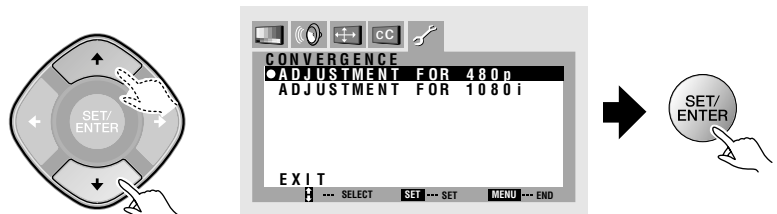

- This accesses the center convergence adjustment.

When the cross pattern is white

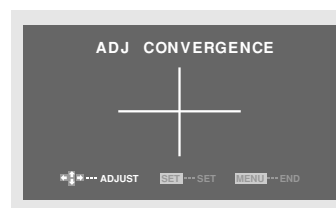

The color is converged. Press SET/ENTER button twice, proceed onto page 73 and perform MULTI-POINT convergence.

If the cross pattern shows other colors or when one side of the white line is red or blue

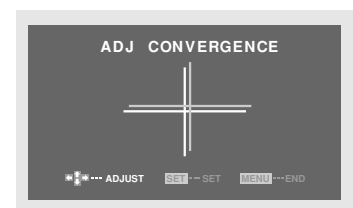

This indicates that the color is misconverged. Proceed to step 4 and perform the adjustment.

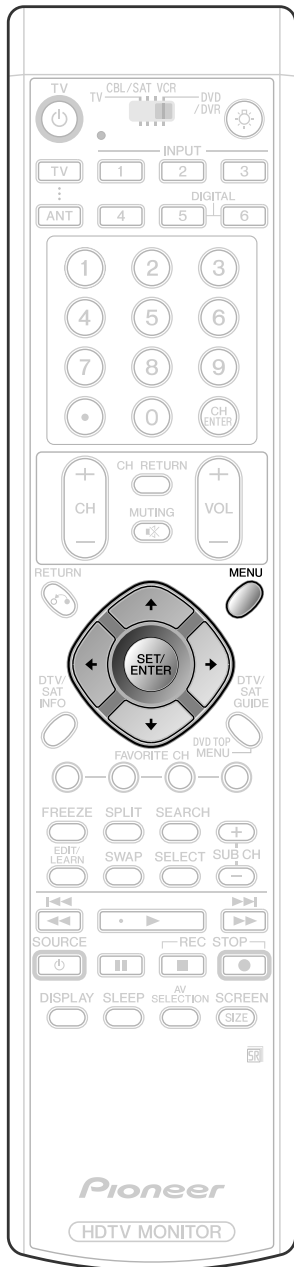

4 Move the red line onto the green line.

Move the vertical line.

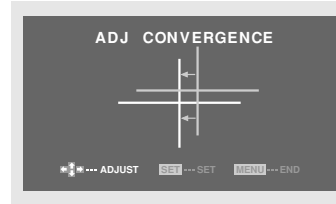
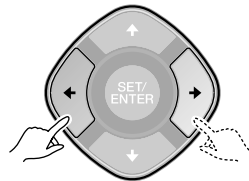

Move the horizontal line.

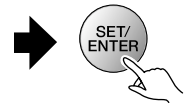
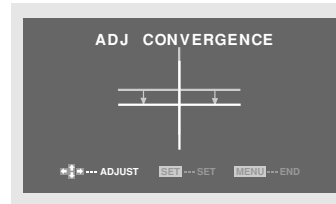
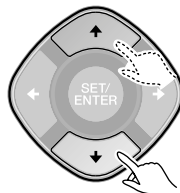

5 Move the blue line onto the yellow line.

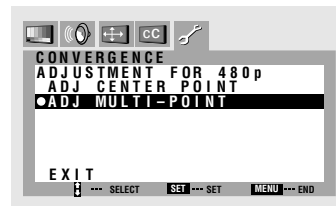
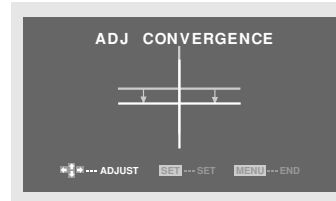
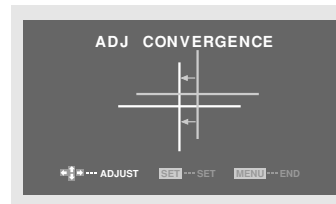
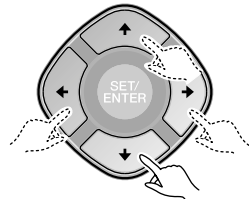

- When ADJ CENTER POINT is selected, center convergence adjustment will be accessed.
- Select ADJ MULTI-POINT to perform fine convergence tuning. See page 73 for further information on multi-point convergence adjustment.

6 After completing the convergence adjustment, press MENU to turn the menu off.

PROGRAM BLOCK (V. CHIP) FUNCTION

Since laws have been passed in the United States requiring a way of blocking undesirable programming, the V-chip has become a required component in television sets. The V-chip is a computer chip which decodes signals added to broadcast signals transmitted by television broadcasters. These signals are classified by programming content (e.g., amount of violence or sexual content) and age, and viewers may specify settings which block certain types of programming. Program blocking may be set to a specific level judged by parents to be undesirable for children depending on their age and the content of the programming in question. The V-chip makes it impossible for such children to view programs with ratings exceeding the specified level.

The V-chip uses the following rating system.

<U.S.A. RATING SYSTEM>

MPAA RATING

RATING		
Age-Base	G	GENERAL AUDIENCES. All ages admitted.
	PG	PARENTAL GUIDANCE SUGGESTED. Some material may not be suitable for children.
	PG-13	PARENTAL STRONGLY CAUTIONED. Some material may be inappropriate for children under 13.
	R	RESTRICTED. Under 17 requires accompanying parent or adult guardian.
	NC-17	NO ONE 17 AND UNDER ADMITTED.
	X	X Rating is an older rating that is the same as NC-17 and may be encoded on the data of older movie.
	NR	NOT RATED

TV PARENTAL GUIDELINES

RATING		Description and Content Themes				
		FV	D	L	S	V
Age-Base	TV-Y	–	–	–	–	–
	TV-Y7	○	–	–	–	–
	TV-G	–	–	–	–	–
	TV-PG	–	○	○	○	○
	TV-14	–	○	○	○	○
	TV-MA	–	–	○	○	○

FV: Fantasy Violence
D: Sexually Suggestive Dialog
L: Adult Language
S: Sexual Situations
V: Violence

TV-Y All Children. This program is designed to be appropriate for all children.

TV-Y7 Directed to Older Children. This program is designed for children age 7 and above.
Note: For those programs where fantasy violence may be more intense or more combative than other programs in this category, such programs will be designated TV-Y7-FV.

TV-G General Audience. Most parents would find this program suitable for all ages.

TV-PG Parental Guidance Suggested. This program contains material that parents may find unsuitable for younger children.
The program contains one or more of the following:
(D) Some suggestive dialogue
(L) Infrequent coarse language
(V) Moderate violence
(S) Some sexual situations

TV-14 Parents Strongly Cautioned. This program contains some material that many parents would find unsuitable for children under 14 years of age.
This program contains one or more of the following:
(D) Intensely suggestive dialogue
(L) Strong coarse language
(S) Intense sexual situations
(V) Intense violence

TV-MA Mature Audience Only. This program is specifically designed to be viewed by adults and therefore may be unsuitable for children under 17.
This program contains one or more of the following:
(L) Crude indecent language
(S) Explicit sexual activity
(V) Graphic violence

<CANADIAN RATING SYSTEM>**CANADIAN ENGLISH LANGUAGE RATING SYSTEM**

RATING		
Age-Base	C	Children
	C8+	Children 8 years and older
	G	General programming, suitable for all audiences
	PG	Parental Guidance
	14+	Viewers 14 years and older
	18+	Adult Programming

- C** Programming intended for children under age 8
Careful attention is paid to themes, which could threaten children's sense of security and well-being. There will be no realistic scenes of violence. Depictions of aggressive behaviour will be infrequent and limited to portrayals that are clearly imaginary, comedic or unrealistic in nature.
- C8+** Programming generally considered acceptable for children 8 years and over to watch on their own
Violence will not be portrayed as the preferred, acceptable, or only way to resolve conflict; or encourage children to imitate dangerous acts which they may see on television. Any realistic depictions of violence will be infrequent, discreet, of low intensity and will show the consequences of the acts.
- G** General Audience
Will contain very little violence, either physical or verbal or emotional. Will be sensitive to themes which could frighten a younger child, will not depict realistic scenes of violence which minimize or gloss over the effects of violent acts.
- PG** Parental Guidance
Programming intended for a general audience but which may not be suitable for younger children. Parents may consider some content inappropriate for unsupervised viewing by children aged 8-13.
- 14+** Programming contains themes or content which may not be suitable for viewers under the age of 14
Parents are strongly cautioned to exercise discretion in permitting viewing by pre-teens and early teens.
- 18+** Adult
May contain violence integral to the development of the plot, character or theme, intended for adult audiences.

CANADIAN FRENCH LANGUAGE RATING SYSTEM

RATING		
Age-Base	G	General
	8+	Children 8 years and older
	13+	Viewers 13 years and older
	16+	Viewers 16 years and older
	18+	For Adults

- G** General
Programming intended for audience of all ages. Contains no violence, or the violence it contains is minimal or is depicted appropriately with humour or caricature or in an unrealistic manner.
- 8+** 8+ General – Not recommended for young children
(8 ans+) Programming intended for a broad audience but contains light or occasional violence that could disturb young children. Viewing with an adult is therefore recommended for young children (under the age of 8) who cannot differentiate between real and imaginary portrayals.
- 13+** Programming may not be suitable for children under the age of 13
(13 ans+) Contains either a few violent scenes or one or more sufficiently violent scenes to affect them. Viewing with an adult is therefore strongly recommended for children under 13.
- 16+** Programming is not suitable for children under the age of 16
(16 ans+) Contains frequent scenes of violence or intense violence.
- 18+** Programming restricted to adults
(18 ans+) Contains constant violence or scenes of extreme violence.

SETTING THE PROGRAM BLOCKING LEVEL

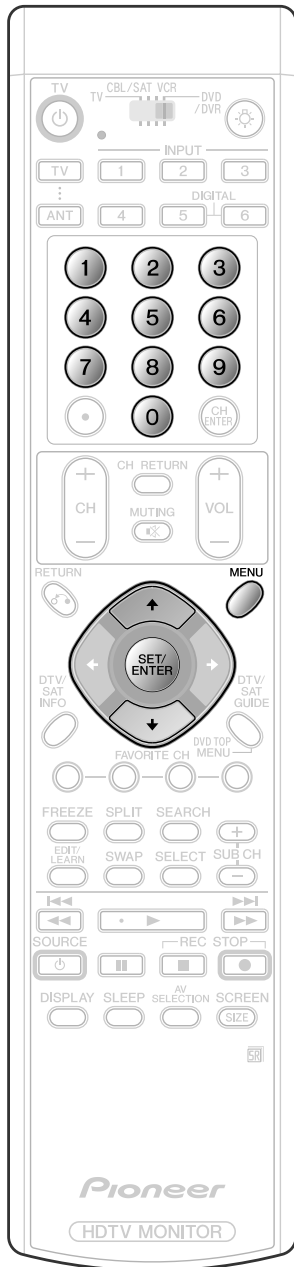

1 Press **MENU** and select **SET UP** by using the **←** or **→** button and then pressing **↓** button. (Refer to page 26.)

2 Select **PROGRAM BLOCK** in the same way.

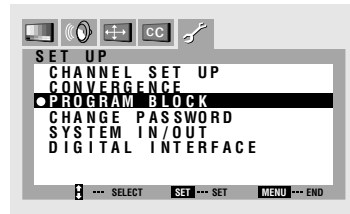
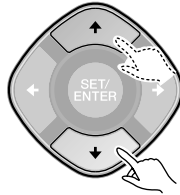

3 Enter a password.

- Press numeric buttons '0' through '9' to enter a four-digit password.
- If the password has not been changed as described in Changing Password (p. 39), enter the default password of '1234'.
- If you wish to change the password (recommended), see p. 39 Changing Password for instructions on how to do so.

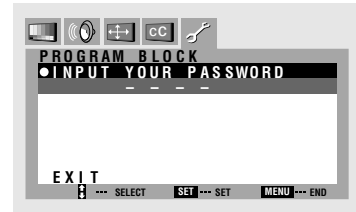
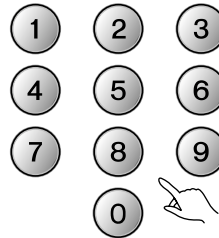

4 Select **BLOCK** .

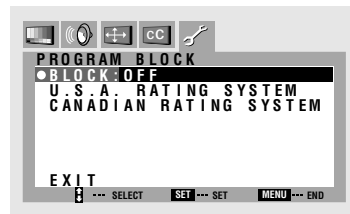
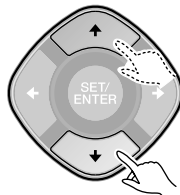

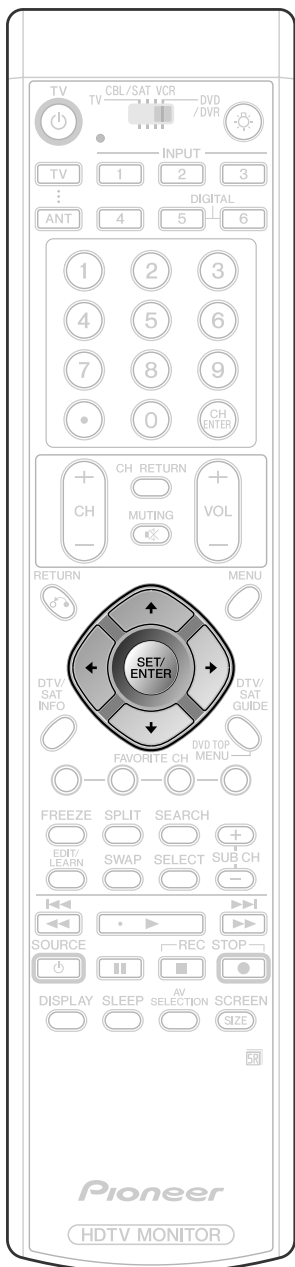

5 Set BLOCK to ON.



6 Select U.S.A. RATING SYSTEM or CANADIAN RATING SYSTEM.

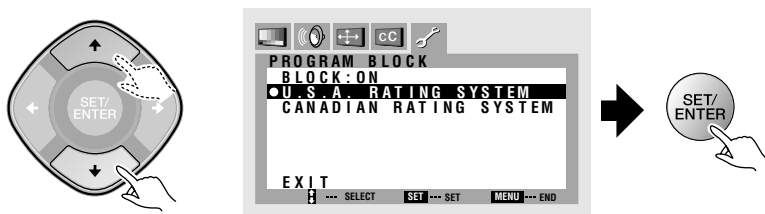

7 If you selected U.S.A. RATING SYSTEM. Select MPAA RATING or TV PARENTAL GUIDELINES.

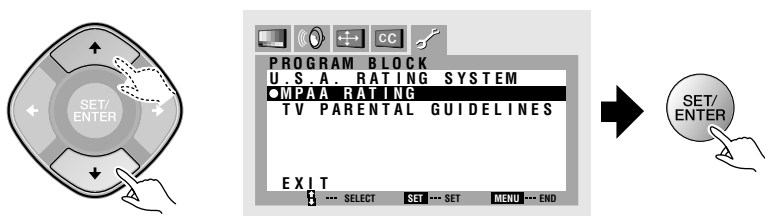

8 Select and then confirm the rank of the MPAA RATING.

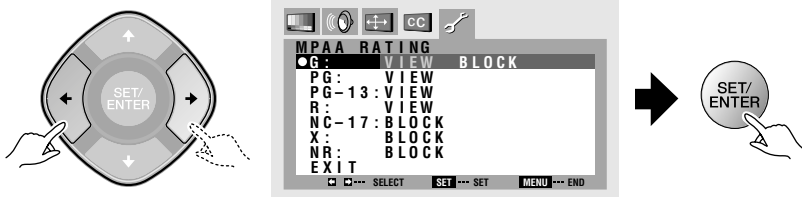
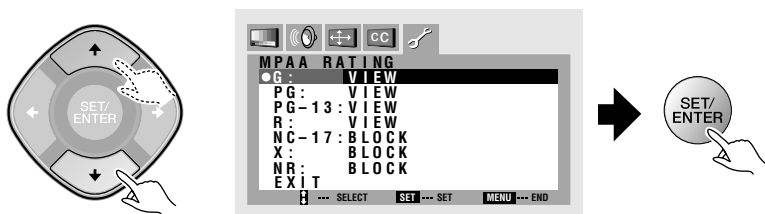

NOTE:

- Blocking programming with a low rating will cause all programming with a higher rating also to be blocked.
- The 'NR' (not rated) MPAA RATING may be set to 'View' or 'Block' without regard to other ratings.

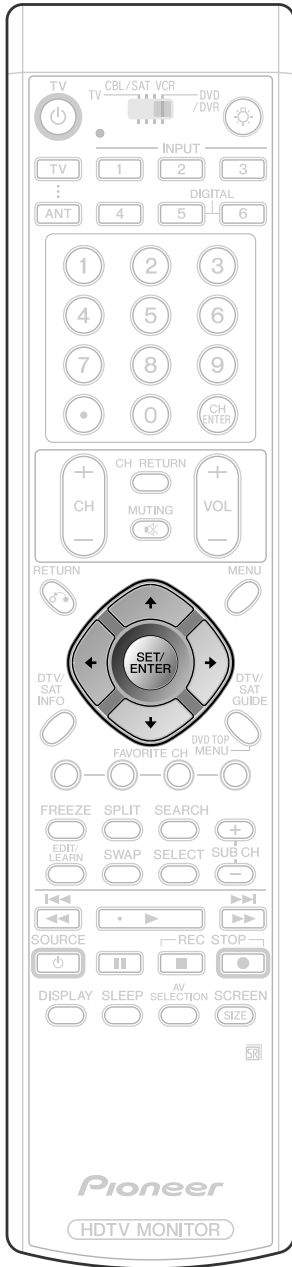

9 Select and confirm the rank of the TV PARENTAL GUIDELINES.

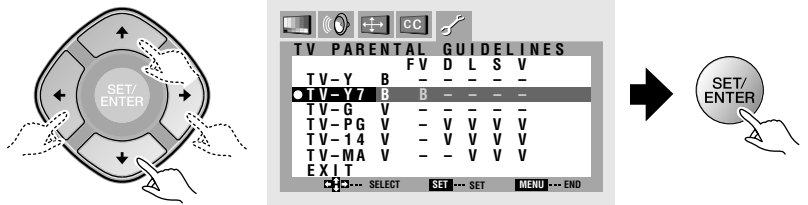

- Each time the SET/ENTER button is pressed, the setting will toggle between 'B' (Block) and 'V' (View).

10 If you selected CANADIAN RATING SYSTEM in step 6, select ENGLISH or FRENCH.

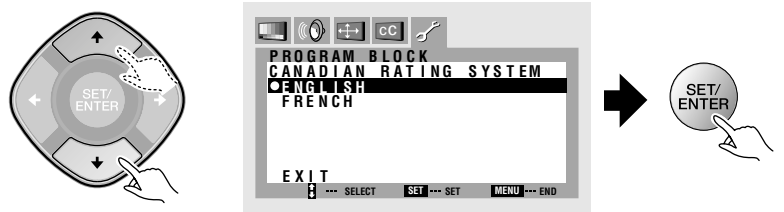

11 If you selected ENGLISH, select and then confirm the rank of the ENGLISH RATING (If you selected FRENCH go to step 12).

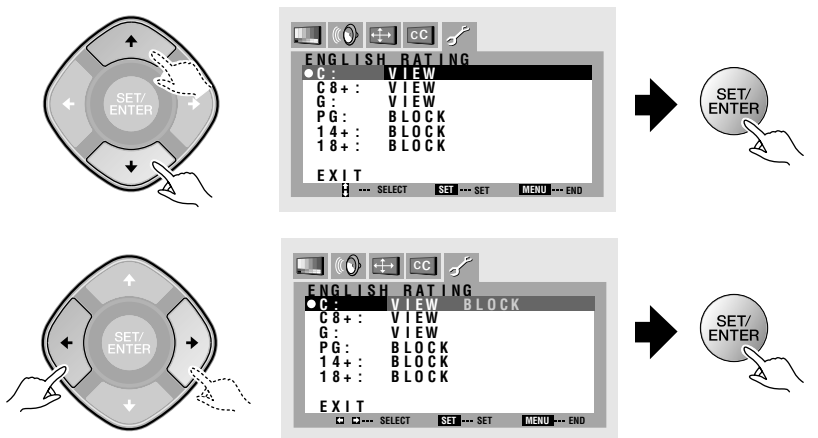

Go to step 13.

12 Select and then confirm the rank of the FRENCH RATING.

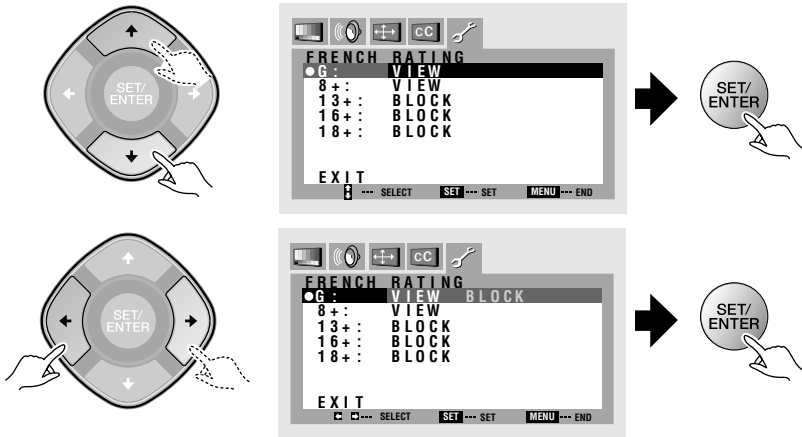
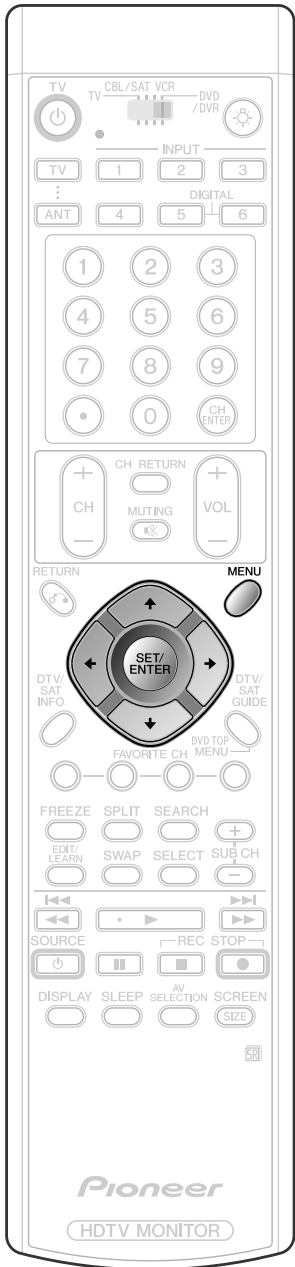

13 After setting, press MENU to turn the menu off.

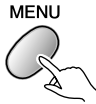

HOW TO REMOVE BLOCKING FROM A PROGRAM IN PROGRESS

If you choose a program that has a rating higher than your program blocking rating, the picture and sound will cut off and an enter password screen will appear.

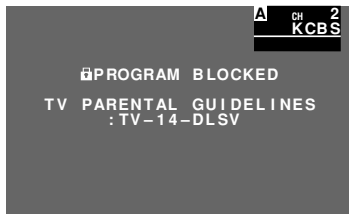

Press the SET/ENTER button on the remote control.

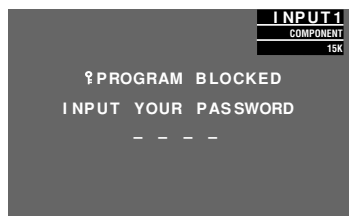

If you enter your password the blocking will be removed for this viewing only.

NOTE:

If the monitor power is turn OFF then turned ON again, the Program Blocked screen will appear again and you'll need to re-enter the password to view the program.

REMOVING BLOCKING IN MULTI-SCREEN MODE

- Just as in normal single-screen mode, programs are blocked in SEARCH screen mode (see pages 44 and 45), but blocking can be removed only from the Main picture. To remove blocking from Search picture screen, switch to the Main picture for that channel and then remove blocking. Because it is impossible to remove blocking when the main picture of 9 screen is blocked, remove it after returning to the single screen.
- When viewing in FREEZE screen (see page 44) mode, only programming on the Moving screen to the left will be blocked and the programming on the Still screen to the right will be displayed as is.

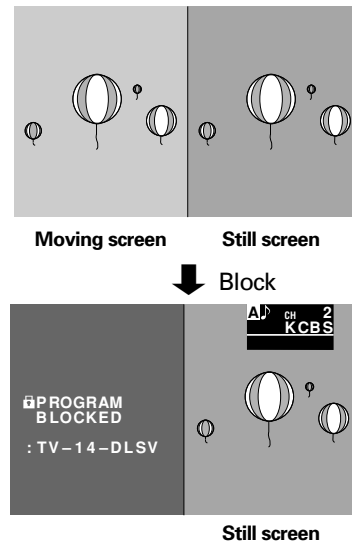

- When blocking is on during SEARCH screen mode, the screen at search picture side will be blacked out and won't display: "PROGRAM BLOCKED".

CHANGING PASSWORD

A password must be entered to turn program blocking on and off. The default password is '1234', but it is strongly recommended that you change the password.

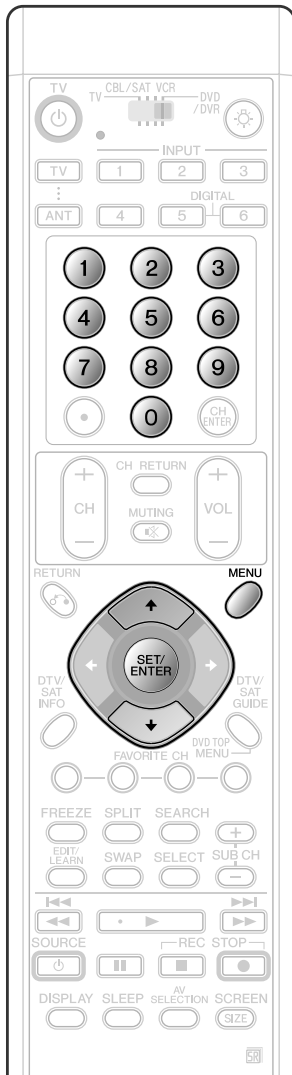

1 Press **MENU** and select **SET UP** by using the **←** or **→** button and then pressing **↓** button. (Refer to page 26.)

2 Select **CHANGE PASSWORD** in the same way.

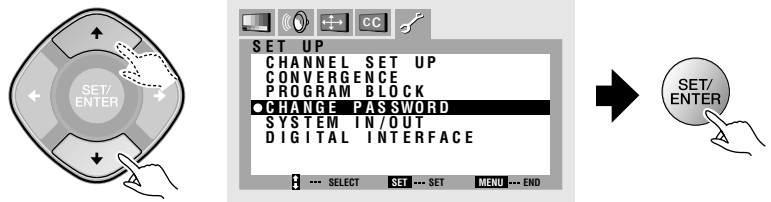

3 Enter current password.

- Press numeric buttons '0' through '9' to enter a four digit password.
- If no password has been previously set, enter the default password of '1234'.

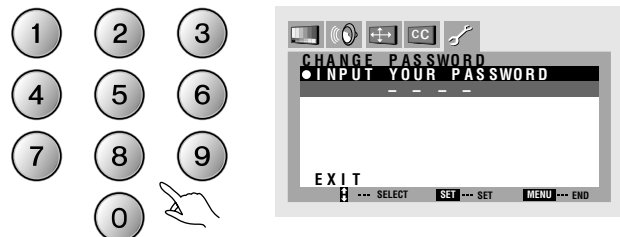

Cut along dotted line and file after reading and filling out.

We suggest you write down your password so you don't forget it.

PRO-730HDI PRO-530HDI

Your PROGRAM BLOCK password No.:

--	--	--	--

If you forget the password

When the message 'INPUT YOUR PASSWORD' in step 3 is displayed, press the RESET button on the front panel and hold it down for 3 seconds or longer. The password reverts to "1234".

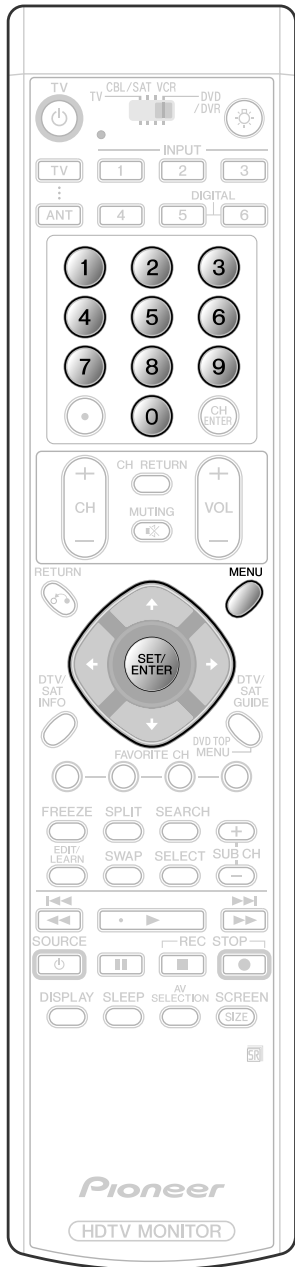

4 Enter new password.

- Press numeric buttons '0' through '9' to enter a four-digit password and press the SET/ENTER button.

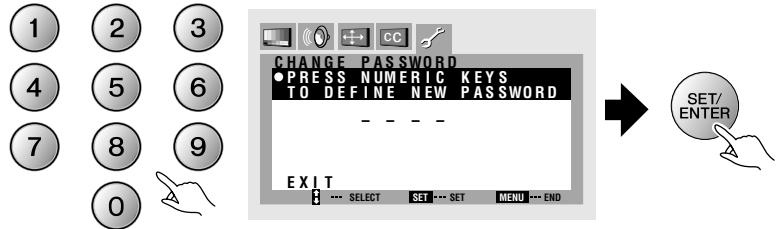

5 After setting, press MENU to turn the menu off.

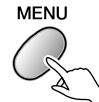

CHANGING SCREEN SIZE

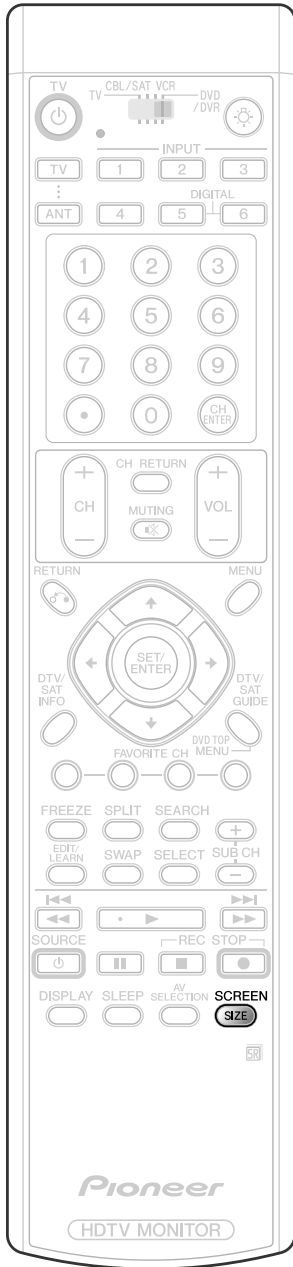

NOTES:

- When 1080i, 720p component signals or RGB signals, 1080i DIGITAL signals are input, SCREEN SIZE will be limited to FULL.
- In PURE DIGITAL: ON state during digital signal input (INPUT 5,6), SCREEN SIZE is fixed at FULL.
- Continuous operation for extended periods in 4:3 NORMAL size may burn out the screen. We thus recommend that this size be used only in conjunction with another SCREEN size.

SETTING SCREEN SIZE

Different source material have specific screen sizes they should use. Some films are size in Vista some in cinemascope etc. check video/DVD packaging for info. Regular TV program are 4:3, so 4:3 is the standard size.

- This Monitor is provided with sizes to deal with screens of various aspect ratios. It is recommended that programs and software be watched in the appropriate size.
- When 4:3 images are fully displayed on a wide TV screen in the NATURAL WIDE size, CINEMA WIDE size, ZOOM size, or FULL size, some parts of the images may be cut off or distorted.

Press the SCREEN SIZE button.

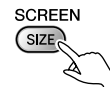

- Each time the SCREEN SIZE button is pressed, the size changes in the following order.



NATURAL WIDE

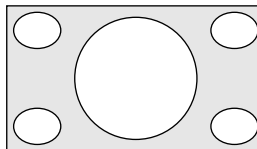

Suitable for when viewing regular TV news or sports programs. Movies or sports programs can be viewed with an expansive powerful image.

CINEMA WIDE

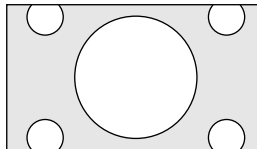

Mainly suitable for viewing Vista size and other such movie images. Provides a more expansive, powerful image. This screen size is convenient when viewing a Cinemascope size image that has subtitles.

ZOOM

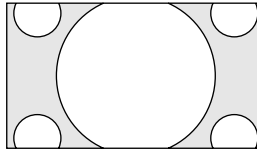

Mainly suitable for viewing Cinemascope size and other such movie images. Provides a more expansive, powerful image.

FULL

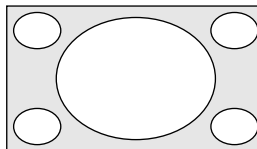

Suitable for wide screen images.

4:3 NORMAL

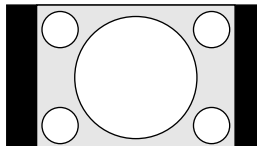

Suitable for when viewing news sit coms or any regular TV programs. Video software can be viewed in its original screen frame size with this size.

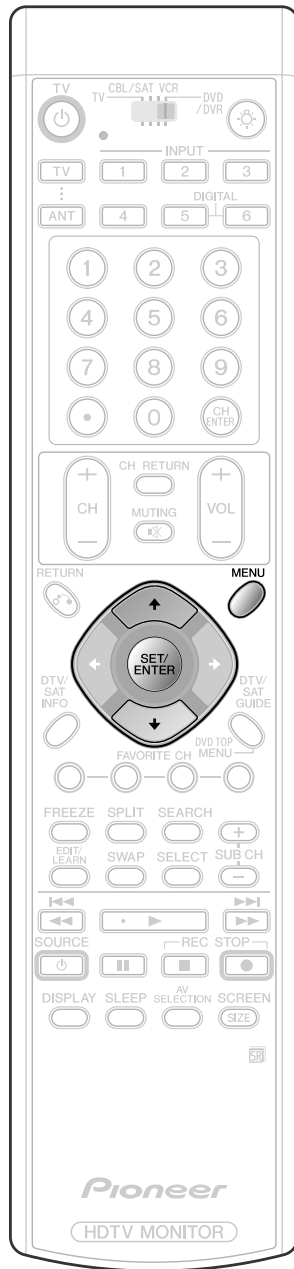

TO ADJUST THE SCREEN POSITION

When the screen mode is CINEMA WIDE or ZOOM, you can adjust the screen position by pushing the **↑** or **↓** button. During digital signal input, the position can be adjusted using the **←** or **→** button.

1 Press **MENU** and select **SET UP** by using the **←** or **→** button and then pressing **↓** button. (Refer to page 26.)

2 Select **V. POSITION** in the same way.

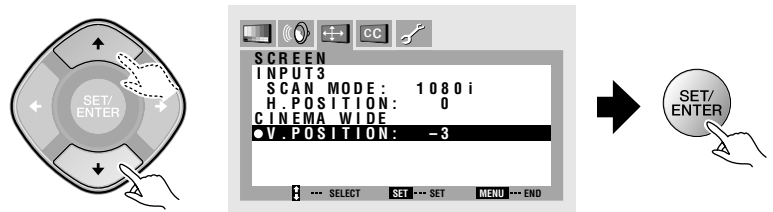

3 Adjust the screen position.

- Adjustable range
 CINEMA WIDE mode : -15 to 15
 ZOOM mode : -25 to 25

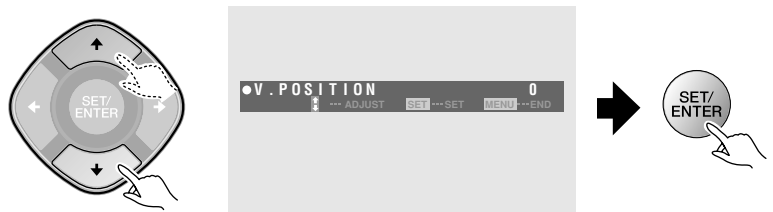

4 Select **H. POSITION** in the same way.

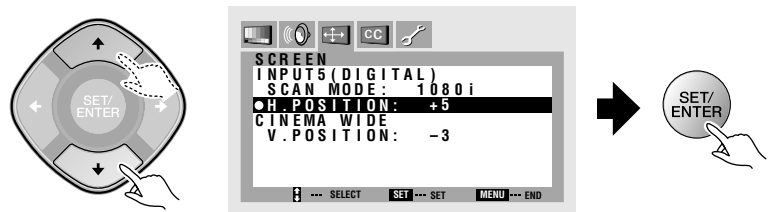

NOTES:

- V screen position cannot be adjusted in NATURAL WIDE, FULL, or 4:3 NORMAL mode.
- H screen position can be adjusted in DIGITAL signals.

5 Adjust the screen position.

- Adjustable range
 DIGITAL 31K : -10 to 10
 DIGITAL 33K : -15 to 0



6 After adjusting, press MENU to turn the menu off.

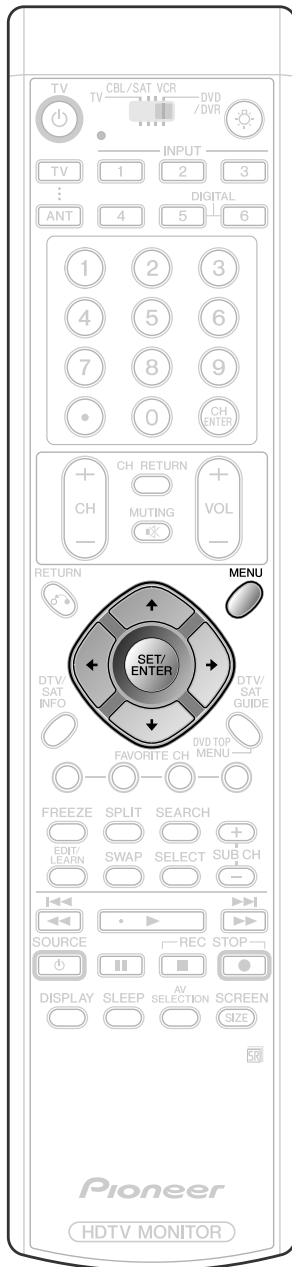
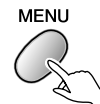

MULTI-SCREEN FUNCTION

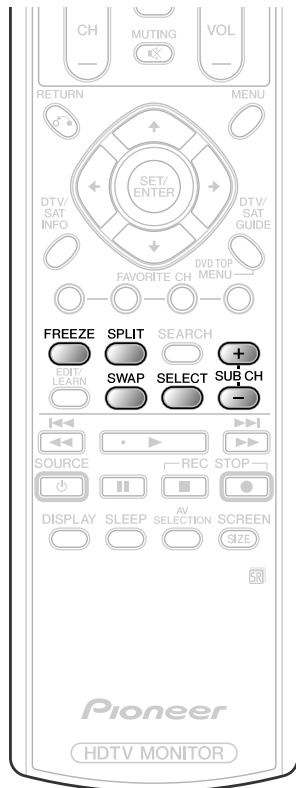

NOTES:

- The same image cannot be viewed as both the main picture and the sub-picture.
- Pressing the MENU button in SPLIT or FREEZE screen mode restores the screen display to normal and displays the menu on screen.
- These functions cannot be used when INPUT 1 or INPUT 2 is receiving a 1080i or 720p component signal (or the signals might not be received or noise might be generated).
- When a TV broadcast is being received, the screen on the right will not show the antenna B signal.
- RGB signals input from INPUT3 cannot be displayed.
- During 1080i input of digital signal input (INPUT 5, 6), display is not possible.
- Continuous operation for extended periods in SPLIT or FREEZE screen mode may burn out the screen. We thus recommend that these modes only be used in conjunction with the normal screen mode.
- If the non-interlace signal for a TV game etc. is entered to the left screen during SPLIT screen mode, the right screen may be disrupted. If this occurs, use the right screen for TV game etc. entry.

VIEWING TWO SCREENS (SPLIT screen)

The screen can be split vertically, making it possible to view different images on the left and right.

- The screen on left side is the main picture, and the other screen is the sub-picture. Sound will be output for the main picture. Sound from the TV speaker will only be output for the main picture. To listen to sound for a sub picture, press the SWAP button and switch the screens on the left and the right.
- Regular operations can be performed on the main picture.

Press the SPLIT button.

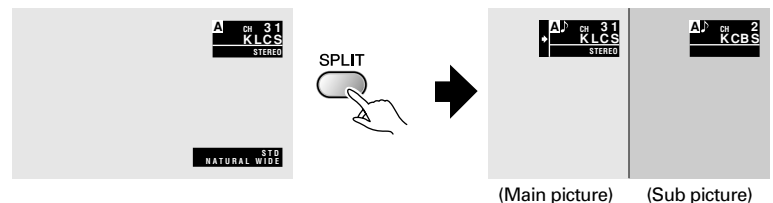

- When the SUB CH +,- buttons are pressed, the channel for the sub-picture will be changed.
- When the SELECT button is pressed, the → will move to the other screen.
- The MONITOR/TV OUTPUT terminal outputs the main picture signal.
- Pressing the SPLIT button again will restore the original screen.

MAKING NOTES ON PROGRAM CONTENT (FREEZE screen)

The screen can be frozen, such as for taking down a recipe from a cooking program or an address for entering a quiz or the like.

Press the FREEZE button.

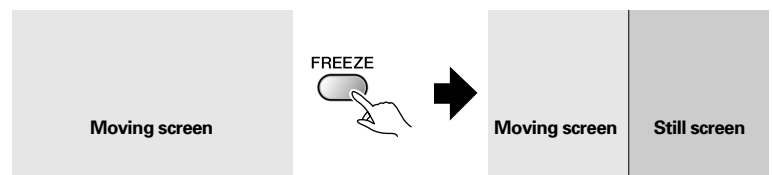

- This function is operable only with the normal screen.
- Pressing the FREEZE button again will restore the original screen.

SEARCHING FOR A PROGRAM ON A DIFFERENT CHANNEL (SEARCH screen)

The screen can be made into nine or four different screens, making it possible to search for programs or enjoy multiple images.

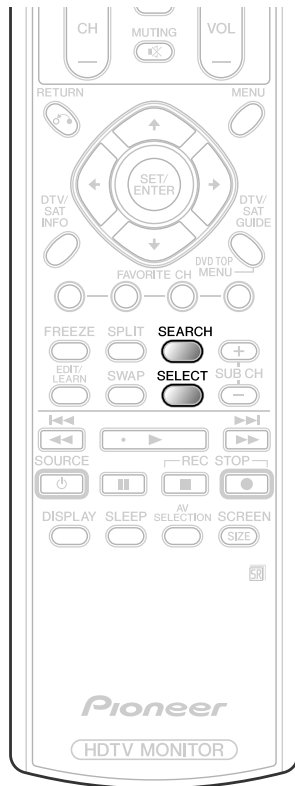

Press the SEARCH button.



- Each time the SEARCH button is pressed, the screen mode changes in the following order.

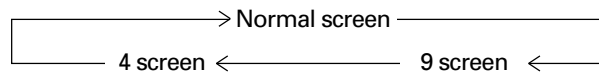

① 9 screen

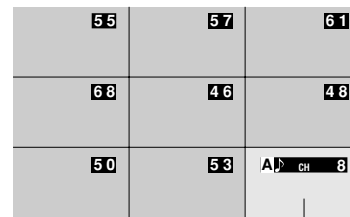

Search picture Main picture

- Pressing the MENU button in SEARCH screen mode restores the screen display to normal and displays the menu on screen.
- These functions cannot be used when INPUT 1 or INPUT 2 is receiving a 1080i, 480p or 720p component signal (or the signals might not be received or noise might be generated).
- RGB signals input from INPUT3 cannot be displayed. Display is also not possible during digital signal input (INPUT 5, 6).
- Continuous operation for extended periods in SEARCH screen mode may burn out the screen. We thus recommend that these modes only be used in conjunction with the normal screen mode.
- The only channels displayed on the SEARCH screen will be those with input signals input from antenna A. Antenna B channels cannot be displayed on this screen.
- If the non-interlace signal for a TV game etc. is entered to the left screen during 9 screen or 4 screen modes, the screen may be disrupted.

- On the search picture, the antenna A preset channel (see page 28) will be displayed as a frozen image. If 8 or more channels have been preset, the screens will automatically be switched and displayed.
- The search picture cannot be operated.
- Sound output is limited to the main picture.

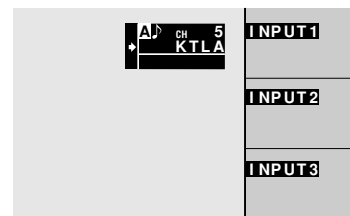

Main picture Search picture

② 4 screen

- Press the SELECT button to select the image that you wish to switch the channel or input source to. You can operate the screen that is selected by the arrow. (Use only the selector buttons, direct channel selection buttons, channel, antenna and CH +,- buttons.)
- Sound output is limited to the main picture.

CLOSED CAPTION DECODE FUNCTION

Closed caption broadcasting (character information) in the video signal allows the displaying of characters on the screen. This unit has a closed caption decoder which allows, these titles to be displayed when receiving these broadcasts or playing a video cassette or Video Disc with the **CC** mark, etc.

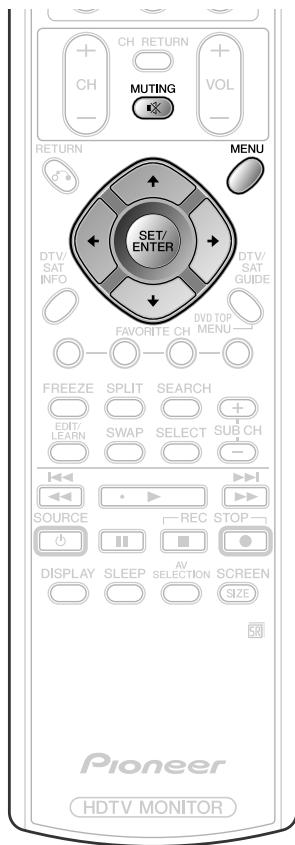

NOTES:

- When a video cassette or Video Disc carrying the **CC** mark etc. is played, the closed caption signal may not be output depending on your VCR or Video disc player.
- During TV broadcast reception, closed caption signal may not be decoded properly if the receiving broadcast signal is weak.
- Closed caption signal may not be decoded properly depending on the recording condition of the video cassette tape.
- The character information will not be displayed while a menu is displayed. To turn on the character information, press the MENU button and turn off MENU.
- This function can be used only during TV and 480i input.

1 Press MENU and select **CC by using the ← or → button and then pressing ↓ button. (Refer to page 26.)**

2 Select **CC in the same way.**

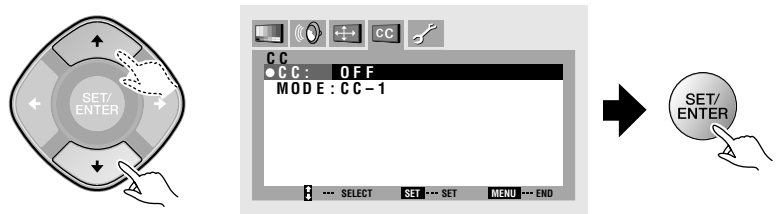

3 Set CC to ON or ON IF MUTE.

- If you have selected ON IF MUTE, closed captions will be displayed only while MUTE is functioning with the MUTING button pressed while you are viewing or listening to the program.

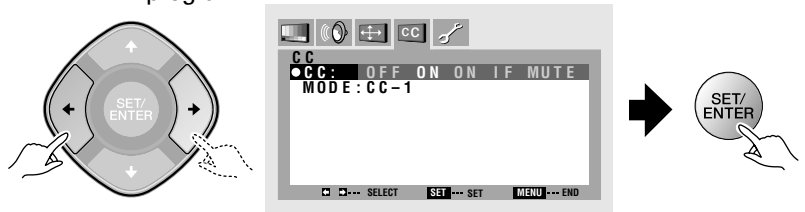

4 Select **MODE .**

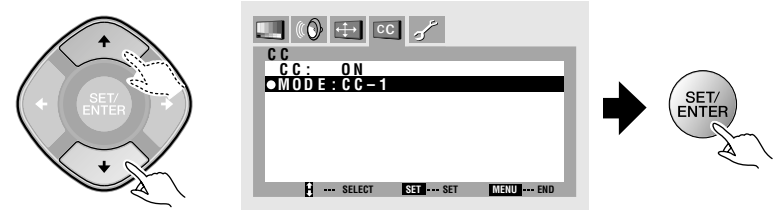

5 Select the desired CC (Closed Caption CC-1 to CC-4) or TEXT (TEXT-1 to TEXT-4).

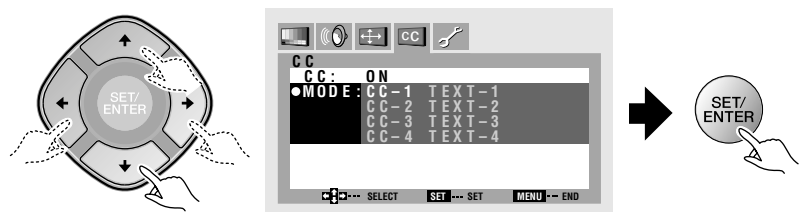

6 After setting, press MENU to turn the menu off.

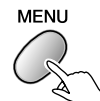

CHANGING CHANNEL SET UP

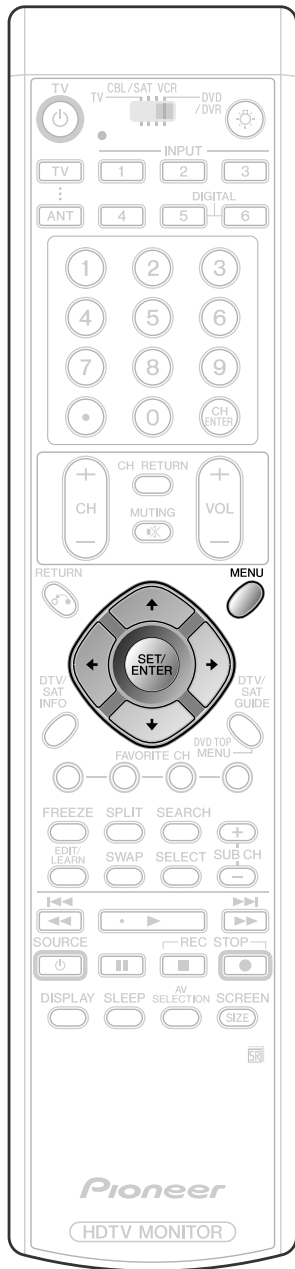

TO ADD OR DELETE PRESET CHANNELS

Broadcast stations preset by auto channel preset which are unnecessary can be deleted. Broadcast stations you want to watch that were not preset by auto channel preset can be preset. You can add a name to a channel that has been added. (See steps 7 and 8 on page 49.)

ADD Manually presets channels that were not preset by AUTO CHANNEL PRESET.

DEL Deletes channels that are not required for reception. The deleted channels can be skipped when selecting channels with the + and - CH (channel) buttons.

- Perform the following after completing AUTO CHANNEL PRESET. (See page 28.)

1 Press **MENU** and select **SET UP** by using the **←** or **→** button and then pressing **↓** button. (Refer to page 26.)

2 Select **CHANNEL SET UP** in the same way.

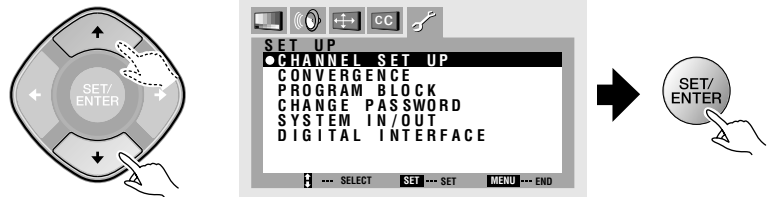

3 Select **CHANNEL ADD/DEL**.



4 Select **ANTENNA** receiving the channel you want to delete or add with **A** or **B**.



5 Select CHANNEL , then select a channel.

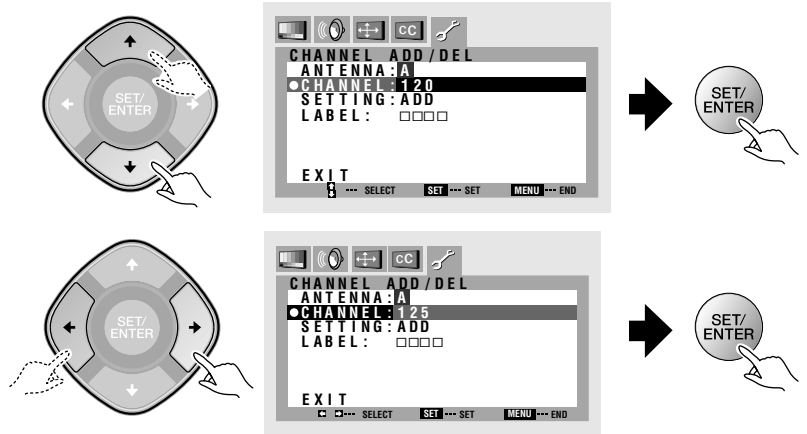
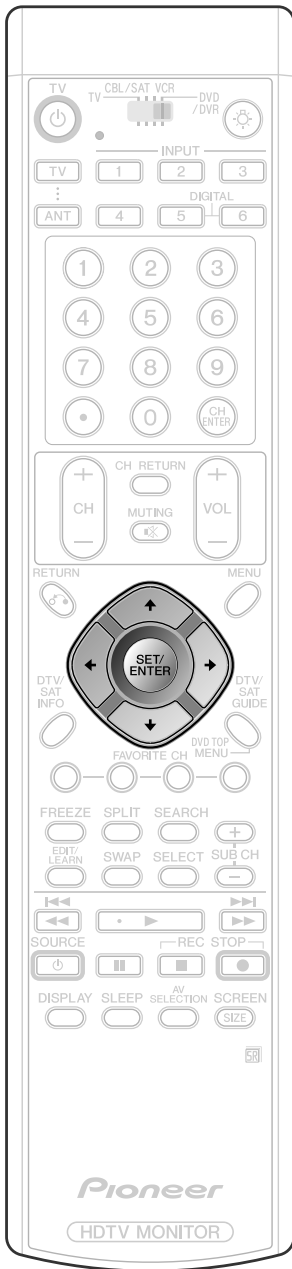

6 Select SETTING , then select ADD (addition) or DEL (deletion).

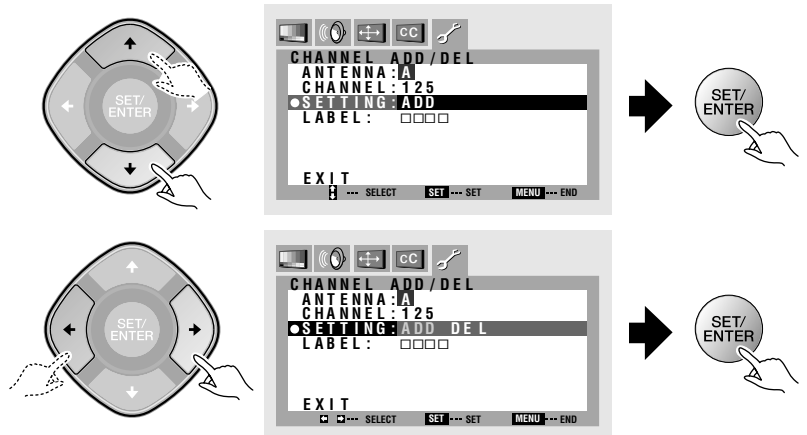

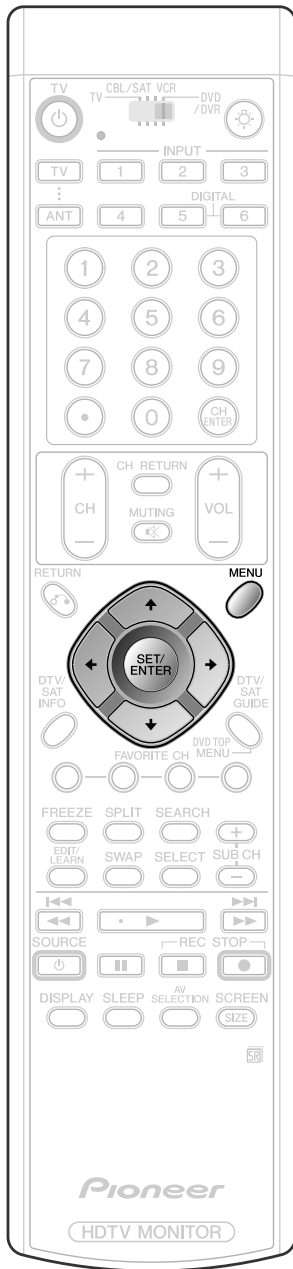

7 Select LABEL and input the letters for the name you want to call this channel.

- When adding a channel, a label of 4 characters can be input for the added channel.

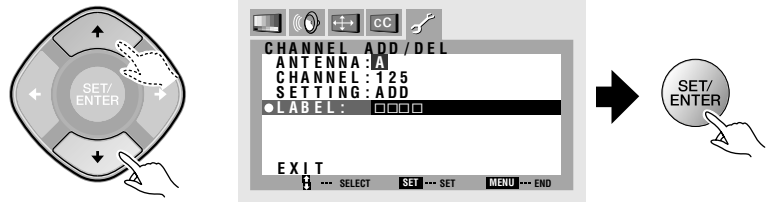

- Input the first character.
When is selected, a space can be input.
When is selected and input, label character input mode will terminate.

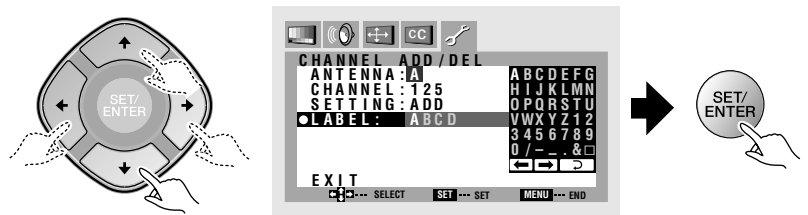

- Input the rest of the characters.

8 Repeat steps 4 to 7 to add and/or delete other channels.

9 After setting, press MENU to turn the menu off.

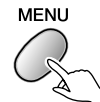

FAVORITE CHANNEL SET UP

Assigning your favorite channels to the four buttons (blue, green, red and yellow) on the remote control unit makes it easy to call them up. Four channels can be assigned to each button, making it possible to set a total of 16 channels.

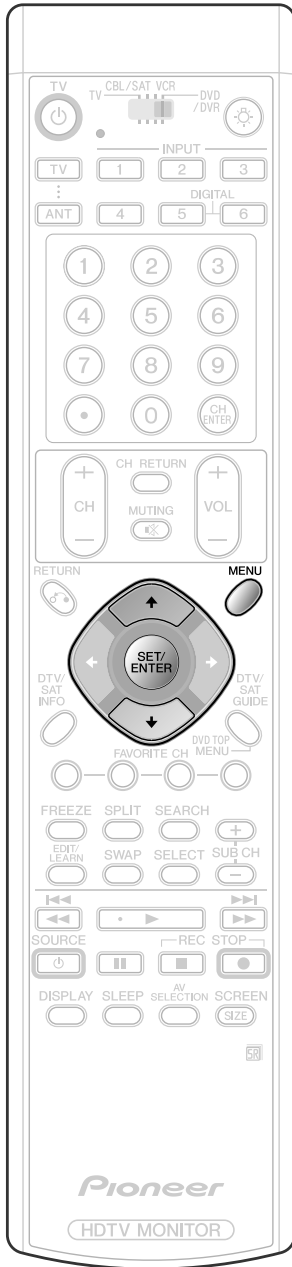

1 Press **MENU** and select **SET UP** by using the **←** or **→** button and then pressing **↓** button. (Refer to page 26.)

2 Select **CHANNEL SET UP** in the same way.

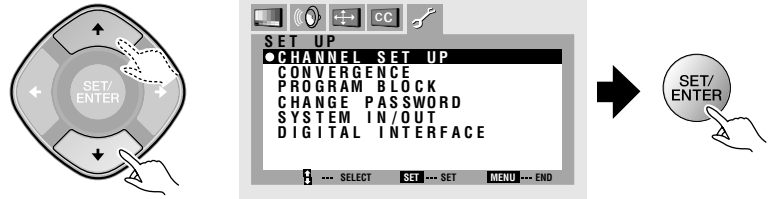

3 Select **FAVORITE CHANNEL**.



4 Select the color of the button you wish to set.

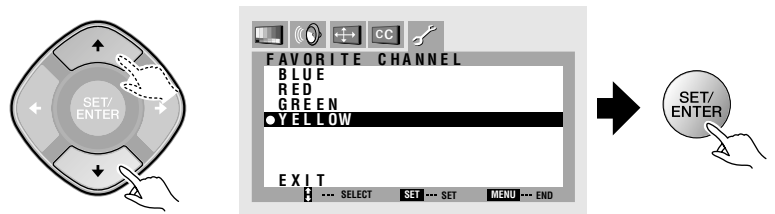

NOTE:
A channel deleted with **CHANNEL ADD/DEL** (page 47) cannot be set as a **FAVORITE CHANNEL**.

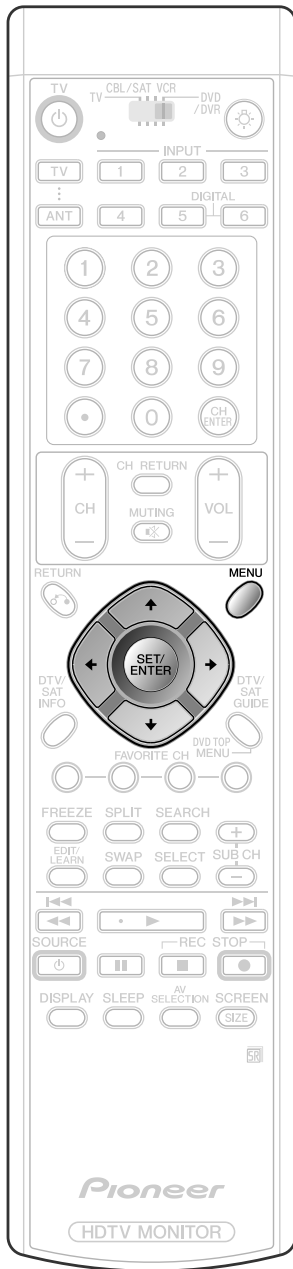

5 Select number.

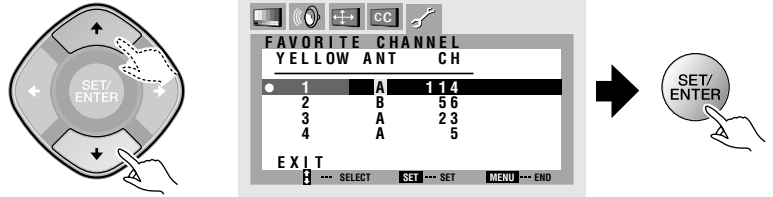

6 Select antenna.

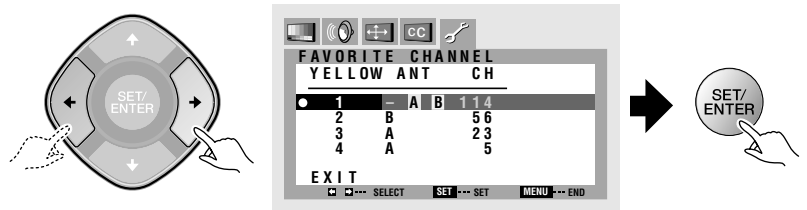

- If you made a mistake during setting, press SET to select the incorrect entry and set it correctly.

7 Select the channel.

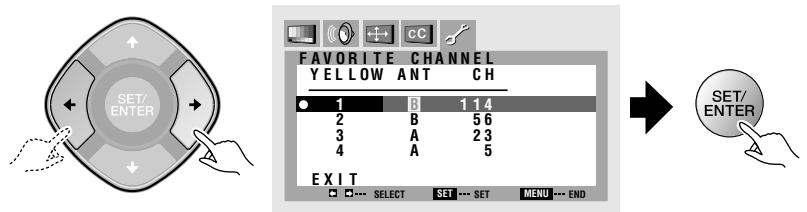

8 To set another number, repeat steps 5 to 7.

To set a button of a different color, repeat steps 4 to 7.

- To return to step 4, press either the ↑ or the ↓ button to select EXIT and then press the SET/ENTER button.

9 After setting, press MENU to turn the menu off.

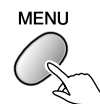

PICTURE ADJUSTMENTS

This device has five types of picture quality settings in memory. You can choose one from them or set the picture quality you desire and store it in memory.

RECALL THE DESIRED SETTINGS

1 Press **MENU** and select **PICTURE** by using the **←** or **→** button and then pressing **↓** button. (Refer to page 26.)

2 Select **MODE** in the same way.

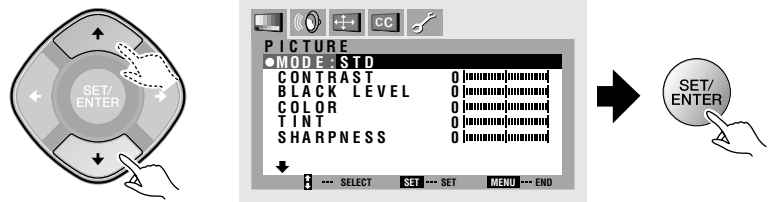

3 Select the desired setting.



- STD Sets standard picture quality.
- REF THEATER This mode reproduces film material just like a real film image. By cutting video enhancement circuits, the picture becomes more natural and looks filmlike.
- GAME Lowers the relative contrast of TV game images to minimize discomfort to the eyes. This will minimize bad effects such as discolored spots or stains on the CRT of the Monitor.
- USER Calls up the picture quality the user has set. See page 53 for an explanation of different picture qualities.
- PRO In this mode, you can finely adjust the picture quality to your taste.

4 After setting, press **MENU** to turn the menu off.

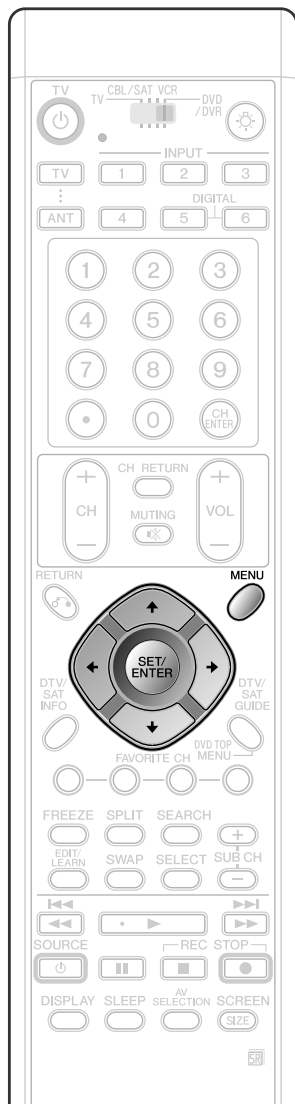
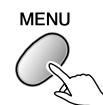

NOTES on GAME mode setting:

- We do not recommend the use of the Monitor for video games, still pictures due to the potential damage to the CRTs*. In the event a consumer needs to use these devices for a short period of time, the GAME mode will minimize potential damage to the CRTs* by lowering the relative contrast.
- All signals output from the Projection Monitor will be unaffected. Only the original output signal is sent through the output jacks.

*CRT: Cathode-ray tube

STORING THE SET PICTURE QUALITY IN MEMORY

USER mode can be set for each input source: TV and INPUT 1 to INPUT 6.

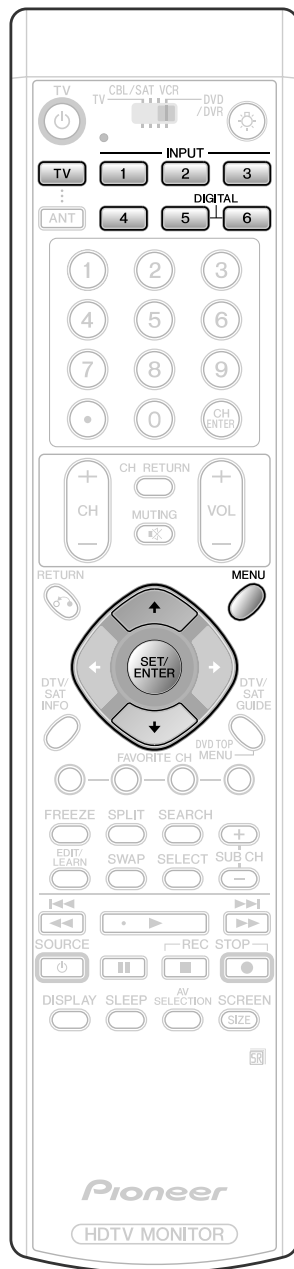

1 Select the input source and show the image on the screen.

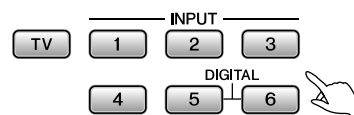

If VCR or DVD/DVR has been selected, start playback for the relevant device.

2 Press MENU and select PICTURE .

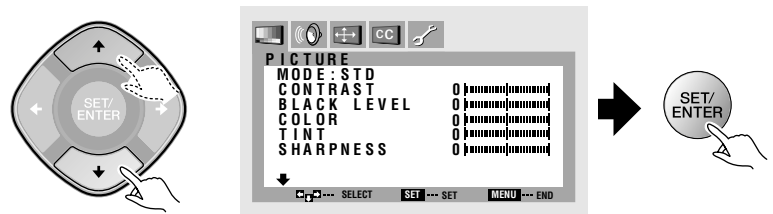

3 Adjust the desired picture quality. (Refer to steps 2 and 3 on page 54.)

- If any mode (STD, REF THEATER, or GAME) is adjusted, setting for USER mode.
- The last mode that was adjusted will become the USER sub mode (indicated in parentheses).
- PRO mode displays "PRO" unchanged.
- A USER mode can be stored for TV and the six input sources.



Indicates the adjusted picture quality setting that is the base for USER mode.

4 After adjusting, press MENU to turn the menu off.

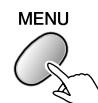

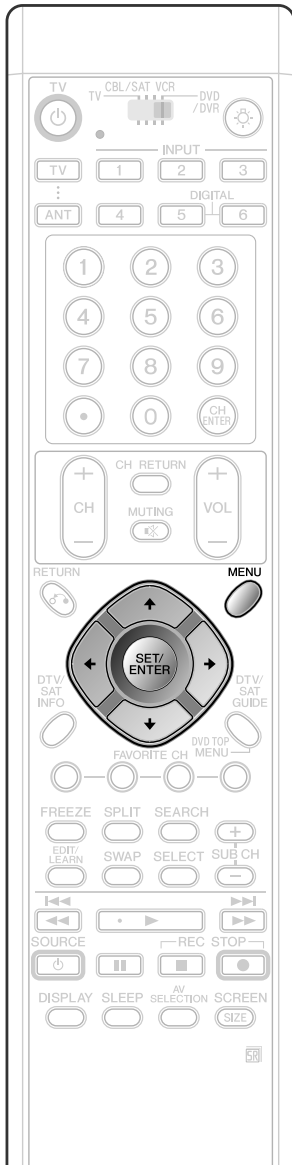

NOTES:

- When picture quality has been adjusted, the user mode data will be overwritten with the new settings.
- The COLOR, TINT, and SHARPNESS settings may not be changed when receiving RGB input (INPUT 3).
- The CONTRAST and BLACK LEVEL cannot be adjusted in PRO mode.
- COLOR, TINT, and SHARPNESS cannot be adjusted in PURE DIGITAL:ON state during digital signal input (INPUT 5, 6).

TO ADJUST THE PICTURE QUALITY

Adjust the picture quality when you want improve the quality of the picture you are watching. You can adjust the CONTRAST, BLACK LEVEL (brightness), COLOR, TINT and SHARPNESS.

CONTRAST Adjusting the contrast to match the brightness of the surroundings so it is easier to watch.

BLACK LEVEL (brightness)

..... Adjusting the picture so that night scenes, dark hair, and other dark parts of the screen are easier to watch.

COLOR Adjusting it to the density you prefer. (It appears natural if it is a little light.)

TINT Adjusting it so that flesh tones appear more attractive.

SHARPNESS Normally use the center value.

When you want a soft sensation, set it so that the scale moves in the minus direction.

1 Press MENU and select PICTURE .
(Refer to page 26.)

2 Select the adjustment item.

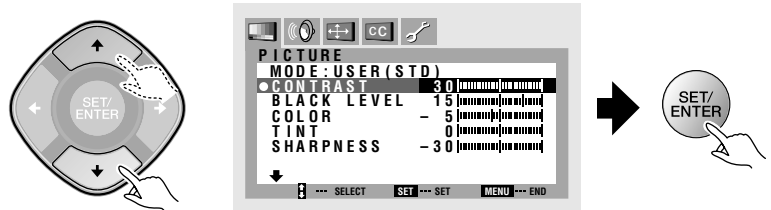

NOTE:

If you are distracted by the screen display during adjustment, push the SET/ENTER button for three or more seconds. You can do the adjustment with the screen display shut off. Pushing any button on the remote control restores the display.

3 Adjust by pressing ←, →, ↑ or ↓ .

- The adjusting range is -30 to 30.
- The numerical value comes down to press ← and comes up to press →.
- The adjustment item change to press ↑ or ↓.

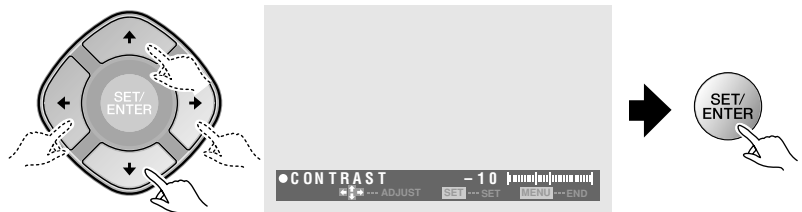

- The set picture quality will be stored in memory as USER mode (see page 53).
- Repeat steps 2 and 3 for other items.

4 After adjusting, press MENU to turn the menu off.

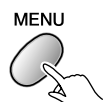

OTHER PICTURE QUALITY ADJUSTMENTS

The following six fine adjustments are available.

- ① PureCinema This function automatically detects movie film recorded at 24 frames per second, and converts it into a high quality 30 frames per second delivering the picture at the same rate as it was recorded.
- ② COLOR TEMP This function enables the image to be set to five different tones.
- ③ 3D Y/C LEVEL Perform this adjustment when noises appear at the color borders of the image.
- ④ 3D NR LEVEL Reduces the noise level of the luminance and chrominance signals.
- ⑤ SVM (Scan Velocity Modulation) Screen contour definition can be selected as desired.
- ⑥ FLESH TONE By the time video signals from a broadcast station arrive at your projection monitor (on air or cable TV), they have experienced significant degradation. Flesh tone reduces color noise, improves color uniformity and corrects unnatural flesh tones to give your natural images.
- ⑦ BLACK ENHANCE ... Changing the black part of the video signal automatically corrects the gradation of the black.
- ⑧ SHARP EFFECT This enables you to switch the SHARPNESS correction function.
- ⑨ LTI (Luminance Transient Improvement) This enables you to switch the definition of the luminance signal.
- ⑩ GAMMA This enables you to switch the balance of the contrast between the bright parts and dark parts of the luminance signal.
- ⑪ CONTRAST EXP This enables you to adjust the brightness level of dark areas in accordance with screen brightness.
- ⑫ SHARP MODE This enables you to switch signal bands in order to correct sharpness.
- ⑬ WHITE BALANCE ... This enables you to adjust the color temperature to your taste.

NOTE:

Adjustments LTI, GAMMA, CONTRAST EXP, SHARP MODE and WHITE BALANCE can be done only in PRO mode.

1 Press MENU and select PICTURE .
(Refer to page 26.)

2 Select ↓.

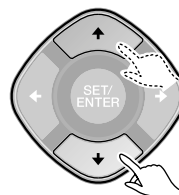

➡ ↓
(To the following item.)

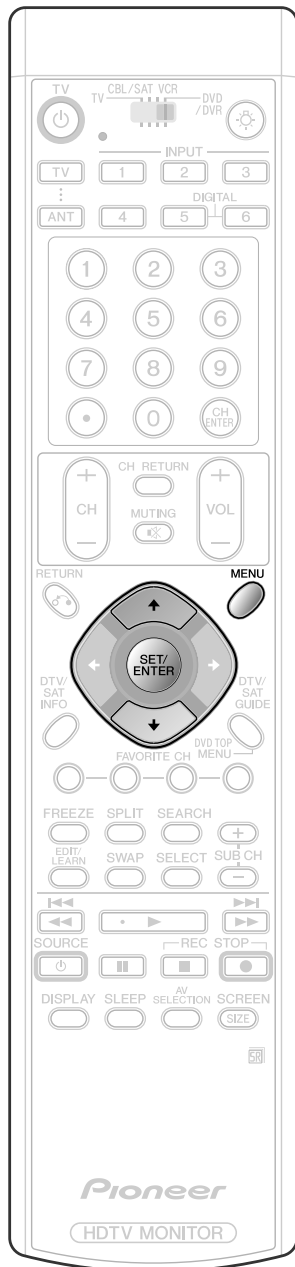

NOTES:

- The COLOR TEMP, GAMMA and WHITE BALANCE settings may be changed when receiving RGB input.
- In PURE DIGITAL: OFF state during digital signal input (INPUT 5, 6) it is possible to switch between ④ and ⑨.

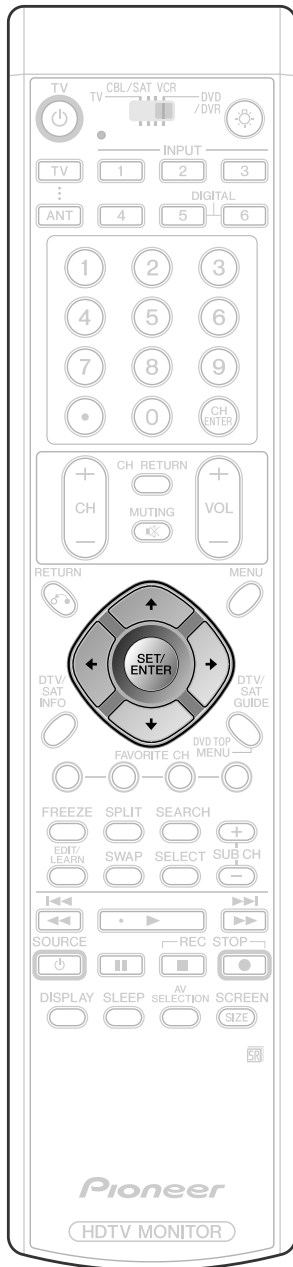

3 ① To adjust PureCinema

This function automatically detects movie film recorded at 24 frames per second, and converts it into a high quality 30 frames per second delivering the picture at the same rate as it was recorded.

NOTE:

This can be used only during 480i signal input.

Select PureCinema .

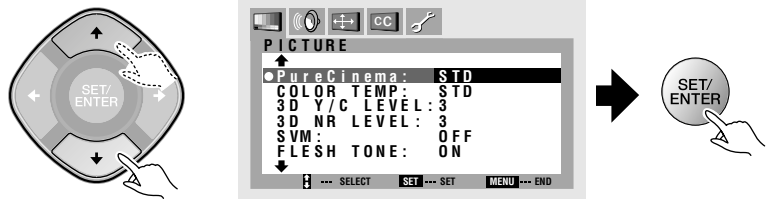

Select the desired PureCinema mode.



- OFF No PureCinema effects
- STD Standard PureCinema effects.
- HQ Maximum PureCinema effects (Optimum setting for the movie source).

② To adjust COLOR TEMP

This function enables the image to be set to five different tones.

Select COLOR TEMP .

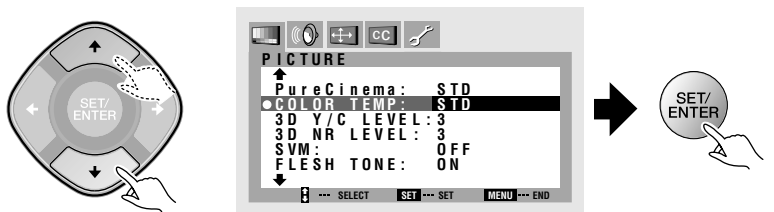

Select the desired tone of the image.



- B&W Warmest color
- FILM Warmer color
- STD Normal color
- LIVE Cooler color
- NEWS Coolest color

NOTE on PureCinema mode setting:
 When the mode has been set to HQ or to STD, the picture may appear unnatural depending on the material being viewed (TV, VCR, DVD, etc.). When this happens, set the mode to OFF.

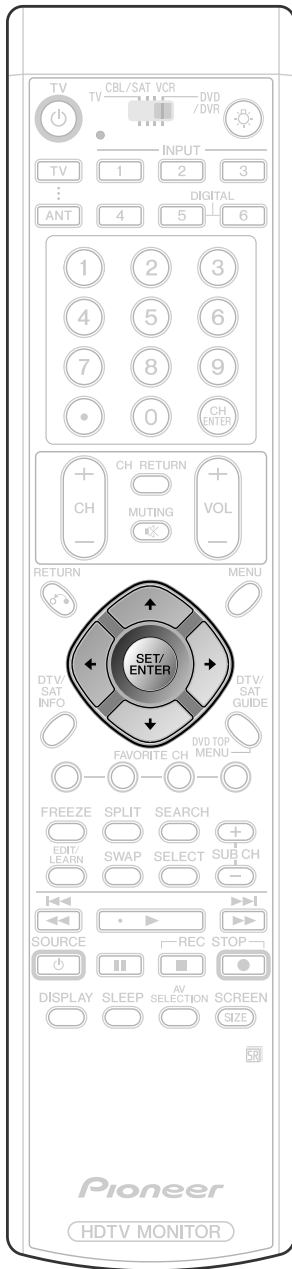

③ To adjust 3D Y/C LEVEL

Perform this adjustment when noises appear at the color borders of the image.

NOTE:

This function can be used only when viewing a source that has been connected to the antenna or composite video input terminal.

Select **3D Y/C LEVEL**.

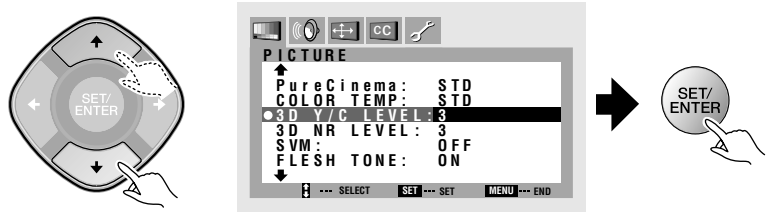

Select the desired level.



1 ↔ 2 ↔ 3 ↔ 4 ↔ 5

Suitable for software using dynamic images

Suitable for software using still images

④ To adjust 3D NR LEVEL

Reduces the noise level of the luminance and chrominance signals. Luminance signal Video signal that controls brightness. Chrominance signal Video signal that controls color.

NOTE:

This can be used only during 480i, 480p (except when SCREEN MODE is FULL) and 720p signal input.

Select **3D NR LEVEL**.

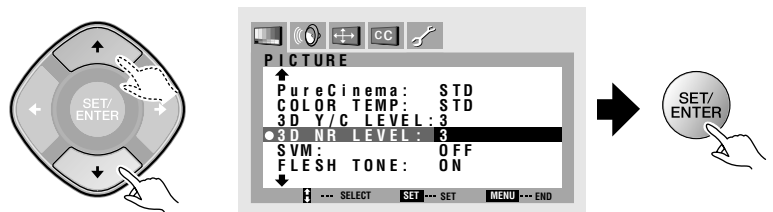

Select the desired level.



1 ↔ 2 ↔ 3 ↔ 4 ↔ 5

Low noise reduction

High noise reduction

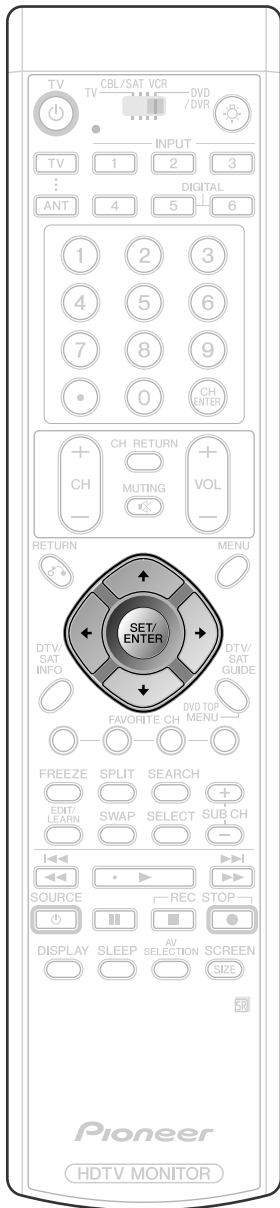

⑤ To adjust Scan Velocity Modulation (SVM)

Screen contour definition can be selected as desired.

NOTES:

- This function cannot be used when SCREEN MODE is 4:3 NORMAL or PICTURE MODE is GAME.
- It cannot be used during RGB signal input.

Select SVM .

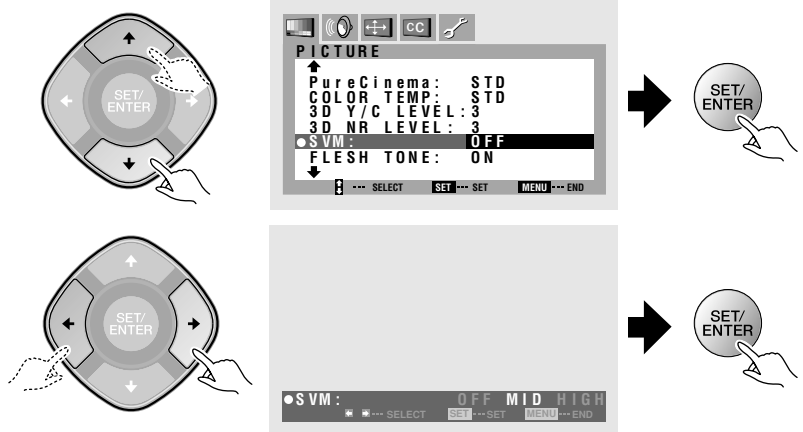

- OFF Provides a soft picture.
- MID Provides a picture with moderate contours.
- HIGH Provides a picture with sharp contours.

⑥ To adjust FLESH TONE

By the time video signals from a broadcast station arrive at your projection monitor (on air or cable TV), they have experienced significant degradation.

Flesh tone reduces color noise, improves color uniformity and corrects unnatural flesh tones to give your natural images.

NOTE:

It cannot be used during RGB signal input.

Select FLESH TONE .

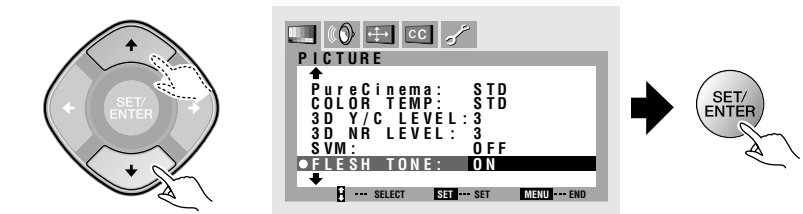

Set FLESH TONE to ON.



⑦ To adjust BLACK ENHANCE

Changing the black part of the video signal automatically corrects the gradation of the black.

NOTES:

- The effectiveness varies according to the content of the video signal.
- It cannot be used during RGB signal input.

Select BLACK ENHANCE .

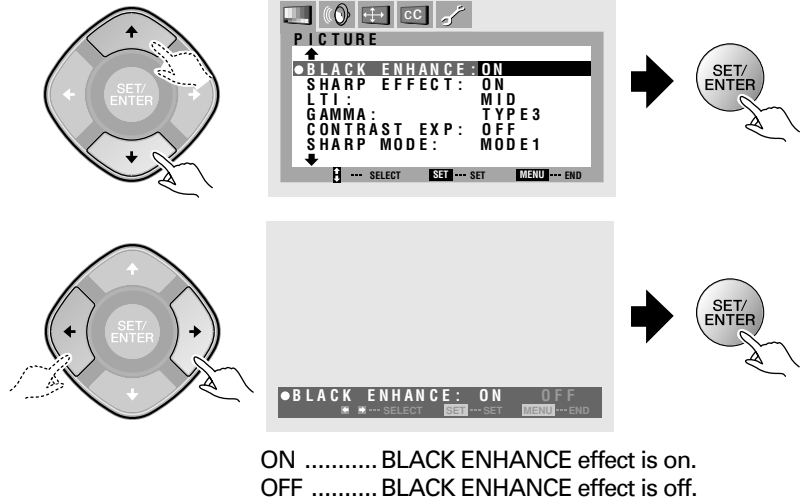
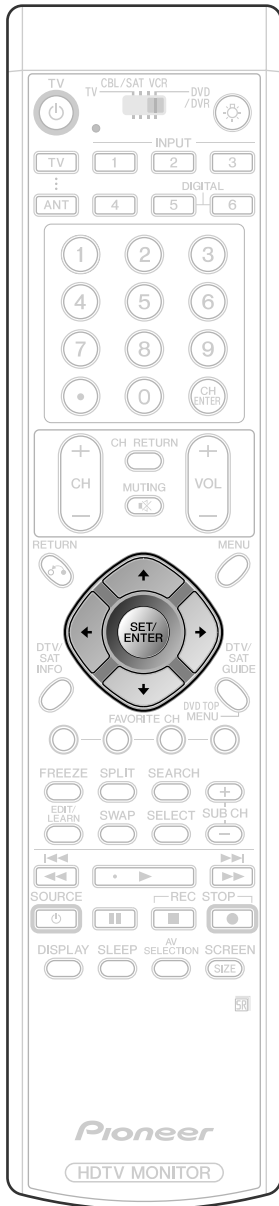

⑧ To adjust SHARP EFFECT

This enables you to switch the SHARPNESS correction function.

NOTE:

It cannot be used during RGB signal input.

Select SHARP EFFECT .

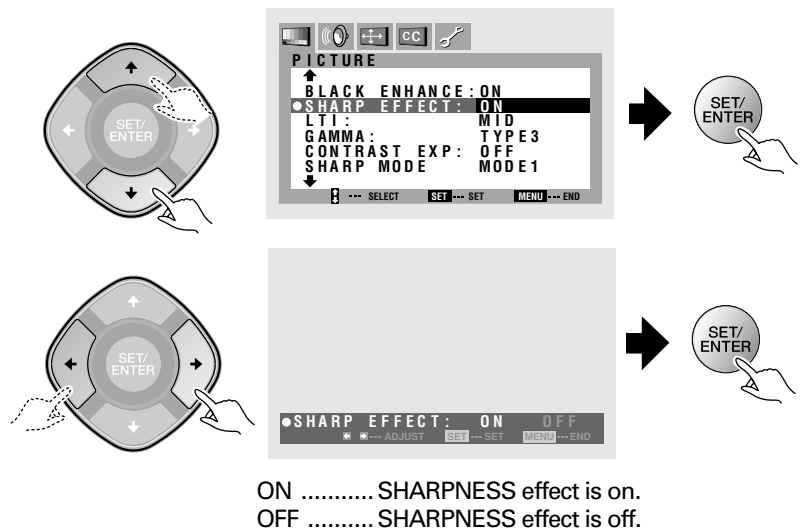

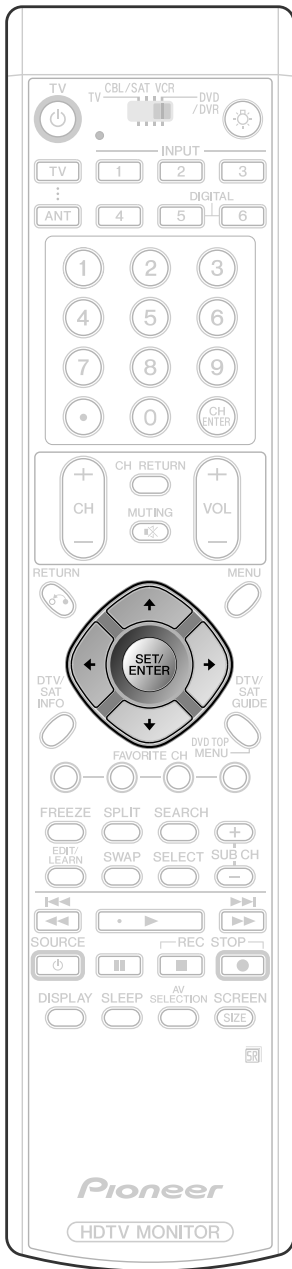

⑨ To adjust Luminance Transient Improvement (LTI)

This enables you to switch the definition of the luminance signal.

NOTES:

- It cannot be used during RGB signal input.
- It can be used only during PICTURE MODE PRO.

Select **LTI** .

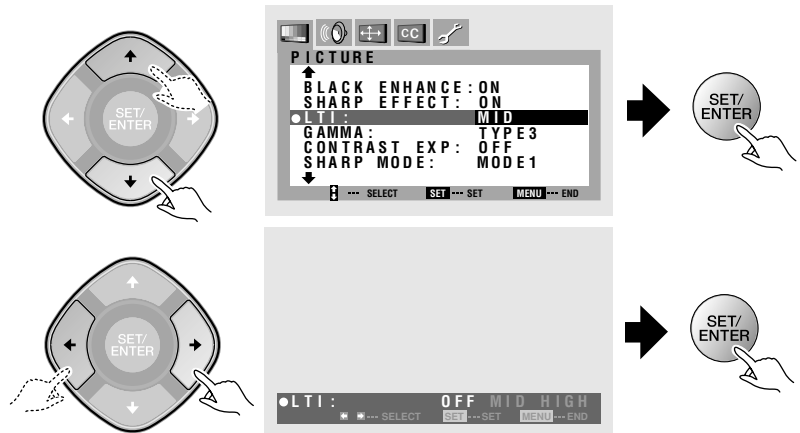

HIGH Maximum LTI effects.
 MID Standard LTI effects.
 OFF No LTI effects.

⑩ To adjust GAMMA

This enables you to switch the balance of the contrast between the bright parts and dark parts of the luminance signal.

NOTE:

It can be used only during PICTURE MODE PRO.

Select **GAMMA** .

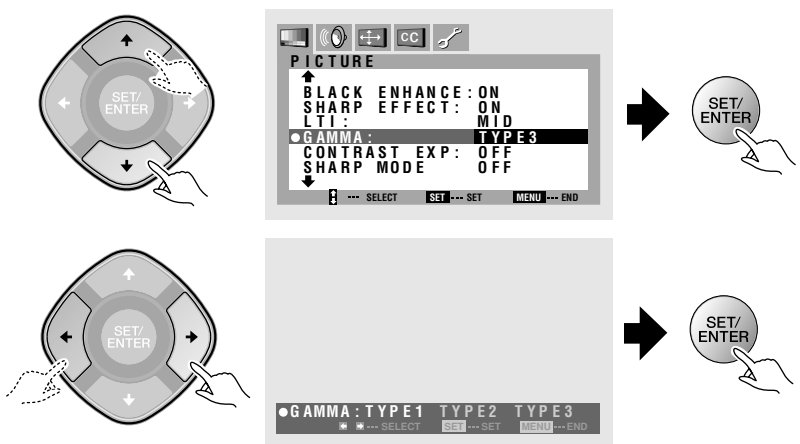

TYPE1 Dark parts of luminance signals are more vividly represented. It is used during movies and television broadcasts with many dark scenes.
 TYPE2 Luminance signal is not corrected.
 TYPE3 It improves the contrast by widening the gap between the bright parts and dark parts of the luminance signal.

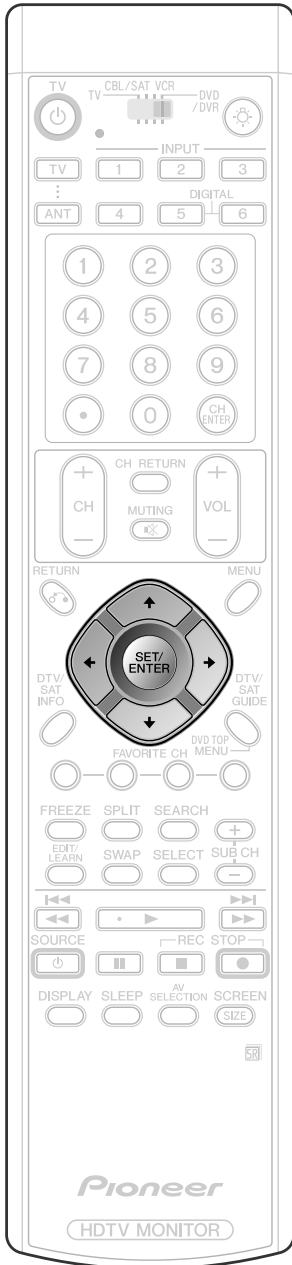

11 To adjust CONTRAST EXP

This enables you to adjust the brightness level of dark areas in accordance with screen brightness.

NOTES:

- It cannot be used during RGB signal input.
- Can only be adjusted when inputting 480p, 1080i and 720p, and when the PRO mode is selected.

Select CONTRAST EXP .

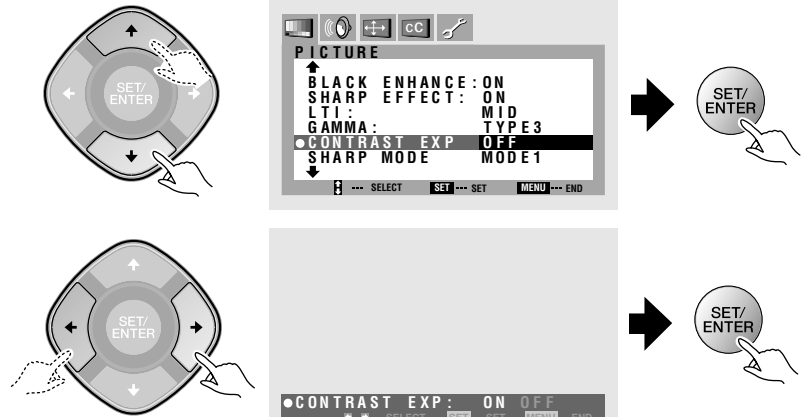

ON CONTRAST EXP effect is on.
 OFF CONTRAST EXP effect is off.

12 To adjust SHARP MODE

This enables you to switch signal bands that correct sharpness.

NOTES:

- It cannot be used during RGB signal input.
- Can only be adjusted when inputting 1080i and 720p, and when the PRO mode is selected.

Select SHARP MODE .

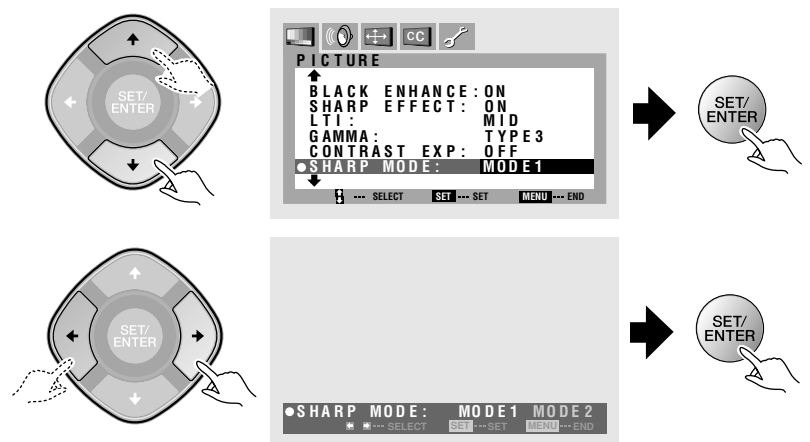

MODE 1 Used to set sharpness correction in the high bandwidth.

MODE 2 Used to set sharpness correction in the low bandwidth.

13 To adjust WHITE BALANCE

This enables you to adjust the color temperature to your taste.

NOTE:

It can be used only during PICTURE MODE PRO.

Select WHITE BALANCE .

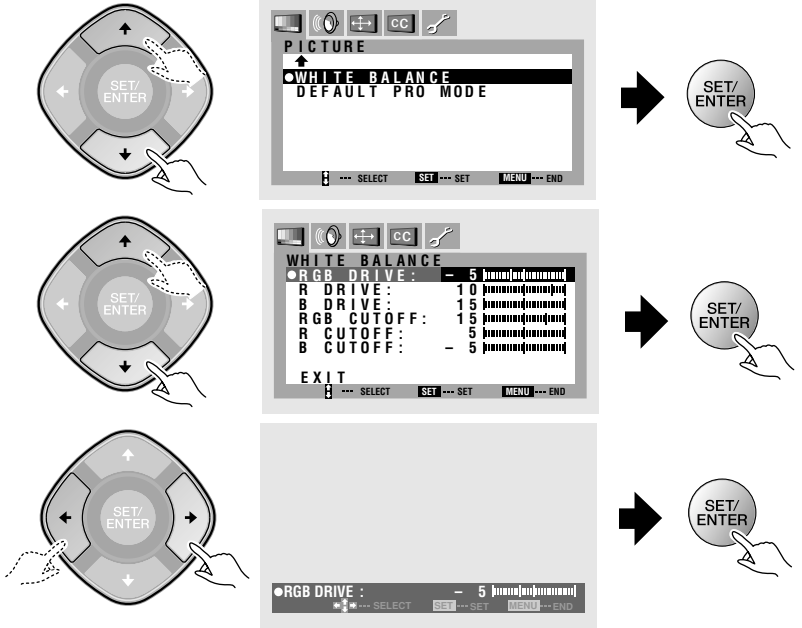
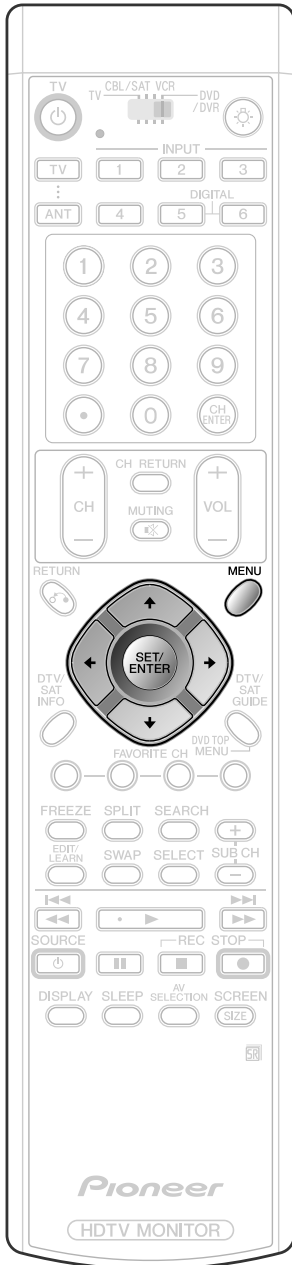

CUT OFF (RGB, R, B) It adjusts the color temperature of dark parts of the picture.

DRIVE (RGB, R, B) It adjusts the color temperature of bright parts of the picture.

Mutually adjust the six lines shown on the above screen to optimize the color temperatures of bright parts and of dark parts.

Adjustments 9 to 13 can only be done when the PICTURE MODE is PRO. Return all contents set in PRO mode to the default status by the following procedure.

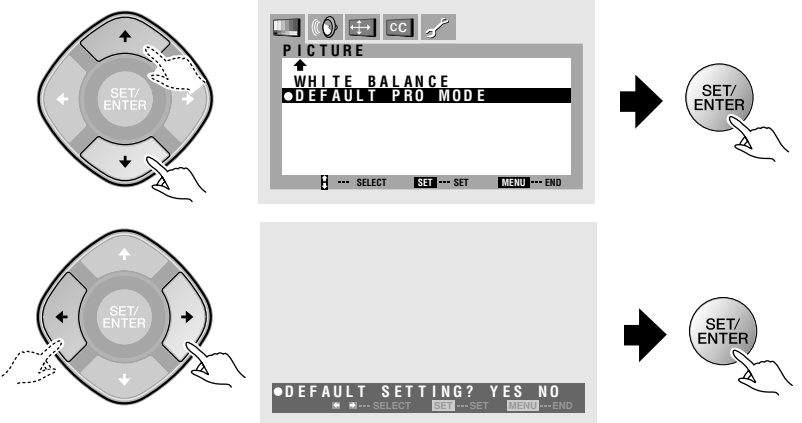

NOTE:

Adjustable range

- RGB DRIVE -10 to 10
- R DRIVE -15 to 15
- B DRIVE -15 to 15
- RGB CUTOFF -30 to 30
- R CUTOFF -5 to 5
- B CUTOFF -5 to 5

4 After setting, press MENU to turn the menu off.

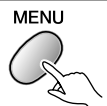

CHANGING SCAN MODE

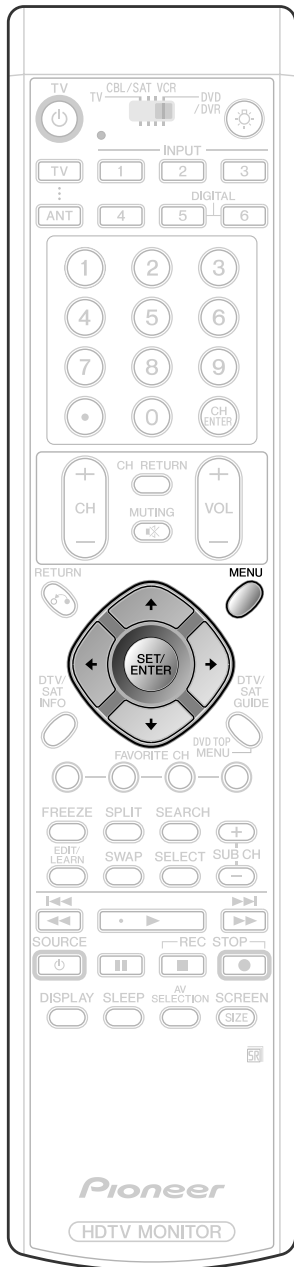

This function switches the display on the screen between 480p (progressive scan) and 1080i (interlace scan) during 480i and 480p.

1 Press MENU and select **SCREEN by using the ← or → button and then pressing ↓ button. (Refer to page 26.)**

2 Select **SCAN MODE.**

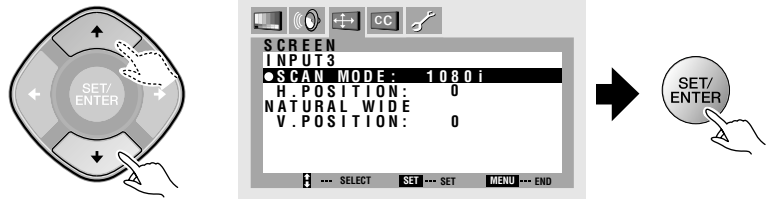

3 Change **SCAN MODE.**



1080i This is optimum for viewing moving video.

480p This is optimum for viewing still pictures or text.

4 After adjusting, press **MENU to turn the menu off.**

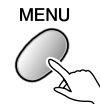

NOTE:

This function cannot be used during "INPUT1, 2 component 1080i, 720p," "INPUT3 RGB Signals," "INPUT 5, 6 Digital Signals 1080i," and "PURE DIGITAL ON."

SOUND ADJUSTMENTS

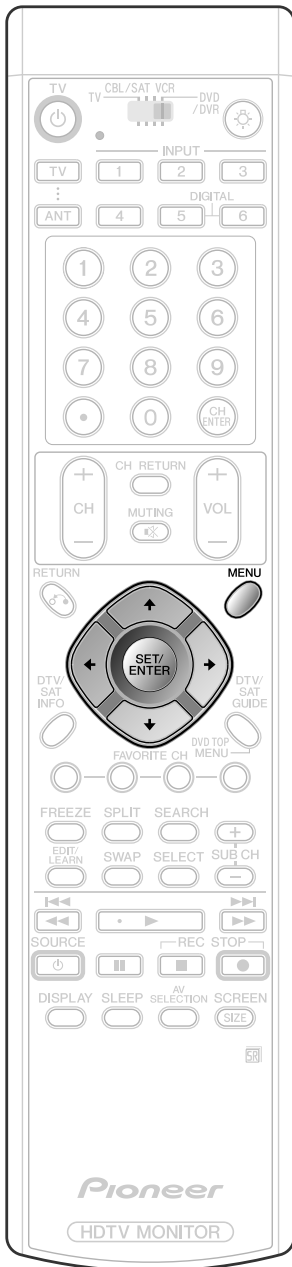

WATCHING STEREO AND BILINGUAL PROGRAMS

The multichannel TV sound (MTS) decoder enables stereo program and Second Audio Program (SAP) to be received. (SAP is often used for a second language). This MTS decoder can only be used if a broadcast of stereo program or SAP is received.

1 Press **MENU** and select **SOUND** by using the **←** or **→** button and then pressing **↓** button. (Refer to page 26.)

2 Select **MTS** in the same way.

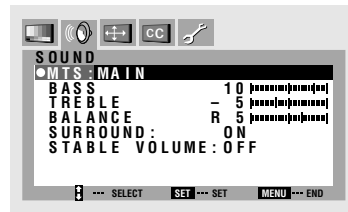
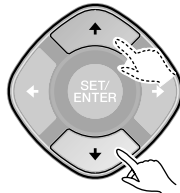

3 Select the desired audio mode.

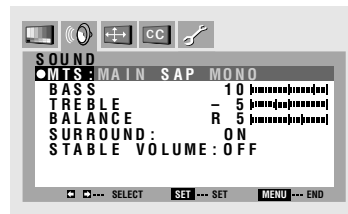
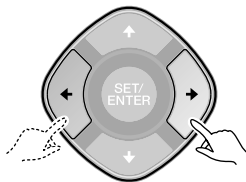

→MAIN←→SAP←→MONO←

4 After setting, press **MENU** to turn the menu off.

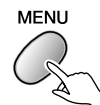

NOTES:

- This function can only be used for TV input.
- Broadcast stereo and SAP reception operate in accordance with the Broadcast Television System Committee (BTSC) standard only. Stereo audio transmission from CATV system can vary from area and may not be compatible with the BTSC standards. Check with your local cable company for specific compatibility requirements.

TO ADJUST THE SOUND QUALITY

BASS, TREBLE and BALANCE can be adjusted.

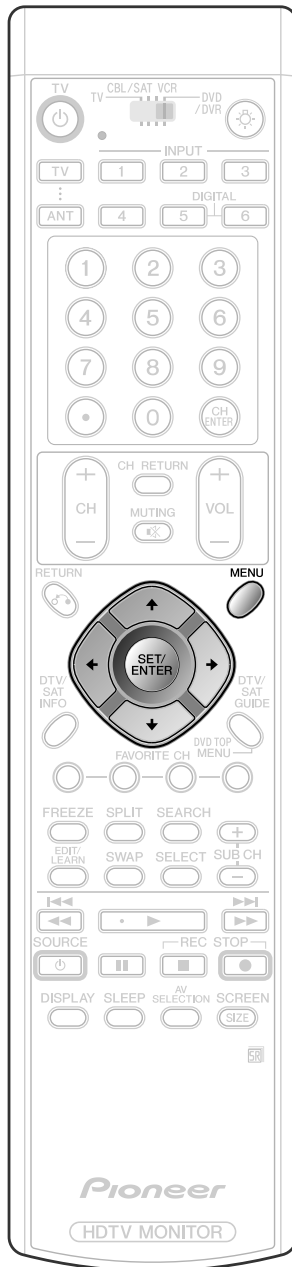

1 Press **MENU** and select **SOUND** .
(Refer to page 26.)

2 Select the adjustment item.

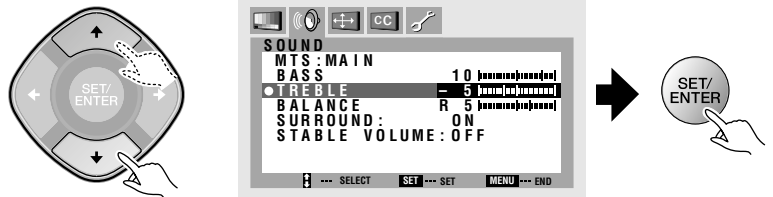

3 Adjust by pressing ◀ or ▶ .

- Adjustable range
BASS, TREBLE : - 15 to 15
BALANCE : L (Left) 15 to R (Right) 15

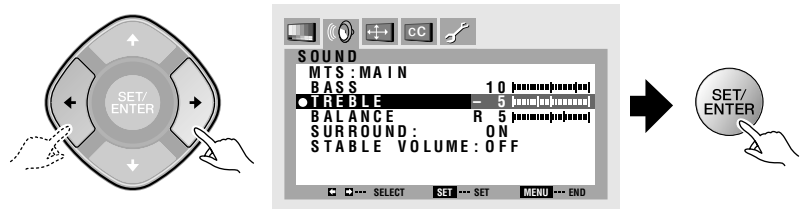

- Repeat steps 2 and 3 for other items.

4 After adjusting, press **MENU** to turn the menu off.

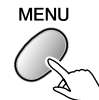

NOTE:

This function cannot be used when the **SPEAKER** mode is **CENTER IN** or when the **SPEAKER** mode is **OFF** and **AUDIO OUT** mode is **FIXED** (see page 76).

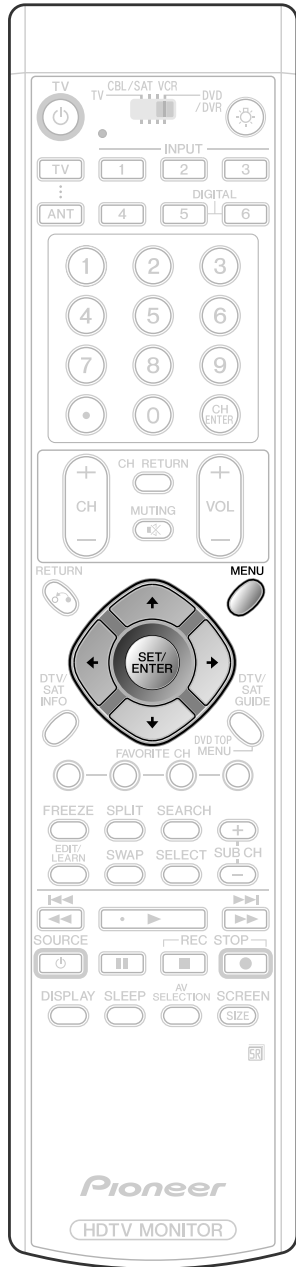

TO SELECT THE DESIRED SURROUND MODE

This function creates the sound with a sense of presence. In a concert hall or in a theater, you hear a mixture of sound coming directly to you (direct sound) and sound that reaches you with a slight delay after being reflected from the walls (indirect sound). Surround mode applies this principal to create a sense of presence by mixing slightly delayed sound signals with direct sound signals.

1 Press MENU and select **SOUND .**
(Refer to page 26.)

2 Select **SURROUND .**

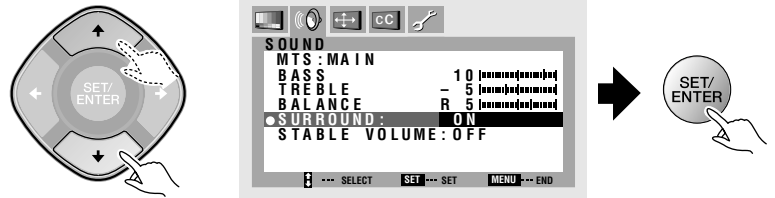

3 Select the desired SURROUND mode.

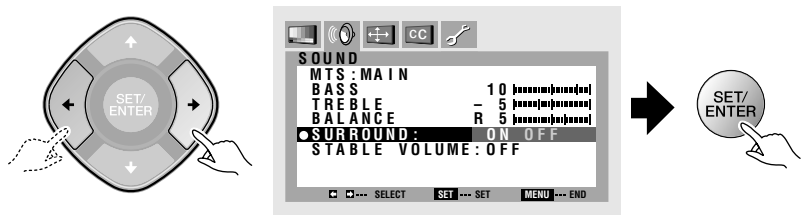

ON This is an easy way to enjoy SURROUND.
OFF Turns off the surround effect.

4 After setting, press MENU to turn the menu off.

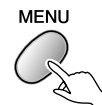

NOTES:

- This function cannot be used when the SPEAKER mode is CENTER IN or when the SPEAKER mode is OFF and AUDIO OUT mode is FIXED (see page 76).
- The surround effect cannot be obtained with mono sound.
- In some cases, the surround effect may be minimal.

TO ADJUST STABLE VOLUME

A loud sound may suddenly be emitted when you change the TV channel or when the broadcast switches to a commercial or the like. If so, setting STABLE VOLUME to ON will enable you to automatically change the volume level to what is comfortable.

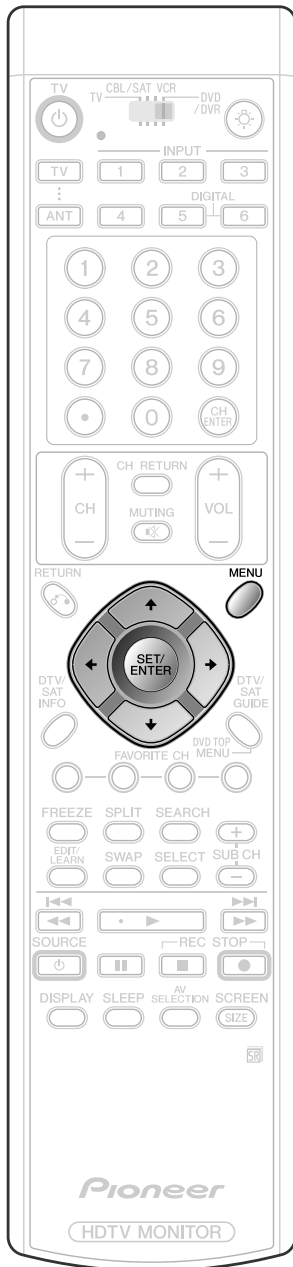

1 Press **MENU** and select **SOUND** .
(Refer to page 26.)

2 Select **STABLE VOLUME** .

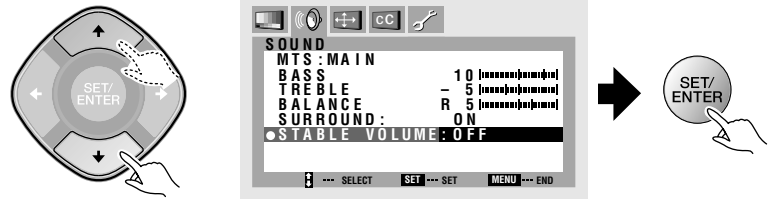

3 Set **STABLE VOLUME** to **ON**.

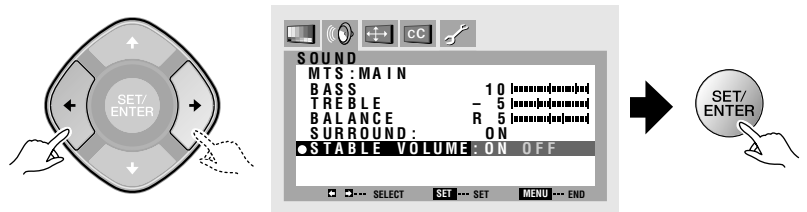

4 After adjusting, press **MENU** to turn the menu off.

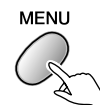

NOTE:

Because volume level is automatically adjusted when STABLE VOLUME is set to ON, the sound might not be loud. In this case, set STABLE VOLUME to OFF.

DIGITAL INTERFACE

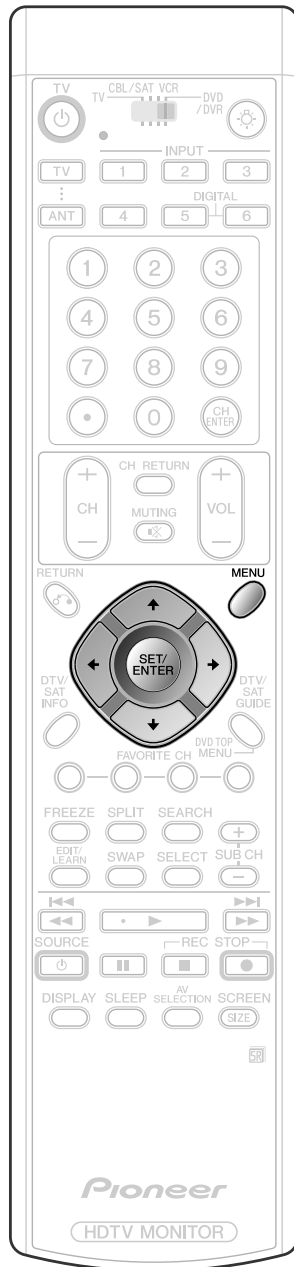

PURE DIGITAL

This function faithfully reproduces the input signal without any processing when digital signal input (INPUT 5, 6) is selected.

1 Press MENU and select SETUP by using the ← or → button and then pressing ↓ button. (Refer to page 26.)

2 Select DIGITAL INTERFACE.

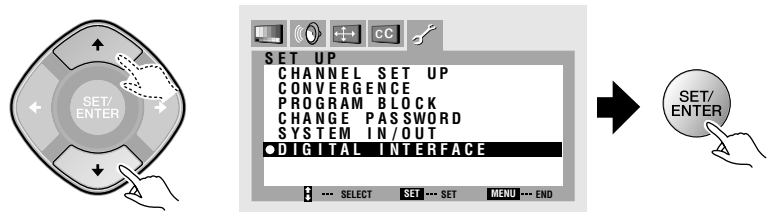

3 Select PURE DIGITAL.

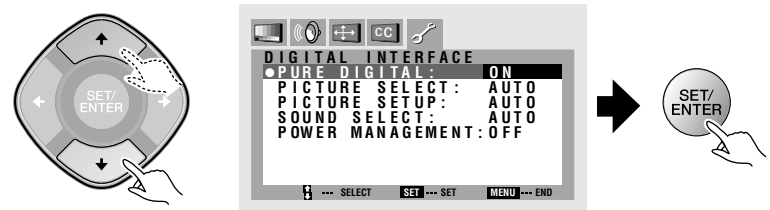

4 Set PURE DIGITAL to ON.



ONThe input signal is faithfully reproduced without any processing.

OFFYou can adjust the picture quality to your taste by performing appropriate signal processing.

5 After setting, press MENU to turn the menu off.

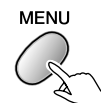

NOTES:

- There are items that can not be adjusted by PICTURE ADJUSTMENT when PURE DIGITAL is on.
- This function can only be used during digital signal input (INPUT 5, 6).

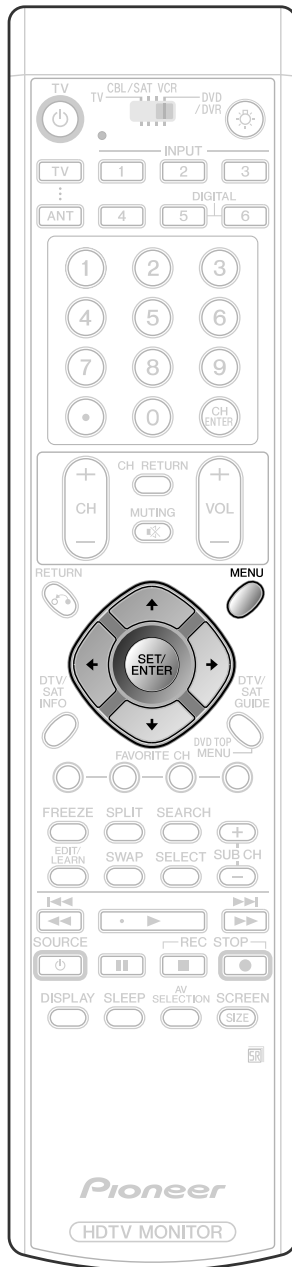

PICTURE SELECT

This function allows you to switch the input signal format to automatic or manual when inputting the digital signal.

1 Press **MENU** and select **SETUP** by using the **←** or **→** button and then pressing **↓** button. (Refer to page 26.)

2 Select **DIGITAL INTERFACE**.

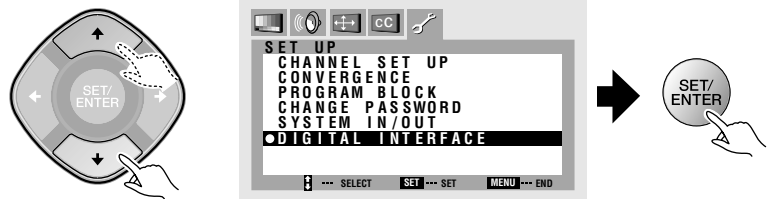

3 Select **PICTURE SELECT**.

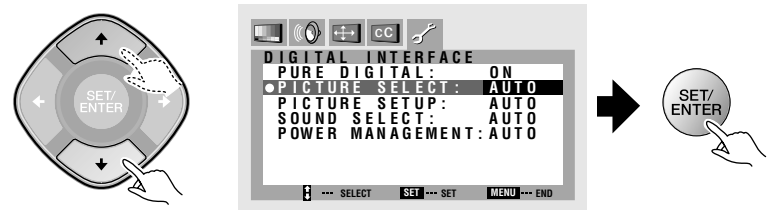

4 Set **PICTURE SELECT** to **AUTO**.



AUTO Automatically identifies input video signals.

COLOR1 Accepts Y Pb/Cb Pr/CR (4:2:2) signals.

COLOR2 Accepts Y Pb/Cb Pr/CR (4:4:4) signals.

COLOR3 Accepts RGB signals.

5 After setting, press **MENU** to turn the menu off.

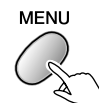

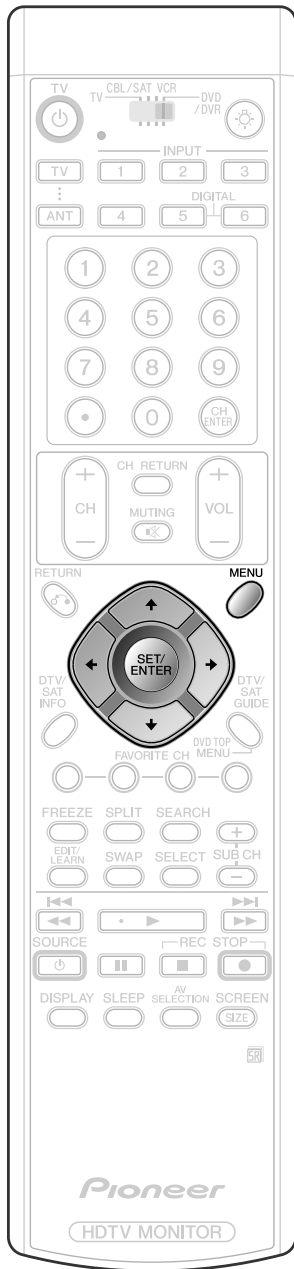

PICTURE SETUP

This function allows you to switch the input signal level to automatic or manual when inputting the digital signal.

1 Press MENU and select SETUP by using the ← or → button and then pressing ↓ button. (Refer to page 26.)

2 Select DIGITAL INTERFACE .

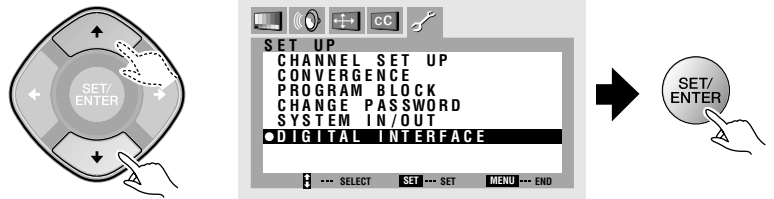

3 Select PICTURE SETUP .

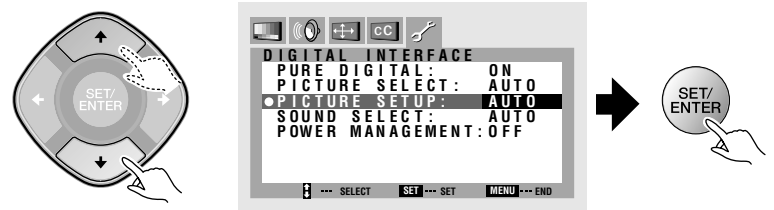

4 Set PICTURE SETUP to AUTO.



AUTO Select AUTO for normal picture set up.

TYPE1 Select TYPE1 to remove white glare in the picture when AUTO is set.

TYPE2 Select TYPE2 for too dark or distorted picture when AUTO is set.

5 After setting, press MENU to turn the menu off.

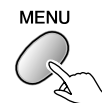

SOUND SELECT

This function allows you to switch the sound signal to automatic or manual when inputting the digital signal.

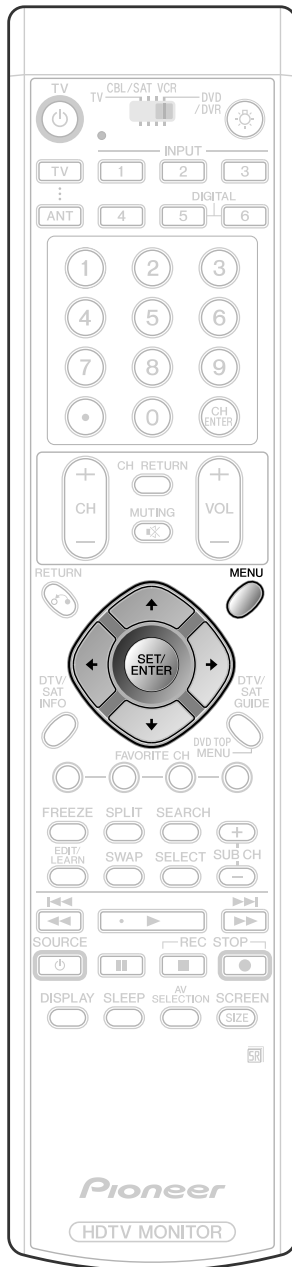

- 1 Press **MENU** and select **SETUP** by using the **←** or **→** button and then pressing **↓** button. (Refer to page 26.)

- 2 Select **DIGITAL INTERFACE**.

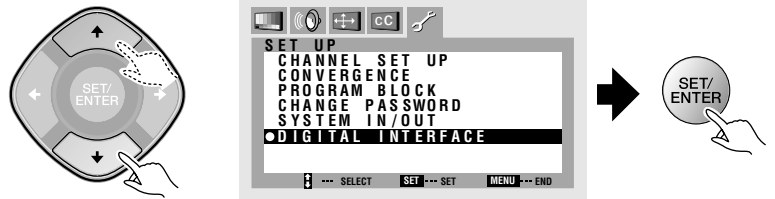

- 3 Select **SOUND SELECT**.

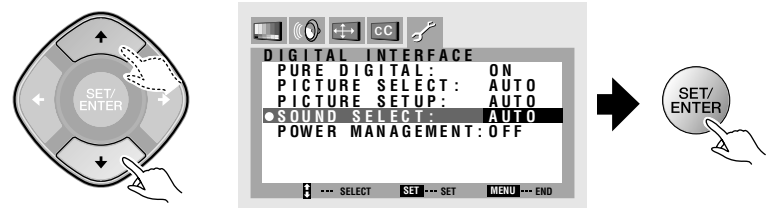

- 4 Set **SOUND SELECT** to **AUTO**.

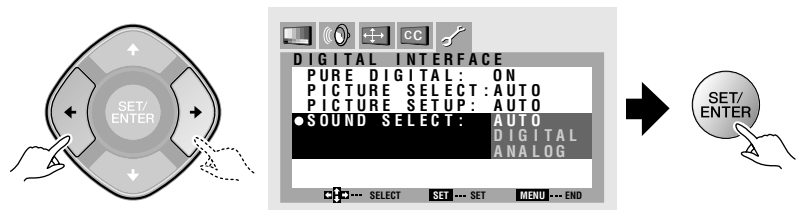

AUTO Automatically identifies input audio signals.

DIGITAL Accepts digital audio signals.

ANALOG Accepts analog audio signals.

- 5 After setting, press **MENU** to turn the menu off.





NOTES:

- It can be used only during digital signal input (INPUT 5, 6).
- When power management mode is operating, the POWER STANDBY indicator (green) flashes. At this time, power management mode can be shut off to operate the monitor by pushing either the INPUT SELECT, or MENU button on the front panel or on the remote control. Pushing the POWER button sets it in standby status.

Control panel of the monitor

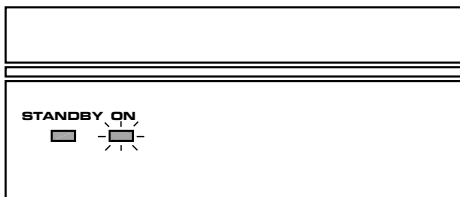

POWER MANAGEMENT

This function automatically turns on power management mode if no digital signal is input when digital signal input is selected. When digital signal input restarts, power management mode is cancelled.

1 Press MENU and select SETUP by using the ← or → button and then pressing ↓ button. (Refer to page 26.)

2 Select DIGITAL INTERFACE.

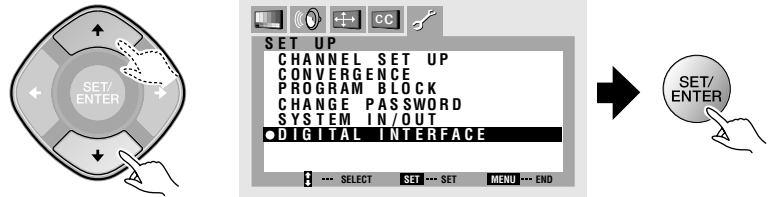

3 Select POWER MANAGEMENT.

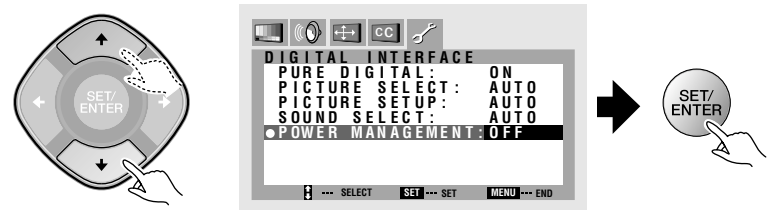

4 Set POWER MANAGEMENT to ON.

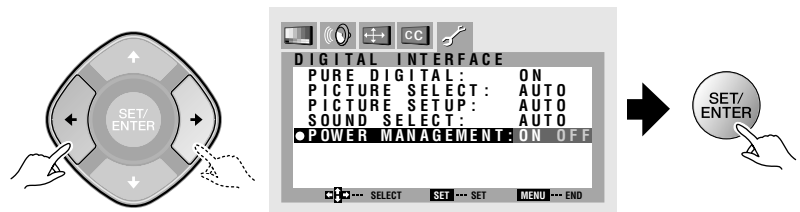

ON Turns on power management mode
 OFF Turns off power management mode.

5 After setting, press MENU to turn the menu off.

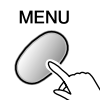

MULTI-POINT CONVERGENCE ADJUSTMENT

Before convergence adjustment*1, please choose a stabilized input signal*2 in order to display a stable cross pattern.

*1 Convergence adjustment Color deviation adjustment

*2 Stabilized input signal Examples, DVD player, digital tuner, etc.

Convergence adjustment may be fined-tuned here.

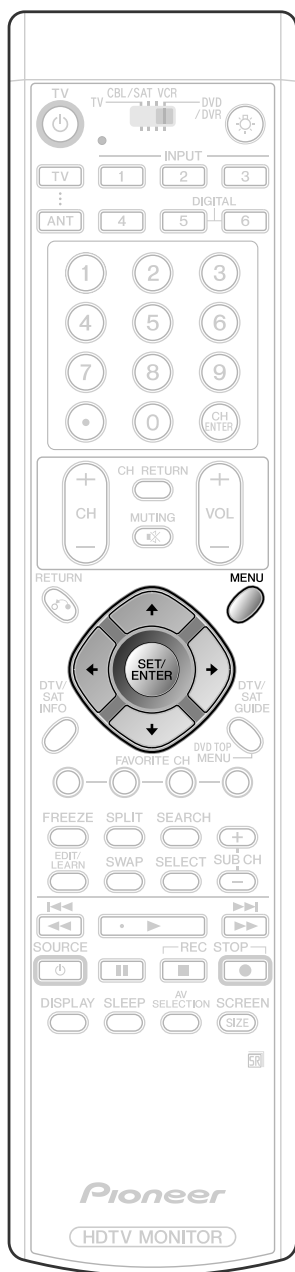

1 Press **MENU** and select **SETUP** by using the **←** or **→** button and then pressing **↓** button. (Refer to page 26.)

2 Adjust the center point convergence. (Refer to steps 2 to 5 on pages 30 to 31.)

3 Select **ADJ MULTI-POINT**.

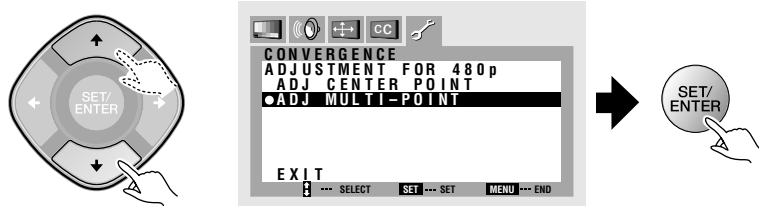

4 Select the adjust point.

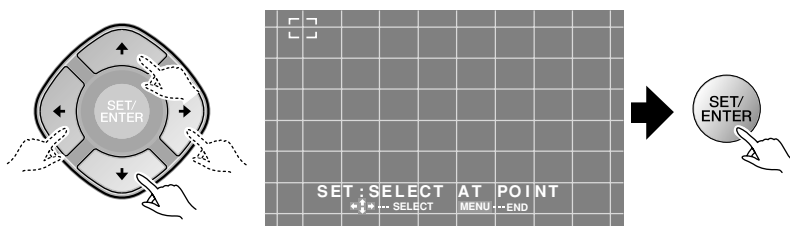

5 Adjust the red line.

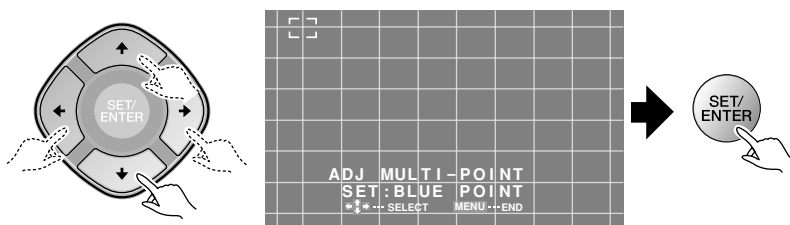

NOTES:

- The cursor is partially invisible around the edge of the screen according to the SCAN MODE.
- It is not possible to adjust all these points (points of change on the cross-hatch).
- Some of the cross-hatch lines are not straight, but this is not a malfunction. They are not always straight on a normal TV.

6 Adjust the blue line.

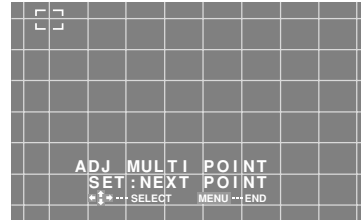
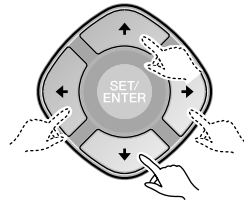
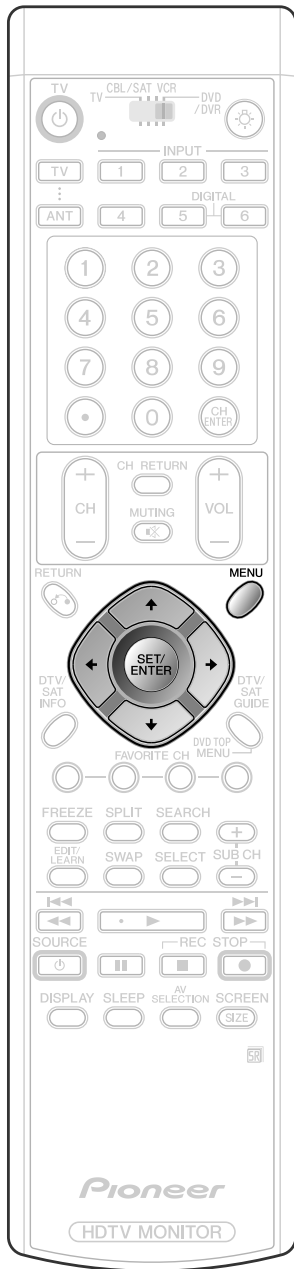

- The brackets which shows the adjusting point will move in order.
Move to the next point to be adjusted, and repeat steps 4 to 6.

7 After completing the convergence adjustment, press MENU twice to turn the menu off.



CONNECTION WITH RECEIVER (1)

The audio signal output from this unit can be reproduced on the receiver when this monitor is connected to the receiver. When this monitor is connected to the CENTER OUT terminal of the receiver, the speaker of this monitor can be used as the center speaker.

- Before making or changing connections, set the power switch to off and unplug the power cord from the AC outlet.
- For details of connecting DVD/DVR player, VCR, SAT tuner, etc., refer to page 16.
- After completing connections, perform the "SPEAKER and AUDIO OUT settings" operation.

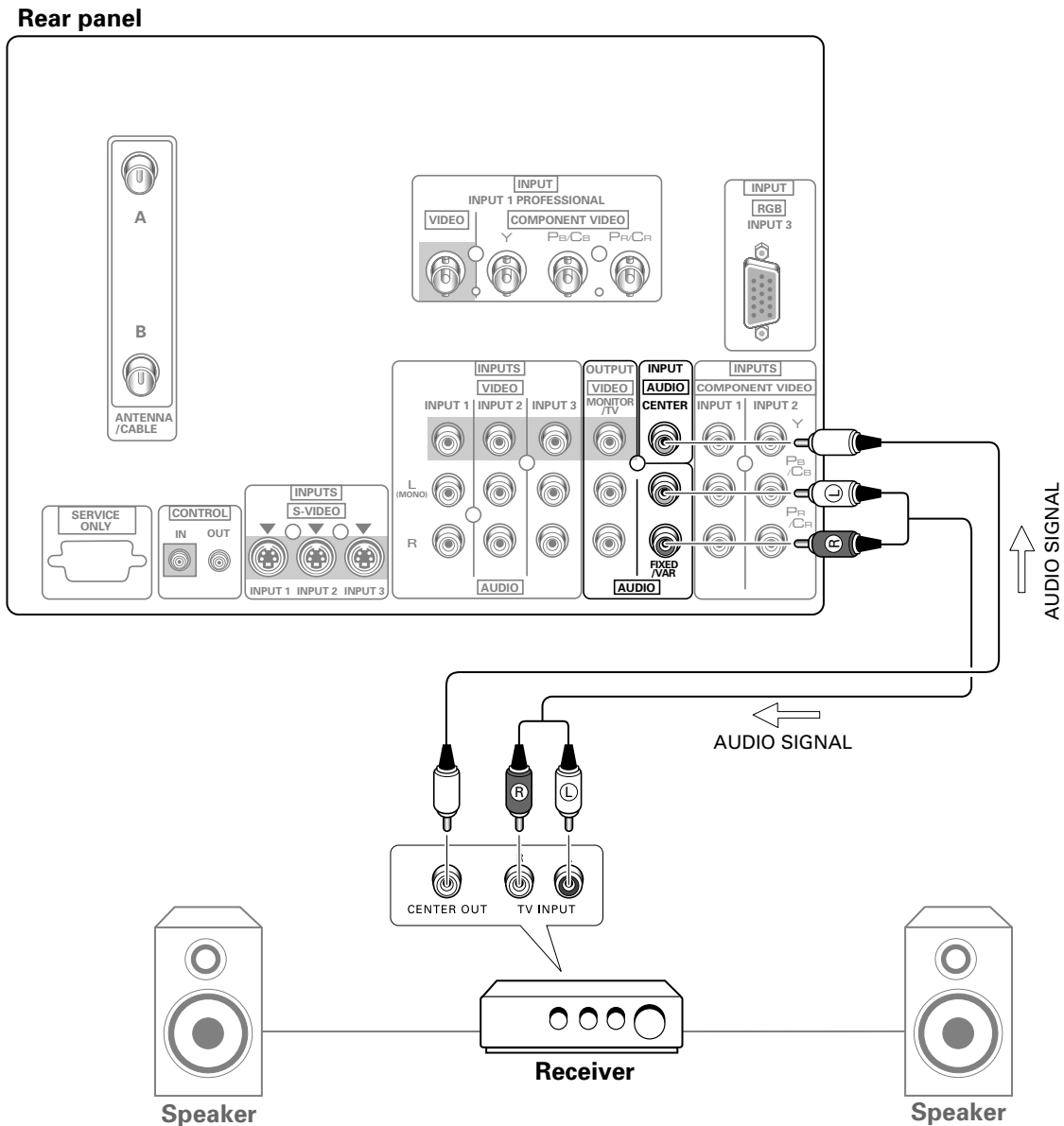

SPEAKER and AUDIO OUT settings

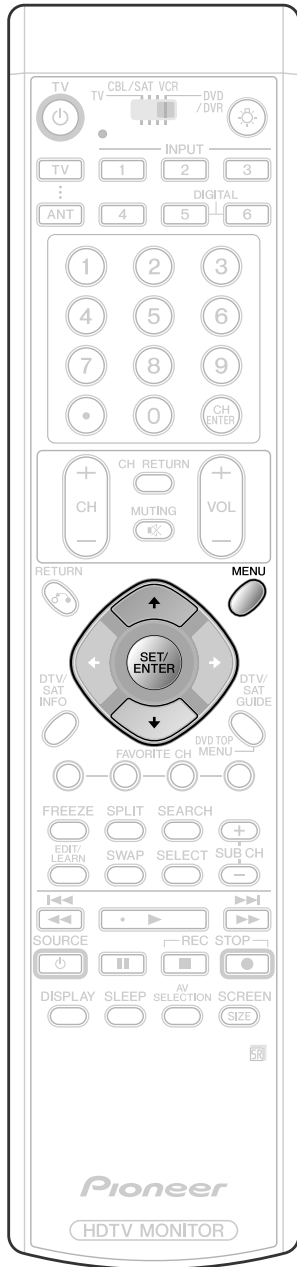

1 Press **MENU** and select **SETUP** by using the **←** or **→** button and then pressing **↓** button. (Refer to page 26.)

2 Select **SYSTEM IN/OUT** in the same way.

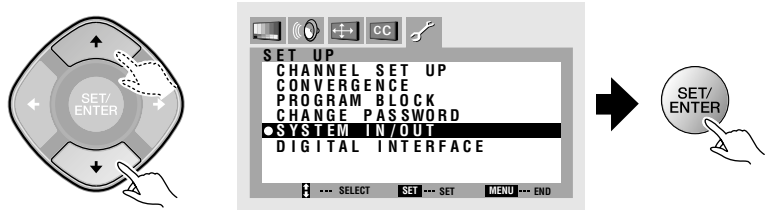

3 Select **SPEAKER**.

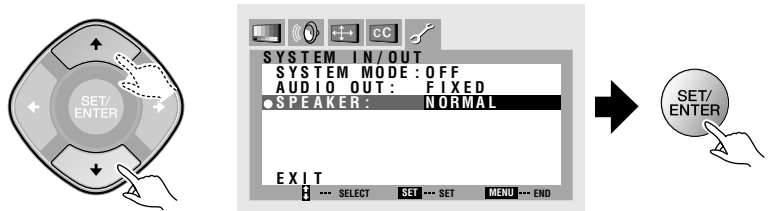

4 Select the **SPEAKER** mode.

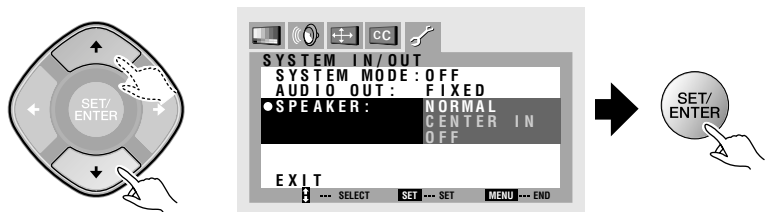

- NORMAL The Monitor sound is output from the speaker.
- CENTER IN ... Select CENTER IN to set TV monitor speaker as the center speaker. The TV monitor speaker will perform as the center speaker from the audio input signal, connected to the AUDIO CENTER INPUT terminal.
- OFF No sound will be output from the Monitor's speaker.

NOTE:
After the speaker mode is set to **CENTER IN**, the volume of the center speaker should be controlled from this monitor.

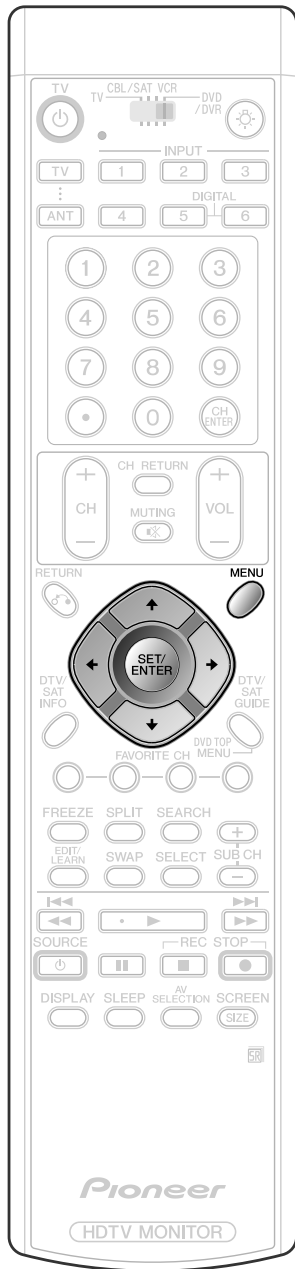

5 Select **AUDIO OUT** .

- If the speaker mode was set to CENTER IN in step 4, the AUDIO OUT mode will automatically change to FIXED, and VAR cannot be selected.

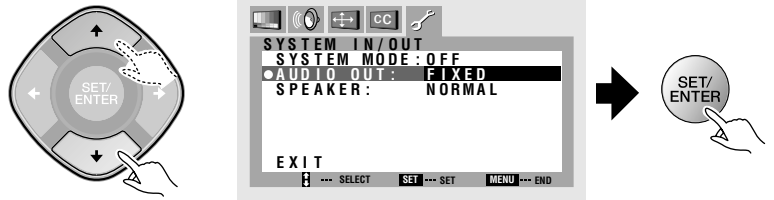

6 Select the **AUDIO OUT** mode.

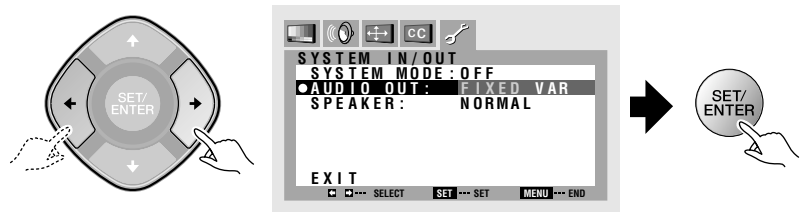

FIXED Signals output from the AUDIO OUTPUT terminal will not change even if the Monitor's volume is adjusted.

VAR (variable) ... Sound signals output will change as Monitor's volume is changed.

- When SYSTEM MODE has been set to ON, the audio out mode will change to MUTING and sound signals will not be output from the AUDIO OUTPUT terminal (see page 79).
- The sound signals output will change in accordance with the SURROUND mode setting (see page 66).

7 After setting, press **MENU** to turn the menu off.

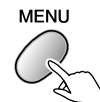

NOTE:
If **AUDIO OUT** is set to **VAR** and the sound is distorted, lower the Monitor volume.

CONNECTION WITH RECEIVER (2)

This unit can be used as the monitor for the receiver when this unit is connected to the receiver. When this unit is connected to the CENTER OUT terminal of the receiver, the speaker of this unit can be used as the center speaker.

- Before making or changing connections, set the power switch to off and unplug the power cord from the AC outlet.
- Connect the DVD/DVR, VCR, SAT tuner or similar component to the receiver.
- After completing connections, perform the "SYSTEM MODE setting" operation.

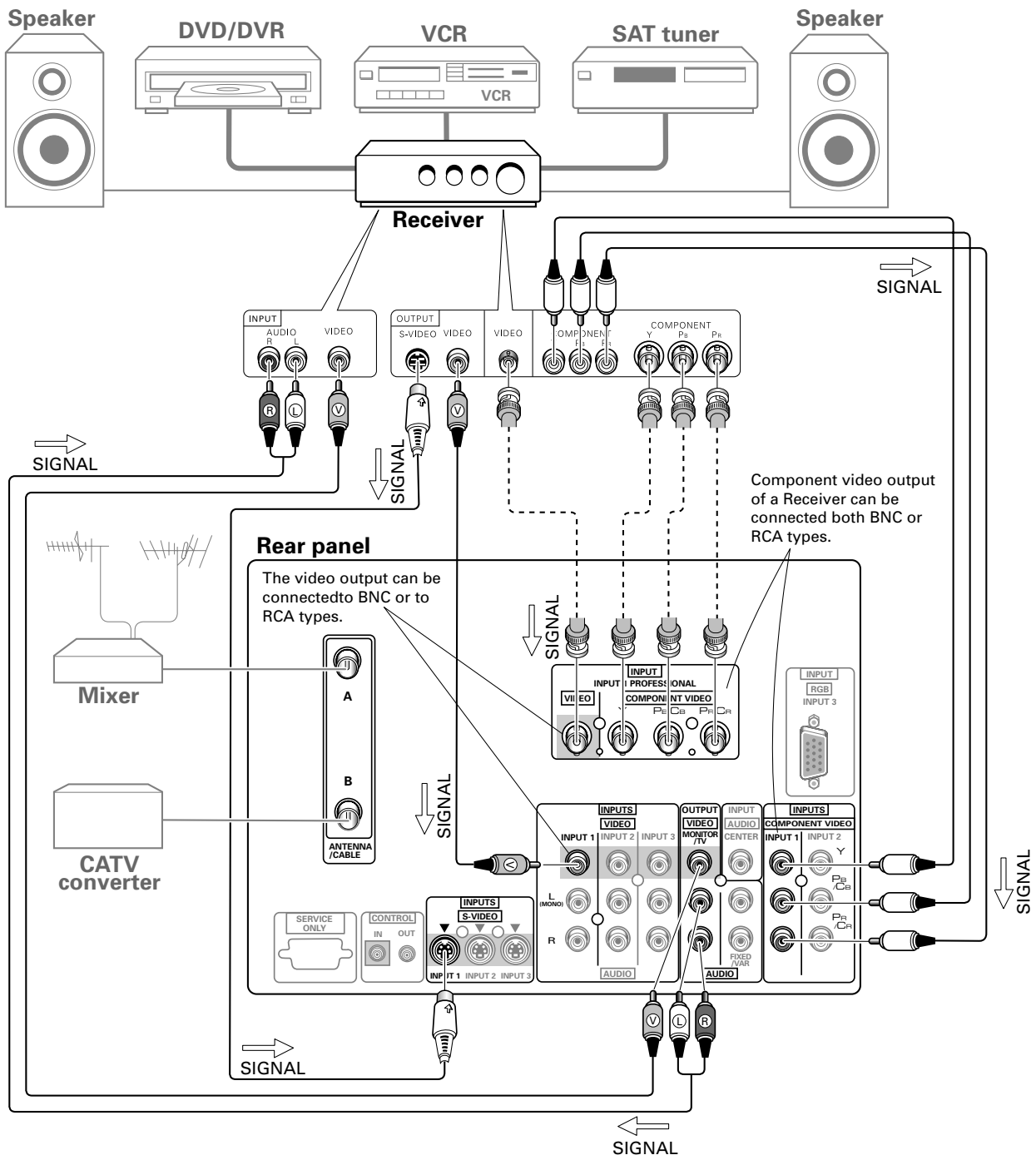

SYSTEM MODE setting

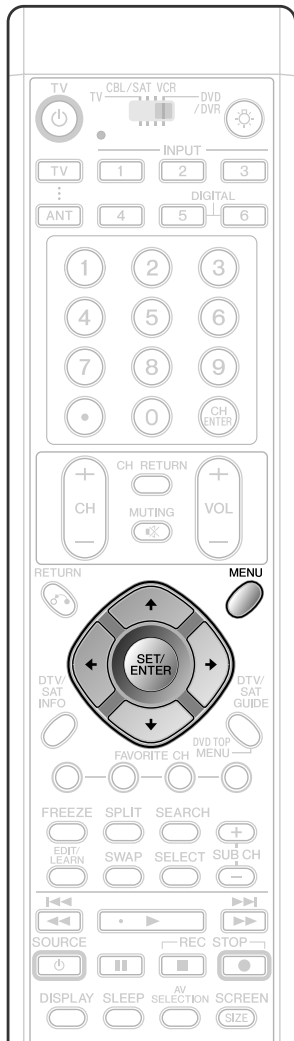

1 Press **MENU** and select **SET UP** .
(Refer to page 26.)

2 Select **SYSTEM IN/OUT** .

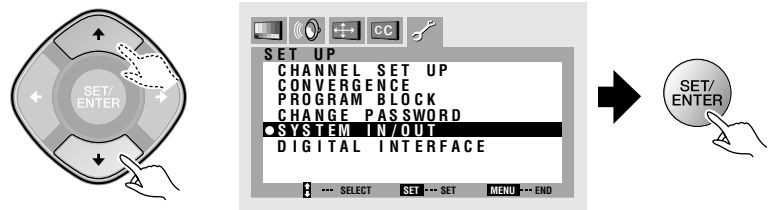

3 Select **SYSTEM MODE** .

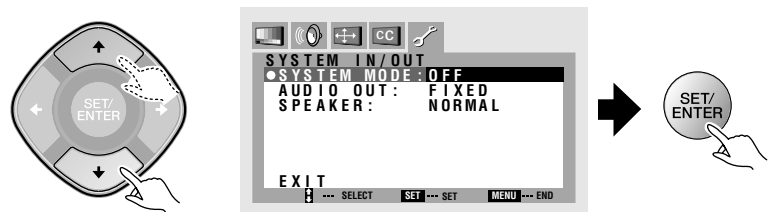

4 Switch the **SYSTEM MODE**.

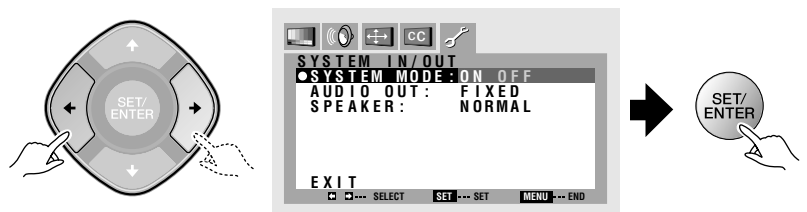

Unless required, set the **SYSTEM MODE** to **OFF**.

Notes on SYSTEM MODE ON :

- The input cannot be switched even if you press the Input selector button of the remote control unit.
- On the sub-picture of a SPLIT screen, only the input signal from the antenna can be displayed.
- The SEARCH screen function will not be operable.
- No signal will be output from the AUDIO OUTPUT terminal.
- Setting SYSTEM MODE ON will cause RGB input signals and DIGITAL input signals to not be displayed.

ON The Monitor input is fixed to INPUT 1 and the images of the input source selected by the receiver will be displayed.

OFF Normal setting.

5 After setting, press **MENU** to turn the menu off.

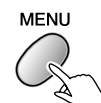

CONNECTING THE SYSTEM REMOTE CONTROL

(When operating Pioneer units with SR mark)

If you want to control your Pioneer equipment with the remote for this unit, you can daisy-chain the components. Connect the audio/video components using the pioneer SR terminals as shown below. See page 86 to 91 for how to control other components.

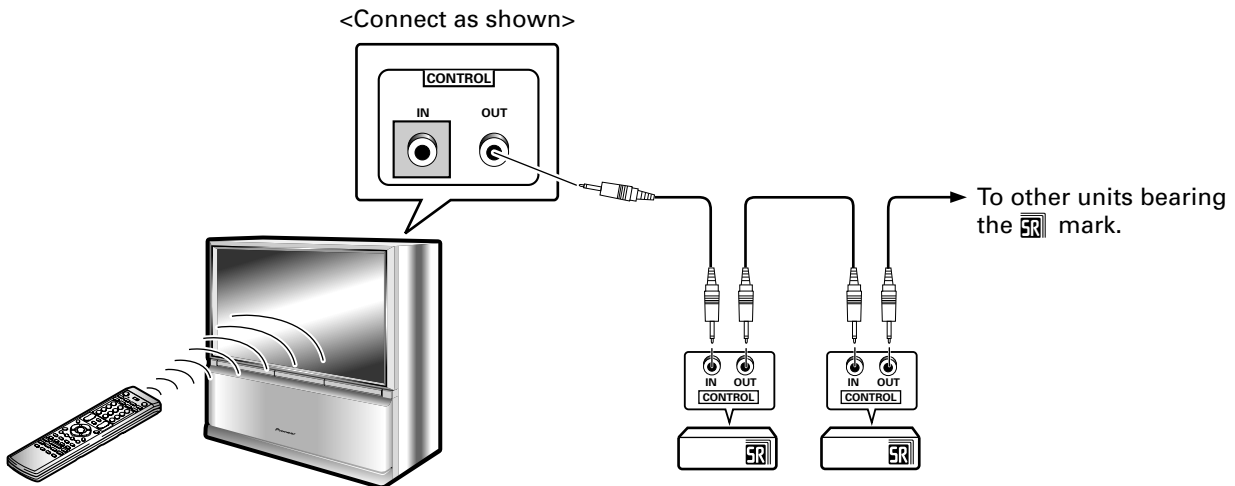

NOTES:

- When the Pioneer unit with SR mark is connected to the CONTROL IN terminal of the projection monitor, the remote sensor of the projection monitor does not accept signals from the remote control unit. In this case, point the remote control at the unit in the chain (the equipment with no CONTROL IN connection).
- To connect the control cord, use the commercially available mini plug cord (monaural).

REMOTE CODE SET UP

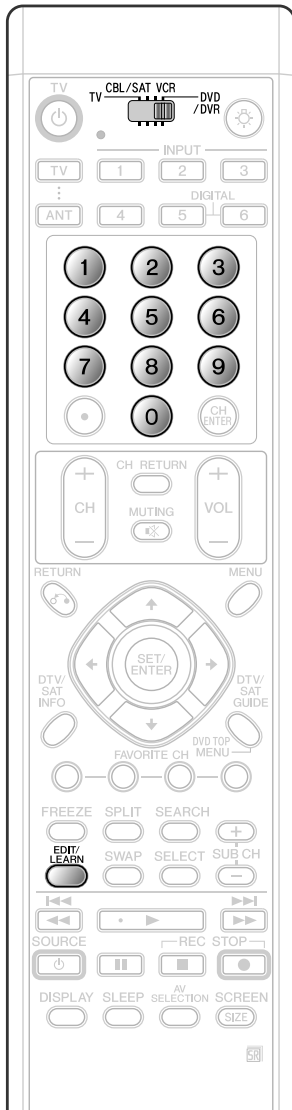

To operate other manufacturers' audio/video units using this remote control unit, remote control codes need to be input.

- There are two methods of setting remote control codes
- For calling the other manufacturers' preset remote control codes to this remote control unit
- For learning other manufacturers' remote control codes

RECALLING OTHER MANUFACTURERS' PRESET REMOTE CONTROL CODES

1 Set the mode switch to match the device to which you want to preset the remote control code

- Example: To select DVD/DVR.

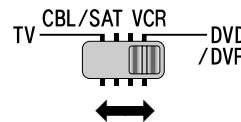

2 At the same time, press the EDIT button and number button 1.

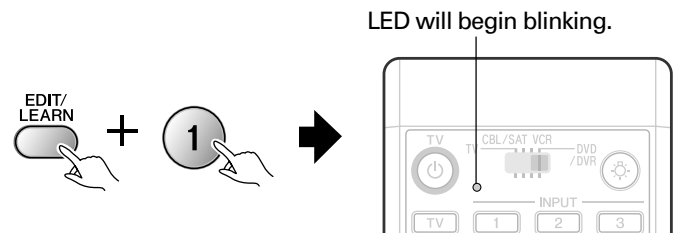

LED will begin blinking.

3 Select the desired manufacturer.

- Select from the figure on page 82.
- Example: To select 006 (PIONEER) in the DVD/DVR mode.



- If the LED blinks rapidly when the number button has been pressed, there has been an error. Input the number again.
- After setting, you can automatically use the remote control in the usual manner.

NOTES:

- To stop the EDIT mode in the middle, press the EDIT button once more.
- If mode switch is switched while in EDIT mode, EDIT mode will be canceled.
- After step 1 and step 2, if you do not press the button for one minute (no operation), the EDIT mode will be canceled.
- If the table on page 82 does not include your desired manufacturer or the remote control code does not work, you can make the memory learn its code by the learning mode (see page 84).
- The initial code is "000" (PIONEER).

Manufacturer's preset remote control codes

CABLE/SAT	VCR	DVD/DVR
000	PIONEER1(CABLE)	PIONEER PIONEER(DVD)
001	PIONEER2(CABLE)	FISHER PANASONIC(DVD)
002	JERROLD1(CABLE)	FISHER SAMSUNG(DVD)
003	JERROLD2(CABLE)	FISHER SONY(DVD)
004	JERROLD3(CABLE)	GOLDSTAR TOSHIBA(DVD)
005	JERROLD4(CABLE)	HITACHI JVC(DVD)
006	JERROLD5(CABLE)	HITACHI2 PIONEER(DVD-RECORDER)
007	JERROLD6(CABLE)	HITACHI3 PIONEER2(DVD-RECORDER)
008	JERROLD7(CABLE)	MAGNAVOX2 PIONEER3(DVD-RECORDER)
009	JERROLD8(CABLE)	MITSUBISHI PANASONIC(DVD-RECORDER)
010	JERROLD9(CABLE)	MITSUBISHI2 PANASONIC2(DVD-RECORDER)
011	JERROLD10(CABLE)	MITSUBISHI3 PANASONIC3(DVD-RECORDER)
012	S.A.1(CABLE)	MITSUBISHI4 PHILIPS(DVD-RECORDER)
013	S.A.2(CABLE)	MITSUBISHI5 SHARP(DVD-RECORDER)
014	S.A.3(CABLE)	MITSUBISHI6 SHARP2(DVD-RECORDER)
015	S.A.4(CABLE)	PANASONIC TOSHIBA(DVD-RECORDER)
016	ZENITH1(CABLE)	PANASONIC2 TOSHIBA2(DVD-RECORDER)
017	ZENITH2(CABLE)	PANASONIC3
018	ZENITH3(CABLE)	RCA
019		RCA2
020	PIONEER(SAT)	RCA3 PIONEER(LD)
021	RCA1(SAT)	SANYO KENWOOD(LD)
022	RCA2(SAT)	SANYO2 PANASONIC1(LD)
023	SONY(SAT)	SANYO3 PANASONIC2(LD)
024		SHARP PHILIPS(LD)
025		SHARP2 RCA(LD)
026		SHARP3 SONY(MDP)
027		SONY(BETA) SONY(LD)
028		SONY(VHS)
029		SONY(8mm)
030		TOSHIBA
031		JVC
032		JVC2
033		JVC3
034		JVC4
035		JVC5
036		ZENITH
037		MITSUBISHI(J-3)

CABLE/SAT	VCR	DVD/DVR
038	SHARP(J-2)	
039	PANASONIC(J-3)	
040	TOSHIBA(J-3)	
041	GRANDIENTE	
042	AKAI	
043	PIONEER2	
044	SANYO4	
045	MATSUI	
046	AIWA	
047	ALBA81	
048	BUSH	
049	THOMSON	
050	BAIRD	
051	TELEFUNKEN	
052	ALBA	
053	Grundig1	
054	Grundig2	
055	Grundig3	
056	SONY2	
057	SONY3	
058	SONY4	
059	RCA4	
060	PHILIPS	
061	PHILIPS2	
062	PHILIPS3	
063	PHILIPS4	
064	PHILIPS5	
065	PHILIPS6	
066	SAMSUNG	
067	SAMSUNG2	
068	SAMSUNG3	
069	SAMSUNG4	
070	SAMSUNG5	
071	SAMSUNG6	
072	MARANTZ	
073	MARANTZ2	
074	GE	
075	GE2	

Different functions can be performed by different components using the remote control buttons. (See pages 88 to 91).

CABLE/SAT	VCR	DVD/DVR
076	GE3	
077	YAMAHA	
078	YAMAHA2	
079	YAMAHA3	
080	YAMAHA4	
081	CURTIS_MATHIS	
082	CURTIS_MATHIS2	
083	CURTIS_MATHIS3	
084	FUNAI	
085	ADMIRAL	
086	KENWOOD	
087	KENWOOD2	
088	KENWOOD3	
089	NEC	
090	NEC2	
091	NEC3	
092	NEC4	
093	WARDS	
094	WARDS2	
095	WARDS3	
096	WARDS4	
097	MEMOREX	
098	MEMOREX2	
099	JC_PENNY	
100	JC_PENNY2	
101	JC_PENNY3	
102	JC_PENNY4	
103	JC_PENNY5	
104	JC_PENNY6	

TO LEARN REMOTE CONTROL CODES

To operate other manufacturers' remote control codes not preset using the remote control unit, have the remote control unit learn these signals.

Example) To learn the VCR power to turn on.

Before operation:

To set the mode switch to VCR when a video cassette recorder is connected (see page 16).

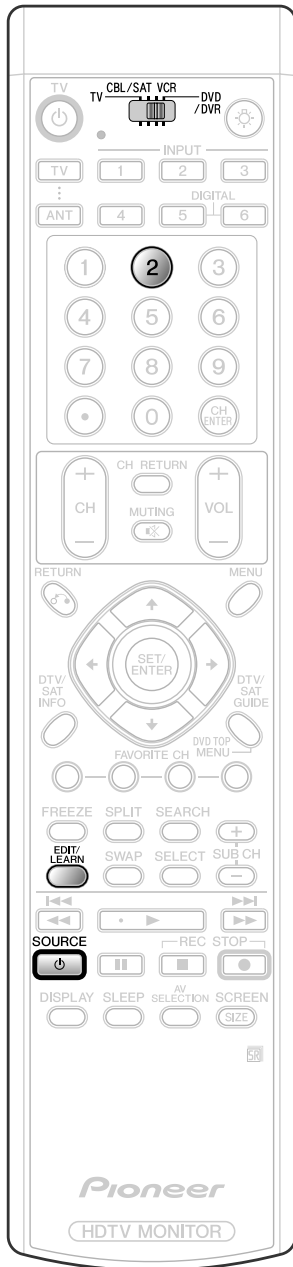

- 1 At the same time, press the LEARN button and number button 2.**

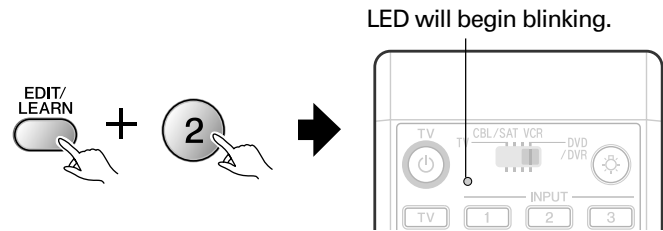

- 2 Press the SOURCE POWER button to memorize the desired operation.**

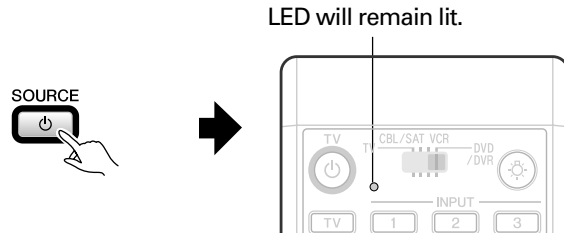

- Buttons which can be learnt are as follows.
 - CBL** SOURCE POWER, CH (+), CH (-), CH RETURN, CH ENTER, 1 to 9, 0
 - SAT** SOURCE POWER, CH (+), CH (-), ◀, ▶, ↑, ↓, SET/ENTER, MENU, DTV/SAT GUIDE, DTV/SAT INFO, CH ENTER, 1 to 9, 0, DVD TOP MENU
 - DTV** SOURCE POWER, BLUE, RED, GREEN, YELLOW, ◀, ▶, ↑, ↓, SET/ENTER, DVD TOP MENU, CH (+), CH (-), 1 to 9, 0, CH ENTER, •(DOT), CH RETURN, DTV/SAT INFO, DTV/SAT GUIDE
 - VCR** SOURCE POWER, CH (+), CH (-), II, ◀◀, ■, ▶▶, ●
 - DVD** SOURCE POWER, RETURN, ▶▶▶, ◀◀◀, II, ◀◀, ■, ▶▶, ◀, ▶, ↑, ↓, SET/ENTER, MENU, DVD TOP MENU
 - DVR** SOURCE POWER, ▶▶▶, I, ◀◀◀, II, ◀◀, ■, ▶▶, CH (+), CH (-), ●, REC STOP
- CBL/SAT/DTV and DVD/DVR cannot be selected at the same time.

3 Face the remote control unit of the other manufacturer's and the remote control unit of the Monitor to each other, and press the POWER button of the remote control unit of the other manufacturer's.

Leave about 0.8 to two inch (2 to 5 cm) between the two remote control units.
If you learn how to use the remote control unit you can adjust the distance of the remote control units.

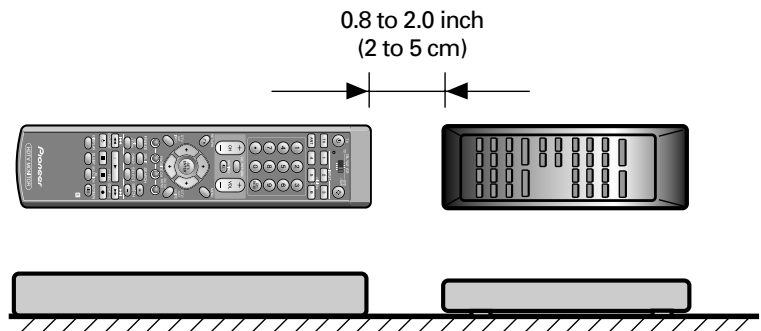

- (VCR) → LED will blink.
-
- If blinks once, return to step 2 for other buttons.
 - Flashes four times, it indicates an error has occurred.
- This ends learn. Repeat steps 2 and 3 for learning pertaining to other VCR devices.
 - If the remote control unit's LED blink four times, it means that learning capacity has reached its maximum and no more learning will be possible.

4 When the LEARN button is pressed, the remote control unit return to normal states.



NOTES:

- To stop using the LEARN mode in the middle, press the LEARN button again.
- If mode switch is switched while in LEARN mode, LEARN mode will be canceled.
- After steps 1 and 2, if you do not press the button for one minute (no operation), the LEARN mode will be canceled.
- To reset the learn setting, have the LED blinking as in step 1 and then keep the remote control unit's TV POWER button pressed for at least 2 seconds.
- There are some remote controls which cannot learn.

USING THE TV REMOTE CONTROL UNIT TO CONTROL OTHER DEVICES

REMOTE CONTROL UNIT SETTING BUTTONS

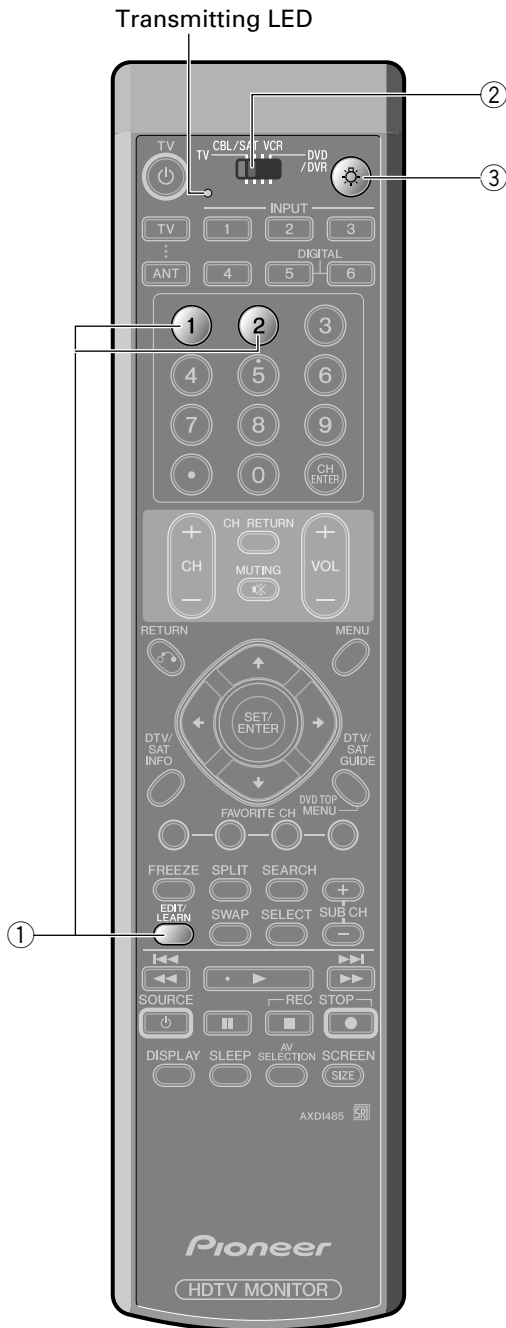

① EDIT/LEARN button

EDIT: When the EDIT/LEARN button is pressed at the same time as number button 1, the mode will change to preset code edit mode. (See page 81.)

LEARN: When the EDIT/LEARN button is pressed at the same time as number button 2, the unit's capability to learn and store command codes from other remote control units will be activated. (See page 84.)

② Mode switch

Use to switch the remote control unit modes.

③ Light button

When this button is pressed, all the buttons on the remote control unit will light. The lighting will turn off if no operations are performed within five seconds. This button is used for performing operations in dark places.

CABLE CONTROL BUTTONS

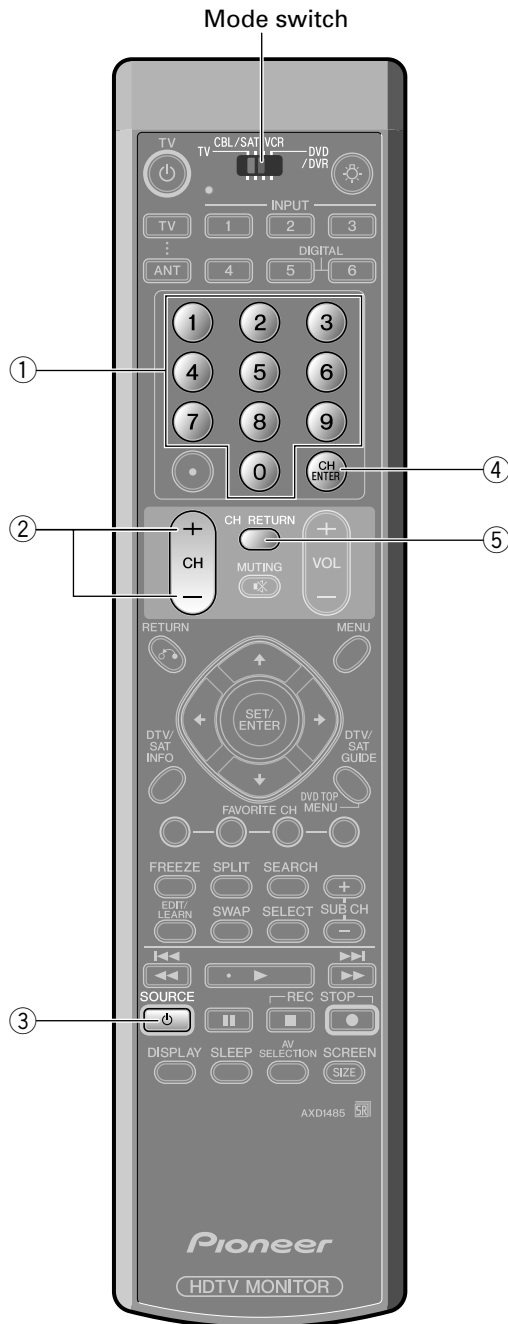

CABLE, SAT and DTV cannot be selected at the same time.

When the mode switch is set to CBL/SAT the cable converter connected to the Monitor can be operated using the buttons ① to ⑤.

Cable converters which are made by other makers and are not preset can also be operated using the remote control unit if buttons ① to ⑤ have learnt the functions (see page 84).

- ① **Direct channel selection buttons**
Press the button (or buttons) that corresponds to the channel that you wish to watch.
- ② **CH (channel) +, - buttons**
Press plus (+) or minus (-) to tune in a higher or lower channel.
- ③ **SOURCE POWER button**
Turns the power of the cable converter on and off.
- ④ **CH ENTER button ***
Fix the selected channel with the direct channel selection buttons.
- ⑤ **CH RETURN (channel return) button ***
Press to switch between the current channel and the channel you were watching immediately before.

* Some manufacturers do not preset CH ENTER and CH RETURN. Use these buttons to learn if necessary.

SAT CONTROL BUTTONS

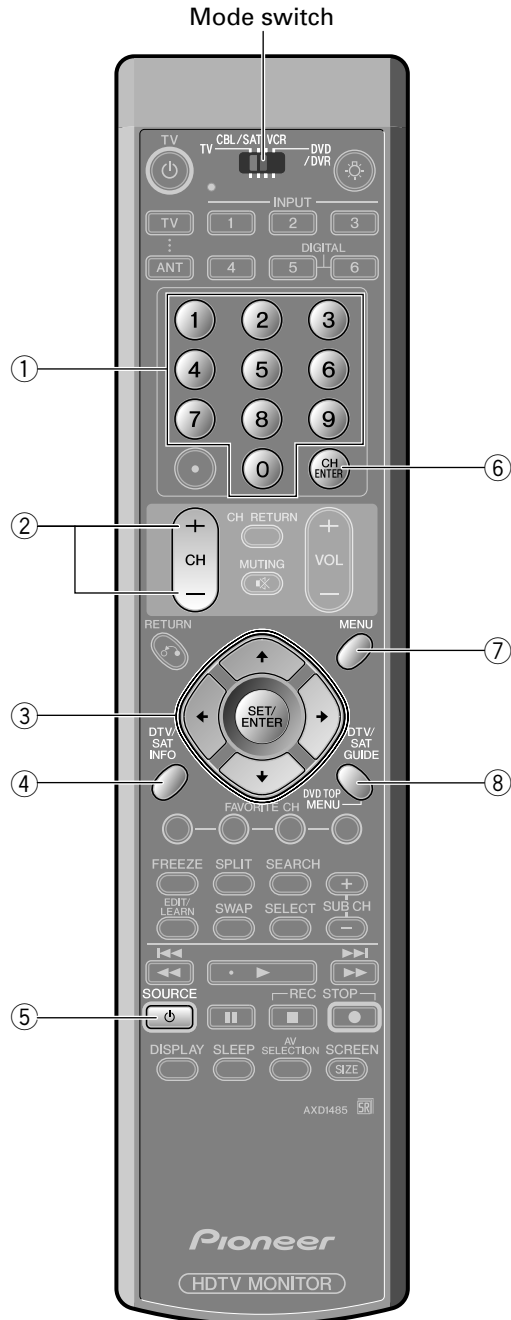

CABLE and SAT cannot be selected at the same time.

When SAT is preset by REMOTE CODE SET UP, the remote control unit buttons will function as shown below.

- When a satellite broadcast tuner is connected to the Monitor, press the input selector button that has the same number as the connected input terminal and set the mode switch to CBL/SAT.

The tuner can be operated using buttons ① to ⑧.

- Satellite broadcast tuners which are made by other makers and are not preset can also be operated with the remote control unit if buttons ① to ⑧ have learnt the functions (see page 84).

① **Direct channel selection buttons**

Press the button (or buttons) that corresponds to the channel that you wish to watch.

② **CH (channel) +, - buttons**

Press plus (+) or minus (-) to tune in a higher or lower channel.

③ **Select/Set buttons (SET/ENTER, ←, →, ↑, ↓)**

←, →, ↑, ↓: Press the button to select items on the SAT GUIDE screen or MENU screen.
 SET/ENTER: Press to activate the selected function.

④ **SAT INFO button**

When this button is pressed, information on satellite broadcasting will be displayed.

- Use this button to learn if necessary.

⑤ **SOURCE POWER button**

Turns the power of the SAT (digital satellite system tuner) on and off.

⑥ **CH ENTER button**

Fix the selected channel with the direct channel selection buttons.

- Use this button to learn if necessary.

⑦ **MENU button**

When this button is pressed, the satellite broadcasting menu screen will be displayed.

⑧ **SAT GUIDE button**

When this button is pressed, the satellite broadcasting guide screen will be displayed.

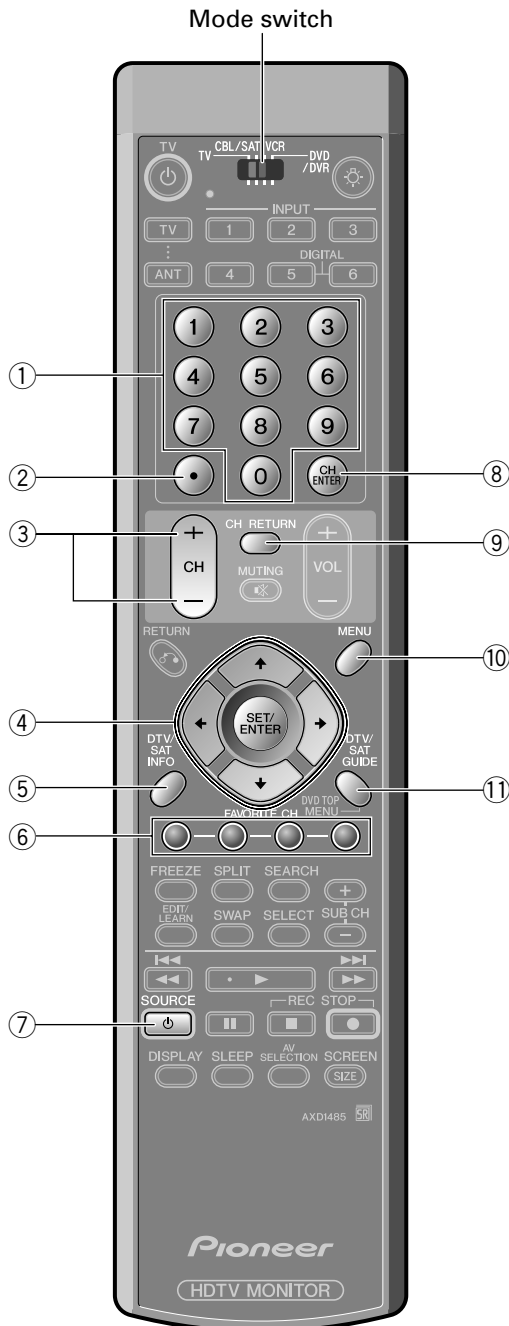

DTV CONTROL BUTTONS

CABLE, SAT and DTV cannot be selected at the same time.

When a digital tuner is connected to the monitor, set the mode switch to CBL/SAT. The tuner can be operated with the remote control unit if buttons ① to ⑪ have learnt the functions (see page 84).

- ① **Direct channel selection buttons**
Press the button (or buttons) that corresponds to the channel that you wish to watch.
- ② **● button**
Used in channel selection.
- ③ **CH (channel) +, - button**
Press plus (+) or minus (-) to tune in a higher or lower channel.
- ④ **Select/Set buttons (SET/ENTER, ←, →, ↑, ↓)**
←, →, ↑, ↓: Press the button to select items on the DTV MENU screen.
SET/ENTER: Press to activate the selected function.
- ⑤ **DTV INFO button**
When this button is pressed, information on DTV will be displayed.
- ⑥ **FAVORITE CH/Colored (blue, red, green and yellow) buttons**
FAVORITE CH: Used for making FAVORITE CH settings with the digital tuner.
Blue, Red, Green, Yellow:
Used to make selections from the digital tuner menu.
- ⑦ **⏻ SOURCE POWER button**
Turns the power of the DTV (digital tuner) on and off.
- ⑧ **CH ENTER button**
Fix the selected channel with the direct channel selection buttons.
- ⑨ **CH RETURN (channel return) button**
Press to switch between the current channel and the channel you were watching immediately before.
- ⑩ **MENU button**
When this button is pressed, the menu screen will be displayed.
- ⑪ **DTV GUIDE button**
When this button is pressed, the DTV guide screen will be displayed.

VCR CONTROL BUTTONS

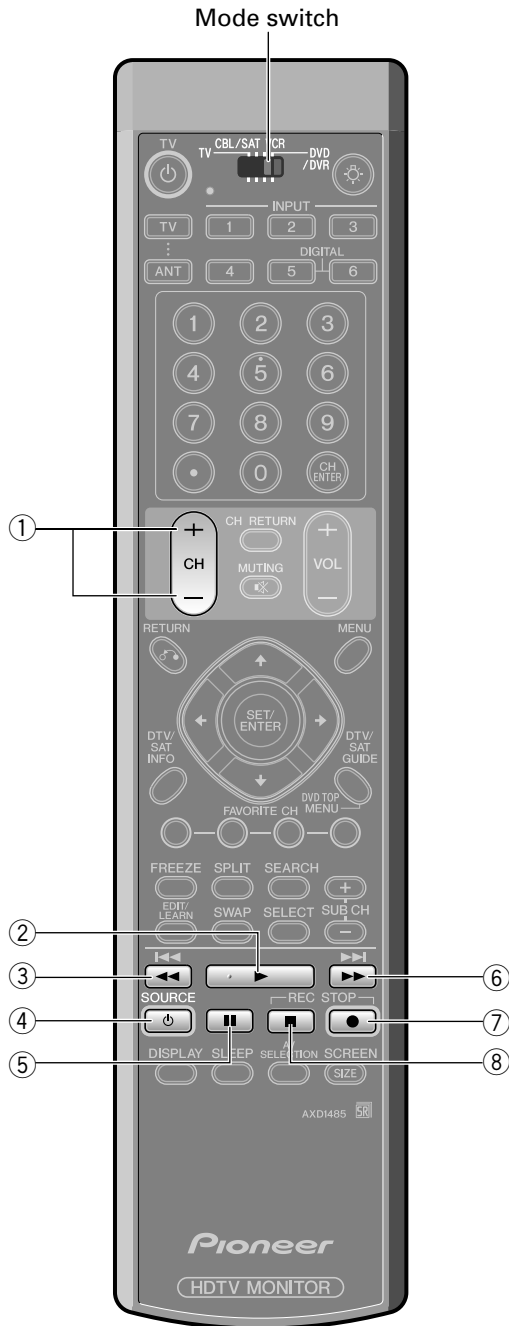

If the VCR is preset by REMOTE CODE SET UP, the remote control unit button will function as follows when the mode switch of the remote control unit is set to VCR. When the input selector button having the same number as the input terminal connecting the VCR is pressed, the VCR can be operated using buttons ① to ⑧. VCR which are made by other makers and are not preset can also be operated using the remote control unit if buttons ① to ⑧ have learnt the functions (see page 84).

- ① **CH (channel) +, - buttons**
Press to select the channel of the TV tuner on the VCR.
- ② **▶ (PLAY) button**
Selects playback.
- ③ **◀◀ (REW) button**
Rewinds the tape and allows picture search.
- ④ **⏻ SOURCE POWER button**
Turns the power of the VCR on and off.
- ⑤ **⏸ (PAUSE/STILL) button**
Set pauses and still pictures.
- ⑥ **▶▶ (FF) button**
Rapidly advances the tape and allows picture search.
- ⑦ **● (REC) button**
Starts recording.
- ⑧ **■ (STOP) button**
Stop the tape transport.

DVD/DVR CONTROL BUTTONS

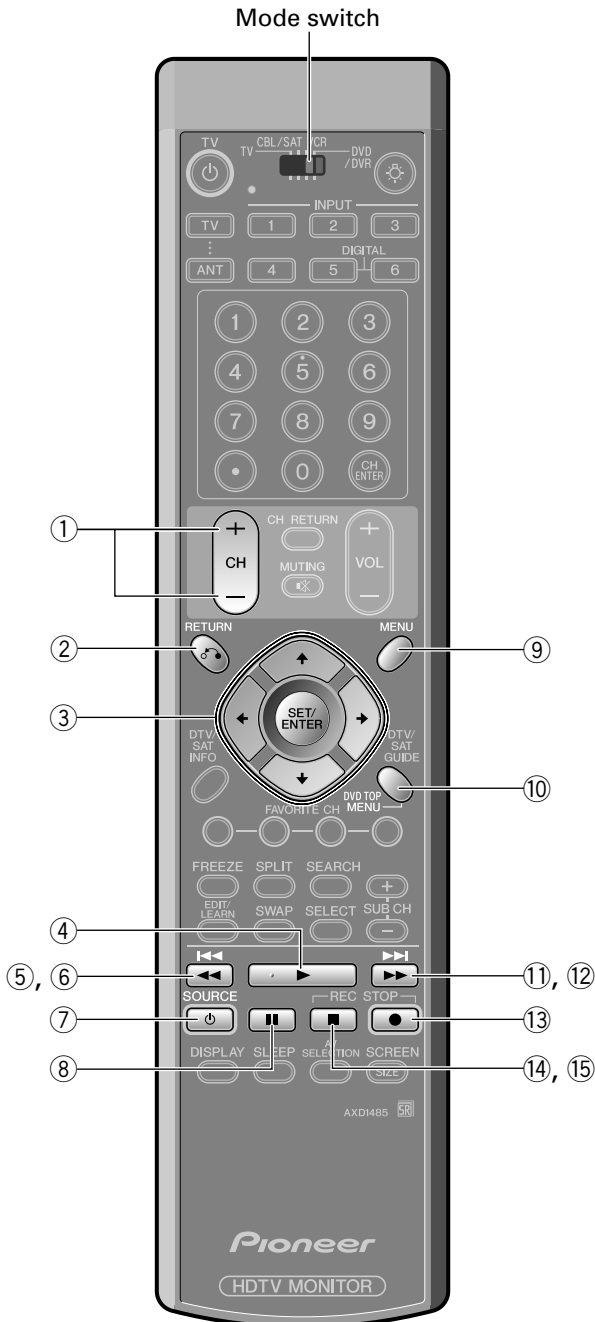

DVD and DVR cannot be selected at the same time.

If the DVD/DVR is preset by REMOTE CODE SET UP, the remote control unit button will function as follows when the mode switch of the remote control unit is set to DVD/DVR.

When the input selector button having the same number as the input terminal connecting a DVD player or DVD recorder is pressed, these players can be operated using buttons ① to ⑮ (buttons ③, ⑨, ⑩ are for DVD players only).

DVD player/DVD recorder which are made by other makers and are not preset can also be operated using the remote control unit if buttons ① to ⑮ have learnt the functions (see page 84).

- ① **CH (channel) +, - button (DVR only)**
Press plus (+) or minus (-) to tune in a higher or lower channel.
- ② **RETURN button**
Returns to the previous menu screen.
- ③ **Select/Set buttons (SET/ENTER, ←, →, ↑, ↓) (DVD only)**
←, →, ↑, ↓: Press the button to select items on the DVD MENU screen.
SET/ENTER: Press to activate the selected function.
- ④ **▶ (PLAY) button**
Selects playback.
- ⑤ **◀◀ (SCAN) button**
Continue pressing to rewind.
- ⑥ **◀◀ (CHAPTER SEARCH) button**
Pressing quickly once takes you to the start of the chapter currently playing. Each time you press it, you move back to the start of the previous chapter.
- ⑦ **⏻ SOURCE POWER button**
Turns the power of the DVD/DVR player on and off.
- ⑧ **⏸ (PAUSE/STILL) button**
Set pauses and still pictures.
- ⑨ **MENU button (DVD only)**
When this button is pressed, the DVD menu will be displayed.
- ⑩ **DVD TOP MENU button (DVD only)**
When this button is pressed, the DVD top menu will be displayed.
- ⑪ **▶▶ (SCAN) button**
Continue pressing for fast forward.
- ⑫ **▶▶ (CHAPTER SEARCH) button**
Pressing quickly once takes you to the start of the next chapter. Each time you press it, you move ahead to the start of the next chapter.
- ⑬ **● (REC) button**
Starts recording.
- ⑭ **■ (STOP) button**
Playback is stopped when pressing once.
With some DVD/DVR players, pressing the button twice may open the disc tray.
- ⑮ **■ button**
Press and hold ●, and then press this button to stop recording. This operation is true of only pioneer DVD recorders.

MENU INDEX

Main menu (See page 26)

PICTURE adjustment menu (See page 52)

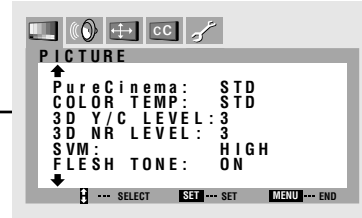
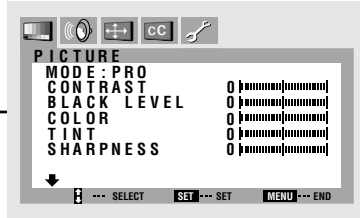

SOUND adjustment menu (See page 64)

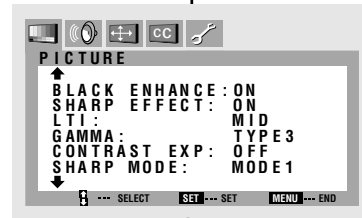
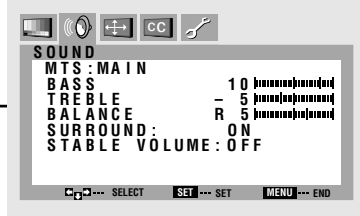

SCREEN adjustment menu (See page 42)

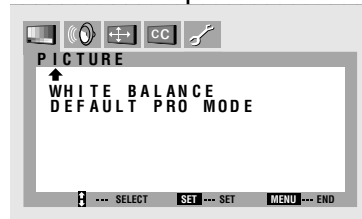
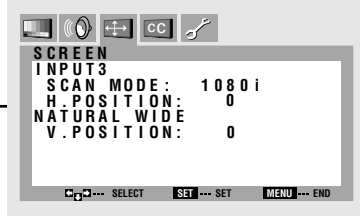

Closed Caption menu (See page 46)

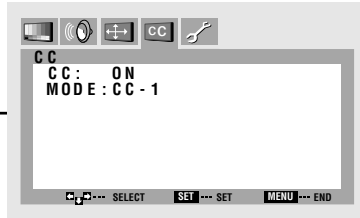

SET UP menu (See page 26)

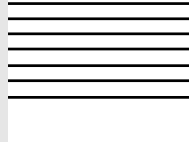
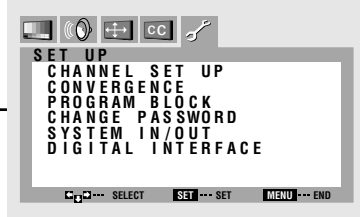

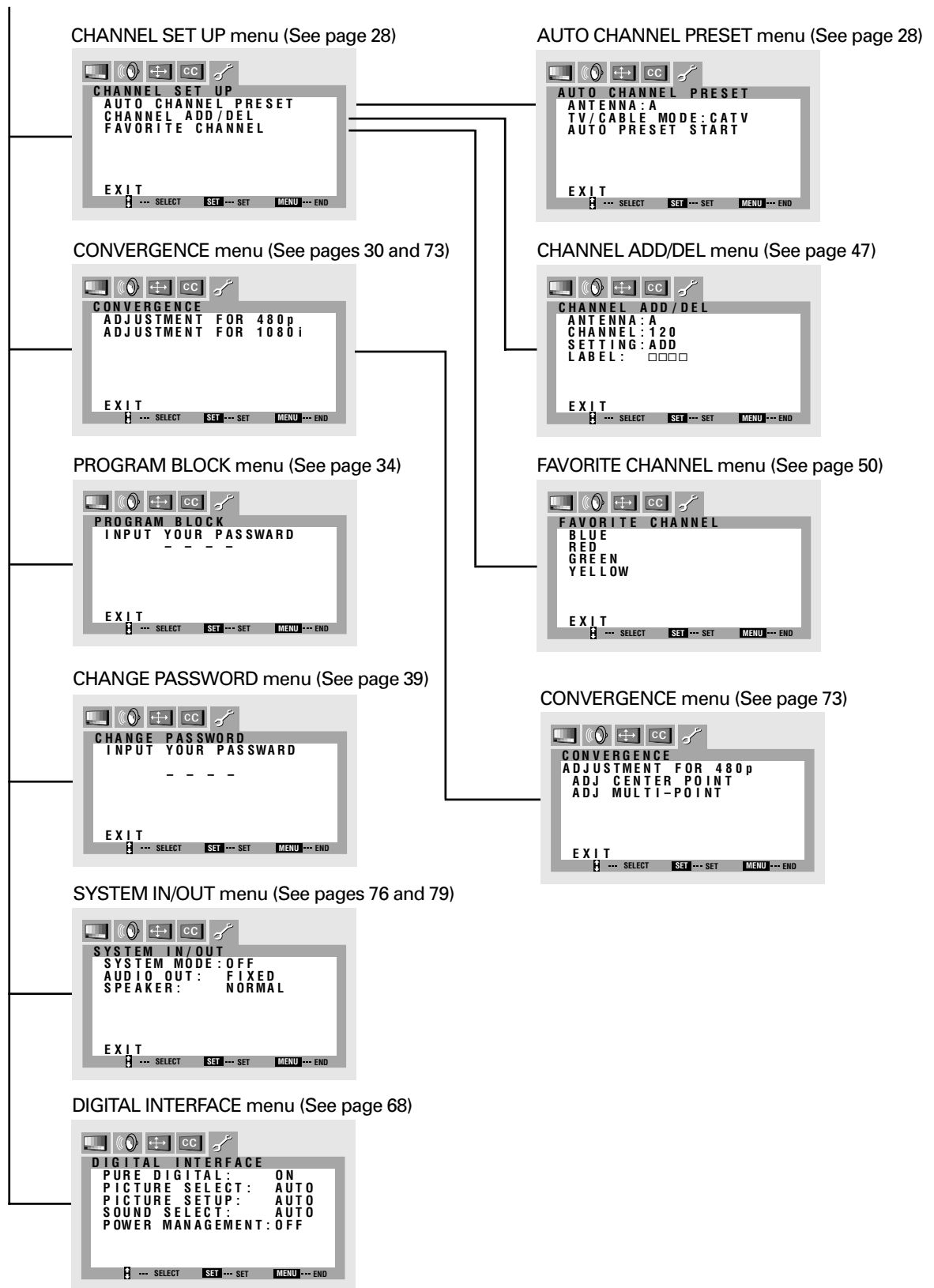

TROUBLESHOOTING

Incorrect operations are often mistaken for trouble and malfunctions. If you think that there is something wrong with the Monitor, check the points below. Sometimes the trouble may lie in another component. Investigate the other component and electrical appliances being used.

If the trouble cannot be rectified even after exercising the checks listed below, ask your nearest PIONEER authorized service center or your dealer to carry out repair work.

SYMPTOM	CAUSE/REMEDY	PAGES
The power will not turn on	The power plug is disconnected. The MAIN POWER button is not turned on.	12 12
The Monitor is inoperative	Press the RESET button. External influences such as lightning and static electricity may prevent the Monitor from operating normally. In such cases, turn on/off the MAIN POWER supply, disconnect the power cord, connect it again a few minutes later, and try operating the Monitor.	21
A TV broadcast station cannot be received	The antenna cable is not connected properly. The antenna cable is broken or shorted. Channels have not been preset correctly.	14 28
No picture appears on the screen	The DVD/DVR or VCR is not connected and operated properly. The input selector has not been set to the desired input source (such as DVD/DVR and VCR). When the POWER STANDBY indicator (green) is flashing at 2-second intervals, a digital input signal (INPUT 5, 6) is not input.	16 69
No sound	The MUTING is on (volume indicator is red).	25
The Monitor cannot be operated using the remote control unit	The batteries in the battery compartment are not correctly matching the (+ and -) polarities. The battery has worn out. Strong lights striking the remote control sensor may cause the internal microcomputer to malfunction.	13 13
The color is not normal The color is too dim or too sharp The color is uneven	Adjust the picture quality. The room is too bright. Adjust the color convergence.	54 30 and 73
Picture does not appear immediately after changing channels	TV-CATV MODE is set incorrectly.	28
Closed caption is not displayed	Check the CC menu settings. (As at October 1, 1999, limited closed caption information is broadcasted in field 1. The closed caption information that will be broadcasted in field 2 in the future may not be decoded with this unit). The character information is not displayed normally during special playback, such as slow and still play, of the VCR or Videodisc player. Closed caption signal may not be output depending on the VCR, Videodisc player or other components (for details, please consult the manufacturer of your unit). Check that the video cassette, Videodisc or broadcasting being played contains closed caption data (The video cassette and Videodisc containing closed caption data carries the  mark etc.).	

The following symptoms may be mistakenly regarded as malfunctioning.
In many cases, they are not the faults of the Monitor.

SYMPTOM	CAUSE
There are 2 or 3 layers of images (ghost images)	Influence of waves from the broadcast stations reflected by nearby mountains and high-rise buildings.
Spots appears on the screen Noises are audible	Influence of harmful waves produced by motor equipments such as hair dryers and vacuum cleaners, ignition devices such as cars and motorbikes, flashing devices such as thermostats and electricity discharge by transmission/distribution lines.
Stripes appears on the screen Noises are audible	Mixing of electric waves from TV stations FM stations, amateur wireless, public wireless (simple wireless), etc., or nearby personal computer, TV, VCR, audio equipment.
A loud a crack is heard after the power is turned on	Sometimes, creaking sounds will be produced when cabinets expand or contract due to changes in the surrounding temperature. Do not suspect a fault.
There is a pop and the power goes off.	The power was turned off momentarily due to the protection circuit to correct the electric discharge phenomenon in the CRT. Do not suspect fault.
The POWER STANDBY indicator (green) is flashing.	Please call your service representative if the green indicator repeatedly flashes 3 times then skips 1 flash.

SPECIFICATIONS

Display and amplifier section

Reception system	American TV standard NTSC system
Screen size	64" (PRO-730HDI) 53" (PRO-530HDI)
CRT	7" High focus CRT x 3
Brightness (White peak)	360 Foot-Lambert (PRO-730HDI) 450 Foot-Lambert (PRO-530HDI) [White window signal input contrast Max.] without protective screen
Horizontal resolution	More than 1400 lines (PRO-730HDI) More than 1150 lines (PRO-530HDI) [Input digital test pattern (1400 lines resolution)]
Input terminals	4 video inputs 4 S-VIDEO input jacks (Y/C separate INPUT) 2 COMPONENT VIDEO INPUT jacks (Y, Pb, Pr) 6 audio inputs CENTER INPUT jack Mini D-sub 15 pin INPUT jack (RGB) BNC VIDEO INPUT jack BNC COMPONENT VIDEO INPUT jack (Y, Pb, Pr) 2 HDMI INPUT jack (Digital)

NOTE:

INPUT 1 video and component video input can be input to both BNC and RCA type.

Output terminals

MONITOR/TV, AUDIO

Input terminal signal ratings

Input signal

Video signal:

Composite and S-VIDEO (Y): 1.0 Vp-p (75 ohms load)

COMPONENT (Y): 1.0 Vp-p (75 ohms load)

(Pb, Pr): 0.7 Vp-p (75 ohms load)

*Mini D-sub 15 pin (RGB): 0.7 Vp-p (75 ohms load)

*Digital signal: 3.3V T.M.D.S, 50 ohms

Audio signal (including CENTER): 400mV rms

Input impedance

Video input: 75 ohms

Audio input (including CENTER): 22 kilo-ohms

or more

Input signal polarity (Video)

Synchronized negative

Output terminal signal ratings

Output signal

Video signal: 1 Vp-p (75 ohms load)

Audio signal: 500 mV rms (100 % modulation)

Output impedance

Video output: 75 ohms

Audio output: Less than 1 kilo-ohms

Effective output

Front both channels driven

10 W + 10 W

Built-in speaker system

16 cm (6-5/16 in) full range x 2

* This jack cannot be used with a personal computer.

Tuner section

Circuit type	Video signal detection: PLL full synchronous detection PLL digital synthesizer system Audio multiplex: BTSC system
Reception channels	VHF; CH2~CH13, UHF; CH14~CH69 CATV (STANDARD, IRC or HRC) CATV 1-125 CH
Antenna terminals	Antenna terminal, 75 ohms UNBAL, F-type connector (VHF, UHF MIXED)

Electrical section, miscellaneous

Power requirements	120 V AC, 60 Hz
Power consumption	250 W, 450 VA (CSA)
Standby power consumption	0.5 W
External dimensions	
PRO-730HDI	1510 (W) x 1425 (H) x 709 (D) mm 59-7/16 (W) x 56-1/8 (H) x 27-15/16 (D) inch
PRO-530HDI	1268 (W) x 1289 (H) x 640 (D) mm 49-15/16 (W) x 50-3/4 (H) x 25-3/16 (D) inch

Weight of main unit

PRO-730HDI

155 kg (341 lb 11 oz)

PRO-530HDI

123 kg (271 lb 3 oz)

Wireless remote control unit

Operation system	Infrared remote control system
Power source	Two DURACELL® "AA" MN1500 1.5 V ALKALINE dry cell batteries
Dimensions	55 (W) x 26 (H) x 242 (D) mm 2-3/16 (W) x 1-1/32 (H) x 9-17/32 (D) inch
Weight	120 g (5 oz) (without batteries)

Accessories

Operating instructions	1
Warranty card	1
Remote control unit	1
DURACELL® "AA" MN1500 1.5V	
Alkaline dry cell batteries	2
Side frame cover	2
Frame cover	2
Panel Frame Attaching screw (spare)	2

NOTE:

Specifications and design are subject to possible modifications without notice due to improvements.

Should this product require service in the U.S.A. and you wish to locate the nearest Pioneer Authorized Independent Service Company, or if you wish to purchase replacement parts, operating instructions, service manuals, or accessories, please call the number shown below.

8 0 0 - 4 2 1 - 1 4 0 4

Please do not ship your product to Pioneer without first calling the Customer Support Division at the above listed number for assistance.

Pioneer Electronics (USA) Inc.
Customer Support Division
P.O. BOX 1760, Long Beach,
CA 90801-1760, U.S.A.

For warranty information please see the Limited Warranty sheet included with your product.

Should this product require service in Canada, please contact a Pioneer Canadian Authorized Dealer to locate the nearest Pioneer Authorized Service Company in Canada.
Alternatively, please contact the Customer Satisfaction Department at the following address:

Pioneer Electronics of Canada, Inc.
Customer Satisfaction Department
300 Allstate Parkway, Markham, Ontario L3R OP2
(905)479-4411
1(877)283-5901

For warranty information please see the Limited Warranty sheet included with your product.

Si ce produit doit être réparé au Canada, veuillez vous adresser à un distributeur autorisé Pioneer du Canada pour obtenir le nom du Centre de Service Autorisé Pioneer le plus près de chez-vous. Vous pouvez aussi contacter le Service à la clientèle de Pioneer:

Pioneer Electroniques du Canada, Inc.
Service à la clientèle
300, Allstate Parkway, Markham, Ontario L3R OP2
(905)479-4411
1(877)283-5901

Pour obtenir des renseignements sur la garantie, veuillez vous reporter au feuillet sur la garantie restreinte qui accompagne le produit.

S018D_enfr

Published by Pioneer Corporation.
Copyright © 2003 Pioneer Corporation.
All rights reserved.

PIONEER CORPORATION

4-1, Meguro 1-Chome, Meguro-ku, Tokyo 153-8654, Japan

PIONEER ELECTRONICS (USA) INC.

P.O. BOX 1540, Long Beach, California 90810-1540, U.S.A. TEL: (800) 421-1404

PIONEER ELECTRONICS OF CANADA, INC.

300 Allstate Parkway, Markham, Ontario L3R OP2, Canada TEL: (905) 479-4411

PIONEER EUROPE NV

Haven 1087, Keetberglaan 1, B-9120 Melsele, Belgium TEL: 03/570.05.11

PIONEER ELECTRONICS ASIACENTRE PTE. LTD.

253 Alexandra Road, #04-01, Singapore 159936 TEL: 656-472-1111

PIONEER ELECTRONICS AUSTRALIA PTY. LTD.

178-184 Boundary Road, Braeside, Victoria 3195, Australia, TEL: (03) 9586-6300

PIONEER ELECTRONICS DE MEXICO S.A. DE C.V.

Bldv.Manuel Avila Camacho 138 10 piso Col.Lomas de Chapultepec, Mexico,D.F. 11000 TEL: 55-9178-4270

K002E

Free Manuals Download Website

<http://myh66.com>

<http://usermanuals.us>

<http://www.somanuals.com>

<http://www.4manuals.cc>

<http://www.manual-lib.com>

<http://www.404manual.com>

<http://www.luxmanual.com>

<http://aubethermostatmanual.com>

Golf course search by state

<http://golfingnear.com>

Email search by domain

<http://emailbydomain.com>

Auto manuals search

<http://auto.somanuals.com>

TV manuals search

<http://tv.somanuals.com>