

# PIONEER

*Q150 OXYGEN CONCENTRATOR*

*OWNER'S MANUAL*



Merits Health Products Co., Ltd.

Read this manual before  
using concentrator and  
save for future reference.

# TABLE OF CONTENTS

<b>0. IEC SYMBOLS</b>	<b>3</b>
<b>1. CAUTIONS</b>	<b>3</b>
<b>2. WARNINGS</b>	<b>4</b>
<b>3. PRECAUTIONS</b>	<b>5</b>
<b>4. INTENDED USE</b>	<b>5</b>
<b>5. DESCRIPTION</b>	<b>6</b>
<b>6. SPECIFICATION</b>	<b>7</b>
<b>7. HANDLING</b>	<b>9</b>
7.1 Unpacking	9
<b>8. OPERATION</b>	<b>10</b>
8.1 Select a Location	10
8.2 Plug in Power Cord	10
8.3 Connect Humidifier (if prescribed by your physician)	10
8.4 Connect Oxygen Tubing	11
8.5 Turn On Power Switch	12
8.6 Adjust Flowrate	12
8.7 Oxygen Purity Indicator	12
8.8 Start Oxygen Therapy	12
<b>9. ALARMS</b>	<b>13</b>
<b>10. MAINTENANCE</b>	<b>13</b>
10.1 General caring	13
10.2 Cleaning the Cabinet Filter	14
10.3 Cabinet	14
10.4 Humidifier	15
<b>11. TROUBLESHOOTING</b>	<b>15</b>
<b>Warranty</b>	<b>16</b>

## 0. IEC SYMBOLS



**Caution, Attention or Consult accompanying documents.**



**Alternating Current**



**Type BF Equipment**



**No Smoking or Naked Flames**



**Use No Oil or Grease**



## 1. CAUTIONS

- Federal Law restricts this device for sale or use on the order of a physician.
- Do not adjust your prescribed level of oxygen flow without consulting your physician.



## 2. WARNINGS

- Fire Hazard-Oxygen promotes rapid burning. No Smoking or Open Flames.
- Electrical Shock Hazard - do not remove the cabinet or open the cover.
- Disconnect the power cord from the electrical outlet before cleaning or servicing.
- Do not place this equipment near hot, sparking or burning objects.
- Do not use oil or grease on or near this device.
- Do not use the concentrator in the presence of pollutants or dangerous fumes.
- An alternate source of oxygen should always be available to avoid any interruption in supply.
- This unit is not intended for life sustaining or life supporting applications.
- Turn the unit off when it is not in use.
- In the event of an alarm, contact your equipment provider.
- If you experience any signs of discomfort, contact your physician immediately.
- Merits recommends that each concentrator be on and running for a minimum of 60 minutes at a time.
- Keep the cord away from HEATED or HOT surfaces.
- NEVER drop or insert any object into any opening.
- NEVER block the air openings of the product or place it on a soft surface, such as a bed or couch, where the air opening may be blocked.
- Avoid the operation in wet or damp locations.

### 3. PRECAUTIONS

- Always plug in a 15 AMP, grounded circuit. DO NOT USE AN EXTENSION CORD
- Place the unit where sides and bottom are unobstructed to ensure proper airflow. (Be sure that the machine is placed away from drapes or other objects that might block the flow of incoming air and/or alarm indicators.)
- Only operate the concentrator in a upright position.
- Do not use oxygen tubing that exceeds 50 feet in length. The manufacturer recommends crush resistant tubing.
- Do not place liquids on the unit or use liquids to clean the unit. Do not use petroleum-based solvents. Clean unit and power cord with mild household cleaner applied with a damp cloth or sponge, then wipe dry.
- **The Salter Labs 7100 350c.c. Bubble Humidifier and the B&F Medical Bubble Humidifier are suitable for use with the Oxygen Concentrators. Or a humidifier capable of 30 Psi operation and 15 LPM of flow is required. Use of certain humidifiers not specified for use with this oxygen concentrator may impair the performance.**
- **Always choose the FDA or CE approved accessories, such as Masks or cannulas & Humidifiers to ensure the reliability and performance.**
- **Different personnel to prevent cross infection should never use the same mask or cannula.**

### 4. INTENDED USE

The Merit Oxygen Concentrator is intended to be used to supply supplemental oxygen to patients in their home. The devices are not intended for life support nor do they provide any patient monitoring capabilities.

## 5. DESCRIPTION

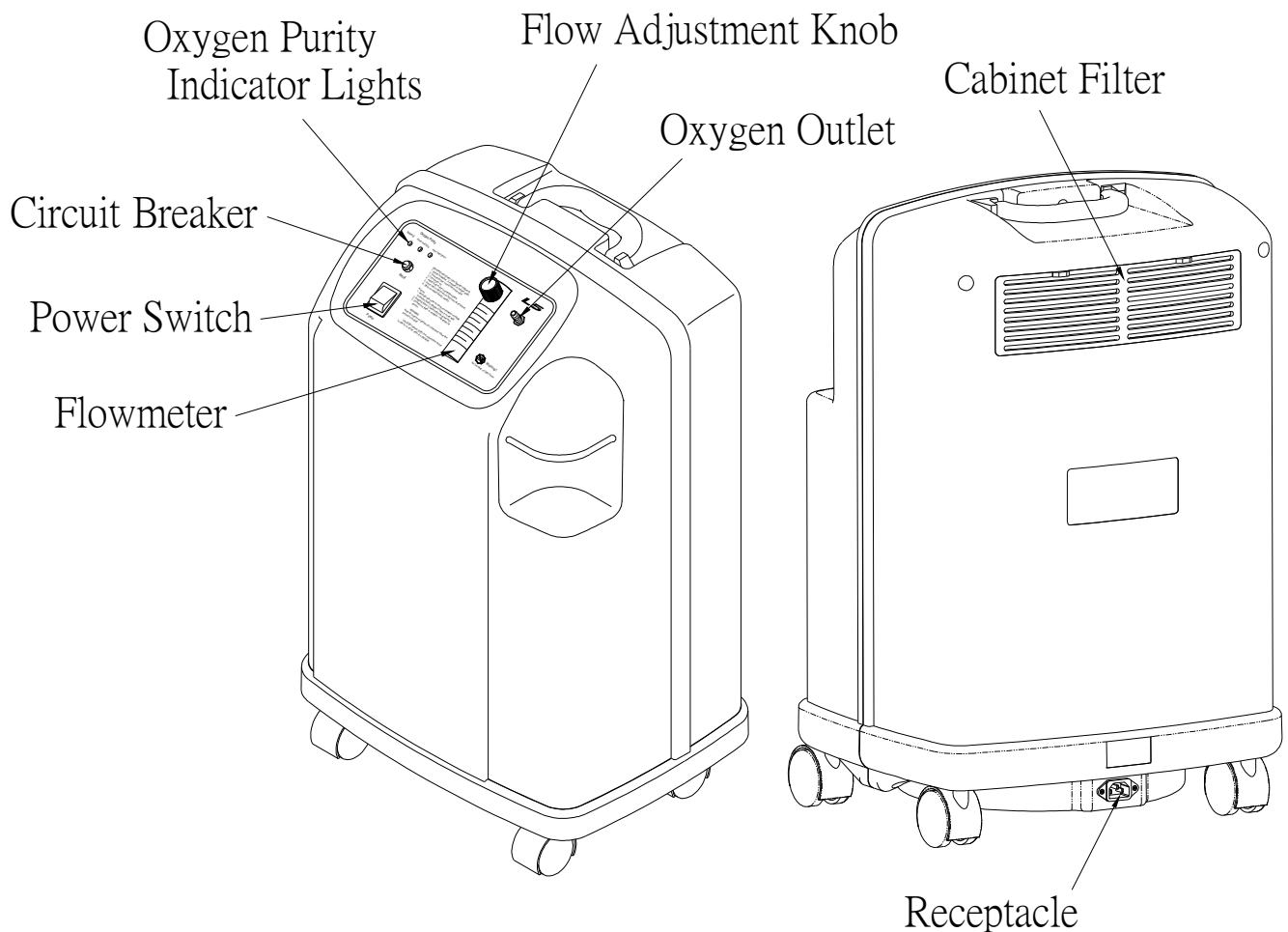

The Merit Oxygen Concentrator operates using standard AC Power from a wall outlet. The concentrator takes in and processes room air through a Molecular Sieve filter system resulting in high purity oxygen at flow up to five liters per minute. Unlike liquid or cylinder oxygen, the concentrator does not require refilling and operates at low pressure. The device only requires minimal cleaning and periodic dealer service checks to ensure optimum performance. The oxygen is delivered via an oxygen cannula or catheter and can be used in conjunction with a humidifier, depending on your physician's orders.

## 6. SPECIFICATIONS

<b>Electrical Requirements</b>	115VAC±10% , 60Hz / 230VAC±10% , 50Hz									
<b>Rated Current Input</b>	3.5A (115VAC/60Hz); 2.0A (230VAC/50Hz)									
<b>Sound Level</b>	45dB(A) Average									
<b>Operating Altitude</b>	Do not use at altitude over 4000 meters.									
<b>Oxygen Concentration</b>	$\geq 90\%$ at 1~5LPM <b>* Stated performance maximum achieved after 60 min. of run time.</b>									
<b>Maximum Oxygen Delivery Pressure:</b>	6±0.5psi. (40±4 kPa.)									
<b>Optional Oxygen Sensor</b>	<table border="1" style="margin-left: auto; margin-right: auto;"> <thead> <tr> <th>Oxygen Purity</th> <th>LED Indicator</th> </tr> </thead> <tbody> <tr> <td>Over 85% (<math>\pm 3\%</math>)</td> <td><b>GREEN</b> Indicator light</td> </tr> <tr> <td>70% (<math>\pm 3\%</math>) to 85% (<math>\pm 3\%</math>)</td> <td><b>YELLOW</b> Indicator light</td> </tr> <tr> <td>Below 70% (<math>\pm 3\%</math>)</td> <td><b>RED</b> Indicator light</td> </tr> </tbody> </table>		Oxygen Purity	LED Indicator	Over 85% ( $\pm 3\%$ )	<b>GREEN</b> Indicator light	70% ( $\pm 3\%$ ) to 85% ( $\pm 3\%$ )	<b>YELLOW</b> Indicator light	Below 70% ( $\pm 3\%$ )	<b>RED</b> Indicator light
Oxygen Purity	LED Indicator									
Over 85% ( $\pm 3\%$ )	<b>GREEN</b> Indicator light									
70% ( $\pm 3\%$ ) to 85% ( $\pm 3\%$ )	<b>YELLOW</b> Indicator light									
Below 70% ( $\pm 3\%$ )	<b>RED</b> Indicator light									
<b>Flow Range / Maximum Recommended Flow</b>	0-5 LPM / 5 LPM									
<b>Average Power Consumption</b>	320W									
<b>Pressure Relief Activation</b>	250kPa±10%									
<b>Filters:</b>	Cabinet, Bacteria and Compressor Inlet									
<b>Alarms – (Visual/Audible)</b>	High temperature w/ compressor – power shutdown High / Low pressure alarm Power loss alarm									
<b>Dimensions</b>	68cm(26.8”) High × 45cm(17.7”) Wide × 33cm(13”) Deep									
<b>Circuit Breaker &amp; Fuse</b>	(115VAC/60Hz) Circuit Breaker: 8A	(230VAC/50Hz) Circuit Breaker: 4A								
<b>Weight</b>	28.2Kg (62lb)									
<b>Shipping Weight</b>	31.8Kg (70lb)									
<b>Operating Ambient Temperature</b>	10°C ~ 39°C									



<b>Cabinet</b>	Impact Resistant flame-retardant plastic cabinet
<b>Regulatory Listing</b>	CSA 601 / UL 2601/ IEC/EN-60601-1
<b>Change in Max. Flow with 7 kpa Back Pressure</b>	0.3 LPM
<b>Recommended Storage and Shipping Temperature</b>	Dry (Up to 95% non-condensing), well ventilated area -20°C ~ 60°C

- (1). Conditions may vary based on altitude above sea level, barometric pressure and temperature. Specification subjects to change without notice.
- (2). This product complies with the following standards: C22.2 No 601.1-M90, UL Std. No 2601-1 and IEC/EN 60601-1-1.
- (3). For electromagnetic compatibility the standards are based as follow: CSA 601.1-2 and IEC/EN 60601-1-2.
- (4). Protection against electric shock is classified as **Type II**.
- (5). Degree of protection against electric shock is classified as **Type BF**.
- (6). Mode of operation belongs to continuous mode.
- (7). Equipment not suitable for use in the presence of a flammable anesthetic mixture with air or with oxygen or nitrous oxide
- (8). Degree of protection against ingress of water is rated as IPX0.

## 7. HANDLING

The concentrator should always be kept in the upright position to prevent cabinet damage while being transported. The shipping container has been designed to assure maximum protection of the concentrator.

If the concentrator is to be reshipped by common carrier, additional cartons are available from Merits.

### 7.1 UNPACKING

1. Check for any obvious damage to the carton or its contents. If damage is evident, notify the carrier, or your local dealer.
2. Remove all loose packing from the carton.
3. Carefully remove all the components from the carton.

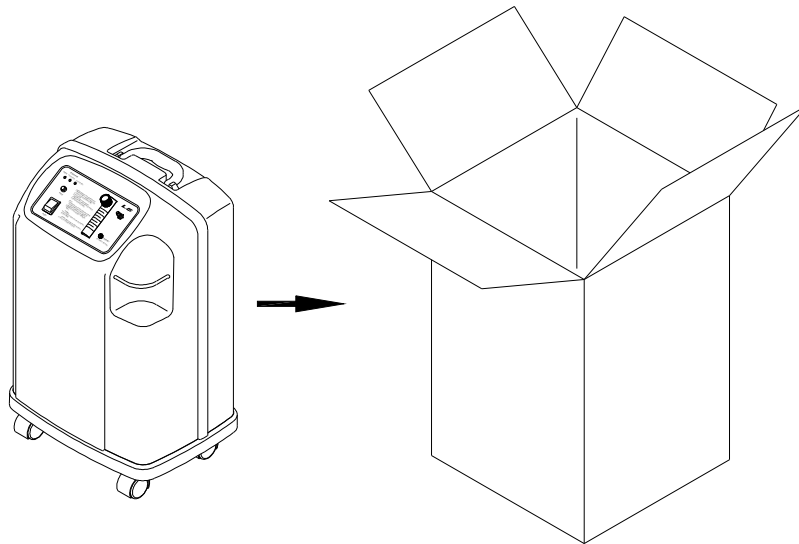

*NOTE: Unless the oxygen concentrator is to be used immediately, retain container and packing materials for storage until use of the concentrator is required.*

# 8. OPERATION

## 8.1 SELECT A LOCATION

Select a location where sides and bottom are unobstructed to ensure proper airflow. Be sure that the machine is placed away from drapes or other objects that might block the flow of incoming air and/or alarm indicators. The area should be free of pollutants or dangerous fumes. The unit should be placed on a stable level surface. The location should have access to a power outlet without use of an extension cord or where the cord is placed across a traffic area. Do not place near a source of heat or open flame or hot, sparking objects.

## 8.2 PLUG IN POWER CORD

Plug the power cord into a grounded, 15 AMP power outlet.

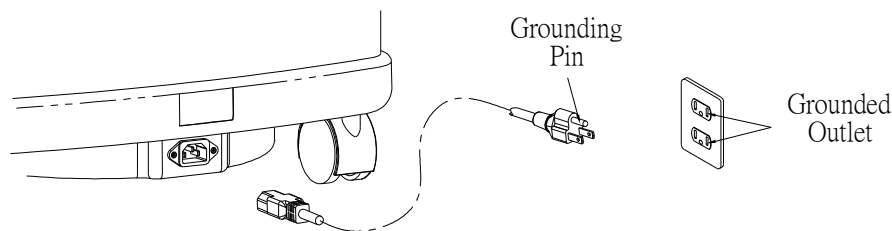

## 8.3 CONNECT HUMIDIFIER (if prescribed by your physician)

**The Salter Labs 7100 350c.c. Bubble Humidifier and the B&F Medical Bubble Humidifier are suitable for use with the Oxygen Concentrators. Or a humidifier capable of 30 Psi operation and 15 LPM of flow is required. Use of certain humidifiers not specified for use with this oxygen concentrator may impair the performance.**

Fill the humidifier with distilled water according to the manufacturer's instructions(FIG.1). Do not overfill. Replace the cap and securely tighten. Place the humidifier in the humidifier compartment(FIG.2) and attach to the oxygen outlet of the concentrator(FIG.3).



FIGURE 1 — FILLING THE HUMIDIFIER

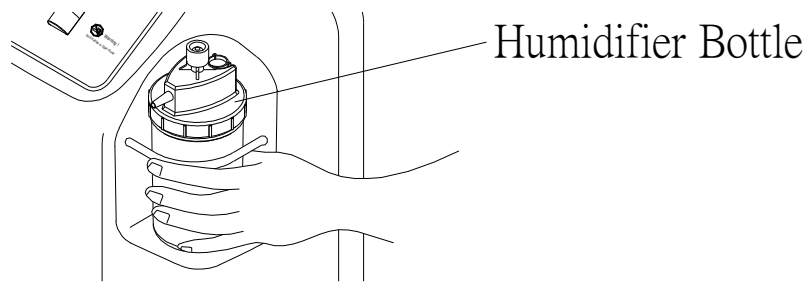

FIGURE 2 — HUMIDIFIER COMPARTMENT

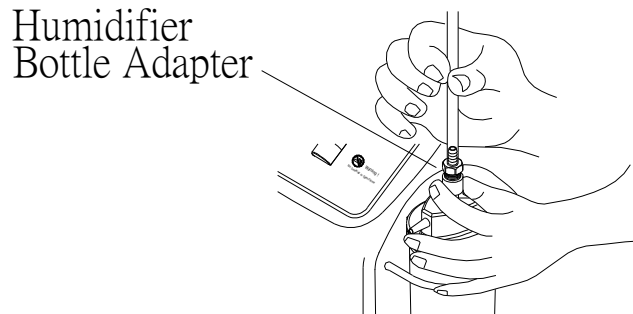

FIGURE 3 — ATTACHING THE HUMIDIFIER ADAPTER

## 8.4 CONNECT OXYGEN TUBING

Attach the oxygen tubing to the oxygen outlet of the concentrator (or the humidifier bottle if prescribed). Attach the prescribed oxygen mask, nasal cannula or oxygen catheter to the oxygen tubing(FIG.4).

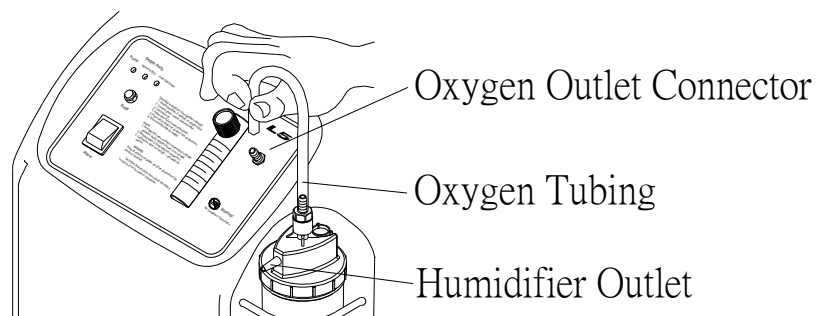

FIGURE 4 — ATTACHING THE OXYGEN TUBING

## 8.5 TURN ON POWER SWITCH

Press the power switch to the **I** position. The power indicator light will illuminate.

## 8.6 ADJUST FLOWRATE

Turn the knob on the flowmeter to adjust the flowrate to that prescribed by your physician. The ball inside the flowmeter must be centered on the flowline for the desired flowrate.

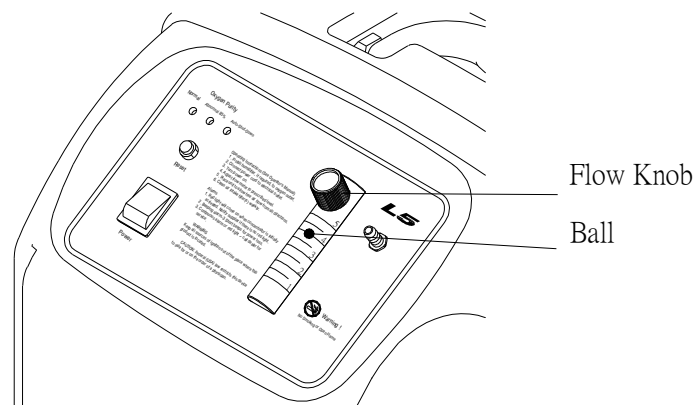

FIGURE 5 — ADJUSTING THE FLOWRATE

## 8.7 OXYGEN PURITY INDICATOR

This feature monitors the purity of oxygen generated by the oxygen concentrator. If purity falls below factory preset standards, indicator lights on the control panel will illuminate.

## 8.8 START OXYGEN THERAPY

You can use the output of the oxygen concentrator immediately. However, it may take up to 60 minutes to reach maximum oxygen concentration.

## 9. ALARMS

The concentrator is equipped with a visual and an audible indicator.

### POWER LOSS:

An audible alarm will sound and the power indicator light will turn off.

### PRESSURE ALARM:

Visual and audible alarms will occur when pressure is too low, indicating a possible problem with the concentrator or signaling that oxygen flow is beyond flow. Contact your service dealer when this occurs.

### THERMAL PROTECTION ALARM:

Visual and audible alarms will occur when temperature inside the concentrator is too high, indicating a possible problem with the concentrator or signaling that cabinet filters need to be clean. Contact your service dealer when this occurs.

## Concentrator With Optional Oxygen Concentration Sensor

This sensor provides the indication of oxygen purity as follows:

**RED LIGHT**—Oxygen concentration level falls below 70%(±3% ). Discontinue use and call for service - obtain alternative source of oxygen.

**YELLOW LIGHT**—Oxygen concentration level is between 70%(±3% ) ~ 85%(±3% ). You may continue to use the concentrator unless instructed otherwise by your supplier. Call for service immediately. Be certain that **BACKUP OXYGEN** is reachable.

**GREEN LIGHT**—Unit is operating - Oxygen at a concentration above 85%(±3% ).

## 10. MAINTENANCE

### 10.1 GENERAL CARING

1. Daily inspection of the cabinet filter should occur. Lightly vacuum or sweep off. Do not use any sharp or corrosive materials.
2. Always use, clean and/or replace the humidifier in accordance with manufacturer's or dealer's instructions.
3. The patient should never service or open this machine. It is to be serviced by qualified personnel only.

4. The oxygen concentration should be checked every 90 days for units without optional oxygen sensors. The oxygen concentration should be checked every 6 months for units with optional oxygen sensors.

## 10.2 CLEANING THE CABINET FILTERS

*NOTE: All concentrator models have one cabinet filter located at rear side of the cabinet. (FIG 6)*

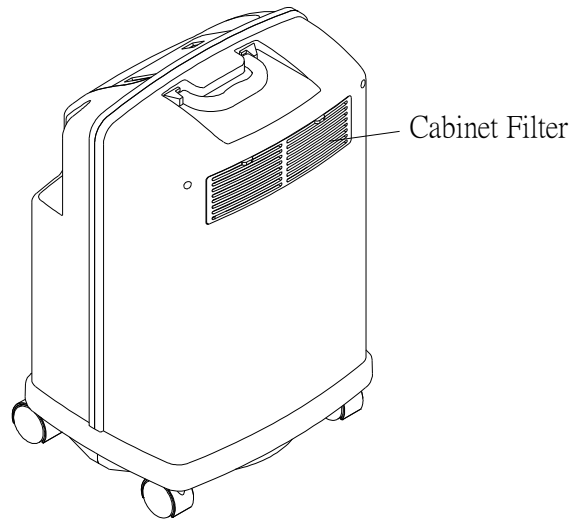

FIGURE 6 — CABINET FILTER LOCATION

1. Remove the cabinet filter and **CLEAN AT LEAST ONCE A WEEK** depending on environmental conditions. (FIG.7)
2. Clean the cabinet filter with a vacuum cleaner or wash in warm soapy water and rinse thoroughly. (FIG. 7)
3. Dry the filters thoroughly before reinstallation.

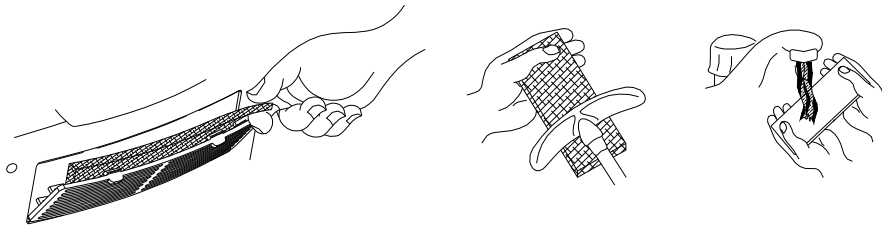

FIGURE 7 — REMOVE THE CABINET FILTERS

## 10.3 CABINET

Clean the cabinet with a mild household cleaner and non-abrasive cloth or sponge.

## 10.4 HUMIDIFIER

*NOTE: To clean the oxygen humidifier, follow the instructions provided by the manufacturer. If none are provided, follow these steps*

1. Clean the humidifier every day.
2. Wash it in soapy water and rinse it with a solution of 10 parts water and 1 part vinegar.
3. Rinse again with hot water and refill with distilled water to the level shown on the humidifier.

## 11. TROUBLESHOOTING

<b>SYMPTOM</b>	<b>PROBABLE CAUSE</b>	<b>SOLUTION</b>
Alarm: One (1) short beep, long pause  Concentrator NOT operating, while Power switch ON	<b>Main Power Loss:</b> 1. Power cord NOT plugged in. 2. No power at outlet. 3. Tripped circuit breaker. 4. Internal repairs required.	1. Insert plug into outlet 2. Inspect house circuit breakers or fuses. If problem recurs, use a different outlet. 3. Reset the circuit breaker. <b>4. Call dealer for service.</b>
Alarm: Two (2) short beeps, long pause  Concentrator NOT operating, while Power switch ON	<b>System Failure:</b> 1. Unit overheating due to blocked air intake. 2. Internal repairs required.	1. Remove and clean cabinet filter. 2. Move oxygen concentrator at least three-inches away from walls, draperies or furniture. <b>3. Call dealer for service.</b>
Alarm: Three (3) short beeps, long pause	<b>System Failure:</b> 1. Pneumatically the system is operating at over pressure. 2. Internal repairs required.	1. Shut down the system. <b>2. Call dealer for service.</b>
Alarm: Four (4) short beeps, long pause	<b>System Failure:</b> 1. Pneumatically the system is operating at under pressure. 2. Internal repairs required.	1. Remove and clean cabinet filter. 2. Move oxygen concentrator at least three-inches away from walls, draperies or furniture. <b>3. Call dealer for service.</b>
YELLOW or RED LIGHT illuminated.	1. Low oxygen purity. 2. Insufficient power at outlet. 3. Internal repairs required.	1. Clean or replace filters 2. Don't use extension cords. Move to another electrical outlet or circuit. <b>3. Call dealer for service.</b>



# Warranty

Merits Health Products Co., Ltd. warrants the **Pioneer** Oxygen Concentrator to be free from defective workmanship and materials for a period of 5 years from the date of purchase. Check with your dealer for more details. This warranty is limited to the original purchaser of the Oxygen Concentrator. Any defective part or assembly will be repaired or replaced, at the sole discretion and determination of Merits Health Products Co., Ltd., if the unit has been properly operated during the warranty period. Normal maintenance items and disposable components are not covered by this warranty. Shipping charges, if any, shall be paid by the purchaser.

Note: There is no other express warranty. Implied warranties, including those of merchantability and fitness for a particular purpose, are limited to the duration of the express limited warranty and to the extent permitted by law and all implied warranties are excluded. This warranty does not cover providing a loaner Oxygen Concentrator, compensating for costs incurred for Oxygen Concentrator rental, or labor costs incurred in repairing or replacing defective part(s).

**Authorized European Representative:**

Roma Medical Limited  
Unit 23 Vale Business Park,  
Cowbridge, Vale of Glamorgan CF71 7PF  
United Kingdom  
+44-1446-774519

**Manufactured by:**

Merits Health Products Co., Ltd.  
No.9, Road 36, Taichung Industrial Park,  
Taichung, Taiwan,  
R.O.C.  
(886)-4-23594985

**CE Marked For Model**

Q150 (Europe)

230V~, 50Hz

**CE** 0197

## Free Manuals Download Website

<http://myh66.com>

<http://usermanuals.us>

<http://www.somanuals.com>

<http://www.4manuals.cc>

<http://www.manual-lib.com>

<http://www.404manual.com>

<http://www.luxmanual.com>

<http://aubethermostatmanual.com>

Golf course search by state

<http://golfingnear.com>

Email search by domain

<http://emailbydomain.com>

Auto manuals search

<http://auto.somanuals.com>

TV manuals search

<http://tv.somanuals.com>