

Pioneer

Stereo CD Tuner

XC-F10
XC-NS1

Stereo Power Amplifier

M-F10
M-NS1

Speaker System

S-F10-LRW
S-NS1-LRW

Stereo Cassette Deck

CT-F10

Operating Instructions

Thank you for buying this Pioneer product.

In the UK, this system comprises the XC-F10 (Stereo CD Tuner); M-F10 (Stereo Power Amplifier); and S-F10-LRW (Speaker System). In all other countries the model names are XC-NS1, M-NS1 and S-NS1-LRW respectively.

The optional CT-F10 Stereo Cassette Deck is available in the UK only.

Please read through these operating instructions so you will know how to operate your model properly. After you have finished reading the instructions, put them away in a safe place for future reference.

In some countries or regions, the shape of the power plug and power outlet may sometimes differ from that shown in the explanatory drawings. However, the method of connecting and operating the unit is the same.

WARNING: TO PREVENT FIRE OR SHOCK HAZARD, DO NOT EXPOSE THIS APPLIANCE TO RAIN OR MOISTURE.

THE STANDBY/ON BUTTON IS SECONDARY CONNECTED AND THEREFORE DOES NOT SEPARATE THE UNIT FROM MAINS POWER IN STANDBY POSITION.

This product complies with the Low Voltage Directive (73/23/EEC), EMC Directives (89/336/EEC, 92/31/EEC) and CE Marking Directive (93/68/EEC).

IMPORTANT



The lightning flash with arrowhead symbol, within an equilateral triangle, is intended to alert the user to the presence of uninsulated "dangerous voltage" within the product's enclosure that may be of sufficient magnitude to constitute a risk of electric shock to persons.

CAUTION

**RISK OF ELECTRIC SHOCK
DO NOT OPEN**

CAUTION:
TO PREVENT THE RISK OF ELECTRIC SHOCK, DO NOT REMOVE COVER (OR BACK). NO USER-SERVICEABLE PARTS INSIDE. REFER SERVICING TO QUALIFIED SERVICE PERSONNEL.



The exclamation point within an equilateral triangle is intended to alert the user to the presence of important operating and maintenance (servicing) instructions in the literature accompanying the appliance.

IMPORTANT FOR USE IN THE UNITED KINGDOM

The wires in this mains lead are coloured in accordance with the following code:

Blue : Neutral
Brown : Live

If the plug provided is unsuitable for your socket outlets, the plug must be cut off and a suitable plug fitted.

The cutoff plug should be disposed of and must not be inserted into any 13

amp socket as this can result in electric shock. The plug or adaptor of the distribution panel should be provided with a 5 amp fuse. As the colours of the wires in the mains lead of this appliance may not correspond with coloured markings identifying the terminals in your plug, proceed as follows:

The wire which is coloured blue must be connected to the terminal which is marked with the letter N or coloured black.

The wire which is coloured brown must be connected to the terminal which is marked with the letter L or

coloured red.

Do not connect either wire to the earth terminal of a three-pin plug.

NOTE

After replacing or changing a fuse, the fuse cover in the plug must be replaced with a fuse cover which corresponds to the colour of the insert in the base of the plug or the word that is embossed on the base of the plug, and the appliance must not be used without a fuse cover. If lost, replacement fuse covers can be obtained from your dealer.

Only 5 A fuses approved by B.S.I. or A.S.T.A. to B.S. 1362 should be used.



CAUTION

**RISK OF ELECTRIC SHOCK
DO NOT OPEN**

ATTENTION

**DANGER D'ELECTROCUTION
NE PAS OUVRIR**

These labels can be found on the unit's bottom panel.

[For XC-F10/ XC-NS1]

CAUTION

This product contains a laser diode of higher class than 1. To ensure continued safety, do not remove any covers or attempt to gain access to the inside of the product.

Refer all servicing to qualified personnel.

The following caution label appears on your unit.

Location: Bottom of the unit.

**CLASS 1
LASER PRODUCT**

US and foreign patents licensed from Dolby Laboratories

These Operating Instructions describe the operating procedures of both the XC-F10 Stereo CD Tuner, M-F10 Stereo Power Amplifier (Non -UK models, XC-NS1 Stereo CD Tuner and the M-NS1 Stereo Power Amplifier) and the CT-F10 Stereo Cassette Deck. However, the CT-F10 is sold separately.

INFRINGEMENT OF COPYRIGHT

Recording and playback of copyrighted material may require consent. See the Copyright Design and Patent Act 1988.

Contents

1 Before You Start

Checking what's in the box	4
Using this manual	4
Putting the battery in the remote	4
Using the remote control	5
Hints on installation	5
Avoiding condensation problems	5
Discs compatible with this system	5

2 Connecting Up

Connecting the CD-tuner to the amplifier	6
Connecting the speakers	7
Connecting the satellite speakers	7
Connecting the subwoofer	8
Placing the speakers	8
Wall-mounting your system	9
Connecting the AM and FM antennas	9
AM loop antenna	9
FM wire antenna	10
Connecting external antennas	10
External AM antenna	10
External FM antenna	10
Connecting to other components	11
Connecting the power	11
Power cord caution	11
Ventillation	11

3 Controls and Displays

Remote control	12
Display	12
CD-tuner	13
Amplifier	13
Tape deck (UK model only)	13

4 Getting Started

Using menus	14
Switching on and setting the clock	14
Playing a CD	15
About the automatic door open sensor	16
Adjusting the sound	16
Listening to the radio	17
Improving poor FM reception	17

5 More CD features

Programming the track order	18
Checking the playlist order	18
Deleting the playlist	18
Using repeat play	19
Using random play	19
Changing the display	20
When a disc is stopped	20
When a disc is playing	20

6 More Tuner Features

Saving station presets	21
Listening to a station preset	21
Giving a station memory a name	22
Using RDS	23
Program types	23
Searching for a program type	24
Switching the displayed information	24
Changing the tuning frequency interval	25

7 Using the Tape Deck

Playing a tape	26
Setting the reverse mode	27
Reducing tape hiss with Dolby NR.	27
Making tape recordings	28
Recording CDs	28
Recording other sources	29
Setting up a future recording	30
Cancelling the record timer	30
Setting the record timer and the wake-up timer	31
Changing the display	31
Resetting the tape counter	31

8 Using the Timer

The timer menu	32
Setting the wake up timer	32
Cancelling the wake up timer	33
Setting the sleep timer	33

9 Additional Information

Care information	34
Handling discs	34
Storing discs	34
Discs you should avoid	34
Using cassette tapes	34
Tapes you should avoid	34
Erase protection	35
Cleaning external surfaces	35
Moving the unit	35
CD lens cleaner	35
Tape head cleaner	35
Demagnetizing the tape head	35
Magnetic shielding of speakers	35
Removing/replacing the satellite speaker grilles	35
Switching the door open sensor on/off	36
Switching the open/close beep on/off	36
Switching the auxiliary attenuator on/off	36
Setting the display brightness	36
Switching the time format	37
Troubleshooting	38
Specifications	39
Switching the demo on/off	Back cover

1 Before You Start

Checking what's in the box

Thank you for buying this Pioneer product. Before starting to set up your new system, please check that you have received the following supplied accessories:

- Lithium battery (CR2025) (for remote control)
- Remote control unit
- Stand A (mounting bracket)
- Stand B (table-top stand)
- Paper pattern (for wall-mounting units)
- System cable
- AC power cord
- FM wire antenna
- AM loop antenna
- Warranty card
- These operating instructions

With the speakers you should also have received the following:

- Subwoofer connecting cable
- Speaker cables (x2)
- Speaker stands (x2)
- Extra speaker grilles (UK model only) (x2)

Using this manual

This manual is for the XC-F10, M-F10, S-F10-LRW and CT-F10. Non-UK models for the XC-NS1, M-NS1 and S-NS1-LRW. It is split into three sections: setting up (chapters 1 and 2); using the system (chapters 3 to 8), and additional information (chapter 9). This last chapter contains care information for the unit and discs, a troubleshooting section and specifications.

Putting the battery in the remote

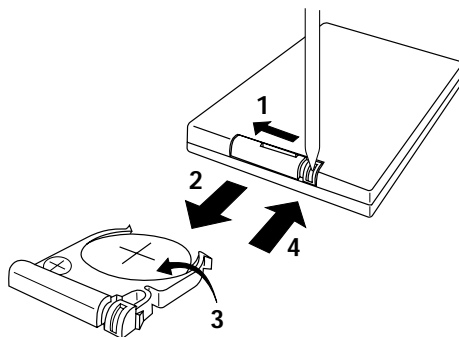

- 1 Turn over the remote control, then use a pen or pencil to release the battery cover catch.**
- 2 Slide out the battery holder.**
- 3 Put in the supplied battery.**
Take care to put it in the right way up (+ side up).
- 4 Push the battery holder back in, and your remote is ready for use.**

Caution!

Incorrect use of batteries can result in hazards such as leakage and bursting. Please observe the following:

- Make sure that the plus and minus sides of each battery match the indications in the battery compartment.
- Remove batteries from equipment that isn't going to be used for a month or more.
- Keep the lithium battery out of reach of children.
- If somebody swallows the lithium battery, immediately call your doctor.
- When disposing of used batteries, please comply with governmental regulations or environmental public institution's rules that apply in your country/area.
- Be careful never to insert the battery holder in a wrong orientation, for this will result in damage.

CAUTION

Danger of explosion if battery is incorrectly replaced. Replace only with the same or equivalent type recommended by the manufacturer. Discard used batteries according to the manufacturer's instructions.

Using the remote control

The diagram below shows the operating range of the remote control.

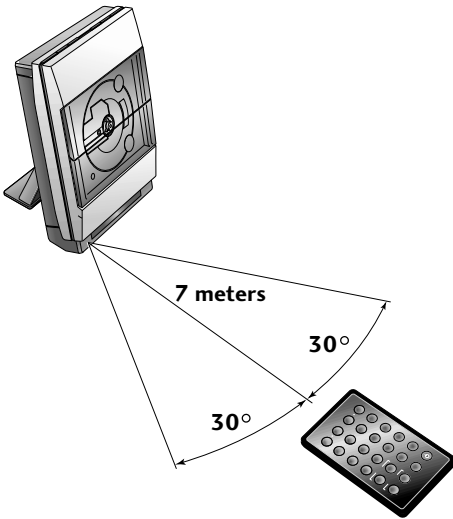

Keep in mind the following when using the remote control:

- Make sure that nothing is blocking the remote sensor on the unit.
- Remote operation may become unreliable if direct sunlight or fluorescent light is shining onto the remote sensor.
- Remotes for different devices can interfere with each other. Avoid using remotes for other equipment located nearby this unit.
- Replace the battery when you notice a fall off in the operating range of the remote.

Hints on installation

We want you to enjoy using this system for years to come, so please bear in mind the following points when choosing a suitable location for it:

Do...

- ✓ **Use in a well-ventilated room.**
- ✓ **Place on a solid, flat, level surface, such as a table, shelf or stereo rack.**

Don't...

- ✗ **Use in a place exposed to high temperatures or humidity, including near radiators and other heat-generating appliances.**
- ✗ **Place on a window sill or other place where the system will be exposed to direct sunlight.**
- ✗ **Use in an excessively dusty or damp environment.**
- ✗ **Use near a television or monitor as you may experience interference—especially if the television uses an indoor antenna.**
- ✗ **Use in a kitchen or other room where the system may be exposed to smoke or steam.**
- ✗ **Use on a thick rug or carpet, or cover with cloth—this may prevent proper cooling of the unit.**
- ✗ **Place on an unstable surface, or one that is not large enough to support the system fully.**

Avoiding condensation problems

Condensation may form inside the player if it is brought into a warm room from outside, or if the temperature of the room rises quickly. Although the condensation won't damage the system, it may temporarily impair its performance. For this reason you should leave it to adjust to the warmer temperature for about an hour before switching on and using.

Discs compatible with this system

Any disc that displays one of the following logos should play in this system. Other discs (such as CD-ROMs) will not play in this unit. Note that this unit cannot record onto recordable discs.



This system can play CD-R and CD-RW discs recorded with audio. However, depending on the condition of the player and the disc, you may find that not all discs will play successfully. (For example, if the disc is scratched or dirty, or if the player's pickup lens is dirty.)

Connecting the CD-tuner to the amplifier

Connect the CD-tuner to the amplifier as described below. If you also have the optional cassette deck, MD recorder or CD-Recorder, see their accompanying instructions before following the instructions on this page. This will make connecting up several components easier.

- **Important:** When connecting or disconnecting the system cable, make sure that the power is switched off and the unit unplugged from the wall outlet.

- 1 **Pass the system cable through Stand A, as shown, and connect the L-shaped end of the system cable to the socket on the underside of the CD-tuner.**

Line up the plug and socket before inserting. Make sure the plug clicks home.

- If you plan to wall-mount the CD-tuner, connect using the other end of the system cable.

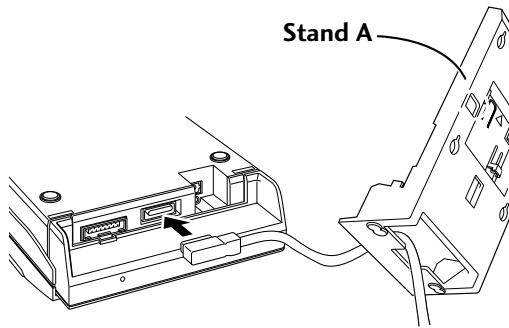

- 2 **Slot Stand A on to the rear side of the CD-tuner.**

Line up the three tabs on Stand A with the holes on the CD-tuner, then slot it into place.

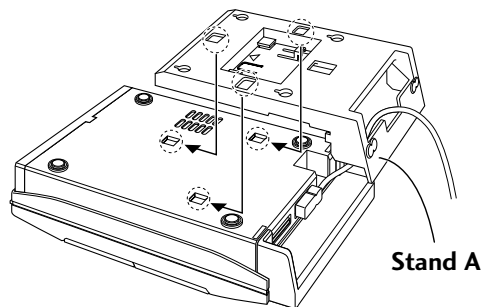

- If you have the optional cassette deck, MD recorder or CD-Recorder, connect these before attaching Stand A. (The ribbon cable can pass under the Stand A to keep it tidy.)

- 3 **Connect the other end of the system cable to the socket on the rear panel of the power amplifier.**

Line up the plug and socket before inserting. Make sure the plug clicks home.

- If you plan to wall-mount the CD-tuner, connect the L-shaped end of the system cable to the amplifier.

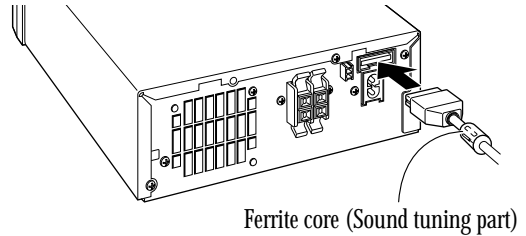

- 4 **If you plan to use the CD-tuner on a table-top or shelf, attach Stand B.**

Line up the tab on Stand B with the center hole on Stand A and slot it into place. Stand B will slide under the two tabs on the back of Stand A.

If you plan to wall-mount the unit, see *Wall-mounting your system* on page 9.

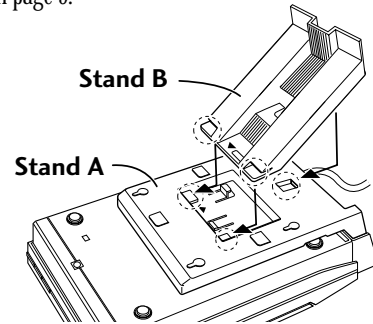

- To remove Stand B, push the center tab, as indicated, and slide off.

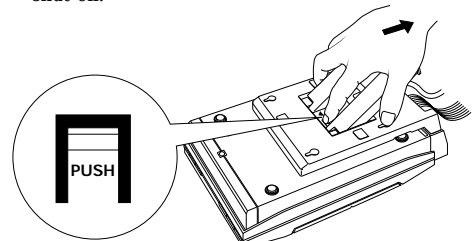

- To remove Stand A, pull the tab, as indicated, and slide off.

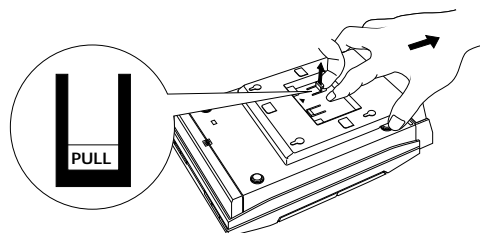

Connecting the speakers

The speaker system consists of stereo satellite speakers and a subwoofer for powerful bass sound. Connect the speakers to the amplifier unit as shown below.

- **Important:** When connecting or disconnecting speakers, make sure that the power is switched off and the unit unplugged from the wall outlet.

Connecting the satellite speakers

To get the best sound from the system, it's important that the red (+) and black (-) speaker terminals on the amplifier are connected to the corresponding terminals on each speaker. To help you match up the terminals correctly, the supplied speaker cable is color coded: connect the white half of the cable to the black (-) terminals, and the grey striped half to the red (+) terminals.

Important: Make sure that the bare speaker wires cannot touch each other, or come into contact with other metal parts once the unit is switched on.

- 1 **Insert a wire into each speaker terminal on the rear of the amplifier.**

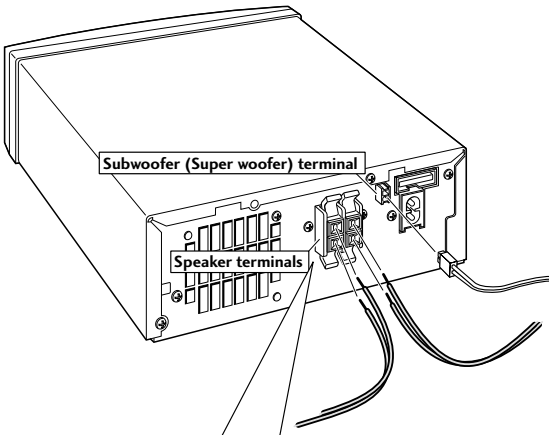

Speaker terminal connectors

Note: Make sure that the bare speaker wires cannot touch each other, or come into contact with other metal parts unit is switched on.



Twist of the plastic shielding then twist the exposed wire strands together.

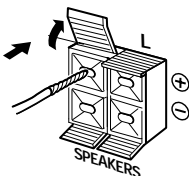

To open a terminal, press down on the tab. Insert the wire, then push the tab back to secure it.

- 2 **If you plan to use your speakers on a table-top or shelf, pass the free end of each speaker cable through the speaker stand.**

See the diagram under step 3, below.

- 3 **Insert the speaker wires into the terminals on the rear of each speaker.**

Connect the white half of the cable to the black (-) terminals, and the grey striped half to the red (+) terminals. To open a terminal, press down on the tab. Insert the wire, then release the tab to secure it.

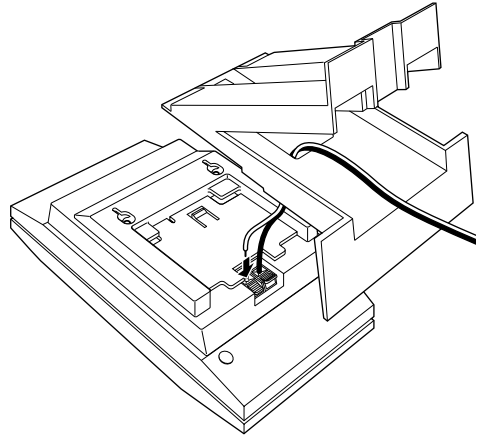

- 4 **If you are going to use the speakers on the stands, slot the stand into place.**

If you plan to wall-mount the speakers, see *Wall-mounting your system* on page 9.

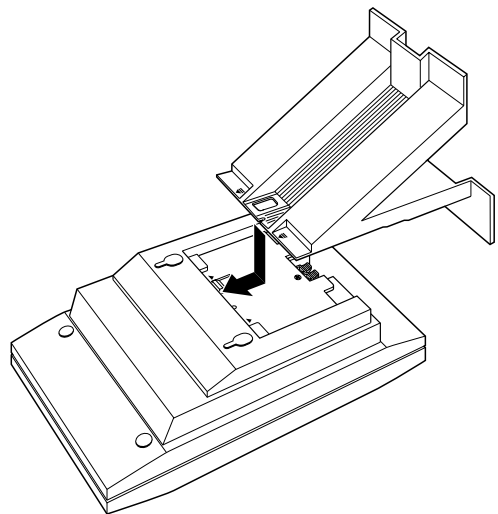

2 Connecting Up

- To remove the stand, press the center tab and slide the stand from the speaker.

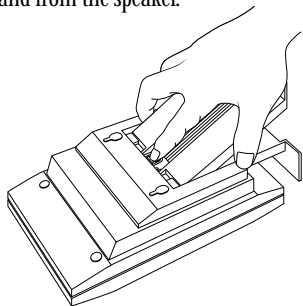

Connecting the subwoofer

Use the supplied subwoofer cable to connect the subwoofer to the amplifier.

- 1 **Twist off the plastic shielding then twist the exposed wire strands together.**



- 2 **Connect the bare wire ends of the cable to the subwoofer.**

The white wire connects to the black terminal; the gray wire to the red.

To open a terminal, press down on the tab. Insert the wire, then release the tab to secure it.

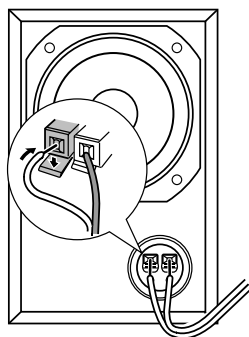

- 3 **Connect the other end to the amplifier.**

The cable will only plug in one way; line up the plug and socket before fully inserting.

Caution!

Do not connect any other amplifier to this system. In rare cases this may result in smoke or fire.

Do not block the port opening on the front of the subwoofer. Also, do not put your hand or other object into the port: you may damage the subwoofer.

If you wish to connect speakers other than the ones supplied, use only speakers with a nominal impedance of $8\ \Omega$. Refer to the instructions that came with your speakers if you are unsure of their impedance before connecting them and switching on.

Placing the speakers

Ideally, the satellite speakers should be at about ear-level when you're listening to them. Putting them on the floor, or mounting them very high on a wall is not recommended. For the best stereo effect, place the speakers 2–3 meters (6–9 feet) apart.

Placement of the subwoofer is not as critical as the satellite speakers because bass sounds are much less directional than middle and treble sounds. However, bear the following points in mind when choosing a suitable location.

- The subwoofer can be placed on top of the amplifier.
- As with other audio components, don't place the subwoofer near heaters, radiators or other appliances that generate heat.
- Although you have some freedom in placement, experiment with different subwoofer locations — some will sound better than others from your usual listening position.
- Don't use the amplifier/subwoofer on a thick rug or carpet as this can also cause ventilation problems.

Note: Avoid touching the actual speaker cone when installing or moving the subwoofer.

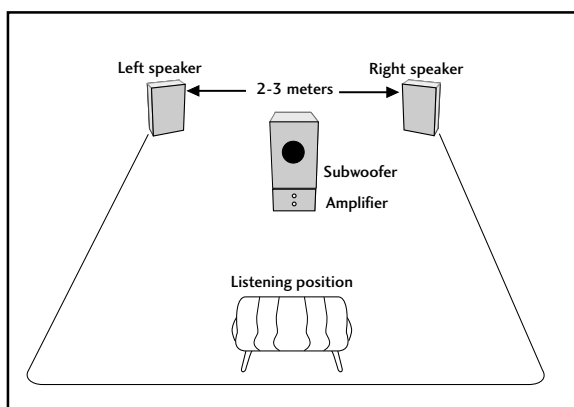

Wall-mounting your system

If you prefer, you can hang the satellite speakers and/or the CD-tuner (together with the optional tape deck, MD recorder and CD-Recorder) on a wall. (Screws and other fixings are not supplied.)

Make sure of the following when wall-mounting any equipment:

- The wall is strong enough to support the weight.
- The screws are suitable for the wall material (concrete, wood, etc.), and are long enough to support the weight.
- You'll still be able to easily operate the system using the remote control or the top panel controls.
- You fix all the required screws (2 for each speaker; 4 for the CD tuner and other components). Using fewer than this may make the system unstable, causing an accident.

After finding a suitable location, stick the supplied paper pattern on the wall. This makes putting the screws in the correct place very easy.

If you're wall-mounting the CD-tuner (or other optional components), attach only Stand A. If wall-mount the satellite speakers, do not attach the speaker stands.

The diagram below shows the dimensions for the screws you'll need.

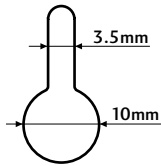

After fixing the screws, hang the speakers and/or other components on the wall.

Important

Pioneer bears no responsibility for accidents resulting from faulty assembly or installation, insufficient mounting strength of walls or other building fixtures, misuse or natural disasters.

Connecting the AM and FM antennas

Connecting the supplied antennas will allow you to listen to both AM and FM radio broadcasts. If you find that reception quality is poor, an outdoor antenna should give you better sound quality—see *Connecting external antennas* on the following page for more on how to do this.

- Before making or changing antenna connections, make sure that the power is switched off and the unit disconnected from the AC wall outlet.

Slide off the top cover to access the antenna terminals and the auxiliary inputs. (AUX IN)

Press down on the center of the topcover while sliding off.

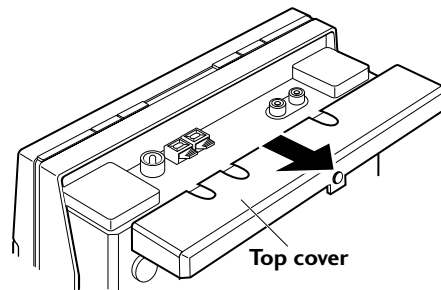

(Illustration shows UK model)

AM loop antenna

- 1 Assemble the antenna as shown.

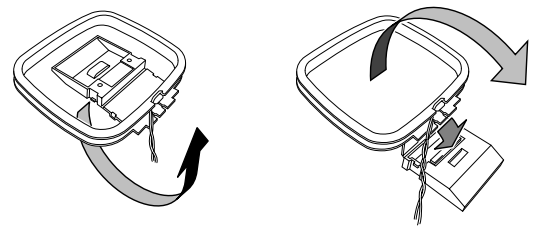

- 2 Twist the exposed wire stands together.



- 3 Press the tabs to open the terminals then insert a wire fully into each. Release the tab to secure the wire.

2 Connecting Up

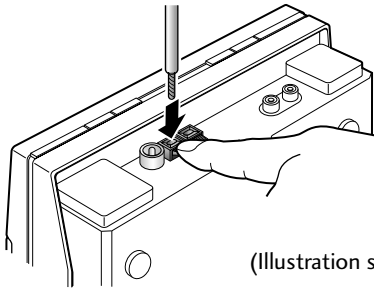

(Illustration shows UK model)

4 Point the AM antenna in the direction giving the best reception.

Avoid placing near computers, television sets or other electrical appliances, and do not let it come into contact with metal objects.

Note: The signal earth (⏏) is designed to reduce noise that occurs when an antenna is connected. It is not an electrical safety earth.

FM wire antenna

The kind of FM antenna supplied depends on the region in which you live.

1 Plug in the FM wire antenna (UK model only).

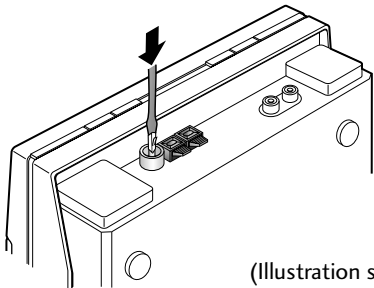

(Illustration shows UK model)

2 Connect the FM wire antenna in the same way as the AM antenna (non-UK models).

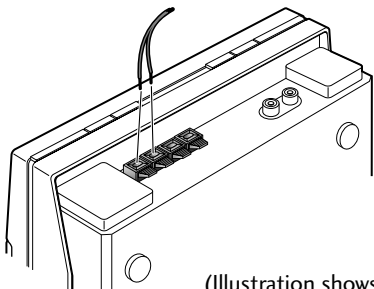

(Illustration shows non-UK model)

For best results, extend the FM antenna fully and fix to a wall or door frame. Don't drape loosely or leave it coiled up. The supplied FM antenna is a simple means of receiving FM stations; using a dedicated, outdoor FM antenna will usually give you better reception and sound quality. See below for connection details.

3 Slide on the top panel cover.

The top panel cover has slots to accommodate the antenna wires.

Connecting external antennas

If you find reception quality is poor with the supplied indoor antennas, try connecting outdoor antennas (not supplied).

External AM antenna

Use 5–6 meters of vinyl-insulated wire and set up either indoors or outdoors. Leave the AM loop antenna connected.

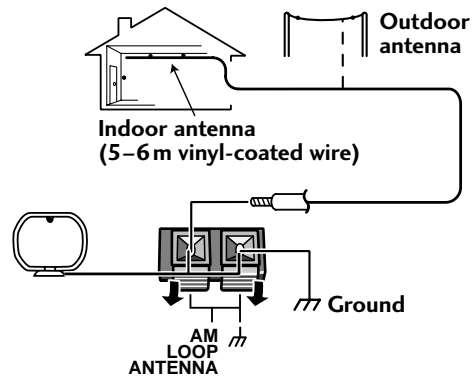

External FM antenna

Connect an outdoor FM antenna as shown below.

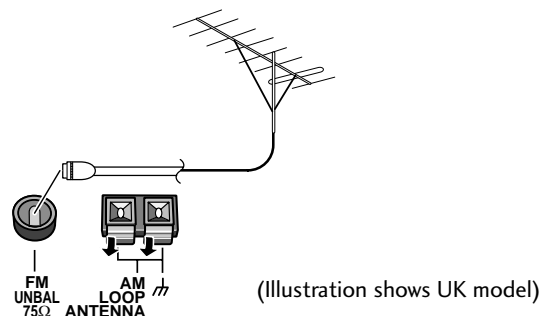

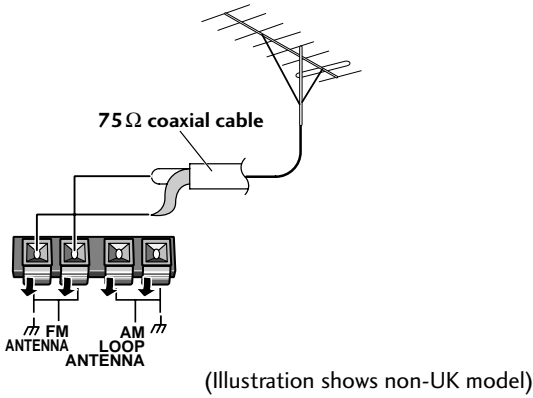

Connecting to other components

There are analog audio inputs for connecting up other components such as an MD or tape deck, or turntable (with suitable phono amplifier). Use a standard stereo audio cable (with RCA/phono plugs on either end) to connect the **AUX IN** (auxiliary inputs) on this unit to the audio out sockets on the other component. Be sure to match the color-coded plugs and sockets at both ends for best results.

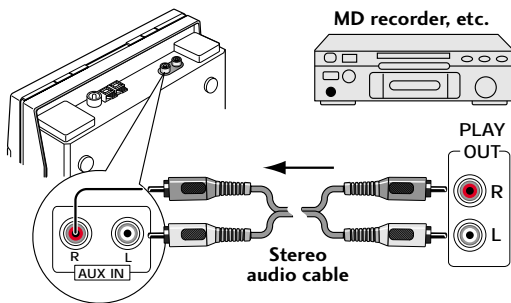

Connecting the power

After making sure that everything is properly connected, plug in to a power outlet.

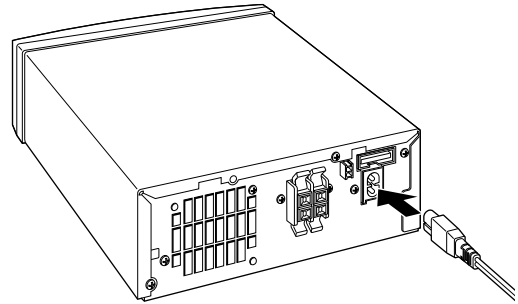

Power cord caution

Handle the power cord by the plug part. Do not pull out the plug by tugging the cord, and never touch the power cord when your hands are wet, as this could cause a short circuit or electric shock. Do not place the unit, a piece of furniture, or other object on the power cord or pinch the cord in any other way. Never make a knot in the cord or tie it with other cords. The power cords should be routed so that they are not likely to be stepped on. A damaged power cord can cause a fire or give you an electric shock. Check the power cord once in a while. If you find it damaged, ask your nearest Pioneer authorized service center or your dealer for a replacement.

Ventilation

For ventilation purposes, leave at least 15 cm (6 inches) of free space at the rear of the unit, 10 cm (3.5 inches) either side, and 20 cm (7 inches) above.

CD-tuner

- 1 **Top cover** – Remove to access the antenna terminals and auxiliary inputs
- 2 **STANDBY/ON** – Press to switch the system on or into standby
- 3 **VOL –** – Use to reduce the volume
- 4 **VOL +** – Use to increase the volume
- 5 **■** – Press to stop the currently playing CD
- 6 **▶/||** – Press to start CD playback, or pause a disc that's already playing (press again to restart)
- 7 **OPEN/CLOSE** – Press to open/close the disc compartment
- 8 **Disc compartment** – The disc compartment automatically opens when you move your hand near
- 9 **Standby indicator** – Lights when the system is in standby.

Amplifier

- 1 **Power indicator** – lights when the system is on
- 2 **Headphone jack** – plug in a pair of headphones for private listening (the sound from the speakers is muted when headphones are plugged in)

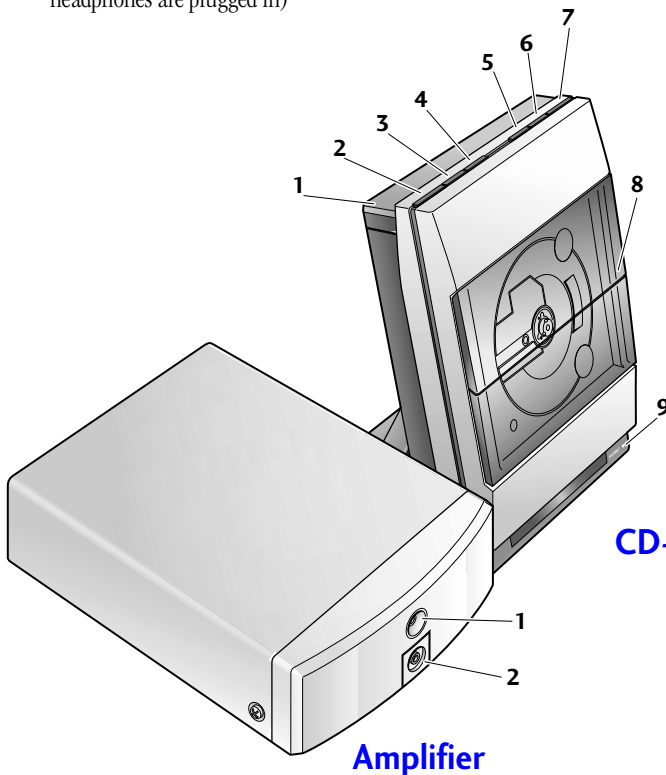

Tape deck (For UK model only)

- 1 **◀▶** – Press to play a tape or reverse a tape that's already playing.
- 2 **■** – Press to stop a tape.
- 3 **Cassette tape slot.**
- 4 **●||** – Press to put the unit into record-pause.
- 5 **▲** – Press to eject a tape.
- 6 **Play indicator** – Lights when a tape is playing.
- 7 **Endless play indicator** – Lights when the reverse mode is set to Endless (reverse mode is One Way if not lit).
- 8 **REC** – Lights when recording or in record-pause.
- 9 **DOLBY NR** – Lights when Dolby Noise Reduction is switched on.
 - *Dolby noise reduction manufactured under license from Dolby Laboratories.*
 - *"Dolby", and the double-D symbol are trademarks of Dolby Laboratories.*

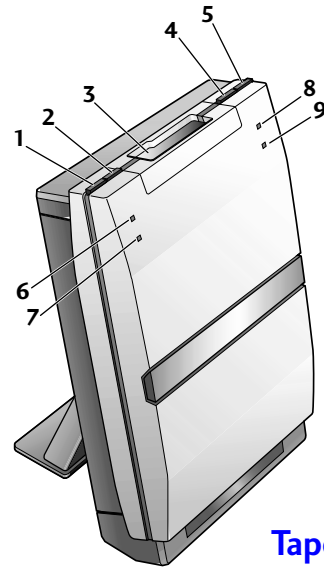

Tape deck

CD-tuner

Amplifier

Using menus

Many of the features of this system are accessed from menus displayed in the CD tuner's fluorescent display. The advantage of this is that you can use many of the features using just four buttons: **MENU** to display the first menu option; **◀◀** and **▶▶** to change the displayed option; and **SET** to select it.

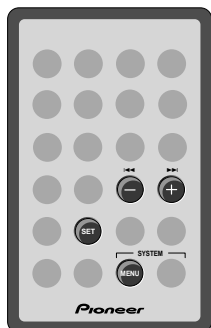

Different menu options appear depending on which component you're listening to; CD, radio, tape, MD, or a component connected to the auxiliary inputs.

There's another menu, the **TIMER** menu, which is available in any mode. From the timer menu you can set the clock, as well as use the wake up, record and sleep timer features. To display this menu, use the **TIMER** button instead of the **MENU** button.

Switching on and setting the clock

You should now have your system installed with everything connected up and plugged in. This chapter takes you through using the basic features: playing CDs and tapes, listening to radio stations, and adjusting the volume, tone and balance to get the sound you want.

First of all, we'll set the clock. This is mainly used for timer functions, such as the sleep timer, though you can also use the display as a clock. Unless you unplug the unit, or there's a power failure, you only need to set the clock once.

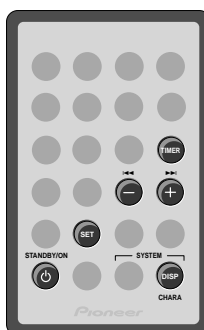

1 Switch on.

You can use the **⏻** button on the remote control or **STANDBY/ON** button on the top panel of the CD/tuner unit.

VOLUME 10

The display lights and briefly indicates the current volume level before showing the current function (e.g. CD).

CD

2 Select CLOCK ADJUST from the timer menu.

Press **TIMER** to display the timer menu, then press **◀◀** or **▶▶** until **CLOCK ADJUST** is shown in the display, then press **SET**.

CLOCK ADJUST

The display changes to show a date and time, with the day* part of the date blinking to indicate that you can set it.

- In some areas, the date is shown as year/month/day, with the year part blinking.

25/10/2001

3 Use the **◀◀** and **▶▶** buttons to set the day, then press **SET**.

Once you've pressed **SET**, the month will start blinking.

13/10/2001

4 In the same way, set the rest of the date and time.

Each time you press **SET**, the next part of the date/time will start blinking. Adjust using the **◀◀** and **▶▶** buttons.

Pressing **SET** after setting the minute completes the clock setup.

Remember

If power is interrupted, the clock display will flash until you reset it to the correct time. To use the timer features, always set the clock to the correct time.

Tip

- You can display the clock in either 12 or 24-hour format. See page 37 for how to change it.
- Press **SYSTEM DISP** in standby mode to show the day and time. The display remains until you hit the power button.

Playing a CD

Here, we'll run through the basics you need to play CDs. Other features, such as programming the track order, are covered in chapter 5.

**1 Load a CD.**

The disc compartment opens automatically if you're holding a disc in front of the unit (unless a disc is playing). Alternatively, you can press **OPEN/CLOSE CD** on the remote.

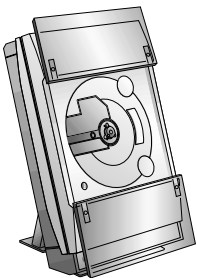

CD OPEN

Push a CD, with the label face outward, on to the disc spindle, as shown below. You can load regular 12cm discs, or 8cm CD singles.

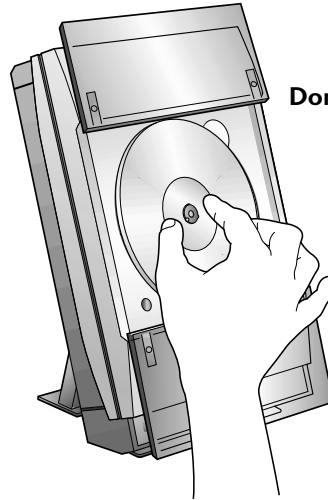

Don't touch the lens!

2 On the remote, press the CD button.

The disc doors close and the disc starts playing.

CD 1 0:06

You can also use the top panel controls:

▶/|| closes the disc compartment and starts the disc playing. **OPEN/CLOSE CD** closes the disc compartment without starting playback (the disc compartment closes automatically after 60 seconds).

3 Use the volume buttons to adjust the volume.

Press and hold for continuous adjustment. The display indicates the current volume level as you adjust it. (Maximum volume is 36.)

VOLUME 14

4 To pause playback, press the CD button.

To resume playback, press again.

You can also use the top panel controls:

Press ▶/|| once to pause playback; press again to resume.

5 To fast-reverse or fast-forward, press and hold ◀◀ or ▶▶.

◀◀ or ▶▶.

Release the button to resume normal playback.

4 Getting Started

- 6 To skip back or forward to another track, press (but don't hold) **⏮** or **⏭**.

Pressing **⏭** once skips to the start of the next track on the disc. Further presses take you to subsequent tracks.

Pressing **⏮** once takes you to the beginning of the current track. Further presses skip to the start of previous tracks.

You can use the track skip buttons while the disc is paused, too. The track number changes while the disc remains paused.

- 7 To stop playback, press **■**.

If the disc was paused, then pause is canceled. The display shows the number of tracks on the disc and the total playing time when the disc is stopped.

CD 16 69:02

Tip

In step 2 above, pressing the CD button closed the disc compartment and set the disc playing. In fact, pressing this button is always the quickest way to play a disc. If there's already a disc in the player, then pressing the CD button — even when the system is in standby mode — will switch the system on and start the disc playing.

Caution!

Be careful not to trap your fingers in the disc compartment as it closes automatically.

About the automatic door open sensor

The automatic opening of the disc compartment works using an infrared sensor. It may not work reliably if:

- the sensor is exposed to direct sunlight
- the room is lit using fluorescent lights
- the unit is on a dark-colored surface
- the unit is placed adjacent to a wall or other surface

Approximate transmitter range

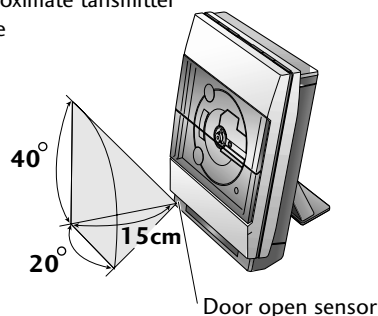

On its default setting, the door open sensor may open the disc compartment even if a CD is playing. You can change this so that it will only work if the CD player is stopped, or you can switch it off altogether (see page 36).

Adjusting the sound

Volume is adjustable from zero (silence) to 36 (maximum volume) using the volume + and – buttons on the remote. You can also adjust the bass, treble, balance and subwoofer level to get the sound you want. Start a disc playing before working through the steps below so that you can hear the effect of changes as you make them.

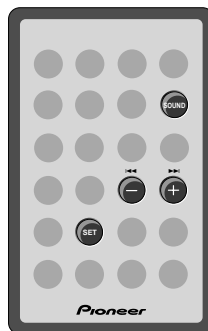

- 1 Press **SOUND**.

Press repeatedly to switch between:

BASS - TREBLE - BALANCE - WOOFER LEVEL

Stop on the one you want to adjust.

BASS

- 2 Press **SET**.

The display shows the current level.

BASS +4

- 3 Use the **⏮** and **⏭** buttons to adjust the level.

The display indicates the level as you change it. (The subwoofer has just three settings: **LOW**, **MEDIUM** and **HIGH**.)

BASS -2

- 4 When you're happy with the level, press **SET** again.

Tip

In step 3, if more than 5 seconds goes by without you pressing a button, the system goes ahead and sets the new level for you, without you having to press **SET** (step 4).

Listening to the radio

The tuner can receive both FM and AM broadcasts, and lets you memorize your favorite stations so you don't have to manually tune in every time you want to listen. Here we run through the basic tuner controls, including switching between AM and FM, and tuning to a station. Full instructions for all the tuner's other features can be found in chapter 6.



- 1 Press **TUNER** to switch to tuner mode.

TUNER

Press repeatedly to switch between:

FM – AM

Choose either **FM** or **AM**.

The display shows the current frequency.

FM 108.00MHz

- 2 **Tune to a station.**

There are three tuning modes: step, auto, and high-speed:

Step tuning: Press ◀◀ or ▶▶ repeatedly to step through the frequency band in either direction

Auto tuning: Press and hold ◀◀ or ▶▶ until the frequency display starts to move, then release. The tuner will stop on the next station it finds. Repeat to search for other stations.

High-speed tuning: Press and hold ◀◀ or ▶▶ until the frequency display starts to move rapidly. Keep the button held down until you reach the frequency you want. If necessary, fine tune the frequency using the step tuning method.

When you're tuned into a station, the tuned indicator lights in the display.

If the station is FM stereo, the stereo indicator lights.

Improving poor FM reception

If you're listening to an FM station in stereo but the reception is weak, you can improve the sound quality by switching to mono:

- 1 Press **SYSTEM MENU**, then **SET**.
You're now in the tuner menu.
- 2 Press ◀◀ or ▶▶ repeatedly to select **FM AUTO/MONO**, then press **SET**.

FM AUTO/MONO

- 3 Press ◀◀ or ▶▶ to select the **FM MONO** option.

(Press again to switch back to **FM AUTO** mode.)

- 4 Press **SET** again to exit the menu.

The mono indicator (○) lights in the display.

Remember: The FM mono mode remains set until you change it back to FM Auto mode.

Programming the track order

This mode lets you program a sequence (a playlist) of up to 24 tracks to play. The order can be anything you choose. Tracks can appear more than once in the playlist, or can be left out entirely. The playlist applies only to the disc in the player at the time. Once you take the disc out (or switch the power into standby), the playlist is lost.

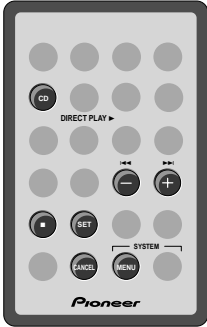

- 1 If the system isn't already in CD mode, press **CD** then stop playback.
- 2 With the disc stopped, press **SYSTEM MENU**, then **SET**.
- 3 Use **◀◀** or **▶▶** to select **PROGRAM**, then press **SET**.

PROGRAM

- 4 Select a track to add to the playlist using the **◀◀** and **▶▶** buttons.
For example, to add track 3, press **▶▶** three times. Or, to add the last but one track, press **◀◀** twice.
The currently selected track blinks.

3 4 : 54 PGM

- 5 Press **SET** to add the track to the playlist.
The display briefly shows the playlist step number and the track.

P01 3 PGM

- 6 Repeat steps 4 and 5 to continue adding tracks to the playlist.
 - If you make a mistake, press **CANCEL** to delete the last (most recent) track programmed. (Delete multiple tracks by pressing **CANCEL** repeatedly.)

P12 CLEAR PGM

- When no more tracks can be added the display shows **CD PGM FULL**.

PGM FULL PGM

- 7 When you've completed the playlist, press **MENU**.
The playlist can be up to 24 tracks long.
- 8 Press **CD** to start playback.

Checking the playlist order

You can only check the playlist order when the disc is stopped. Once stopped, you can step through the playlist using the **◀◀** and **▶▶** buttons. **Each track number in the playlist is displayed.**

If you then press **■**, the total playing time of the playlist is displayed.

Deleting the playlist

If you want to delete the playlist without **removing** the disc, press **■ STOP** twice when the disc is stopped.

Using repeat play

You can set the CD player to repeat either a single track over and over, or the whole disc.

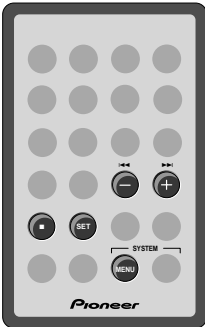

- 1 If the system isn't already in CD mode, press **CD** then stop playback.
- 2 Press **SYSTEM MENU**, then **SET**.
- 3 Use **◀◀** or **▶▶** to select **REPEAT MODE**, then press **SET**.

REPEAT MODE

- 4 Use **◀◀** or **▶▶** to choose a repeat mode. Three options are available:
 - **REPEAT TRK?** – repeat one track
 - **REPEAT ALL?** – repeat all tracks on the disc
 - **REPEAT OFF?** – turn repeat off
- 5 **Start playback.**

In one track repeat mode, any track you choose will repeat. If you jump to another track (using track skip or manual search), then the new track will start repeating.

In all track repeat mode, whenever the end of the disc is reached, the player will jump back to the first track and continue playback. You're still free to skip tracks and use manual search.

The repeat mode you set stays active until you:

- select another repeat mode, or switch repeat mode off using the menu.
- **open the disc compartment door.**
- switch to standby mode.

Tip

You can use either of the repeat modes together with the program play mode.

Setting the repeat mode to **REPEAT ALL** plays the tracks in the playlist over and over. In **REPEAT TRK** mode, just the current track in the playlist repeats.

Using random play

To have the CD player play the tracks on a disc in a different order each time you play the disc, use the random play function. Each track will play just once, but the order will be random. When all tracks have been played, the disc stops.

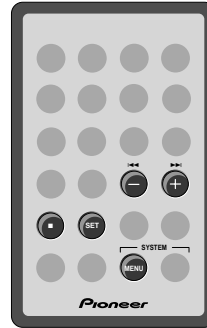

- 1 If the system isn't already in CD mode, press **CD** then stop playback.
- 2 Press **SYSTEM MENU**, then **SET**.
- 3 Use **◀◀** or **▶▶** to select **RANDOM PLAY**, then press **SET**.

RANDOM PLAY

- 4 **Playback begins automatically.** Pressing **■** during random play stops playback, and random play mode is cancelled.

Tip

You can use either of the repeat modes together with the random play mode.

Setting the repeat mode to repeat all endlessly plays all the tracks on the disc at random. In repeat track mode, just the current randomly selected track repeats.

Changing the display

You can choose to display various kinds of information during playback and stop modes. Switch between them by pressing the **SYSTEM DISP** button.

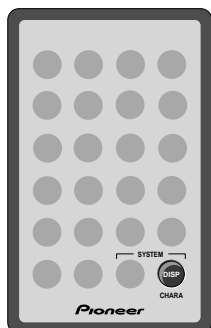

CALENDER – displays the current date

25/10/2001 or 2001/10/25

* In random play mode, the **ALL REMAIN** display is not available.

When a disc is stopped

TOTAL TIME – displays the number of tracks and the total playing time of the disc

CD 16 69:02

CLOCK – displays the current time and date

Mon 11:53 am

CALENDER – displays the current date

25/10/2001 or 2001/10/25

When a disc is playing

Elapsed track time (default) – displays the track number and the time elapsed

CD 1 0:06

TRACK REMAIN – displays the track number and track time still remaining

CD 1 3:42

ALL REMAIN – displays the disc time still remaining

CD AL 58:27

CLOCK – displays the current time and date

Mon 11:53 am

Saving station presets

You can save up to 30 station presets so that you always have easy access to your favorite stations without having to tune in manually each time. After you've set a station preset you can give it a name so you can remember which is which.

The following instructions assume that you are already familiar with tuning into radio stations — turn back to page 17 for detailed tuning instructions.

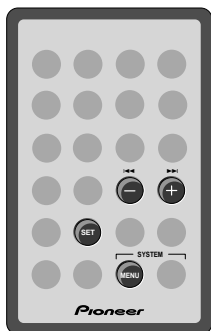

- 1 **Tune into a radio station on either the AM or FM band.**

See page 17 for detailed instructions on how to do this.

FM 108.00MHz

- 2 **Press SYSTEM MENU, then SET.**
- 3 **Use ◀◀ or ▶▶ to select STA. MEMORY, then press SET.**

STA. MEMORY

- 4 **Choose a station preset in which to save the station's frequency.**

You can save up to 30 station presets. Use the ◀◀ and ▶▶ buttons to select a preset number (1–30).

The number of the currently selected station preset blinks.

12 FM 108.00

- 5 **Press SET to save the station.**

The display flashes to indicate that it's saved.

Note: Station presets remain memorized for several days if the system is disconnected from the power outlet. After this time, station presets are lost and you'll have to reprogram them.

Listening to a station preset

When using the tuner button to switch between FM and AM, you've probably noticed a third option. This is the station memory mode, in which you can listen to the stations you've previously memorized.

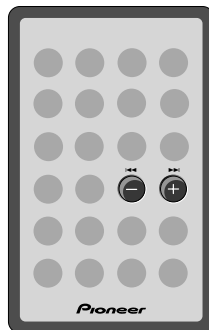

- 1 **If the system is not already in tuner mode, press TUNER.**
- 2 **Use the ◀◀ and ▶▶ buttons to step through the station memories.**

22 FM 88.00

The tuner will jump immediately to the frequency in the station memory. Unless you've given the station memory a name (see below for how to do this), the display shows the station memory number and the frequency.

6 More Tuner Features

Giving a station memory a name

If you've set up more than a couple of station memories, you'll probably want to give them names that are a little more memorable than 'FM 108.00'. Normally, of course, the name will be that of the radio station.

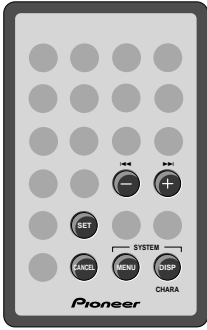

- 1 Recall the station preset you want to name.

24 FM 88.00

See *Listening to a station preset* on page 21 for detailed instructions on this.

- 2 Press **SYSTEM MENU**, then **SET**.
- 3 Use **◀◀** or **▶▶** to select **STA. NAME**, then press **SET**.

STA. NAME

- 4 Enter a name for the current station memory. The display shows the station preset number and a blinking cursor.

24 █

Names can be up to 9 characters long and can contain letters (upper and lower case), numbers, spaces and other symbols.

To select a character:

Use the **SYSTEM DISP** button to switch between character lists:

- Alphabet (uppercase)
- Alphabet (lowercase)
- Numbers (0-9) & punctuation/symbols

Use the **◀◀** and **▶▶** buttons to select a character from the

current list:

- ABCDEFGHIJKLMNOPQRSTUVWXYZ . , ' / <space>
- abcdefghijklmnopqrstuvwxyz . , ' <space>
- 0123456789 ! " # \$ % & ' () * + , - . / : ; < = > ? @ _ ` <space>

Press **SET** to enter the character.

The cursor moves to the next character position ready for you to input another character.

24 R █

- 5 When you've entered the whole name, press **MENU** to exit.

24 Radio 1

Tip

You can move the cursor left and right using the **◀◀** and **▶▶** buttons. To delete the character at the current cursor position, press **CANCEL**.

Using RDS (UK model only)

Radio Data System, or RDS as it's usually known, is a system used by FM radio stations to provide listeners with various information—the name of the station and the kind of show they're broadcasting, for example. This information shows up as text on the display, and you can switch between the kind of information shown. Although you don't get RDS information from all FM radio stations, you do with most.

Probably the most useful feature of RDS is that you can search automatically by type of program. So, if you felt like listening to jazz, you could have the MT search for a station that's broadcasting a show with the program type, "JAZZ." There are around 30 such program types, including various genres of music, news, sport, talk shows, financial information, and so on.

This unit let's you display three different kinds of RDS information: Radio Text, Program Service Name, and Program Type.

Radio Text (RT) is a message sent by the radio station. It can be anything the broadcaster chooses—a talk radio station might give out its telephone number as RT, for example.

Program Service Name (PS) is the name of the radio station.

Program Type (PTY) indicates the kind of program currently being broadcast.

Program types

Pop M	Pop music
Rock M	Rock music
M.O.R. M	"Middle of the road" music
Light M	'Light' classical music
Classics	'Serious' classical music
Jazz	Jazz music
Country	Country music
Nation M	Popular music in a language other than English
Oldies	Popular music from the '50s
Folk M	Folk music
Other M	Other music not fitting any of the above categories
News	News
Affairs	Current affairs
Info	General information
Sport	Sports
Educate	Educational material
Drama	Radio drama
Culture	Arts and culture
Science	Science and technology
Varied	Usually talk-based material, such as quiz shows or interviews.
Weather	Weather reports
Finance	Finance and business
Children	Children's entertainment
Social A	Social affairs
Religion	Religious programming
Phone in	Phone in talk show
Travel	Holiday-type travel rather than traffic announcements, etc.
Leisure	Leisure interests and hobbies
Document	Documentaries

In addition, there is a program type, **ALARM!**, used for exceptional emergency announcements. You can't search for this, but the tuner will switch automatically to that station if it picks up this RDS signal.

6 More Tuner Features

Searching for a program type

You can search for a station among your presets that is broadcasting a particular program type from the list on page 23.

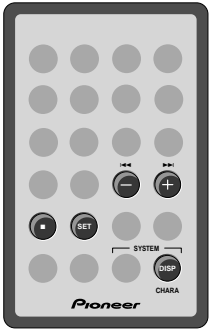

- 1 Press **SYSTEM DISP** and select **PTY SEARCH**.

PTY SEARCH

Press **SYSTEM DISP** repeatedly to switch between the options, then press **SET**.

- 2 Select the program type.

Use the ◀◀ and ▶▶ buttons to change the program type; select one by pressing **SYSTEM DISP**.

JAZZ

The complete list is on page 23.

- 3 The tuner starts searching for a matching station.

The tuner searches through the FM station presets.

If the tuner finds a matching program type, the tuner plays 5 seconds of the station. To listen to that station, press **SYSTEM DISP**. (The tuner stops searching.)

If you don't press **SYSTEM DISP** during the 5 seconds, the tuner resumes the search.

Cancel the search by pressing ■.

Switching the displayed information

You can choose to display various kinds of information when listening to the tuner. Remember that RDS information is only available when listening to FM stations. Switch between them by pressing the **SYSTEM DISP** button.

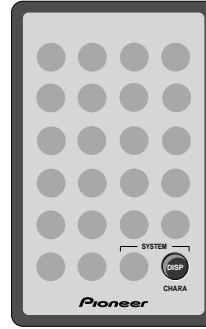

Frequency/station name (default) – displays the current radio frequency or station name (if you've programmed one)

RT – displays RDS radio text information*

R T

PS – displays RDS program service name information*

P S

PTY – displays RDS program type information*

PTY

PTY SEARCH – search for a particular program type (see *Searching for a program type* above)

PTY SEARCH

CLOCK – displays the current time and date

Mon 11:53 am

CALENDER – displays the current date

25/10/2001 or 2001/10/25

* If the station you're listening to is not transmitting any RDS information, you'll see the message **NO DATA** in the display.

If you selected **PTY** and the display shows **NO TYPE**, the display will revert automatically to the program service name after about 5 seconds.

Changing the tuning frequency interval

In some regions or countries, the default tuning frequency interval may not be suitable. If you find that you can't tune into stations properly (it sounds 'almost' tuned in), try switching to the alternate tuning frequency interval.

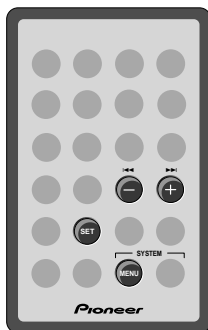

- 1 Put the system into standby.
- 2 Press **SYSTEM MENU**.
- 3 Use **◀◀** or **▶▶** to select **TUNER F.STEP**, then press **SET**.

TUNER F . STEP

- 4 Use **◀◀** and **▶▶** to select a frequency step.

AM9k / FM50k

There are two options:

- **AM9K / FM50K** – AM 9 kHz / FM 50 kHz
- **AM10K / FM100K** – AM 10 kHz / FM 100 kHz

- 5 Press **SET**.
The system goes back into standby.

7 Using the Tape Deck

Playing a tape (UK model only)

The tape deck features auto-reverse, Dolby B NR (noise reduction) and auto tape select. The auto-reverse feature lets you play or record both sides of the tape without physically taking it out and turning it over. Dolby B NR reduces tape hiss on tapes recorded using Dolby NR (which includes almost all commercially recorded tapes). Auto tape select means that the deck automatically detects the type of tape you're playing — normal (type I) or high-position/CrO₂ (type II) — so there's no need to check the tape type and switch manually. Here, we'll run through the basic tape deck controls; instructions for other features, such as recording, start on page 28.

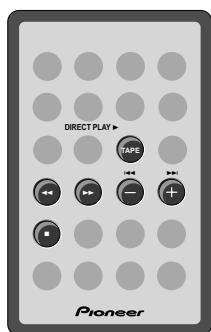

- 1 Press **TAPE** to switch to tape mode.

TAPE

- 2 Load a cassette tape then press **TAPE** to start playback.

Playback will start from the side facing you when you load it.

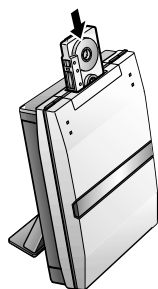

TAPE 0004

If you're using the top panel controls, press ◀▶ to start playback.

Use a tape that's already recorded on so you can hear something in the following steps!

The side of the tape you'll hear is whichever is facing toward you when you load it. This is the 'forward' (▶) direction, while the other side is 'reverse' (◀). The forward indicator is shown in the display.

- 3 To play the other side of the tape, press **TAPE**. Each time you press tape during playback, the other side of the tape starts playing. Pressing tape when the tape is stopped starts playback on the side it was playing previously. The current tape direction is indicated in the display.
- 4 To rewind or fast forward the tape, press ◀◀ or ▶▶.
- 5 To skip back or forward a track on the tape, press ◀◀◀ or ▶▶▶.

▶▶▶ searches for the next blank space between tracks on the side currently playing (in other words, to the start of the next track), then resumes playback.

◀◀◀ searches for the previous blank space between tracks on the side currently playing (in other words, to the start of the current track), then resumes playback.

By pressing ◀◀◀ or ▶▶▶ more than once, the **tape deck** will skip several tracks at once (up to a maximum of 15). For example, press ▶▶▶ twice to skip forward two tracks.

TAPE MS P+02

Note: Track search is unlikely to work reliably in the following cases:

- if the space between tracks is less than about 4 seconds
- if the recording is particularly noisy so the spaces are not recognized
- if the recording contains frequent silences, such as a language study tape.
- if the recording contains sections of very quiet material, such as some classical music recordings

- 6 To stop the tape, press ■.

Press ▲ on the top panel to eject the tape.

TAPE EJECT

Tip

If there's already a tape in the **deck**, then pressing the **TAPE** button — even when the system is in standby mode — will switch the system on and start the tape playing.

Setting the reverse mode

The tape deck can play both sides of a tape without you having to take the cassette out and turning it over by hand. This feature is called auto-reverse (because to play the other side of the tape, the tape travels in the opposite direction).

You can switch sides any time while playing a tape by pressing the tape button. The reverse mode, however, tells the deck what to do when it reaches the end of the tape on the side it's playing. There are two modes: endless and one-way.

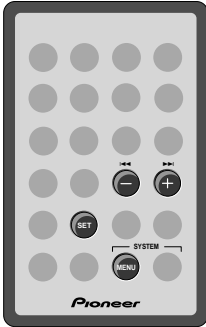

- 1 Press **SYSTEM MENU**, then **SET**.
- 2 Use **◀◀** or **▶▶** to select **REVERSE MODE**, then press **SET**.

REVERSE MODE

- 3 Use **◀◀** or **▶▶** to select a reverse mode, then press **SET**.

ENDLESS?

Two options are available:

- **ENDLESS?** – Play the tape round and round continuously.
- **ONE-WAY?** – Play one side, then stop.

In endless mode, the reverse mode indicator on the front panel lights.

Note: Actually, in endless mode, the deck will only play the tape through 16 times before it stops automatically.

Reducing tape hiss with Dolby NR.

For best sound quality, tapes that are recorded with Dolby NR should be played with Dolby NR switched on. This includes virtually all commercially produced tapes—look for the double-D symbol (DD) on the inlay card, or on the cassette tape itself.

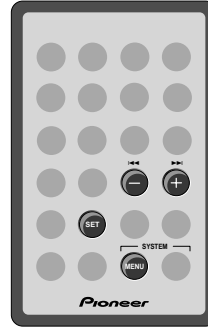

- 1 Press **SYSTEM MENU**, then **SET**.
- 2 Use **◀◀** or **▶▶** to select **DOLBY NR**, then press **SET**.

DOLBY NR

- 3 Use **◀◀** or **▶▶** to set **NR ON** or **NR OFF**, then press **SET**.

NR ON?

The **DOLBY** indicator on the front panel lights when Dolby NR is on.

- *Dolby noise reduction manufactured under license from Dolby Laboratories.*
- *“Dolby”, and the double-D symbol are trademarks of Dolby Laboratories.*

Making tape recordings (UK model only)

You can make tape recordings from any other component in the system, and also from an external component connected to the auxiliary inputs. If you're recording from CD or the optional CD-Recorder, it's usually most convenient to use the synchro-recording mode. This makes the process largely automatic with the system starting and stopping the recording for you. Detailed instructions for this are below. If you're recording from the tuner or from a component connected to the auxiliary inputs, use the manual recording mode explained on page 29.

Once recording has started, you can't switch to another component until either the recording has stopped, or you pause the recording. So, for example, you can't switch over to the tuner while you're recording a CD.

Unlike some tape decks, there's no need to set recording levels — the deck sets the right level automatically. Also, when recording, the volume, tone and balance controls have no effect on the recording. This means that you can record something with the volume turned right down, if you want.

Before recording, check that the cassette erase tabs have not been broken, and that the tape is either a type I (normal position) or type II (high position/CrO₂) — you can't record on type IV (metal) tapes using this deck.

If you're recording from the start of a tape, it's a good idea to wind the tape on a little so that you don't accidentally start recording over the leader tape. You can either do this by hand, or load the tape into the deck and play the tape for 5–6 seconds.

Recording CDs

This feature makes recording a CD as simple as possible by automatically starting and stopping the CD and tape together. There are two modes: 1 track synchro records just a single track, then stops; all tracks synchro records the whole disc.



1 Load a cassette into the tape deck.

In order to follow these instructions more easily, load the cassette with side A facing you.

2 Check the recording direction.

If the tape direction indicator shows ►, then recording will start from side A. If it shows ◀, then recording will start from side B.

If you need to change the direction, press **TAPE** twice, then ■.

3 Set the auto-reverse mode.

If you set this to one-way, then recording will stop after reaching the end of the current side. If it's set to endless, then recording will continue onto the other side of the tape. However, if you start recording in the reverse direction, (◀) only that side of the tape will be recorded.

For detailed instructions on setting the reverse mode, see page 27.

4 Turn Dolby NR on or off as required.

Using Dolby NR improves the sound quality of tape recordings that are going to be played on Dolby NR equipped players. If the tape is not going to be played on a Dolby NR equipped player (or if you're not sure), you should leave Dolby NR off. See page 27 for detailed instructions on switching Dolby NR on/off.

5 Press CD to switch to the CD.

6 Load the CD you want to record.

See page 15 for detailed instructions on loading discs.

If the disc has started playing, press ■.

7 If you want to record just one track, select the track using the ◀◀ and ▶▶ buttons.

8 Press ● II (top panel only).

The tape deck goes into record-pause mode, waiting for you to start the CD.

9 Press CD to start the CD playing.

Recording starts automatically with the CD.

Once the track or disc has finished, the tape deck goes back into record-pause mode — press ■ to fully stop recording.

Should you want to stop recording before the track/disc has finished playing, simply press ■ any time during the recording.

Note: If the recorder has to switch the side of the tape half way through a track, recording will start again on the other side from the beginning of the same track. This means you don't get a single track spread over two sides of a tape.

Recording other sources

Usually, when recording a CD or MD, the synchro-recording feature is the easiest way to do it. However, if you want to record from the tuner or from a component connected to the auxiliary inputs, you'll need to start and stop the recording manually.

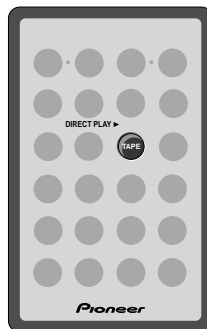

1 Follow steps 1–4 of Recording CDs on page 28.

- Load a cassette
- Set the record direction
- Set the reverse mode
- Switch Dolby NR on/off.

2 Select the source you want to record.

For example, if you want to record from the tuner, press tuner, and tune into a station.

If you are recording from another component, set it up ready for playback.

3 Press ● II (top panel only).

The **tape deck** goes into record-pause mode.

4 Press TAPE to begin recording.

If you're recording from a component that requires you to start playback (a turntable or another cassette deck, for example), start playback here.

To pause recording, press ● II. To resume, press TAPE.

5 When you want to finish the recording, press ■ (top panel only).

Setting up a future recording (UK model only)

You can set the timer to record something from either the tuner or a component connected to the auxiliary inputs. For example, you might want to record a program on the radio that is broadcast while you're at work. If you're recording from an auxiliary component it must also be able to switch on at the time the recording starts — this system can't control it — or you have to leave it switched on until the recording has finished. During the actual recording, the volume is automatically set to minimum.

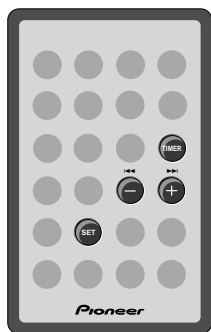

1 Set up the tape deck ready to record.

Load a cassette tape, set the recording direction and reverse mode, and switch on/off Dolby NR as required.

2 Set up the tuner/auxiliary component.

If you're recording from the tuner, switch to the tuner, and tune into the station (see page 17 for more detailed instructions on this).

If you're recording from the auxiliary component, switch to that component and set it up for playback.

3 Press **TIMER** and select **TIMER REC.**

Remember: Switch between timer menu options using the **◀◀** and **▶▶** buttons; select the option by pressing **SET**.

4 Use **◀◀** and **▶▶** to select **TIMER EDIT**, then press **SET**.

5 Set the recording start time:

First, set the hour:

Use the **◀◀** and **▶▶** buttons to change the flashing hour display, then press **SET**.

Next, set the minute:

Use the **◀◀** and **▶▶** buttons to change the flashing minute display, then press **SET**.

6 Set the recording end time:

First, set the hour:

Use the **◀◀** and **▶▶** buttons to change the flashing hour display, then press **SET**.

Next, set the minute:

Use the **◀◀** and **▶▶** buttons to change the flashing minute display, then press **SET**.

7 Use **◀◀** and **▶▶** to select **TAPE REC**, then press **SET**.

After pressing **SET**, the display shows you the settings you've just made, including the switch on and off times, and the component you're recording from.

The clock and record symbols in the display indicate that the record timer is set.

Be sure to switch the system into standby before timer recording starts (the standby indicator lights green in timer-standby mode). In timer-standby you can check the timer settings by pressing **TIMER**.

After the recording has finished, the timer recording mode is automatically cancelled.

Cancelling the record timer

Once the timer recording has finished, the timer is automatically cancelled. However, if you need to cancel it before the recording has started, (either because you made a mistake setting it, or simply because you no longer want to make the recording), here's how you do it.

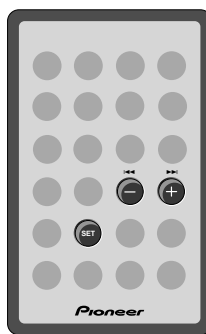

1 Press **TIMER** and select **TIMER REC.**

Remember: Switch between timer menu options using the **◀◀** and **▶▶** buttons; select the option by pressing **SET**.

2 Use **◀◀** and **▶▶** to select **TIMER OFF**, then press **SET**.

After pressing **SET**, the timer indicator in the display goes out.

Setting the record timer and the wake-up timer

You can set the record timer together with the wake-up timer (described on page 32)—to record a radio program with the record timer, then later start playing a CD at the time set by the wake-up timer, for example. Be careful, however, to leave at least a minute between the end time for one timer and the start time of the another. If the start and end times overlap or are the same, the later timer will not operate correctly.

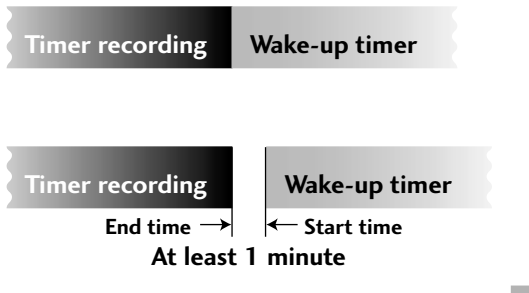

Changing the display

(UK model only)

You can choose to display various kinds of information when using the tape deck. Switch between them by pressing the **SYSTEM DISP** button.

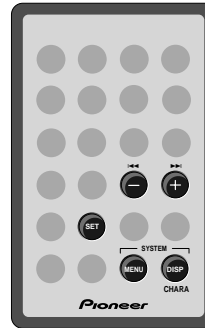

TAPE COUNTER – displays the tape counter

TAPE 0004

CLOCK – displays the current time and date

Mon 11:53 am

CALENDAR – displays the current date

25/10/2001

Resetting the tape counter

The tape deck has a digital tape counter which resets to zero each time you load a cassette or switch the power off. You can reset the counter to zero at any other time from the menu.

- 1 Press **SYSTEM MENU**, then **SET**.
- 2 Use **◀◀** or **▶▶** to select **C.RESET**, then press **SET**.

C . RESET

The counter returns to zero.

TAPE 0000

The timer menu

Using the timer features you can automatically record a program from the tuner at a certain time, wake up to a CD playing, or fall asleep at night to the radio. These functions are available from the timer menu, which is accessed by pressing the **TIMER** button. The menu has four options.

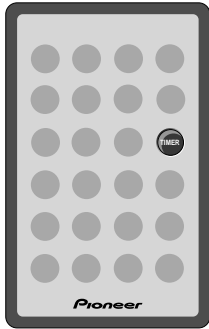

WAKE UP – Set the system to switch on and start playing at a certain time (for example, at the same time as your alarm clock goes in the morning).

TIMER REC – Set the optional tape deck, MD or CD-Recorder to record from the auxiliary inputs or a radio program at a certain time.

SLEEP TIMER – Set the system to switch off at a certain time (for example, half an hour after you go to bed).

CLOCK ADJUST – Set the clock to the correct time (see page 14). Remember, the timer functions won't work properly unless you've set the clock!

Setting the wake up timer

Once set, the wake-up timer will remain active (i.e., it will switch on the system every day) until you cancel it (see *Cancelling the wake up timer* below). You can wake up to the sound of any component in the system, but not a component connected to the auxiliary inputs. To set the wake up timer, you'll need to tell it which component to start playing, what time to start, and also what time to stop.



1 Select the component you want the timer to start playing.

For example, press the CD button and load a CD into the player (no need to start it playing). If you're using the tuner, tune in to a radio station. Remember to set the volume at a suitable level.

2 Press **TIMER** and select **WAKE-UP**.

WAKE - UP

Remember: switch between timer menu options using the **◀◀** and **▶▶** buttons; select the option by pressing **SET**.

3 Use **◀◀** and **▶▶** to select **TIMER EDIT**, then press **SET**.

4 Set the time to switch on.

First, set the hour: use the **◀◀** and **▶▶** buttons to change the flashing hour display, then press **SET**.

Next, set the minute: use the **◀◀** and **▶▶** buttons to change the flashing minute display, then press **SET**.

ON 10:30 am

5 Set the switch off time.

Set the hour: use the **◀◀** and **▶▶** buttons to change the flashing hour display, then press **SET**.

Next, set the minute: use the **◀◀** and **▶▶** buttons to change the flashing minute display, then press **SET**.

OFF 11:45 am

After pressing **SET** the display shows you the settings you've just made, including the switch on and off times, the component, and the volume level.

TIMER CHECK

The clock and sunrise symbols in the display indicate that the wake up timer is active.

Note: for the wake-up timer to work, the system must be in standby, so remember to switch the system off before going to sleep (the standby indicator lights green in timer-standby mode). In timer-standby you can check the timer settings by pressing **TIMER**.

 cancelling the wake up timer

The wake-up timer doesn't automatically cancel, since you may well want to have the system switch on every morning at the same time, for example.

1 Press TIMER and select WAKE-UP.

WAKE - UP

Remember: switch between timer menu options using the **◀◀** and **▶▶** buttons; select the option by pressing **SET**.

2 Use ◀◀ and ▶▶ to select TIMER OFF, then press SET.

After pressing **SET**, the timer indicator in the display disappears.

- To switch the timer back on, repeat step 1, then select **TIMER ON** in step 2.

Tips

- Although you can't directly edit the wake-up settings once they're made, if you cancel the wake-up timer then set it again, the previous settings will show up in the display.
- You can set both the wake-up timer and the record timer independently. However, make sure that the times do not overlap. See page 31 for more on this.

Setting the sleep timer

When setting the sleep timer, you only have to tell the system when to switch off.

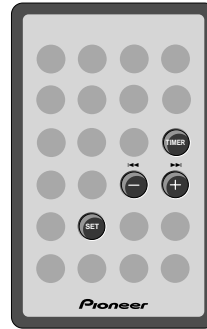
**1 Press TIMER and select SLEEP TIMER.**

SLEEP TIMER

Remember: switch between timer menu options using the **◀◀** and **▶▶** buttons; select the option by pressing **SET**.

2 Use ◀◀ and ▶▶ to select a switch off time, then press SET.

- **AUTO** – plays the current CD, CD-R, tape or MD out, then switches off the system
- **90** – switches off after 90 minutes
- **60** – switches off after 60 minutes
- **30** – switches off after 30 minutes
- **OFF** – cancels the sleep timer if it was previously set

The **sleep** indicator lights in the display to show the sleep timer is set and the display dims. To check how much time is left on the sleep timer, select **SLEEP TIMER** from the timer menu, then press **SET**. The display shows the remaining time.

Tip

The **AUTO** setting will not be available if a CD, CD-R or MD is playing in repeat mode (see page 19), or if a tape is playing in endless mode (see page 27). If you select **AUTO**, then subsequently start playing something in repeat or endless mode, the sleep timer will change automatically to the **90** minute setting.

Care information

Handling discs

When holding CDs, take care not to leave fingerprints, dirt or scratches on the disc surface. Hold the disc by its edge or by the center hole and edge. Damaged or dirty discs can affect playback performance. Take care also not to scratch the label side of the disc. Although not as fragile as the recorded side, scratches can still result in a disc becoming unusable.

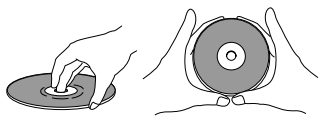

Should a disc become marked with fingerprints, dust, etc., clean using a soft, dry cloth, wiping the disc lightly from the center to the outside edge as shown below. If necessary, use a cloth soaked in alcohol, or a commercially available CD cleaning kit to clean a disc more thoroughly. Never use benzine, thinner or other cleaning agents, including products designed for cleaning vinyl records.

- **Wipe lightly from the center of the disc using straight strokes.**

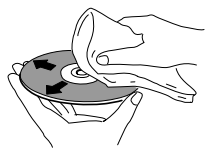

- **Don't wipe the disc surface using circular strokes.**



Storing discs

Although CDs are more durable than vinyl records, you should still take care to handle and store discs correctly. When you're not using a disc, return it to its case and store upright. Avoid leaving discs in excessively cold, humid, or hot environments (including under direct sunlight).

Don't glue paper or put stickers on discs, or write on them using a pencil, ball-point pen or other sharp-tipped writing instrument.



Discs you should avoid

CDs spin at high speed inside the player during playback. If you can see that a disc is cracked, chipped, warped, or otherwise damaged, don't risk using it in your CD player — you could end up damaging the unit.

This system is designed for use with conventional, fully circular CDs only. Use of shaped CDs is not recommended. Pioneer disclaims all liability arising in connection with the use of shaped CDs.

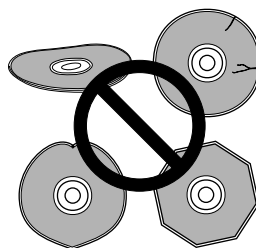

Using cassette tapes

The tape of a cassette is quite easily damaged and loose tape can jam in the tape deck mechanism. If the tape has become unwound, use a pen or pencil to wind it back on to the spool.

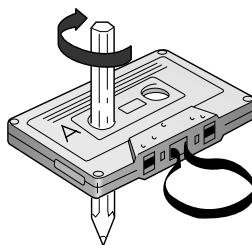

When not using cassettes, always store in the case. Store cassettes away from magnetic fields, excessive heat, humidity, dust or oil.

Before recording on a tape, wind the tape on past the leader tape (about the first 3 or 4 seconds of each side).

Tapes you should avoid

Since tapes longer than 90 minutes are so thin, they are more susceptible to jamming in the tape deck mechanism and other trouble such as irregular winding. Avoid using cassette tapes longer than 90 minutes.

Erase protection

You can protect an important recording against accidental erasure by breaking the erase-protect tab(s) with a small screwdriver.

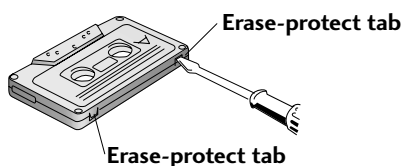

If you want to re-record on an erase-protected cassette, cover the space left by the broken tab with self-adhesive tape.

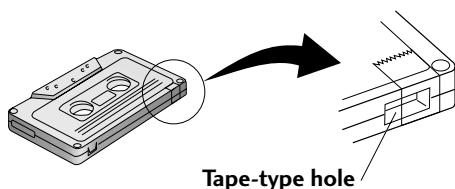

Note: If you're using Type II (High/CrO₂) tapes, make sure you don't also cover the tape-type detection holes.

Cleaning external surfaces

To clean this unit, wipe with a soft, dry cloth. For stubborn dirt, wet a soft cloth with a mild detergent solution made by diluting one part detergent to 5 or 6 parts water, wring well, then wipe off the dirt. Use a dry cloth to wipe the surface dry. Do not use volatile liquids such as benzene and thinner which may damage the surfaces.

Moving the unit

If you need to move the unit, first switch it off and unplug from the wall outlet. Avoid lifting or moving the unit during playback or recording.

CD lens cleaner

The CD pickup lens should not become dirty in normal use, but if for some reason it should malfunction due to dirt or dust, consult your nearest Pioneer authorized service center. Although lens cleaners for CD players are commercially available, we do not recommend using them since some may damage the lens.

Tape head cleaner

To maintain the recording/playback quality of the tape deck, use a commercially available wet-type cassette head cleaner. Avoid using dry-type cassette head cleaners.

Be careful: Some cassette head cleaners are not designed to work with auto-reverse decks and may become jammed in the mechanism — ask your Pioneer authorized service centre for details.

After using the head cleaner, leave the unit for 2–3 minutes before playing a tape. This will give any excess cleaning fluid a chance to dry.

Demagnetizing the tape head

The recording/playback head in the tape deck gradually becomes magnetized after long periods of use. Playback and recording quality will suffer as a result, with a lack of treble and increased noise. To avoid the problem, we recommend using a head demagnetizer at regular intervals. These are available from any good audio dealer.

When using a head demagnetizer, be sure to turn the volume right down and unplug any headphones to avoid damaging the unit or the speakers. For further details, refer to the instructions that came with the head demagnetizer.

Magnetic shielding of speakers

The satellite speakers are magnetically shielded. This means that they can safely be placed near a TV or monitor without distorting the picture.

The subwoofer is not magnetically shielded. If it is placed very near a TV or monitor, you may see color distortion in the picture. Switch off the TV for about 30 minutes and move the subwoofer further away from the television to solve the problem.

Removing/replacing the satellite speaker grilles

You can use the satellite speakers with or without the grilles.

To remove:

- 1 Gently pull the bottom half of the grille away from the speaker.
- 2 Pull away the top half to completely remove the grille.

To put back on:

- 1 Line up the grille with the holes in each corner of the speaker
- 2 Push the grille back on.

Switching the door open sensor on/off

The door open sensor on the front of the CD tuner has two operating modes, as well as an off setting.

- 1 **Switch the unit into standby.**
- 2 **Press SYSTEM MENU and select SENSOR MODE.**

SENSOR MODE

Remember: switch between menu options using **◀◀** and **▶▶**; select the option by pressing **SET**.

- 3 **Use ◀◀ or ▶▶ to select MODE 1, MODE 2 or OFF as required.**
 - **SNSR MODE 1** – (default) the door will open automatically, even if a disc is currently playing.
 - **SNSR MODE 2** – the door will only open automatically if no disc is playing.
 - **SNSR OFF** – switches off the automatic door feature
- 4 **Press SET.**
The system goes back into standby.

Switching the open/close beep on/off

By default, when you press **OPEN/CLOSE** to open or close the disc compartment, you'll hear a beep. If you would prefer not to, here's how to switch it off:

- 1 **Switch the unit into standby.**
- 2 **Press SYSTEM MENU and select BEEP MODE.**

BEEP MODE

Remember: switch between menu options using **◀◀** and **▶▶**; select the option by pressing **SET**.

- 3 **Use ◀◀ or ▶▶ to select BEEP ON or BEEP OFF as required.**
- 4 **Press SET.**
The system goes back into standby.

Switching the auxiliary attenuator on/off

Depending on the component that you connect to the auxiliary inputs, it's possible that the signal level will be too high for this system to play properly without the sound distorting. If you notice distortion when listening to the auxiliary component, try switching the attenuator on.

- 1 **Switch the unit into standby.**
- 2 **Press SYSTEM MENU and select AUX ATT.**

AUX ATT

Remember: switch between menu options using **◀◀** and **▶▶**; select the option by pressing **SET**.

- 3 **Use ◀◀ or ▶▶ to select ATT ON or ATT OFF as required.**
The default setting is **ATT OFF** (attenuate off).
- 4 **Press SET.**
The system goes back into standby.
If you selected **ATT ON**, the level of the input signal is reduced to prevent distortion.

Setting the display brightness

You can adjust the brightness of the display to suit the lighting conditions of the room. For example, in a brightly lit room you'd probably want the display brighter than in a room with low lighting.

- 1 **Press SYSTEM MENU and select DIMMER SEL.**

DIMMER SEL

Remember: switch between menu options using **◀◀** and **▶▶**; select the option by pressing **SET**.

- 2 **Adjust the brightness using the ◀◀ and ▶▶ buttons.**
There are five levels of brightness (UK model default is 4; non-UK model default is 5).
- 3 **Press SET.**
The system goes back into standby.
 - When switched on, the blue light on the disc compartment door and on the front of the tape deck changes (3 levels) with the display brightness.

Switching the time format

By default, the time is displayed as a standard 12-hour clock. If you prefer, you can show the time in 24-hour format.

- 1 **Switch the unit into standby.**
- 2 **Press SYSTEM MENU and select HOUR FORMAT.**

HOUR FORMAT

Remember: switch between menu options using **◀◀** and **▶▶**; select the option by pressing **SET**.

- 3 **Use ◀◀ or ▶▶ to select 12-HOUR or 24-HOUR as required.**
 - 4 **Press SET.**
The system goes back into standby.
-

Troubleshooting

Incorrect use can be mistaken for trouble or malfunction. If you think there is something wrong with this component, check the points below. Sometimes the trouble may lie in another component. Check the other components and electrical appliances being used. If the trouble cannot be rectified even after checking the points below, ask your nearest Pioneer authorized service station to carry out repair work.

- **Power turns off suddenly during operation.**
 - Check that the cooling vents are not blocked. Do not use on thick carpet or cover with cloth in use.
 - **No sound.**
 - No sound when trying to listen to the radio.
 - Check that the FM and AM antennas are connected properly.
 - **CD doesn't play.**
 - Check that the disc is loaded with its printed/label side face up.
 - Check that the disc is clean and free of scratches and other damage. If necessary, clean the disc.
 - **When listening to the radio, the sound is noisy or distorted.**
 - If you're listening to a stereo FM station, try switching to mono.
 - Check that the antenna(s) are connected securely.
 - Try moving the antenna(s) to face a different direction.
 - Check that there aren't any electrical appliances operating near the antenna(s).
 - Try using the alternative tuning frequency interval.
 - **Broadcast is stereo but the sound from the speakers is mono.**
 - Switch to auto stereo mode.
 - **Can't set the timer.**
 - Check that the clock has been set.
 - **Remote control doesn't work.**
 - Try replacing the batteries.
 - Check that fluorescent light, or other strong light is not shining onto the remote sensor.
 - Make sure that you're using the remote within its operating range.
 - **Can't record**
 - Check that the erase-protect tabs are intact, or covered with tape. Cover broken tabs with tape to enable recording. (page 35)
 - **Recordings are muddy or distorted**
 - Clean the tape heads. (page 35)
 - **Previous recording can still be heard underneath a new one.**
 - Check that you're using either a Type I (Normal), or Type II (CrO₂) tape.
 - Clean the heads. (page 35)
 - **Playback sound is muddy or distorted; high frequency sounds are excessively emphasized.**
 - Check that Dolby NR is set to the same setting as that used during recording. (page 27)
 - **Miscellaneous problems**
 - When the system is installed near a television set, magnetic influence from the speakers may cause the television's picture to be distorted. This symptom frequently occurs when using an indoor antenna; in this event, install an outdoor antenna, or separate the system farther from the television.
 - Static electricity and other outside electrical influences may cause the system to operate incorrectly. In such cases, unplugging and reconnecting the power cord may help correct the problem.
 - More than one of the same kind of component (CD tuner, MD recorder, CD recorder or cassette deck) cannot be connected at the same time.
-

Specifications

Stereo Power Amplifier: M-F10/ M-NS1

Continuous Power (RMS)	
Satellite	30 W + 30 W (3 kHz, THD 10%, 8 Ω)
Subwoofer	50 W (70 Hz, THD 10%, 4 Ω)
Continuous Power (DIN)	
Satellite	23 W + 23 W (3 kHz, THD 1%, 8 Ω)
Subwoofer	43 W (70 Hz, THD 1%, 4 Ω)
Power Requirements	
	AC 230 V, 50/60 Hz (UK model)
	AC 240 V, 50/60 Hz (Non-UK model)
Power Consumption (ON mode)	
	127 W (UK model)
	110 W (Non-UK model)
Power Consumption (Standby mode)	
	0.9 W
Dimensions	
	190 (W) x 80 (H) x 267 (D) mm
Weight	
	4.0 kg

Stereo CD Tuner: XC-F10/XC-NS1

FM Tuner Section

Frequency Range	87.5 – 108MHz
Antenna	75 Ω, unbalanced

AM Tuner Section

Frequency Range	531 kHz – 1,602 kHz
	(9 kHz step)
	530 kHz – 1,700 kHz
	(10 kHz step)
Antenna	Loop antenna

Compact Disc Player Section

Type	Compact disc digital audio system
Usable discs	Compact discs
Channels	2 (stereo)
Frequency Response	4 Hz–20 kHz
Signal-to-Noise Ratio	110 dB (EIAJ)
Wow and Flutter	Limit of measurement
	(0.001%) or less (EIAJ)
Dimensions	170 (W) x 268 (H) x 66 (D) mm
	(w/out stands and door closed)
Weight	1.5 kg

Accessories

Remote control unit	1
Stand A	1
Stand B	1
Paper pattern	1
System cable	1
AC power cable	1
FM wire antenna	1
AM loop antenna	1
Lithium battery (CR2025)	1
Operating Instructions	1
Warranty card	1

Satellite Speakers: S-F10-LR/ S-NS1-LR

Type	Enclosed bookshelf type
Speaker Elements	70 mm (cone type)
Nominal impedance	8 Ω
Frequency response	125 Hz–20 kHz
Maximum power	30 W
External dimensions	130 (W) x 245 (H) x 65 (D) mm
	(w/out stands)
Weight	0.7 kg

Subwoofer: S-F10-W/S-NS1-W

Type	Phase inversion (bass reflex), bookshelf type
Speaker Elements	16 cm (cone type)
Nominal impedance	4 Ω
Frequency response	22 Hz–3000 Hz
Maximum power	50 W
External dimensions	190 (W) x 282 (H) x 253 (D) mm
Weight	3.5 kg

Accessories

Speaker cables	2
Subwoofer connecting cable	1
Speaker stands	2
Extra speaker grilles (UK only)	2

Stereo Cassette Deck: CT-F10

System	4-track, 2-channel stereo
Heads	Recording/playback head x 1
	Erase head x 1
Motor	DC Servo motor x 1
Frequency Response (–20dB recording)	
Type I (Normal) tape	20 Hz–16,000 Hz ± 6 dB
Type II (High/CrO ₂) tape	20 Hz–16,000 Hz ± 6 dB
Signal-to-Noise Ratio	56 dB
	(EIAJ, peak recording level, audio compensation)
Noise Reduction Effect	
Dolby B-type NR ON	More than 10 dB (at 5 kHz)
Wow and Flutter	0.07% (WRMS), ± 0.14% (DIN)
Dimensions	170 (W) x 268 (H) x 66 (D) mm
	(without stands)
Weight	1.5 kg

Accessories

Stand A	1
Stand B	1
Operating instructions	1
Warranty card	1

Note: Specifications and design subject to possible modification without notice, due to improvements.

Switching the demo on/off

When you first plug in this unit the display shows a demo sequence. When the demo mode is set to on, the demo sequence starts if the unit is idle for more than 5 minutes, *unless*:

- the function is set to **AUX** or **TUNER**
- the display is showing the time or calendar

Press any button to exit the demo sequence once it's started.

If you would rather switch off the demo completely, here's how to do it.

- 1 **Switch the unit into standby.**
- 2 **Press SYSTEM MENU.**
- 3 **Use the ◀◀ or ▶▶ buttons to select DEMO MODE, then press SET.**

DEMO MODE

- 4 **Use ◀◀ or ▶▶ to select DEMO ON or DEMO OFF as required.**
- 5 **Press SET.**

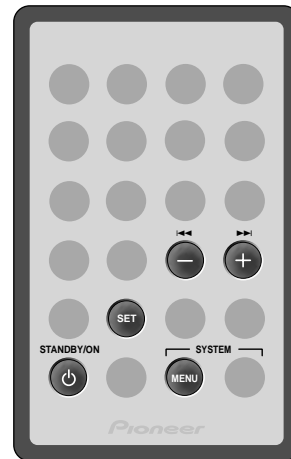

Published by Pioneer Corporation.
Copyright © 2000 Pioneer Corporation.
All rights reserved.

PIONEER CORPORATION 4-1, Meguro 1-Chome, Meguro-ku, Tokyo 153-8654, Japan
PIONEER ELECTRONICS [USA] INC. P.O. BOX 1540, Long Beach, California 90801-1540, U.S.A.
PIONEER ELECTRONICS OF CANADA, INC. 300 Allstate Parkway, Markham, Ontario L3R 0P2, Canada
PIONEER EUROPE N.V. Haven 1087, Keetberglaan 1, 9120 Melsele, Belgium TEL: 03/570.05.11
PIONEER ELECTRONICS AUSTRALIA PTY. LTD. 178-184 Boundary Road, Braeside, Victoria 3195, Australia, TEL: [03] 9586-6300
PIONEER ELECTRONICS DE MEXICO S.A. DE C.V. San Lorenzo 1009 3er Piso Desp. 302 Col. Del Valle Mexico D.F. C.P. 03100
TEL: 5-688-52-90

Free Manuals Download Website

<http://myh66.com>

<http://usermanuals.us>

<http://www.somanuals.com>

<http://www.4manuals.cc>

<http://www.manual-lib.com>

<http://www.404manual.com>

<http://www.luxmanual.com>

<http://aubethermostatmanual.com>

Golf course search by state

<http://golfingnear.com>

Email search by domain

<http://emailbydomain.com>

Auto manuals search

<http://auto.somanuals.com>

TV manuals search

<http://tv.somanuals.com>