

Pioneer

MULTI PLAYER

CDJ-900

<http://www.prodjnet.com/support/>

The Pioneer website listed above provides answers to frequently asked questions, information about software, and other up-to-date data of assistance to our customers.



<http://www.prodjnet.com/rekordbox/support/>

For inquiries on rekordbox, please see the support site indicated above.

Operating Instructions



Thank you for buying this Pioneer product. Please read through these operating instructions so you will know how to operate your model properly. After you have finished reading the instructions, put them away in a safe place for future reference. In some countries or regions, the shape of the power plug and power outlet may sometimes differ from that shown in the explanatory drawings. However the method of connecting and operating the unit is the same.

<h2 style="margin: 0;">IMPORTANT</h2>  <p>The lightning flash with arrowhead symbol, within an equilateral triangle, is intended to alert the user to the presence of uninsulated "dangerous voltage" within the product's enclosure that may be of sufficient magnitude to constitute a risk of electric shock to persons.</p>	<div style="border: 1px solid black; padding: 5px; margin: 0 auto; width: 80%;"> <p style="text-align: center; margin: 0;">CAUTION</p> <p style="text-align: center; margin: 0;">RISK OF ELECTRIC SHOCK DO NOT OPEN</p> </div> <p>CAUTION: TO PREVENT THE RISK OF ELECTRIC SHOCK, DO NOT REMOVE COVER (OR BACK). NO USER-SERVICEABLE PARTS INSIDE. REFER SERVICING TO QUALIFIED SERVICE PERSONNEL.</p>	 <p>The exclamation point within an equilateral triangle is intended to alert the user to the presence of important operating and maintenance (servicing) instructions in the literature accompanying the appliance.</p>
D3-4-2-1-1_A1_En		

NOTE: THE NO USER-SERVICEABLE PARTS COMPARTMENT WARNING IS LOCATED ON THE APPLIANCE BOTTOM.

IMPORTANT SAFETY INSTRUCTIONS

- | | |
|---|---|
| <ol style="list-style-type: none"> 1) Read these instructions. 2) Keep these instructions. 3) Heed all warnings. 4) Follow all instructions. 5) Do not use this apparatus near water. 6) Clean only with dry cloth. 7) Do not block any ventilation openings. Install in accordance with the manufacturer's instructions. 8) Do not install near any heat sources such as radiators, heat registers, stoves, or other apparatus (including amplifiers) that produce heat. 9) Do not defeat the safety purpose of the polarized or grounding-type plug. A polarized plug has two blades with one wider than the other. A grounding type plug has two blades and a third grounding prong. The wide blade or the third prong are provided for your safety. If the provided plug does not fit into your outlet, consult an electrician for replacement of the obsolete outlet. 10) Protect the power cord from being walked on or pinched particularly at plugs, convenience receptacles, and the point where they exit from the apparatus. | <ol style="list-style-type: none"> 11) Only use attachments/accessories specified by the manufacturer. 12) Use only with the cart, stand, tripod, bracket, or table specified by the manufacturer, or sold with the apparatus. When a cart is used, use caution when moving the cart/apparatus combination to avoid injury from tip-over. <div style="text-align: center; margin: 10px 0;">  </div> <ol style="list-style-type: none"> 13) Unplug this apparatus during lightning storms or when unused for long periods of time. 14) Refer all servicing to qualified service personnel. Servicing is required when the apparatus has been damaged in any way, such as power-supply cord or plug is damaged, liquid has been spilled or objects have fallen into the apparatus, the apparatus has been exposed to rain or moisture, does not operate normally, or has been dropped. |
|---|---|

P1-4-2-2_En

NOTE:

This equipment has been tested and found to comply with the limits for a Class B digital device, pursuant to Part 15 of the FCC Rules. These limits are designed to provide reasonable protection against harmful interference in a residential installation. This equipment generates, uses, and can radiate radio frequency energy and, if not installed and used in accordance with the instructions, may cause harmful interference to radio communications. However, there is no guarantee that interference will not occur in a particular installation. If this equipment does cause harmful interference to radio or television reception, which can be determined by turning the equipment off and on, the user is encouraged to try to correct the interference by one or more of the following measures:

- Reorient or relocate the receiving antenna.
- Increase the separation between the equipment and receiver.
- Connect the equipment into an outlet on a circuit different from that to which the receiver is connected.
- Consult the dealer or an experienced radio/TV technician for help.

D8-10-1-2_A1_En

Information to User

Alterations or modifications carried out without appropriate authorization may invalidate the user's right to operate the equipment.

D8-10-2_A1_En

CAUTION

This product satisfies FCC regulations when shielded cables and connectors are used to connect the unit to other equipment. To prevent electromagnetic interference with electric appliances such as radios and televisions, use shielded cables and connectors for connections.

D8-10-3a_A1_En

FEDERAL COMMUNICATIONS COMMISSION DECLARATION OF CONFORMITY

This device complies with part 15 of the FCC Rules. Operation is subject to the following two conditions: (1) This device may not cause harmful interference, and (2) this device must accept any interference received, including interference that may cause undesired operation.

Product Name: MULTI PLAYER
 Model Number: CDJ-900
 Responsible Party Name: PIONEER ELECTRONICS (USA), INC.
 SERVICE SUPPORT DIVISION
 Address: 1925 E. DOMINGUEZ ST. LONG BEACH, CA 90810-1003, U.S.A.
 Phone: 1-800-421-1404
 URL: <http://www.pioneerelectronics.com>

D8-10-4*_B1_En

This Class B digital apparatus complies with Canadian ICES-003.

D8-10-1-3_A1_En

WARNING

This equipment is not waterproof. To prevent a fire or shock hazard, do not place any container filled with liquid near this equipment (such as a vase or flower pot) or expose it to dripping, splashing, rain or moisture.

D3-4-2-1-3_B_En

WARNING

Before plugging in for the first time, read the following section carefully.

The voltage of the available power supply differs according to country or region. Be sure that the power supply voltage of the area where this unit will be used meets the required voltage (e.g., 230V or 120V) written on the rear panel.

D3-4-2-1-4_A_En

WARNING

To prevent a fire hazard, do not place any naked flame sources (such as a lighted candle) on the equipment.

D3-4-2-1-7a_A_En

VENTILATION CAUTION

When installing this unit, make sure to leave space around the unit for ventilation to improve heat radiation (at least 5 cm at rear, and 5 cm at each side).

WARNING

Slots and openings in the cabinet are provided for ventilation to ensure reliable operation of the product, and to protect it from overheating. To prevent fire hazard, the openings should never be blocked or covered with items (such as newspapers, table-cloths, curtains) or by operating the equipment on thick carpet or a bed.

D3-4-2-1-7b_A_En

Operating Environment

Operating environment temperature and humidity: +5 °C to +35 °C (+41 °F to +95 °F); less than 85 %RH (cooling vents not blocked)

Do not install this unit in a poorly ventilated area, or in locations exposed to high humidity or direct sunlight (or strong artificial light)

D3-4-2-1-7c*_A1_En

If the AC plug of this unit does not match the AC outlet you want to use, the plug must be removed and appropriate one fitted. Replacement and mounting of an AC plug on the power supply cord of this unit should be performed only by qualified service personnel. If connected to an AC outlet, the cut-off plug can cause severe electrical shock. Make sure it is properly disposed of after removal. The equipment should be disconnected by removing the mains plug from the wall socket when left unused for a long period of time (for example, when on vacation).

D3-4-2-2-1a_A1_En

CAUTION

The POWER switch on this unit will not completely shut off all power from the AC outlet. Since the power cord serves as the main disconnect device for the unit, you will need to unplug it from the AC outlet to shut down all power. Therefore, make sure the unit has been installed so that the power cord can be easily unplugged from the AC outlet in case of an accident. To avoid fire hazard, the power cord should also be unplugged from the AC outlet when left unused for a long period of time (for example, when on vacation).

D3-4-2-2-2a_A_En

POWER-CORD CAUTION

Handle the power cord by the plug. Do not pull out the plug by tugging the cord and never touch the power cord when your hands are wet as this could cause a short circuit or electric shock. Do not place the unit, a piece of furniture, etc., on the power cord, or pinch the cord. Never make a knot in the cord or tie it with other cords. The power cords should be routed such that they are not likely to be stepped on. A damaged power cord can cause a fire or give you an electrical shock. Check the power cord once in a while. When you find it damaged, ask your nearest PIONEER authorized service center or your dealer for a replacement.

S002*_En

IMPORTANT NOTICE

THE SERIAL NUMBER FOR THIS EQUIPMENT IS LOCATED ON THE BOTTOM. PLEASE WRITE THIS SERIAL NUMBER ON YOUR ENCLOSED WARRANTY CARD AND KEEP IN A SECURE AREA. THIS IS FOR YOUR SECURITY.

D1-4-2-6-1*_A1_En

When using this product, confirm the safety information shown on the bottom of the unit.

CAUTION

This product is a class 1 laser product classified under the Safety of laser products, IEC 60825-1:2007.

CLASS 1 LASER PRODUCT

D58-5-2-2a_A1_En

This product contains mercury. Disposal of this material may be regulated due to environmental considerations. For disposal or recycling information, please contact your local authorities or the Electronics Industries Alliance : www.eiae.org.

K057_A1_En

WARNING: Handling the cord on this product or cords associated with accessories sold with the product will expose you to chemicals listed on proposition 65 known to the State of California and other governmental entities to cause cancer and birth defect or other reproductive harm.

Wash hands after handling

D36-P5_A1_En



Dear Customer:

Selecting fine audio equipment such as the unit you've just purchased is only the start of your musical enjoyment. Now it's time to consider how you can maximize the fun and excitement your equipment offers. This manufacturer and the Electronic Industries Association's Consumer Electronics Group want you to get the most out of your equipment by playing it at a safe level. One that lets the sound come through loud and clear without annoying blaring or distortion-and, most importantly, without affecting your sensitive hearing.

Sound can be deceiving. Over time your hearing "comfort level" adapts to higher volumes of sound. So what sounds "normal" can actually be loud and harmful to your hearing. Guard against this by setting your equipment at a safe level BEFORE your hearing adapts.

To establish a safe level:

- Start your volume control at a low setting.
- Slowly increase the sound until you can hear it comfortably and clearly, and without distortion.

Once you have established a comfortable sound level:

- Set the dial and leave it there.

Taking a minute to do this now will help to prevent hearing damage or loss in the future. After all, we want you listening for a lifetime.



We Want You Listening For A Lifetime

Used wisely, your new sound equipment will provide a lifetime of fun and enjoyment. Since hearing damage from loud noise is often undetectable until it is too late, this manufacturer and the Electronic Industries Association's Consumer Electronics Group recommend you avoid prolonged exposure to excessive noise. This list of sound levels is included for your protection.

Decibel Level Example

30	Quiet library, soft whispers
40	Living room, refrigerator, bedroom away from traffic
50	Light traffic, normal conversation, quiet office
60	Air conditioner at 20 feet, sewing machine
70	Vacuum cleaner, hair dryer, noisy restaurant
80	Average city traffic, garbage disposals, alarm clock at two feet.

THE FOLLOWING NOISES CAN BE DANGEROUS UNDER CONSTANT EXPOSURE

90	Subway, motorcycle, truck traffic, lawn mower
100	Garbage truck, chain saw, pneumatic drill
120	Rock band concert in front of speakers, thunderclap
140	Gunshot blast, jet plane
180	Rocket launching pad

Information courtesy of the Deafness Research Foundation.



S001_En

Contents

How to read this manual

The names of displays, menus, and buttons in this manual are enclosed in brackets. (e.g. [MASTER] channel, [ON/OFF], [File] menu)

01 Before start

Features	5
----------------	---

02 Before you start

What's in the box.....	7
Discs/files playable on the CDJ-900.....	7

03 Part Names and Functions

Control Panel.....	9
Rear Panel	10
Front Panel.....	10
Main unit display.....	11
Jog dial display section.....	11

04 Connections

Basic style.....	12
Using in combination with rekordbox.....	12
Using other brands of DJ software.....	13
Connections for relay play.....	13

05 Playback

Loading discs.....	14
Loading USB devices.....	14
Using the PRO DJ LINK function	14
Playback.....	15
Setting Cue	16
Setting Loop.....	16
Setting the loop automatically based on the track's tempo (Auto Beat Loop).....	17
Storing cue and loop points.....	17
Operating the jog dial	17
Using the [SLIP] button	18
Operating the CDJ-900 in combination with other devices	18
Using the [BROWSE] button	19
Using the [TAG LIST] button.....	19
Using the [INFO] button	20

06 Changing the settings

Using the [MENU/UTILITY] button.....	21
About the rekordbox software.....	22
About the driver software.....	25
Using other brands of DJ software.....	26

07 Additional information

Troubleshooting	27
Error messages	28
List of icons displayed on the main unit display section	28
Cautions on use	29
Handling discs	29
Disclaimer.....	30
Specifications.....	30

Before start

Features

The CDJ-900 is a multi player for professional DJs, offering the variety of functions, durability and operability required for working in discos and nightclubs.

MULTI MEDIA, MULTI FORMAT

The CDJ-900 can play not only discs (CDs), but also music files recorded on USB devices (flash memory drives and hard disks). Supported music file formats include not only music CD (CD-DA) and MP3 but also AAC, WAV and AIFF.

rekordbox™

The included rekordbox music management software can be used to prepare playlists, cues, loops, hot cues and other data required for DJ play unhurriedly at home ahead of time. This allows you to devote all your attention to DJ play at the disco/nightclub, with total assurance. From acquiring music files to DJ play, all steps in the cycle of the DJ's work can be accomplished smoothly.

rekordbox is an application for managing music files which are used for DJ play with a Pioneer DJ Player (i.e. CDJ-2000, CDJ-900).

Data that has been detected and measured, as well as any points which have been set and stored using rekordbox, can be used in combination with a Pioneer DJ Player (i.e. CDJ-2000, CDJ-900) to achieve outstanding DJ performance.

PRO DJ LINK

Functions include "USB Export" using USB devices (flash memory drives and hard discs) and "rekordbox LINK Export" using the computer on which rekordbox is installed.

❖ USB Export

This function can be used to transfer rekordbox music files and management data using USB devices. This eliminates the need to take your computer to the disco or club.

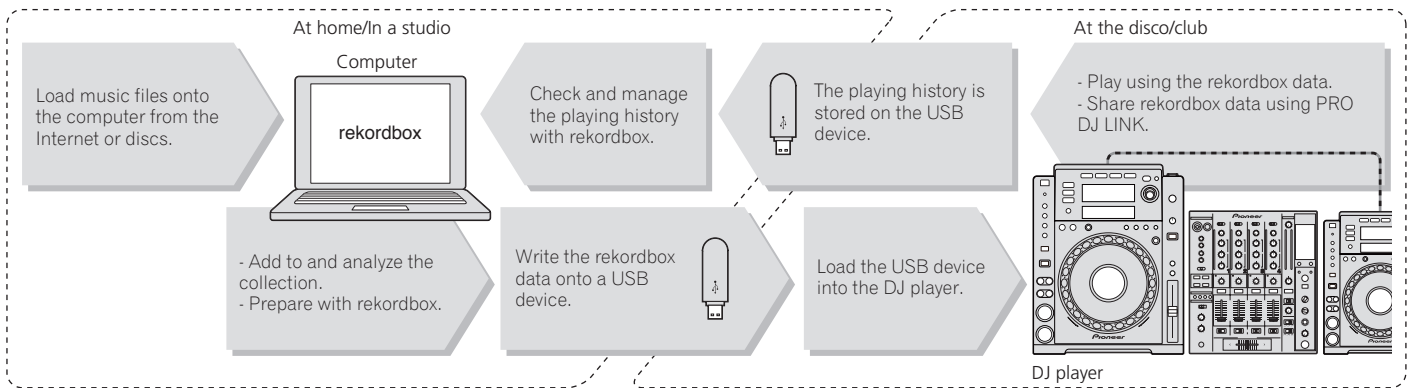

❖ rekordbox LINK Export

When the CDJ-900 and computer are connected by LAN cable, the rekordbox music files and management data can be transferred directly between them. This eliminates the need to export data to USB devices.

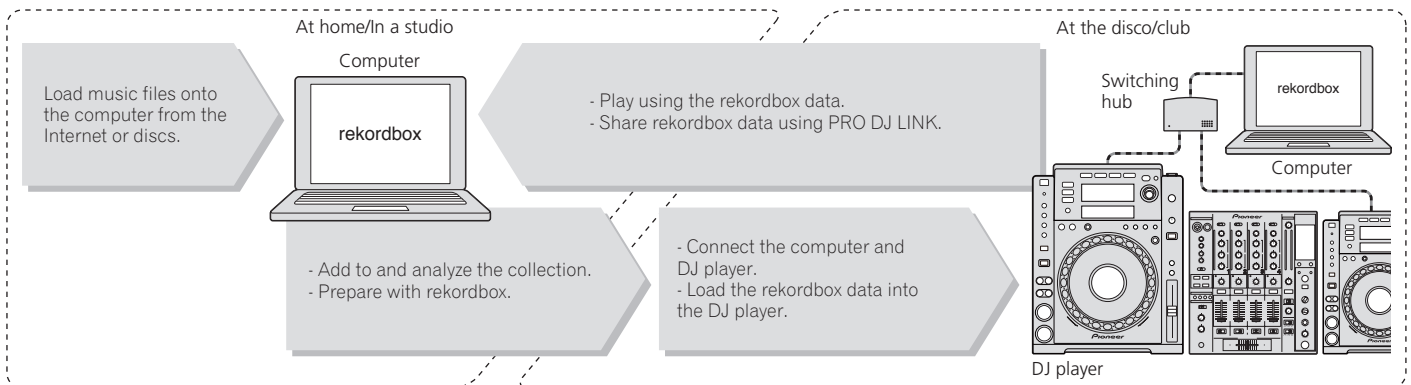

SOUND CARD

The CDJ-900 is equipped with exclusive interface and MIDI interface for controlling the DJ software of other brands. There is also a built-in sound card, so other equipment can be connected easily.

DISPLAY

The combination of a GUI displaying music file information in easily understandable fashion and a rotary selector with easy operation lets you select tracks with no stress.

WAVE DISPLAY

This unit is equipped with a 100 x 7 dot WAVE display.

TAG LIST

In addition to playlists prepared using rekordbox, tracks to be played next can be temporarily collected inside the CDJ-900. The music files added to the tag list can be displayed as a list. This function is extremely convenient for selecting tracks during live performances.

KEYWORD SEARCH

Keyword searching, letter jumping and other functions let you quickly and precisely search for the desired music file.

HISTORY MEMORY

The CDJ-900 is equipped with a history function storing the playing history of music files. Playlists can be created from this playing history using rekordbox.

0.5 FRAME STEP

The minimum frame has evolved from 1 (1/75 seconds) to 0.5 frames. This makes it possible to set the cue and loop points with greater precision to achieve accurate, advanced DJ play.

QUANTIZE

The CDJ-900 is equipped with a quantize function for putting a track on beat even when the button is pressed roughly, as long as the track has been analyzed with rekordbox. When setting real time cues and auto beat loops, the beat is automatically set to the beat nearest the position at which the button was pressed.

HIGH SOUND QUALITY

The CDJ-900 is designed for thorough improvement of the sound quality, for both the digital and analog outputs.

For the digital circuitry, the CDJ-900 is equipped with a high performance Wolfson D/A converter.

For the analog circuitry, a hybrid OP amplifier is used to reduce to the utmost limits that inaudible noise of 20 kHz and higher that can blur the original sound. Unwanted digital noise is shut out to achieve clear, highly transparent sound faithful to the original.

Before you start

What's in the box

- Audio cable
- Power cable
- Control cord
- LAN cable
- Disc force eject pin
- CD-ROM (rekordbox)
- License key
- Warranty card
- Operating instructions (this document)

Discs/files playable on the CDJ-900

Playable discs

Discs including the following marks on the disc label, package or jacket can be played.

Types of discs that can be played and marks



CD



CD-TEXT



CD-R



CD-RW

Discs playable on this player are as shown below.

- CD-R/-RW discs recorded in music CD (CD-DA) format
- CD-R/-RW disc containing music files (MP3/AAC/WAV/AIFF)

❖ Discs that cannot be played

- DTS-CD
- Photo CDs
- Video CDs
- CD Graphics (CD-G) discs
- Unfinalized CDs
- DVD-R/-RW
- DVD+R/+RW
- DVD-R DL (dual layer)
- DVD+R DL (dual layer)
- DVD-Video discs
- DVD-Audio discs
- DVD-RAM discs

❖ Playback of discs created on a computer

Depending on the application's settings and the computer's environment settings, it may not be possible to play discs created on a computer. Record discs in a format playable on the CDJ-900. For details, contact your application's selling agent.

It may not be possible to play discs created on a computer due to the disc's properties, scratches or dirt, or poor recording quality (dirt on the recording lens, etc.). See *Handling discs* on page 29 for instructions on handling discs.

❖ Creating backup discs

When CD-R/-RW discs are paused or left in the pause mode at cue points for long periods of time, it may become difficult to play the disc at that point, due to the properties of the disc. Also, when a specific point is looped repeatedly an extremely large number of times, it may become difficult to play that point. When playing valuable discs, we recommend making backup discs.

❖ Regarding copy protected CDs

This player is designed to conform to the specifications of the audio CD format. This player does not support the playback or function of discs that do not conform to these specifications.

❖ About DualDisc

This player is designed to conform to the specifications of the audio CD format. This player does not support the playback or function of discs that do not conform to these specifications.

❖ About 8 cm single CDs

8 cm single CDs cannot be played on the CDJ-900. Do not mount 8 cm adapters on CDs and play them on the CDJ-900. The adapter could fall off as the disc spins, damaging the disc or the player.

❖ About CD-Text

The CDJ-900 supports CD-Text. Titles, album names and artist names recorded in CD-Text are displayed. When multiple text data is recorded, the first text data is displayed. The supported character codes are shown below.

- ASCII
- ISO-8859
- MS-JIS
- Mandarin Chinese character code

About CD playback

Music files (MP3/AAC/WAV/AIFF) recorded on CD-R/-RW discs can be played.

Folder layers	Max. 8 levels (files in folders beyond the 8th level cannot be played)
Max. number of folders	2 000 folders per disc (folders beyond the 2 000th folder cannot be displayed)
Max. number of files	<ul style="list-style-type: none"> • 999 files for each file format • 3 000 files per disc (files beyond the 3 000th folder cannot be displayed)

When there are many folders or files, some time may be required for loading.

About USB devices

Music files (MP3/AAC/WAV/AIFF) recorded on USB devices can be played. Such data as disc identification information, cue points, loop points and hot cues can be recorded on USB devices.

Folder layers	Max. 8 levels (files in folders beyond the 8th level cannot be played)
Max. number of folders	Unlimited (folders beyond the 10 000th folder within a single folder cannot be displayed)
Max. number of files	Unlimited (files beyond the 10 000th file within a single folder cannot be displayed)
Supported file systems	FAT, FAT32 and HFS+

- The CDJ-900 supports such USB mass storage class USB devices as external hard discs, portable flash memory drives and digital audio players. External DVD/CD drives and other optical disc devices cannot be used.
- When there are many folders or files, some time may be required for loading.
- If multiple partitions are set for the USB device, the device may not be recognized.

❖ Cautions on using USB devices

- Some USB devices may not operate properly. Please note that Pioneer will accept no responsibility whatsoever for loss of data recorded on USB devices.
- USB hubs cannot be used.
- USB devices equipped with flash card readers may not operate.
- If a current above the allowable level is detected in the CDJ-900's USB port, it could happen that a warning message is displayed, the power to the USB device is cut off and signal transfer is stopped. To restore normal operation, remove USB devices connected to the player, then press **USB STOP**. Avoid reusing the USB device for which the excess current was detected. If normal operation is not restored after performing the above operation (if signals are not transferred), try turning off the player's power then turning it back on.
- Depending on the USB device you are using, the desired performance may not be achieved.

About MP3 files

MP3 files can have a constant bit rate (CBR) or a variable bit rate (VBR). Both types of files can be played on the CDJ-900, but the search and super fast search functions are slower with VBR files. If your priority is operability, we recommend recording MP3 files in CBR.

The CDJ-900 supports MP3 files in the formats shown below.

Compatible formats	MPEG-1	Audio Layer-3 sampling frequencies of 32 kHz, 44.1 kHz and 48 kHz, and bit rates of 32 kbps – 320 kbps are supported.
	MPEG-2	Audio Layer-3 sampling frequencies of 16 kHz, 22.05 kHz and 24 kHz, and bit rates of 16 kbps – 160 kbps are supported.
Track information		ID3 tag versions 1.0, 1.1, 2.2, 2.3 and 2.4 are supported. Titles, album names, artist names, etc., are displayed here.
File extension		.mp3

About AAC files

- AAC is the abbreviation of "Advanced Audio Coding", a basic format of audio compression technology used for MPEG-2 and MPEG-4.
- The file format and extension of AAC data depends on the application used to create the data.
- In addition to AAC files encoded with iTunes® and with the extension ".m4a", files with the extensions ".aac" and ".mp4" can also be played on the CDJ-900. However, copyright protected AAC files purchased for example at the iTunes Music Store cannot be played. Also, some files may not be playable, depending on the iTunes version used to encode them.
- The CDJ-900 supports AAC files in the formats shown below.

Compatible formats	MPEG-4 AAC LC	Sampling frequencies of 16 kHz, 22.05 kHz, 24 kHz, 32 kHz, 44.1 kHz and 48 kHz, and bit rates of 16 kpbs – 320 kbps are supported.
Track information	aac	ID3 tag versions 1.0, 1.1, 2.2, 2.3 and 2.4 are supported. Titles, album names, artist names, etc., are displayed here.
	Extensions other than aac	Meta tags (embedded tags) are supported. Titles, album names, artist names, etc., are displayed here.
File extension		.m4a, .aac and .mp4

About WAV files

The CDJ-900 supports WAV files in the formats shown below.

Compatible formats	The 16-/24-bit non-compressed PCM format and sampling frequencies of 44.1 kHz and 48 kHz are supported.
Track information	LST chunk Titles, album names, artist names, etc., are displayed here.
File extension	.wav

About AIFF files

The CDJ-900 supports AIFF files in the formats shown below.

Compatible formats	The 16-/24-bit non-compressed PCM format and sampling frequencies of 44.1 kHz and 48 kHz are supported. Titles, album names, artist names, etc., are displayed here.
File extension	.aif, .aiff

About rekordbox

- rekordbox is an application for managing music files which are used for DJ play with a Pioneer DJ Player (i.e. CDJ-2000, CDJ-900). Data that has been detected and measured, as well as any points which have been set and stored using rekordbox, can be used in combination with a Pioneer DJ Player (i.e. CDJ-2000, CDJ-900) to achieve outstanding DJ performance.
- Install rekordbox from the included CD-ROM onto a computer. For instructions on using rekordbox, see *Using in combination with rekordbox* on page 12 and *About the rekordbox software* on page 22.

Part Names and Functions

Control Panel

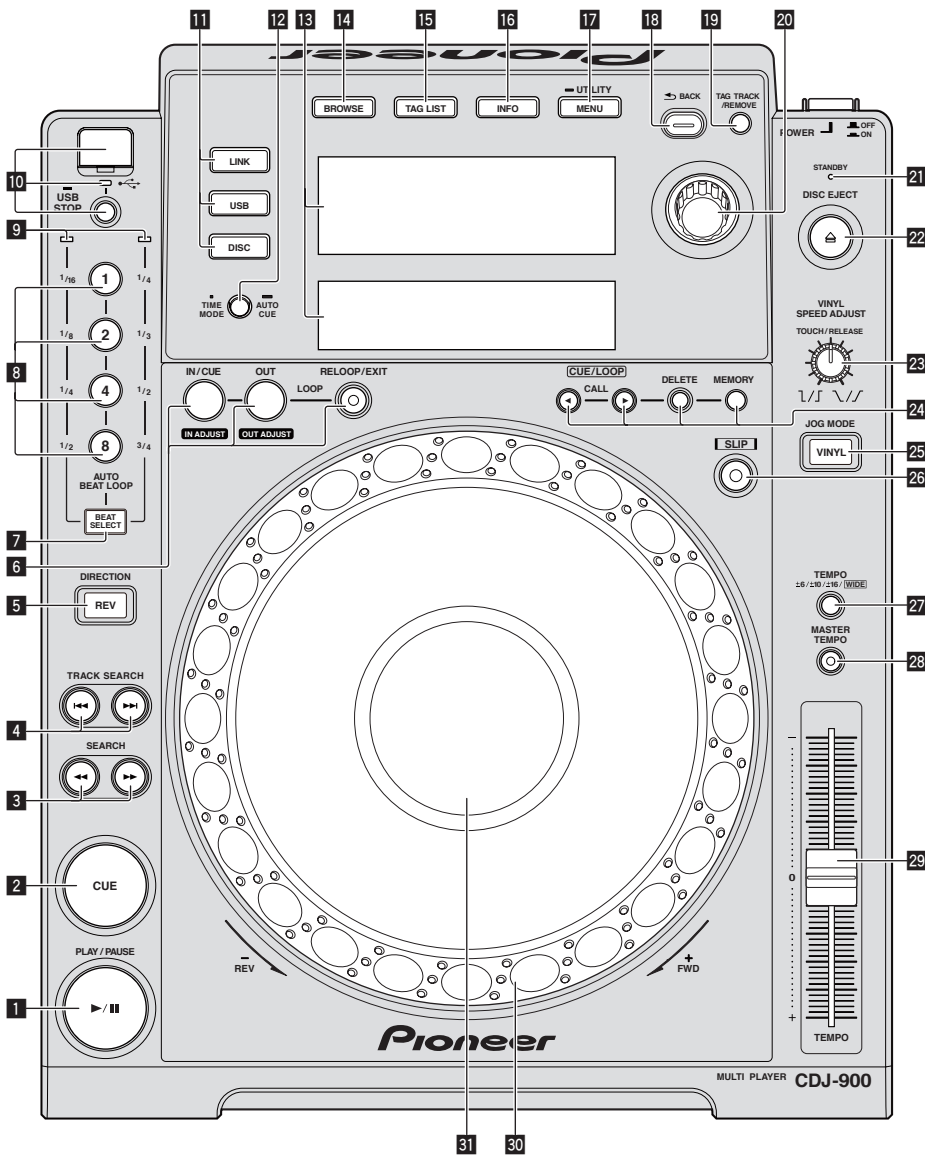

Rear Panel

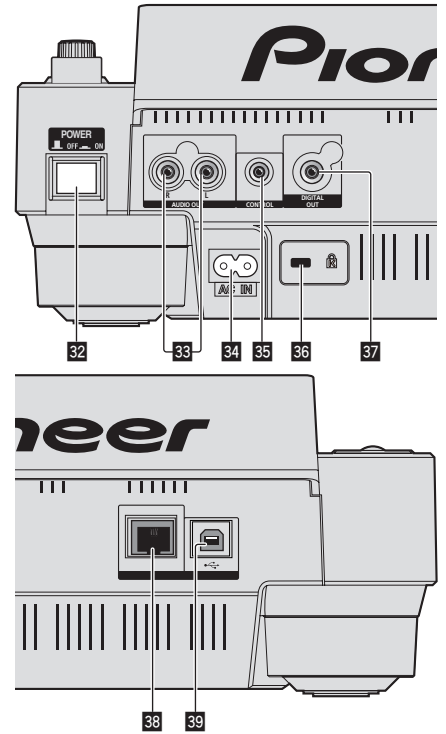

Front Panel

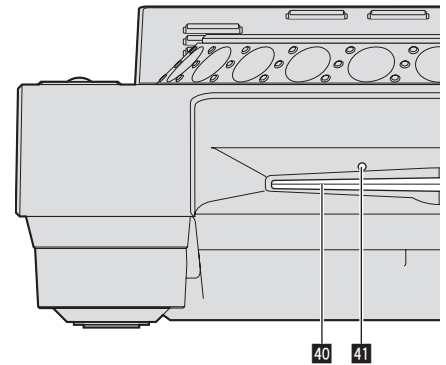

Control Panel

- 1** **PLAY/PAUSE ▶/|| and PLAY/PAUSE ▶/|| indicator (page 15)**
This lights when playing tracks and flashes when in the pause mode.
- 2** **CUE and CUE indicator (page 16)**
This lights when a cue point is set (except during track searching), and flashes when a new cue point can be set in the pause mode.
- 3** **SEARCH ◀◀/▶▶ (page 15)**
- 4** **TRACK SEARCH ◀◀/▶▶ (page 15)**
- 5** **DIRECTION REV and REV indicator (page 15)**
- 6** **LOOP IN/CUE (IN ADJUST) (page 16), LOOP OUT (OUT ADJUST) (page 16), RELOOP/EXIT (page 16)**
- 7** **BEAT SELECT (page 17)**
- 8** **AUTO BEAT LOOP (1, 2, 4, 8) (page 17)**
- 9** **Beat select indicator (page 17)**
The indicator for the row selected by pressing [BEAT SELECT] lights.
- 10** **USB device insertion slot, USB indicator and USB STOP (page 14)**
- 11** **LINK, USB, DISC (page 15)**

- 12** **TIME MODE/AUTO CUE (page 16)**
- 13** **Main unit display (page 11)**
- 14** **BROWSE (page 19)**
- 15** **TAG LIST (page 19)**
- 16** **INFO (page 20)**
- 17** **MENU/UTILITY (page 21)**
- 18** **BACK (page 19)**
- 19** **TAG TRACK/REMOVE (page 19)**
- 20** **Rotary selector**
When selecting tracks or setting items, the cursor moves when the rotary selector is turned. Press the rotary selector to enter.
- 21** **STANDBY indicator (page 21)**
This lights when in the standby mode.
- 22** **DISC EJECT ▲ and DISC EJECT indicator (page 14)**
- 23** **VINYL SPEED ADJUST (page 18)**
- 24** **CUE/LOOP CALL ◀/▶ (page 17), DELETE (page 17), MEMORY (page 17)**

25 JOG MODE, VINYL mode indicator and CDJ mode indicator (page 18)

The mode switches between VINYL and CDJ each time this is pressed. The indicator lights when the VINYL mode is selected.

26 SLIP (page 18)

27 TEMPO ±6/±10/±16/WIDE (page 15)

28 MASTER TEMPO (page 15)

29 TEMPO (page 15)

30 Jog dial (- REV/+ FWD) (page 17)

31 Jog dial display section (page 11)

Rear Panel

32 POWER  ON  OFF

Press to turn the power on and off.

33 AUDIO OUT L/R (page 12)

34 AC IN (page 12)

35 CONTROL (page 18)

36 Kensington security slot

37 DIGITAL OUT

38 LINK (page 12)

39 USB (page 12)

Front Panel

40 Disc insertion slot

41 Disc force eject pin insertion hole

About ejecting discs by force

- If the disc cannot be ejected by pressing [DISC EJECT▲], the disc can be ejected forcibly by inserting the disc force eject pin all the way into the disc force eject pin insertion hole on the main unit's front panel.
- When forcibly ejecting a disc, be sure to do so following the procedure below.

1 Press [POWER] and wait at least 1 minute after the set's power has turned off.

Never forcibly eject a disc directly after turning off the set's power. Doing so is dangerous for the reasons described below.

The disc will still be spinning when ejected and could hit your fingers, etc., causing injury.

Also, the disc clamp will rotate in an unstable way, and the disc could get scratched.

2 Use the included disc force eject pin. (Do not use anything else.)

The included disc force eject pin is mounted on the CDJ-900's bottom panel. When the pin is inserted all the way into the insertion hole, the disc is ejected 5 mm to 10 mm out of the disc insertion slot. Grasp the disc with your fingers and pull it out.

Main unit display

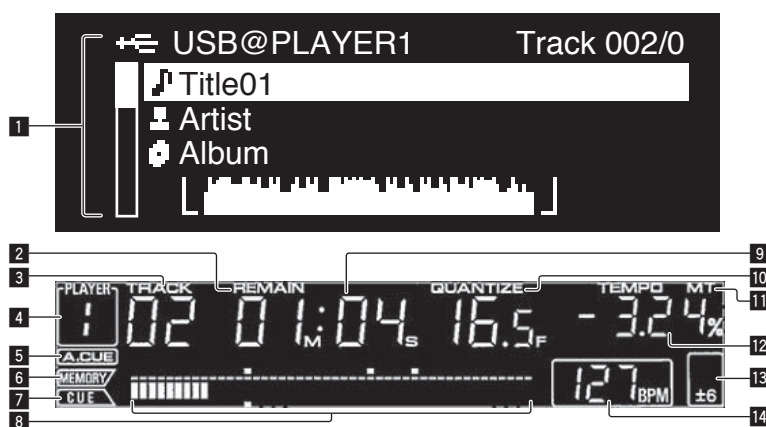

1 Information display section

Up to 63 characters can be displayed for each item. The characters that can be displayed are letters A to Z, numbers 0 to 9 and certain symbols. Any other characters are displayed as "?".

2 REMAIN

This lights when the time display is set to the remaining time.

3 TRACK

This indicates the track number (01 – 99).

4 PLAYER

This indicates the player number (1 – 4) assigned to this CDJ-900.

5 A. CUE (page 16)

This lights when auto cue is set.

6 MEMORY

Cue and loop points recorded on USB devices are displayed as marks.

7 CUE

The positions of currently set cue and loop points are displayed as marks.

8 Playing address display

The track is displayed as a bar graph. When the remaining time is displayed, the display turns off from the left side. The entire graph flashes slowly when there are less than 30 seconds remaining in the track, then begins flashing rapidly when less than 15 seconds remain.

9 Time display (minutes, seconds and frames)

There are 75 frames to a second.

10 QUANTIZE

This lights red when [QUANTIZE] is turned on.

When [QUANTIZE] is turned on, the loop point is automatically set to the beat position nearest the position at which [LOOP IN/CUE (IN ADJUST)], [LOOP OUT (OUT ADJUST)] or [AUTO BEAT LOOP] (1, 2, 4, 8) was pressed. The Quantize function will not work (the indicator is off) under the following conditions:

- When playing tracks recorded on discs
- When playing music files that have not been analyzed with rekordbox
- In the pause mode

11 MT

This lights when the master tempo is set (page 15).

12 Playing speed display

The number changes according to the position of [TEMPO].

13 Playing speed adjustment range display

This indicates the range in which the playing speed can be adjusted with respect to the original playing speed recorded on the medium.

14 BPM

Displays BPM (Beats Per Minute) of the track currently being played.

Jog dial display section

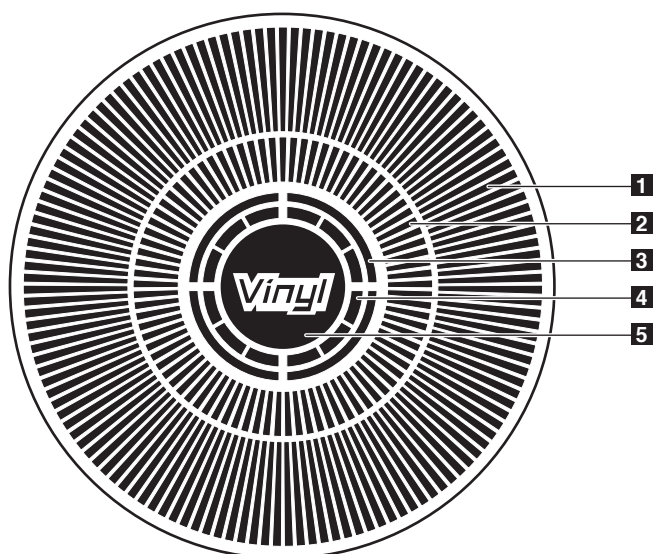

1 Operation display

This indicates the playing position, with one revolution equal to 135 frames. It turns during playback and stops in the pause mode.

2 Cue point display/SLIP play display

3 Audio memory status display

This flashes when the audio memory is being written. It stops flashing, remaining lit, when writing is completed.

The operations below may not be possible while the audio memory is being written.

- Setting Cue Point during playback (Real Time Cue)
- The display also flashes when there is not enough memory due to scratch play.

4 Jog touch detection display

When the jog mode is set to VINYL, the top of the jog dial lights when pressed.

5 VINYL

This lights when the jog mode is set to VINYL (page 17).

Connections

Be sure to turn off the power and unplug the power cord from the power outlet whenever making or changing connections.

Refer to the operating instructions for the component to be connected.

Connect the power cord after all the connections between devices have been completed.

Do not disconnect the LAN cable when music files and/or information are being shared using PRO DJ LINK.

Basic style

- USB devices (flash memory drives and hard disks) can be used to transfer rekordbox music files and data to and from the CDJ-900 without taking a computer into the DJ booth. This makes it possible to play using playlist, cue and loop information that has been set ahead of time using rekordbox.
- The contents of media loaded in DJ players (tracks, cue point memories, WAVE information, etc.) can be shared. For details, see *Using the PRO DJ LINK function* on page 14.
- Up to four units can be connected. A switching hub (commercially available) is required to connect three or more units. Use a switching hub of 100 Mbps or greater. Note that some switching hubs may not operate normally.

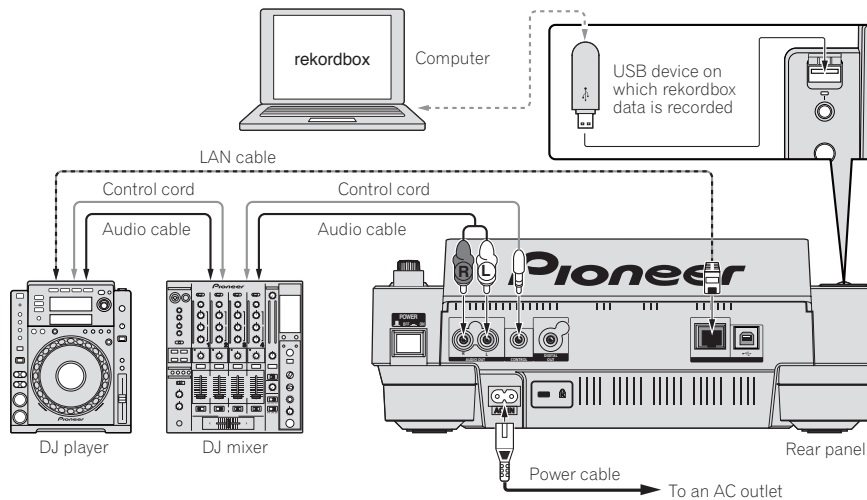

Using in combination with rekordbox

- When connected by LAN cable to a computer on which rekordbox is installed, tracks in rekordbox can be selected and played. For instructions on operating rekordbox on the computer, see the rekordbox manual. Instructions on operating rekordbox can be found in the rekordbox [Help] menu.
- Up to two computers can be connected.
- The contents of media loaded in the different DJ players (tracks, cue point memories, WAVE information, etc.) can be displayed (page 14).
- Up to four units can be connected. A switching hub (commercially available) is required to connect three or more units. Use a switching hub of 100 Mbps or greater. Note that some switching hubs may not operate normally.

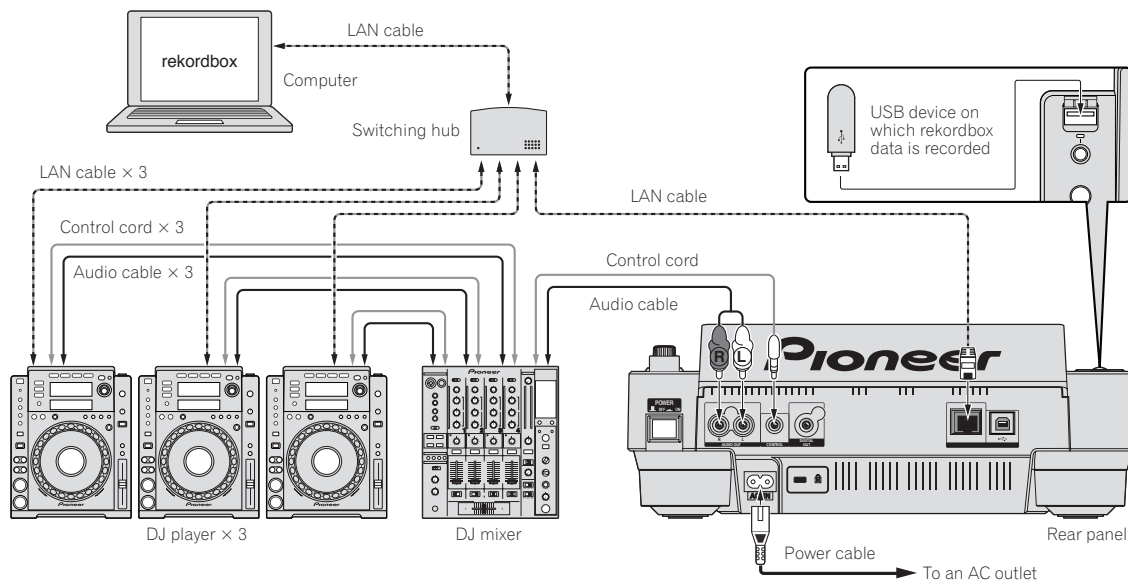

Using other brands of DJ software

With the CDJ-900, the operating information of the buttons, tempo adjustment dial, etc., can also be output in universal MIDI format. When connected by USB cable to a computer on which MIDI-compatible DJ software is installed, the DJ software can be operated from the CDJ-900. The sound of music files being played on the computer can also be output from the CDJ-900. For details, see *About the driver software* on page 25 and *Using other brands of DJ software* on page 26.

- Connect a computer on which Mac OS X (10.4.6 or later), Windows Vista® or Windows® XP is installed.

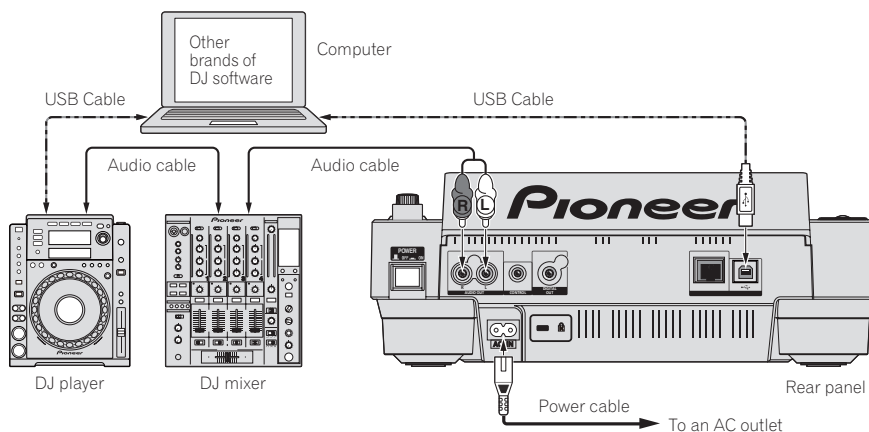

Connections for relay play

Relay play between two DJ players is possible by interconnecting the CDJ-900 and a Pioneer DJ player using the **CONTROL** jacks (page 18).

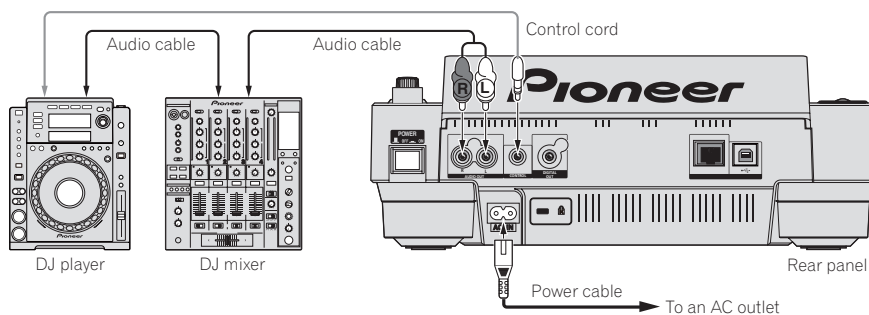

Playback

Loading discs

- Set the disc with the printed side facing up.
- Insert the disc into the disc insertion slot on the set's front panel.
- Do not insert two or more discs at once.
- Do not force discs into the set's disc insertion slot when the set's power is off. Doing so could damage the disc or the set.
- When the disc is being drawn in or ejected, do not apply any force to the disc in the direction opposite its movement. Doing so could damage the disc or the set.

1 Press [POWER].

Turn on the power of this unit.

2 Insert the disc into the disc insertion slot.

Playback starts.

- When auto cue is turned on, playback starts when [PLAY/PAUSE▶/II] is pressed. For details on the auto cue function, see *Setting auto cue* on page 16.

Ejecting discs

Press [DISC EJECT▲].

The disc is ejected from the disc insertion slot.

- If [DISC EJECT▲] is pressed by mistake, press [PLAY/PAUSE▶/II] immediately. The set is restored to the status it was in just before [DISC EJECT▲] was pressed. (No sound is output during this time.)

Loading USB devices

Insert the USB device into the USB port.

The USB indicator lights.

- When a USB device that has previously been loaded in the CDJ-900 or a Pioneer DJ player is loaded, the number of discs for which WAVE information, etc., is recorded is displayed on the main unit display.

Removing USB devices from the set

- Be sure to follow the procedure below when removing USB devices from the set. Removing a USB device without following this procedure could erase the set's management data and make it impossible to read the USB device.
- When turning the set's power off, be sure to remove the USB device first.

1 Press [USB STOP] for over 2 second.

The USB indicator turns off.

2 Disconnect the USB device.

Using the PRO DJ LINK function

When two or more CDJ-900s are connected by LAN cable, tracks recorded on USB devices connected to other players can be loaded onto this unit.

1 Connect this unit and other DJ players using LAN cables.

2 Press [LINK].

Media loaded in another DJ player is displayed on this unit's display.

3 Select the medium and enter.

The medium's contents are displayed.

4 Select the track and enter.

The track is loaded into this unit.

- The information below can be shared among DJ players connected by PRO DJ LINK.

Tracks (music files)
TAG LIST (page 19)
INFO (page 20)
Disc cue points
Disc WAVE displays

Sharing disc information

1 Connect the USB device to the DJ player connected by PRO DJ LINK.

2 Load a disc in the CDJ-900.

When no USB device is connected to this unit, the player number of the DJ player to which the USB device is connected and a check screen are displayed on this unit's display.

3 Press [MEMORY] on this unit.

The information of the disc loaded in this unit is registered on the USB device of the DJ player connected by PRO DJ LINK.

- When multiple DJ players are connected by PRO DJ LINK and USB devices are connected to two or more DJ players, discs are not registered in DJ players other than this one.
- If [DELETE] is pressed in step 3, the disc information is not registered on any DJ player. Disc information is not registered in any DJ player until a USB device is connected to this unit (the DJ player in which the disc is loaded). To register the disc information, press [DISC], then press [MENU/UTILITY] and select the player in which the information is to be registered.

Browsing libraries and folders

The browsing display differs depending on whether or not library information is recorded on the USB device.

- With library information → Library browsing: The music files are displayed by the categories set in rekordbox (album, artist, etc.).
- Without library information → Folder browsing: The folders/tracks on the medium are displayed with a tree structure.

The types of items on the category menu can be changed in rekordbox's preferences (environmental settings).

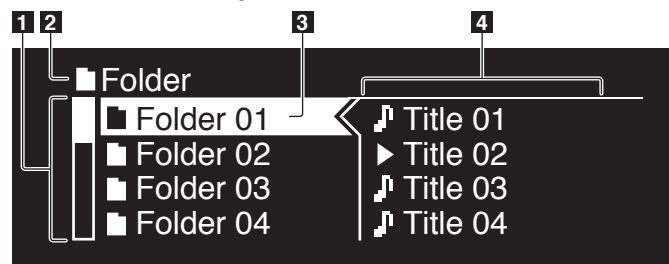

1 List of contents	The contents of the selected medium are displayed.
2 Uppermost level	Displays the name of the upper folder or media of the displayed item.
3 Cursor	Turn the rotary selector to move the cursor up and down.
4 Contents of selected item	The contents of the line selected with the cursor are displayed.

Playback

1 Load the medium in this unit.

2 Press [DISC], [USB] or [LINK].

The contents of the selected medium are displayed.

3 Turn the rotary selector.

Select the track. The category/folder/track information is displayed.

- Once the lowermost level in the folder is reached, press the rotary selector. Press [BACK] to return to the uppermost level.
- Press [BACK] for over 1 second or press the media button of the medium you are browsing to return to the uppermost level.

4 Press the rotary selector.

The track is loaded and playback begins.  is displayed to the left of the currently playing track.

- [TRACK SEARCH<</>>] can be used to select tracks within the currently playing track's category/folder.
- When a disc containing music files recorded with a hierarchical structure is loaded, playback starts from the tracks in the uppermost level.

Pausing

During playback, press [PLAY/PAUSE>/II].

The **PLAY/PAUSE>/II** and **CUE** indicators flash. Press [PLAY/PAUSE>/II] again to resume playback.

- If no operation is performed for 100 minutes while in the pause mode, the disc automatically stops spinning. When [PLAY/PAUSE>/II] is pressed at this time, playback resumes from the first track. When auto cue is turned on, the set cues to the first track and pauses there.

❖ Resuming playback from the position playing just before the disc was ejected (Resume)

- After a disc is ejected, if that same disc is immediately reloaded in the CDJ-900, playback resumes from the position playing just before the disc was ejected.
- The resume function only works when the same disc is ejected then reloaded before loading another disc.
- When [TRACK SEARCH<</>>] is pressed before starting playback, the set searches for the beginning of the track and playback starts.
- The resume function does not work for USB devices.

Forward and reverse scanning

Press [SEARCH<</>>].

When [SEARCH<</>>] pressed and held in, the track is fast-forwarded or fast-reversed.

- When the music files are recorded in a folder structure, only tracks within the same category/folder are fast-forwarded/fast-reversed.

Finding the beginnings of tracks (Track Search)

Press [TRACK SEARCH<</>>].

Press the [▶▶] to move to the beginning of the next track.

When [◀◀] is pressed, the beginning of the currently playing track is searched.

When pressed twice consecutively, the set returns to the beginning of the previous track.

- When the music files are recorded in a folder structure, only tracks within the same category/folder are searched.
- When auto cue is turned on, the set searches for the beginning of the track and pauses there (page 16).

Adjusting the playing speed (Tempo control)

Move [TEMPO] up or down.

The tempo increases when moved to the [+] side (down), decreases when moved to the [-] side (up). The rate at which the playing speed is changed is indicated on the playing speed display.

❖ Selecting the range for adjusting the playing speed

Press [TEMPO ±6/±10/±16/WIDE].

The range of adjustment of the [TEMPO] control switches each time the button is pressed. The adjustment range setting is indicated on the playing speed adjustment range display.

- The tempo can be adjusted in units of 0.02 % when set to ±6 %, in steps of 0.05 % when set to ±10 %, in steps of 0.05 % when set to ±16 %, and in steps of 0.5 % when set to **WIDE**.
- The adjustment range is ±100 % when set to **WIDE**. When set to -100 %, playback stops.
- The adjustment range is set to ±10 % when the power is turned on.

Adjusting the playing speed without changing the pitch (Master Tempo)

Press [MASTER TEMPO].

The **MASTER TEMPO** indicator and [MT] on the main unit display light. The pitch does not change even when the playing speed is changed with the [TEMPO] control.

- The sound is digitally processed, so the sound quality decreases.

Playing in reverse

Press [REV].

The **REV** indicator lights and the track plays in the reverse direction.

- When the music files are recorded in a folder structure, only tracks within the same category/folder can be played in reverse. Also note that reverse playback may not start immediately.
- The direction in which the playing speed is increased or decreased according to the direction in which the jog dial is turned is reversed.
- When such operations as track searching and loop playback are performed during reverse playback, the audio memory status display on the jog dial display section flashes and scratch play may not be possible.

Setting Cue

1 During playback, press [PLAY/PAUSE▶/II].

Playback is paused.

2 Press [CUE].

The point at which the track is paused is set as the cue point. The CUE indicator lights and the PLAY/PAUSE▶/II indicators flashes. No sound is output at this time.

- When a new cue point is set, the previously set cue point is canceled.
- For instructions on saving cue points. see *Storing cue and loop points* on page 17.

Adjusting the cue point position

1 Press [SEARCH◀◀/▶▶] while pausing at the cue point.

The CUE and PLAY/PAUSE▶/II indicators flash.

2 Press [SEARCH◀◀/▶▶].

The cue point can be fine-adjusted in steps of 0.5 frames.

- The same operation is possible using the jog dial.

3 Press [CUE].

The point at which the button was pressed is set as the cue point.

- When a new cue point is set, the previously set cue point is canceled.
- When the medium containing the track is removed, the cue point is canceled. For instructions on saving cue points. see *Storing cue and loop points* on page 17.

Returning to Cue Point (Back Cue)

During playback, press [CUE].

The set immediately returns to the currently set cue point and pauses.

- When [PLAY/PAUSE▶/II] is pressed, playback starts from the cue point.

Checking Cue Point (Cue Point Sampler)

Press and hold [CUE] after returning to the cue point.

Playback starts from the currently set cue point. Playback continues while [CUE] is pressed in.

- When the music files are recorded in a folder structure, the cue point can only be checked for tracks within the same category/folder.

Setting Cue Point during playback (Real Time Cue)

During playback, press [LOOP IN/CUE (IN ADJUST)] at the position at which you want to set the cue point.

The point at which the button was pressed is set as the cue point.

Setting auto cue

When a track is loaded or the track search operation is performed, the silent section at the beginning of the track is skipped and the cue point is automatically set at the point immediately before the sound starts.

Press [TIME MODE/AUTO CUE] for over 1 second.

Auto cue is turned on. [A. CUE] lights on the main unit display.

- The auto cue level setting remains in the memory, even when the power is turned off.

Changing the auto cue level

The sound pressure level for identifying a section as silent can be selected from among the following eight steps:

-36 dB, -42 dB, -48 dB, -54 dB, -60 dB, -66 dB, -72 dB and -78 dB

- The auto cue level setting remains in the memory, even when the power is turned off.
- There are two ways to change the auto cue level, as shown below.

❖ Changing procedure - [MENU/UTILITY]

1 Press [MENU/UTILITY] for over 1 second.

The [UTILITY] screen is displayed.

2 Select [AUTO CUE LEVEL] and enter.

3 Turn the rotary selector.

The auto cue level setting changes.

❖ Changing procedure - [TIME MODE/AUTO CUE]

1 Press [TIME MODE/AUTO CUE] for at least 5 seconds.

The auto cue level setting changing mode is set.

2 Press [CUE/LOOP CALL◀/▶].

The auto cue level setting changes.

- To cancel the changing mode, press [TIME MODE/AUTO CUE] again.

Setting Loop

1 During playback, press [LOOP IN/CUE (IN ADJUST)] at the position at which you want to start looping (the loop in point).

Loop In Point is set.

- This operation is not necessary if you have already set a Cue Point as a Loop In Point.

2 Press [LOOP OUT (OUT ADJUST)] at the position at which you want to stop looping (the loop out point).

The Loop Out Point is set, and Loop playback starts from the Loop In Point.

- When playing music files, looping can only be set within the same track.

Fine-adjusting the loop in point (loop in adjust)

1 During loop playback, press [LOOP IN/CUE (IN ADJUST)].

[LOOP IN/CUE (IN ADJUST)] switches to a fast flashing and [LOOP OUT (OUT ADJUST)] turns off.

The loop in point's time is displayed on the main unit display.

2 Press [SEARCH◀◀/▶▶].

The loop in point can be adjusted in units of 0.5 frames.

- The same operation is possible using the jog dial.
- The loop in point can be adjusted by ± 30 frames and must be in front of the loop out point.

3 Press [LOOP IN/CUE (IN ADJUST)].

- Normal loop playback resumes.
- Normal loop playback also resumes if no operation is performed for over 10 seconds.
- When playing music files, the loop in point can only be adjusted within the same track.

Fine-adjusting the loop out point (loop out adjust)

1 During loop playback, press [LOOP OUT (OUT ADJUST)].

[LOOP OUT (OUT ADJUST)] switches to a fast flashing and [LOOP IN/CUE (IN ADJUST)] turns off.

The loop out point's time is displayed on the main unit display.

2 Press [SEARCH◀◀/▶▶].

The loop out point can be adjusted in units of 0.5 frames.

- The same operation is possible using the jog dial.
- The loop out point adjustment range is anywhere after the loop in point.

3 Press [LOOP OUT (OUT ADJUST)].

Normal loop playback resumes.

- Normal loop playback also resumes if no operation is performed for over 10 seconds.
- When playing music files, the loop out point can only be adjusted within the same track.

Canceling Loop playback (Loop Exit)

During loop playback, press [RELOOP/EXIT].

Playback continues after the Loop Out Point without returning to the Loop In Point.

Returning to Loop playback (Reloop)

After canceling loop playback, press [RELOOP/EXIT] during playback.

Playback returns to the previously set Loop In Point, and Loop playback resumes.

Cutting loops (Loop Cut)

During loop playback, press [SEARCH◀◀] while pressing [LOOP OUT (OUT ADJUST)].

The loop playing time is cut in half each time the button is pressed.

Extending loops

During loop playback, press [SEARCH▶▶] while pressing [LOOP OUT (OUT ADJUST)].

The loop playing time is doubled each time the button is pressed.

- The same operation can be performed as described below. Turn the jog dial while pressing [LOOP OUT (OUT ADJUST)].

Setting the loop automatically based on the track's tempo (Auto Beat Loop)

1 Press [BEAT SELECT].

Set the number of beats for loop playback. This operation is not necessary when selecting 1-beat, 2-beat, 4-beat or 8-beat loop playback.

- 1/4-beat, 1/3-beat, 1/2-beat and 3/4-beat: Press [BEAT SELECT] for over 1 second.
- 1/16-beat, 1/8-beat, 1/4-beat and 1/2-beat: Press [BEAT SELECT] once.

2 In the play or pause mode, press one of the [AUTO BEAT LOOP] buttons (1, 2, 4 or 8) at the point at which you want to set the loop.

The pressed button flashes, the loop out point is set automatically according to the track's tempo (BPM) and the number of beats set in step 1, and loop playback begins.

- When one of the [AUTO BEAT LOOP] buttons (1, 2, 4 or 8) is pressed again during auto beat looping, the loop out point is automatically reset according to the track's tempo (BPM) and the number of beats of the button that was pressed, and loop playback begins.

Storing cue and loop points

1 Load a USB device in the CDJ-900.

2 Set Cue Point or Loop Point.

3 Press [MEMORY].

[MEMORY] appears on the main unit display. The stored cue point appears on the playing address display. The point information is registered on the USB device.

- To store loop points, press [MEMORY] during loop playback. The stored loop points appear on the playing address display.
- The  icon is displayed to the left of tracks for which cue or loop points are saved.

Calling out saved cue or loop points

1 Load a USB device in the CDJ-900.

2 Load the track whose cue or loop points you want to call out.

Cue and loop points are displayed as marks on the playing address display.

3 Press [CUE/LOOP CALL◀/▶].

Playback is moved to the selected point and paused.

- When multiple points are recorded, the point moves each time the button is pressed.

4 Press [PLAY/PAUSE▶/II].

Playback starts from the Cue or Loop point.

Deleting cue or loop points individually

1 Load a USB device in the CDJ-900.

2 Load the track containing the cue point or loop points you want to delete.

Cue and loop points are displayed as marks on the playing address display.

3 Press [CUE/LOOP CALL◀/▶].

Playback is moved to the selected point and paused.

- When multiple points are recorded, the point moves each time the button is pressed.

4 Press [DELETE].

[◀◀ DELETE] is displayed on the main unit display and the selected point information is deleted.

Deleting all cue and loop points for a disc

1 Load a USB device in the CDJ-900.

Cue and loop points are displayed as marks on the playing address display.

2 Press [DELETE] for at least 5 seconds.

[DISC CUE/LOOP DATA-DELETE? PUSH MEMORY] appears on the main unit display.

3 Press [MEMORY].

All cue and loop points for the disc currently loaded in the CDJ-900 are deleted.

- The deletion mode is canceled when any button other than [MEMORY] is pressed.

Deleting all disc information recorded on the USB device

1 With no disc loaded in the CDJ-900, press [DELETE] for at least 5 seconds.

[DISC CUE/LOOP DATA-DELETE ALL? PUSH MEMORY] appears on the main unit display.

2 Press [MEMORY].

All the disc information recorded on the USB device is deleted.

- The deletion mode is canceled when any button other than [MEMORY] is pressed.

Operating the jog dial

The top of the jog dial has an embedded switch. Do not place objects on the jog dial or subject it to strong forces. Also note that water or other liquids getting into the set will lead to malfunction.

The jog dial has two modes.

- VINYL mode: When the top of the jog dial is pressed during playback, playback stops, and when the jog dial is spun at this time sound is produced according to the direction in which the jog dial is spun.
- CDJ mode: When the top of the jog dial is pressed, playback stops, and such operations as scratch play are not possible.

Frame search [VINYL·CDJ]

In the pause mode, spin the jog dial.

The position at which the track is pausing can be moved in units of 0.5 frames.

- The position is moved in the direction of playback when the jog dial is spun clockwise, in the reverse direction when it is spun counterclockwise. The position moves 135 for one revolution of the jog dial.

Super fast search [VINYL·CDJ]

Spin the jog dial while pressing in [SEARCH◀◀/▶▶].

The track is fast-forwarded/fast-reversed in the direction in which the jog dial is spun.

- When the [SEARCH◀◀/▶▶] button is released, this function is canceled.
- When you stop the jog dial from spinning, normal playback resumes.
- The fast-forward/fast-reverse speed can be adjusted according to the speed at which the jog dial is spun.

❖ Super fast track search

When the jog dial is spun while pressing in [TRACK SEARCH◀◀/▶▶], the track advances at high speed in the direction in which the jog dial is spun.

Pitch bend [VINYL·CDJ]

During playback, spin the outer section of the jog dial.

The playing speed increases when spun clockwise, decreases when spun counterclockwise. When spinning is stopped, playback returns to the normal speed.

- When the jog mode is set to the CDJ mode, the same operation can be performed by spinning the top of the jog dial.

Scratch play [VINYL]

When the jog mode is set to the VINYL mode, tracks can be played according to the direction and speed at which the jog dial is spun by spinning the top of the jog dial while pressing it.

1 Press [JOG MODE VINYL].

Set the jog mode to VINYL.

2 During playback, press the top of the jog dial.

Playback slows then stops.

3 Spin the jog dial in the desired direction and at the desired speed.

The sound is played according to the direction and speed at which the jog dial is spun by spinning the top of the jog dial while pressing it.

4 Release your hand from the top of the jog dial.

Normal playback resumes.

❖ Adjusting the speed at which playback slows then stops when the top of the jog dial is pressed and the speed at which playback returns to normal when the top of the jog dial is released.

Turn [VINYL SPEED ADJUST TOUCH/BRAKE].

The speed increases when turned clockwise, decreases when turned counterclockwise.

- When the jog mode set to the VINYL mode, the speed at which playback starts and stops when [PLAY/PAUSE▶/II] is pressed changes simultaneously.

Using the [SLIP] button

When [SLIP] is set to on, normal playback with the original rhythm continues in the background during scratch play, loop play and reverse play. When scratch play, loop play or reverse play is canceled, normal playback resumes from the position playing in the background at that time.

Slip scratch play [VINYL]

1 Press [JOG MODE VINYL].

Set the jog mode to VINYL.

2 Press [SLIP].

The mode switches to the slip mode.

3 During playback, press the top of the jog dial.

The scratch play mode is set.

Normal playback continues in the background during scratch play. The **SLIP** indicator flashes in beat with the sound playing in the background. The position playing in the background is shown on the jog dial's **SLIP** play display.

- The slip loop and slip reverse operations cannot be performed during slip scratch play.

4 Release your hand from the top of the jog dial.

Normal playback of the sound that was playing in the background resumes.

- To cancel the slip mode, press [SLIP] again.

Slip looping

1 Press [SLIP].

The mode switches to the slip mode.

2 Press [LOOP IN/CUE (IN ADJUST)], then press [LOOP OUT (OUT ADJUST)].

Loop playback starts.

Normal playback continues in the background during looping. The **SLIP** indicator flashes in beat with the sound playing in the background. The position playing in the background is shown on the jog dial's **SLIP** play display.

- Loops of over 8 seconds cannot be set.

3 Press [RELOOP/EXIT].

Looping is canceled, and normal playback of the sound that was playing in the background resumes.

- To cancel the slip mode, press [SLIP] again.

Auto beat slip looping

1 Press [SLIP].

The mode switches to the slip mode.

2 Press one of the [AUTO BEAT LOOP] buttons (1, 2, 4 or 8).

The loop is set automatically and loop playback begins.

Normal playback continues in the background during looping. The **SLIP** indicator flashes in beat with the sound playing in the background. The position playing in the background is shown on the jog dial's **SLIP** play display.

3 Press [RELOOP/EXIT].

Normal playback of the sound that was playing in the background resumes.

- To cancel the slip mode, press [SLIP] again.

Slip reverse

1 Press [SLIP].

The mode switches to the slip mode.

2 During playback, press [REV].

The **REV** indicator lights and the track plays in the reverse direction.

Normal playback continues in the background during reverse playback. The **SLIP** indicator flashes in beat with the sound playing in the background. The position playing in the background is shown on the jog dial's **SLIP** play display.

- Slip reverse play is automatically canceled after 8 beats have elapsed from the position at which [REV] was pressed. Normal playback of the sound that was playing in the background resumes.
- If [REV] is pressed again before 8 beats have elapsed, slip reverse play is canceled and normal playback of the sound that was playing in the background resumes.
- To cancel the slip mode, press [SLIP] again.

Operating the CDJ-900 in combination with other devices

Starting playback using a DJ mixer's fader (Fader Start)

1 Connect the CDJ-900 with a Pioneer DJ mixer using the included control cord.

For instructions on connecting, see *Basic style* on page 12.

2 Move the DJ mixer's channel fader or cross fader.

The DJ player's pause mode is canceled and the track is played instantaneously. Also refer to the operating instructions of the connected DJ mixer.

- When the channel fader or cross fader is set back to its original position, playback cues back to the set cue point and the pause mode is set (Back Cue).

Relay play on two DJ players

1 Connect the CDJ-900 and a DJ mixer.

For instructions on connecting, see *Connections for relay play* on page 13.

2 Set the DJ mixer's cross fader to the center position.

3 Turn auto cue on for both DJ players.

The DJ players' auto cue indicators light.

4 Start playback on this unit.

The first track on this unit is played, and once it finished playback begins automatically on the other DJ player. This unit cues to the beginning of the next track and pauses. This operation is repeated for relay play between the two DJ players.

- The medium can be changed and the cue point set on the DJ player that is in standby.
- If the power of one DJ player is turned off during playback, playback may start on the other DJ player.
- The fader start function does not work during relay play.
- Relay play may not be possible if the two DJ players are not connected to the same DJ mixer.

Using the [BROWSE] button

Rearranging tracks (Sort menu)

When in the library browse mode, the tracks can be rearranged using the Sort menu. (The Sort menu is not displayed when in the folder browse mode.)

1 Press [MENU/UTILITY] while the tracks are displayed.

The Sort menu is displayed to the right of the information display screen.

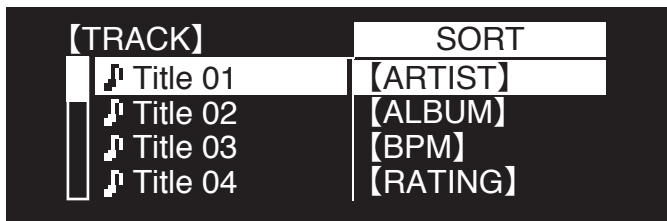

2 Select and enter the setting item.

The tracks are sorted according to the selected item. The track information is displayed.

- Sorting is canceled when [BACK] is pressed to return to the uppermost level.
- The types of sorting items on the Sort menu can be changed in the rekordbox preferences (environmental settings).

Searching for tracks (SEARCH)

- The search function can be used to search for tracks recorded on the media loaded in the set with [SEARCH].
- Tracks recorded on discs cannot be searched.
- Tracks recorded on media for which library browsing is not possible cannot be searched.

1 Select [SEARCH] and enter the setting item.

The character input screen appears.

2 Using the rotary selector to input characters.

Tracks including the character you have input are displayed.

- When more characters are input at this point, tracks starting with the character string you have input are displayed.
- When [BACK] is pressed, the category screen reappears.

Using the jump function

The jump function can be used to instantaneously move to the track, category or folder you want to play.

The jump function includes the two modes below.

- Letter jumping: Use this when the tracks are arranged or sorted in alphabetical order.
- Page jumping: Use this when the tracks are not arranged or sorted in alphabetical order. Turn the rotary selector to jump by page.

❖ In the letter jump mode

1 Press the rotary selector for at least 1 second.

The letter jump mode is set. The first letter of the selected track is displayed at the top left.

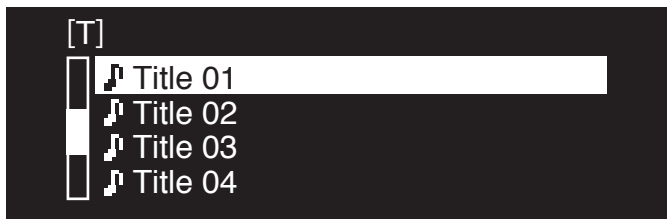

2 Select the character or symbol to which you want to jump and enter.

The display moves to the category starting with the selected character or symbol.

- The characters that can be displayed are letters A – Z, numbers 0 – 9 and symbols.

❖ In the page jump mode

1 Press the rotary selector for at least 1 second.

The mode switches to the page jump mode.

2 Select the page to which you want to jump and enter.

The display moves to the selected page.

Checking the playing history (HISTORY)

- The track playing history is recorded and displayed at [HISTORY].
- Playlists can be created based on the playing history at [HISTORY] using rekordbox. For details, see rekordbox's operating instructions.

1 Load a USB device in the CDJ-900.

2 Playing tracks.

The currently playing track is recorded and displayed at [HISTORY].

- When a USB device, etc., is connected to the CDJ-900 for the first time or reconnected, the new [HISTORY] is automatically created on the USB device.
- A warning message is displayed if there is not enough free space on the USB device, etc., or if the device is write-protected.
- The name of [HISTORY] can be preset at [UTILITY] (page 21).
- When a track already recorded in [HISTORY] is played again after playing a different track, it is newly recorded in [HISTORY].
- The maximum number of tracks that can be recorded in [HISTORY] is 999. When a 1 000th track is recorded, the oldest item in the playing history is deleted.

❖ Deleting [HISTORY]

1 While [HISTORY] is selected, press [MENU/UTILITY].

The delete menu is displayed.

2 Select the range to be deleted and enter.

- [DELETE]: The [HISTORY] item selected with the cursor is deleted.
- [ALL DELETE]: The entire [HISTORY] is deleted.
- The [HISTORY] is deleted when [HISTORY] is converted into a playlist using rekordbox.

Using the [TAG LIST] button

Up to 60 tracks to be played next or tracks selected for specific DJ scenes can be preset in the tag list.

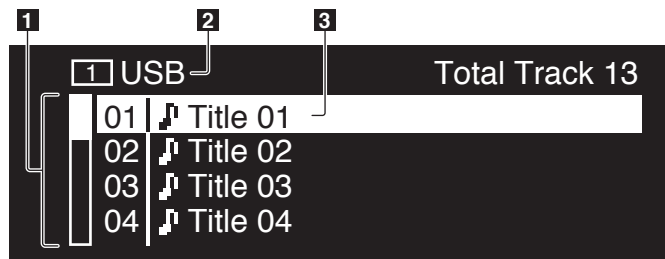

1 List of contents	The contents of the tag list are displayed here.
2 Medium name	The name of the medium on which the track is recorded is displayed here.
3 Cursor	Turn the rotary selector to move the cursor up and down.

Adding tracks to the tag list

Select the track, then press [TAG TRACK/REMOVE].

✓ is displayed to the left of the track.

- The number of tracks that can be added to the tag list is 60 tracks per medium. If you attempt to add a 61st track, a warning message is displayed and the track cannot be added. (There is no limit to the number of tracks when a computer on which rekordbox is installed is connected.)
- Tracks can be recorded in the tag list ahead of time using rekordbox.
- When multiple DJ players are connected by PRO DJ LINK, the same tag list contents are displayed on all DJ players.
- When [TAG TRACK/REMOVE] is pressed while the information is displayed after pressing [INFO], the tracks loaded in this unit are added to the tag list.

❖ Adding categories or folders to the tag list

With the list of the tracks displayed on the right side of the information display screen, press [TAG TRACK/REMOVE].

The category name/folder name flashes, and the tracks in that category/folder are added to the tag list.

- When a category/folder including tracks already added to the tag list is selected and [TAG TRACK/REMOVE] is pressed, only the tracks not already on the tag list are added.
- When a folder is added while in the folder browse mode, the track names are registered as file names. The artist names are not registered.

❖ Adding playlists to the tag list

With the list of the tracks displayed on the right side of the information display screen, press [TAG TRACK/REMOVE].

The playlist name flashes, and the tracks in that playlist are added to the tag list.

- When a playlist including tracks that have already been added to the tag list is selected and [TAG TRACK/REMOVE] is pressed, only the tracks that were not previously added to the tag list are added.

Loading tracks from the tag list

1 Press [TAG LIST].

The tag list is displayed.

2 Select the track to be loaded and enter.

The track is loaded and playback starts.

Removing tracks from the tag list

1 Press [TAG LIST].

The tag list is displayed.

2 Select the track to be removed from the tag list, then press [TAG TRACK/REMOVE] for at least 1 second.

The track is removed from the tag list.

- If a track that has been added to the tag list is removed from the tag list while it is playing, the track is played to the end, then the stop mode is set. The next track is not played.
- When a medium is removed from the CDJ-900, all the tracks recorded on that medium are removed from the tag list.

Using the [INFO] button

The details of the tracks loaded in the CDJ-900 can be checked by pressing [INFO]. When DJ players are connected by PRO DJ LINK, the details of the tracks loaded in the other DJ players can also be checked.

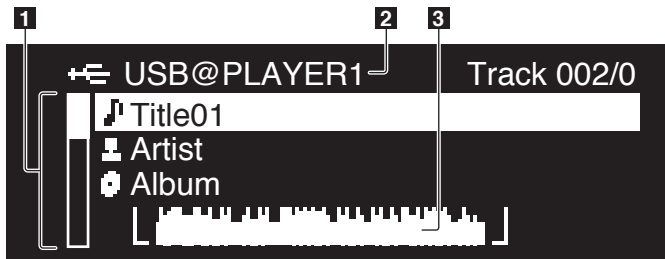

1 Track details

The details of the tracks loaded in the DJ player are displayed here. Other details ([BPM], etc.) can be displayed by turning the rotary selector.

2 Medium/player number

The place where the track information is stored is displayed here.

3 WAVE display

The WAVE display is shown here.

Checking the details of loaded tracks

While the track is playing, press [INFO].

The track's details are displayed.

Displaying details of tracks loaded in other DJ players

1 Connect this unit and the other DJ players by PRO DJ LINK.

2 Press [INFO], then press [MENU/UTILITY].

The [Link Info] screen appears.

3 Select the DJ player and enter.

The details of the tracks loaded in the selected DJ player are displayed.

- If no tracks are loaded in the selected DJ player, no details are displayed.

Using the information jump function

This function can be used to select items displayed in the details and move them to the category, etc., in which a track is included.

1 Display the track details.

2 Select and enter the setting item.

The library browse mode for the selected item is set.

- It may not be possible to select some items.
- When a track is selected, it is moved to the category in which the track was loaded.
- It is not possible to move items from the disc's details to tracks loaded in a DJ player connected by PRO DJ LINK.
- When an item for which only an icon is displayed is selected, that icon is moved to the corresponding category.

Changing the settings

Using the [MENU/UTILITY] button

Various settings on the CDJ-900 can be changed by pressing [MENU/UTILITY].

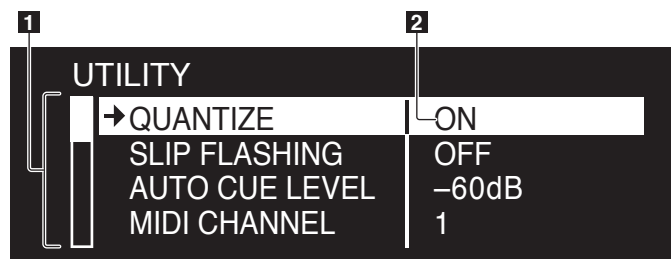

1 Setting item	The CDJ-900's settings items are displayed here.
2 Setting	The settings for the various items are displayed here.

Changing the settings

1 Press [MENU/UTILITY] for over 1 second.

The [UTILITY] screen is displayed.

2 Select and enter the setting item.

The cursor moves to the setting.

3 Change the setting and enter.

The cursor returns to the setting.

- Press [BACK] before changing the setting to return to step 2.

4 Press [MENU/UTILITY].

Press [MENU/UTILITY] to return to the menu screen.

List of settings

The factory default settings are indicated in **bold**.

Options settings	Setting ranges	Descriptions
QUANTIZE	ON/OFF	For details, see QUANTIZE on page 11.
SLIP FLASHING	ON/OFF	Sets whether or not the SLIP indicator flashes during DJ play using the [SLIP] button.
AUTO CUE LEVEL	-36dB/-42dB/-48dB/-54dB/ -60dB /-66dB/-72dB/-78dB	For details, see <i>Changing the auto cue level</i> on page 16.
MIDI CHANNEL	1 – 16	—
LIBRARY CREATOR	LIBRARY /FOLDER	Sets the browsing method for media on which Pioneer MEP-7000 libraries are recorded.
HISTORY NAME	—	For details, refer to <i>Setting [HISTORY NAME]</i> on the right.
DIGITAL OUT	16 bit/ 24 bit	This switches the number of bits of the audio signals output from the [DIGITAL OUT] terminal.
PLAYER No.	AUTO , 1 – 4	Sets this unit's player number. The player number cannot be changed when a medium is loaded in this unit.
LINK STATUS	—	When PRO DJ LINK connections are made, the connection status is displayed here.
AUTO STANDBY	ON/OFF	For details, refer to <i>Setting the auto standby mode</i> on the right.
VERSION No.	—	Displays the CDJ-900's software version.

Setting the auto standby mode

1 Select [AUTO STANDBY] and enter the setting item.

2 Select [ON] or [OFF] and enter.

When [AUTO STANDBY] is set to [ON], the power management function is activated in the following cases and the standby mode is set.

- When no operation whatsoever is performed for over 4 hours with no disc loaded or USB device connected, no PRO DJ LINK connection, and no computer connected to the **USB** port (on the CDJ-900's rear panel)
- When the CDJ-900 is operated, the standby mode is canceled.
- The CDJ-900 is shipped with the power management function turned on. If you do not want to use the power management function, set [AUTO STANDBY] to [OFF].

Setting [HISTORY NAME]

The name of the [HISTORY] recorded on the USB device can be preset.

1 Select [HISTORY NAME] and enter the setting item.

2 Using the rotary selector to input characters.

3 Press the rotary selector to enter.

The [HISTORY NAME] setting is changed.

- If [HISTORY NAME] is not set, numbers are added sequentially after [HISTORY].
- The maximum number of characters that can be set for the [HISTORY] name is 32, including both letters, numbers and symbols.

About the rekordbox software

rekordbox is an application for managing music files which are used for DJ play with a Pioneer DJ Player (i.e. CDJ-2000, CDJ-900).

rekordbox can be used to classify and search for music files stored on your computer and create playlists used for DJ performance.

rekordbox allows you to detect, measure and adjust the beats, tempos (BPM) and other elements of your music files prior to performance.

rekordbox can be used to set and store point information (for Cue, Loop, Hot Cue, etc.) prior to performance.

Data that has been detected and measured, as well as any points which have been set and stored using rekordbox, can be used in combination with a Pioneer DJ Player (i.e. CDJ-2000, CDJ-900) to achieve outstanding DJ performance.

Software end user license agreement

This Software End User License Agreement ("Agreement") is between you (both the individual installing the Program and any single legal entity for which the individual is acting) ("You" or "Your") and PIONEER CORPORATION ("Pioneer"). TAKING ANY STEP TO SET UP OR INSTALL THE PROGRAM MEANS THAT YOU ACCEPT ALL OF THE TERMS OF THIS LICENSE AGREEMENT. PERMISSION TO DOWNLOAD AND/OR USE THE PROGRAM IS EXPRESSLY CONDITIONED ON YOUR FOLLOWING THESE TERMS. WRITTEN OR ELECTRONIC APPROVAL IS NOT REQUIRED TO MAKE THIS AGREEMENT VALID AND ENFORCEABLE. IF YOU DO NOT AGREE TO ALL OF THE TERMS OF THIS AGREEMENT, YOU ARE NOT AUTHORIZED TO USE THE PROGRAM AND MUST STOP INSTALLING IT OR UNINSTALL IT, AS APPLICABLE.

1 Definitions

- 1 "Documentation" means written documentation, specifications and help content made generally available by Pioneer to aid in installing and using the Program.
- 2 "Program" means all or any part of Pioneer's software licensed to You by Pioneer under this Agreement.

2 Program license

- 1 Limited License. Subject to this Agreement's restrictions, Pioneer grants to You a limited, non-exclusive, nontransferable, license (without the right to sublicense):
 - a To install a single copy of the Program on the hard disk drive of Your computer, to use the Program only for Your personal purpose complying with this Agreement and the Documentation ("Authorized Use");
 - b To use the Documentation in support of Your Authorized Use; and
 - c To make one copy of the Program solely for backup purposes, provided that all titles and trademark, copyright and restricted rights notices are reproduced on the copy.
- 2 Restrictions. You will not copy or use the Program or Documentation except as expressly permitted by this Agreement. You will not transfer, sublicense, rent, lease or lend the Program, or use it for third-party training, commercial time-sharing or service bureau use. You will not Yourself or through any third party modify, reverse engineer, disassemble or decompile the Program, except to the extent expressly permitted by applicable law, and then only after You have notified Pioneer in writing of Your intended activities. You will not use the Program on multiple processors without Pioneer's prior written consent.
- 3 Ownership. Pioneer or its licensor retains all right, title and interest in and to all patent, copyright, trademark, trade secret and other intellectual property rights in the Program and Documentation, and any derivative works thereof. You do not acquire any other rights, express or implied, beyond the limited license set forth in this Agreement.
- 4 No Support. Pioneer has no obligation to provide support, maintenance, upgrades, modifications or new releases for the Program or Documentation under this Agreement.

3 Warranty disclaimer

THE PROGRAM AND DOCUMENTATION ARE PROVIDED "AS IS" WITHOUT ANY REPRESENTATIONS OR WARRANTIES, AND YOU AGREE TO USE THEM AT YOUR SOLE RISK. TO THE FULLEST EXTENT PERMISSIBLE BY LAW, PIONEER EXPRESSLY DISCLAIMS ALL WARRANTIES OF ANY KIND WITH RESPECT TO THE PROGRAM AND DOCUMENTATION, WHETHER EXPRESS, IMPLIED, STATUTORY, OR ARISING OUT OF COURSE OF PERFORMANCE, COURSE OF DEALING OR USAGE OF TRADE, INCLUDING ANY WARRANTIES OF MERCHANTABILITY, FITNESS FOR A PARTICULAR PURPOSE, SATISFACTORY QUALITY, ACCURACY, TITLE OR NON-INFRINGEMENT.

4 Damages and remedies for breach

You agree that any breach of this Agreement's restrictions would cause Pioneer irreparable harm for which money damages alone would be inadequate. In addition to damages and any other remedies to which Pioneer may be entitled, You agree that Pioneer may seek injunctive relief to prevent the actual, threatened or continued breach of this Agreement.

5 Termination

Pioneer may terminate this Agreement at any time upon Your breach of any provision. If this Agreement is terminated, You will stop using the Program, permanently delete it from the computer where it resides, and destroy all copies

of the Program and Documentation in Your possession, confirming to Pioneer in writing that You have done so. Sections 2.2, 2.3, 2.4, 3, 4, 5 and 6 will continue in effect after this Agreement's termination.

6 General terms

- 1 Limitation of Liability. In no event will Pioneer or its subsidiaries be liable in connection with this Agreement or its subject matter, under any theory of liability, for any indirect, incidental, special, consequential or punitive damages, or damages for lost profits, revenue, business, savings, data, use, or cost of substitute procurement, even if advised of the possibility of such damages or if such damages are foreseeable. In no event will Pioneer's liability for all damages exceed the amounts actually paid by You to Pioneer or its subsidiaries for the Program. The parties acknowledge that the liability limits and risk allocation in this Agreement are reflected in the Program price and are essential elements of the bargain between the parties, without which Pioneer would not have provided the Program or entered into this Agreement.
- 2 The limitations or exclusions of warranties and liability contained in this Agreement do not affect or prejudice Your statutory rights as consumer and shall apply to You only to the extent such limitations or exclusions are permitted under the laws of the jurisdiction where You are located.
- 3 Severability and Waiver. If any provision of this Agreement is held to be illegal, invalid or otherwise unenforceable, that provision will be enforced to the extent possible or, if incapable of enforcement, deemed to be severed and deleted from this Agreement, and the remainder will continue in full force and effect. The waiver by either party of any default or breach of this Agreement will not waive any other or subsequent default or breach.
- 4 No Assignment. You may not assign, sell, transfer, delegate or otherwise dispose of this Agreement or any rights or obligations under it, whether voluntarily or involuntarily, by operation of law or otherwise, without Pioneer's prior written consent. Any purported assignment, transfer or delegation by You will be null and void. Subject to the foregoing, this Agreement will be binding upon and will inure to the benefit of the parties and their respective successors and assigns.
- 5 Entire Agreement. This Agreement constitutes the entire agreement between the parties and supersedes all prior or contemporaneous agreements or representations, whether written or oral, concerning its subject matter. This Agreement may not be modified or amended without Pioneer's prior and express written consent, and no other act, document, usage or custom will be deemed to amend or modify this Agreement.
- 6 You agree that this Agreement shall be governed and construed by and under the laws of Japan.

Cautions on copyrights

rekordbox restricts playback and duplication of copyright-protected music contents.

- When coded data, etc., for protecting the copyright is embedded in the music contents, it may not be possible to operate the program normally.
- When rekordbox detects that coded data, etc., for protecting the copyright is embedded in the music contents, processing (playback, reading, etc.) may stop.

Recordings you have made are for your personal enjoyment and according to copyright laws may not be used without the consent of the copyright holder.

- Music recorded from CDs, etc., is protected by the copyright laws of individual countries and by international treaties. It is the full responsibility of the person who has recorded the music to ensure that it is used legally.
- When handling music downloaded from the Internet, etc., it is the full responsibility of the person who has downloaded the music to ensure that it is used in accordance with the contract concluded with the download site.

Cautions on Installation

Read the "Software end user license agreement" carefully before installing rekordbox.

rekordbox is compatible with the operating systems shown below.

- Mac OS X (10.4.6 or later)
- Windows Vista® Home Basic/Home Premium/Ultimate/Business
- Windows® XP Home Edition/Professional (SP2 or later)
rekordbox is not compatible with 64-bit editions of operating systems (Windows® XP Professional x64 edition or 64-bit editions of Windows Vista®).

The included CD-ROM contains installation programs and operating instructions in the following 12 languages:

- English, French, German, Italian, Dutch, Spanish, Portuguese, Russian, Chinese (simplified characters), Chinese (traditional characters), Korean, Japanese.
When using rekordbox with an operating system in a different language, follow the instructions on the screen to select [English].

Check that the computer provides the operating environment described below before starting installation.

<Required system (minimum operating environment)>

- CPU:
For Mac OS X, Macintosh computer equipped with a 1.83 GHz or greater Intel® Core™ Duo (or compatible) processor
For Windows Vista® or Windows® XP, PC/AT compatible computer equipped with a 2 GHz or greater Intel® Pentium® 4 (or compatible) processor
- Required memory: 512 MB or more of RAM
- Hard disc: 250 MB or more of free space (not including space for storing music files, etc.)
- CD drive: Optical disc drive on which the CD-ROM can be read
- Sound: Audio output to speakers, headphones, etc. (internal or external audio device)
- Internet connection: For user registration and inquiries, use a web browser supporting 128-bit SSL (Safari 2.0 or later or Internet Explorer® 6.0 or later).
- USB port: A USB port for connection of a USB device (flash memory, hard disc, etc.) is required to transfer music files to the USB device.
- LAN port: An Ethernet LAN adapter (RJ45 port) for communicating with the DJ player is required to transfer music files to a Pioneer DJ player (i.e. CDJ-2000, CDJ-900).
Operation is not guaranteed on all computers, even those with the operating environment described above.
Even with the required memory capacity indicated for the operating environment above, depending on the number of resident programs and services, the software may not provide full functionality and performance due to lack of memory. In this case, stop some resident programs and services in order to increase the amount of free memory. We recommend adding extra memory in order to achieve stable performance.
Depending on the computer's power settings, etc., the CPU and hard disc processing capacity may be insufficient. When using laptop computers in particular, always keep the AC power connected and set the computer to maximum performance conditions when using rekordbox.
Note that problems may arise in the operation of rekordbox due to other software being used together with it.

Installing rekordbox

❖ Installation Procedure (Macintosh)

- Read the "Cautions on Installation" carefully before installing rekordbox.
- Log on as the user which was set as the computer's administrator before installing.

1 When the included CD-ROM is inserted into the computer's CD drive, the CD drive opens on the screen. Double-click the [CD_menu.app] icon.

- If the CD drive does not open on the screen when the CD-ROM is inserted, use Finder to open the CD drive, then double-click the [CD_menu.app] icon.

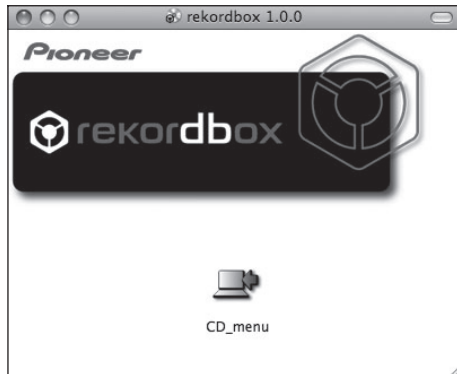

2 When the CD-ROM's menu is displayed, select [rekordbox: Install Music Management Software], then click [Start].

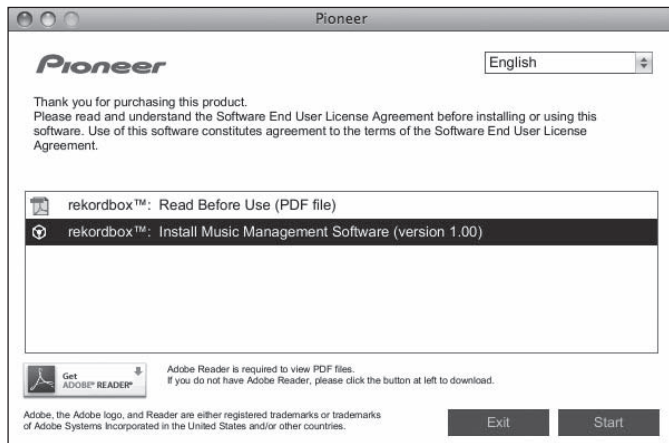

To close the CD-ROM menu, click [Exit].

3 Install rekordbox following the instructions on the screen.

❖ Installation Procedure (Windows)

- Read the "Cautions on Installation" carefully before installing rekordbox.
- Log on as the user registered as the computer's administrator before installing rekordbox.

1 Insert the included CD-ROM into the computer's CD drive.

The CD-ROM menu is displayed.

- If the CD-ROM menu does not appear when the CD-ROM is inserted, open the CD drive from [Computer (or My Computer)] in the [Start] menu, then double-click the [CD_menu.exe] icon.

2 When the CD-ROM's menu is displayed, select [rekordbox: Install Music Management Software], then click [Start].

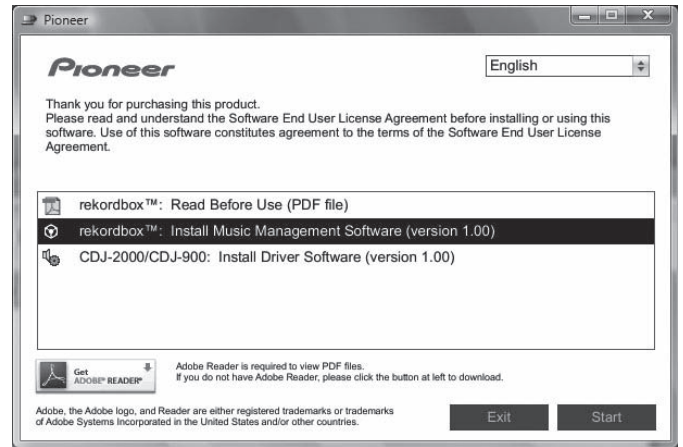

To close the CD-ROM menu, click [Exit].

3 Install rekordbox following the instructions on the screen.

- To stop installation in progress, click [Cancel].

Launching rekordbox

Log on as the user which was set as the computer's administrator before using rekordbox.

When rekordbox is started up for the first time, the license key must be input. The license key is affixed to the CD-ROM package.

When rekordbox is started up, the operating instructions can be viewed from the rekordbox [Help] menu.

❖ For Mac OS X:

Open the [Application] folder with Finder, then double-click [rekordbox 1.x.x.app].

The 1.x.x indicates the rekordbox version.

❖ For Windows Vista® or Windows® XP:

Click on the windows [Start] menu button, then [All Programs] > [Pioneer] > [rekordbox 1.x.x] > [rekordbox 1.x.x].

The 1.x.x indicates the rekordbox version.

Using the support site

Before making an inquiry about rekordbox operations and technical support, refer to the operating instructions for rekordbox and check the FAQs published on the support site for rekordbox.

<Support Site for rekordbox>

<http://www.prodjnet.com/rekordbox/support/>

- To make an inquiry about rekordbox, you need to register as a user in advance on the support site for rekordbox.
- You need to enter the license key for your user registration. Have the license key ready. Also, be sure not to forget the login name (your e-mail address) and the password specified for your user registration, as well as the license key.
- Pioneer Corporation collects your personal information for the following purposes:
 - 1 To provide customer support for your purchased product
 - 2 To inform you of product or event information by e-mail
 - 3 To reflect your opinions collected by survey on product planningYour personal information is kept confidential corresponding to the privacy policy set forth by our company.
You can check our privacy policy on the support site for rekordbox.
- When you make an inquiry about rekordbox, be sure to provide us the information on the model name, specifications (CPU and memory capacity and peripheral devices connected), and operating system version of your computer, as well as specific descriptions of system malfunction.
For an inquiry about configuring your computer with peripheral devices other than our products and the corresponding technical support, contact each manufacturer or retailer.
- rekordbox is subject to upgrade for enhanced function and performance. The upgrade program can be downloaded on the support site. We strongly recommend you upgrade your software on a regular basis to keep the latest updates on your system.

About the driver software

This driver software is an exclusive ASIO driver for outputting audio signals from the computer. To use the CDJ-900 connected to a computer on which Windows is installed, install the driver software on the computer beforehand. When using a computer on which a MAC operating system is installed, use the operating system's standard driver software.

Software end user license agreement

Carefully read the provisions of the *Software end user license agreement* on page 22 before installing or using the driver software. Using the driver software implies that you have consented to the *Software end user license agreement*.

Cautions on Installation

- Before installing the driver software, be sure to turn off the power of this unit and disconnect the USB cable from both this unit and your computer.
- If you connect this unit to your computer without installing the driver software first, an error may occur on your computer depending on the system environment.
- If you have discontinued the installation process in progress, step through the installation process again from the beginning according to the following procedure.
- Carefully read the provisions of the *Software end user license agreement* before installing the driver software for exclusive use with this unit.
- Before installing the driver software, terminate all other programs running on your computer.
- The driver software is compatible with the following OSs.
 - Windows Vista® Home Basic/Home Premium/Ultimate/Business
 - Windows® XP Home Edition/Professional (SP2 or later)The driver software is not compatible with 64-bit OS (Windows® XP Professional x64 edition and Windows Vista® 64-bit).
- The included CD-ROM contains installation programs in the following 12 languages:
 - English, French, German, Italian, Dutch, Spanish, Portuguese, Russian, Simplified Chinese, Traditional Chinese, Korean, and JapaneseIf the language of your OS is one other than the ones listed above, select **[English]** following the instructions on the screen.

Installing the driver software

- Carefully read "Cautions on Installation" before installing the driver software.
- To install or uninstall the driver software, you need to be authorized by the administrator of your computer. Log on as the administrator of your computer before proceeding with the installation.

1 Insert the included CD-ROM into the computer's CD drive.

The CD-ROM menu is displayed.

- If the CD-ROM menu does not appear when the CD-ROM is inserted, open the CD drive from **[Computer (or My Computer)]** in the **[Start]** menu, then double-click the **[CD_menu.exe]** icon.

2 When the CD-ROM's menu is displayed, select **[CDJ-2000/CDJ-900: Install Driver Software]**, then click **[Start]**.

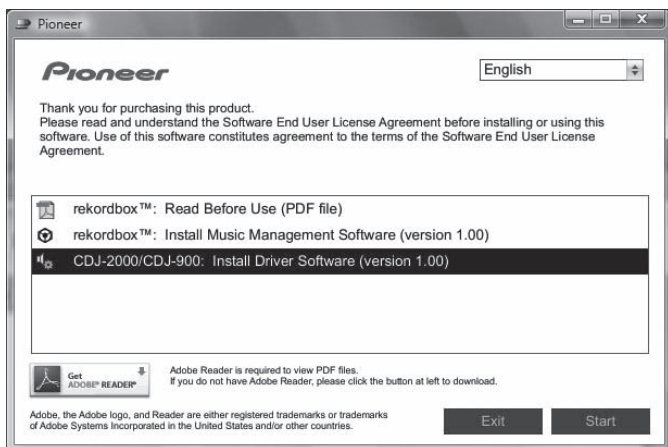

To close the CD-ROM menu, click **[Exit]**.

3 Proceed with installation according to the instructions on the screen.

If **[Windows Security]** appears on the screen while the installation is in progress, click **[Install this driver software anyway]** and continue with the installation.

- When installing on Windows XP
 - If **[Hardware Installation]** appears on the screen while the installation is in progress, click **[Continue Anyway]** and continue with the installation.

- When the installation program is completed, a completion message appears.

Connecting the CDJ-900 and computer

1 Connect this unit to your computer via a USB cable.

2 Press **[POWER]**.

Turn on the power of this unit.

- The message **[Installing device driver software]** may appear when the CDJ-900 is connected to the computer for the first time or when it is reconnected to the computer's USB port. Wait until the **[Your devices are ready for use]** message appears.
- When installing on Windows XP
 - [Can Windows connect to Windows Update to search for software?]** may appear while the installation is in progress. Select **[No, not this time]** and click **[Next]** to continue with the installation.
 - [What do you want the wizard to do?]** may appear while the installation is in progress. Select **[Install the software automatically (Recommended)]** and click **[Next]** to continue with the installation.
 - If **[Hardware Installation]** appears on the screen while the installation is in progress, click **[Continue Anyway]** and continue with the installation.

Adjusting the buffer size (Windows)

This unit functions as an audio device conforming to the ASIO standards.

Click **Windows [Start] menu >[All Programs]>[Pioneer]>[Pioneer CDJ]>[Pioneer CDJ ASIO Settings Utility]**.

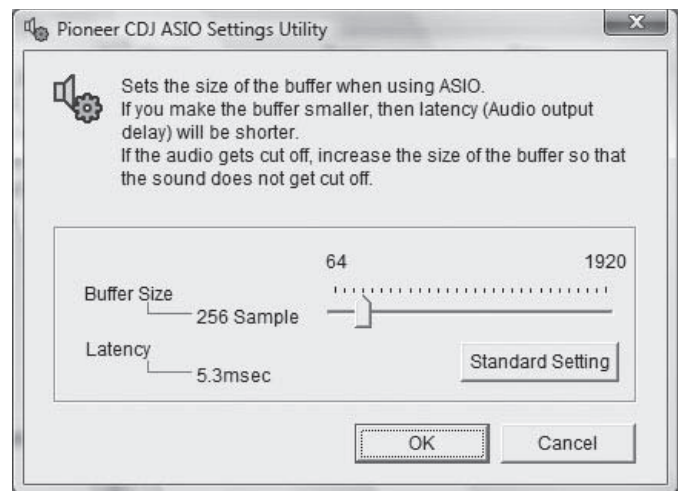

A sufficiently large buffer size decreases the chance of sound dropout (sound interruption) but increases audio signal transmission delay (latency).

- When an application program (DJ software, etc.) with this unit set as a fixed device is running, terminate the program before adjusting the buffer size.

Checking the version of the driver software

Click Windows [Start] menu >[All Programs]>[Pioneer]>[Pioneer CDJ]>[Pioneer CDJ Version Display Utility].

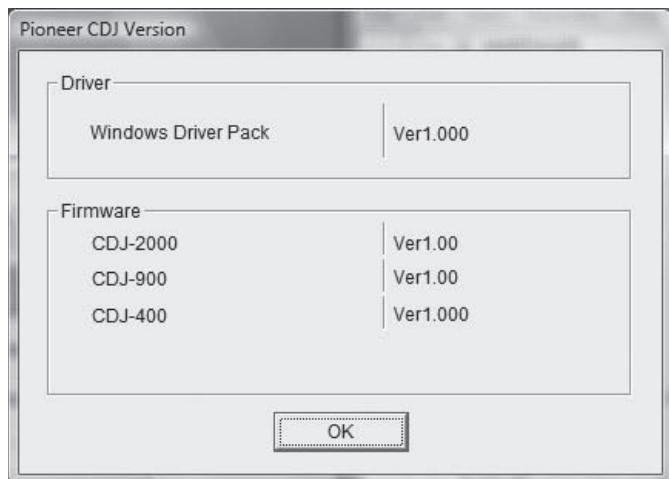

- You can check the firmware version of this unit on the screen.
- The firmware version is not displayed when the CDJ-900 is not connected to the computer or when the CDJ-900 and computer are not properly communicating.

Checking the latest information on the driver software

For the latest information on the driver software for exclusive use with this unit, visit our website shown below.
<http://www.prodjnet.com/support/>

Using other brands of DJ software

Operating DJ software by MIDI interface

The CDJ-900 also outputs the operating data for the buttons and dials in MIDI format. If you connect a computer with a built-in MIDI-compatible DJ software via a USB cable, you can operate the DJ software on this unit. The sound of music files being played on the computer can also be output from the CDJ-900. Before using the CDJ-900 as an audio device, install the driver software on the computer (page 25). Also, the CDJ-900 must be selected in the DJ software's settings. For details, see your DJ software's operating instructions.

1 Connect the USB port on this unit to your computer.

For instructions on connecting, see *Using other brands of DJ software* on page 13.

2 Press [BROWSE], then press [LINK].

[Control Mode] and [USB-MIDI] appear on the menu screen.

3 Select [Control Mode] and enter.

The connecting screen is displayed.

4 Select [USB-MIDI] and enter.

The CDJ-900 switches to the control mode.

5 Start the DJ software.

Communication with the DJ software starts.

- The DJ software on the computer can be operated using the buttons and rotary selector on the CDJ-900.
- It may not be possible to use some buttons to operate the DJ software.
- The control mode is canceled when a track is loaded in the CDJ-900.
- For messages output by the CDJ-900, see *List of MIDI Messages*.

❖ Changing the MIDI channel setting

1 Press [MENU/UTILITY] for over 1 second.

The utility screen appears.

2 Select [MIDI CHANNEL] and enter.

3 Turn the rotary selector.

Select the MIDI channel and change the setting. A setting from 1 – 16 can be selected.

4 Press the rotary selector to enter.

5 Press [MENU/UTILITY].

The previous screen reappears.

❖ List of MIDI Messages

SW Name	SW Type	MIDI Messages			Notes
		MSB			
JOG (TOUCH)	—	Bn	10	dd	A linear value corresponding to the speed, from stop to 4X: 64 for stop, 65 (0.06X) – 127 (4X) in the forward direction, 63 (0.06X) – 0 (4X) in the reverse direction.
TEMPO SLIDER	VR	Bn	1D	dd	0 – 127, 0 on the – side, 127 on the + side
TOUCH/RELEASE	VR	Bn	1E	dd	0 – 127, 0 (min.) on the left side, 127 (max.) on the right side
JOG RING	—	Bn	30	dd	A linear value corresponding to the speed from 0.5X to 4X: 64 when stopped (under 0.49X), 65 (0.5X) to 127 (4X) in the forward direction, 63 (0.5X) to 0 (4X) in the reverse direction.
ENCODER	General Purpose Controller	Bn	4F	dd	98 – 127, 1 – 30 Difference of count from previous time is sent ($\pm 1 - \pm 30$) When over ± 30 , set at ± 30
PLAY/PAUSE	SW	9n	00	dd	OFF=0, ON=127
CUE	SW	9n	01	dd	OFF=0, ON=127
SEARCH FWD	SW	9n	02	dd	OFF=0, ON=127
SEARCH REV	SW	9n	03	dd	OFF=0, ON=127
TRACK SEARCH NEXT	SW	9n	04	dd	OFF=0, ON=127
TRACK SEARCH PREV	SW	9n	05	dd	OFF=0, ON=127
LOOP IN	SW	9n	06	dd	OFF=0, ON=127
LOOP OUT	SW	9n	07	dd	OFF=0, ON=127
RELOOP	SW	9n	08	dd	OFF=0, ON=127
MEMORY	SW	9n	0A	dd	OFF=0, ON=127
CALL NEXT	SW	9n	0B	dd	OFF=0, ON=127
CALL PREV	SW	9n	0C	dd	OFF=0, ON=127
DELETE	SW	9n	0D	dd	OFF=0, ON=127
TIME/A.CUE	SW	9n	0E	dd	OFF=0, ON=127
TEMPO RANGE	SW	9n	10	dd	OFF=0, ON=127
MASTER TEMPO	SW	9n	11	dd	OFF=0, ON=127
JOG MODE	SW	9n	12	dd	OFF=0, ON=127
JOG TOUCH	SW	9n	20	dd	OFF=0, ON=127
REVERSE	SW	9n	21	dd	OFF=0, ON=127
BEAT LOOP 1	SW	9n	28	dd	OFF=0, ON=127
BEAT LOOP 2	SW	9n	29	dd	OFF=0, ON=127
BEAT LOOP 4	SW	9n	2A	dd	OFF=0, ON=127
BEAT LOOP 8	SW	9n	2B	dd	OFF=0, ON=127
SLIP	SW	9n	2C	dd	OFF=0, ON=127
BEAT SELECT	SW	9n	2D	dd	OFF=0, ON=127
EJECT	SW	9n	2F	dd	OFF=0, ON=127
TAG TRACK	SW	9n	30	dd	OFF=0, ON=127
BACK	SW	9n	32	dd	OFF=0, ON=127
ENCODER PUSH	SW	9n	33	dd	OFF=0, ON=127

n is the channel number.

Additional information

Troubleshooting

- Incorrect operation is often mistaken for trouble or malfunction. If you think that there is something wrong with this component, check the points below. Sometimes the trouble may lie in another component. Inspect the other components and electrical appliances being used. If the trouble cannot be rectified after checking the items below, ask your nearest Pioneer authorized service center or your dealer to carry out repair work.
- The CDJ-900 may not operate properly due to such external causes as static electricity. If this happens, normal operation can sometimes be restored by turning the power off, waiting for the disc to stop completely, then turning the power back on.
- Non-finalized (partial discs) CD-R/-RW cannot be played on the CDJ-900.
- Irregularly shaped discs other than standard 12 cm discs cannot be played on the CDJ-900 (doing so will lead to damage or accidents).
- The BPM measured by the CDJ-900 may differ from the BPM indicated on the disc or that of a Pioneer DJ mixer, etc. This is due to the different methods used for measuring the BPM, and is not a malfunction.























Problem	Check	Remedy
Disc cannot be ejected.	—	If the [DISC EJECT▲] button does not work, insert the pin in the disc force eject pin insertion hole to eject the disc.
Playback does not start when disc is loaded.	Is the disc or file playable?	See <i>Discs/files playable on the CDJ-900</i> on page 7.
	Is the auto cue function activated?	Press [AUTO CUE] for at least 1 second to turn cancel the auto cue function.
File cannot be played.	Is the file copyright-protected (by DRM)?	Copyright-protected files cannot be played.
No sound is produced, or sound is distorted or noisy.	Are you operating the connected DJ mixer properly?	Check the operation of the DJ mixer.
	Is the CDJ-900 placed near a TV?	Turn the TV's power off, or install the CDJ-900 and TV away from one another.
Loud noise is produced or playback stops when a certain disc is played.	Is the disc scratched?	Scratched discs may not play.
	Is the disc dirty?	Wipe the dirt off the disc (page 29).
File information is not properly displayed.	Is the information recorded in a language not supported by the CDJ-900?	When creating files using DJ software, etc., record the information in a language supported by the CDJ-900.
Track search operation takes too long.	Is the auto cue function activated?	Track searching may take some time when there are long silent sections between tracks.
	—	If track searching is not possible within 10 seconds, a cue point is set at the beginning of the track.
Back cue function does not work.	Is a cue point set?	Set the cue point (page 16).
Loop play function does not work.	Is a cue point set?	Set the cue point (page 16).
Settings are not stored in the memory.	Has the power been turned off directly after changing the setting?	After changing settings, wait at least 10 seconds before turning the power off.
USB device is not recognized.	Is the USB device properly connected?	Connect the device securely (all the way in).
	Is the USB device connected via a USB hub?	USB hubs cannot be used.
	Is the USB device supported by the CDJ-900?	This player only supports USB mass storage class devices. This player supports portable flash memory and digital audio playback devices.
	Is the file format supported by the CDJ-900?	Check the file format of the connected USB device. For the file formats supported by the CDJ-900, see <i>About USB devices</i> on page 8.
	—	Turn the power off then back on.
Cue or loop points of tracks recorded on USB devices are not stored in the memory.	Is there sufficient free space on the USB device?	A maximum of 100 cue and loop points per disc can be recorded on USB devices (10 per track for media other than discs). If you attempt to record more points than the limit, [POINT FULL] is displayed and the points cannot be recorded. If there is not enough free space on the USB device or if the device is write-protected, [USB FULL] is displayed and the points cannot be recorded.
Cue or loop points of tracks recorded on USB devices are not displayed.	Has the USB device been properly removed?	Points may not be displayed if the USB device is removed without performing the proper stopping procedure or if the CDJ-900's power is turned off.
The playing address display is not displayed in the remaining time mode.	—	When playing files recorded in VBR, it may happen that the set cannot detect the length of the track immediately and that some time is required for the playing address display to appear.
Time is required to read USB devices (flash memory drives and hard discs).	Is there a large number of folders or files recorded on the USB device?	When there are many folders or files, some time may be required for loading.
	Are files other than music files stored on the USB device?	When files other than music files are stored in folders, time is required to read them as well. Do not store files or folders other than music files on the USB device.
Library browsing is not possible.	Is a medium on which library information is recorded loaded?	The library browse mode is only set when media on which library information is recorded are loaded. When a medium on which no library information is recorded is loaded, the folder browse mode is set.
[HISTORY] is not displayed.	Is a USB device loaded?	The [HISTORY] function can only be used for DJ players on which a USB device is loaded.
Nothing is displayed.	Is the power management function activated?	The CDJ-900 is shipped with the power management function turned on. If you do not want to use the power management function, set [AUTO STANDBY] to [OFF] . (page 21)
PRO DJ LINK does not work well.	Are the player numbers properly set?	Set [PLAYER No.] to [AUTO] or to a number different from the number currently set. (page 21)
	Is the LAN cable properly connected?	Connect the LAN cable properly to the [LINK] terminal.
	Is the switching hub's power turned on?	Turn the switching hub's power on.
	Is an unnecessary device connected to the switching hub?	Disconnect the unnecessary device from the switching hub.

Error messages

When the CDJ-900 cannot operate normally, an error code appears on the display. Take the necessary measures, referring to the table below. If an error code not indicated on the table below is displayed or if the same error code appears after the indicated action has been taken, contact your store of purchase or nearby Pioneer service station.

Error code	Error type	Description of error	Cause and action
E-7201	TOC READ ERROR	TOC data cannot be read.	<ul style="list-style-type: none"> Disc is cracked. → Replace the disc. Disc is dirty. → Clean the disc. If operation is normal with other discs, the problem is with that disc.
E-8301 E-8302 E-8303	PLAYER ERROR	Disc that cannot be played normally is loaded.	
E-8304	DECODE ERROR	Music files that cannot be played normally are loaded.	
E-8305	DATA FORMAT ERROR		Format is wrong. → Replace with music files in the proper format.
E-8306	NO FILE	Track recorded in the library, playlist, etc., has been deleted from the USB device and cannot be played.	Do not delete that track from the USB device.
E-9101	MECHANICAL TIME OUT	Mechanical error (time out) during loading or ejecting of disc.	Displayed when mechanism operation is not completed within the specified time.

List of icons displayed on the main unit display section

	Genre		Rating		Playback is not possible		Label		Folder
	Artist		Time		USB		Playing		History
	Album		Player number (1 – 4)		SD		Played		WAIT
	Track/file name		Cue point set in memory		Computer		Remixer name		
	Playlist		Registered in tag list		Disc		Original artist		

Cautions on use

About condensation

Water droplets (condensation) may form inside the unit (on operating parts and lenses) in the winter, for example, if the unit is moved from a cold place into a warm room or if the temperature in the room in which the unit is installed rises suddenly (through heating, etc.). The unit will not operate properly and will not be playable with condensation inside. Let the unit stand for 1 to 2 hours at room temperature (though this time depends on the conditions of the condensation) without turning on the power. The water droplets will evaporate and the unit will become playable. Condensation can occur in the summer as well if the unit is exposed to the direct wind from an air-conditioner, etc. If this happens, move the unit to a different location.

Cleaning the lens

The player's lens should not become dirty in normal use, but if for some reason it should malfunction due to dust or dirt, consult your nearest Pioneer authorized service center. Although lens cleaners for players are commercially available, we advise against using them since some may damage the lens.

Handling discs

Storing

- Always place discs in their cases and store them vertically, avoiding hot, humid places, places exposed to direct sunlight and extremely cold places.
- Be sure to read the cautions included with the disc.

Cleaning discs

- Discs may not play if there are fingerprints or dust on them. In this case, use a cleaning cloth, etc., to gently wipe the disc from the inside towards the outside. Do not use dirty cleaning cloths.



- Do not use benzene, thinner or other volatile chemicals. Also do not use record spray or antistatic agents.
- For tough dirt, apply some water to a soft cloth, wring out thoroughly, wipe off the dirt, then wipe off the moisture with a dry cloth.
- Do not use damaged (cracked or warped) discs.
- Do not let the signal surface of discs get scratched or dirty.
- Do not place two discs in the disc tray, one on top of the other.
- Do not attach pieces of paper or stickers to discs. Doing so could warp discs, making it impossible to play them. Also note that rental discs often have labels attached to them, and the label's glue may have oozed out. Check that there is no glue around the edges of such labels before using rented discs.

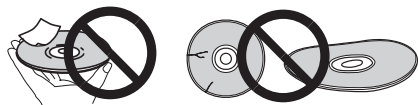

About specially shaped discs

Specially shaped discs (heart-shaped, hexagonal, etc.) cannot be played on this player. Do not attempt to play such discs, as they could damage the player.



About condensation on discs

Water droplets (condensation) may form on the surface of discs if they are moved from a cold place (particularly in winter) into a warm room. Discs may not play normally if there is condensation on them. Carefully wipe the water droplets off the surface of the disc before loading it.

Disclaimer

- Pioneer and rekordbox are trademarks or registered trademarks of the Pioneer Corporation.
- Microsoft®, Windows Vista®, Windows® and Internet Explorer® are registered trademarks or trademarks in the United States and other countries of the Microsoft Corporation of the United States.
- Apple, Macintosh, Mac OS, Safari, iTunes and Finder are registered trademarks of Apple Inc. in the United States and other countries.
- Pentium is a registered trademark of Intel Corporation.
- Adobe and Reader are either registered trademarks or trademarks of Adobe Systems Incorporated in the United States and/or other countries.
- ASIO is a trademark of Steinberg Media Technologies GmbH.

The names of companies and products mentioned herein are the trademarks of their respective owners.

This product has been licensed for nonprofit use. This product has not been licensed for commercial purposes (for profit-making use), such as broadcasting (terrestrial, satellite, cable or other types of broadcasting), streaming on the Internet, Intranet (a corporate network) or other types of networks or distributing of electronic information (online digital music distribution service). You need to acquire the corresponding licenses for such uses. For details, visit <http://www.mp3licensing.com>.



Fraunhofer Institut
Integrierte Schaltungen

The audio compression technology for MP3 is offered under the license of Fraunhofer IIS and Thomson Multimedia.

Specifications

Power requirements	AC 120 V, 60 Hz
Power consumption	26 W
Power consumption (standby)	0.4 W
Main unit weight	3.9 kg
External dimensions	305 mm (W) x 115.6 mm (H) x 385 mm (D)
Tolerable operating temperature	+5 °C to +35 °C
Tolerable operating humidity	5 % to 85 % (no condensation)

Analog audio output (AUDIO OUT L/R)

Output terminal	RCA terminal
Output Level	2.0 Vrms (1 kHz)
Frequency response	4 Hz to 20 kHz
S/N ratio	115 dB
Total harmonic distortion	0.003 %

Digital audio output (DIGITAL OUT)

Output terminal	RCA terminal
Output type	Coaxial digital (S/PDIF)
Output level	0.5 Vp-p (75 Ω)
Output format	44.1 kHz, 24 bit/16 bit

USB downstream section (USB)

Port	Type A
Power supply	5 V/500 mA or less

USB upstream section (USB)

Port	Type B
------------	--------

LAN (PRO DJ LINK)

Rating	100Base-TX
--------------	------------

Control output (CONTROL)

Port	Mini-jack
------------	-----------

- The articles concerning free repairs, etc., indicated on the warranty do not apply to the rekordbox music management software. Before installing or using rekordbox, carefully read the articles in *Software end user license agreement* on page 22.
- The specifications and design of this product are subject to change without notice.

Should this product require service in the U.S.A. and you wish to locate the nearest Pioneer Authorized Independent Service Company, or if you wish to purchase replacement parts, operating instructions, service manuals, or accessories, please call the number shown below.

1-800-872-4159

Please do not ship your product to Pioneer without first calling the Customer Support at the above listed number for assistance.

Pioneer Electronics (USA), INC.
Service Support Division
P.O. BOX 1760, Long Beach, CA 90801-1760, U.S.A.

For warranty information please see the Limited Warranty sheet included with your product.

Should this product require service in Canada, please contact a Pioneer Canadian Authorized Dealer to locate the nearest Pioneer Authorized Service Company in Canada. Alternatively, please contact the Customer Satisfaction Department at the following address:

Pioneer Electronics of Canada, Inc.
Customer Satisfaction Department
300 Allstate Parkway, Markham, Ontario L3R 0P2
1-877-283-5901
905-479-4411

For warranty information please see the Limited Warranty sheet included with your product.

5021_C_E

Published by Pioneer Corporation.
Copyright © 2009 Pioneer Corporation.
All rights reserved.

PIONEER CORPORATION

4-1, Meguro 1-Chome, Meguro-ku, Tokyo 153-8654, Japan

PIONEER ELECTRONICS (USA) INC.

Multimedia and Mass Storage Division: 2265 East 220th Street, Long Beach, CA 90810, U.S.A. TEL: 800-444-OPTI (6784)

PIONEER ELECTRONICS OF CANADA, INC.

Industrial Products Department: 300 Allstate Parkway, Markham, Ontario L3R 0P2, Canada TEL: 905-479-4411

Printed in

<DRB1486-A>

Free Manuals Download Website

<http://myh66.com>

<http://usermanuals.us>

<http://www.somanuals.com>

<http://www.4manuals.cc>

<http://www.manual-lib.com>

<http://www.404manual.com>

<http://www.luxmanual.com>

<http://aubethermostatmanual.com>

Golf course search by state

<http://golfingnear.com>

Email search by domain

<http://emailbydomain.com>

Auto manuals search

<http://auto.somanuals.com>

TV manuals search

<http://tv.somanuals.com>