

AFTER-SALES SERVICE FOR PIONEER PRODUCTS

Please contact the dealer or distributor from where you purchased the product for its after-sales service (including warranty conditions) or any other information. In case the necessary information is not available, please contact the Pioneer's subsidiaries (regional service headquarters) listed below:

PLEASE DO NOT SHIP YOUR PRODUCT TO THE COMPANIES at the addresses listed below for repair without advance contact, for these companies are not repair locations.

AMERICA

PIONEER ELECTRONICS SERVICE, INC.
CUSTOMER SUPPORT DIVISION
P.O. BOX 1760, LONG BEACH, CA 90801-1760, U.S.A.

EUROPE

PIONEER ELECTRONIC (EUROPE) N.V.
EUROPEAN SERVICE DIVISION
HAVEN 1087, KEETBERGLAAN 1, 9120 MELSELE, BELGIUM

ASEAN

PIONEER ELECTRONICS ASIACENTRE PTE. LTD.
SERVICE DEPARTMENT
501 ORCHARD ROAD, #10-00
LANE CRAWFORD PLACE, SINGAPORE 0923

JAPAN AND OTHERS

PIONEER ELECTRONIC CORPORATION (HEAD OFFICE)
CUSTOMER SUPPORT CENTER
4-1, MEGURO 1-CHOME, MEGURO-KU, TOKYO 153 JAPAN

 **PIONEER®**

LaserMemory

DR-U06S

CD-ROM DRIVE UNIT
UNITE DE LECTEUR DE CD-ROM
CD-ROM -LAUFWERK
LETTORE DI CD-ROM
CD-ROMドライブユニット

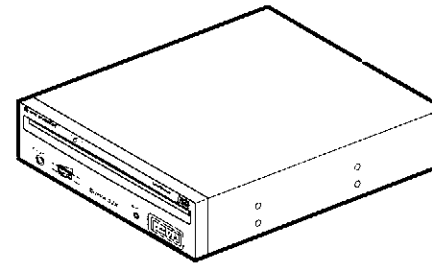

Operating instructions
Mode d'emploi
Bedienungsanleitung
Istruzioni per l'uso
取扱説明書

COMPACT
disc

English

Français

Deutsch

Italiano

日本語

IMPORTANT NOTICE:
RECORD THE MODEL NUMBER AND SERIAL NUMBER OF THIS EQUIPMENT BELOW. THE NUMBERS ARE ON THE TOP PANEL.
MODEL NO. DR-U06S
SERIAL NO. _____
KEEP THESE NUMBERS FOR FUTURE USE.

WARNING: TO PREVENT FIRE OR SHOCK HAZARD, DO NOT EXPOSE THIS APPLIANCE TO RAIN OR MOISTURE.

IMPORTANT



The lightning flash with arrowhead, within an equilateral triangle, is intended to alert the user to the presence of uninsulated "dangerous voltage" within the product's enclosure that may be of sufficient magnitude to constitute a risk of electric shock to persons.

CAUTION
RISK OF ELECTRIC SHOCK
DO NOT OPEN

CAUTION:
TO PREVENT THE RISK OF ELECTRIC SHOCK, DO NOT REMOVE COVER (OR BACK). NO USER-SERVICEABLE PARTS INSIDE. REFER SERVICING TO QUALIFIED SERVICE PERSONNEL.



The exclamation point within an equilateral triangle is intended to alert the user to the presence of important operating and maintenance (servicing) instructions in the literature accompanying the appliance.



この取扱説明書はエコマーク認定の再生紙を使用しています。

France : tapez 36 15 PIONEER

Published by Pioneer Electronic Corporation.
Copyright © 1997 Pioneer Electronic Corporation
All rights reserved.

© 1997 パイオニア株式会社 禁無断転載

 **パイオニア株式会社** 〒153 東京都目黒区目黒1丁目4番1号

PIONEER ELECTRONIC CORPORATION

Business Systems Company, Overseas Sales Department: 4-1, Meguro 1-Chome, Meguro-ku, Tokyo 153-8664, Japan
PIONEER NEW MEDIA TECHNOLOGIES, INC.

Multimedia and Mass Storage Division: 2266 East 220th Street, Long Beach, CA 90810, U.S.A. TEL: (800-444-OPT1) (6784)

PIONEER ELECTRONICS SERVICE, INC. 1926 East Dominguez St. Long Beach, CA 90810, U.S.A. TEL: (310-652-2820)

PIONEER ELECTRONIC (EUROPE) N.V.

Multimedia Division: PIONEER House, Hollybush Hill, Stoke Pages, Slough SL2 4QP, U.K. TEL: +44-1753-780-780

PIONEER ELECTRONICS OF CANADA, INC.

Industrial Products Department: 309 Allstate Parkway, Markham, Ontario L3R 0P2, Canada TEL: 905-479-4411

PIONEER ELECTRONICS AUSTRALIA PTY. LTD. 178-184 Boundary Road, Braeside, Victoria 3195, Australia TEL: +61-3 9530 6300

PIONEER ELECTRONICS ASIACENTRE PTE. LTD. 501 Orchard Road, #10-00, Lane Crawford Place, Singapore 0923 TEL: +65 735 9011

SYSTEM REQUIREMENTS

OPERATING SYSTEM COMPATIBILITY

The Drive is bundled with software drivers for MS-DOS/Windows systems, however, drivers for many other systems are also available.

BASIC SYSTEM REQUIREMENTS:

IBM PC/XT/AT/386 SYSTEMS

640 KB RAM

516 KB of Available Disk Space

DOS Version 3.1 or higher

SCSI Interface Card if your system dose not have one.

Empty slot for drive expansion

One Expansion Slot if a SCSI Interface Card is needed.

SCSI Cable

Power Cable

INSPECTION CHECKLIST

The Pioneer CD-ROM Drive is packaged with the following items:

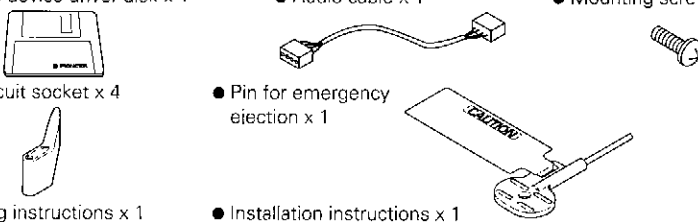
- Software device driver disk x 1*
 - Audio cable x 1
 - Mounting screw x 4
 - Short-circuit socket x 4
 - Pin for emergency ejection x 1
 - Operating instructions x 1
 - Installation instructions x 1
- 

* The Pioneer DR-U06S can be operated using any generic single SCSI CD-ROM device driver (e.g. as included in your Operating System software or supplied with your SCSI controller board). For details please refer to the manual supplied with your device driver.
In accordance with specific arrangements, the DR-U06S is in some countries shipping with a diskette containing device driver software. The references in this manual to device driver software are related to the Pioneer supplied version.
The enclosed device driver is for use with MS-DOS/Windows 3.XX. This driver is not required for use with Windows 95.

* MS-DOS and Windows are trademarks of Microsoft Corporation.

A HARDWARE TOUR

Illustrations are provided in this chapter as a visual introduction to the Drive. Please Familiarize yourself with these illustrations and refer to them when necessary to complete the installation and operation of the unit.

Front View

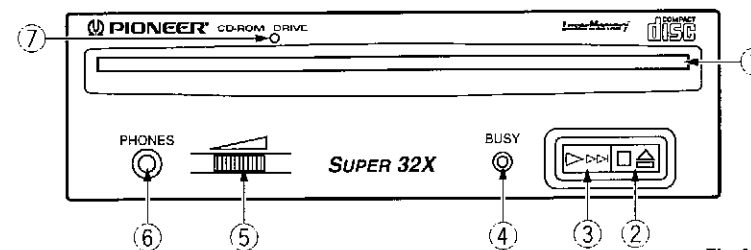



Fig.1

1. Disc loading slot

Insert the CD-ROM with the label facing up.

PRECAUTIONS ON PLAYING CD SINGLES (8 cm Discs):

- When playing CD singles (8 cm discs), always use the adapter for 8 cm discs. Before loading the disc into the CD-ROM drive unit, be sure to check that it is secured properly by the catches of the adapter. If discs have been inserted without the adapter by mistake, remove the disc immediately by pressing the eject button. If the disc does not come out with one press, press another time.
- Use 8 cm disc adapters labeled with the  mark (recommended standard product). Do not use adapters which cause the disc to idle, nor adapters which are bent or curved.

2. Stop (■)/Eject (▲) button

This button is used to eject the disc. When this button is pressed once during playback of an audio disc, the playback will be stopped, and when it is pressed in stopped condition, the disc will be ejected.

3. Play (▶)/Skip (▶▶) button

This is used for direct playback of audio discs. When an audio disc is inserted and this button is pressed, play status will be reached, and when this button is pressed in play status, the playback will skip to the next track. Data discs will not be played back

4. BUSY indicator

This flashes during data access.

5. Volume Control (headphone level)

This is used to adjust the volume level of the headphone jack.

6. Headphone jack (PHONES)

This is a stereo minijack for headphones.

7. Hole for forced ejection

When the eject button has lost its function, insert an accessory pin for emergency ejection into this hole and push to eject the disc.

WARNING:

- Before executing this operation, be sure to switch off the power supply of the computer and confirm that the disc loading is stopped. It takes approx. 60 seconds to stop loading a disc after switching off the power supply.
- Always use the pin provided (Do not use other objects).

A HARDWARE TOUR

Rear View

The display is on the top panel.

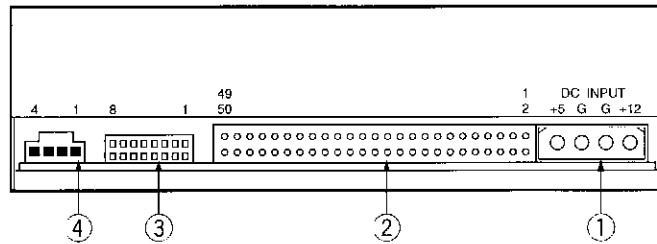

Fig.2

1 DC Input

This is the input for DC +5 V and +12 V. Connect the computer power supply.

2 SCSI interface

This is a 50-pin I/O connector according to the SCSI-2 specifications. Use a flat ribbon SCSI connector to connect to the SCSI host adapter.

3 Function switch

Use the accessory short-circuit sockets to set the SCSI ID number and the drive function.

4 Audio output

This is a connector for analog audio output. As a Molex 70553 is used, please select a suitable connection cable.

INSTALLATION

HARDWARE SETUP OVERVIEW

This chapter describes the steps required to connect your Pioneer Drive to your PC. Prior to installation, there are a few things you should know about this product.

- ◆ **First**, the Drive is a SCSI device. What is a SCSI device? SCSI is an acronym for Small Computer System Interface. A SCSI system allows up to seven SCSI devices (including CD-ROM drives, hard disks, scanners, and tape drives) to be connected to each other in a series called a "daisy chain". A SCSI interface is the physical connection between a SCSI device and a computer serving as a pipeline to transfer data between the two.
- ◆ SCSI devices can be installed as an **internal** (inside your computer) device, as an **external** (outside your computer) device, or both. This unit is an internal drive. Once connected, signals are passed through the chain from one device to the next and order is kept by assigning a unique SCSI ID number to each device. The *last* device in a SCSI chain must be terminated to maintain the quality of the electrical signals in the cable.
- ◆ **Second (PCs only): Your System Must Have a SCSI Interface Card.** If your system does not have a SCSI interface, you must buy and install one.
- ◆ **Third, Use the Proper Cable.** After installing a SCSI interface card or identifying the existing SCSI interface, it must be connected to your Drive using the proper cable. A 50-pin flat ribbon cable is used to connect this unit to the computer. Connection instructions are given on pages 16, 17.

SCSI COMPATIBILITY

If your interface card is not listed in the software installation menu, the card may still operate with your Drive. An ASPI* device driver is included with the Pioneer software which provides an interface between the Drive and a SCSI interface card. The ASPI driver translates the peculiarities of the interface card into a standard interface protocol thus establishing compatibility with the Drive. There is one requirement, the interface card must have a software device driver known as an ASPI Manager.

If you are uncertain whether your card came with an ASPI Manager, check the documentation for the card. If you find that the card didn't come with an ASPI Manager, contact the manufacturer or check with an Authorized Pioneer Dealer to see if a driver is now available.

INTERFACE CARD RECOMMENDATIONS

Pioneer drivers have been written to work with built-in SCSI port, on PCs with Future Domain SCSI Interface Cards, IBM SCSI Interface Cards, and ASPI compatible interface cards. Other SCSI interface cards require drivers provided by the manufacturer of the card.

INSTALLING A SCSI INTERFACE CARD IN A PC

SCSI interface card installation instructions accompany the card. For best results, follow the instructions that ship with the card.



Note: The SCSI interface card must be properly installed before continuing with the Drive installation.

INSTALLATION

SETTING THE SCSI ID

SCSI devices are identified by a SCSI ID number from 0 through 7 with ID number 7 typically reserved for the SCSI interface card. The basic rule for assigning a SCSI ID number requires that: *Each SCSI device have a unique ID number (address) on the SCSI bus. If two SCSI devices are assigned the same ID number, your computer will not operate properly.*

Assigning a SCSI ID to the Drive if you have a PC:

To avoid conflicts with an existing SCSI device and the interface card, choose an unassigned number in the range of 0-6.

Tip:  Make list of your SCSI devices and their assigned ID numbers to avoid a SCSI ID conflict.

Assigning a SCSI ID to the Drive:

- The three SCSI ID setting switches 0, 1, and 2 (#1, #2 and #3) compose a digital switch. Please execute setting according to the following table.
The jumper is ON when a short-circuit socket is inserted to short-circuit the upper and lower pin, and it is OFF in open condition.
*If the personal computer has no other built-in SCSI equipment except this unit, please use the unit with the factory setting (ID No. 2).

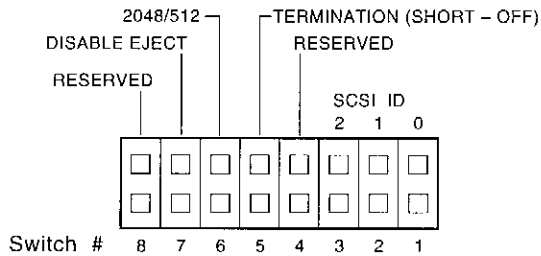

Setting switch	SCSI-ID							
	0	1	2*	3	4	5	6	7
0 (LSB) (#1)	OFF	ON	OFF	ON	OFF	ON	OFF	ON
1 (#2)	OFF	OFF	ON	ON	OFF	OFF	ON	ON
2 (MSB) (#3)	OFF	OFF	OFF	OFF	ON	ON	ON	ON

OFF (open) ON (short-circuited) * The factory setting is for ID No. 2.



WARNING

DO NOT assign SCSI ID number 7 which is normally reserved for the SCSI interface.

INSTALLATION

SCSI TERMINATION

SCSI termination is a technique used to absorb line reflections at the beginning and end of a SCSI daisy chain that would otherwise interfere with legitimate SCSI signals and cause errors. To minimize interference with data transfer, SCSI termination is absolutely required for proper operation of your Drive.

WHEN TERMINATION IS REQUIRED

If you are installing the Drive as the *only* SCSI device or as the *last* SCSI device in the chain, termination must be enabled.

A built-in terminator switch is located on the rear panel. Function Switch #5 is used to enable or disable termination as described on page 14.

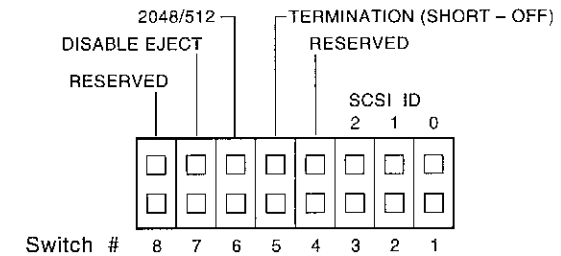

As you can see in the above illustrations, whether you have an ON/OFF Terminator Switch or a Termination Function Switch, your Drive has an **ON/OFF termination** option.

- ON:** The *Terminator Switch* must be open when the drive is:
- ♦ the *only* SCSI device connected to an interface card; and/or
 - ♦ the *last* physical device in a daisy-chain.
- OFF:** The Terminator Switch must be short-circuited when the drive is
- ♦ connected in the *middle* of a SCSI chain.

SETTING FUNCTION SWITCHES

Function Switches, also known as Jumper Switches, control the operational functions of the CD-ROM Drive.

The jumper is ON when a short-circuit socket is inserted to short-circuit the upper and lower pin, and it is OFF in open condition.

INSTALLATION

SWITCH SETTING TABLE

The display is on the top panel.

Switch 4 - Reserved

MUST BE SET TO OFF (OPEN)

Switch 5: SCSI Terminator

The built-in switch which enables or disables SCSI termination.

Short = SCSI Termination OFF : SCSI termination disabled (factory default setting).
Open = SCSI Termination ON: SCSI termination enabled.

Note: This information is described in detail earlier in this chapter under SCSI Termination on page 13.

Switch 6: Default Sector Size

Set the default sector size for the Drive when the drive is ON.

Short = 512-byte sector size (required for some UNIX systems)

Open = 2048-byte (2K) sector size (factory default setting)

For PC systems, the recommended setting is OFF (open). To confirm which sector size should be used in your system, refer to your system documentation.

Switch 7 - Disable Eject Button

Specifies if the power is ON to the front panel eject button.

Short = Disables the eject button.
Open = Enables the eject button (factory default setting).

Switch 8 - Reserved

MUST BE SET TO OFF (OPEN)

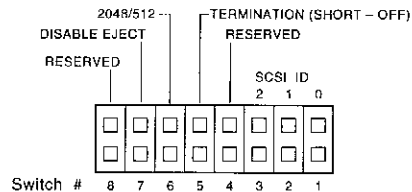

TO INSTALL THE DRIVE

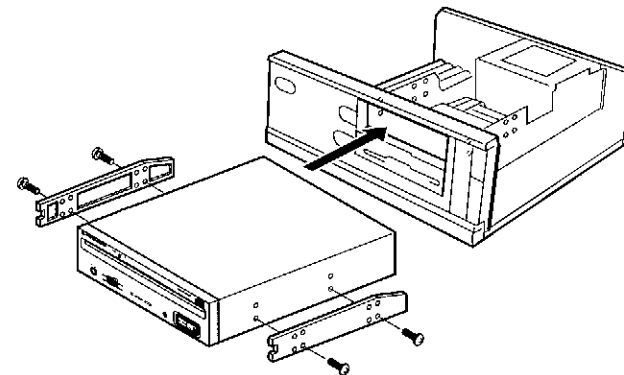

Fig.3

- Switch off the power of the personal computer and remove the cover or the front panel.
- Remove the blank panel installed at the front of the 5.25 inch slot.
Installation is not possible when there is no empty slot.
- Install the fixation slide rails on the drive. (If slide rails are required, contact the shop where you bought the computer or the computer manufacturer.)
- Insert the drive into the slot.
- If fixing is required, fix the drive according to the instruction manual for the computer.



Use mounting screws with a length of 5 mm or less.
Use of long screws may damage the drive.



Install the drive after the power supply of the personal computer has been switched off.



When the mounting screws are loose etc., the vibrations from disc rotation can generate a ripping noise, so that the screws should be tightened securely.



The drive installation method differs according to the computer type. For details, please refer to the manuals of your computer.



WARNING

The short-circuit switches always must be inserted vertically, never horizontally.

CONNECTING THE DRIVE IN THE MIDDLE OF A SCSI CHAIN

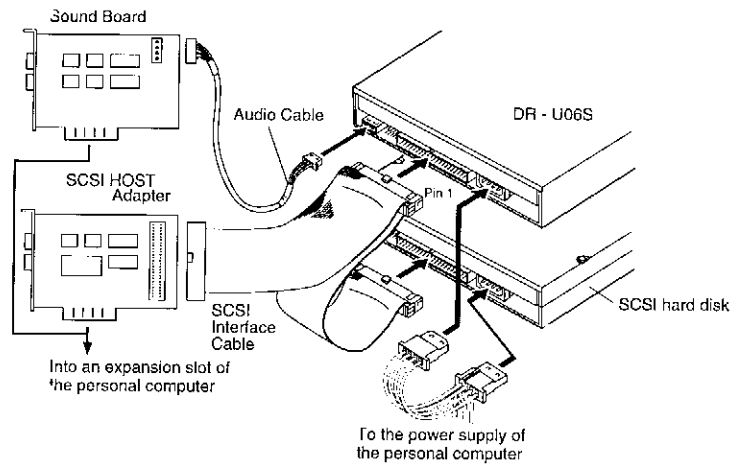

Fig.4

When a SCSI hard disk or other SCSI equipment also is installed in the computer, please connect according to the following method.

- Switch off the power supply of the personal computer.
- Set the SCSI ID number so that it is different from the ID numbers of all other SCSI units.
- Set the termination OFF.
- Connect the power supply cable from the personal computer. At the time of connection, pay attention to the cable polarity. Please use a power supply cable with two or more connectors in parallel.
- Connect the SCSI interface cable. At this time, confirm that the pin 1 of the SCSI connector is connected correctly to pin 1 of the cable. Use a cable with two or more connectors in parallel.
- When a sound board is used, connect the audio output with an audio cable to the sound board.

CONNECTING THE DRIVE AS THE ONLY SCSI DEVICE

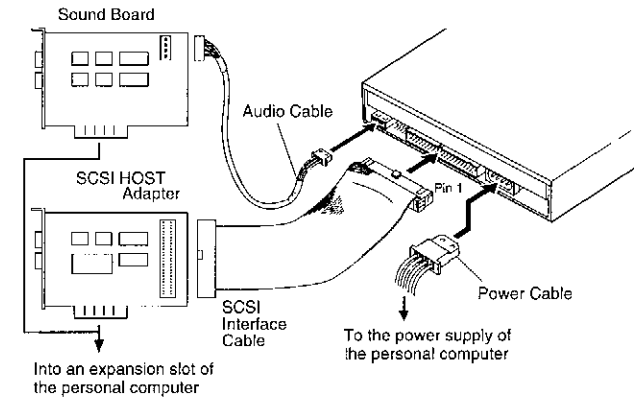

Fig.5

When no SCSI hard disk or other SCSI equipment is used, connect according to the following connection method.

- Switch off the power supply of the personal computer.
- Set the SCSI ID number.
- Set the termination ON.
- Connect the power supply cable from the personal computer. At the time of connection, please pay attention to the cable polarity.
- Connect the SCSI interface cable. At this time, confirm that the pin 1 of the SCSI connector is connected correctly to pin 1 of the cable.
- When a sound board is used, connect the audio output with an audio cable to the sound board.



WARNING

The power supply of the personal computer always must be switched off before cables are connected.

DISC OPERATION

DISC SETTING METHOD

- Disc setting
Insert the disc into the disc loading slot with the label facing up.
When using 8 cm discs, attach a CD adapter (available at stores) to the disc, and insert the disc into the disc loading slot.

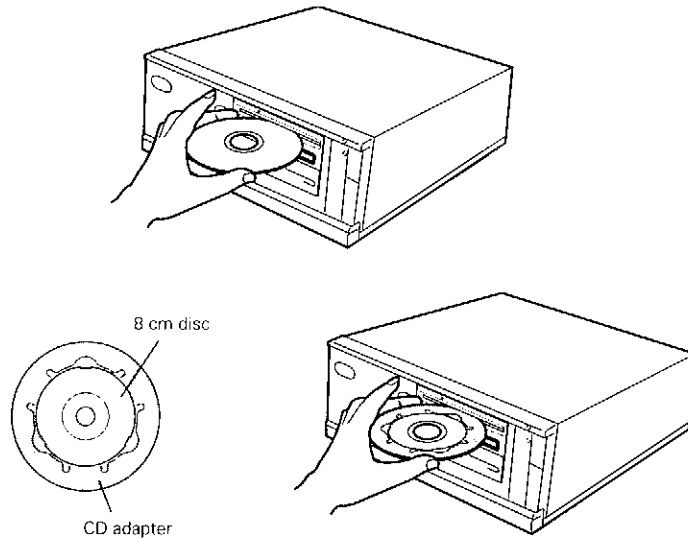

Fig.6



Do not insert 8 cm discs by themselves.



When using a CD adapter, attach it properly to the disc, and check that it does not come off to prevent damage to the disc and adapter.



Do not attempt to insert more than two discs at one time, nor insert discs during play.



Do not insert the disc with excessive force so that it bends nor attempt to insert it by force. While the unit is pulling in or ejecting discs, do not attempt to do the opposite using force as this may cause damage to the disc or malfunction of the unit.

DISC OPERATION

DISC REMOVAL METHOD

- Confirm that the BUSY indicator of the drive is not lit, and then press the Eject button (▲).
- Remove the disc after it has been ejected.

FORCED EJECTION METHOD IN CASE OF EMERGENCY

In the following cases, the disc can be removed using the forced ejection hole.

- ◆ In case of drive trouble, when the disc can not be ejected with the Eject button or by a software command.
- ◆ When the disc is to be removed while the power is switched off.
- Confirm that the power supply of the computer is switched off and the disc loading is stopped. It takes approx. 60 seconds to stop loading a disc after switching off the power supply. While this operation, do not execute the forced ejection.
- Use an accessory pin for emergency ejection, insert it straight into the hole for forced ejection, and push strongly.

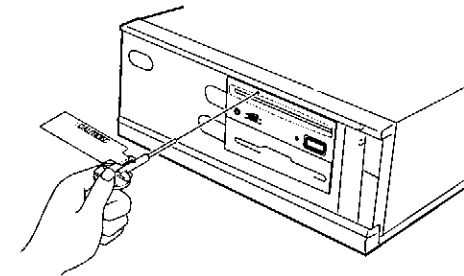

Fig.7

- As the disc will be ejected approx. 5-10 mm from the disc loading slot, pull it out by fingers.



Do not execute the forced ejection while loading a disc, an injury or a disc damage will be caused.



Do not place anything within 12 cm in front of the unit as this may obstruct the disc ejection operation of the unit.

SPECIFICATIONS

[General functions]

Disc diameter 12 cm (4.72 in), 8 cm (3.15 in)

Transfer rate Sustained 2,100 – 4,950 kBytes/sec*

* The data transfer rate may not be output for some disc conditions (scratches, etc.).

Seek time Random (average) 60 ms

Access time Random (average) 70 ms

Data buffer capacity 128 kBytes

[Audio output part]

Line 0.7 Vrms ± 0.1 Vrms (at 10 kΩ load)

[Others]

Power supply DC +12 V, 0.9 A (peak), 0.55 A (normal)

(With the built-in terminator) DC +5 V, 1.8 A (peak), 0.75 A (normal)

External dimensions 148 (W) x 42.3 (H) x 207.5 (D) mm
5-27/32 (W) x 1-11/16 (H) x 8-6/32 (D) in

Weight 0.99 kg (2.2 lb)

Operation temperature + 5°C to +45°C (41°F to 113°F)

Operation humidity 5% to 85% (no condensation)

Storage temperature – 40°C to +60°C (–40°F to 140°F)

Storage humidity 5% to 90% (no condensation)

[Accessories]

- Software device drive disk x 1
- Short-circuit socket x 4
- Audio cable x 1
- Mounting screw x 4
- Pin for emergency ejection x 1
- Operating instructions x 1
- Installation instructions x 1

NOTE:

Specifications and design subject to possible modifications without notice, due to improvements.

TROUBLESHOOTING

Incorrect operations are often mistaken for trouble and malfunctions. If you think that there is something wrong with this unit, check the points below according to the symptom.

If your computer did not start up correctly because the initial diagnostics did not recognize a SCSI device, check these items:

- Were all of your SCSI devices plugged in and turned on before you started your computer?
The Drive *and* all of the SCSI devices in the daisy chain must be turned on before you start your computer.
- Are your cables connected properly?
All cables must be attached to the correct ports.
- Are your SCSI IDs set properly?
Each device on a SCSI chain must have a unique SCSI ID.
- Have you set termination properly?
If the Drive is the *only* SCSI device, it must be terminated.
- Have you installed the software driver properly that came with your Drive?
If you have not installed the software device drivers yet, refer to the *Installation instructions*.

If data cannot be read from the CD-ROM disc:

- Is this disc properly inserted in the slot with the label side facing ↑ UP ?
- Is the *BUSY* indicator light on ?
- Is the disc in proper operating condition ?
- Is the SCSI cable connected correctly to the interface card and/or other SCSI devices ?
- Are you sure there is a disc in the slot (drive) you are trying to access ?

If music cannot be played back:

- Are you sure an audio CD is being used ?
- Is the audio amplifier, powered speakers, or headphone set connected ?
- Are you using CD-DA Audio ?

Some audio formats require an audio sound card in the computer to decode digital Audio CD-DA.

- Are you operating the Drive that is not connected to a SCSI 2 interface card ? Bringing digital audio from the CD-ROM disc into the computer requires a SCSI 2 interface card.
- Is the volume turned high enough ?

Free Manuals Download Website

<http://myh66.com>

<http://usermanuals.us>

<http://www.somanuals.com>

<http://www.4manuals.cc>

<http://www.manual-lib.com>

<http://www.404manual.com>

<http://www.luxmanual.com>

<http://aubethermostatmanual.com>

Golf course search by state

<http://golfingnear.com>

Email search by domain

<http://emailbydomain.com>

Auto manuals search

<http://auto.somanuals.com>

TV manuals search

<http://tv.somanuals.com>