

Pioneer

DVD SURROUND SYSTEM

HTZ-55DV

Operating Instructions

IMPORTANT



The lightning flash with arrowhead symbol, within an equilateral triangle, is intended to alert the user to the presence of uninsulated "dangerous voltage" within the product's enclosure that may be of sufficient magnitude to constitute a risk of electric shock to persons.

CAUTION

**RISK OF ELECTRIC SHOCK
DO NOT OPEN**

CAUTION:
TO PREVENT THE RISK OF ELECTRIC SHOCK, DO NOT REMOVE COVER (OR BACK). NO USER-SERVICEABLE PARTS INSIDE. REFER SERVICING TO QUALIFIED SERVICE PERSONNEL.



The exclamation point within an equilateral triangle is intended to alert the user to the presence of important operating and maintenance (servicing) instructions in the literature accompanying the appliance.

These labels can be found on the unit's bottom panel.

Ces étiquettes se trouvent sur le fond de l'appareil.



CAUTION

**RISK OF ELECTRIC SHOCK
DO NOT OPEN**

ATTENTION

**DANGER D'ELECTROCUTION
NE PAS OUVRIR**

Note: This equipment has been tested and found to comply with the limits for a Class B digital device, pursuant to Part 15 of the FCC Rules. These limits are designed to provide reasonable protection against harmful interference in a residential installation. This equipment generates, uses, and can radiate radio frequency energy and, if not installed and used in accordance with the instructions, may cause harmful interference to radio communications. However, there is no guarantee that interference will not occur in a particular installation. If this equipment does cause harmful interference to radio or television reception, which can be determined by turning the equipment off and on, the user is encouraged to try to correct the interference by one or more of the following measures:

- Reorient or relocate the receiving antenna.
- Increase the separation between the equipment and receiver.
- Connect the equipment into an outlet on a circuit different from that to which the receiver is connected.
- Consult the dealer or an experienced radio/TV technician for help.

CAUTION

This product satisfies FCC regulations when shielded cables and connectors are used to connect the unit to other equipment. To prevent electromagnetic interference with electric appliances such as radios and televisions, use shielded cables and connectors for connections.

CAUTION

- Use of controls or adjustments or performance of procedures other than those specified herein may result in hazardous radiation exposure.
- The use of optical instruments with this product will increase eye hazard.

Information to User

Alteration or modifications carried out without appropriate authorization may invalidate the user's right to operate the equipment.

WARNING: TO PREVENT FIRE OR SHOCK HAZARD, DO NOT EXPOSE THIS APPLIANCE TO RAIN OR MOISTURE.

THE STANDBY/ON BUTTON IS SECONDARY CONNECTED AND THEREFORE DOES NOT SEPARATE THE UNIT FROM MAINS POWER IN STANDBY POSITION.

POWER-CORD CAUTION

Handle the power cord by the plug. Do not pull out the plug by tugging the cord and never touch the power cord when your hands are wet as this could cause a short circuit or electric shock. Do not place the unit, a piece of furniture, etc., on the power cord, or pinch the cord. Never make a knot in the cord or tie it with other cords. The power cords should be routed such that they are not likely to be stepped on. A damaged power cord can cause a fire or give you an electrical shock. Check the power cord once in a while. When you find it damaged, ask your nearest PIONEER authorized service center or your dealer for a replacement.

CAUTION

This product contains a laser diode of higher class than 1. To ensure continued safety, do not remove any covers or attempt to gain access to the inside of the product. Refer all servicing to qualified personnel.

The following caution appears on your unit.
Location: bottom of the unit

**CLASS 1
LASER PRODUCT**

CAUTION : LASER RADIATION WHEN OPEN.
: AVOID EXPOSURE TO BEAM.
VORSICHT : LASERSTRAHLUNG, WENN ABDECKUNG GEÖFFNET
: NICHT DEM STRAHL AUSSETZEN!
ADVARSEL : LASERSTRÅLING VED ÅBNING UDGÅ
: UDSÆTTELSE FOR STRÅLING.
VARNING : LASERSTRÅLNING NÄR DENNA DEL ÄR
: ÖPPNAD BETRÄKTA EJ STRÅLEN.
VARO! : AVAITAESSA ALTISTUT LASERSÄTEIL YLLE.
: ÄLÄ KATSO SÄTEESSEN.

VRW1697

Thank you for buying this Pioneer product.

Please read through these operating instructions so you will know how to operate your model properly. After you have finished reading the instructions, put them away in a safe place for future reference.

In some countries or regions, the shape of the power plug and power outlet may sometimes differ from that shown in the explanatory drawings. However, the method of connecting and operating the unit is the same.

Installation Precautions

- Install components so that there are no obstructions above or either side of them, or by ventilation holes. Also install 10cm away from the wall as shown in the figures. Components feature ventilation holes on the bottom so do not install on thick pile carpets or other surfaces that may block them.
- Use a vacuum cleaner periodically to clean the port of the subwoofer to keep it free of dust.

Powered subwoofer unit (S-DV55SW)

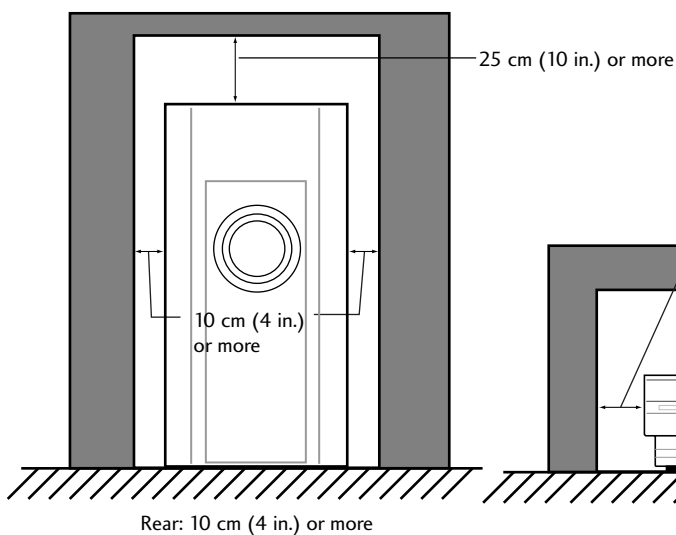

Line Voltage Selector Switch

Only multi-voltage models are provided with this switch. There is a Voltage Selector. Australian model is not provided with this switch. Be sure this is set correctly.

Mains voltages in Saudi Arabia are 127 V and 220 V only.

Always check that this selector is set properly before plugging the power cord into the wall outlet.

1. **Disconnect the power cord.**
2. **Use a small-sized screwdriver (flat blade).**
3. **Insert the screwdriver into the groove on the voltage selector, and adjust the voltage selector.**

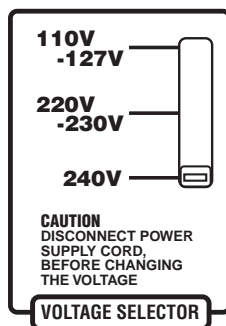

CAUTION 240V

Power source voltage is factory adjusted 240 volts. If your area is different, change voltage selector setting.

DVD Tuner system (XV-DV55)

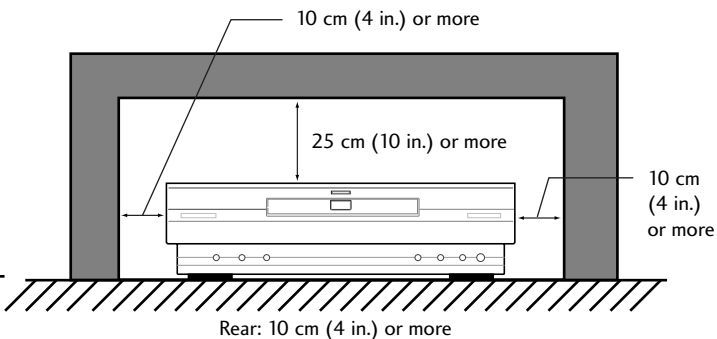

Contents

1 Before You Start		7 Using the Timer	
Features	5	Using the wake up timer	31
Using this manual	5	Activating/deactivating the wake up timer	31
Hints on installation	6	Checking the timer settings	32
Avoiding problems with condensation	6	Using the sleep timer	32
Moving the system	6	8 Making a Recording	
Discs compatible with this system	6	Making an audio or a video recording	33
DVD Video regions	6	Making a digital recording	33
2 Controls and Displays		9 DVD Settings	
Front panel	7	Using the Setup menu	34
Display	7	OSD settings	34
Remote control	8	Setup Menu Mode	34
3 Getting Started		OSD language	34
Introduction	10	On Screen Display (Expert)	34
Switching on and setting the clock	10	Video settings	35
Switching the time format	10	TV Screen Size	35
Setting up for surround sound	11	Adjusting the video quality	35
Setting the speaker distances	11	Still Picture (Expert)	35
Balancing the surround sound	12	Angle Indicator (Expert)	35
Using the setup navigator	13	Audio settings	36
Playing DVD Video discs	14	Dolby Digital Out	36
Playing CDs	16	Linear PCM Out	36
Playing Video CDs	17	Language settings	36
Listening to the radio	18	Audio Language	36
Improving FM stereo sound	18	Subtitle Language	37
Listening to other components	19	Auto Language	37
Switching between digital and analog sources	19	DVD Language (Expert)	38
4 Shaping the Sound		Subtitle Off (Expert)	38
Adjusting the bass and treble	20	Subtitle Display (Expert)	38
Using P.Bass	20	Miscellaneous settings	39
Using sound modes	21	Parental Lock	39
Listening to surround-sound sources with room effects	21	Changing the parental lock level	39
Listening to other sources with room effects	22	Changing your password	40
Listening at low volume	22	Background Color (Expert)	40
Adjusting channel volume levels	22	10 Advanced Sound Settings	
5 Using the DVD Player		Advanced sound settings	41
Introduction	23	LFE attenuator	41
Finding what you want on a disc	23	Dynamic Range Control	41
Switching camera angles (DVD only)	24	Dual-mono setting	42
Switching subtitles (DVD only)	24	11 Controlling Other Equipment	
Switching audio language (DVD only)	24	Setting up the remote control	43
Programming playlists	24	Setting up using component presets	43
Programming a DVD playlist	25	Reassigning a MULTI CONTROL button	44
Programming a CD/Video CD playlist	26	Learning directly from other remote controls	45
More programming options	26	Deleting a single command	46
Using repeat play	27	Deleting all commands for a component	46
Using random play	27	Controlling a component while playing another	46
DVD	27	Clearing all remote control settings	47
CD/Video CD	27	Checking preset codes	47
Bookmarking a place in a disc (DVD/Video CD)	28	CD/MD/CD-R/VCR/LD player controls	48
Memorizing disc settings (DVD only)	28	Cassette deck controls	49
Displaying disc information	29	DVD/DVR player controls	50
6 Using the Tuner		DTV controls	51
Saving station presets	30	Cable TV/satellite TV/TV controls	52
Listening to station presets	30		

12 Connecting Up

Connecting to a TV with the supplied video cord	53
Connecting to a TV with an S-Video cord	53
Playing your TV through this system	53
Watching TV	53
Connecting Other Components	54
Connecting an audio recorder	54
Connecting Outdoor Antennas	55
Connecting an Outdoor AM Antenna	55
Connecting an Outdoor FM Antenna	55

13 Additional Information

Setting the display brightness	56
Switching the TV system output	56
Taking care of your system	57
Disc lens cleaner	57
Taking care of your discs	57
Storing discs	57
Discs to avoid	57
Glossary	58
DVD language code list	59
Preset Code List	60
Troubleshooting	64
Resetting the player	66
Screen sizes and disc formats	66
Component features & functions	67
DVD tuner system	67
Powered subwoofer unit	67
Display unit	67
Specifications	68

Features

- **Superlative audio performance with Dolby Digital* and DTS** software**

The HTZ-55DV delivers breathtaking sound quality with Dolby Digital and DTS discs, and is also compatible with 96kHz/24-bit PCM sources.

- **New graphical Setup Navigator**

Setting up your home theater is easy using the graphical Setup Navigator. Answer the questions that appear on-screen and the Setup Navigator makes the necessary audio, video and language settings for you.

- This product incorporates copyright protection technology that is protected by method claims of certain U. S. patents and other intellectual property rights owned by Macrovision Corporation and other rights owners. Use of this copyright protection technology must be authorized by Macrovision Corporation, and is intended for home and other limited viewing uses only unless otherwise authorized by Macrovision Corporation. Reverse engineering or disassembly is prohibited.

* Manufactured under license from Dolby Laboratories. "Dolby", "Pro Logic" and the double-D symbol are trademarks of Dolby Laboratories. Confidential unpublished works. © 1992-1997 Dolby Laboratories. All rights reserved.

** "DTS" and "DTS Digital Surround" are trademarks of Digital Theater Systems, Inc. Manufactured under license from Digital Theater Systems, Inc.

Using this manual

This manual is for the HTZ-55DV DVD Surround System. It is divided into several sections: information for before you start using the system (chapters 1-2); getting started using the system (chapters 3-4); more advanced features (chapters 5-8); system settings and preferences (chapters 9-10); using this remote control with other components (chapter 11); connecting up the system and using this system with external components (chapter 12). Chapter 13 provides additional information, including a glossary of terms used in this manual, and a troubleshooting section.

Hints on installation

We want you to enjoy using this unit for years to come, so please bear in mind the following points when choosing a suitable location for it:

Do...

- ✓ Use in a well-ventilated room.
- ✓ Place on a solid, flat, level surface, such as a table, shelf or stereo rack.

Don't...

- ✗ Use in a place exposed to high temperatures or humidity, including near radiators and other heat-generating appliances.
- ✗ Place on a window sill or other place where the system will be exposed to direct sunlight.
- ✗ Use in an excessively dusty or damp environment.
- ✗ Place directly on top of an amplifier, or other component in your stereo system that becomes hot in use.
- ✗ Use near a television or monitor as you may experience interference—especially if the television uses an indoor antenna.
- ✗ Use in a kitchen or other room where the system may be exposed to smoke or steam.
- ✗ Use on a thick rug or carpet, or cover with cloth—this may prevent proper cooling of the unit.
- ✗ Place on an unstable surface, or one that is not large enough to support all four of the unit's feet.

Avoiding problems with condensation

Condensation may form inside the system if it is brought into a warm room from outside, or if the temperature of the room rises quickly. Although the condensation won't damage the system, it may temporarily impair its performance. For this reason you should leave it to adjust to the warmer temperature for about an hour before switching on and using.

Moving the system

If you need to move the system, first switch it off and unplug from the wall outlet. Never lift or move the unit during playback—discs rotate at a high speed and may be damaged.

Discs compatible with this system

Any disc that displays one of the following logos should play in this system. Other formats, including DVD-RAM, DVD-ROM, DVD-Audio, CD-ROM, SACD and Photo CD will not play.



Single or double sided / Single or double layer.

Dolby Digital, DTS, MPEG or Linear PCM digital audio.

MPEG-2 digital video.

Discs are generally divided into one or more 'titles'. Titles are further subdivided into 'chapters'.



Single sided / Single layer. 12 cm or 8 cm (5" or 3") discs.

Linear PCM digital audio. (Also compatible with finalized CD-Recordable discs.)

Discs are divided into 'tracks'.

This system can play CD-R and CD-RW discs recorded with audio. However, depending on the quality of the initial recording, and the condition of the disc, you may find that not all discs will play successfully. (For example, if the disc is scratched or dirty, or if the player's pickup lens is dirty.) Some CD-R and CD-RW discs may need to be finalized* before playing successfully.

- * Check with the instruction manual of the recording component used to make the CD-R or CD-RW disc for finalization procedures.



Single sided / Single layer. 12 cm or 8 cm (5" or 3") discs.

MPEG-1 digital audio. MPEG-1 digital video. Discs are divided into 'tracks'.

DVD Video regions



All DVD Video discs carry a region mark on the case somewhere that indicates which region(s) of the world the disc is compatible with. Your DVD system also has a region mark, which you can find on the rear panel. Discs from incompatible regions will not play in this system. Discs marked **ALL** will play in any player.

Front panel

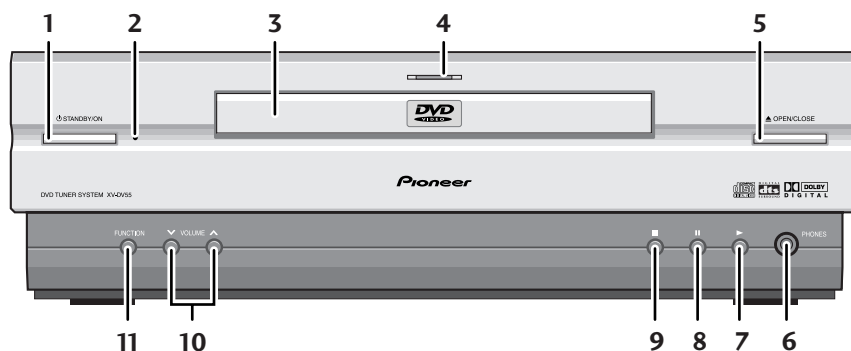

- 1 **STANDBY / ON** – Press to switch the system on or into standby.
- 2 **Standby/timer indicator** – Lights red when the system is in standby; lights in green if the timer has been set.
- 3 **Disc tray**
- 4 **DVD function indicator** – Lights when the system is set to the DVD function.
- 5 **▲ OPEN/CLOSE** – Press to open or close the disc tray.
- 6 **PHONES** – Plug in a pair of headphones for private listening.
- 7 **▶** – Press to start or resume playback.
- 8 **⏸** – Press to pause a disc that's playing, or restart a paused disc.
- 9 **■** – Press to stop the disc.
- 10 **VOLUME controls** – Use to adjust the overall system volume.
- 11 **FUNCTION** – Press to select the input source (DVD, tuner, etc.)

Display

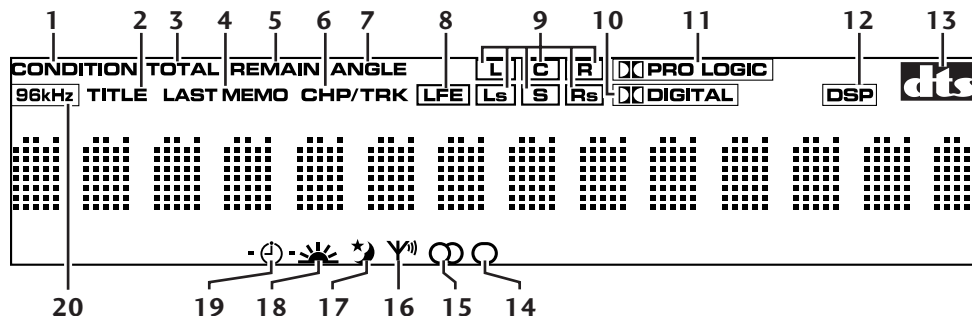

- 1 **CONDITION** – Indicates playback settings (condition) are memorized.
- 2 **TITLE** – Indicates a title playback.
- 3 **TOTAL** – Indicates total playback time of disc side currently playing.
- 4 **LAST MEMO** – Indicates that the location on a disc where you last stopped watching is memorized.
- 5 **REMAIN** – Indicates remaining playback time.
- 6 **CHP/TRK** – Indicates playback of a chapter or track.
- 7 **ANGLE** – Indicates multi-angle playback.
- 8 **LFE** – Lights if the current Dolby Digital or DTS source has a Low Frequency Effects (LFE) channel.
- 9 **Channel indicators** – Shows which channels are recorded on the disc loaded.
- 10 **DIGITAL** – Indicates Dolby Digital playback.
- 11 **PRO LOGIC** – Indicates Dolby Pro Logic playback.
- 12 **DSP** – Lights when a DSP mode or Advanced Theater effect is on.
- 13 **DTS** – Indicates DTS playback.
- 14 **Mono** – Lights when the mono FM reception mode is selected.
- 15 **Stereo Station Reception** – Lights during stereo broadcast station reception.
- 16 **Station Reception** – Lights during broadcast station reception.
- 17 **Sleep Timer** – Lights when the sleep timer is ON and during sleep timer operation.
- 18 **Wake-up Timer** – Lights when the wake-up timer is ON, and flashes during wake-up timer operation.
- 19 **Timer ON** – Lights when the wake-up timer is ON, and flashes during wake-up timer operation.
- 20 **96 kHz** – Lights during playback of a source with a sampling frequency of 96kHz.

Remote control

Many of the remote control's buttons have more than one function. To make things easier, the button names are color-coded:

- Sky blue – DVD and Video CD functions
- Yellow – tuner functions
- Pale purple – TV functions
- Green – sound and other system settings
- Orange – DVD and CD functions (press **SHIFT** first to access)
- Pink – Cable TV functions

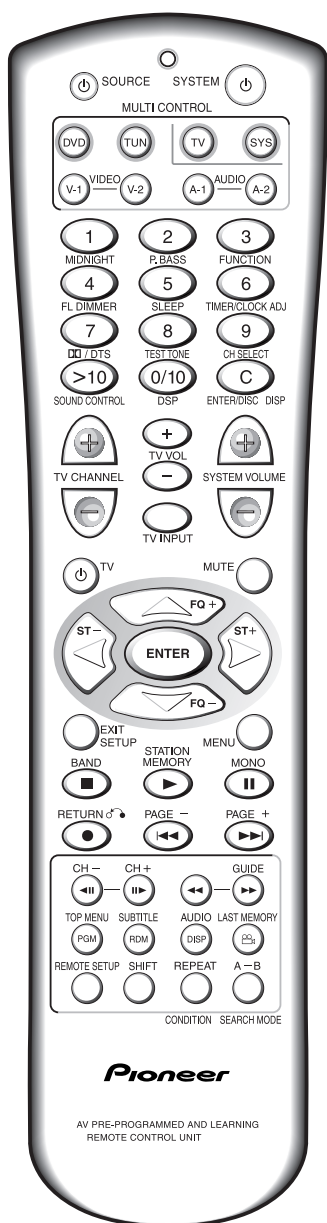

To learn how a particular button on the remote works, look up the function name in the alphabetical list below. Buttons labeled only with symbols appear first.

DD/DTS – Press to switch the Theater mode when listening to Dolby Digital or DTS DVD discs. For other discs, press to switch on Dolby Pro Logic.

■ – Press to stop a disc playing.

▶ – Press to start or restart a disc playing.

|| – Press to pause or restart a disc.

● – Press twice within 10 seconds to start recording on a recorder connected to the AUDIO 1 or VIDEO 1 outputs.

◀◀ – Press to skip back tracks/chapters/titles on a disc.

▶▶ – Press to skip forward tracks/chapters/titles on a disc.

◀|| – Use for slow motion reverse playback and frame reverse with a DVD or Video CD.

||▶ – Use for slow motion forward playback and frame advance with a DVD or Video CD.

◀◀ – Press and hold to reverse scan through a disc.

▶▶ – Press and hold to forward scan through a disc.

◻ – Press to switch the camera angle during a multi-angle scene on a DVD disc.

0/10 – Use as zero, or 10 when selecting tracks/chapters/titles from a DVD, Video CD or CD, or radio station presets.

1–9 (number buttons) – Use to select tracks/chapters/titles from a DVD, Video CD or CD, or radio station presets.

>10 – Use when entering a track/chapter/title or radio station preset number greater than 10. After pressing, input the required number (**>10**, **2**, **4** for 24, and so on).

A A-1 – Press to switch to an audio component connected to the AUDIO 1 inputs/outputs.

A-2 – Press to switch to an audio component connected to the AUDIO 2 inputs.

A-B – Use to set the start and end points of a repeating loop.



AUDIO (sky blue) – Press to switch to another audio channel or language on the disc playing.

B BAND – Press to switch between AM and FM bands when listening to the radio.

C C – Press to clear settings or entries.

CH+ / CH- – Press to change channels on a satellite tuner, cable box, VCR, etc.

CH SELECT – Press to select the speaker channel when setting up your system for surround sound.

- CONDITION** – Press to save the current settings for the DVD disc playing. Next time you load the disc, the player will automatically revert to these settings.
- D DISP (orange)** – Press to switch the displayed information for the DVD or CD loaded.
- DISP (green)** – Press to display the time.
- DSP** – Use to select a DSP room effect mode.
- DVD** – Press when you want to play a DVD, Video CD or CD.
- E ENTER** – Use to confirm menu choices, setups and so on.
- ENTER/DISC** – Used for controlling external components only. Function varies with the external component.
- EXIT** – Press to exit the guide feature of cable TV.
- F FL DIMMER** – Use to adjust the brightness of the fluorescent display.
- FQ+/-** – Use to manually tune to radio stations.
- FUNCTION** – Press to switch the system function (DVD, tuner, Video 1, etc.), without changing the remote control mode.
- G GUIDE** – Press to access the guide feature on cable TV.
- L LAST MEMORY** – Use to bookmark the current place on a DVD or Video CD disc, and to start playing from a previously bookmarked place on a disc.
- M MENU** – Press to display a DVD or Video CD disc menu for navigating the contents of a disc.
- MIDNIGHT** – Press to switch the Midnight listening mode on or off. This mode aids listening at low volume.
- MONO** – Press to listen to a stereo FM radio broadcast in mono (this can improve the sound quality). Press again to switch back to stereo.
- MUTE** – Press to mute the speakers. Press again to cancel the mute.
- P P.BASS** – Press to switch P.BASS on or off. Switch on for extended bass.
- PAGE +/-** – Press to display the next/previous page of a cable TV guide.
- PGM** – Use to program a playlist for a DVD, Video CD or CD.
- R RDM** – Use to set the random play mode when playing a DVD, Video CD or CD.
- REMOTE SETUP** – Press to put the remote into setup mode. Use to setup the remote to control other components in your system.
- REPEAT** – Use to set the repeat mode for a DVD, Video CD or CD.
- RETURN** – Use to return to the previous level of a DVD disc menu, or to display the menu of a Video CD playing in PBC mode.
- S SEARCH MODE** – Use to select a search mode (title, chapter, track, time) for a DVD, Video CD or CD.
- SETUP** – Press to show the on-screen display for making audio, video and other settings for DVD playback.
- SHIFT** – Press to access the remote functions printed in orange on the remote. After pressing, the shift mode remains in effect for up to 10 seconds.
- SLEEP** – Use to select a preset time until the system switches into standby.
- SOUND CONTROL** – Press to adjust the bass or treble.
- SOURCE ** – Press to switch on/off a source component (tape or MD deck, for example) connected to this system. (You need to set up the remote first for this to work).
- ST +/-** – Press to switch the station preset when listening to the radio.
- STATION MEMORY** – Use to save the current frequency as a station preset.
- SUBTITLE** – Press to switch the subtitle language on a multilingual DVD disc.
- SYS** – Press to switch the remote from TV control to system control without changing the source function of the system.
- SYSTEM ** – Press to switch the system on or into standby.
- SYSTEM VOLUME** – Use to adjust the overall system volume.
- T TEST TONE** – While setting up the channel levels of the speakers, press to start or stop the test tone.
- TIMER/CLOCK ADJ** – Use to set the timer or clock.
- TOP MENU** – Press to display the top level menu of a DVD disc.
- TUN** – Press to switch to tuner for listening to the radio.
- TV** – Press to switch the remote from system, DVD, tuner, etc. control to TV control.
- TV ** – Press to switch your TV on/off. (You need to set up the remote first for this to work).
- TV CHANNEL** – Use to change the TV channel.
- TV INPUT** – Press to switch the TV input (from internal tuner, to VCR1, and so on).
- TV VOL** – Use to adjust the TV volume.
- V V-1** – Press to switch to a video component connected to the VIDEO 1 inputs/outputs.
- V-2** – Press to switch to a video component connected to the VIDEO 2 inputs.

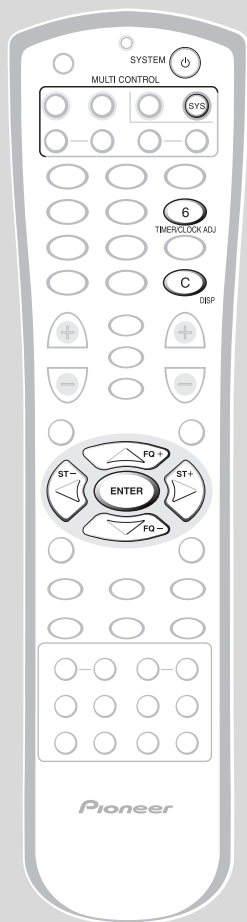

Introduction

This chapter covers switching on and setting the clock, using the Setup Navigator to set some basic preferences, using all the basic controls for playing discs, and using the tuner.

Switching on and setting the clock

This system has a built in clock, which needs to be set to be able to use the timer features.

- 1 Press **SYSTEM** to switch on.
- 2 Press **SYS** then **TIMER/CLOCK ADJ.**
- 3 Press the **<** or **>** button until you see **CLOCK ADJUST** in the display.

- 4 Press **ENTER**.

If you've just connected the power, the display shows **12:00 AM**, with the hour blinking.

- 5 Use the **Δ** and **∇** buttons to set the hour, then press **ENTER**.

- 6 Use the **Δ** and **∇** buttons to set the minute, then press **ENTER**.

The display blinks for 2 seconds to indicate that the time has been set.

Tip

Press **SYS** then **DISP** anytime to see the clock when the system is on or in standby.

Switching the time format

You can display the clock in either 12 or 24-hour format.

- 1 Switch the system into standby.
- 2 Press **SYS** then **TIMER/CLOCK ADJ.**
- 3 Press the **<** or **>** button until you see **CLOCK 12 HOUR** or **CLOCK 24 HOUR** in the display.

- 4 Use the **Δ** and **∇** buttons to select 12 or 24.
- 5 Press **ENTER**.

Setting up for surround sound

You can use this system right out of the box for surround sound with just the default settings. However, for really great surround sound, we recommend that you spend a few minutes making some settings that match this system to your listening room. These include setting the distances from your listening position to your speakers, and balancing the speaker volumes. Unless you change the layout of your speakers or main listening position, you only need to make these settings once.

Setting the speaker distances

1 Press **SYS**, then **SETUP**.

This puts the remote into surround setup mode.

2 Press the **◀** or **▶** button until you see **FRONT** in the display.

```
FRONT  SP  3.0m
```

3 Use the **△** and **▽** buttons to set the distance from your main listening position to the front speakers.

Ideally, your listening position should be equidistant from the two front speakers.

The default setting is 3m. You can adjust the range from 0.3m to 9.0m in steps of 0.3m.

4 Press **▶** to move on to the **CENTER** speaker setting.

```
CENTER SP  3.0m
```

5 Use the **△** and **▽** buttons to set the distance from your main listening position to the center speaker.

The default setting is 3m. You can adjust the range from 0.3m to 9.0m in steps of 0.3m.

6 Press **▶** to move on to the **SURROUND** speakers setting.

```
SURR.  SP  3.0m
```

7 Use the **△** and **▽** buttons to set the distance from your main listening position to the surround speakers.

Ideally, your listening position should be equidistant from the surround speakers.

The default setting is 3m. You can adjust the range from 0.3m to 9.0m in steps of 0.3m.

8 Press **ENTER** to make the last setting and exit.

- The setting mode is automatically exited if no operation is performed within 20 seconds.
- There are several other settings that you can make from the System Setup menu to further tailor your surround sound. See chapter 10 for more on this.
- The speaker distance settings have no effect when the Dolby/DTS mode is set to **VIRTUAL SURR1** or **VIRTUAL SURR2**. See page 21 for more on Dolby/DTS modes.

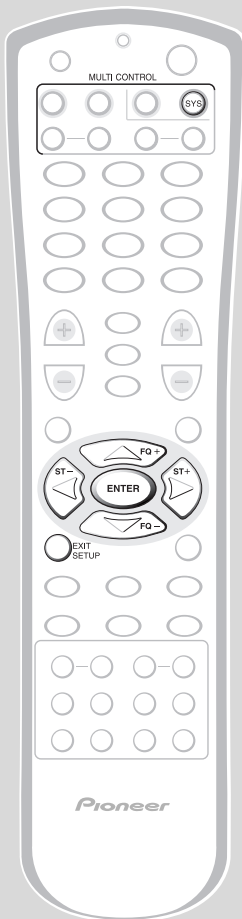

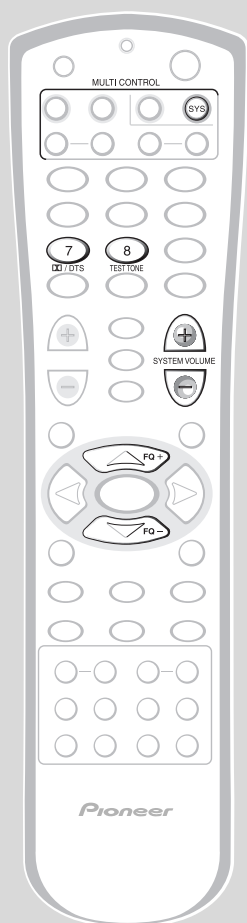

Balancing the surround sound

You can further improve surround sound performance by balancing the levels from the subwoofer, center and surround speakers relative to the front left/right speakers. To help you judge the sound level of each speaker a test tone is played through each speaker in turn (make sure that there are no headphones connected). Adjust the levels until they all sound equal.

The levels you set here will apply to all Dolby/DTS modes. However, you can set levels independently for each DSP mode.

Note: it may not be possible to accurately adjust the subwoofer level using this method. You may prefer to leave it on its default setting and adjust it to your liking later when playing surround-sound sources.

1 Press **SYS** then **DOLBY/DTS**.

The Dolby/DTS mode can be set to any-thing except **SURROUND OFF**. (No test tone is output if the Dolby/DTS mode is set to **SURROUND OFF**.)

2 Set the volume to a moderate level.

3 Press **TEST TONE** to start the test tone then adjust the master volume to a suitable level.

The test tone plays through each speaker in turn:

- Front left
- Center
- Front right
- Surround right
- Surround left
- Subwoofer

4 Use the **△** and **▽** buttons to adjust the level of a speaker as the test tone plays.

For best results, sit in your main listening position when doing this. You can adjust each speaker in the range of +/-10dB.

5 When you're done, press **TEST TONE** to turn off the test tone.

Using the setup navigator

Before playing any discs, we strongly recommend using the Setup Navigator. This makes all the basic system settings for you.

1 Press **SYSTEM** to switch on.

Also turn on your TV and make sure that it is set to the correct video input.



- If a disc already loaded starts playing, press  to stop it.

2 Press **DVD** then **SETUP**.

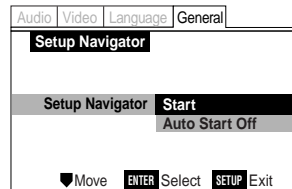
The **Setup Navigator** on-screen display (OSD) appears:



Navigate all of the following OSDs using these controls:

- ,  – cursor up/down
 - ENTER** – select the highlighted menu option
 -  – go back to the previous question
- The control possibilities for the current OSD are shown at the bottom of each screen.

3 Select **START**.

Remember: Press **ENTER** to select an option.

- If you decide you don't want to use the Setup Navigator, select **Auto Start Off** here instead.

4 Choose an **OSD menu language**.



5 Select the type of TV you have.

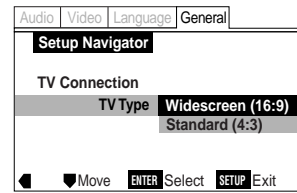

- See *Aspect ratio* in the glossary on page 58 if you're unsure of the difference between widescreen and standard TVs.

6 Confirm all the settings.

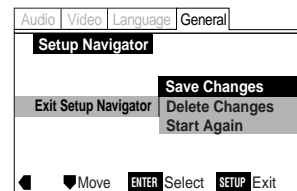

7 Press **SETUP** to exit.

Congratulations, you've set up your system!

If you want to use the Setup Navigator again at any time, it is available from the **General** menu. Also, each individual setting can be changed using the appropriate menu option—chapter 9 explains all menu options in detail.

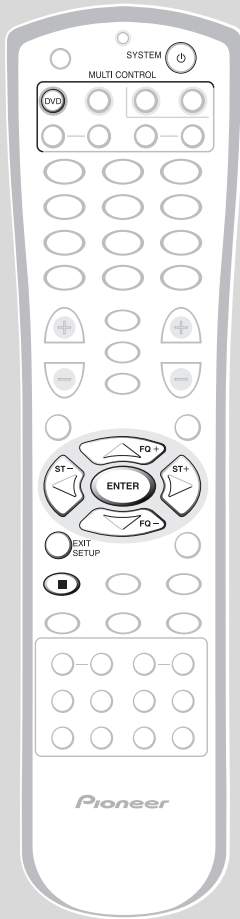

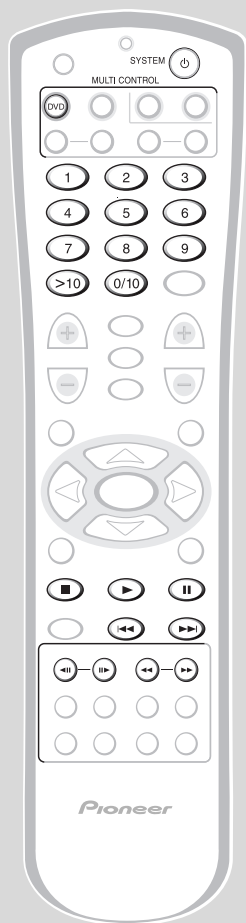

Playing DVD Video discs

Only the basic controls for playback of DVD discs are covered here. Further functions are detailed in the next chapter.

1 Press DVD.

Alternatively, press **FUNCTION** on the front panel to select DVD.

2 Load a DVD disc.

- Press **▲ OPEN/CLOSE** to eject the disc tray.
- Place a disc in the tray, label side face up, making sure it is seated properly in the disc guide.
- Press **▲ OPEN/CLOSE** to close the disc tray. Many DVD-Video discs start playing automatically.

3 Basic playback controls*

Button	What it does
	Starts/resumes playback
	Pauses a disc that's playing or restarts a paused disc
	Stops playback. Display shows RESUME (press to start playback again from the last place stopped).
	Press & hold for fast reverse scanning. (After 5 seconds, scanning continues even after releasing the button: press to resume normal playback.)
	Press & hold for fast forward scanning. (After 5 seconds, scanning continues even after releasing the button: press to resume normal playback.)
	Skips to the start of the current chapter, then to previous chapters.
	Skips to the next chapter.

Button	What it does
Numbers	If the disc is stopped, playback starts from the selected title number. If the disc is playing, playback jumps to the start of the selected chapter number.
>10	Selects titles/chapters 11 and over. (For example, for 24, press >10 , 2 , 4 .)
	Press & hold for about 2 seconds to start slow-motion reverse scanning. Change the speed using the and buttons. When playing, press once to pause; reverse a single frame with each subsequent press.
	Press & hold for about 2 seconds to start slow-motion forward scanning. Change the speed using the and buttons. When playing, press once to pause; advance a single frame with each subsequent press.

- * While using the DVD, you may see the or mark displayed on-screen. means that the operation is not allowed by the system. means that the operation is not allowed by the disc.

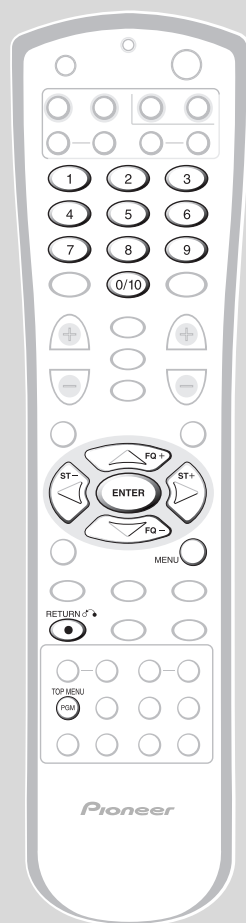

4 Basic disc menu controls

Some DVD discs contain menus. Sometimes these are displayed automatically when you start playback; others only appear when you press **MENU** or **TOP MENU**.

Control	What it does
TOP MENU	Displays the 'top menu' of a DVD disc — this varies with the disc.
MENU	Displays a DVD disc menu — this varies with the disc and may be the same as the 'top menu'.
RETURN	Returns to the previously displayed menu screen. On some DVD-Audio discs featuring browsable pictures, press to display the browser screen.
Cursor buttons	Moves the cursor around the screen
ENTER	Selects the current menu option
Numbers	Selects a numbered menu option (some discs only)

5 Eject and remove the disc before switching off.

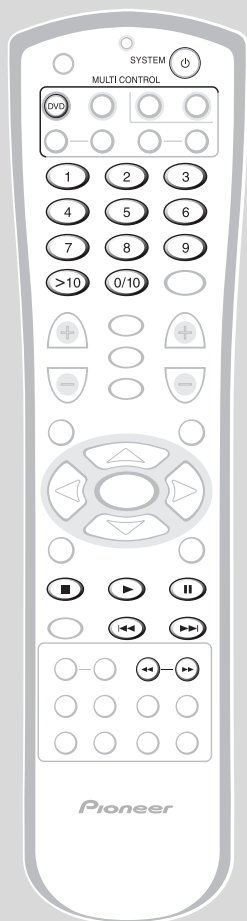

Playing CDs

Only the basic controls for playback of CDs are covered here. Further functions are detailed in the next chapter.

1 Press DVD.

Alternatively, press **FUNCTION** on the front panel to select DVD.

2 Load a CD.

- Press **▲ OPEN/CLOSE** to eject the disc tray.
- Place a disc in the tray, label side face up, making sure it is seated properly in the disc guide.
- Press **▲ OPEN/CLOSE** to close the disc tray.

3 Basic playback controls:

Button	What it does
▶	Starts/restarts playback
⏸	Pauses a disc that's playing or restarts a paused disc
■	Stops playback
◀◀	Press & hold for fast reverse scanning.
▶▶	Press & hold for fast forward scanning.
⏮	Skips to the start of the current track, then to previous tracks.
⏭	Skips to the next track.
Numbers	Starts playback from the selected track number.
>10	Selects tracks 11 and over. (For example, to select track 24, press >10, 2, 4.)

4 Eject and remove the disc before switching off.

Playing Video CDs

Only the basic controls for playback of Video CDs are covered here. Further functions are detailed in the next chapter.

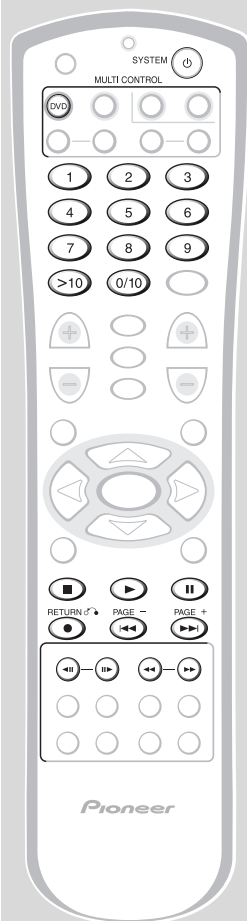

1 Press DVD.

Alternatively, press **FUNCTION** on the front panel to select DVD.

2 Load a Video CD.

- Press **▲ OPEN/CLOSE** to eject the disc tray.
- Place a disc in the tray, label side face up, making sure it is seated properly in the disc guide.
- Press **▲ OPEN/CLOSE** to close the disc tray.

3 Basic playback controls

Many Video CDs contain menus, from which you control playback. This is called PlayBack Control, or PBC, and if the disc features it, the PBC menu will be the first thing you see when you start playback (see *Basic PBC menu controls* on the right for how to navigate these).

Button	What it does
▶	Starts/resumes playback
	Pauses a disc that's playing or restarts a paused disc
■	Stops playback. Display shows RESUME (press ▶ to start playback again from the last place stopped).
◀◀	Press & hold for fast reverse scanning. (After 5 seconds, scanning continues even after releasing the button: press ▶ to resume normal playback.)
▶▶	Press & hold for fast forward scanning. (After 5 seconds, scanning continues even after releasing the button: press ▶ to resume normal playback.)
◀◀	Skips to the start of the current track, then to previous tracks.
▶▶	Skips to the next track.

Button	What it does
Numbers	Starts playback from the selected track number.
>10	Selects tracks 11 and over. (For example, to select track 24, press >10, 2, 4.)
▶	Press & hold for about 2 seconds to start slow-motion forward scanning. Change the speed using the ◀ and ▶ buttons. When playing, press once to pause; advance a single frame with each subsequent press.

4 Basic PBC menu controls

If the Video CD features PBC menus, navigate them using the following controls. To switch off PBC, press ■ then restart playback using a number button to select a track directly.

Button	What it does
RETURN	Displays the PBC menu.
Numbers	Selects a numbered menu option.
◀◀	Displays the previous menu page (if there is one).
▶▶	Displays the next menu page (if there is one).
▶	Press to select an item from a PBC menu.

5 Eject and remove the disc before switching off.

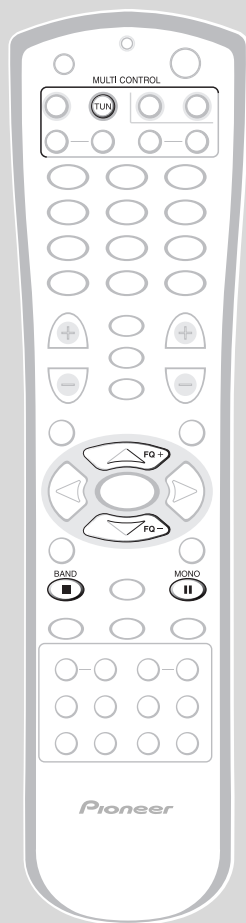

Listening to the radio

The following steps show you how to tune in to FM and AM radio broadcasts using the automatic (search) and manual (step) tuning functions. Once you are tuned to a station you can memorize the frequency for recall later—see *Saving station presets* on page 30 for more on how to do this.

1 Press TUN.

Alternatively, press **FUNCTION** on the front panel to select Tuner.

2 Press BAND to select the FM or AM band.

Each press switches the band between FM and AM.

3 Tune to a station.

There are three ways to do this:

- **Automatic tuning**

To search for stations in the currently selected band, press and hold either the **FQ+** or **FQ-** button for about a second. The system will start searching for the next station, stopping when it has found one. Repeat this step to search for other stations.

- **Manual tuning**

To change the frequency one step at a time, press the **FQ+** / **FQ-** buttons.

- **High speed tuning**

Press and hold the **FQ+** or **FQ-** button for high speed tuning, releasing the button once you reach the frequency you want.

Improving FM stereo sound

If you're listening to a stereo FM broadcast, but find that there is a lot of noise because of a weak signal, try switching to mono.

- **Press MONO to switch between mono and stereo.**

When listening in mono, the  indicator lights in the display.

Listening to other components

This system has several audio/video inputs for you to connect other components, such as a VCR, MD deck, and so on. See chapter 12 for more on connecting up other components.

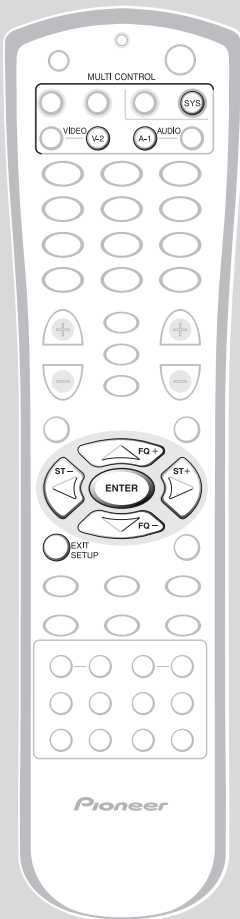
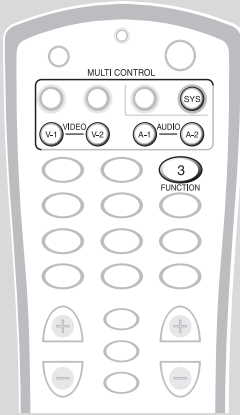

1 Switch to the source you want to watch/listen to.

There are four external inputs you can connect components to. Select them using the multi-control buttons:

- **V-1** (Video 1)
- **V-2** (Video 2)
- **A-1** (Audio 1)
- **A-2** (Audio 2)

Alternatively, you can use the **FUNCTION** button on the front panel, or press **SYS** then **FUNCTION** on the remote.

2 Start playing the source component.

Switching between digital and analog sources

Both digital and analog inputs are available when Audio 1 or Video 2 is selected as the source. The Input Select setting tells the system which input it should use.

See page 54 for more on connecting other components to this system.

Note: This system can only play Dolby Digital, PCM (32, 44.1, and 48kHz) and DTS digital audio formats. For digital sources using other formats, use analog connections and select **INPUT ANALOG**.

1 Press **AUDIO A-1** or **VIDEO V-2** (for the input you want to set).

The settings for the Audio 1 and Video 2 inputs are completely independent.

2 Press **SYS** then **SETUP**.

3 Press the **<** or **>** button until you see **INPUT** in the display.

4 Use the **△** and **▽** buttons to select the input to use.

- **INPUT OPTICAL** – the optical digital input is used as the source

INPUT OPTICAL

- **INPUT COAXIAL** – the coaxial digital input is used as the source (this setting is only available for VIDEO 2)

INPUT COAXIAL

- **INPUT ANALOG** – (default setting) the analog inputs are used as the source

INPUT ANALOG

5 Press **ENTER** to make the setting.



Adjusting the bass and treble

The simplest way to shape the sound is by adjusting the amount of bass and treble.

Note: The bass and treble controls have no effect when using the DSP modes, or when the Dolby/DTS mode is set to anything other than **AUTO**, **STANDARD** or **SURROUND OFF**.

- 1 Press **SYS** then **SOUND CONTROL**.
- 2 Use the **◀** or **▶** buttons to select **BASS** or **TREBLE**.

BASS +3

TREBLE 0

- 3 Use the **△** and **▽** buttons to adjust the sound.
You can see the current level in the display.
- 4 Press **ENTER** to set the level.

Using P.Bass

In addition to the standard controls for adjusting bass and treble, this system has a P.Bass feature. Switch this on to further extend the bass.

Note: P.Bass has no effect when listening through headphones.

- Press **SYS** then **P.BASS** to switch **P.BASS** on or off.

P. BASS ON

P. BASS OFF

Using sound modes

The sound modes allow you to add various room-type sound effects to your DVDs, CDs and other sources. These effects process the sound in various ways to simulate different spaces such as a theater, or concert hall.

For Dolby Surround, Dolby Digital or DTS surround sources, such as DVDs, use the Advanced Theater effects to add room effects to the sound; for stereo-only sources, such as audio CDs, use the DSP modes. As well as choosing between effects, you can also adjust how strong the effect sounds. Often, a more subtle effect level enhances the sound better than turning it right up. Experiment to see what works best for you.

Listening to surround-sound sources with room effects

Effects modes

Switch on the Dolby/DTS mode when you play a Dolby Surround, Dolby Digital or DTS encoded source.

- **Auto** – For digital sources, decoding is automatically selected according to the source: Dolby Digital, DTS, Dolby Pro Logic, 2-channel stereo, etc. No extra effects are added to the source. Analog sources are played in the same way as the Surround Off setting.
- **Standard** – As Auto, except that 2-channel (analog or digital) sources are processed using Dolby Pro Logic for surround-sound effects.
- **Musical** – Concert hall sound.
- **Drama** – Classic, mid-size movie theater sound.
- **Action** – Large, modern movie theater sound.
- **Virtual Surround 1** – Virtual surround sound from just the main front stereo speakers and a subwoofer. Use this mode if you can't use the surround speakers.

- **Virtual Surround 2** – Virtual surround sound if you have connected the surround speakers, but are using them in front of the listening position.
- **Rear Wide** – Widens the rear channel soundstage.
- **Surround Off** – All sources are played through only the front left and right speakers, and the subwoofer. No effects are added.

Note: The Dolby/DTS mode cannot be used with 96kHz/24-bit sources, or in combination with DSP effects.

1 Press **SYS** then **DD/DTS** to select a sound mode.

Each press changes the mode as follows:

- **AUTO**
- **STANDARD** (surround on, with no Advanced Theater effect)
- **MUSICAL**
- **DRAMA**
- **ACTION**
- **VIRTUAL SURR. 1**
- **VIRTUAL SURR. 2**
- **REAR WIDE**
- **SURROUND OFF** (surround off)

To adjust the effect level when using one of the Advanced Theater effects:

1 Press **SYS** then **SOUND CONTROL**.

2 Use the **△** and **▽** buttons to adjust the effect level.

You can adjust the effect level in the range of 10 to 90.

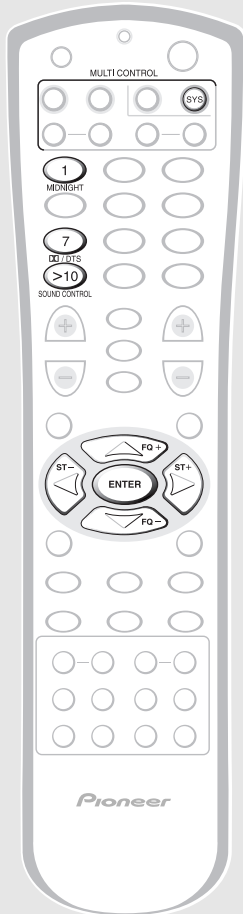

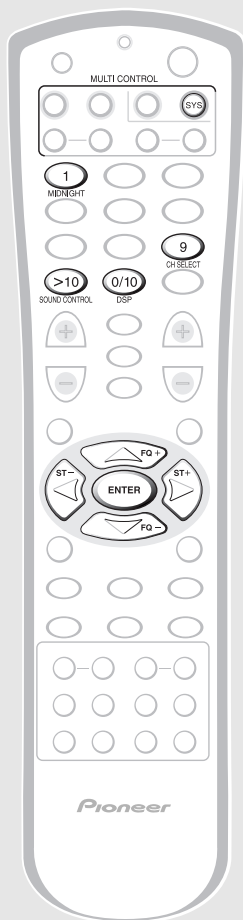

Listening to other sources with room effects

You can add room effects to audio CDs and other stereo sources using the DSP modes. Different effects work better with different kinds of music, so don't be afraid to experiment a little.

There are seven DSP effects to choose from:

- **Hall 1** – Large, wood-paneled concert hall sound.
- **Hall 2** – Large, stone-walled concert hall sound.
- **Jazz** – Live jazz club sound.
- **Dance** – Nightclub sound.
- **Theater 1** – Classic, mid-size movie theater sound.
- **Theater 2** – Large, modern movie theater sound.
- **Simulated Stereo** – Virtual stereo for mono sources.

Notes

- The DSP effects cannot be used with 96kHz/24-bit sources, or in combination with the Dolby/DTS mode.
- When playing stereo sources with DSP effects switched off, there is no sound from the surround and center speakers.

1 Press **SYS** then **DSP** to select a sound mode.

Each press changes the mode as follows:

- **HALL 1**
- **HALL 2**
- **JAZZ**
- **DANCE**
- **THEATER 1**
- **THEATER 2**
- **SIMULATED STEREO**
- **DSP OFF** (no effects added)

To adjust the effect level when using one of the DSP effects:

1 Press **SYS** then **SOUND CONTROL**.

2 Use the **△** and **▽** buttons to adjust the effect level.

You can adjust the effect level in the range of 10 to 90.

Listening at low volume

When the volume is low, surround effects tend to become less than satisfactory. Turn the Midnight listening mode on to enjoy quality surround sound even at low volumes.

- **Press **SYS** then **MIDNIGHT** to switch Midnight listening mode on/off.**

Adjusting channel volume levels

Depending on your room and where you're sitting, you may want to adjust the relative volumes of one or more speakers for a more balanced sound. You can do this in any mode, including the Dolby Digital/DTS, DSP, and stereo modes. Settings that you make in any sound mode are completely independent and don't affect any other mode.

Notes

- Each DSP effect has its own set of channel level settings.
- The channel levels you set for the Dolby/DTS mode apply to all Advanced Theater effects.
- The headphone level is not affected by the channel level settings.

1 Press **SYS** then **CH SELECT**.

Adjustments to the channel volume levels will affect only the current sound mode.

2 Use the **◀** and **▶** buttons to select a channel to adjust.

The display shows the channel and its current setting.

- Remember that not all channels are available in all sound modes.



3 Use the **△** and **▽** buttons to adjust the volume of the current channel.

For best results, sit in your main listening position when doing this. You can adjust each speaker in the range of +/-10 dB.

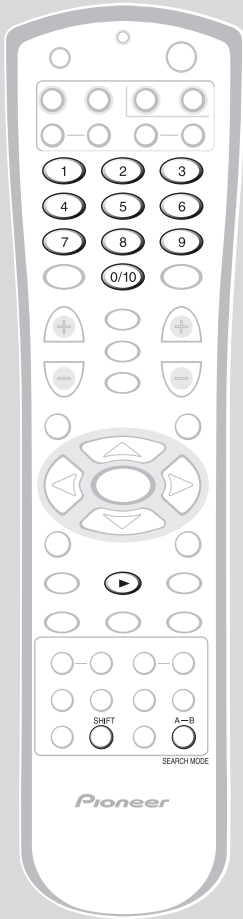
4 When you're done, press **ENTER**.



Introduction

- Most of the functions covered in this chapter apply to DVD discs, Video CDs and CDs, although the exact operation of some varies slightly with the kind of disc loaded.
- When playing DVD discs, if the  or  icon appears on-screen when you try and use a particular function, either the player or the disc doesn't allow the use of that function.
- When playing Video CDs, some of the functions are not available in PBC mode. If you want to use them, stop the disc first and restart by inputting a track number on the remote control.

Finding what you want on a disc

You can directly access any point on a disc using one of the search modes. Use these search modes while a disc is playing, or when it's stopped—playback immediately starts from the point specified.

1 Press **SHIFT**, then **SEARCH MODE** repeatedly to choose between:

- **Title search** (DVD only)
- **Chapter/Track search**
- **Time search** (DVD and Video CD only)
- **Off**

2 Enter the title/chapter/track number or time (minutes & seconds).

For example, for title 4, press **4**.

For chapter/track 12, press **1** , **2**.

For 45 minutes into the disc,
press **4** , **5** , **0** , **0**.

3 Press **▶** to start/restart playback.

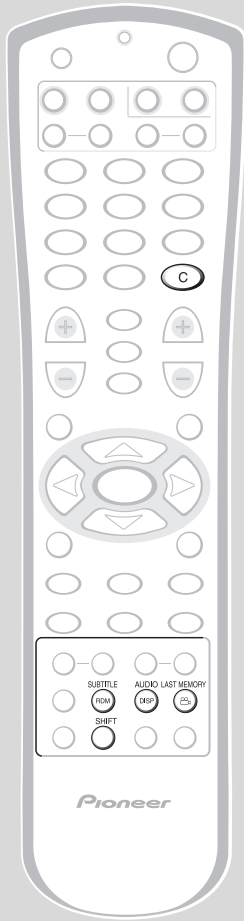

Switching camera angles (DVD only)

Some DVD discs feature scenes shot from two or more angles—check the box for details: it should be marked with a  icon if it contains multi-angle scenes. When these scenes are playing, a camera icon appears on-screen and the **ANGLE** indicator lights in the display.

- To switch the camera angle, press **SHIFT** then  .
- To hide the TV angle indicator, choose **Angle Indicator > Off** from the **Video** menu (see page 35).

Switching subtitles

(DVD only)

Many DVD discs have subtitles in one or more languages—the box will usually tell you which subtitle languages are available. You can switch subtitle language anytime during playback.

- To display/switch the subtitle language, press **SUBTITLE** repeatedly.
- To switch off subtitles, press **SUBTITLE** then **C (Clear)**.
- To set subtitle preferences, see page 37.

Switching audio language (DVD only)

When playing a DVD disc recorded with dialog in two or more languages, you can switch audio language anytime during playback.

Note: With some discs, you can select the audio language from the DVD disc menu. Press menu then follow the on-screen menus to make your selection.

- To display the current audio language, press **AUDIO**.
- To switch the audio language, press **AUDIO** repeatedly.
- To set audio language preferences, see page 36.

Programming playlists

Programming a playlist means telling the player which tracks, and in what order, you want played. You can program a sequence of up to 24 tracks, playing tracks more than once if you like.

Input the playlist via an on-screen display, using the cursor buttons and number buttons to navigate the screen and enter title/chapter numbers.

Programming a DVD playlist



1 Press SHIFT then PGM.

2 Use the ◀ and ▶ buttons to select Program Chapter or Program Title.

If you select **Program Chapter**, move the cursor down (▽) to highlight Title, then enter a title number (all the chapters you program will be from this title).

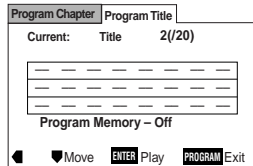
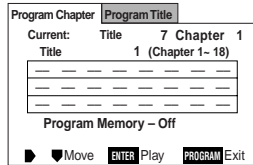

3 Move the cursor down to the playlist window and start entering chapter/title numbers.

For titles/chapters 1 to 10, use the corresponding number button. For 11 and over, use the >10 button (>10, 2, 4 for 24, etc.)

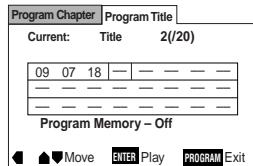
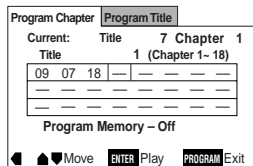

4 If you want to memorize the playlist, move the cursor down to Program Memory and set it to ON.

The player can memorize playlists for up to 24 DVD discs.

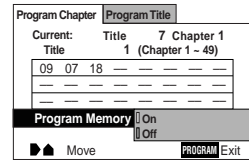

5 Press ENTER to start playback immediately, or SHIFT then PGM to exit if you want to start playback later.



Programming a CD/Video CD playlist

- 1 Press **SHIFT** then **PGM**.

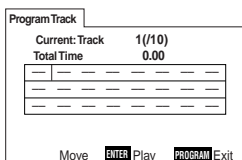

- 2 Start entering track numbers.

For tracks 1 to 10, use the corresponding number button. For 11 and over, use the **>10** button (**>10**, **2**, **4** for 24, etc.)

- 3 Press **ENTER** to start playback immediately, or **SHIFT** then **PGM** to exit if you want to start playback later*

* You can't start program playback later with a PBC Video CD: press **ENTER** to start.

More programming options

There are several other options available when programming/using playlists.

- To view the playlist, press **SHIFT** then **PGM**.
- To put a pause in the playlist, press **II** instead of a number.
 - You can't program two pauses in succession, or start/end a playlist with a pause.
- To delete an entry from the playlist, position the cursor on the title/chapter/track number and press **C** (Clear).
- To insert an entry into the playlist, position the cursor where you want the title/chapter/track to appear, then enter its number. All the following entries move up one.
- To add an entry to the end of the playlist, press **SHIFT** then **PGM**, enter the title/chapter/track number, then press **SHIFT** and **PGM** again.
- To add the currently playing title/chapter/track to the playlist, press **SHIFT** then hold **PGM** for about 2 seconds.
 - If there is no current playlist, a new one is created. (For DVD: if the last playlist programmed was for titles, then a title playlist is created; otherwise a chapter playlist is created.)
- To delete the playlist, press **■** to stop playback, then press **C** (Clear).
- To delete a memorized DVD playlist, load the DVD disc, press **SHIFT** then **PGM**, then change the Program Memory option to **Off**. Press **ENTER** to confirm.

Using repeat play

Use the repeat function to repeat the current track/chapter/title, the whole disc, or loop between two points anywhere on the disc. You can set the repeat mode in normal or program play modes. Set or change the repeat mode while the disc is already playing.

Note: you can't use repeat and random play at the same time.

- **To set or change the repeat mode, press REPEAT.**
The repeat mode is shown on-screen. Just stop on the one you want.
- **To cancel repeat play, press C (Clear), or set the repeat mode to OFF.**
- **To loop a section of a disc, press A-B to mark the start point, then again to mark the end point and start looping.**
- **To cancel looping, press A-B again.**
- **To repeat a section of a disc once, press A-B to mark the start point, then press ► to mark the end point and loop.**

Button	What it does
REPEAT	Sets the repeat mode. For DVD the repeat modes are title or chapter; for CDs or Video CDs, track or all tracks.
A-B	Sets the start point of a loop to repeat. Press again to mark the end point and start the loop repeating. <ul style="list-style-type: none"> • To play the loop just once, mark the end point by pressing ►
C	Cancels repeat mode (playback continues).
■	Cancels repeat mode (playback stops).

Using random play

To play titles/chapters/tracks in a different order each time you play a disc, use the random play mode. Each title/chapter/track plays just once, but in a random order. Set the random play mode while the disc is playing or stopped.

Note: you can't use random play together with program or repeat play.

DVD

- **To start playing chapters at random, press SHIFT then RDM, then ENTER.**
- **To start playing titles at random, press SHIFT, then RDM twice, then ENTER.**

CD/Video CD

- **To start playing tracks at random, press SHIFT then RDM.**

Button	What it does
RDM	CD/Video CD: Starts random playback of tracks. DVD: Sets random mode (chapter or title). Press ENTER to start.
ENTER	DVD only: Starts random playback.
►►	Starts a new random title/chapter/track.
◀◀	Returns to the start of the current title/chapter/track (you can't go further back than this).
C	Cancels random mode (playback continues normally).
■	Cancels random mode (playback stops).

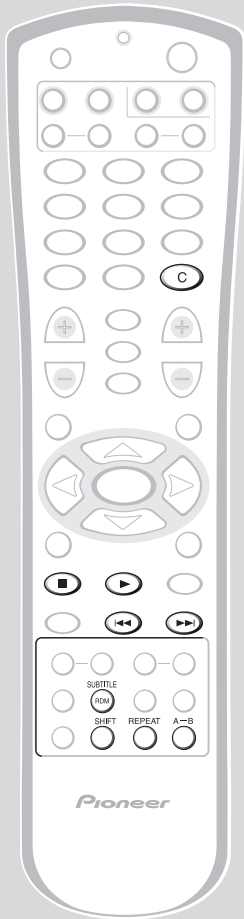

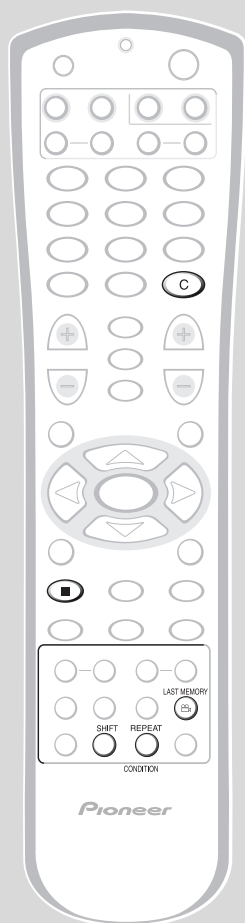

Bookmarking a place in a disc

(DVD/Video CD)

If you watch only part of a DVD disc with the intention of picking up later where you left off, you can bookmark the place then resume playback at a later date without having to manually search for the right place.

You can use this feature for up to five discs (after that the oldest bookmark is deleted to make space for a new one).

- **At the point from which you want to resume playback next time, press LAST MEMORY, then stop the disc (■).**
- **To resume playback, load the disc and press LAST MEMORY. (If the disc started auto playback, stop it first.)**
- **To clear the last memo position of the disc loaded, press LAST MEMORY then C (Clear) while Last Memory is displayed on-screen.**

Note: Bookmarking also works with Video CD, but for one disc only, and you must leave the disc in the system—opening the disc tray erases the memory. Last Memory may not work reliably with some PBC Video CDs.

Memorizing disc settings (DVD only)

If you have a particular set of preferences for a disc, you can memorize them using the Condition Memory function. Once memorized, your settings will be recalled automatically whenever you load that disc. The system can store settings for 15 discs; after this, memorizing another replaces the oldest one stored.

The settings memorized are:

- On Screen Display (page 34)
 - Subtitle language (page 37)
 - Audio language (page 36)
 - Video quality (page 35)
 - Angle indicator (page 35)
 - Parental lock level (page 39)
- **To memorize settings for the current disc, press SHIFT then CONDITION during playback.**
 - **To recall memorized settings, just load the disc.**
The display shows COND_MEMORY and Condition Memory appears on-screen.
 - **To clear memorized settings, load the disc and press C (Clear) while Condition Memory is displayed on-screen.**

Displaying disc information

Various track, chapter and title information, as well as the video transmission rate for DVD discs, can be displayed on-screen while a disc is playing, or while it's stopped.

- **To show/switch the information displayed, press DVD then DISP.**
 - When a disc is playing, the information appears at the top of the screen. Keep pressing **DISP** to change the displayed information.

Play 3
Tr. Rate : ■■■■■■■■ 9.2

DVD display showing the video transmission rate

- When a disc is stopped, all title/chapter, or track information for the disc loaded appears on-screen. Press **DISP** again to exit the screen.

Information: DVD

Title	Chapter	Title	Chapter
01	1~ 30	06	1~ 10
02	1~ 21	07	1~ 13
03	1~ 46	08	1~ 5
04	1~ 12	09	1~ 4
05	1~ 8		

1/1 **DISPLAY** Exit

DVD-Video

Information: Compact Disc

Total Time	6.30
Track	Time
01	3.32
02	2.58

1/1 **DISPLAY** Exit

CD/Video CD

- **To display the time remaining on the DVD disc playing, press and hold DISP.**

The time remaining is displayed for as long as you hold down the DISP button. Release to revert to the previous display.

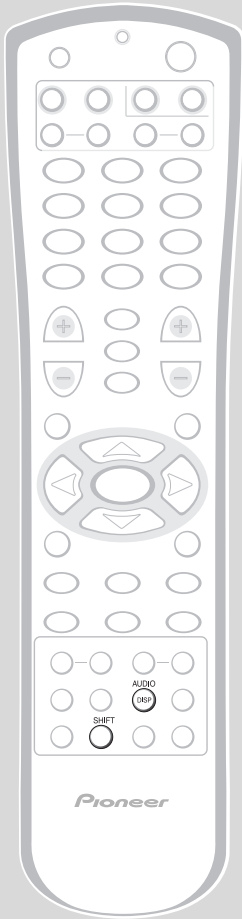

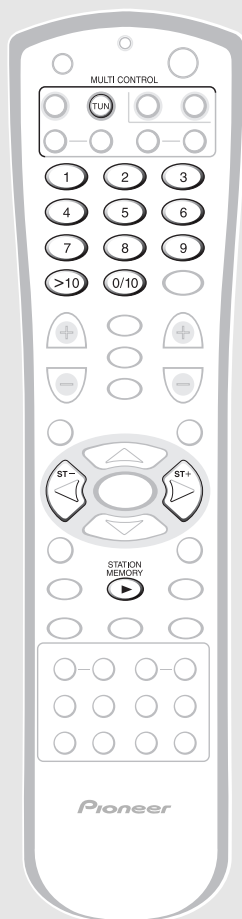

Saving station presets

If you often listen to a particular radio station, it's convenient to have the receiver store the frequency for easy recall whenever you want to listen to that station. This saves the effort of manually tuning in each time. This system can save up to 30 station presets. When saving FM frequencies, the receiver also saves the mono setting (see page 18).

1 Tune to a station you want to memorize.

See *Listening to the radio* on page 18 for more on how to do this.

2 Press STATION MEMORY.

3 Press ST+ or ST- to select a station preset number.

Alternatively, use the number buttons (use the **>10** button for numbers over 10).

If you use the number buttons, you can skip step 4.

4 Press STATION MEMORY again to save the station preset.

Repeat these steps to save up to 30 station presets.

Listening to station presets

Having saved up to 30 station presets (see above for how to do this), you can be listening to a station with a couple of button presses.

1 Press TUN to switch to the tuner.

2 Use ST+ or ST- to select the station preset you want to listen to.

Alternatively, use the number buttons (use the **>10** button for numbers over 10).

- If the system is left disconnected from the AC power outlet for a lengthy period, the station presets will be lost and will have to be re-programed.

Using the wake up timer

You can use the timer as an alarm clock to wake up to the sound of a disc loaded or the radio. If you have an external component operated by a separate timer, you can also set the source function to that.

Once the timer is active, it will switch the system on everyday at the set time.

Unlike an ordinary alarm clock, you need to set a system switch off time as well as a switch on time.

1 Select the source that you'd like to wake up to.

For a disc, press **DVD**; for the radio press **TUNER**. For an external component, press the corresponding button.

2 Load a disc or tune to a radio station, then set the volume.

If you selected an external component, make the appropriate timer settings for it.

When setting the volume, remember things sound louder first thing in the morning!

3 Press **SYS** then **TIMER/CLOCK ADJ.**

4 Press the **◀** or **▶** button until you see **WAKE-UP SET** in the display.

WAKE-UP SET

5 Press **ENTER**.

The display shows a switch on time with the hour blinking.

6 Set the switch on time.

Use **△** and **▽** to set the hour then press **ENTER**. Set the minute in the same way, pressing **ENTER** to finish.

- If you make a mistake, press **TIMER/CLOCK ADJ** and start again from step 3.

7 Set the switch off time.

Set in the same way as the switch on time, pressing **ENTER** to finish.

- If you make a mistake, press **TIMER/CLOCK ADJ** and start again from step 3.

8 Check the settings you just made.

The display should indicate that you set the wake up timer, then show the on time, the off time, the function (DVD, etc.), and the volume.

- There is no direct way to edit the timer settings. If you see that some timer setting is not what you'd intended, you'll need to start the process again from the top.

9 Switch the system into standby.

The timer will not work if the system is left on!

The standby light on the front panel lights green to indicate that the timer has been set.

Activating/deactivating the wake up timer

To activate the wake up timer, set the timer to **ON**. To deactivate it, set the timer to **OFF**.

1 Press **SYS** then **TIMER/CLOCK ADJ.**

2 Press the **◀** or **▶** button until you see **TIMER ON** or **TIMER OFF** in the display.

TIMER ON

TIMER OFF

3 Press **ENTER**.

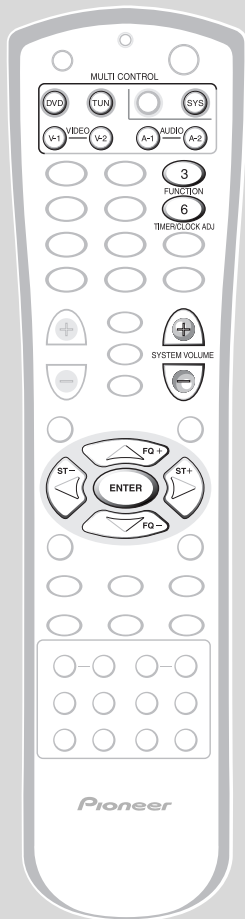

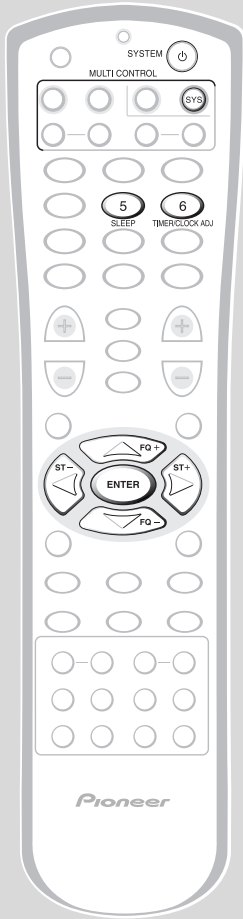

Checking the timer settings

If you've set the wake-up timer, you can check the settings anytime. Here's how to do it.

- 1 Press **SYS** then **TIMER CLOCK/ADJ.**
- 2 Press the **◀** or **▶** button until you see **TIMER CHECK** in the display.

TIMER CHECK

- 3 Press **ENTER**.

The display shows the timer settings:

- **On time**

ON 7:30 AM

- **Off time**

OFF 9:15 AM

- **Function (DVD, etc.)**

DVD

- **Volume**

VOLUME 10

CHECK END

Using the sleep timer

The sleep timer switches the system into standby after a specified amount of time so that you can fall asleep without worrying about the stereo being left on all night. If you've also set the wake up timer this is important since the wake up timer will only work if the system is in standby.

- 1 Press **SYS**.
- 2 Press **SLEEP** to set the time until the system goes into standby.

Press repeatedly to switch between:

- **SLEEP AUTO** – this setting is only available when the system is playing a CD*
- **SLEEP 90** (minutes)
- **SLEEP 60** (minutes)
- **SLEEP 30** (minutes)
- **SLEEP OFF** (cancels the sleep timer)

The sleep timer indicator (Ⓜ) lights when the sleep timer is active.

* not available when a Video CD is in PBC mode, or if you're playing a CD or Video CD in repeat mode. If you set a disc playing in repeat mode after setting the sleep timer to **AUTO**, it automatically switches to the 90 minute setting.

- Once the sleep timer is set, you can check the time left by pressing **SLEEP**.
- To cancel the sleep timer, switch the system into standby, or select **SLEEP OFF** (as described above)
- If you switch to a different source when **SLEEP AUTO** is set, the system will automatically go into standby a minute later.

Making an audio or a video recording

The following steps show you how to make an audio or a video recording from the built in tuner, DVD, CD or from an audio or video source connected to the system (CD player, satellite tuner, etc.). Recordings can be made to a recorder connected to the **AUDIO 1** or **VIDEO 1** inputs/outputs.

The system's volume, balance, bass, treble, Midnight and surround sound settings have no effect on the recording.

Notes

- You can't record a source connected to the digital inputs from the analog outputs.
- You can't record DTS encoded discs from the analog outputs.

1 Select a source to record.

Use the **MULTI CONTROL** buttons on the remote, or the **FUNCTION** button (remote or front panel) to select the source.

2 Prepare the program source.

Tune to the radio station, load the CD, etc. For a video recording load the video, etc.

3 Insert a blank tape, MD, etc. into the recorder connected to either **AUDIO 1** or **VIDEO 1** and set the recording levels.

Refer to the instructions that came with the recorder if you are unsure how to do this. Most video recorders set the audio recording level automatically—check your video's instruction manual if you are unsure whether yours has manual controls.

4 Start recording, then start playback of the source component.

Making a digital recording

The system has one optical digital audio output (for **AUDIO 1**). If you want to make a digital recording from this system hook up this optical output to the optical input of your digital recorder. The source (CD, DVD, etc.) must be digital also; this system doesn't convert analog inputs to digital. If you're recording from an external digital component, also make sure that you've selected the digital input for that component (see page 19).

Note: If you want to record DVD disc, check that the digital output settings correct. See page 36 for detailed instructions.

1 Select DVD or VIDEO V-2 as the digital source to record.

Use the **MULTI CONTROL** buttons on the remote, or the **FUNCTION** button (remote or front panel) to select the source.

2 Prepare the program source.

Load the CD, MD, etc.

3 Insert a blank MD, CD-R, etc. into the recorder connected to the optical output of **AUDIO 1**.

4 Start recording, then start playback of the source component.

See the instructions that came with your recorder for detailed instructions on recording.

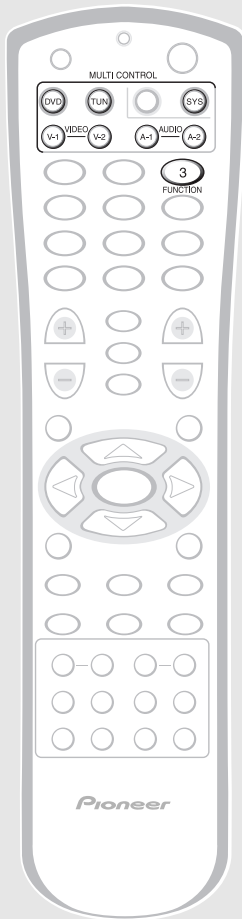

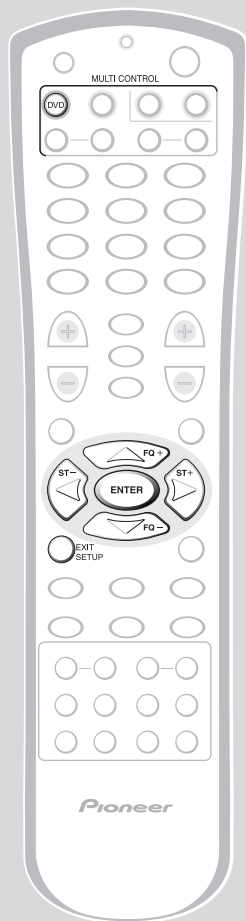

Using the Setup menu

The Setup menu gives you access to all the DVD system settings. When in DVD mode, press **SETUP** to display/leave the menu and the cursor buttons and **ENTER** to navigate and select options. The controls for each menu are shown at the bottom of the screen.

If an option is greyed out it means that it cannot be changed at the current time. This is usually because a disc is playing. Stop the disc, then change the setting.

The current setting for any option is marked with a colored box. The color of the box indicates what kind of disc the setting is applicable to: blue for DVD only; yellow for DVD and Video CD; green for any type of disc.

OSD settings

Setup Menu Mode

- Default setting: **Basic**

The **Basic** setup menu gives you access to the more commonly used settings. It also features an information bar which tells you more about what the currently highlighted option means.

Set to **Expert** for access to all settings.

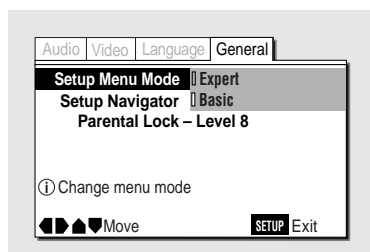

OSD language

- Set in Setup Navigator (default: **English**)

Choose between OSD menus in the languages offered.

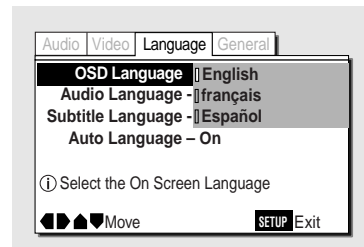

On Screen Display (Expert)

- Default setting: **Position - Normal**

When watching DVD discs recorded in 4:3 format ('regular' TV size) on a widescreen TV, it can be difficult to see the operation displays (Play, Stop, Resume, etc.) at the top of the screen. If you find them hard to read, set the **On Screen Display** to **Position - Wide**.

If you prefer not to have the operation displays (Play, Stop, Resume, etc.) shown on-screen, change the **On Screen Display** setting to **Off**.

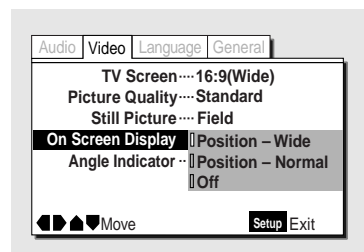

Video settings

TV Screen Size

- Set in Setup Navigator (Default: **16:9 (Wide)**)

If you have a widescreen TV, select the **16:9 (Wide)** setting—widescreen DVD software is then shown using the full screen area. When playing software recorded in conventional (4:3) format, the settings on your TV will determine how the material is presented—see the manual that came with your TV for details on what options are available.

If you have a conventional TV, choose either **4:3 (Letter Box)** or **4:3 (Pan & Scan)**. In **Letter Box** mode, widescreen software is shown with black bars at the top and bottom of the screen. **Pan & Scan** chops the sides off widescreen material to make it fit the 4:3 screen (so even though the picture looks larger on the screen, you're actually seeing less of the movie). See *Aspect ratio* in the Glossary on page 58 for more information.

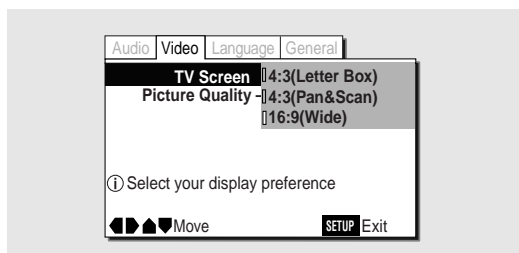

Adjusting the video quality

There are several preset picture quality settings that suit various program types. Alternatively, set up your own and save them for later recall.

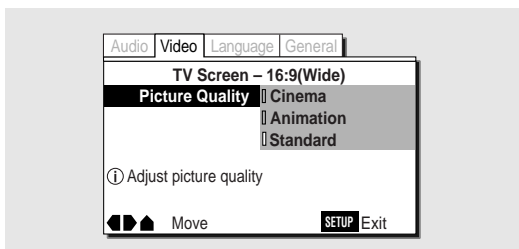

Still Picture (Expert)

- Default setting: **Auto**

This system uses one of two processes when displaying a still frame from a DVD disc. The default **Auto** setting lets the system decide which to use.

Field – produces a stable, generally shake-free image.

Frame – produces a sharper image, but more prone to shake than field stills.

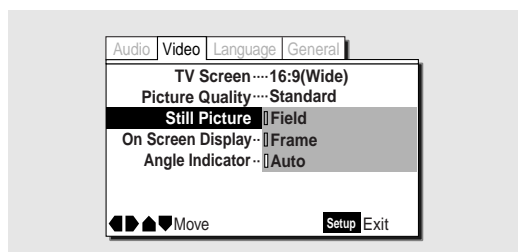

Angle Indicator (Expert)

- Default setting: **On**

If you prefer *not* to see the camera icon on-screen during multi-angle scenes on DVD discs, change the **Angle Indicator** setting to **Off**.

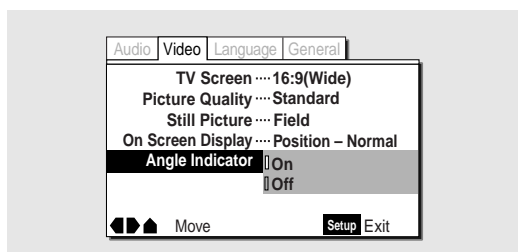

Audio settings

Dolby Digital Out

- Set in Setup Navigator (Default: **Dolby Digital**)

You only need to make this setting if you connected this system to another component (MD recorder, etc.) using one of the digital outs.

When recording a Dolby Digital disc to an MD or CD recorder, set this to **Dolby Digital ▶ PCM**. When you're done recording, set it back to **Dolby Digital** for proper playback of Dolby Digital discs.

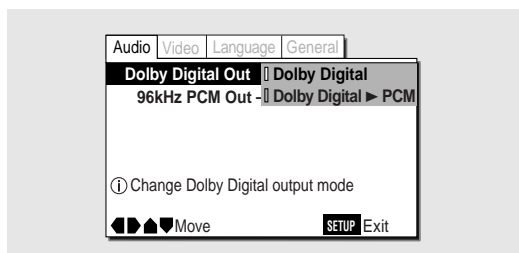

Linear PCM Out

- Set in Setup Navigator (Default: **96kHz**)

You only need to make this setting if you connected this system to another component (MD recorder, etc.) using one of the digital outs.

When recording a 96kHz/24-bit disc to an MD or CD recorder, set this to **96kHz ▶ 48kHz**. When you're done recording, set it back to **96kHz** for proper playback of 96kHz/24-bit discs.

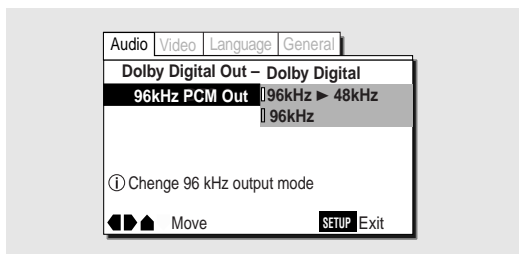

Language settings

Audio Language

- Default Setting: **English**

This setting is your preferred audio language for DVD discs. If the language you specify here is recorded on a disc, the system automatically plays the disc in that language (although this depends on the *Auto Language* setting—see *Auto Language* on page 37).

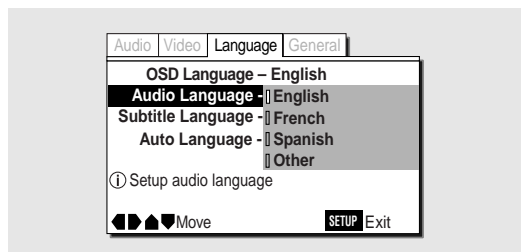

The DVD format recognizes 136 different languages. Choose **Other** if you want to specify a language other than those listed, then follow the on-screen display to select a language. You may also want to refer to the *DVD language code list* on page 59.

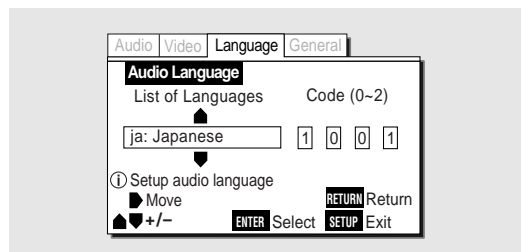

Remember: You can switch between the languages recorded on a DVD disc any time during playback using the **AUDIO** button. (This does not affect this setting.)

Subtitle Language

- Default Setting: **English**

This setting is your preferred subtitle language for DVD discs. If the language you specify here is recorded on a disc, the system automatically plays the disc with those subtitles (although this depends on the *Auto Language* setting—see *Auto Language* on the right).

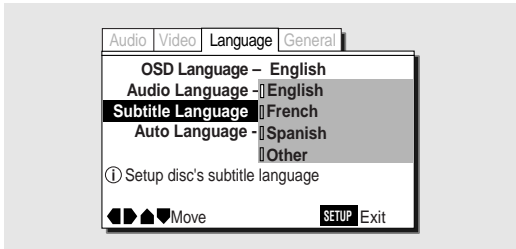

The DVD format recognizes 136 different languages. Choose **Other** if you want to specify a language other than those listed, then follow the on-screen display to select a language. You may also want to refer to the *DVD language code list* on page 59.

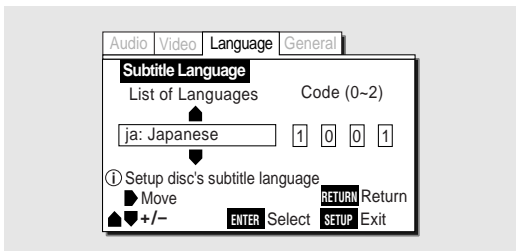

Remember: You can change or switch off the subtitles on a DVD disc any time during playback using the **SUBTITLE** button. (This does not affect this setting.)

Auto Language

- Default Setting: **On**

When set to **On**, the system always selects the default audio language on a DVD disc (French dialog for a French movie, for example), and displays subtitles in your preferred subtitle language only if that is set to something different. In other words, movies in your native language won't have any subtitles, while foreign language movies will be shown with subtitles.

Set to **Off** to have the system play discs strictly according to your *Audio Language* and *Subtitle Language* settings.

For Auto Language to work, the *Audio Language* and *Subtitle Language* settings must be the same—see pages 36–37.

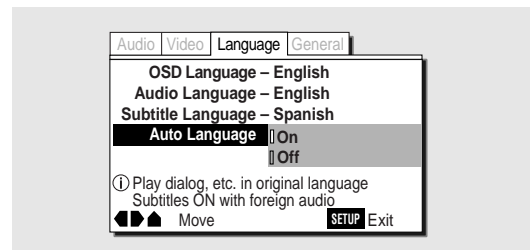

Remember: You can still switch audio and subtitle languages on playback using the **AUDIO** and **SUBTITLE** buttons.

DVD Language (Expert)

- Default Setting: **w/Subtitle Language**

Some multi-lingual discs have disc menus in several languages. This setting specifies in which language the disc menus should appear. Leave on the default setting for menus to appear in the same language as your subtitle preference—see page 37.

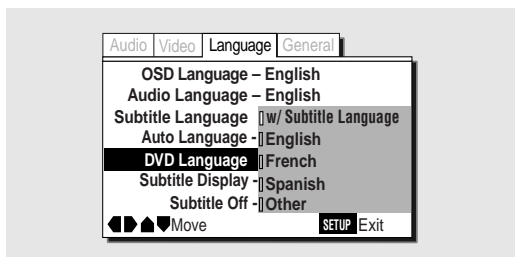

The DVD format recognizes 136 different languages. Choose **Other** if you want to specify a language other than those listed, then follow the on-screen display to select a language. You may also want to refer to the *DVD language code list* on page 59.

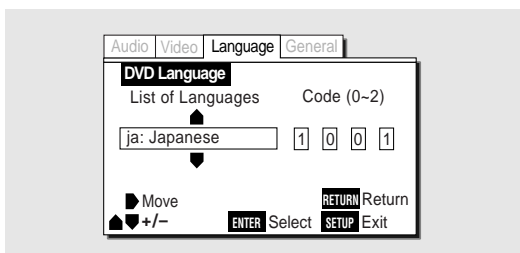

Subtitle Off (Expert)

- Default Setting: **Selected Subtitle**

Some discs display subtitles even if the *Subtitle Display* setting (below) is set to off. In this case, you can either have the subtitles displayed in the same language as your preferred audio language (**With Audio**), or in your preferred subtitle language (**Selected Subtitle**). If the *Audio Language* and *Subtitle Language* settings are the same then both of these choices will give the same result.

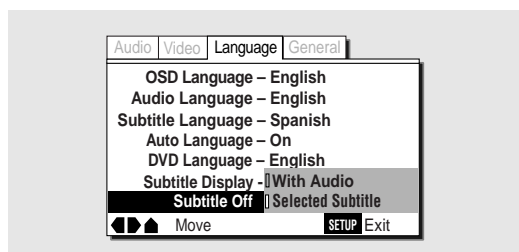

Subtitle Display (Expert)

- Default Setting: **On**

Set to **On**, the system displays subtitles according to the Subtitle Language and Auto Language settings above. Set to **Off** to switch subtitles off altogether (although see *Subtitle Off* above). Set to **Assist Subtitle** to have the system display the extra assistive subtitles recorded on to some DVD discs.

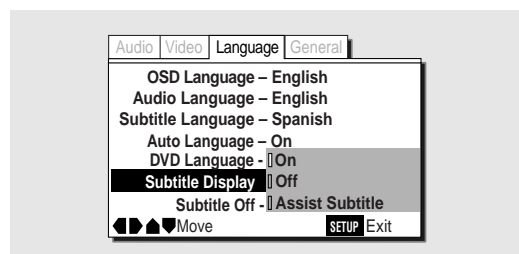

Miscellaneous settings

Parental Lock

- Default level: **8**
- Default password: **none**

You can restrict access to certain discs using this feature. Once set, you will be asked for a four-digit password when a restricted disc is loaded, giving you a degree of control over what your children watch.

You can set the restriction to one of eight levels. Setting the level at 1 means that any disc that has any level of restriction will need the password in order to watch it, while setting it at level 8 gives unlimited access.

DVD discs are also rated from 1 to 8. Discs rated 1 (or with no rating) generally contain little or no offensive material; discs rated 2, may contain material that some parents may feel is unsuitable for children. Discs rated 8 will almost certainly be unsuitable for children.

Since a disc's rating is up to the manufacturer, it is not possible to give a definitive guide to each level—check the disc box for parental lock details.

Be careful: not all discs that you may consider inappropriate for your children are rated. Unrated discs will always play without requiring the password first.

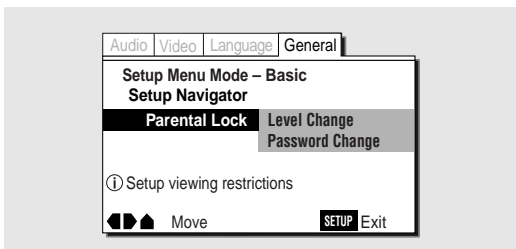

Changing the parental lock level

- 1 Select Level Change.

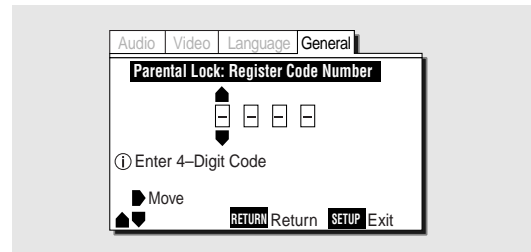

- 2 Use the number buttons to register a new password or confirm your existing password, then press ENTER.

The first time you set the parental lock level, you have to register a password. Anything you input becomes your password.

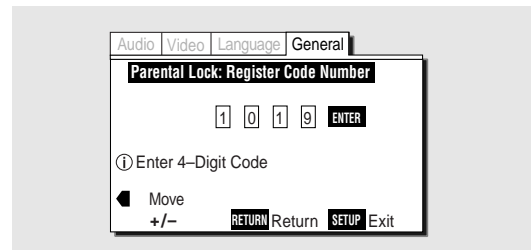

- 3 Select a new level.

Move leftward to lock more levels (more discs will require the password); rightward to unlock levels. You can't lock level 1.

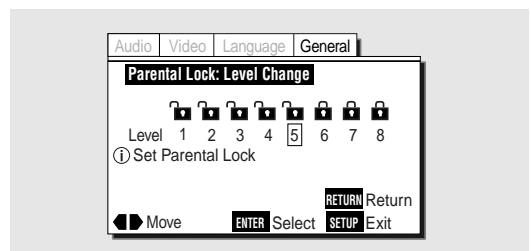

- 4 Press ENTER to set the new level.

The screen returns to the General menu display.

Changing your password

1 Select Password Change.

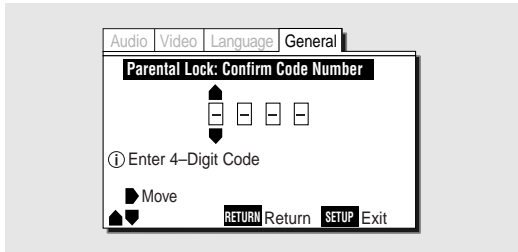

2 Input your existing password, then press ENTER.

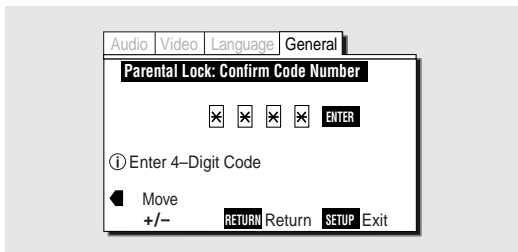

3 Input a new password, then press ENTER.

The new password is set and the screen returns to the General menu display.

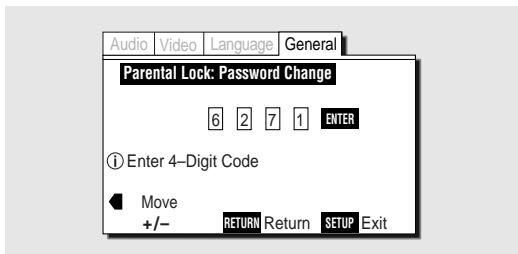

If you forget your password, resetting the system will clear the password. See page 66 for more on this.

Background Color (Expert)

- Default setting: **Blue**

This specifies the color of the screen when there's no video.

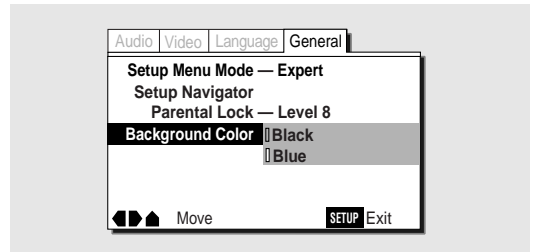

Advanced sound settings

This chapter covers advanced settings to further optimize the sound of your system.

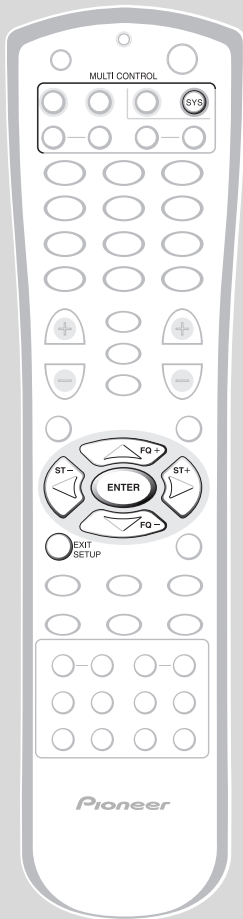

LFE attenuator

The LFE (low frequency effects) channel carries ultra low bass sound to add weight to effects in Dolby Digital and DTS soundtracks. This channel can overload the sub-woofer resulting in distortion. Use the LFE attenuator setting to reduce the signal fed to the sub-woofer.

Note: The LFE attenuator only works with sources that contain an LFE channel. It is not a general level control for the sub-woofer.

- 1 Press **SYS** then **SETUP**.
- 2 Press the **<** or **>** button until you see **LFE ATT** in the display.

LFE ATT 0

- 3 Use the **△** and **▽** buttons to set the amount of signal reduction.

There are three settings:

- **ATT 0** – default setting (no signal reduction)
- **ATT 10** – the LFE channel signal level is reduced to avoid distortion
- **OFF** – the LFE channel is switched off completely. This may be useful late at night, for example.

- 4 Press **ENTER** to make the setting.

Dynamic Range Control

The dynamic range of a source is the difference between the quietest and the loudest sounds. The dynamic range of Dolby Digital soundtracks can be very great. This makes them exciting, but it also means that when you turn the volume down you can easily lose quiet dialog. Switch on Dynamic Range Control to even out the soundtrack volume.

- 1 Press **SYS** then **SETUP**.
- 2 Press the **<** or **>** button until you see **D.R.C.** in the display.

D.R.C. OFF

- 3 Use the **△** and **▽** buttons to select a dynamic range setting.

- **D.R.C. OFF** – default setting (no change to the dynamics)
- **D.R.C. LOW** – the dynamic range is reduced by a small amount.
- **D.R.C. MEDIUM** – mid setting
- **D.R.C. HIGH** – the dynamic range is reduced by a large amount (good for listening at very low volume).

- 4 Press **ENTER** to make the setting.

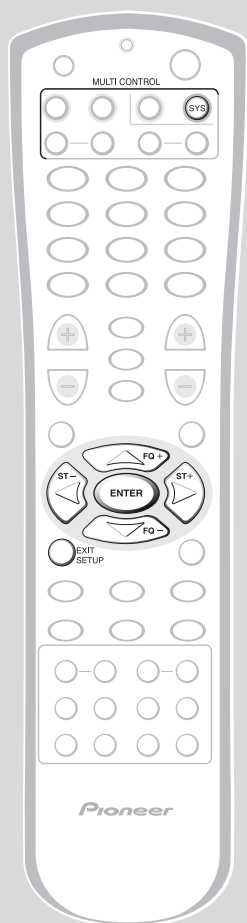

Dual-mono setting

The dual-mono setting applies only to Dolby Digital discs that feature dual-mono material—see the disc box for details.

Dual-mono discs are recorded with two independent channels that may be played together or separately depending on the situation. For example, a guitar tuition disc might have the guitar recorded on one channel and all the other instruments on the other. Use the dual-mono setting to play just the guitar part on its own; just the backing, or everything together (through separate speakers, or mixed).

- 1 Press **SYS** then **SETUP**.
- 2 Press the **<** or **>** button until you see **STEREO** or **DUAL MONO** in the display.

STEREO

DualMono Ch1

- 3 Use the **△** and **▽** buttons to select a dual-mono setting.
 - **STEREO** – default setting (Ch1 is played through the left speaker; Ch2 through the right)
 - **DualMono Ch1** – Ch1 is played through the center speaker (or through the left and right speakers if Surround Off is selected); Ch2 is muted.
 - **DualMono Ch2** – Ch2 is played through the center speaker (or through the left and right speakers if Surround Off is selected); Ch1 is muted.
 - **DualMono MIX** – Ch1 and Ch2 are mixed together and played through the center speaker (or through both left and right speakers if Surround Off is selected).
- 4 Press **ENTER** to make the setting.

Setting up the remote control

In addition to controlling this system, you can set up the remote to operate other audio/visual components, such as your TV, VCR, MD recorder, and so on.

To set up the remote, often all you need to do is to tell it what component(s) you have (see *Setting up using component presets* below). If you have a component that the remote doesn't know how to control already, you can 'teach' it using that component's remote control (see *Learning directly from other remote controls* on page 45).

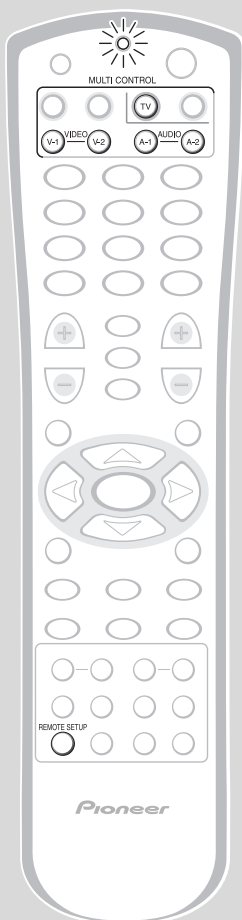

Setting up using component presets

This method of setting up the remote requires only that you tell it the manufacturer of each component. You do this by looking up the type of component (TV, MD deck, etc.), and the manufacturer in the *Preset code list* starting on page 60.

After setting up, see pages 48 – 52 for how to actually control your other components using this remote.

Note: The correct preset code may not cover all the remote control commands for your particular components. Use the learning function to program extra commands (see *Learning directly from other remote controls* on page 45).

1 Switch on the component you are setting up this remote for.

After you've entered the correct code in the steps below, the remote should switch off the component.

2 Press and hold REMOTE SETUP for three seconds.

The red LED at the top of the remote blinks twice.

- To cancel, press **REMOTE SETUP** again.

3 Press the MULTI CONTROL button for the component you want to control.

For example, if you want to set up the remote to control your TV, press **TV**.

The **MULTI CONTROL** buttons have different types of components assigned to them by default:

- **V-1** – analog or digital VCR, DVD, DVD-R, LD, DVD/LD player (default: Pioneer VCR, 0058).
- **V-2** – Satellite, cable or DTV tuner (default: Pioneer cable TV tuner, 0533).
- **A-1** and **A-2** – CD player, CD-R recorder, tape deck, MD deck (A-1 default: Pioneer CD-R recorder, 1087. A-2 default: Pioneer CD player, 0032).
- **TV** – television (default: Pioneer TV, 0679).

You can change these assignments if you need to. For example, if you connected an audio component to one of the video inputs/outputs. See page 44 for how to do this.

4 Look up the preset code for your component.

You can find this in *Preset code list* starting on page 60. First find the type of component (TV, etc.), then find the manufacturer. Next to each manufacturer is one or more 4-digit codes.

- If you can't find the manufacturer of your component in the code list, press **REMOTE SETUP** to exit, then see *Learning directly from other remote controls* on page 45 for how to set up the remote using an alternative method.
- If no button is pressed for more than 10 seconds, remote setup is exited.

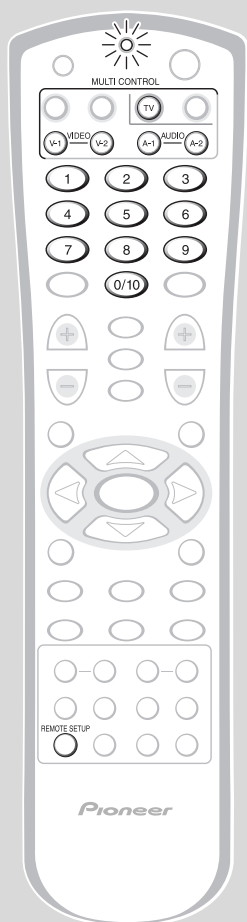

5 Point the remote at the component to control and enter the 4-digit code.

If there's more than one code, enter the first one.

The LED blinks after each button press, and twice to confirm a valid code has been input. If it doesn't blink twice, you have entered an invalid code: check the code and input it again.

If all went well, the remote should have just switched off the other component. If it didn't, and the manufacturer has more than one code in the list, start again from step 1 using another code.

Reassigning a MULTI CONTROL button

You can only assign preset codes for certain kinds of components to each **MULTI CONTROL** button. However, if necessary, you can reassign a **MULTI CONTROL** button to a different kind of component. You would need to do this if you connected an MD recorder to the Video 1 inputs/outputs, for example.

1 Press and hold REMOTE SETUP for three seconds.

The LED at the top of the remote will blink twice.

2 Press the MULTI CONTROL button which you want to change.

You can reassign these buttons:

- V-1
- V-2
- A-1
- A-2
- TV

In the above example, press **V-1**.

3 Use the number buttons to enter 992.

4 Press the MULTI CONTROL button which you want duplicated.

In the above example, press **A-1**.

Learning directly from other remote controls

If preset codes are not available for your component(s), or the available preset codes do not work, you can use this method to teach the remote each command separately.

You can also use this operation to program additional commands for a component not covered in the preset codes.

1 Press and hold REMOTE SETUP for three seconds.

The LED at the top of the remote blinks twice.

2 Press the MULTI CONTROL button for the component you want to control.

For example, press **VIDEO V-1** to program a command from a VCR connected to the Video 1 inputs/outputs.

3 Using the number buttons, enter 975.

The LED flashes rapidly to indicate that the remote is in Learning Setup mode and ready to learn new commands from another remote.

- The remote will exit Learning Setup after 10 seconds if no commands are entered.
- To cancel Learning Setup here, press **REMOTE SETUP**.

4 Press the MULTI CONTROL button again for the component you want to control.

5 Press the button on this system's remote that you want to learn a new command.

For example, press ►.

The illustration left shows the buttons that can be used to learn commands.

6 Point the remotes towards each other, about 2-5 cm (1-2 inches) apart.

7 Press the button on the other component's remote for the command you want to program.

The LED on this system's remote will go out and then blink twice when the command has been learned.

- If the LED doesn't start blinking, try varying the distance between the remotes, then press the button again.
- Some commands from other remote controls cannot be learned, but in most cases the remotes just need to be moved closer together or farther apart.
- If the LED starts to blink slowly, it may mean that no more commands can be learnt. If it is necessary to learn another command, first delete another learnt command—see the following page.

8 Program additional commands for the same component as required.

Repeat steps 5 through 7.

9 Program commands for other components as required.

Repeat steps 4 through 7.

10 When you're done, press REMOTE SETUP to exit Learning Setup mode.

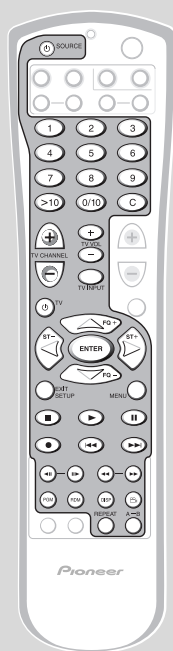

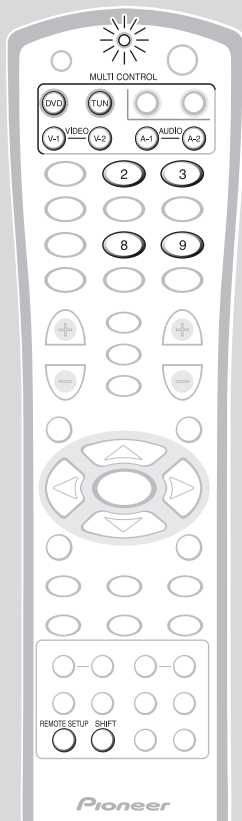
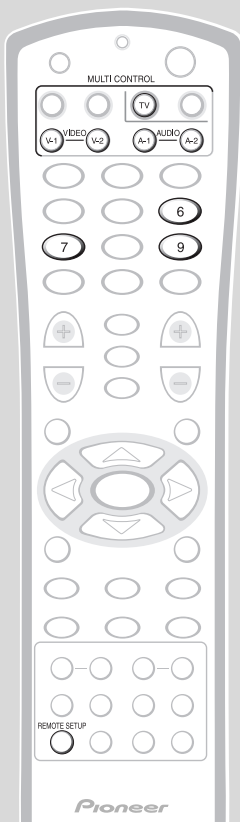

Deleting a single command

- 1 Press and hold **REMOTE SETUP** for three seconds.
- 2 Press the **MULTI CONTROL** button related to the command you want to delete.
For example, press **VIDEO V-1** if the command you want to delete is one for a VCR connected to the Video 1 inputs.
- 3 Use the number buttons to enter **976**.
- 4 Press the same **MULTI CONTROL** button again.
In the above example, press **VIDEO V-1** again.
- 5 Press twice the command button you want to delete.

Deleting all commands for a component

- 1 Press and hold **REMOTE SETUP** for three seconds.
- 2 Press the **MULTI CONTROL** button related to the commands you want to delete.
For example, press **VIDEO V-1** if the commands you want to delete are for a VCR connected to the Video 1 inputs.
- 3 Use the number buttons to enter **976**.
- 4 Press the same **MULTI CONTROL** button twice more.
In the above example, press **VIDEO V-1** twice.

Controlling a component while playing another

This feature allows you to keep the system in one function (for example, CD) while putting the remote control in a different one (Video 1, for example). This may be useful if you were listening to a CD and wanted to rewind a video tape, for example.

- 1 Press **SHIFT**, then press the **MULTI CONTROL** button for the component you want to control.
The system remains in the same function, but the remote is in a different one.
- 2 To switch back to the original function, press the **MULTI CONTROL** for the current system function.

It's also possible to set up the remote so that a particular multi control button always *only* switches the remote control mode and not the system function.

- 1 Press and hold **REMOTE SETUP** for three seconds.
The LED at the top of the remote blinks twice.
- 2 Press the **MULTI CONTROL** button you want to set up.
- 3 Use the number buttons to enter **983**.
The LED on the top of the remote blinks twice. Now, when you press that **MULTI CONTROL** button, only the remote mode changes.
 - To change the button back, repeat the above, entering **982** in step 3.

Clearing all remote control settings

This clears all presets, all learnt functions and restores the factory presets.

- 1 Press and hold REMOTE SETUP for three seconds.**
The LED at top of the remote blinks twice.
- 2 Press any MULTI CONTROL button.**
- 3 Use the number buttons to enter 981.**
The LED blinks a total of four times to indicate the button has been cleared.

Checking preset codes

To check which preset code is associated with a **MULTI CONTROL** button:

- 1 Press and hold REMOTE SETUP for three seconds.**
The LED at top of the remote will blink twice.
- 2 Press the MULTI CONTROL button you want to check the preset code for.**
- 3 Use the number buttons to enter 990.**
Each preset code consists of four digits, for example 1329. Each digit will be represented by a series of blinks on the remote's LED—3 blinks to represent the digit “3”, etc.
- 4 Press 1.**
The blinking LED indicates the left-most digit of the preset code (“1” in the example above).
- 5 Press 2.**
The blinking LED indicates the next digit of the preset code (“3” in the example above).
- 6 Press 3.**
The blinking LED indicates the next digit of the preset code (“2” in the example above).
- 7 Press 4.**
The blinking LED indicates the right-most digit of the preset code (“9” in the example above).

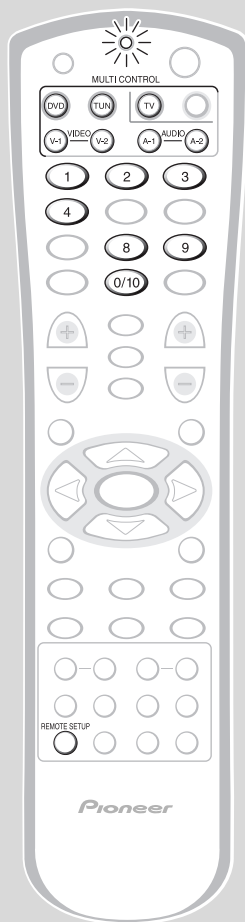

11 Controlling Other Equipment

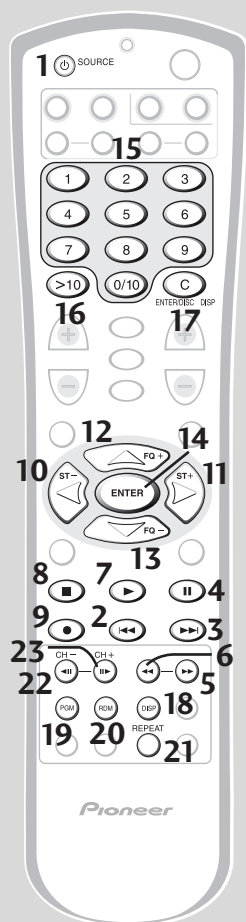

CD/MD/CD-R/VCR/LD player controls

These controls are available after you set up the remote to control. See *Setting up the remote control* on page 43 for how to do this.

- 1** **SOURCE**
Press to switch between standby and on.
- 2** **<<<**
Press to return to the start of the current track. Repeated presses skips to the start of previous tracks.
- 3** **>>>**
Press to advance to the start of the next track. Repeated presses skips to the start of following tracks.
- 4** **||**
Press to pause playback.
- 5** **>>>**
Hold down for fast playback.
- 6** **<<<**
Hold down for fast reverse playback.
- 7** **>**
Press to start playback.
- 8** **■**
Press to stop playback.
- 9** **●**
Press twice within 10 seconds to start recording or pause recording.
- 10** **<**
Press to rewind or reverse program source.
- 11** **>**
Press to fast forward program source.
- 12** **▲**
Press to pause program source.
- 13** **▼**
Press to stop program source.
- 14** **ENTER**
to play program source.
- 15** **Number buttons**
Used to directly access tracks on a program source.
- 16** **>10**
Use to select track numbers over 10.
- 17** **ENTER/DISC, C**
Function varies with the component:
CD changer : selects a disc
CD-R, MD, LD : clear function
VCR : enter function
- 18** **DISP**
Press to switch the display.
- 19** **PGM**
Press to start program play.
- 20** **RDM**
Press to start random play.
- 21** **REPEAT**
Press to start repeat play.
- 22** **CH -**
Press to change the TV channel on the VCR.
- 23** **CH +**
Press to change the TV channel on the VCR.

Cassette deck controls

These controls are available after you set up the remote to control. See *Setting up the remote control* on page 43 for how to do this.

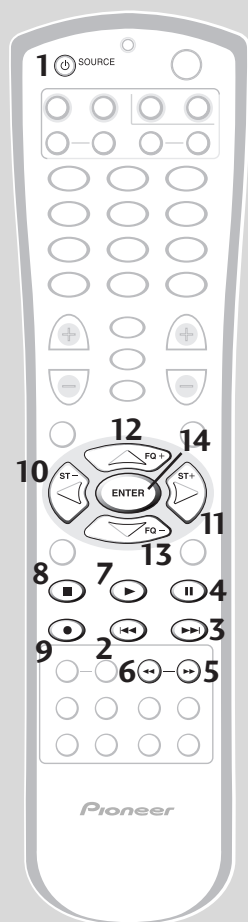

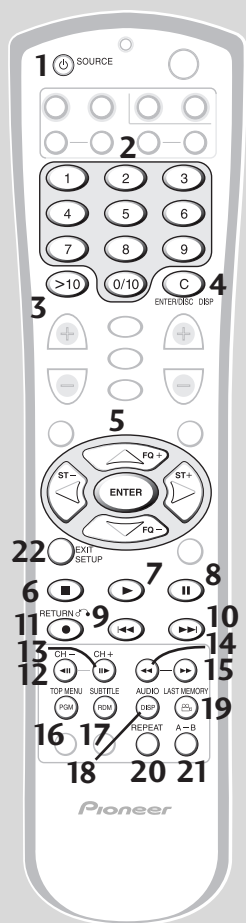

- 1 **⏻ SOURCE**
Press to switch between standby and on (not possible on all models).
 - 2 **⏮**
Use to play the reverse side of the tape on a reversible deck.
 - 3 **⏭**
Use to play the forward side of the tape on a reversible deck.
 - 4 **⏸**
Press to pause playback or recording.
 - 5 **⏩**
Press to fast forward the tape. Pressing during playback starts forward search.
 - 6 **⏪**
Press to rewind the tape. Pressing during playback starts reverse search.
 - 7 **▶**
Press to start playback.
 - 8 **■**
Press to stop playback.
- For deck two or any tape deck that can record:**
- 9 **●**
Press twice within 10 seconds to start recording or pause recording.
- For deck one of a dual tape deck:**
- 10 **◀**
Press to rewind the tape.
 - 11 **▶**
Press to fast forward the tape.
 - 12 **▲**
Press to pause the tape.
 - 13 **▼**
Press to stop the tape.
 - 14 **ENTER**
Press to start playback.

11 Controlling Other Equipment



DVD/DVR player controls

These controls are available after you set up the remote to control. See *Setting up the remote control* on page 43 for how to do this.

- 1 SOURCE**
Press to switch the DVD or DVR between standby and on.
- 2 Number buttons**
Press to directly access tracks.
- 3 >10**
Use to select track numbers over 10.
- 4 C**
Use to clear function.
- 5 ▲/▼/◀/▶/ENTER**
Use to navigate items on the menu screen.
- 6 ■**
Press to stop playback or recording.
- 7 ▶**
Press to start playback.
- 8 II**
Press to pause playback or recording.
- 9 ◀◀**
Press to return to the start of the current track. Repeated presses skip to the start of previous tracks.
- 10 ▶▶**
Press to advance to the start of the next track. Repeated presses skip to the start of following tracks.
- 11 RETURN**  / ●
DVD : Use to go back one menu.
DVR : Press twice within 10 seconds to start recording.
- 12 ◀II/CH-**
Press during playback for reverse slow motion. When paused, press to go back frame-by-frame. For DVR, use to change channels.
- 13 II▶/CH+**
Press during playback for slow motion. When paused, press to advance frame-by-frame. For DVR, use to change channels.
- 14 ◀◀**
Press and hold for fast reverse scanning.
- 15 ▶▶**
Press and hold for fast forward scanning.
- 16 TOP MENU/PGM**
Press to display the top menu of a DVD disc. Press with **SHIFT** to program a playlist of tracks.
- 17 SUBTITLE/RDM**
Press to display/switch subtitles. Press with **SHIFT** to start random playback.
- 18 AUDIO/DISPLAY**
Press to select the audio language. Press with **SHIFT** to display/switch disc information.
- 19 LAST MEMORY** 
Press to set a bookmark, or start playback from a bookmarked disc. Press with **SHIFT** to switch camera angles.
- 20 REPEAT/CONDITION**
Press once to repeat playback of the current track, or twice to repeat playback of the current title. Press with **SHIFT** to save the player settings for the currently loaded disc.
- 21 A-B /SEARCH MODE**
Press once to mark the start of a loop; press again to mark the end and start looping. Press with **SHIFT** to select the disc search mode.
- 22 SETUP**
Press to access the Setup menu.

DTV controls

These controls are available after you set up the remote to control. See *Setting up the remote control* on page 43 for how to do this.

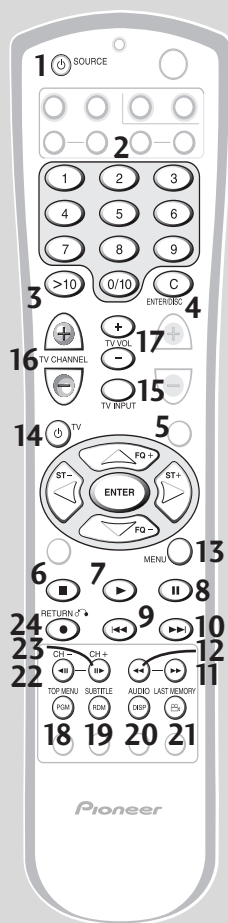

- 1** **⏻ SOURCE**
Press to switch the TV on or off.
 - 2** **Number buttons**
Use to select a specific TV channel.
 - 3** **>10 (•)**
Use to add a decimal point when selecting a specific TV channel.
 - 4** **ENTER/DISC**
Use to enter a channel.
 - 5** **▲/▼/◀/▶/ENTER**
Press to select or adjust and navigate items on the menu screen.
ENTER
Use to bring up the DTV menus.
 - 6** **■ (CLOSED CAPTION)**
Press to display closed captions
 - 7** **▶ (AUDIO)**
Press to select audio channels
 - 8** **⏏ (SCREEN MODE)**
Press to select the screen mode.
 - 9** **⏪ (DTV)**
Press to switch the DTV on/off
 - 10** **▶▶ (MENU)**
Use to display the menu.
 - 11** **▶▶▶ (GUIDE)**
Use as the Guide button for navigation.
 - 12** **◀◀ (CLEAR)**
Press to clear the DTV menu.
 - 13** **MENU**
Use to select different menus from the DTV functions.
- These four buttons are dedicated TV control buttons.**
- 14** **⏻ TV**
Press to switch the TV between standby and on.
 - 15** **TV INPUT**
Press to switch the TV input (not possible with some models).
 - 16** **TV CHANNEL +/-**
Use to select channels.
 - 17** **TV VOL +/-**
Use to adjust the TV volume.
 - 18** **TOP MENU (BLUE)**
Use to choose the blue commands on a DTV menu.
 - 19** **SUBTITLE (GREEN)**
Use to choose the green commands on a DTV menu.
 - 20** **AUDIO (RED)**
Use to choose the red commands on a DTV menu.
 - 21** **LAST MEMORY (YELLOW)**
Use to choose the yellow commands on a DTV menu.
 - 22** **CH -**
Press to change the DTV channel.
 - 23** **CH +**
Press to change the DTV channel.
 - 24** **RETURN ⏪ / ● (Information)**
Press to get INFO on the DTV program.

11 Controlling Other Equipment

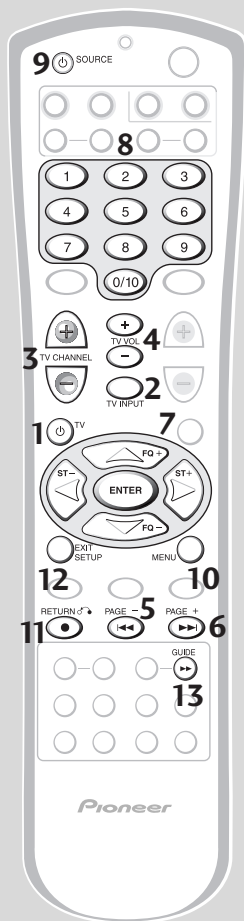

Cable TV/satellite TV/TV controls

These controls are available after you set up the remote to control. See *Setting up the remote control* on page 43 for how to do this.

The first four buttons are dedicated TV control buttons.

- 1 TV**
Press to switch the TV between standby and on.
- 2 TV INPUT**
Press to switch the TV input (not possible with some models).
- 3 TV CHANNEL +/-**
Use to select channels.
- 4 TV VOL +/-**
Use to adjust the TV volume.
- 5 PAGE -**
Press to display the previous menu page on cable TV.
- 6 PAGE +**
Press to display the next menu page on cable TV.
- 7 ▲/▼/◀/▶/ENTER**
Press to select or adjust and navigate items on the menu screen.
- 8 Number buttons**
Use to select a specific TV channel.
- 9 SOURCE**
Press to switch the TV or CATV between standby and on.
- 10 MENU**
Press to display or close the TV or CATV menu.
- 11 RETURN (INFO)**
Press to display information on cable TV.
- 12 EXIT**
Press to exit.
- 13 GUIDE**
Press to switch the program information screen for cable TV on/off.

Connecting to a TV with the supplied video cord

Important: Before making or changing any rear panel connections, switch off the power and disconnect the power cord from the AC outlet.

You can connect this system to any TV using this output jack with the supplied video cord. However, if your TV has an S-Video input, we recommend also using that since you should get a better picture.

Refer to the TV's instruction manual for more detailed connection instructions.

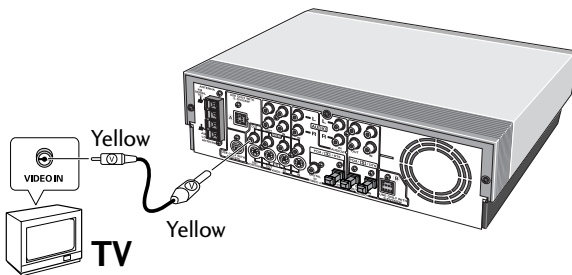

Connecting to a TV with an S-Video cord

Many TVs also have an S-Video input which you can use to connect to this system using an S-Video cord (not supplied).

Refer to the TV's instruction manual for more detailed connection instructions.

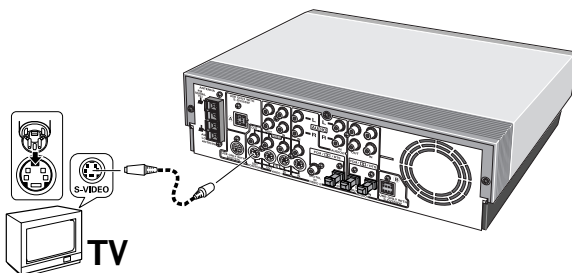

Playing your TV through this system

When watching cable or satellite TV, it's best to connect the cable/satellite box directly to this system, rather than going via the TV. However, if you're watching TV via an antenna plugged directly into the back of the TV, then connect your TV's audio outputs to the **AUDIO 1** or **AUDIO 2** inputs of this system to play the TV's audio through the speakers of this system. Use a standard stereo audio cord (not supplied), matching up the colors both ends for best results.

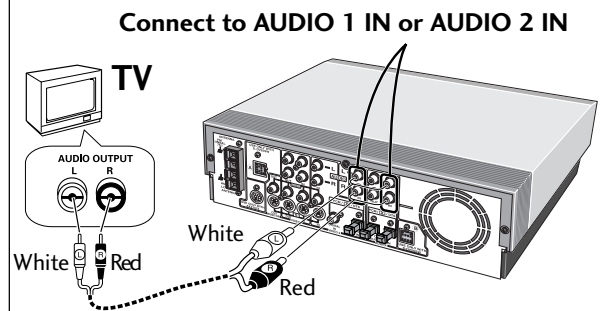

Watching TV

With the above connections made, your TV becomes another source component for this system.

To play your TV through this system, press the AUDIO A-1 or A-2 button (depending on which one the TV is connected to).

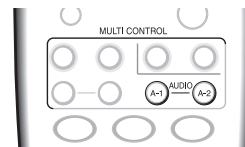

If the TV is connected to **AUDIO 1**, memorize its remote control codes in the **AUDIO A-1** multi control button. If it is connected to **AUDIO 2**, memorize its remote control codes in the **AUDIO A-2** multi control button. See chapter 11 for more on this.

Connecting Other Components

- Connect an audio/visual player or recorder, such as a video recorder or satellite decoder to the **VIDEO 1** inputs/outputs.
- Connect an audio/visual player, such as a video deck or satellite decoder to the **VIDEO 2** inputs. If the player has a digital audio output, connect to the **VIDEO 2 DIGITAL IN** or **OPTICAL IN** jacks.

See *Switching between digital and analog sources* on page 19 for more on this.

- Connect an audio player/recorder, such as an MD deck, to the **AUDIO 1** analog inputs/outputs. If the player/recorder has optical digital jacks, connect to the **AUDIO 1 OPTICAL IN** to the player/recorder's optical output, and **AUDIO 1 OPTICAL OUT** to the player/recorder's optical input.

See *Switching between digital and analog sources* on page 19 for more on this.

- Connect an audio player to the **AUDIO 2** analog inputs.

LD player, video deck, etc.
(Components with audio/
video capability)

Tape deck, etc.
(Audio only
components)

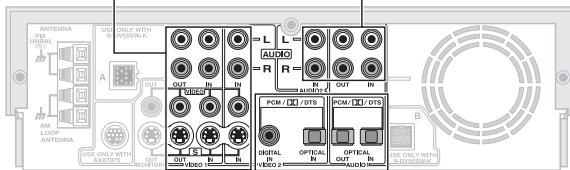

For digital connection

Important: if you connect a video component with an S-Video cord, your TV must also be connected to this unit with an S-Video cord.

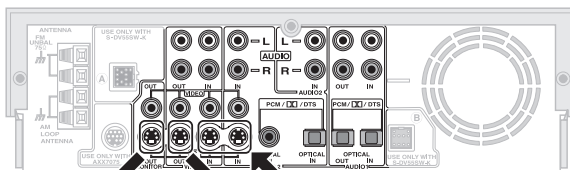

To the TV's S-Video input

From an auxiliary component's S-Video output jacks

To an auxiliary component's S-Video input jacks

Important: if you connect a video component with a standard video cord, your TV must also be connected to this system with a standard video cord.

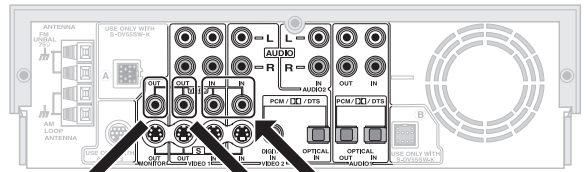

To the TV's video input

From an auxiliary component's video output jacks

To an auxiliary component's video input jacks

Connecting an audio recorder

Analog inputs are only output from the analog outputs. (You can't record an analog input via the digital output.) Likewise, you can't record a digital input via the analog outputs.

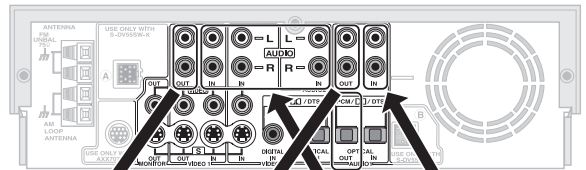

To an auxiliary component's audio input jacks

No output

From an auxiliary component's audio output jacks

No output

No output

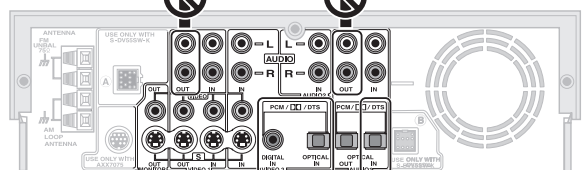

From an auxiliary component's audio output jacks

Connecting outdoor antennas

If reception is poor with the supplied antenna, connect a commercially available outdoor AM and/or FM antenna.

Connecting an outdoor AM Antenna

Connect as shown in the figure below. Do not disconnect the AM loop antenna even if you connect an outdoor AM antenna.

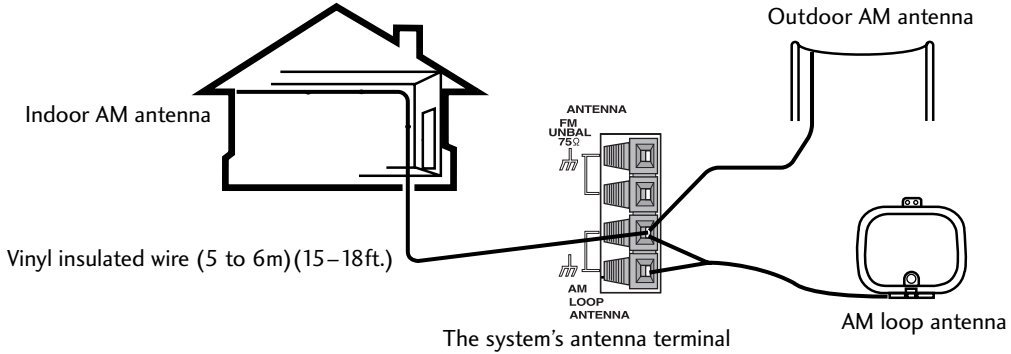

Connecting an outdoor FM Antenna

Connect as shown in the figure below.

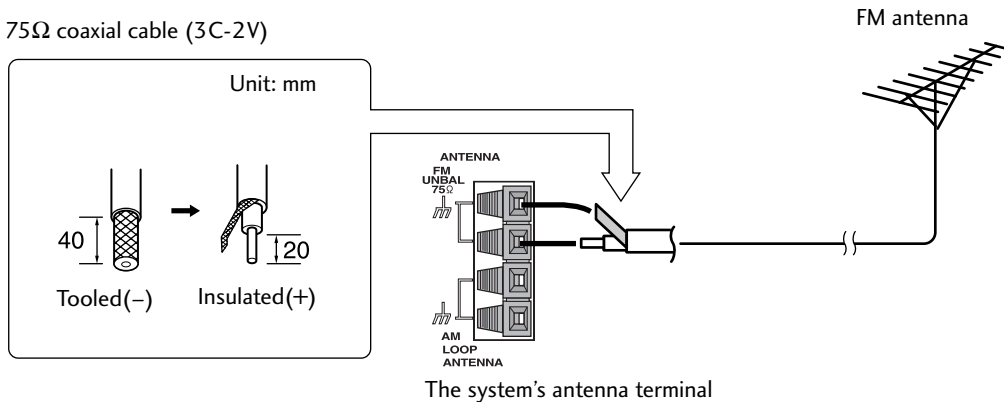

Note: The ground mark (⏏) on the antenna terminal refers to measures to reduce reception noise when an antenna is connected. It does not refer to a safety ground.

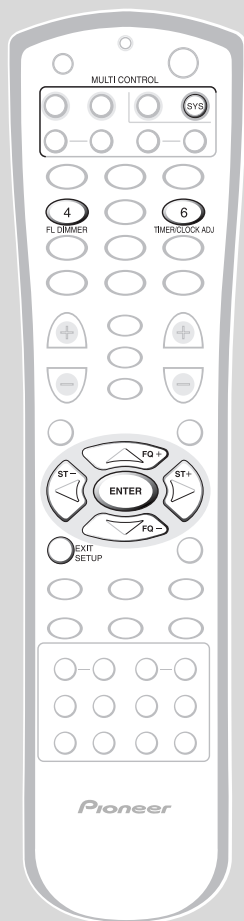

Setting the display brightness

You can adjust the brightness of the display to suit the lighting conditions of the room. For example, in a brightly lit room you'd probably want the display brighter than in a room with low lighting.

- **Press SYS then FL DIMMER.**
Press **FL DIMMER** repeatedly to set the display brightness. There are five levels.

Switching the TV system output

DVD and Video CD discs are recorded in either PAL or NTSC format. This setting determines which TV signal format is output to your TV.

- 1 With the system in standby, press SYS then SETUP.**
- 2 Press the ◀ or ▶ button until you see DVD VIDEO in the display.**

DVD VIDEO AUTO

- 3 Use the ▲ and ▼ buttons to select a video out setting.**
 - **DVD VIDEO AUTO** – default setting (video is output according to the disc loaded: PAL if it's a PAL disc; NTSC if it's an NTSC disc). If you have a multi-system TV, leave this setting as **AUTO**.
 - **DVD VIDEO PAL** – output is always PAL, even when an NTSC disc is loaded. Use this setting if your TV is PAL-compatible only.
 - **DVD VIDEO NTSC** – PAL Video CDs are output as NTSC; PAL DVD discs cannot be played on this setting. Use this setting if your TV is NTSC-compatible only.
- 4 Press ENTER to make the setting.**

Taking care of your system

To clean this unit, wipe with a soft, dry cloth. For stubborn dirt, wet a soft cloth with a mild detergent solution made by diluting one part detergent to 5 or 6 parts water, wring well, then wipe off the dirt. Use a dry cloth to wipe the surface dry. Do not use volatile liquids such as benzene and thinner which may damage the surfaces.

Disc lens cleaner

The disc pickup lens should not become dirty in normal use, but if for some reason it should malfunction due to dirt or dust, consult your nearest Pioneer authorized service center. Although lens cleaners for CD players are commercially available, we do not recommend using them since some may damage the lens.

Taking care of your discs

When holding discs, take care not to leave fingerprints, dirt or scratches on the disc surface. Hold the disc by its edge or by the center hole and edge. Damaged or dirty discs can affect playback performance. Take care also not to scratch the label side of the disc. Although not as fragile as the recorded side, scratches can still result in a disc becoming unusable.



Should a disc become marked with fingerprints, dust, etc., clean using a soft, dry cloth, wiping the disc lightly from the center to the outside edge as shown on the right. If necessary, use a cloth soaked in alcohol, or a commercially available CD or DVD cleaning kit to clean a disc more thoroughly. Never use benzene, thinner or other cleaning agents, including products designed for cleaning vinyl records.

- **Wipe lightly from the center of the disc using straight strokes.**

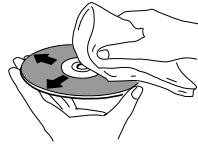

- **Don't wipe the disc surface using circular strokes.**



Storing discs

Although CDs and DVDs are more durable than vinyl records, you should still take care to handle and store discs correctly. When you're not using a disc, return it to its case and store upright. Avoid leaving discs in excessively cold, humid, or hot environments (including under direct sunlight).

Don't glue paper or put stickers on discs, or write on them using a pencil, ball-point pen or other sharp-tipped writing instrument.



Discs to avoid

Discs spin at high speed during playback. If you can see that a disc is cracked, chipped, warped, or otherwise damaged, don't risk using it—you could end up damaging the system.

This system is designed for use with conventional, fully circular discs only. Use of shaped discs is not recommended. Pioneer disclaims all liability arising in connection with the use of shaped CDs and DVDs.

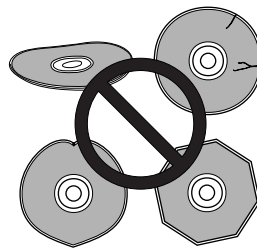

Glossary

Analog audio

An electrical signal that directly represents sound. Compare this to digital audio which can be an electrical signal, but is an indirect representation of sound. See also Digital audio.

Aspect ratio

The width of a TV screen relative to its height. Conventional TVs are 4:3 (in other words, the screen is almost square); widescreen models are 16:9 (the screen is almost twice as wide as it is high).

Chapter (DVD only)

Just as a book is split up into several chapters, a title on a DVD disc is usually divided into chapters. See also *Title*.

Digital audio

An indirect representation of sound by numbers. During recording, the sound is measured at discrete intervals (44,100 times a second for CD audio) by an analog-to-digital converter, generating a stream of numbers. On playback, a digital-to-analog converter generates an analog signal based on these numbers. See also *Sampling frequency* and *Analog audio*.

Dolby Digital

A surround sound system developed by Dolby Laboratories containing up to six channels of digital audio (front left and right, surround left and right, center and low-frequency channels). See also *DTS*.

DTS

A surround sound system developed by Digital Theater Systems as an alternative to Dolby Digital. DTS discs contain up to eight channels of digital audio. See also *Dolby Digital*.

Dynamic range

The difference between the quietest and loudest sounds possible in an audio signal (without distorting or getting lost in noise). Dolby Digital and DTS soundtracks are capable of a very wide dynamic range, delivering dramatic cinema-like effects.

MPEG video

The video format used for Video CDs and DVDs. Video CD uses the older MPEG-1 standard, while DVD uses the newer and much better quality MPEG-2 standard.

Optical digital output

A jack that outputs digital audio in the form of light pulses. Connect components with optical digital jacks using a special optical cord, available from good audio dealers.

PCM (Pulse Code Modulation)

The most common system of encoding digital audio, found on CDs and DAT. Excellent quality, but requires a lot of data compared to formats such as Dolby Digital and MPEG audio. For compatibility with digital audio recorders (CD, MD and DAT) and AV amplifiers with digital inputs, this unit can convert Dolby Digital and MPEG audio to PCM. See also *Digital audio*.

PBC (PlayBack Control) (Video CD only)

A system of navigating a Video CD through on-screen menus recorded onto the disc. Especially good for discs that you would normally not watch from beginning to end all at once—karaoke discs, for example.

Regions (DVD only)

These associate discs and players with particular areas of the world. This unit will only play discs that have compatible region codes. You can find the region code of your unit by looking on the rear panel. Some discs are compatible with more than one region (or all regions).

Sampling frequency

The rate at which sound is measured to be turned into digital audio data. The higher the rate, the better the sound quality, but the more digital information is generated. Standard CD audio has a sampling frequency of 44.1kHz, which means 44,100 samples (measurements) per second. See also *Digital audio*.

Title (DVD only)

A collection of chapters on a DVD disc. See also *Chapter*.

DVD language code list

The table below lists all the languages and codes that are recognized by the DVD standard.

Language	Code	Language	Code	Language	Code
Japanese/japonais (ja)	1001	Hausa (ha)	0801	Quechua (qu)	1721
English/anglais (en)	0514	Hindi (hi)	0809	Rhaeto-Romance (rm)	1813
French (fr)	0618	Croatian (hr)	0818	Kirundi (rn)	1814
German (de)	0405	Hungarian (hu)	0821	Romanian (ro)	1815
Italian (it)	0920	Armenian (hy)	0825	Kinyarwanda (rw)	1823
Spanish (es)	0519	Interlingua (ia)	0901	Sanskrit (sa)	1901
Dutch (nl)	1412	Interlingue (ie)	0905	Sindhi (sd)	1904
Russian (ru)	1821	Inupiak (ik)	0911	Sangho (sg)	1907
Chinese (zh)	2608	Indonesian (in)	0914	Serbo-Croatian (sh)	1908
Korean (ko)	1115	Icelandic (is)	0919	Singhalese (si)	1909
Greek (el)	0512	Hebrew (iw)	0923	Slovak (sk)	1911
Afar (aa)	0101	Yiddish (ji)	1009	Slovenian (sl)	1912
Abkhazian (ab)	0102	Javanese (jw)	1023	Samoaan (sm)	1913
Afrikaans (af)	0106	Georgian (ka)	1101	Shona (sn)	1914
Amharic (am)	0113	Kazakh (kk)	1111	Somali (so)	1915
Arabic (ar)	0118	Greenlandic (kl)	1112	Albanian (sq)	1917
Assamese (as)	0119	Cambodian (km)	1113	Serbian (sr)	1918
Aymara (ay)	0125	Kannada (kn)	1114	Siswati (ss)	1919
Azerbaijani (az)	0126	Kashmiri (ks)	1119	Sesotho (st)	1920
Bashkir (ba)	0201	Kurdish (ku)	1121	Sundanese (su)	1921
Byelorussian (be)	0205	Kirghiz (ky)	1125	Swedish (sv)	1922
Bulgarian (bg)	0207	Latin (la)	1201	Swahili (sw)	1923
Bihari (bh)	0208	Lingala (ln)	1214	Tamil (ta)	2001
Bislama (bi)	0209	Laotian (lo)	1215	Telugu (te)	2005
Bengali (bn)	0214	Lithuanian (lt)	1220	Tajik (tg)	2007
Tibetan (bo)	0215	Latvian (lv)	1222	Thai (th)	2008
Breton (br)	0218	Malagasy (mg)	1307	Tigrinya (ti)	2009
Catalan (ca)	0301	Maori (mi)	1309	Turkmen (tk)	2011
Corsican (co)	0315	Macedonian (mk)	1311	Tagalog (tl)	2012
Czech (cs)	0319	Malayalam (ml)	1312	Setswana (tn)	2014
Welsh (cy)	0325	Mongolian (mn)	1314	Tonga (to)	2015
Danish (da)	0401	Moldavian (mo)	1315	Turkish (tr)	2018
Bhutani (dz)	0426	Marathi (mr)	1318	Tsonga (ts)	2019
Esperanto (eo)	0515	Malay (ms)	1319	Tatar (tt)	2020
Estonian (et)	0520	Maltese (mt)	1320	Twí (tw)	2023
Basque (eu)	0521	Burmese (my)	1325	Ukrainian (uk)	2111
Persian (fa)	0601	Nauru (na)	1401	Urdu (ur)	2118
Finnish (fi)	0609	Nepali (ne)	1405	Uzbek (uz)	2126
Fiji (fj)	0610	Norwegian (no)	1415	Vietnamese (vi)	2209
Faroese (fo)	0615	Occitan (oc)	1503	Volapük (vo)	2215
Frisian (fy)	0625	Oromo (om)	1513	Wolof (wo)	2315
Irish (ga)	0701	Oriya (or)	1518	Xhosa (xh)	2408
Scots-Gaelic (gd)	0704	Panjabi (pa)	1601	Yoruba (yo)	2515
Galician (gl)	0712	Polish (pl)	1612	Zulu (zu)	2621
Guarani (gn)	0714	Pashto, Pushto (ps)	1619		
Gujarati (gu)	0721	Portuguese (pt)	1620		

Preset Code List

DVD PLAYER/RECORDER

Manufacturer	Code
Denon	0490, 0634
GE	0522
Harman/Kardon	0582
JVC	0558, 0623
Kenwood	0534
Magnavox	0503
Marantz	0539
Mitsubishi	0521
Onkyo	0503, 0627
Optimus	0571
Panasonic	0490, 0632
Philips	0503, 0539
Pioneer	0525, 0571, 0632, 0631(DVD-R)
Proscan	0522
RCA	0522
Samsung	0573
Sharp	0630
Sherwood	0633
Sony	0533
Technics	0490
Theta Digital	0571
Toshiba	0503
Yamaha	0490, 0545
Zenith	0503, 0591

LASERDISC PLAYER

Manufacturer	Code
Aiwa	0203
Akai	0598
Denon	0059, 0172
Disco Vision	0023
Funai	0203, 0584
GoldStar	0172
Hitachi	0023
Hong Deng	0542
Idall	0595
Kebao	0581
Mitsubishi	0059
NAD	0059
Optimus	0059
Panasonic	0204, 0496
Pioneer	0023, 0059, 0463, 0572, 0548
Quasar	0204
Realistic	0203
Rowa	0541
SMC	0596
Sega	0023
Sharp	0597
Shinco	0540
Sony	0193, 0201, 0583, 0589
Super	0581
Technics	0204
Toshiba	0599

TELEVISION (1/4)

Manufacturer	Code
A-Mark	0003
AOC	0003, 0019, 0030
Admiral	0093, 0418, 0463, 1096
Aiko	0092
Akai	0030, 0035
Alaron	0179, 0216
Ambassador	0177
America Action	0180
Ampro	0751
Amstrad	0412
Anam	0003, 0004, 0009, 0068, 0161, 0180, 0250, 0425, 1253
Anam National	0161, 0250, 0425, 0650, 1253
Archer	0003
Audiovox	0003, 0092, 0180, 0451
Baysonic	0180
Belcor	0019
Bell & Howell	0016, 0154
Bradford	0180
Brockwood	0019
Broksonic	0003, 0236, 0463
CCE	0037
CXC	0180
Candle	0030, 0056, 0186
Carnivale	0030
Carver	0054, 0170
Celebrity	0000, 1003
Cineral	0092, 0451
Citizen	0030, 0039, 0056, 0060, 0092, 0186, 1063
Concerto	0056
Contec	0180
Craig	0161, 0180
Crosley	0054
Crown	0039, 0180, 0418
Curtis Mathes	0016, 0030, 0039, 0047, 0051, 0054, 0056, 0060, 0093, 0145, 0154, 0451, 0466, 1063, 1096, 1147, 1148, 1166, 1347
Daewoo	0019, 0039, 0066, 0092, 0154, 0451
Daytron	0019
Denon	0145, 1148
Dumont	0017, 0019
Dwin	0720, 0774
ECE	0037
Electroband	0000, 1003
Emerson	0019, 0038, 0039, 0154, 0177, 0178, 0179, 0180, 0236, 0282, 0463, 1181
Envision	0030
Etron	0009, 0646
Fisher	0154
Fortress	0093, 1096

TELEVISION (2/4)

Manufacturer	Code
Fujitsu	0179, 0683
Funai	0171, 0179, 0180, 0264, 1174
Futuretech	0180
GE	0021, 0047, 0051, 0093, 0135, 0178, 0282, 0451, 1096, 1147, 1181, 1347
General	0186
Gibraltar	0017, 0019, 0030
GoldStar	0001, 0002, 0019, 0030, 0037, 0039, 0056, 0178, 1181
Gradiente	0053, 0056, 0170, 1056
Grundig	0037
Grunpy	0179, 0180
Hallmark	0178, 1181
Harley Davidson	0179
Harman/Kardon	0054
Harvard	0068, 0180
HCM	0412
Hitachi	0016, 0038, 0056, 0145, 0151, 1148
Infinity	0054
Innova	0037
Inteq	0017
JBL	0054
JCB	0000, 1003
JVC	0036, 0053, 0069, 0094, 0160, 0653, 1056
KEC	0180
KTV	0030, 0039, 0180
Kamp	0216
Kawasho	0216
Kenwood	0019, 0030
LG	0056
LXI	0047, 0054, 0154, 0156, 0178, 1159, 1181
Logik	0016
Luxman	0056
MGA	0019, 0030, 0150, 0178, 1153, 1181
MTC	0019, 0030, 0056, 0060, 0216, 1063
Magnavox	0030, 0036, 0054, 0179, 0186, 1254
Majestic	0016
Marantz	0030, 0037, 0054
Matsushita	0250, 0650, 1253
Megatron	0003, 0145, 0178, 1148, 1181
Memorex	0016, 0056, 0150, 0154, 0178, 0250, 0463, 1181, 1153, 1253
Midland	0017, 0039, 0047, 0051, 0135
Minoka	0412
Minutz	0021

TELEVISION (3/4)

Manufacturer	Code
Mitsubishi	0019, 0093, 0150, 0178, 1096, 1153, 1181, 0108, 0512
Motorola	0093, 1096
Multitech	0180
NAD	0156, 0178, 1159, 1166, 1181
NEC	0019, 0030, 0036, 0056, 0170
NTC	0092
Netsat	0037
Nicamagic	0216
Nikko	0030, 0092, 0178, 1181
Onwa	0180
Optimus	0154, 0250, 0650, 1166, 1253
Optonica	0093, 0165, 1096
Orion	0179, 0236, 0463
Osaki	0412
Panasonic	0051, 0126, 0161, 0250, 0650, 1253
Penney	0002, 0003, 0019, 0021, 0030, 0039, 0047, 0051, 0056, 0060, 0135, 0156, 0178, 1063, 1159, 1181, 1347
Philco	0019, 0030, 0054, 0145, 0418, 0463, 1148
Philips	0037, 0054
Pilot	0019, 0030, 0039
Pioneer	0038, 0172, 1166
Portland	0019, 0039, 0092
Prism	0051
Proscan	0047
Proton	0003, 0178, 0466, 1181
Pulsar	0017, 0019
Quasar	0051, 0165, 0250, 0650, 1253
RCA	0019, 0038, 0047, 0051, 0090, 0093, 0135, 1047, 1096, 1147, 1247, 1347, 1447
Radio Shack	0019, 0030, 0039, 0047, 0056, 0154, 0165, 0178, 0180, 1181
Realistic	0019, 0030, 0039, 0056, 0154, 0165, 0178, 0180, 1181
Rhapsody	0216
Royal	0412
Runco	0017, 0030
SKY	0037
SSS	0019, 0180
Sampo	0030, 0039
Samsung	0019, 0030, 0037, 0056, 0060, 0090, 0178, 1063, 1181
Samsux	0039
Sansei	0451
Sansui	0463

TELEVISION (4/4)

Manufacturer	Code
Sanyo	0154, 0208, 0339
Scimitsu	0019
Scotch	0178, 1181
Scott	0019, 0178, 0179, 0180, 0236, 1181
Sears	0047, 0054, 0056, 0154, 0156, 0171, 0178, 0179, 1159, 1174, 1181
Semivox	0180
Semp	0156, 1159
Sharp	0039, 0093, 0165, 1096
Shogun	0019
Signature	0016
Simpson	0186
Sky-Worth	0037
Sony	0000, 0650, 1003, 0010
Soundesign	0178, 0179, 0180, 0186, 1181
Spectricon	0003
Squareview	0171, 1174
Starlite	0180
SuperTech	0216
Supreme	0000, 1003
Sylvania	0030, 0054
Symphonic	0171, 1174
TMK	0056, 0177, 0178, 1181
Tandy	0093, 1096
Tatung	0003
Technics	0051, 0250, 1253
Technol Ace	0179
Techwood	0003, 0051, 0056
Teknika	0016, 0019, 0039, 0054, 0056, 0060, 0092, 0150, 0179, 0180, 0186, 1063, 1153
Telefunken	0056
Toshiba	0036, 0060, 0154, 0156, 1063, 1159, 1256, 0035
Totevision	0039
Vector Research	0030
Victor	0036, 0053, 0160, 0250, 0650, 1056, 1253
Vidikron	0054
Vidtech	0019, 0036, 0178, 1181
Wards	0016, 0019, 0021, 0030, 0054, 0056, 0165, 0178, 0179, 1181
White Westinghouse	0463
Yamaha	0019, 0030
Zenith	0016, 0017, 0092, 0463
Zonda	0003

CABLE TV/DTV

Manufacturer	Code
ABC	0003, 0007, 0008, 0011, 0014, 0017
Americast	0899
Bell & Howell	0014
Bell South	0899
Contec	0019
Daehan	0778
Daeryung	0008
Everquest	0015
Gemini	0015
General Instrument	0011, 0276, 0476, 0810
GoldStar	0144, 0838
Hamlin	0020
Hitachi	0011
Hytex	0007
Jasco	0015
Jerrold	0003, 0011, 0012, 0014, 0015, 0276, 0476, 0810
LG Alps	0779
Memorex	0000, 1003
Now	0776
Oak	0007, 0019
Pacific	0678
Panasonic	0000, 0107, 1003
Paragon	0000, 1003
Pioneer	0144, 0260, 0533, 0877, 1010(DTV), 1021
Pulsar	0000
Quasar	0000
Radio Shack	0015
Regal	0020
Rembrandt	0011
Runco	0000
Samsung	0144, 0702
Scientific Atlanta	0008, 0017, 0477, 0877
Seawoo	0780
Sharp	0313, 1010(DTV)
Signal	0015
Signature	0011
Starcom	0003, 0015
Stargate	0015
Starquest	0015
Taihan	0778
Tocom	0012
TongKook	0777, 0840
Toshiba	0000
Tusa	0015
United Artists	0007
Zenith	0000, 0525, 0899

13 Additional Information

SATELLITE TUNER

Manufacturer	Code
AlphaStar	0772
DX Antenna	0752
Dae Young	0735
Daeryung	0396
Echostar	0396, 0775, 1005
Expressvu	0775
General Instrument	0361, 0627, 0869
HTS	0775
Hitachi	0489, 0819
Hughes Network Systems	0749
Hung Chang	0732
Hyundai	0758
JVC	0492, 0505, 0506, 0775
Jerrold	0361, 0627
JiWon	0364
Kabil	0737
Magnavox	0722, 0724
Marantz	0200
Memorex	0724
Mitsubishi	0491
NEC	0496, 0499, 0507, 0508
Next Level	0869
Now	0757
Panasonic	0340, 0500, 0701, 0739
Pantech	0747
Philips	0200, 0722, 0724
Pioneer	0662
Primestar	0361, 0627
RCA	0143, 0392, 0566, 0855
Radio Shack	0869
Samsung	0773
Sanyo	0493
Sharp	0494, 0275, 0639, 0661
Sony	0869
Star Choice	0733
Tae Kwang	0486, 0790
Toshiba	0722, 0724
Uniden	0321
VTech	0492, 0505, 0506
Victor	0856
Zenith	

CD PLAYER (1/2)

Manufacturer	Code
ADC	0018
Adcom	0155
Aiwa	0124, 0157
Anam	0362
Audio-Technica	0170
Burmester	0420
California Audio Labs	0029, 0303
Carver	0157, 0179, 0437
DKK	0000
Denon	0003, 0358, 0873
Dynamic Bass	0179
Emerson	0155, 0164, 0305, 0469
Eroica	0562, 0563
Fantasia	0525
Fisher	0174, 0179, 0342
GE	0009
Garrard	0280, 0393, 0420
Genexxa	0032, 0164, 0305

CD PLAYER (2/2)

Manufacturer	Code
GoldStar	0383, 0525
Harman/Kardon	0157, 0173, 0426
Hitachi	0032, 0155
Inkel	0065, 0114, 0180, 0203, 0437
JVC	0072
Kenwood	0028, 0037, 0190, 0626, 0681, 0826
Krell	0157
Kyocera	0018
LXI	0305
Linn	0157
Lotte	0505
Luxman	0266
MCS	0029
MTC	0420
Magnavox	0157, 0305
Marantz	0029, 0157, 0180
Mission	0157
NSM	0157
Nikko	0164, 0170, 0174, 0362, 0525
Onkyo	0101, 0381, 0868
Optimus	0000, 0032, 0037, 0087, 0145, 0179, 0280, 0305, 0342, 0420, 0426, 0437, 0468, 1063
Panasonic	0029, 0303, 0367, 0752
Parasound	0420
Philips	0157, 0626
Pioneer	0032, 0244, 0305, 0468, 0551, 1062, 1063, 1087
Proton	0157
QED	0157
Quasar	0029
RCA	0009, 0053, 0155, 0179, 0305, 0764
Realistic	0155, 0164, 0179, 0180, 0420
Rotel	0157, 0420
SAE	0157
STS	0018
Sansui	0157, 0305
Sanyo	0087, 0179, 0349
Scott	0155, 0164, 0305
Sears	0305
Sharp	0037, 0180, 0261, 0861
Sherwood	0065, 0114, 0180, 0426
Sony	0000, 0185, 0490, 0604, 0605
Soundesign	0145
Tandberg	0203
Tascam	0420
Teac	0174, 0180, 0393, 0420
Technics	0029, 0303
Toshiba	0481
Victor	0072
Wards	0053, 0157
Yamaha	0036, 0170, 0187, 0261
Yorx	0461

CASSETTE DECK

Manufacture	Code
ADC	1171
Aiwa	1029, 1197, 1223
Akai	1189
Anam	1364
Carver	1029, 1261
Denon	1076
Dual	1383
Dynamic Bass	1261
Eroica	1418
Fisher	1261
Garrard	1375
GoldStar	1375
Harman/Kardon	1029, 1182
Inkel	1070, 1337
JVC	1244, 1273
Kenwood	1070
Kyocera	1171
Lotte	1339
Luxman	1266
Magnavox	1029
Marantz	1029
Nakamichi	1218
Nikko	1364
Olympus	1266
Onkyo	1135, 1282
Optimus	1027, 1220, 1337
Panasonic	1229
Philips	1029
Pioneer	1027, 1099, 1101, 1220
RCA	1261
Renaissance	1413
Samsung	1391
Sansui	1029
Sanyo	1261
Sherwood	1337
Sonic	1375
Sony	1170, 1243, 1291
Teac	1391
Technics	1229
Victor	1244, 1273
Wards	1027
Yamaha	1094, 1097

VCR (1/4)

Manufacturer	Code
Admiral	0048, 0209
Adventura	0000
Aiko	0278
Aiwa	0000, 0037
Akai	0041, 0315
America Action	0278
American High	0035
Anam	0037, 0162, 0240, 0278, 0553, 0579
Anam National	0162, 1162
Asha	0240
Audiovox	0037
Beaumarck	0240
Bell & Howell	0104
Broksonic	0002, 0121, 0184, 0209
CCE	0072, 0278
Calix	0037
Canon	0035
Capehart	0020
Carver	0081

VCR (2/4)

Manufacturer	Code
Cineral	0278
Citizen	0037, 0278
Colt	0072
Craig	0037, 0047, 0072, 0240
Curtis Mathes	0035, 0041, 0060, 0162
Cybernex	0240
Daewoo	0020, 0045, 0046, 0278
Daytron	0020
Denon	0042
Dynatech	0000
Electrohome	0037
Electrohome	0037
Emerex	0032
Emerson	0000, 0002, 0037, 0043, 0121, 0184, 0209, 0278
Fisher	0047, 0104
Fuji	0033, 0035
Funai	0000
GE	0035, 0048, 0060, 0240
Garrard	0000
General	0052
Go Video	0432
GoldStar	0037, 0038, 0225, 0480
Gradiente	0000, 0008
HI-Q	0047
Harley Davidson	0000
Harman/Kardon	0038, 0081
Harwood	0072
Headquarter	0046
Hitachi	0000, 0041, 0042, 0235
Hughes Network Systems	0042
JVC	0008, 0041, 0067
Jensen	0041
KEC	0037, 0278
KLH	0072
Kenwood	0038, 0041, 0067
Kodak	0035, 0037
LG	0480
LXI	0037
Lloyd's	0000
Logik	0072
MEI	0035
MGA	0043, 0240
MGN Technology	0240
MTC	0000, 0240
Magnasonic	0278
Magnavox	0000, 0035, 0039, 0081, 0149
Magnin	0240
Marantz	0035, 0081
Marta	0037
Matsushita	0035, 0162
Memorex	0000, 0035, 0037, 0039, 0046, 0047, 0048, 0104, 0209, 0240, 1037, 1162, 1262
Minolta	0042
Mitsubishi	0043, 0048, 0067
Motorola	0035, 0048
Multitech	0000, 0072

VCR (3/4)

Manufacturer	Code
NAD	0058
NEC	0038, 0040, 0041, 0067, 0104
Nikko	0037
Nikon	0034
Noblex	0240
Olympus	0035
Optimus	0037, 0048, 0058, 0104, 0162, 0432, 1048, 1062, 1162, 1262
Orion	0002, 0184, 0209
Panasonic	0035, 0162, 0225, 0616, 1062, 1162, 1262
Penney	0035, 0037, 0038, 0040, 0042, 0240
Pentax	0042
Philco	0035, 0209
Philips	0035, 0081, 0618
Pilot	0037
Pioneer	0058, 0067, 0168
Portland	0020
Profitronic	0240
Proscan	0060, 0072
Protec	0072
Pulsar	0039
Quarter	0046
Quartz	0046
Quasar	0035, 0162, 1162
RCA	0035, 0042, 0048, 0060, 0149, 0240, 0000, 1037
Radio Shack	0000, 1037
Radix	0037
Randex	0037
Realistic	0000, 0035, 0037, 0046, 0047, 0048, 0104
ReplayTV	0614, 0616
Ricoh	0034
Runco	0039
STS	0042
Samsung	0045, 0240, 0426, 0432
Sanky	0039, 0048
Sansui	0000, 0041, 0067, 0209
Sanyo	0046, 0047, 0104, 0240
Scott	0043, 0045, 0121, 0184
Sears	0000, 0035, 0037, 0042, 0046, 0047, 0104
Semp	0045
Sharp	0048, 0363
Shintom	0072
Shogun	0240
Singer	0072
Sony	0000, 0032, 0033, 0034, 0035
Sylvania	0000, 0035, 0043, 0081
Symphonic	0000
TMK	0240
Tatung	0041
Teac	0000, 0041
Technics	0035, 0162

VCR (4/4)

Manufacturer	Code
Teknika	0000, 0035, 0037, 0052
Thomas	0000
Tivo	0618
Toshiba	0043, 0045
Totevision	0037, 0240
Unitech	0240
Vector	0045
Vector Research	0038, 0040
Victor	0008, 0041, 0067
Video Concepts	0040, 0045
Videosonic	0240
Wards	0000, 0035, 0042, 0047, 0048, 0060, 0072, 0081, 0149, 0240
White Westinghouse	0209, 0278
XR-1000	0000, 0035, 0072
Yamaha	0038
Zenith	0000, 0033, 0034, 0039, 0209

MD RECORDER AND CD RECORDER

Manufacturer	Code
Denon	0873
Kenwood	0626, 0681, 0826
Onkyo	0868
Optimus	1063
Philips	0626
Pioneer	1062, 1063, 1087(CD-R)
Sharp	0861
Sony	0490

Troubleshooting

Incorrect operation is often mistaken for trouble or malfunction. If you think that there is something wrong with this component, check the points below. Sometimes the trouble may lie in another component. Inspect the other components and electrical appliances being used. If the trouble cannot be rectified after checking the items below, ask your nearest Pioneer authorized service center or your dealer to carry out repair work.

The disc is ejected automatically after loading.

- Dirty or damaged disc.
See page 57 for disc care information.
- Disc not seated properly in the disc guide.
Align the disc properly.
- Incompatible region number.
If the region number on a DVD-video disc does not match the number on the DVD tuner, the disc cannot be used (page 6).
- Condensation inside the unit.
Allow time for condensation to evaporate. Avoid using the player near an air-conditioning unit.

Playback is not possible.

- Disc is loaded upside down.
Reload the disc with the label side face up.
- In the case of CD-R and CD-RW discs, make sure that the recording has been finalized following the procedures in the manual supplied with the recording component.



mark appears on screen.

- The operation is prohibited by the system.



mark appears on screen.

- The selected function does not operate for that disc.

When making changes in the Setup OSD menus, is displayed.

- There is a CD or Video CD loaded and the setting that was changed applies only to DVD discs.
The settings will take effect next time a DVD is loaded.

Picture playback stops and the operation buttons cannot be used.

Press **■**, then start playback again (**▶**). Switch the power off once, then on again using the front panel **STANDBY/ON** switch.

New settings made in the Setup screen menus while a disc is playing are ineffective.

- Some settings can be changed while a disc is playing, but are not effective until the disc is stopped then restarted. This is not a malfunction.
Make the same setting when the disc is stopped.
Press **■**, then restart playback (**▶**). Note that making settings in the Setup screen menus may cancel the **RESUME** function.

Settings are canceled.

- When the power is cut due to power failure or by unplugging the power cord, settings will be canceled.

No picture/No color.

- Incorrect video connections.
Check that connections are correct and that plugs are inserted fully.
- TV/monitor settings are incorrect.
Check the instruction manual of the TV/monitor.

Screen is stretched or aspect does not change.

- The **TV Screen** setting in the Setup menu is incorrect.
Set the **TV Screen** option to match the TV/monitor you're using (page 35).

Picture disturbance during playback or dark.

- This player is compatible with Macro-Vision System copy guard. Some discs include a copy prevention signal, and when this type of disc is played back, stripes etc., may appear on some sections of the picture depending on the TV.

This is not a malfunction.

- Different discs respond in different ways to some functions. This may result in the screen becoming black for a brief instant or shaking slightly when the function is executed.

These problems are largely due to differences between discs and disc content and are not malfunctions of this system.

When recorded on a VCR or passed through an AV selector, there is disturbance in the playback picture.

- Due to copy protection, connection of this system through a VCR or an AV selector may prevent recording or cause picture problems.

This is not a malfunction.

The remote control doesn't seem to work.

- The remote control is too far from the system, or the angle with the remote sensor is too wide.

Use the remote within its operating range (See the separate *Setting Up* guide).

- The batteries are exhausted.

Put in new batteries (See the separate *Setting Up* guide).

No 96kHz signal from the digital audio output

- **Linear PCM Out** is set to **96kHz▶48kHz**.

Set to **96kHz**.

- As a copy-protection measure, some DVDs do not output 96 kHz audio.

In this case, even if **96kHz** is selected, the player automatically outputs the audio at 48 kHz. This is not a malfunction.

No audio, or audio is distorted.

- Dirt, dust, etc. on the disc.
Clean the disc (page 57).
- Interconnects are not fully inserted into the terminals (or are not connected).
Check that all interconnects are firmly inserted.
- Dirty or oxidized plugs/terminals.
Clean the plugs/terminals.
- Incorrect audio cable connection.
Check the audio connections (See the separate *Setting Up* guide).
- The disc is paused.
Press ▶ or II to exit the pause mode.
- Incorrect settings.
Check that the volume is turned up, that the speakers are on, the input function set correctly, etc.
- Mute is on.
Press mute (remote control only) to switch mute off.

Noticeable difference in DVD and CD volume.

- DVDs and CDs use different recording methods.
This is not a malfunction.

Noisy radio reception

- Antennas are not connected properly.
Check the connections. For FM, make sure that the antenna is fully extended and positioned to give the best reception (See the separate *Setting Up* guide).
For AM, make sure that the loop antenna is pointing in the best direction (See the separate *Setting Up* guide).
- The frequency is incorrect.
Check the radio frequency.
- The radio signal is weak.
If the radio signal is weak, an outdoor antenna will usually give better results than the supplied indoor types.
- Other electrical equipment is causing interference.
Other electrical equipment, such as TVs, fluorescent lamps and motors can cause interference. Try switching off or moving the equipment, or moving the antenna(s).

Auto tuning does not pick up some stations.

- The radio signal is weak.
Auto tuning will only detect radio stations with a good signal. For more sensitive tuning, connect an outdoor antenna.

Note: Static electricity or other external influences may cause malfunctioning of this unit. In this case, unplug the power cord and then plug back in. This will usually reset the unit for proper operation. If this does not correct the problem, please consult your nearest Pioneer service center.

Resetting the system

Resetting the system returns all menu, picture and password settings to their factory defaults.

Switch the system into standby using the front panel **STANDBY/ON** switch. Next, hold down the front panel **■** button and switch back on. All settings will have been cleared.

Screen sizes and disc formats

The table below shows the effect of various TV Screen settings on the different kinds of disc available.

When viewing a wide screen TV or monitor

Setting and Appearance Screen format of disc



16:9 (Wide)

Widescreen (movies, etc.)

Note that some extra-wide formats (such as CinemaScope) will appear with black bars at the top and bottom of the screen.



16:9 (Wide)

Standard (TV programs, etc.)

Your TV will determine how the picture is presented—check the manual that came with the TV for details. Typical options are black bars either side, some form of stretched or zoomed presentation.

When viewing a standard size TV or monitor

Setting and Appearance Screen format of disc



Any setting

Standard (TV programs, etc.)

The program is presented correctly, regardless of the setting.



4:3 (Letter Box)

Widescreen (movies, etc.)

The program is shown in widescreen with black bars at the top and bottom of the screen.



4:3 (Pan & Scan)

Widescreen (movies, etc.)

The sides of the program are cropped so that the picture fills the whole screen.



16:9 (Wide)

Widescreen (movies, etc.)

The program appears squashed: set to either 4:3 (**Letter Box**) or 4:3 (**Pan & Scan**).

Component features & functions

DVD Tuner System

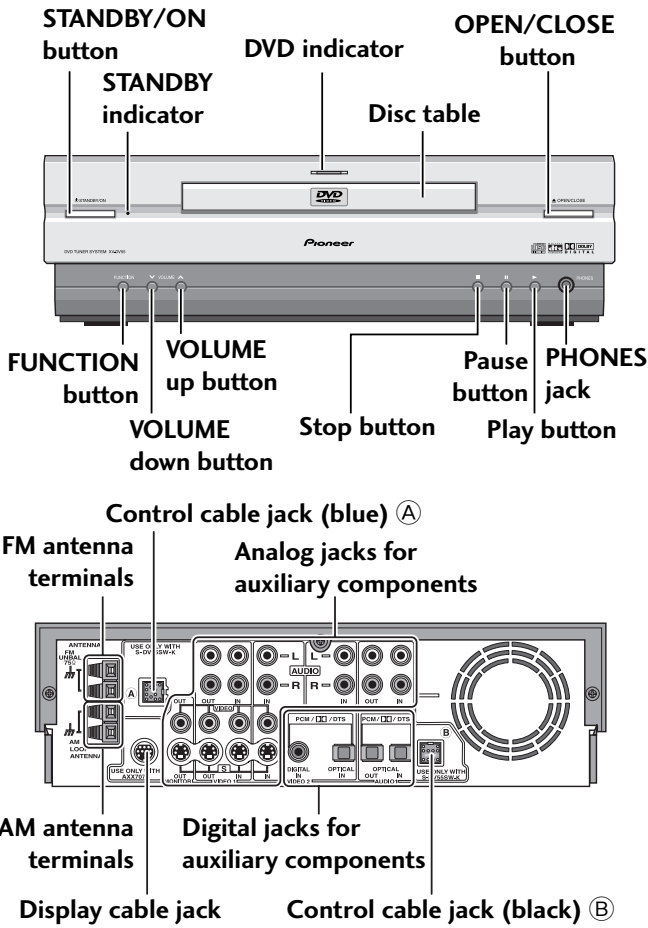

Powered Subwoofer Unit

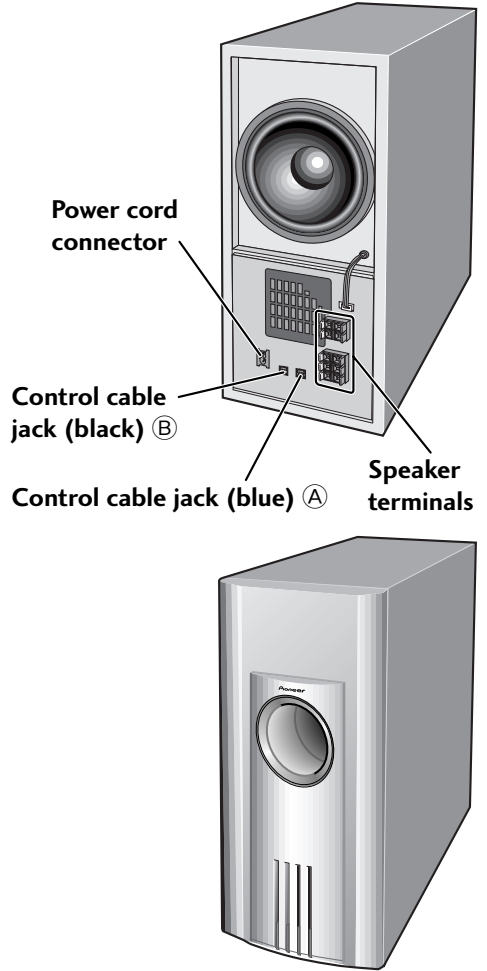

Display Unit

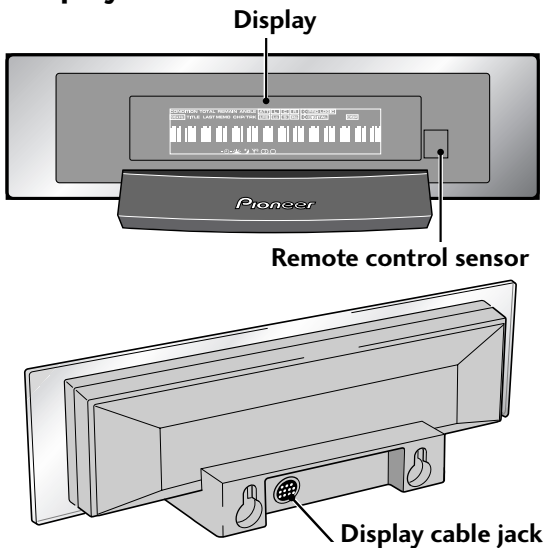

Specifications

Amplifier Section

Continuous power output (RMS)	
Front, Center, Rear	40W, per channel (1 kHz, 10% T.H.D., 8 Ω)
Subwoofer	65W (100Hz 10% T.H.D., 8 Ω)

Speakers Section

Front, Rear, Center speakers

Type	Sealed, antimagnetic (EIA)*
Speaker	8.7cm (3-7/16 in.) (cone type)
Nominal impedance	8 Ω
Frequency range	100 to 20,000 Hz
Max. input	40 W (EIA)

Powered subwoofer

Type	Bass reflex floor type, antimagnetic (EIA)*
Speaker	16 cm (6 in.) (cone type)
Nominal impedance	8 Ω
Frequency range	25 Hz to 300 Hz
Max. input	65 W (EIA)

* Antimagnetic design (EIA) speaker system conforms to the basic EIA standards.

DVD Player (Audio)Section

S/N ratio	115 dB (EIA)
Dynamic range	100 dB (EIA)
Distortion	0.004%
Frequency response	
48 kHz sampling	4 Hz to 22 kHz
96 kHz sampling	4 Hz to 44 kHz
Wow & flutter	Below measurable levels (±0.001% W.PEAK)

DVD Player (Video) Section

Output level	1 Vp-p (75 Ω)
Video Y output level	1 Vp-p (75 Ω)
Video C output level	286 mVp-p (75 Ω)

DVD (Other jacks) Section

Digital optical output (PCM/DQ/DTS) ...	Optical connector
Digital optical input (PCM/DQ/DTS)	Optical connector
Digital coaxial input (PCM/DQ/DTS)	Coaxial connector

Tuner Section

FM tuner	
Frequency range	87.5 MHz to 108.0 MHz
Antenna	75 Ω unbalanced
AM tuner	
Frequency range	531 kHz to 1,602 kHz (9 kHz step)
Antenna	loop antenna (supplied)

Power Supply Section

Power requirements	
Australian model	AC 240 V, 50/60 Hz
Multi voltage model	AC 110-127/220-230/240 V (Switchable), 50/60 Hz
Power consumption	
Australian model	160 W
Multi voltage model	418 W
Power consumption in standby mode	1 W

Miscellaneous

DVD tuner system	
Dimensions	280 (W) x 240 (D) x 82 (H) mm (11 (W) x 9-7/16 (D) x 3-1/4 (H) in.)
Weight	3.1 kg (6.8 lbs)
Powered subwoofer unit	
Dimensions	190 (W) x 425 (D) x 430 (H) mm (7-1/2 (W) x 16-3/4 (D) x 17 (H) in.)
Weight	13.8 kg (30.15 lbs)
Front, Rear speakers	
Dimensions	110 (W) x 75 (D) x 154 (H) mm (4-5/16 (W) x 2-15/16 (D) x 6 (H) in.)
Weight	0.76 kg (1.7 lbs)
Center speaker	
Dimensions	210 (W) x 75 (D) x 110 (H) mm (8-1/2 (W) x 2-15/16 (D) x 4-5/16 (H) in.)
Weight	0.83 kg (1.8 lbs)
Display unit	
Dimensions	210 (W) x 62 (D) x 86 (H) mm (8-1/2 (W) x 2-7/16 (D) x 3-3/8 (H) in.)
Weight	0.23 kg (.51 lb)

Operating conditions:

Temperature	+5°C to +35°C (+41°F to 95°F)
Humidity	5% to 85% (without condensation)

Supplied Items

Remote control	1
Alkaline Batteries (AA/LR6)	2
Display unit	1
AM loop antenna	1
FM antenna	1
Video cable	1
Power cord	1
Display cable	1
Control cable [Ⓐ] (Blue)	1
Control cable [Ⓑ] (Black)	1
Speaker cords (5 m/16 ft. 3 in.)	3
Speaker cords (10 m/32 ft. 6 in.)	2
Cord labels	1
Non-skid pads	1
Operating instructions (Setting up)	1
Operating instructions (Basic/Detailed)	1
Warranty	1

Note: Specifications and design subject to possible modification without notice, due improvements.

Published by Pioneer Corporation.
Copyright © 2000 Pioneer Corporation.
All rights reserved.

PIONEER CORPORATION

4-1, Meguro 1-Chome, Meguro-ku, Tokyo 153-8654, Japan

PIONEER ELECTRONICS [USA] INC.

P.O. BOX 1540, Long Beach, California 90801-1540, U.S.A.

PIONEER ELECTRONICS OF CANADA, INC.

300 Allstate Parkway, Markham, Ontario L3R 0P2, Canada

PIONEER EUROPE NV

Haven 1087, Keetberglaan 1, B-9120 Melsele, Belgium TEL: 03/570.05.11

PIONEER ELECTRONICS AUSTRALIA PTY. LTD.

178-184 Boundary Road, Braeside, Victoria 3195, Australia, TEL: [03] 9586-6300

PIONEER ELECTRONICS DE MEXICO S.A. DE C.V.

San Lorenzo 1009 3er Piso Desp. 302 Col. Del Valle Mexico D.F. C.P. 03100
TEL: 5-688-52-90

Free Manuals Download Website

<http://myh66.com>

<http://usermanuals.us>

<http://www.somanuals.com>

<http://www.4manuals.cc>

<http://www.manual-lib.com>

<http://www.404manual.com>

<http://www.luxmanual.com>

<http://aubethermostatmanual.com>

Golf course search by state

<http://golfingnear.com>

Email search by domain

<http://emailbydomain.com>

Auto manuals search

<http://auto.somanuals.com>

TV manuals search

<http://tv.somanuals.com>