

Pioneer

ELITE

**AUDIO/VIDEO
MULTI-CHANNEL RECEIVER**

VSX-27TX

VSX-26TX

VSX-24TX

Operating Instructions

Congratulations on buying this fine Pioneer product. Please read through these operating instructions so you will know how to operate your model properly. After you have finished reading the instructions, put them away in a safe place for future reference.

[For Canadian model]

CAUTION: TO PREVENT ELECTRIC SHOCK DO NOT USE THIS (POLARIZED) PLUG WITH AN EXTENSION CORD, RECEPTACLE OR OTHER OUTLET UNLESS THE BLADES CAN BE FULLY INSERTED TO PREVENT BLADE EXPOSURE.

ATTENTION: POUR PREVENIR LES CHOCS ELECTRIQUES NE PAS UTILISER CETTE FICHE POLARISEE AVEC UN PROLONGATEUR, UNE PRISE DE COURANT OU UNE AUTRE SORTIE DE COURANT, SAUF SI LES LAMES PEUVENT ETRE INSEREES A FOND SANS EN LAISSER AUCUNE PARTIE A DECOUVERT.

IMPORTANT NOTICE

The serial number for this equipment is located on the rear panel. Please write this serial number on your enclosed warranty card and keep it in a secure area. This is for your security.

WARNING: TO PREVENT FIRE OR SHOCK HAZARD, DO NOT EXPOSE THIS APPLIANCE TO RAIN OR MOISTURE.

THE POWER SWITCH IS SECONDARY CONNECTED AND THEREFORE DOES NOT SEPARATE THE UNIT FROM MAINS POWER IN THE STANDBY POSITION.

This Class B digital apparatus meets all requirements of the Canadian Interference-Causing Equipment Regulations.

IMPORTANT



The lightning flash with arrowhead symbol, within an equilateral triangle, is intended to alert the user to the presence of uninsulated "dangerous voltage" within the product's enclosure that may be of sufficient magnitude to constitute a risk of electric shock to persons.

CAUTION

RISK OF ELECTRIC SHOCK
DO NOT OPEN

CAUTION:
TO PREVENT THE RISK OF ELECTRIC SHOCK, DO NOT REMOVE COVER (OR BACK). NO USER-SERVICEABLE PARTS INSIDE. REFER SERVICING TO QUALIFIED SERVICE PERSONNEL.



The exclamation point within an equilateral triangle is intended to alert the user to the presence of important operating and maintenance (servicing) instructions in the literature accompanying the appliance.

This equipment has been tested and found to comply with the limits for a Class B digital device, pursuant to Part 15 of the FCC Rules. These limits are designed to provide reasonable protection against harmful interference in a residential installation. This equipment generates, uses, and can radiate radio frequency energy and, if not installed and used in accordance with the instructions, may cause harmful interference to radio communications. However, there is no guarantee that interference will not occur in a particular installation. If this equipment does cause harmful interference to radio or television reception, which can be determined by turning the equipment off and on, the user is encouraged to try to correct the interference by one or more of the following measures:

- Reorient or relocate the receiving antenna.
- Increase the separation between the equipment and receiver.
- Connect the equipment into an outlet on a circuit different from that to which the receiver is connected.
- Consult the dealer or an experienced radio/TV technician for help.

ATTENTION: AFIN DE PREVENIR TOUS RISQUES DE CHOC ELECTRIQUE OU DE DEBUT D'ENCENDIE, NE PAS EXPOSER CET APPAREIL A L'HUMIDITE OU A LA PLUIE.

L'INTERRUPTEUR EST CONNECTÉ AU SECONDAIRE, ET NE SÉPARE PAS L'APPAREIL DE LA SOURCE DE COURANT PRINCIPAL EN MODE DE MISE EN ATTENTE.

Cet appareil numérique de la Classe B respecte toutes les exigences du Règlement sur le matériel brouilleur du Canada.

IMPORTANT SAFETY INSTRUCTIONS

READ INSTRUCTIONS — All the safety and operating instructions should be read before the product is operated.

RETAIN INSTRUCTIONS — The safety and operating instructions should be retained for future reference.

HEED WARNINGS — All warnings on the product and in the operating instructions should be adhered to.

FOLLOW INSTRUCTIONS — All operating and use instructions should be followed.

CLEANING — Unplug this product from the wall outlet before cleaning. The product should be cleaned only with a polishing cloth or a soft dry cloth. Never clean with furniture wax, benzine, insecticides or other volatile liquids since they may corrode the cabinet.

ATTACHMENTS — Do not use attachments not recommended by the product manufacturer as they may cause hazards.

WATER AND MOISTURE — Do not use this product near water — for example, near a bathtub, wash bowl, kitchen sink, or laundry tub; in a wet basement; or near a swimming pool; and the like.

ACCESSORIES — Do not place this product on an unstable cart, stand, tripod, bracket, or table. The product may fall, causing serious injury to a child or adult, and serious damage to the product. Use only with a cart, stand, tripod, bracket, or table recommended by the manufacturer, or sold with the product. Any mounting of the product should follow the manufacturer's instructions, and should use a mounting accessory recommended by the manufacturer.

CART — A product and cart combination should be moved with care. Quick stops, excessive force, and uneven surfaces may cause the product and cart combination to overturn.



VENTILATION — Slots and openings in the cabinet are provided for ventilation and to ensure reliable operation of the product and to protect it from overheating, and these openings must not be blocked or covered. The openings should never be blocked by placing the product on a bed, sofa, rug, or other similar surface. This product should not be placed in a built-in installation such as a bookcase or rack unless proper ventilation is provided or the manufacturer's instructions have been adhered to.

POWER SOURCES — This product should be operated only from the type of power source indicated on the marking label. If you are not sure of the type of power supply to your home, consult your product dealer or local power company.

LOCATION — The appliance should be installed in a stable location.

NONUSE PERIODS — The power cord of the appliance should be unplugged from the outlet when left unused for a long period of time.

GROUNDING OR POLARIZATION

- If this product is equipped with a polarized alternating current line plug (a plug having one blade wider than the other), it will fit into the outlet only one way. This is a safety feature. If you are unable to insert the plug fully into the outlet, try reversing the plug. If the plug should still fail to fit, contact your electrician to replace your obsolete outlet. Do not defeat the safety purpose of the polarized plug.
- If this product is equipped with a three-wire grounding type plug, a plug having a third (grounding) pin, it will only fit into a grounding type power outlet. This is a safety feature. If you are unable to insert the plug into the outlet, contact your electrician to replace your obsolete outlet. Do not defeat the safety purpose of the grounding type plug.

POWER-CORD PROTECTION — Power-supply cords should be routed so that they are not likely to be walked on or pinched by items placed upon or against them, paying particular attention to cords at plugs, convenience receptacles, and the point where they exit from the product.

OUTDOOR ANTENNA GROUNDING — If an outside antenna or cable system is connected to the product, be sure the antenna or cable system is grounded so as to provide some protection against voltage surges and built-up static charges. Article 810 of the National Electrical Code, ANSI/NFPA 70, provides information with regard to proper grounding of the mast and supporting structure, grounding of the lead-in wire to an antenna discharge unit, size of grounding conductors, location of antenna-discharge unit, connection to grounding electrodes, and requirements for the grounding electrode. See Figure A.

LIGHTNING — For added protection for this product during a lightning storm, or when it is left unattended and unused for long periods of time, unplug it from the wall outlet and disconnect the antenna or cable system. This will prevent damage to the product due to lightning and power-line surges.

POWER LINES — An outside antenna system should not be located in the vicinity of overhead power lines or other electric light or power circuits, or where it can fall into such power lines or circuits. When installing an outside antenna system, extreme care should be taken to keep from touching such power lines or circuits as contact with them might be fatal.

OVERLOADING — Do not overload wall outlets, extension cords, or integral convenience receptacles as this can result in a risk of fire or electric shock.

OBJECT AND LIQUID ENTRY — Never push objects of any kind into this product through openings as they may touch dangerous voltage points or short-out parts that could result in a fire or electric shock. Never spill liquid of any kind on the product.

SERVICING — Do not attempt to service this product yourself as opening or removing covers may expose you to dangerous voltage or other hazards. Refer all servicing to qualified service personnel.

DAMAGE REQUIRING SERVICE — Unplug this product from the wall outlet and refer servicing to qualified service personnel under the following conditions:

- If the power-supply cord or plug is damaged.
- If liquid has been spilled, or objects have fallen into the product.
- If the product has been exposed to rain or water.
- If the product does not operate normally by following the operating instructions. Adjust only those controls that are covered by the operating instructions as an improper adjustment of other controls may result in damage and will often require extensive work by a qualified technician to restore the product to its normal operation.
- If the product has been dropped or damaged in any way.
- When the product exhibits a distinct change in performance — this indicates a need for service.

REPLACEMENT PARTS — When replacement parts are required, be sure the service technician has used replacement parts specified by the manufacturer or have the same characteristics as the original part. Unauthorized substitutions may result in fire, electric shock, or other hazards.

SAFETY CHECK — Upon completion of any service or repairs to this product, ask the service technician to perform safety checks to determine that the product is in proper operating condition.

WALL OR CEILING MOUNTING — The product should not be mounted to a wall or ceiling.

HEAT — The product should be situated away from heat sources such as radiators, heat registers, stoves, or other products (including amplifiers) that produce heat.

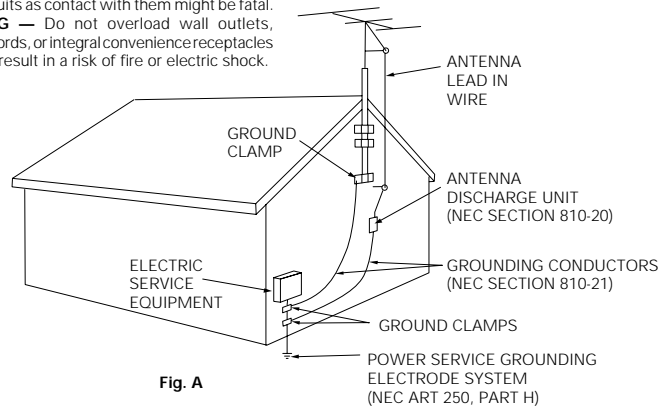

Fig. A

NEC — NATIONAL ELECTRICAL CODE

Information to User

Alteration or modifications carried out without appropriate authorization may invalidate the user's right to operate the equipment.

Features

Decoding of Dolby Digital, Dolby Pro Logic and DTS (Digital Theater Systems)



DTS is the latest and most widely used digital theater system for cinemas throughout the world. The decoder has been incorporated into this receiver and is able to achieve high sound quality as well as produce dynamic surround sound effects. Also, there's no need to worry about program formats. When playing Dolby Digital, Dolby Pro Logic or Dolby Surround software in the  (Dolby) Surround and HOME THX CINEMA modes, decoding switches on automatically according to the input signal, all you have to do is enjoy!

*"DTS" and "DTS Digital Surround" are trademarks of Digital Theater Systems, Inc.
Manufactured under licence from Digital Theater Systems, Inc.*

Manufactured under license from Dolby Laboratories. "Dolby", "AC-3", "Pro Logic", and double-D symbol are trademarks of Dolby Laboratories. Confidential Unpublished Works. © 1992 - 1997 Dolby Laboratories, Inc. All rights reserved.

Direct Energy MOS amplifier

The VSX-27TX receiver incorporates 5 independent 120 watt built in power amplifiers, the VSX-26TX 100 watt built in power amplifiers and the VSX-24TX 90 watt built in power amplifiers, all with high-performance Hex power MOS FET output transistors. This construction provides improved linearity and accurate reproduction of each channel for true high fidelity reproduction from even the most demanding Dolby Digital and DTS program sources.

True Home Cinema with THX® Certification

The HOME THX CINEMA surround mode employs special processing to allow you to enjoy movie soundtracks with the same level of power and realism you experience in well designed movie theaters. You can enjoy this effect with both Dolby Digital, Dolby Surround and DTS sources.

Manufactured under license from Lucasfilm Ltd. Lucasfilm and THX are trademarks of Lucasfilm Ltd.

Advanced Theater Modes

This mode enhances the sound of either film or music so a more dramatic effect can be achieved. The four modes are each designed to accentuate specific sound qualities, giving the listener a wide range of possibilities.

DSP Surround Modes

DSP (Digital Signal Processing) surround mode gives you the capability of transforming your living room into six different sonic environments when listening to music.

Midnight Listening Mode

Midnight mode allows you to obtain excellent surround sound effects even when listening at low volumes, something that was previously impossible.

Digital Noise Reduction

Digital Noise reduction is the latest technology for filtering out unwanted noise. It produces clear, resonant tones.

Illuminated Remote Control of Other Components

The supplied remote control can be used to operate a variety of other components simply by recalling the appropriate preset codes or by using the learning function to teach the remote control new commands. In addition, the multi-operation functions allow you to perform a variety of operations automatically.

The Energy-saving Design

This unit is designed to use minimal electricity when power is switched OFF (in Standby mode). Regarding the value of the power consumption in standby mode, refer to "Specifications" on page 78.

Before You Start	6
Checking the Supplied Accessories	6
How to Use This Manual	6
Preparing the Remote Control	6
Installing the Receiver	7
Opening the Front Panel	7
Connecting Your Equipment	8
Audio Components	8
Video Components	9
Digital Connections	10
External Decoder Input	12
Antennas	13
Speakers	14
Connecting Additional Amplifiers	16
Power Connections (AC OUTLETS)	16
Displays & Controls	17
Display	17
Front Panel (VSX-27TX/26TX)	18
Front Panel (VSX-24TX)	20
Remote Control	22
Surround Sound Set Up	24
On Screen Display	24
Setting Up for Surround Sound	24
Basic Playback	35
Playing Source with Stereo Sound	35
Sound Modes	36
Selecting a Sound Mode	38
Playing Source with Dolby Digital or DTS Sound	39
Switching ANALOG/DIGITAL Signal Input	40
Reducing Noise During Playback (DIGITAL NR Function)	41
Listening in MIDNIGHT LISTENING Mode	41
External Decoder Input Playback	42
96kHz 24Bit Performance	42
Listening in LOUDNESS Mode	42
Adjusting Bass and Treble (Tone Control)	43
Direct Playback	43
Adjusting the Brightness of the Display	43
Using the Tuner	44
Automatic and Manual Tuning	44
Direct Access Tuning	45
Memorizing Frequently Used Stations	46
Recalling Memorized Stations	47
Remote Control of Other Components	48
Setting Up the Remote to Control Other Components	48
Recalling Preset Codes	48
Learning Mode : Programming Signals from Other Remote Controls ...	50
Using Remote Control with Other Components	52
Using Other Functions	60
Recording from Audio Components	60
Recording from Digital Audio Components	61
Recording from Video Components	62
Multi Operations	63
Resetting the Remote Control	66
Multi-Room	67
Techno Tidbits & Problem-solving	72
Dolby Digital	72
DTS	73
THX	74
Preset Code List	75
Troubleshooting	76
Specifications	78

Before You Start

Checking the Supplied Accessories

Please check that you have received all of the following supplied accessories.



FM wire antenna

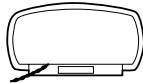

AM loop antenna

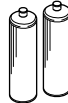

"AA" IEC LR6 batteries x 2

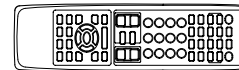

Remote control unit

How to Use This Manual

This manual is for the VSX-27TX/26TX/24TX Audio/Video Multi-Channel Receiver.

This manual is divided into three main sections which will tell you how to setup and use the unit :

PREPARATION

First carry out the tasks below in this "Before You Start" section to prepare the remote control, then connect the receiver to your other components as described in "Connecting Your Equipment" (p.8). Take special care to connect your digital equipment like DVDs and LDs properly to be able to take advantage of the receiver's surround sound systems (p.10-11). To learn about a specific button, control, or indicator, see "Displays & Controls" starting on p.17.

SET UP

Performing the tasks in "Surround Sound Set Up" (from p.24) is essential to get proper surround sound.

OPERATION

To play some music or soundtrack refer to "Basic Playback" on p.35. "Using the Tuner" (p.44) explains how to use the radio of this unit. Doing the operations in "Remote Control of Other Components" (p.48) is highly recommended so you can use this unit's remote control for all your components. "Using Other Functions" (p.60) explain the other possibilities of the receiver. "Techno Tidbits & Problem-solving" (p.72) provide detailed technical information and a troubleshooting guide.

The following marks and symbols are used throughout the manual:



Provides additional information, precautions, and advice.



Indicates a blinking button, indicator, or display.



Indicates a steadily lit button, indicator, or display.

Preparing the Remote Control

Loading the batteries

Load the batteries into the remote control as shown below. Please use alkaline batteries.

1

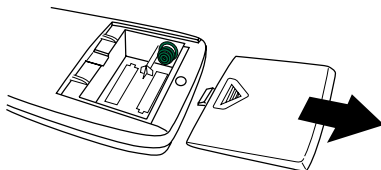

2

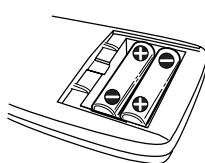

3

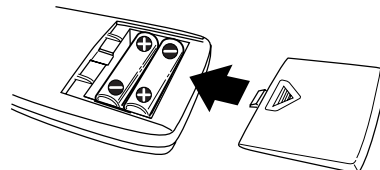

When you notice a decrease in the operating range of the remote control, replace all batteries with new ones.

CAUTION!

Incorrect use of batteries may result in such hazards as leakage and bursting. Observe the following precautions.

- Never use new and old batteries together.
- Insert the plus and minus sides of the batteries properly according to the marks in the battery case.
- Batteries with the same shape may have different voltages. Do not use different batteries together.

Operating range of remote control unit

The area in which you can use the remote control to operate the VSX-27TX/26TX/24TX is fairly large. To use, point the remote control toward the remote sensor on the front panel of this unit while within the range shown below.

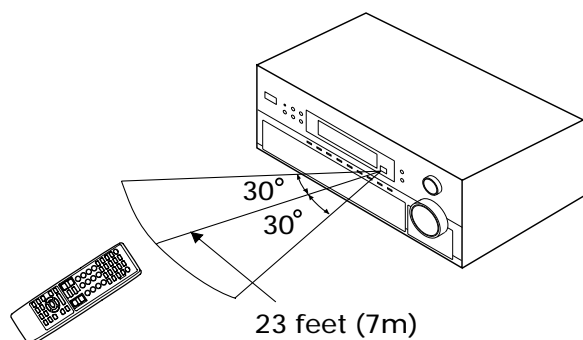

Remote control may not function properly if :

- There are obstacles between the remote control and the remote sensor.
- Direct sunlight or fluorescent light is shining onto the remote sensor.
- The receiver located near a device emitting infrared rays.
- Operated simultaneously with another remote control which uses infrared rays.

Installing the Receiver

Please note:

- Do not place objects directly on top of this unit. This would prevent proper heat dispersal.
- When installing in a rack, shelf, etc., be sure to leave more than 8 inches of space above the receiver.

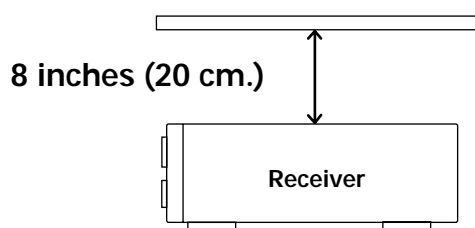

Opening the Front Panel

To open the front panel push gently on the lower third of the panel with your finger.

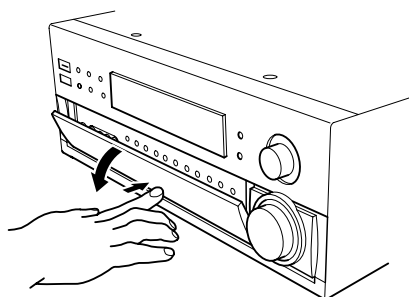

Connecting Your Equipment

Audio Components

To begin set up connect your audio components to the jacks as shown below. These are all analog connections and your analog audio components (turntable, cassette deck) use these jacks. Remember that for components you want to record with you need to hook up four plugs (a set of stereo ins and a set of stereo outs), but for components that only play (like a turntable) you only need to hook up one set of stereo plugs (two plugs). To use DTS surround sound features you must hook up your digital components to the digital inputs but it is also a good idea to hook up your digital components to analog audio jacks. If you want to record to/from digital components (like an MD) to/from analog components you must hook up your digital equipment with these analog connections. See p.10,11 for more on digital connections.

When connecting your equipment always make sure the power is turned off and the power cord is disconnected from the wall outlet.

NOTE :

- Only the VSX-27TX has a RF IN jack.
- The arrows indicate the direction of the audio signal.

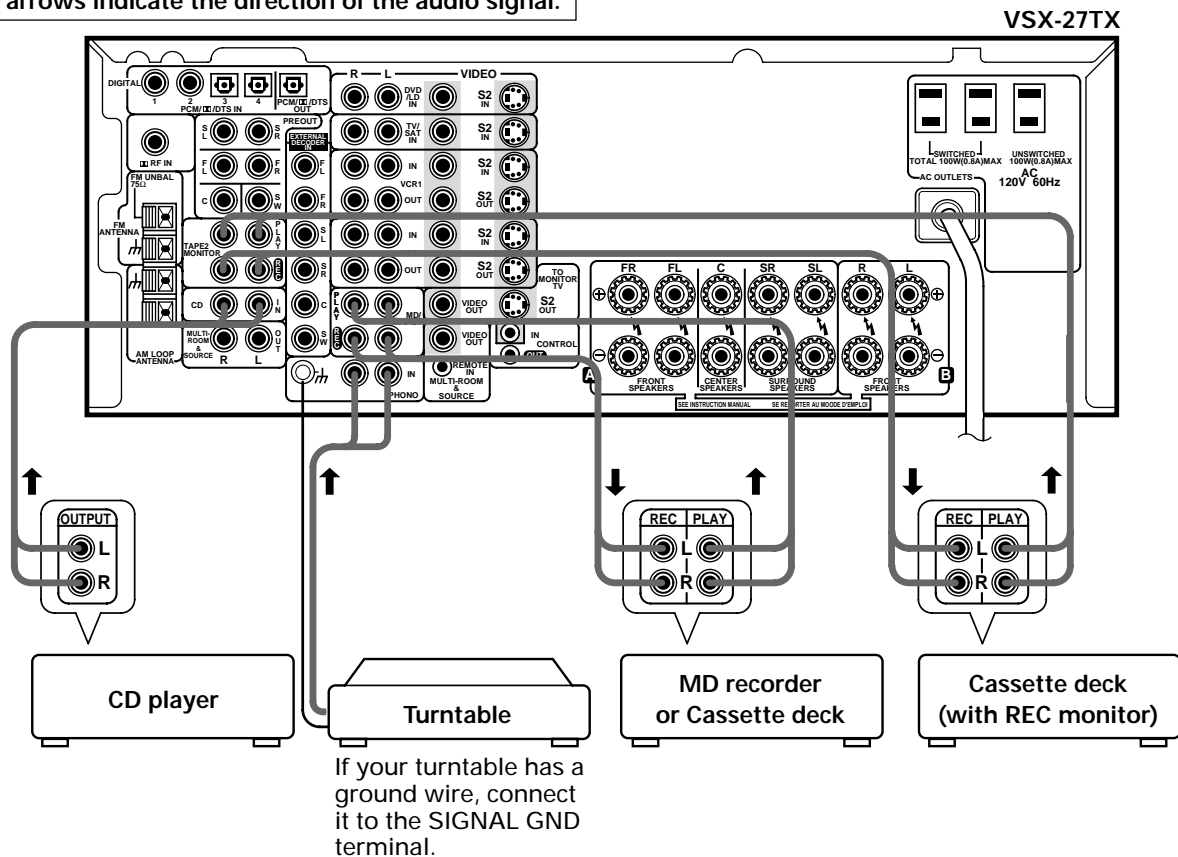

■ Audio cords

Use audio cords (not supplied) to connect the audio components.

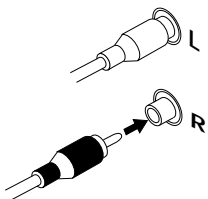

Connect red plugs to R (right) and white plugs to L (left). Be sure to insert completely.

Cassette deck placement

Depending on where the cassette deck is placed, noise may occur during playback of your cassette deck which is caused by leakage flux from the transformer in the receiver. If you experience noise, move the cassette deck farther away from the receiver.

Video Components

Connect your video components to the jacks as shown below. Regarding digital video components (like a DVD), you must use the analog connections pictured on this page for the video signal but in order to use Dolby Digital you should hook up their audio to a digital input (see the next page). It is also a good idea to hook up your digital components with analog audio connections as well (see the previous page). To cover all possible laser discs a DVD/LD player or LD player requires an analog connection (as shown here) and two digital connections (see the next page). When connecting your equipment always make sure the power is turned off and the power cord is disconnected from the wall outlet.

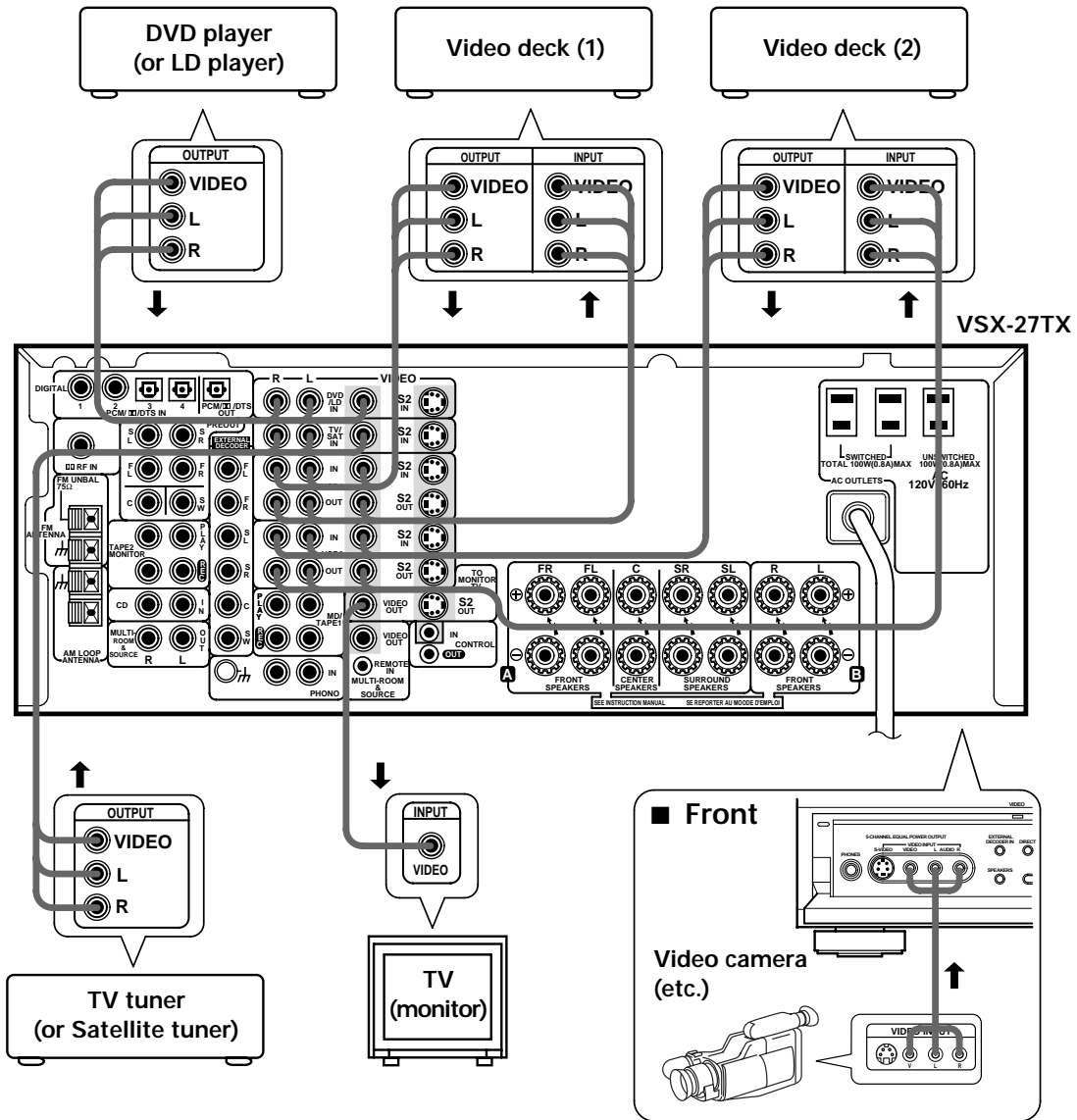

■ Audio/Video cords

Use audio/video cords (not supplied) to connect the video components and a video cord to connect the monitor TV.

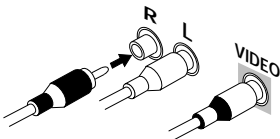

Connect red plugs to R (right), white plugs to L (left), and the yellow plugs to VIDEO.

Be sure to insert completely.

Front video connections are accessed via the front panel input selector as "VIDEO."



If your video components have S-video jacks, you could use S-video cords (not supplied) to connect them on the back of the receiver. These jacks are labeled by the Japanese designation "S2" on the VSX-27TX/26TX/24TX but they are simply S-video jacks.

However, if you use S-video cords for your video hook ups you must also hook up your TV with S-video connections. Conversely, if you use regular composite video cords for video hook ups, you should use them for your TV as well.

Digital Connections

In order to use Dolby Digital/DTS soundtracks you need to make digital audio connections. You can do this by either coaxial or optical connections (you don't need to do both). The quality of these two types of connections is the same but since some digital components only have one type of digital terminal, it is a matter of matching like with like (for example, the coaxial out from the component to coaxial in on the receiver). The VSX-27TX/26TX/24TX has two coaxial and two optical inputs for a total of four digital inputs. For the VSX-27TX, a DVD/LD player or LD player should be connected to a digital jack and the special AC-3 RF jack (if the LD has one) as well as a pair of analog jacks (see the previous page). Connect your digital components as shown below. There is one digital out jack which is marked PCM/DTS OUT. If you connect this to the optical input on a digital recorder (currently these include MD, DAT, and CD-R) you can make direct digital recordings with this unit.

When connecting your equipment always make sure the power is turned off and the power cord is disconnected from the wall outlet.

NOTE :

- Only the VSX-27TX has a RF IN jack.

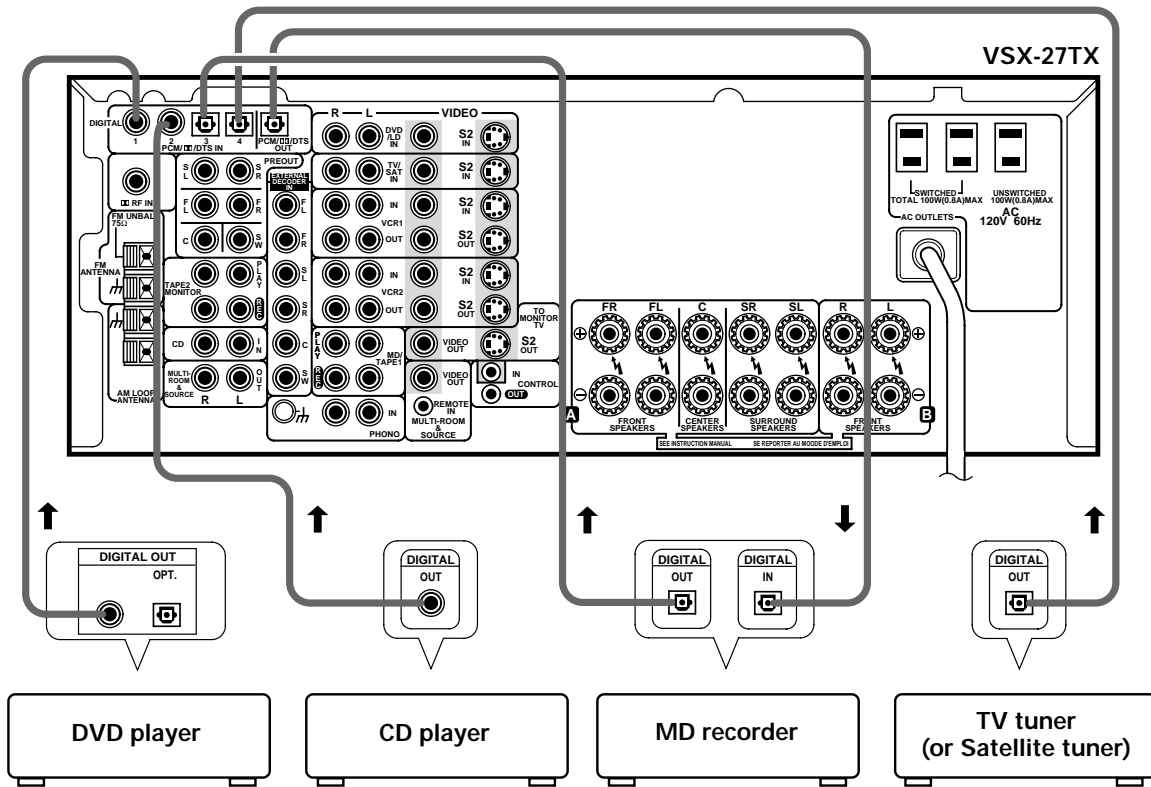

■ Digital audio cords/Optical cables

Commercially available digital audio coaxial cords (standard video cords can also be used) or optical cables (not supplied) are used to connect digital components to this receiver.

When you use optical digital input or output terminals, pull off the caps and insert the plugs. Be sure to insert completely.

**Digital audio cord
(or standard video cord)**

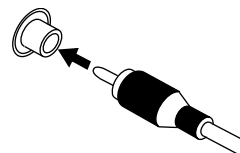

Optical cable

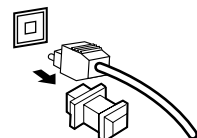

Example Connection for a DVD/LD or LD player

VSX-27TX model :

Make sure you connect your DVD/LD or LD players using both the AC-3 RF jack and a coaxial or optical connection. If your player has an AC-3 RF output this will ensure you can use all LDs. See p. 34.

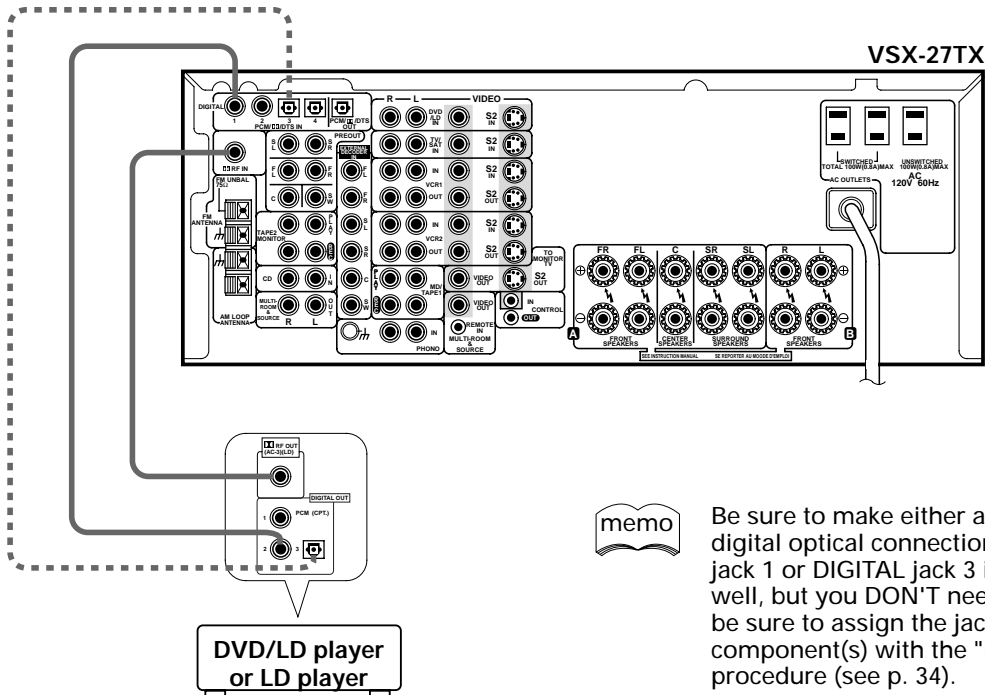

Be sure to make either a digital coaxial or digital optical connection (pictured as DIGITAL jack 1 or DIGITAL jack 3 in this diagram) as well, but you DON'T need to make both. Also, be sure to assign the jacks to the proper component(s) with the "Digital-In Select" procedure (see p. 34).

VSX-26TX/24TX models :

When playing LD recorded in Dolby Digital

To connect a DVD/LD player or LD player with its AC-3 RF output, a commercially available RF demodulator (RFD-1) is required. The RF demodulator changes the RF signal to a digital signal which is then processed by the VSX-26TX/24TX models through their digital input jacks. For more details, refer to the instruction manual supplied with the RFD-1.

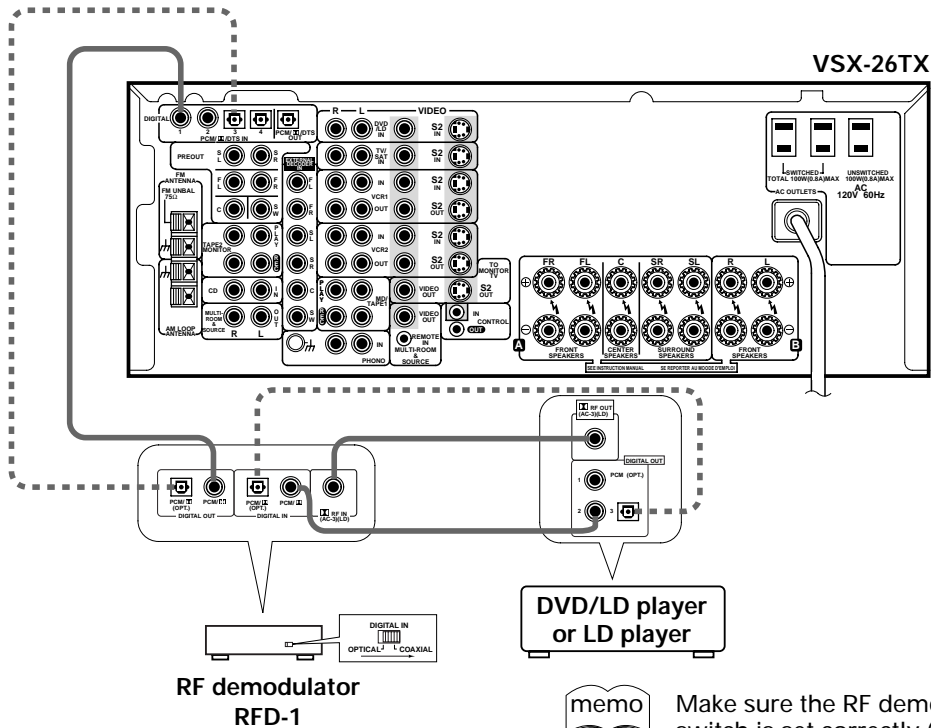

Make sure the RF demodulator digital in switch is set correctly (optical or coaxial depending on the connection).

External Decoder Input

In some cases you may need an external decoder to play special analog or DVD sources. If you find you need an external decoder hook one up as shown below, but for most people this component is unnecessary. (See p.42) When connecting your equipment always make sure the power is turned off and the power cord is disconnected from the wall outlet.

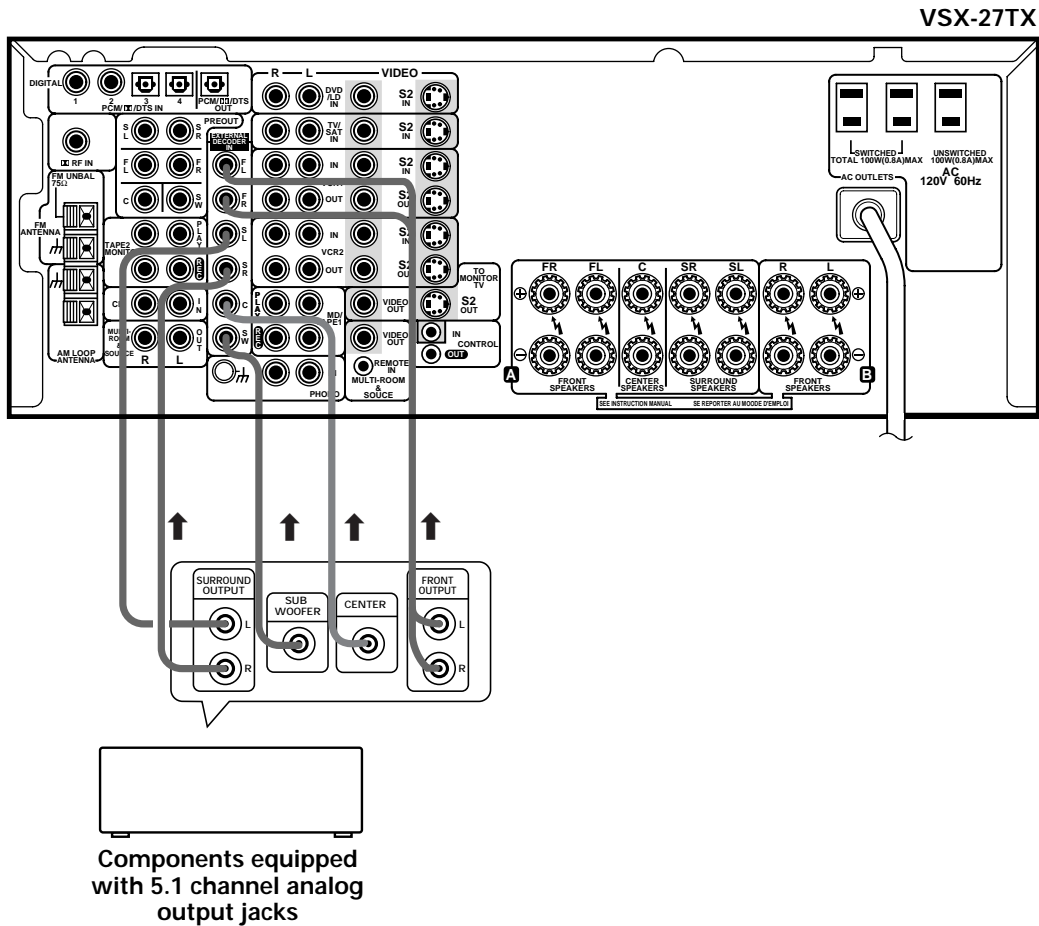

You can't use the tuner and phono functions with an external decoder input.

Antennas

Hook up the supplied radio antennas as shown below. When connecting your equipment always make sure the power is turned off and the power cord is disconnected from the wall outlet.

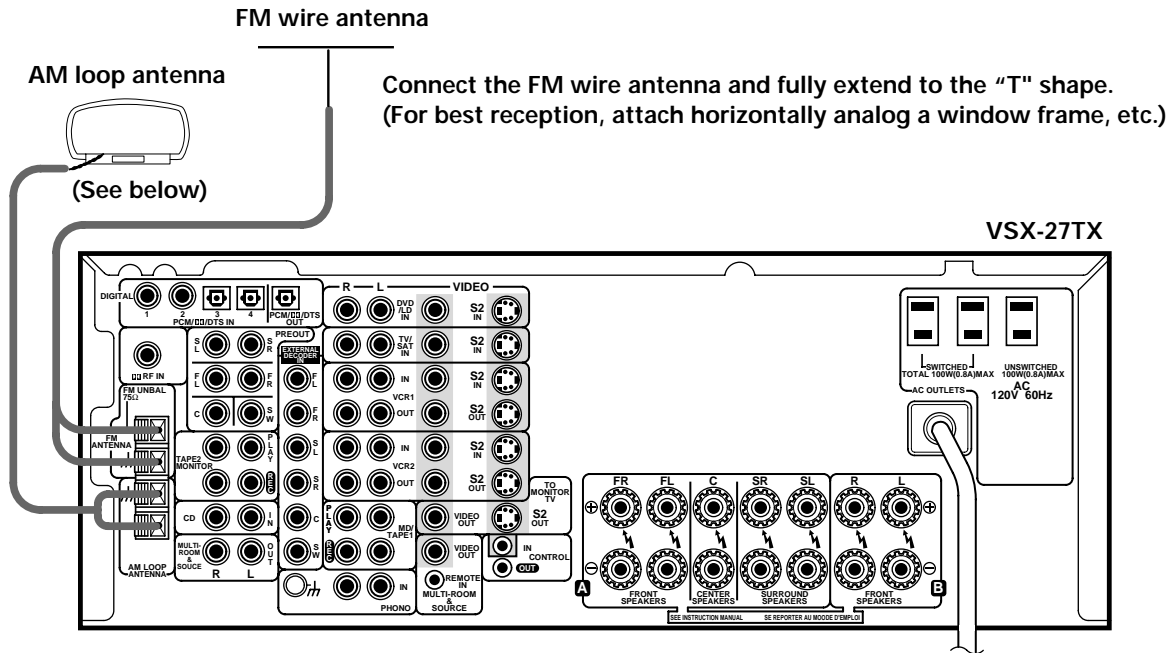

■ AM loop antenna

① Assemble the antenna.

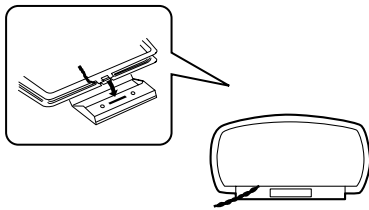

② Twist exposed wire strands together and insert.

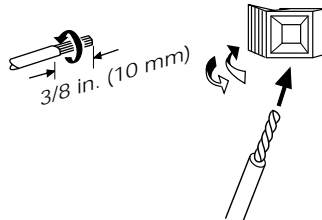

③ Attach to a wall, etc. (if desired) and face toward the direction providing the best reception.

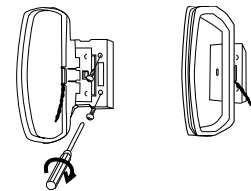

Using external antennas

■ To improve FM reception

Connect an external FM antenna.

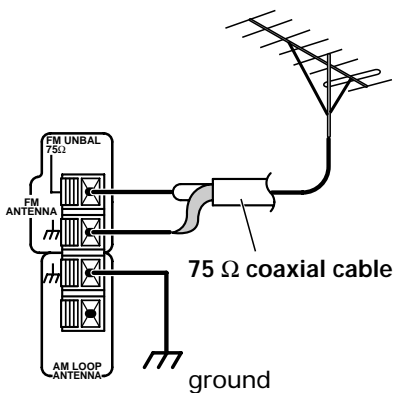

■ To improve AM reception

Connect a 15 to 18 feet (5-6 meter) length of vinyl-coated wire to the AM antenna terminal in addition to the supplied AM loop antenna. For the best possible reception, suspend horizontally outdoors.

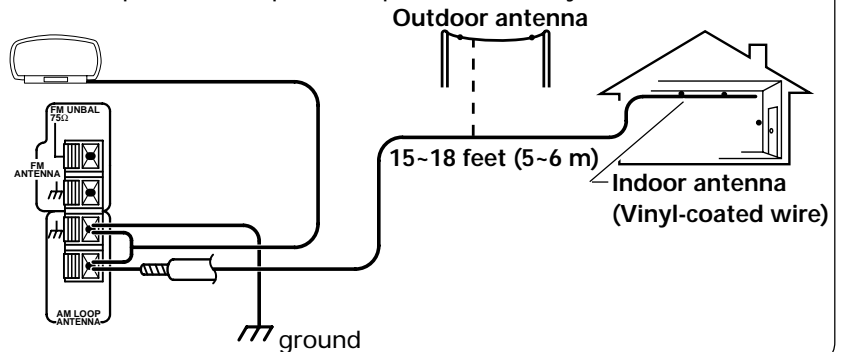

Speakers

A full complement of six speakers is shown here but, naturally, everyone's home set up will vary. Simply connect the speakers you have in the manner described below. The VSX-27TX/26TX/24TX will work with just two stereo speakers (called "front" speakers in the diagram) but the receiver is designed to be used with at least three speakers. Make sure you connect the speaker on the right to the right terminal and the speaker on the left to the left terminal. Also make sure the positive and negative (+/-) terminals on the receiver match those on the speakers. When connecting your equipment always make sure the power is turned off and the power cord is disconnected from the wall outlet.



The VSX-27TX/26TX/24TX has two speaker systems, A & B. A is the main system supporting the full complement of surround sound speakers. If you switch on both A & B speaker systems, only front speakers and the sub-woofer will be audible. No sound will come from the center or surround speakers but multi channel sources will be down-mixed to the active speakers so no sound will be lost. Similarly, if you choose just the B system you'll only hear the front speakers connected to the B system and multi channel sources will be down-mixed to these two speakers.

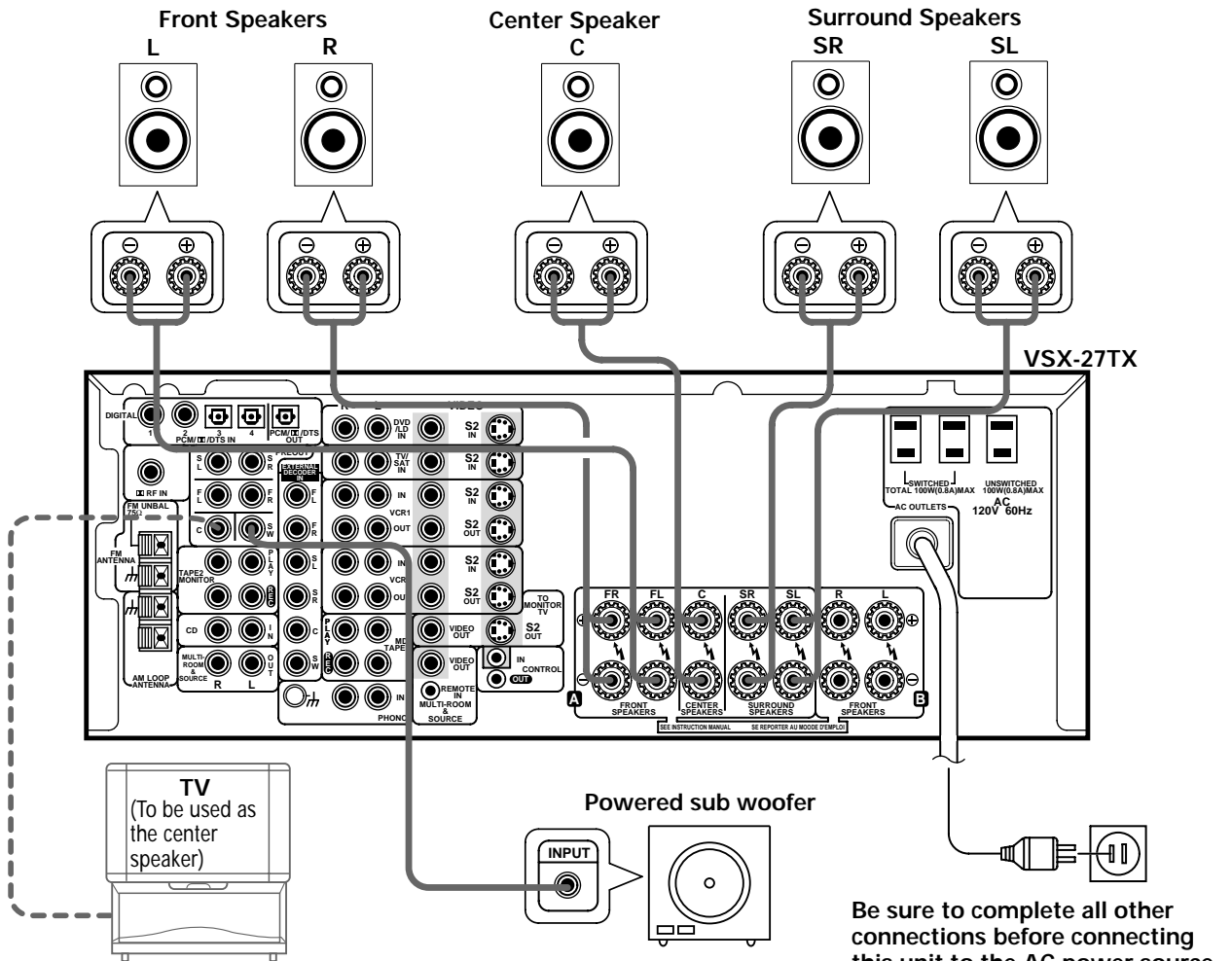

When using the speaker on your TV as the center speaker, connect the CENTER PREOUT jack on this unit to the audio input jack on your TV. In this case, the center speaker shown is unnecessary.

Speaker terminals

- ① Twist exposed wire strands together.
- ② Loosen speaker terminal and insert exposed wire.
- ③ Tighten terminal.

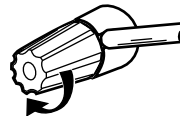
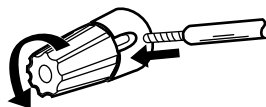
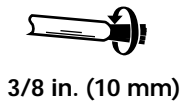

The speaker terminals also accept single banana plugs. (Refer to speaker manual for details.)

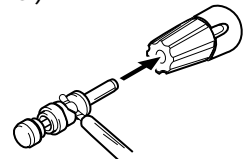

Speaker impedance (26TX and 24TX only)

You can change the speaker impedance to suit the kind of speakers you have in your home system but we recommend using speakers with an impedance of 8Ω-16Ω (the default setting). If you are using less than 8 Ω impedance speakers, you need to change the impedance setting.

STANDBY/ON

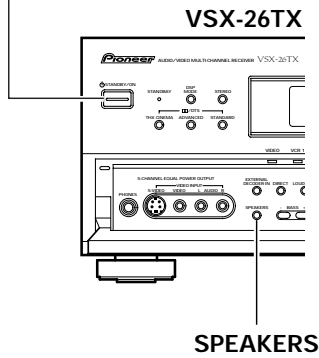

First turn the receiver off, then press the power button while holding down the SPEAKERS button.

Choose the impedance setting by pressing the SPEAKERS button again. You can choose the 8Ω-16Ω setting or the 6Ω-8Ω setting.

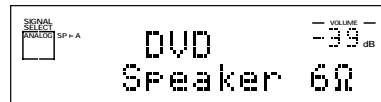

(This display indicates a 6Ω-less than 8Ω impedance setting.)



To check which impedance the amp is set to hold down the SPEAKERS button for 2-3 seconds. You'll get a display like the one shown below right telling you the speaker impedance setting.

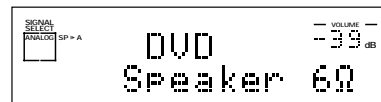

(This display indicates a 6Ω-less than 8Ω impedance setting.)

or

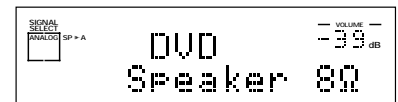

(This display indicates an 8Ω-16Ω impedance setting.)

Speaker placement

If you have a multiple speaker arrangement the placement of the speakers is extremely important. To achieve the best possible surround sound, install your speakers as shown below. Make sure all speakers are installed securely to prevent accidents and improve sound quality. Be sure to consult your speaker manuals for the best placement of the speakers. Some speakers are designed to be floor-standing but others benefit greatly from speakers stands which raise them off the floor.

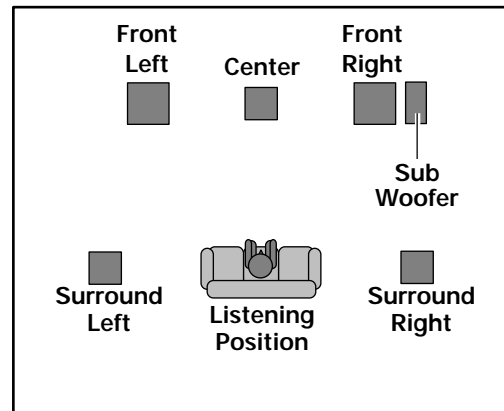
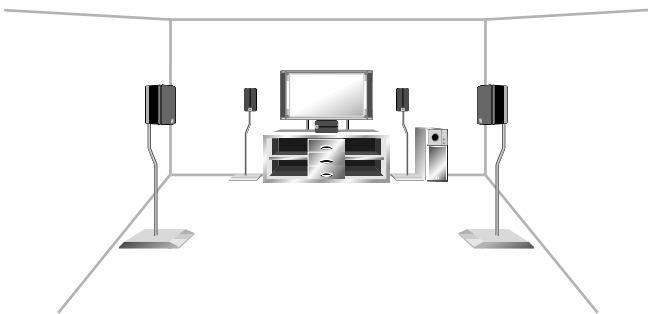

- Install the left and right front speakers at equal distances from the TV.
- When installing speakers near the TV, we recommend using magnetically shielded speakers to prevent possible interference such as distortion in the color of the TV screen. If you do not have magnetically shielded speakers and notice discoloration of the TV screen, place the speakers farther away from the TV.
- Install the center speaker above or below the TV so that the sound of the center channel is localized at the TV screen.

CAUTION:

When installing the center speaker on top of the TV, be sure to secure it with tape or some other suitable means. Otherwise, the speaker may fall from the TV due to external shocks such as earthquakes, and it may lead to endangering those nearby or damaging the speaker.

- If possible, install the surround speakers slightly above ear level.
- It may be difficult to obtain a cohesive surround effect if the surround speakers are installed farther away from the listening position than the front and center speakers.

Connecting additional amplifiers

Although the VSX-27TX/26TX/24TX has more than sufficient power for any home use, it is possible to add additional amplifiers to your system. If you want to use separate amplifiers to power your speakers, make the connections shown below.

When connecting your equipment always make sure the power is turned off and the power cord is disconnected from the wall outlet for all the equipment.

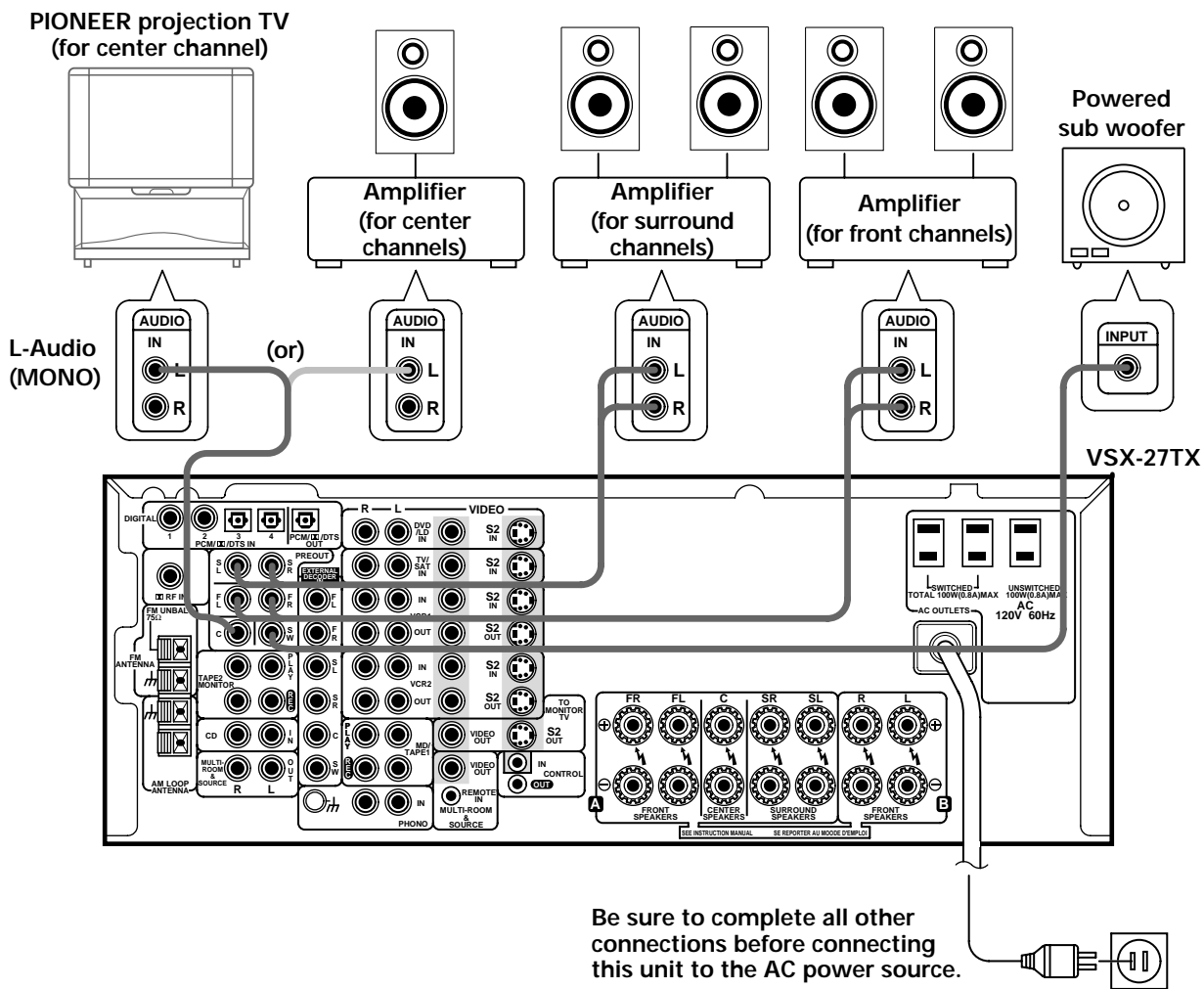

Power connections (AC OUTLETS)

[SWITCHED TOTAL 100 W (0.8 A) MAX]

Power supplied through these outlets is turned on and off by the receiver's POWER switch. Total electrical power consumption of connected equipment should not exceed 100 W (0.8 A).

[UNSWITCHED 100 W (0.8 A) MAX]

Power flows continually to this outlet, regardless of whether the receiver is switched ON or OFF. Electrical power consumption of the connected equipment should not exceed 100 W (0.8 A).

CAUTION!

- To avoid overheating, fire risk, and possible malfunction do not connect high-wattage appliances such as heaters, irons, monitors, or TV sets to this unit's AC OUTLETS.
- Remove the power plug from the wall socket to disconnect this unit from the AC power source when not in regular use, for example, when on vacation.

Display

All the display information is explained and/or referenced here.

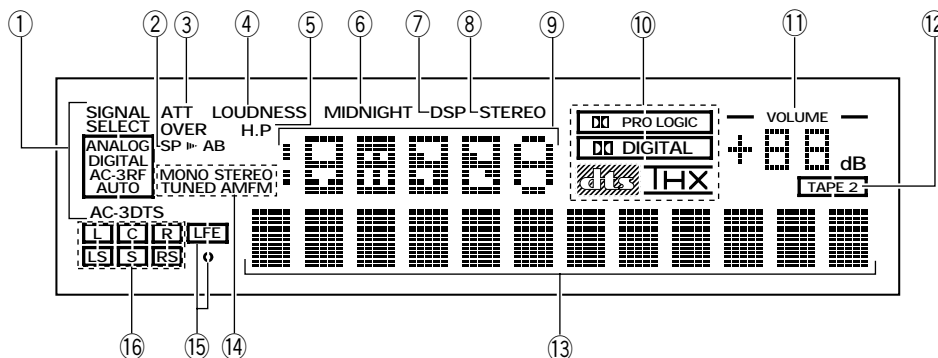

① SIGNAL SELECT indicators

Light to indicate the type of input signal assigned for the current component (see "Front Panel", ⑱, SIGNAL SELECT).

ANALOG : Lights when an analog signal is selected.

DIGITAL : Lights when a digital audio signal is selected (DVD/LD, CD, MD/TAPE1, TV/SAT, VCR 1, VCR 2).

AC-3 RF : Lights when an AC-3 RF signal is selected (DVD/LD, TV/SAT, VCR 1, VCR 2), VSX-27TX only.

AUTO : Lights when the receiver is set to select the input signal automatically. (DVD/LD, CD, MD/TAPE 1, TV/SAT, VCR 1, VCR 2) VSX-27TX only.

AC-3 : Lights when a source with Dolby Digital signals is played.

DTS : Lights when a source with DTS audio signals is played.

② Speaker indicators

Light to indicate the current speaker system (see "Front Panel", ⑳, SPEAKERS (A/B)).

SP > A : Lights when speaker system A is selected.

SP > B : Lights when speaker system B is selected.

SP > AB : Lights when speaker systems A & B are both selected.

③ Analog level indicators

OVER : If "ANALOG" is selected in SIGNAL SELECT, this indicator lights to show that an excessively strong signal is being processed. When this occurs, press INPUT ATT on the front panel to attenuate (lower) the signal. Also, when "DIGITAL" is selected in SIGNAL SELECT, this indicator lights to show that a source containing an excessive amount of information is being processed. If this occurs, see p. 38.

ATT : Lights when INPUT ATT is used to reduce the level of the input signal (available in ANALOG mode only).

④ LOUDNESS indicator (See p.42)

Lights when the LOUDNESS mode is on.

⑤ H.P (headphones)

Lights when headphones are connected to the PHONES jack (speakers systems A and B both turn off automatically).

⑥ MIDNIGHT indicator (See p.41)

Lights when the MIDNIGHT LISTENING mode is on.

⑦ DSP indicator (See p.37-38)

Light when a DSP or Advanced Theater mode is selected.

⑧ STEREO indicator

Lights when a STEREO mode is selected.

⑨ Radio Frequency/Function indicator

Displays the function or the frequency of the current radio station.

⑩ Surround/dts mode indicators

DIGITAL : When the Surround/dts mode on the receiver is on, this indicator lights to indicate playback of a Dolby Digital signal. However, PRO LOGIC lights during 2 channel playback of Dolby Digital.

PRO LOGIC : When the Surround/dts mode on the receiver is on, this indicator lights during 2 channel playback. (Both B or A+B speaker systems turn off automatically when headphones are plugged in.)

DTS : Lights when DTS signals are input.

HOME THX CINEMA : Lights when the HOME THX CINEMA mode is selected.

⑪ MASTER VOLUME indication

Displays current level of master volume.

⑫ TAPE 2 indicator

Lights when the TAPE 2 monitor is on.

⑬ Character display

Displays sound modes, general information, etc.

⑭ Tuner indicators

MONO : Lights when the tuner is set to receive FM broadcasts and when selected MPX mode.

STEREO : Lights when a FM stereo broadcast is received in the auto stereo mode.

TUNED : Lights when a broadcast is received.

AM/FM : Light to indicate the current band (FM or AM).

⑮ LFE indicator

LFE (Low Frequency Effects) indicator lights to indicate that the program source contains an LFE channel. The indicator under the LFE lights during actual playback of the LFE signals (LFE signals are not present in all parts of the soundtrack).

⑯ Program Format indicator

When a Dolby Digital or DTS signal is input, he following indicators light to show the channels being played back.

L : Left front*¹*², **C** : Center*¹, **R** : Right front*¹*²,

LS : Left surround*¹, **S** : Surround (mono)*²,

RS : Right surround*¹

*1: Indicates 5.1ch Dolby Digital or DTS playback.

*2: Indicates Dolby Pro Logic playback.

Front Panel (VSX-27TX/26TX)

All the controls on the front panel are explained and/or referenced here. To open the front panel push gently on the lower third of the panel.

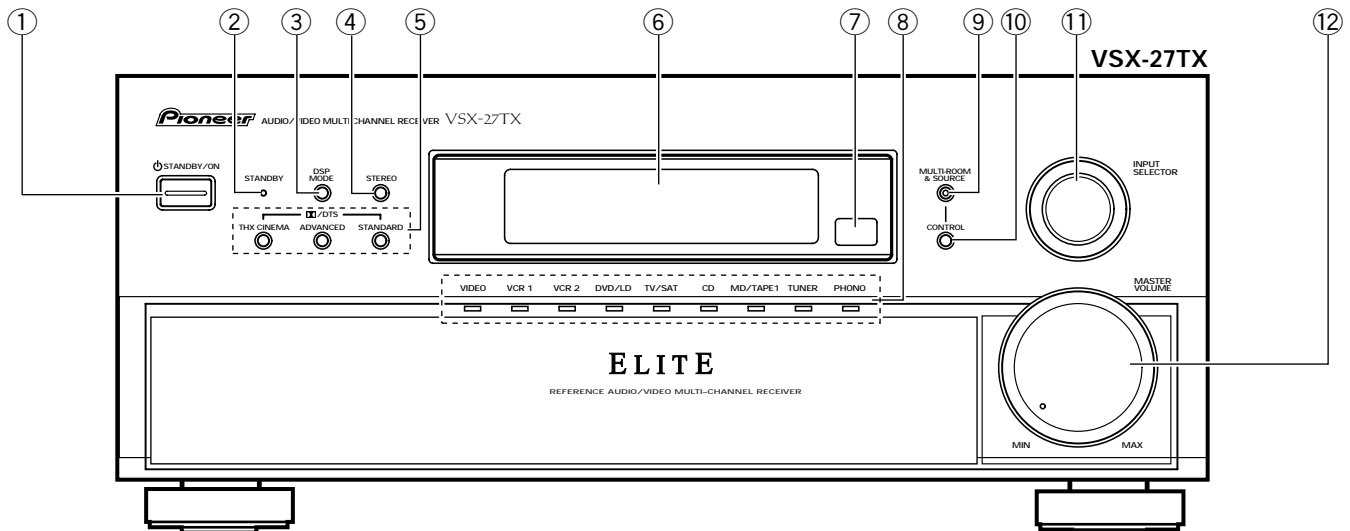

- ① **STANDBY/ON button**
Press to switch the receiver ON or into STANDBY mode.
- ② **STANDBY indicator**
Lights when the receiver is in STANDBY mode. (Please note that this receiver consumes a small amount of power (1.0 W) during the standby mode.)
- ③ **DSP MODE button (See p.37-38)**
Press repeatedly to select a DSP sound mode. (HALL 1, HALL 2, JAZZ, DANCE, THEATER 1, or THEATER 2). Use these modes to produce surround sound from standard (two channel) stereo sources and create different listening environments.
- ④ **STEREO button (See p.37-38)**
Press to select the STEREO sound mode. In this mode, sound comes from the front (left and right) speakers only.
- ⑤ **THX CINEMA /DTS buttons (See p. 36,38 & 72-74)**
THX CINEMA : Press to select the HOME THX CINEMA sound mode when listening to Dolby Digital, Dolby Pro Logic or DTS a variety of other sources.
ADVANCED THEATER : Press to select one of the four Advanced Theater modes.
STANDARD : Press for pure decoding of multi channel sources.
- ⑥ **Display (See page 17)**
- ⑦ **Remote sensor**
Point the remote control toward the remote sensor to operate the receiver.
- ⑧ **Source indicators (VSX-27TX only)**
Shows the source currently selected.
- ⑨ **MULTI-ROOM & SOURCE button (See p.67-71)**
Press to enable multi room operation (requires an optional PIONEER Multi-Room Remote Sensor Unit MR-100 or other IR receiver).
- ⑩ **CONTROL button (See p.67-71)**
Use to select the function or volume of the MULTI ROOM system.
- ⑪ **INPUT SELECTOR dial**
Turn to select a source component. The source indicators show the current component:
DVD/LD : DVD player or Laser Disc player.
TV/SAT : TV tuner or satellite tuner.
CD : Compact Disc player.
MD/TAPE 1 : Tape deck or Mini Disc recorder connected to MD/TAPE 1 inputs/outputs.
TUNER : The built-in tuner.
PHONO : Turntable.
VIDEO : Video camera (etc.) connected to the VIDEO INPUT on the front panel.
VCR 1 : Video cassette recorder connected to VCR 1 inputs.
VCR 2 : Video cassette recorder or other component connected to VCR 2 inputs.
- ⑫ **MASTER VOLUME**
Adjusts the overall receiver volume.
- ⑬ **EXTERNAL DECODER IN (See p.42)**
Use to hook up an external component that can decode other types of signals and input them into the VSX-27TX/26TX.
- ⑭ **DIRECT button**
Switches DIRECT playback on or off. Use to bypass the tone controls and channel level for the most accurate reproduction of a program source. It will automatically put the receiver in STEREO mode for the function being used for DIRECT playback.

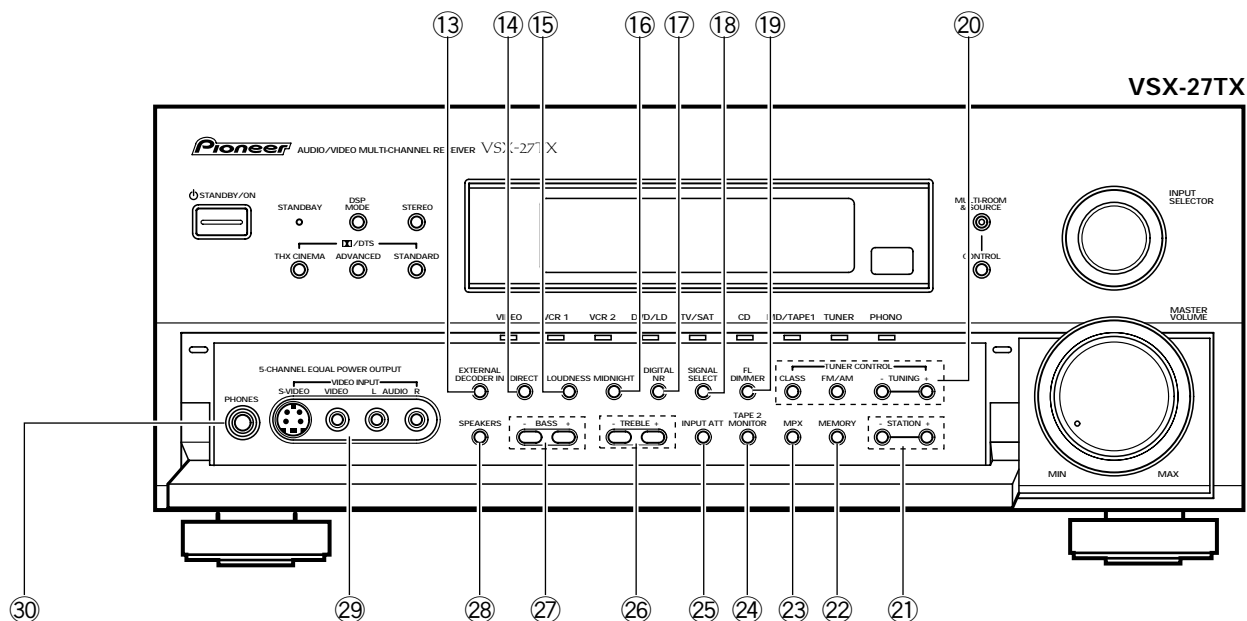

- 15 **LOUDNESS button** (See p.42)
Switches the LOUDNESS mode on or off.
- 16 **MIDNIGHT button** (See p.41)
Switches the MIDNIGHT LISTENING mode on or off.
- 17 **DIGITAL NR button** (See p.41)
Switches the DIGITAL NR on or off (STEREO mode only).
- 18 **SIGNAL SELECT button** (See p.40)
Use to select the type of signal being input into the receiver.
SIGNAL SELECT repeatedly to select one of the following:
ANALOG : To select an analog signal.
DIGITAL : To select a optical or coaxial digital signal.
AC-3 RF : To select an AC-3 RF signal (VSX-27TX only).
AUTO : This is the default. If there are both analog and digital input signals, the receiver automatically selects the digital signal (VSX-27TX only).
- 19 **FL DIMMER button** (See p.43)
Use to adjust the brightness of the main display.
- 20 **TUNER CONTROL button** (See p.44-47)
CLASS : Press repeatedly to switch the preset station classes.
FM/AM : Press to select the AM or FM band.
TUNING +/- : Use to manually tune to radio stations.
- 21 **STATION +/- buttons** (See p.46-47)
Use to choose programmed radio stations.
- 22 **MEMORY button** (See p.46)
Press to start the memorization of a preset station.
- 23 **MPX button** (See p.44)
Press to switch between auto stereo and MONO reception of FM broadcasts. When the broadcast signal is weak, selecting MONO will improve the sound quality.
- 24 **TAPE 2 MONITOR button** (See p.60)
Selects the tape deck (MD recorder, etc.) connected to the TAPE 2 MONITOR inputs/outputs. Allows monitoring of a recording as it's being made.
- 25 **INPUT ATT button**
Use to lower the input level of an analog signal that is too powerful, thus causing the receiver to distort (the overload indicator will light furiously).
- 26 **TREBLE (-/+ button** (See p.43)
Use to adjust the high frequencies.
- 27 **BASS (-/+ button** (See p.43)
Use to adjust low frequencies.
- 28 **SPEAKERS (A/B) buttons**
A is the primary setting. It plays all speakers hooked up to the A system. A & B setting only plays the front speakers of both the A & B systems and the subwoofer. Multi channel sources will be down-mixed to these speakers so no sound will be lost. B setting only plays the front speakers connected to the B system and multi channel sources will be down-mixed to these two speakers.

→ A → B → A+B → OFF
- 29 **VIDEO INPUT jacks** (See p.9)
S-VIDEO : Video input for connecting a video camera (etc.), that has an S-Video out.
VIDEO / AUDIO (L/R) : Video input for connecting a video camera, etc. that has standard video/audio outputs.
- 30 **PHONES jack**
Connect headphones for private listening (no sound will be heard through the speakers)

Front Panel (VSX-24TX)

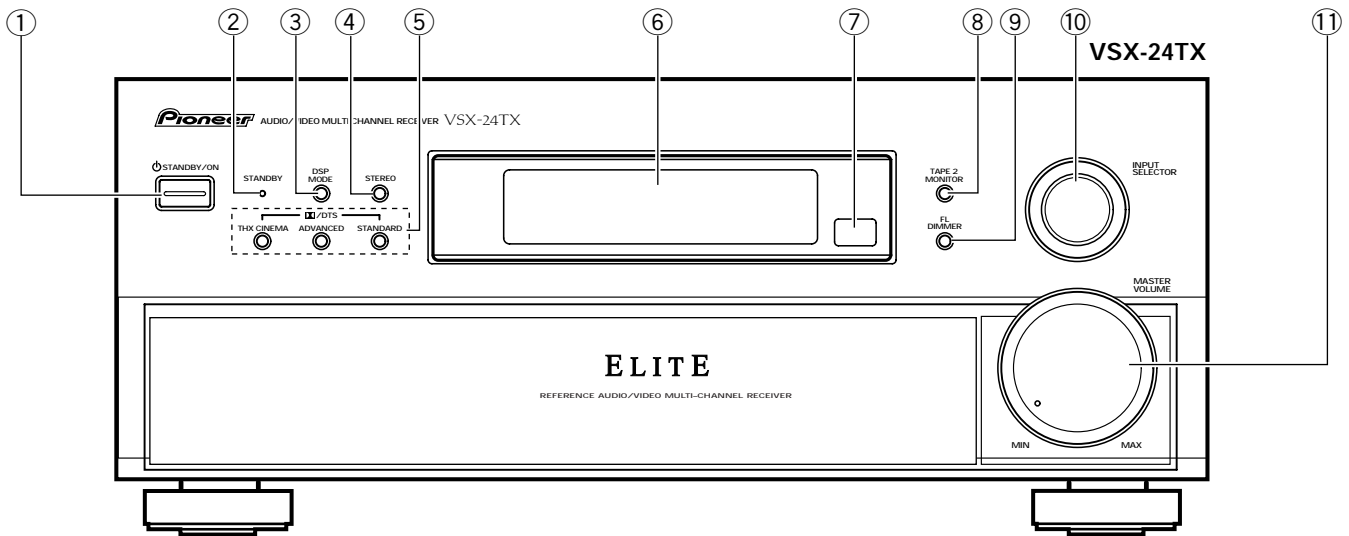

- ① **STANDBY/ON button**
Press to switch the receiver ON or into STANDBY mode.
- ② **STANDBY indicator**
Lights when the receiver is in STANDBY mode. (Please note that this receiver consumes a small amount of power (1.0 W) during the standby mode.)
- ③ **DSP MODE button (See p.37-38)**
Press repeatedly to select a DSP sound mode. (HALL 1, HALL 2, JAZZ, DANCE, THEATER 1, or THEATER 2). Use these modes to produce surround sound from standard (two channel) stereo sources and create different listening environments.
- ④ **STEREO button (See p.37-38)**
Press to select the STEREO sound mode. In this mode, sound comes from the front (left and right) speakers only.
- ⑤ **THX CINEMA /DTS buttons (See p. 36,38 & 72-74)**
THX CINEMA : Press to select the HOME THX CINEMA sound mode when listening to Dolby Digital, Dolby Pro Logic or DTS a variety of other sources.
ADVANCED THEATER : Press to select one of the four Advanced Theater modes.
STANDARD : Press for pure decoding of multi channel sources.
- ⑥ **Display (See page 17)**
- ⑦ **Remote sensor**
Point the remote control toward the remote sensor to operate the receiver.
- ⑧ **TAPE 2 MONITOR button (See p.60)**
Selects the tape deck (MD recorder, etc.) connected to the TAPE 2 MONITOR inputs/outputs. Allows monitoring of a recording as it's being made.
- ⑨ **FL DIMMER button (See p.43)**
Use to adjust the brightness of the main display.
- ⑩ **INPUT SELECTOR dial**
Turn to select a source component. The source indicators show the current component:
DVD/LD : DVD player or Laser Disc player.
TV/SAT : TV tuner or satellite tuner.
CD : Compact Disc player.
MD/TAPE 1 : Tape deck or Mini Disc recorder connected to MD/TAPE 1 inputs/outputs.
TUNER : The built-in tuner.
PHONO : Turntable.
VIDEO : Video camera (etc.) connected to the VIDEO INPUT on the front panel.
VCR 1 : Video cassette recorder connected to VCR 1 inputs.
VCR 2 : Video cassette recorder or other component connected to VCR 2 inputs.
- ⑪ **MASTER VOLUME**
Adjusts the overall receiver volume.
- ⑫ **EXTERNAL DECODER IN (See p.42)**
Use to hook up an external component that can decode other types of signals and input them into the VSX-24TX.
- ⑬ **DIRECT button**
Switches DIRECT playback on or off. Use to bypass the tone controls and channel level for the most accurate reproduction of a program source. It will automatically put the receiver in STEREO mode for the function being used for DIRECT playback.
- ⑭ **LOUDNESS button (See p.42)**
Switches the LOUDNESS mode on or off.
- ⑮ **MIDNIGHT button (See p.41)**
Switches the MIDNIGHT LISTENING mode on or off.

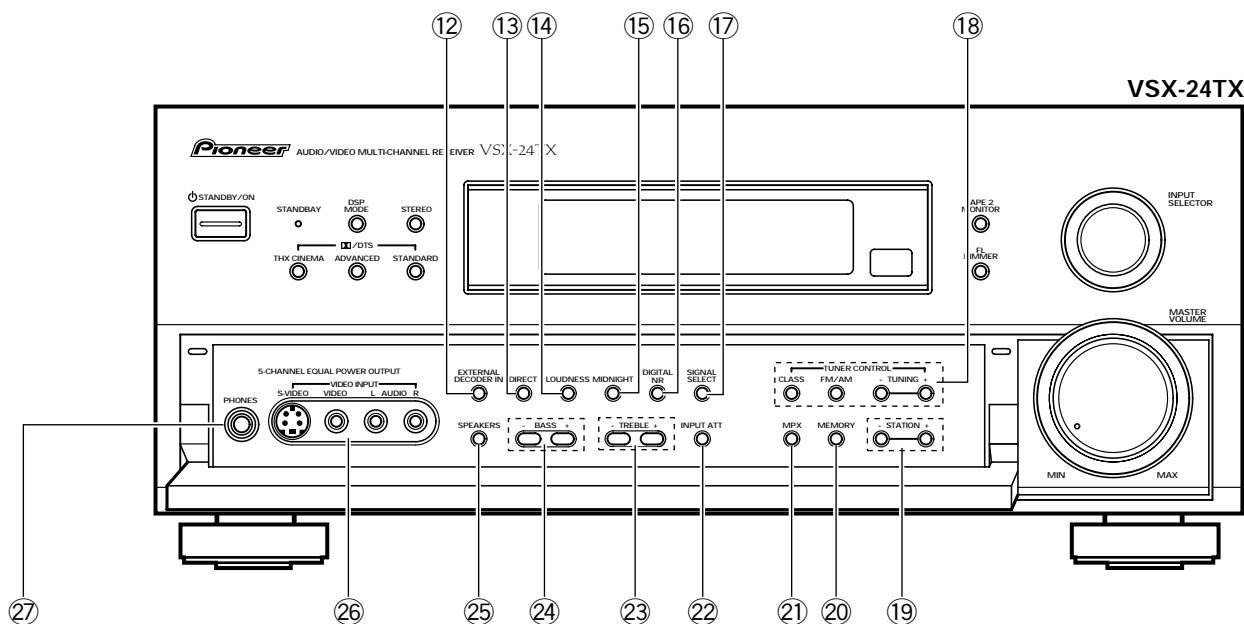

- 16 **DIGITAL NR button (See p.41)**
Switches the DIGITAL NR on or off (STEREO mode only).
- 17 **SIGNAL SELECT button (See p.40)**
Use to select the type of signal being input into the receiver.
SIGNAL SELECT repeatedly to select one of the following:
ANALOG : To select an analog signal.
DIGITAL : To select a optical or coaxial digital signal.
- 18 **TUNER CONTROL button (See p.44-47)**
CLASS : Press repeatedly to switch the preset station classes.
FM/AM : Press to select the AM or FM band.
TUNING +/- : Use to manually tune to radio stations.
- 19 **STATION +/- buttons (See p.46-47)**
Use to choose programmed radio stations.
- 20 **MEMORY button (See p.46)**
Press to start the memorization of a preset station.
- 21 **MPX button (See p.44)**
Press to switch between auto stereo and MONO reception of FM broadcasts. When the broadcast signal is weak, selecting MONO will improve the sound quality.
- 22 **INPUT ATT button**
Use to lower the input level of an analog signal that is too powerful, thus causing the receiver to distort (the overload indicator will light furiously).
- 23 **TREBLE (-/+ button (See p.43)**
Use to adjust the high frequencies.
- 24 **BASS (-/+ button (See p.43)**
Use to adjust low frequencies.

- 25 **SPEAKERS (A/B) buttons**
A is the primary setting. It plays all speakers hooked up to the A system. A & B setting only plays the front speakers of both the A & B systems and the subwoofer. Multi channel sources will be down-mixed to these speakers so no sound will be lost. B setting only plays the front speakers connected to the B system and multi channel sources will be down-mixed to these two speakers.

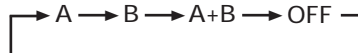

- 26 **VIDEO INPUT jacks (See p.9)**
S-VIDEO : Video input for connecting a video camera (etc.), that has an S-Video out.
VIDEO / AUDIO (L/R) : Video input for connecting a video camera, etc. that has standard video/audio outputs.
- 27 **PHONES jack**
Connect headphones for private listening (no sound will be heard through the speakers)

Remote Control

These pages describe the buttons on the remote control used to operate the receiver.

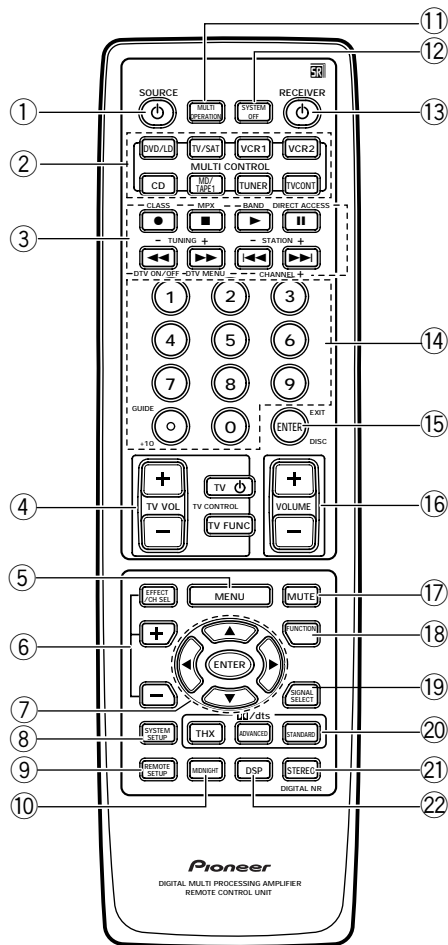

- ① **⏻ SOURCE button** (See p.52-59)
 Use to turn on the power of your other components after you have recalled or taught the signals to this remote control.
- ② **MULTI CONTROL buttons**
 Use these to select a source and the corresponding remote operation mode.
 For example, pressing TUNER selects the built in tuner and sets the remote operation to the tuner functions.
- ③ **Component Control buttons**
 Use to control specific components, like a CD player or DVD player, after you have programmed the remote control to do these operations (see p.52-59) and the remote is put in that operation mode.
- ④ **TV CONTROL buttons**
 The following buttons are used to control the TV only and can be used no matter what function the remote control is set to.
TV ⏻ : Press to turn the power of the TV on/off.
TV FUNC : Press TV FUNC to select the TV for remote control operation.
TV VOL +/- : Press to control the volume of the TV.
- ⑤ **MENU button**
 Use to get the various menus for your TV or DTV.
- ⑥ **EFFECT/CH SEL +/- buttons** (See p.38)
EFFECT : Use these buttons to increase or decrease the amount of effect applied in a DSP or Advanced Theater mode. When the amount of effect is increased in a DSP/Advanced Theater mode the characteristics of that mode become stronger and more noticeable. The scale ranges from 10-90 with 70 as the default setting. First turn on the DSP/Advanced Theater you want (by pressing the DSP/Advanced Theater button until you get the mode) and then increase or decrease the amount of effect.
CH SEL : You may want to adjust the channels when listening to some sound sources. Use this button to select the channel you want to adjust.
+/- : Use these buttons to select the amount of effect in a sound mode and to adjust the channel level when making sound settings.
- ⑦ **▲/▼/◀/▶/ENTER buttons**
 Use to operate the on-screen menu on your TV screen and enter commands when setting up surround sound, speakers levels & settings, and other set up features see p.24-34). Specific use of these buttons is described in conjunction with the operations they perform. For more information see each individual section.

- ⑧ **SYSTEM SET UP button**
Use to set up the speaker and sound systems. For more information see "Surround Sound Setup" starting on p. 24.
- ⑨ **REMOTE SETUP button.**
Use to customize the remote control functions and the remote control itself. (See "Setting Up the Remote Control to Control Other Components" starting on p.48, "Multi Operation" starting on p. 63.)
- To access the EXTERNAL DECODER option, press the REMOTE SETUP button and the SIGNAL SELECT button simultaneously.
- ⑩ **MIDNIGHT button (See p. 41)**
Switches the MIDNIGHT mode on or off.
- ⑪ **MULTI OPERATION button**
Use this button to start the MULTI OPERATION mode. See p. 63 for how to program and use the MULTI OPERATION mode.
- ⑫ **SYSTEM OFF button**
This button turns off components in two ways. First, when pressed it will turn off all PIONEER components. Secondly, any component that has programmed into the MULTI OPERATIONS settings will also be turned off (see p.63).
For example : If you programmed power on for your TV and VCR, pressing the SYSTEM OFF button will turn off these components even if they are not PIONEER products.
- ⑬ **⏻ RECEIVER button**
Press to turn power of the receiver on or to STANDBY (off).
- ⑭ **Number buttons**
These buttons can perform a variety of different functions depending on the remote operation mode. They are most useful for CD and tuner operations.
- ⑮ **ENTER/EXIT/DISC button**
These buttons can perform a variety of different functions depending on the remote operation mode.
- ⑯ **MASTER VOLUME button**
Use to raise or lower the volume of the receiver.
- ⑰ **MUTE button**
Press to mute or restore the volume.
- ⑱ **FUNCTION button**
Press to select a source. The button will cycle through all the possible sources.
- ⑲ **SIGNAL SELECT button**
Press SIGNAL SELECT repeatedly to select one of the following:
ANALOG : To select an analog signal.
DIGITAL : To select a digital signal (DVD/LD, TV/SAT, CD, MD/TAPE 1, VCR 1, VCR 2).
AC-3 RF : To select an AC-3 RF signal (DVD/LD, TV/SAT, VCR 1, VCR 2), VSX-27TX only.
AUTO : This is the default. If there are both analog and digital input signal, the receiver automatically selects the best possible signal (VSX-27TX only). Press the SIGNAL SELECT and REMOTE SETUP buttons simultaneously to switch from the SIGNAL SELECT operation to EXTERNAL DECODER operation. Then press the button to get the EXTERNAL DECODER function. To get back to the SIGNAL SELECT control, press the REMOTE SETUP button and the SIGNAL SELECT button simultaneously once again.
- ⑳ **⏮ /dts buttons (See p.38)**
Press these buttons to put the receiver in the selected sound mode. For more information on the modes .
- ㉑ **STEREO/DIGITAL NR button**
STEREO : Press this button to put the receiver into stereo mode when it's in a different sound mode. For more information on the sound modes see p.38.
DIGITAL NR : Switches the DIGITAL NR on or off (see p.41).
- ㉒ **DSP button (See p.38)**
Press repeatedly to select a DSP sound mode.

Surround Sound Set Up

On Screen Display

There are a number of possible ways to hook up the receiver to your video components, like a DVD player, and hook up to your receiver to your TV, but some of them won't allow you to use the on-screen display of this unit. To avoid this one simply needs to follow two rules.

- ① Always use the same type of video cords to hook up your video components to the receiver as you use to hook up the receiver and your TV. For example, if you use composite video cords to hook up your DVD and the receiver, use composite video cords to hook up the receiver to your TV. If you use S video cords to hook up your DVD and the receiver, use S video cords to hook up the receiver to your TV.
- ② Always make sure your TV is set to the appropriate input channel (for example, video 1). Your TV may have a number of input channels and if you don't select the proper one you won't be able to use this receiver's on-screen display, or, in fact, see any picture from this receiver at all. If you are unsure how to choose an input channel for your TV, refer to the manual which came with your TV.

You might, for example, use both composite and S video cords to hook up your video components with this receiver and then use composite video cords to hook up this receiver to your TV. This arrangement would still NOT let you see the on screen displays from this receiver on your TV. The best idea is just to use one type of video cord for all your video component and TV hook ups.

Setting Up for Surround Sound

To ensure the best possible surround sound, be sure to complete the following set up operations. This is particularly important when using the HOME THX CINEMA , DTS,  (Dolby) Surround sound modes. You only need to make these settings once (unless you change the placement of your current speaker system or add new speakers, etc.). These set up operations use your TV to display the settings and choices so be sure your TV and receiver are properly hooked up.

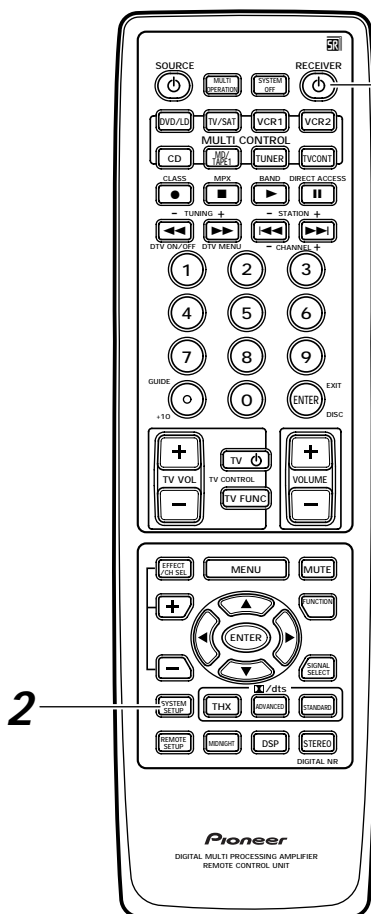

1 Turn on the receiver and your TV.

Make sure your TV is set to the receiver.

2 Press SYSTEM SETUP button.

The SYSTEM SETUP MENU appears on your TV screen.

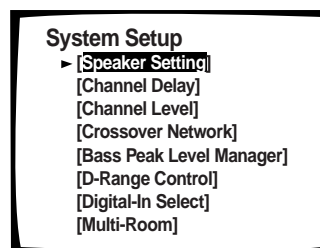

* You can escape from this screen at any time by pressing the SYSTEM SETUP button again. None of the settings you made will be entered in this case.



Only the VSX-27TX and 26TX models have a MULTI ROOM function (see p.67-71).

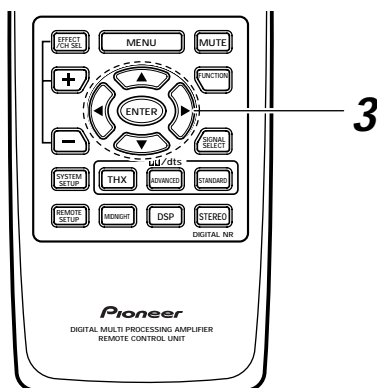

3 Press the ▲ or ▼ arrow buttons to move the hand to the mode you want. Then press ENTER.

In each mode, the current settings are displayed automatically. We suggest you adjust all these settings when you first hook up to the receiver. That gets them out of the way and you won't need to return to this setting mode unless you change your home set up by adding new speakers (etc.). The sound set up modes explained here are:

Speaker Setting (See p.26-27)

Use to specify the type and number of speakers you connected.

Channel Delay (See p.28)

Set up all your speakers for the most realistic surround sound. Adding a slight delay to some speakers enhances sound separation and is particularly important for achieving a surround sound effect. You need to figure out the distance from your listening position to your speakers to add the proper delay.

Channel Level (See p.29-30)

Use to balance the volumes of your different speakers.

Crossover Network (See p.31)

This feature lets you select which bass frequencies will be sent to the sub woofer or front speakers.

Bass Peak Level Manager (See p.32)

Dolby Digital and DTS audio sources include ultra-low bass tones. Set the bass peak level as needed to prevent the ultra-low bass tones from distorting the sound from the speakers.

D-Range Control (See p.33)

This feature makes possible excellent surround sound effects when listening to Dolby Digital sources at low volumes.

Digital-In Select (See p.34)

In order to use your digital components you must match the numbered digital input settings with the numbered digital jacks used by your digital components.

Multi-Room [VSX-27TX/26TX only] (See p.67-71)

You can set up this unit to power systems in different rooms.

4 Go on to the next page to continue set up. To exit the SYSTEM SETUP MENU and on-screen display press SYSTEM SET UP button again.



After you complete one of the SYSTEM SETUP menus and return to the basic SYSTEM SETUP screen (shown in the diagram directly above labeled 4), the receiver automatically moves the cursor to the next SYSTEM SETUP menu. For example, if you've completed SPEAKER SETTINGS and returned to the basic SYSTEM SETUP screen, CHANNEL DELAY will be selected automatically. You can notice this on your TV screen.

Speaker Setting

The following steps show you how to specify the type of speakers you connected. Use the ▲/▼ and ◀/▶ arrow buttons to make a selection within the on-screen menus, and use the enter to register the information.

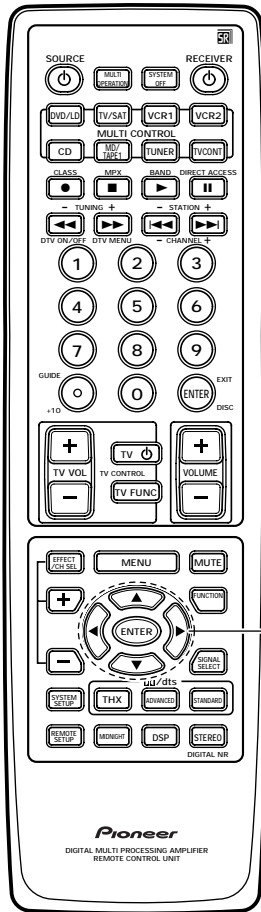

1,2

- 1 **Select SPEAKER SETTING with the ▲/▼ buttons.** See "Setting Up for Surround Sound" on the previous page if you are unsure how to do this.
Press ENTER.

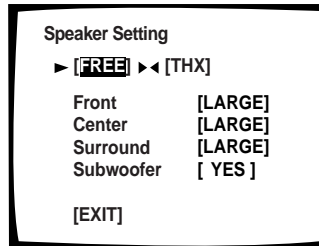

- 2 **Select a speaker setting mode with the ◀/▶ buttons.**

To specify each speaker individually
Select FREE.

If you connected a complete set of THX speakers
Select THX and skip to step 4.

Press the ▼ button.

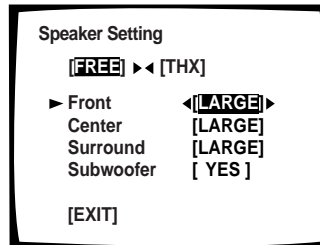

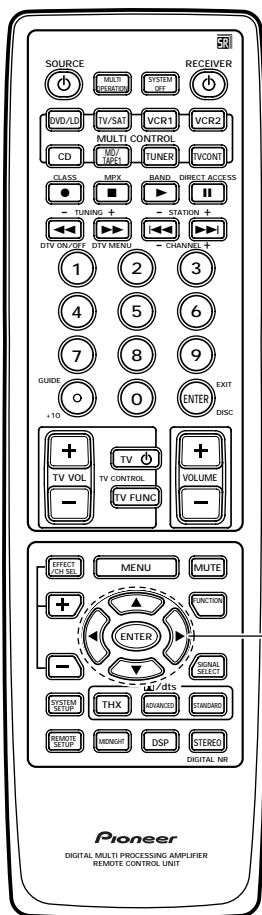

3,4



If you have a sub woofer and like lots of bass, it may seem logical to select LARGE for your FRONT speakers and leave the sub woofer selected. This may not, however, yield the best bass results. Depending on the size and shape of your room you may actually experience a decrease in the amount of bass due to what is called "low frequency cancellations." If you have a sub woofer, listen to the bass response with the FRONT speakers set to LARGE and SMALL alternatively and let your ears judge which sounds best.

The safest option in this case is to route all the bass sounds to the sub woofer by selecting SMALL for the FRONT speakers.

3 Specify the type of speakers you connected. See the explanations below for the meaning of each size.

- ① Press ◀ or ▶ to move the hand to LARGE, SMALL, or NO (you can't select NO for the FRONT speakers).
- ② Press ▼.
- ③ Repeat ① and ② for each speaker.

Depending on your choices the sound will be routed differently, as explained here.

FRONT (default setting is LARGE)

- Select small to send bass frequencies to the sub woofer.
- Select large if your speakers will reproduce bass frequencies effectively or if you did not connect a sub woofer. (If you select small for the front speakers the sub woofer will automatically be switched YES. Also, the center and surround speakers cannot be set to large if the front speakers are set to small. In this case, all bass frequencies are sent to the sub woofer.)

CENTER (default setting is LARGE)

- Select large if your speaker will reproduce bass frequencies effectively.
- Select small to send bass frequencies to the other speakers or sub woofer.
- If you did not connect a center speaker, deselect it. In this case, the center channel is output from the front speakers.

SURROUND (default setting is LARGE)

- Select large if your speakers will reproduce bass frequencies effectively.
- Select small to send bass frequencies to the other speakers or sub woofer.
- If you did not connect surround speakers deselect them. In this case, the sound of the surround channels is output from the front and center speakers.

SUB WOOFER (default setting is YES)

- Leave it selected if you connected a sub woofer.
- If you did not connect a sub woofer deselect it. In this case, the bass frequencies are output from the front or surround speakers.
- Choose the PLUS setting if you want stronger reproduction of deep bass sounds.
- If you select PLUS the bass frequencies that would normally come out the front and center speakers are all routed to the sub woofer.

4 Select EXIT with the ▲/▼ buttons and press ENTER to return to the SYSTEM SETUP MENU.

Next, proceed to CHANNEL DELAY below.

If you want to change a setting before proceeding Simply use the arrow buttons to go back.

Channel Delay

Adding a slight delay to some speakers is necessary to achieve a surround sound effect. You need to figure out the distance from your listening position to your speakers to add the proper delay. The following steps show you how to set the delay time for each channel by specifying the distances from your listening position to each speaker. Once you specify the speaker distances, the receiver calculates the correct delay times automatically. If continuing from SPEAKER SETTING go to step 1. If starting fresh, complete steps 1-3 in "Setting Up for Surround Sound" (p.24) first.

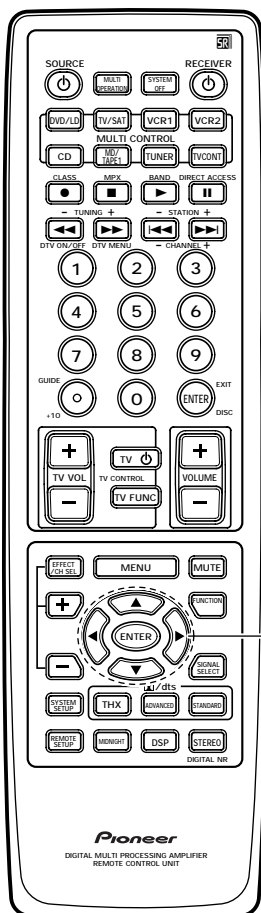

1-3

1 Select CHANNEL DELAY (if continuing from last set up, it will already be selected).

See "Setting Up for Surround Sound" on page 24 if you are unsure how to do this.

Press ENTER.

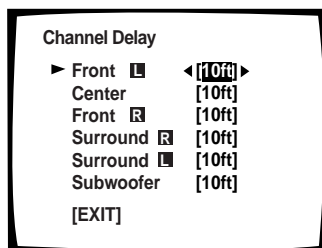

The default setting is 10 ft.

2 Use the ▲/▼ buttons to select a speaker. Specify the distance from your listening position to each speaker using the commands below.

- ① Press ◀ or ▶ to adjust the speaker distance in 1 foot increments from 1 to 30 feet. (1 foot equals approximately 0.3 meters.)
- ② Use the ▲/▼ buttons to move to the next set of speakers
- ③ Repeat for each speaker.

NOTE : Sound takes about 1 ms (millisecond) to travel 1 foot.

3 Select EXIT with the ▲/▼ buttons and press ENTER to return to the SYSTEM SETUP MENU.

Next, proceed to CHANNEL LEVEL below.

If you want to change a setting before proceeding Simply use the arrow buttons to go back.

Channel Level

The following steps show you how to balance the sound output level of your speakers. Proper speaker balance is essential for obtaining high quality surround sound. If continuing from CHANNEL DELAY go to step 1. If starting fresh, complete steps 1-3 in "Setting Up for Surround Sound" (p.24) first.

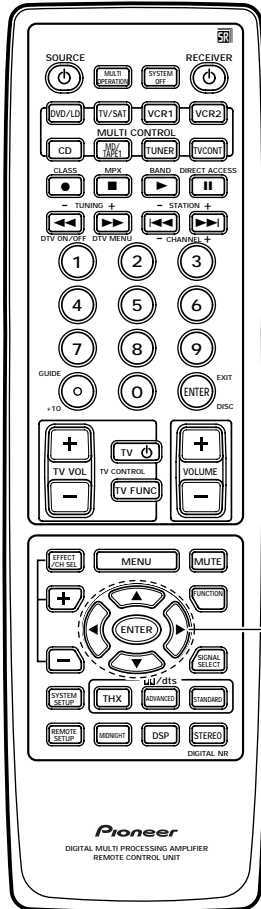

1 Select CHANNEL LEVEL (if continuing from CHANNEL DELAY, it will already be selected).

See "Setting Up for Surround Sound" on page 24 if you are unsure how to do this.

Press ENTER.

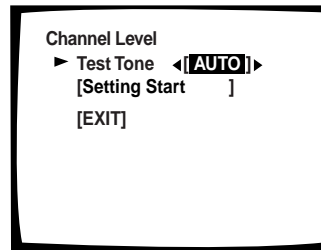

2 Select a TEST TONE mode.

- ① Press ◀ or ▶ to move the hand to AUTO or MANU.
- ② Press ▼ button to select SETTING START.

AUTO (automatic TEST TONE)

This mode switches the test tone between each speaker automatically. Use this mode when balancing the speaker levels by ear.

The automatic test tone is output in the following order :

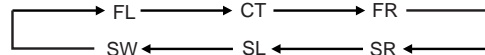

MANUAL (manual TEST TONE)

This mode lets you switch the test tone between each speaker manually. You can use this mode when you want to balance the speaker levels by ear at a more leisurely pace.

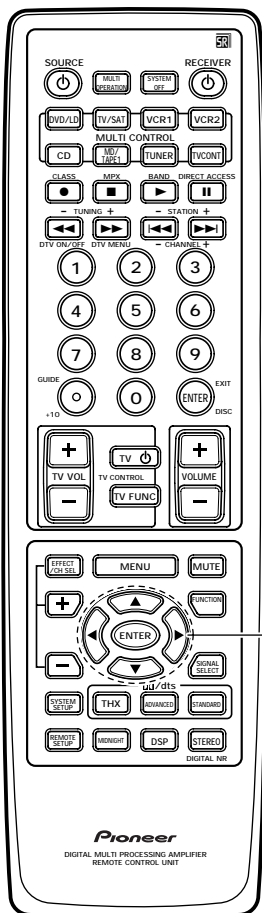

3,4

3 After selecting SETTING START with the ▼ button press ENTER. The TEST TONE will be output.

These settings will be displayed on your TV.

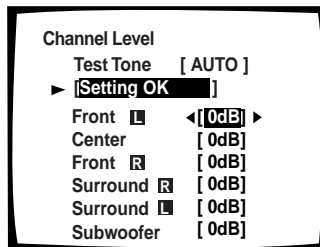

It takes a moment for the machine to set itself. MASTER VOLUME rotates to the reference position (0dB), and the test tone is output.

To exit before outputting the TEST TONE

Press ENTER

To exit while outputting the TEST TONE

Press ENTER.

4 Adjust speaker levels so that you hear the test tone at the same volume from each speaker when seated in your main listening position.

NOTE : The volume of the sub-woofer tends to sound lower than it actually is, you may need to raise its level after testing the sound with actual soundtracks.

In AUTO mode

- ① Press ◀ or ▶ to adjust the level of the speaker outputting the TEST TONE.

In MANU mode

- ① Press ◀ or ▶ to adjust the level of the first speaker.
- ② Press ▲/▼ to switch the TEST TONE to the next speaker.
- ③ Repeat ① and ② for each speaker.

If you are using a Sound Pressure Level (SPL) meter

Take the readings from your main listening position and adjust the level of each speaker to 75 dB SPL (C-weighted/slow model).

5 When you have adjusted each speaker level, press ENTER to return to the previous screen

The MASTER VOLUME will return to its original position.

Next, proceed to CROSSOVER NETWORK below.

If you want to change a setting before proceeding.

Simply use the arrow buttons to go back.

6 Select EXIT with the ▲/▼ buttons and press ENTER to return to the SYSTEM SETUP MENU



It is possible to set channels levels independently for Surround/dts, STEREO, EXTERNAL DECODER and each DSP mode for listening-once purposes (see p.22 ⑥) but if you do so these levels will remain in Surround/dts setup mode unless put back to zero. They will show up the display in step 3.

Crossover Network

The following steps show you how to adjust the crossover network. The crossover network is the frequency at which the system divides the signal and sends the different parts (high, mid, low) to different speakers. Speaking precisely, this setting sets the cutoff point for the bass frequencies rerouted from your SMALL speakers to your sub woofer or speakers set to LARGE. If continuing from CHANNEL LEVEL go to step 1. If starting fresh, complete steps 1-3 in "Setting Up for Surround Sound" (p.24) first.

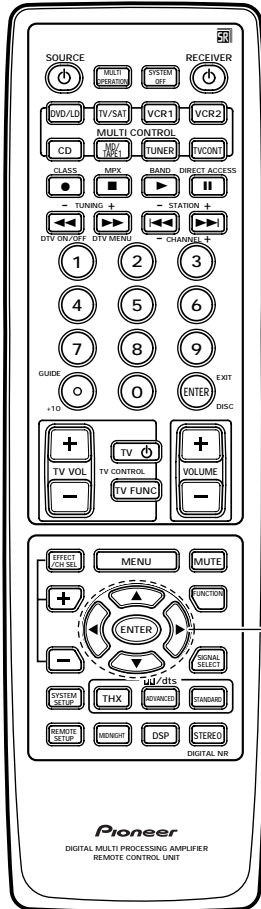

1 Select CROSSOVER NETWORK (if continuing from CHANNEL LEVEL, it will already be selected).

See "Setting Up for Surround Sound" on page 24 if you are unsure how to do this.

Press ENTER.

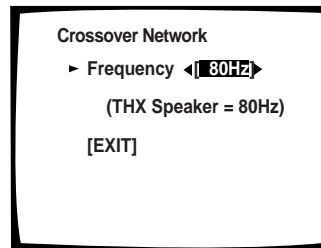

The default setting is 80 Hz.

2 Specify the crossover frequency for your small speakers.

Setting speakers to SMALL in "SPEAKER SETTING" sends the respective channel's bass frequencies to the sub woofer (or LARGE speakers). The present function lets you determine which frequencies will be sent to the sub woofer or LARGE speakers.

- ① Press ◀ or ▶ to move the hand to 80 Hz, 100 Hz, or 150 Hz.
- ② Press ▼.

80 Hz

Sends bass frequencies below 80 Hz to the sub woofer (or LARGE speakers).

100 Hz

Sends bass frequencies below 100 Hz to the sub woofer (or LARGE speakers).

150 Hz

Sends bass frequencies below 150 Hz to the sub woofer (or LARGE speakers).

As noted on your TV screen the THX setting is 80. Select this setting if you have THX approved SMALL speakers.

Experiment with the different settings to see which sounds best to you.

3 Select EXIT to return to the SYSTEM SETUP MENU.

Next, proceed to BASS PEAK LEVEL MANAGER below.

If you want to change a setting before proceeding Select a new crossover frequency.

Bass Peak Level Manager

The LFE (Low Frequency Effect) channel in Dolby Digital or DTS program sources can produce heavily concentrated ultra-low bass tones that may exceed the capabilities of your speaker system. The following steps show you how to set the peak level for the ultra-low bass (LFE) channel. If continuing from CROSSOVER NETWORK go to step 1. If starting fresh, complete steps 1-3 in "Setting Up for Surround Sound" (p.24) first.

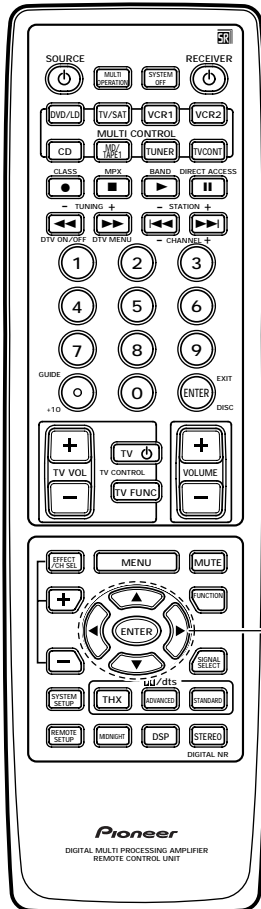

1-3

1 Select BASS PEAK LEVEL MANAGER (if continuing from CROSSOVER NETWORK it will already be selected).

See "Setting Up for Surround Sound" on page 24 if you are unsure how to do this.

Press ENTER.

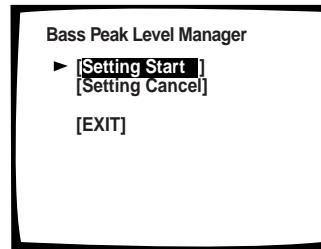

2 Output the test tone for the LFE channel and specify the peak level.

- ① If your sub woofer has a volume control, set it to the middle position before proceeding.
- ② Select SETTING START
- ③ Press ENTER.

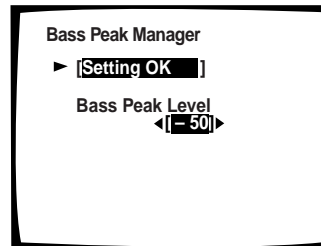

- ④ Use the ◀ or ▶ arrows to gradually increase the level of the LFE channel until the test tone begins to distort. Then go back and leave the level setting at a point just before that. Press ENTER and the receiver will remember this bass output level.

To exit before outputting the TEST TONE
Select EXIT and press ENTER.

To exit while outputting the TEST TONE
Press ENTER.

3 Select EXIT and press ENTER to return to the SYSTEM SETUP MENU.

This completes the speaker setup.



If you select SETTING CANCEL no settings are input to the receiver but the screen remains on the TV. To escape the screen you must press EXIT.

D-Range Control

This feature makes it possible to enjoy full surround sound effects on Dolby Digital sources even at low volumes. It does this by compressing the dynamic range. Dynamic range is the difference between the loudest and the softest sounds in any given signal. Compressing the range plays sounds so the quieter ones are audible and the louder ones don't get distorted or become overpowering. This feature only applies to Dolby Digital sources but the MIDNIGHT LISTENING mode accomplishes the same end for a variety of sources (see p.38). If continuing from BASS PEAK LEVEL MANAGER go to step 1. If starting fresh, complete steps 1-3 in "Setting Up for Surround Sound" (p.24) first.

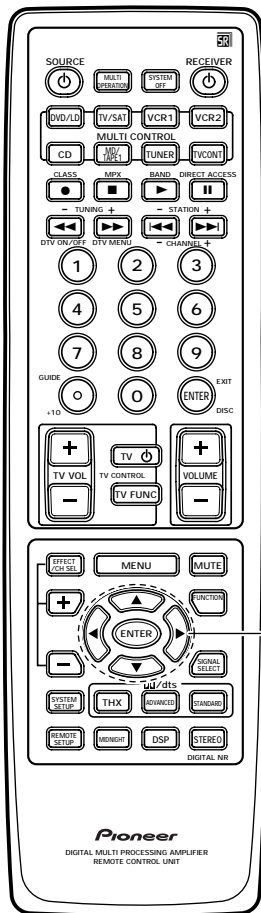

1 Select D-RANGE CONTROL (if continuing from BASS PEAK LEVEL MANAGER, it will already be selected).

See "Setting Up for Surround Sound" on page 24 if you are unsure how to do this.
Press **ENTER**.

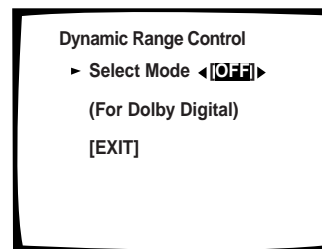

- The default setting is OFF.
- If listening at loud volumes we recommend turning the Dynamic Range Control OFF.

2 Use the ◀ or ▶ arrows to choose OFF, MID or MAX.

3 Select EXIT and press ENTER to return to the SYSTEM SETUP MENU.

If you want to change a setting before proceeding Choose a new DYNAMIC RANGE CONTROL setting. You may need to experiment with different Dolby Digital sources before you can use the DYNAMIC RANGE CONTROL setting to suit your low volume listening needs.

Digital-In Select

In order to be able to use your digital equipment properly you need to assign digital inputs for each of the digital components you connected. Match the Digital 1-4 settings with the digital jacks 1-4 in accordance with what component is hooked up to each digital jack. Check the digital terminal numbers on the back of the receiver to make certain what component is in which jack (if necessary, see p.10 for more on digital connections). The last setting, the AC-3 RF setting, is specifically for a DVD/LD player or LD player with an AC-3 RF output. If you connected one of these components match this button to the component. If continuing from BASS PEAK LEVEL MANAGER go to step 1. If starting fresh, complete steps 1-3 in "Setting Up for Surround Sound" (p.24) first.

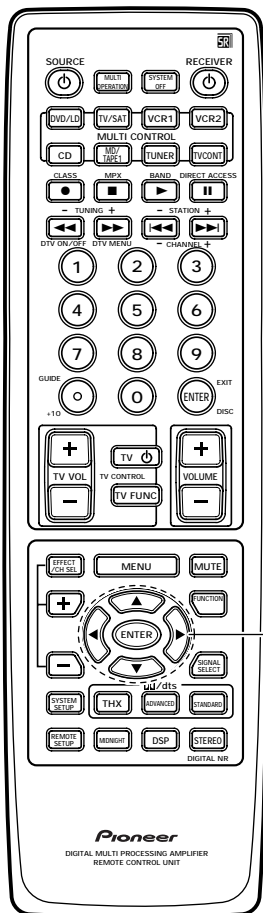

1-3

1 Select DIGITAL-IN SELELCT (If continuing from last set up, it will already be selected).

See "Setting Up for Surround Sound" on page 24 if you are unsure how to do this.

Press ENTER.

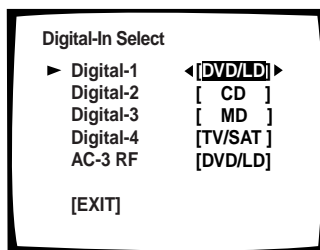

Only the VSX-27TX has an AC-3 RF terminal, see the note on p.10 for other models' AC-3 RF hook up .

2 Choose a DIGITAL IN and assign it an input function.

Use the ◀ or ▶ to choose the input function that matches the component hooked up to that digital terminal.

The possible choices include: DVD/LD,TV/SAT, CD, MD/TAPE 1, VCR 1,VCR 2. You cannot assign digital inputs to the TUNER, VIDEO, PHONO, and TAPE 2 MONITOR functions.

3 Select EXIT and press ENTER to return to the SYSTEM SETUP MENU.

If you want to change a setting before proceeding Simply use the arrow buttons to go back.



- For the Digital 1-4 setting you can choose between DVD/LD, CD, TV/SAT, MD/TAPE 1,VCR 1 and VCR 2 functions.
- For the AC-3 RF setting you can choose between DVD/LD, TV/SAT, VCR 1 and VCR 2 functions.
Remember, if you have a DVD/LD player or LD player you should hook it up to the analog and digital jacks in addition to the AC-3 RF connection described here.
- Once one function (for example DVD/LD) has been assigned its name disappears from the possibilities on the remaining settings because one function cannot be assigned twice.

Playing Sources with Stereo Sound

The following instructions show you how to play audio or audio-visual stereo sources with the VSX-27TX/26TX/24TX.

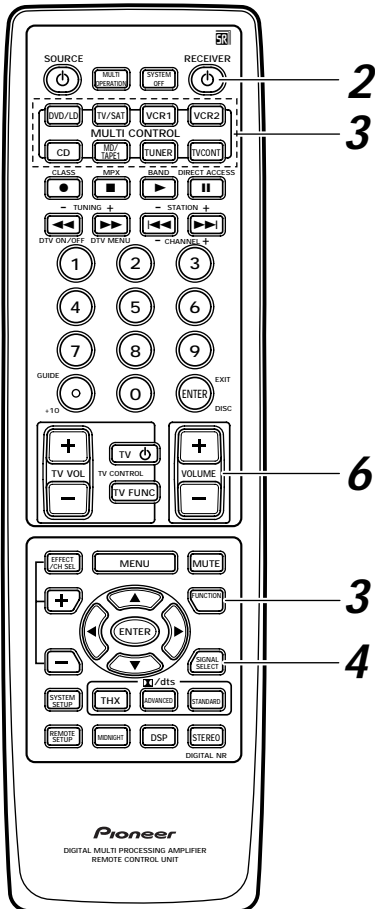

1 Turn on the power of the playback component.

2 Press the **RECEIVER** button to turn on the receiver.

Be sure that the standby indicator turns off on the front panel.

STANDBY indicator

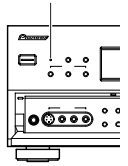

3 Press **MULTI CONTROL** buttons or the **FUNCTION** button to select the source you want to playback.

The **FUNCTION** button cycles through the sources in the following order:



4 Press **SIGNAL SELECT** on the remote control or **SIGNAL SELECT** on the front panel to select the input signal corresponding to the source component.

(See "Switching ANALOG/DIGITAL signal input" on p. 40.)

5 Start playback of the component you selected in step 1.

6 Adjust the volume by using the volume buttons on the remote control or the **MASTER VOLUME** on the front panel.

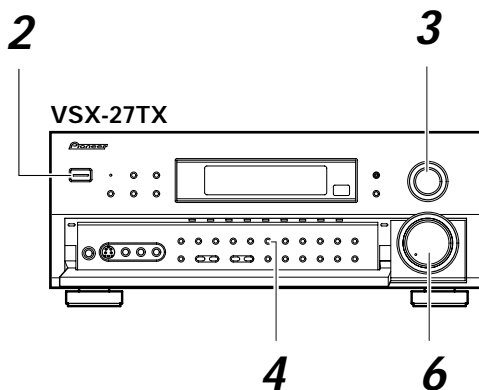

If you are not able to get sound from the receiver the problem may well lie with the **SIGNAL SELECT** switch. You need to make sure the input is set to the appropriate **ANALOG** or **DIGITAL** setting. Refer to page 40 for more on this.

Sound Modes

The five sound modes on the VSX-27TX/26TX/24TX are explained here. These can be turned on from the front panel or from the remote control.

There are three cinema modes: STANDARD, HOME THX CINEMA, and ADVANCED THEATER. These are designed to be used with multi channel surround sound audio/visual sources (like DVDs and LDs). Intrinsic to home theater, these modes can deliver realistic and powerful surround sound that recreates the movie theater experience. You may need to experiment with them to see which settings suit your home system and personal tastes.

The DSP and STEREO modes are designed to be used with music sources but some DSP modes are also suited for film soundtracks. Again, try different settings with various soundtracks to see which you like.

You must choose one of the three cinema modes or the DSP mode in order to get surround sound. In STEREO mode only the front two speakers are used.

STANDARD mode

This mode is for pure decoding of Dolby Digital, DTS and Dolby Pro Logic. No special effects are added. It is good for enjoying movies that have been recorded in Dolby Digital, DTS or Surround.

HOME THX CINEMA mode

THX is a set of technical standards created by Lucasfilm, Ltd. These standards were designed to emulate a film sound stage and thus reproduce, with the greatest possible accuracy, the soundtrack intended by the filmmakers.

For more detailed information see p. 74

ADVANCED THEATER modes

The Advanced Theater mode is a newly designed system for enhancing movie soundtracks and other audio-visual sources. It incorporates the use of DTS (Digital Theater System) as well as Dolby Digital into its sound processing. These functions switch on automatically when the source you are playing is encoded with DTS, Dolby Pro Logic or Dolby Digital (bearing the  logo). There are four Advanced Theater settings that use DSP (Digital Signal Processing) to create different types of sound environments.

MUSICAL

This mode is primarily for music and adds a spacious feeling to the sound. A long delay time of reflected sounds, provides resonant tones which emulate a concert hall.

DRAMA (CINEMA)

This mode is designed for movies with a lot of dialog. The elements of dialog are enhanced, making the characters seem more real. The mode also compresses the dynamic range somewhat so loud sounds do not overpower softer ones (compare this with the MIDNIGHT mode explained on p.41).

ACTION

This mode is designed for action movies, which generally use lots of sound effects. The mode enriches the sound to make it more realistic and extends the parameters to pick up high and low sound effects.

5-D THEATER

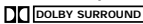
This mode is especially designed to give sound depth to stereo sources. The overall effect builds a dynamic and broad sound space, allowing two-channel (stereo) signals to faithfully imitate a five speaker sound. The mode should be used in conjunction with Dolby Pro Logic for sources bearing the  mark.



When a Dolby Digital soundtrack is played back the Dialog Normalization function of the receiver activates automatically. Dialog Normalization is a Dolby Digital function that establishes the average dialog level for the program source being played. If the receiver's level does not match the average dialog level, first you see "DIAL. NORM" flash in the receiver's display and next OFFSET +4 dB (as an example) will appear. The number +4 dB is the difference between the receiver's gain structure and the Dolby Digital average dialog level. To match the average dialog level, subtract or add the OFFSET level. For example, if the OFFSET level is +4 dB, the amplifier's output is 4 dB over the average recorded level.

DSP modes

The DSP (Digital Signal Processing) modes allow you to transform your living room into a variety of different sonic environments when playing either two-channel or multi-channel sources.

HALL 1

Simulates the acoustic effects of a large concert hall. Suitable for classical music.

A long delay time of reflected sounds, coupled with reverb effects, let the listener enjoy the dynamic and rich sounds characteristic of concert halls and powerful orchestral performances.

HALL 2

Simulates the acoustic environment of a very resonant concert hall. Rich reverberation and a full sound create the impression of a lively performance space.

JAZZ

Simulates the acoustic effects of a jazz club. Reflected sound is virtually below 100 msec so that the listener can enjoy a live band effect.

DANCE

Simulates the acoustic effects of a dance club. Features a strong bass sound.

Reflected sound delay time is virtually below 50 msec, for the listener to enjoy the visceral power of dance music.

THEATER 1

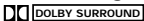
Reproduces theater sound field effects without losing the localization of each channel. Theater effects can be enjoyed without losing Dolby Digital/ Pro Logic effects when used in combination those formats (with movies bearing the  trademark).

THEATER 2

Simulates the acoustic environment of a theater while maintaining proper localization of each channel.

Stereo mode

Use the STEREO mode to enjoy standard (two-channel) stereo sound from the front left and right speakers.

This mode also allows you to :

- Use the BASS and TREBLE tone controls
- Use DIRECT for truer reproduction of the original recording.
- Use DIGITAL NR.

See display explanations on p.17 and front panel explanations on p.18-21 for details on SPEAKERS (A/B) , BASS (-/+), and TREBLE (-/+). See p. 41 for DIGITAL NR explanation.



When listening to Dolby Digital or DTS sources, DIGITAL NR does not function even if you select STEREO.

Selecting a Sound Mode

To ensure the best possible surround sound, be sure to complete the set up procedures described in "Setting Up for Surround Sound" (starting on page 24) before using the sound modes. This is particularly important when using the  (Dolby) Digital or DTS sources. When using the sound modes, using SPEAKERS A will give the best results. If you use SPEAKERS B the sound will be down mixed to the two front B speakers and the surround sound effect will be lost.

Surround operation

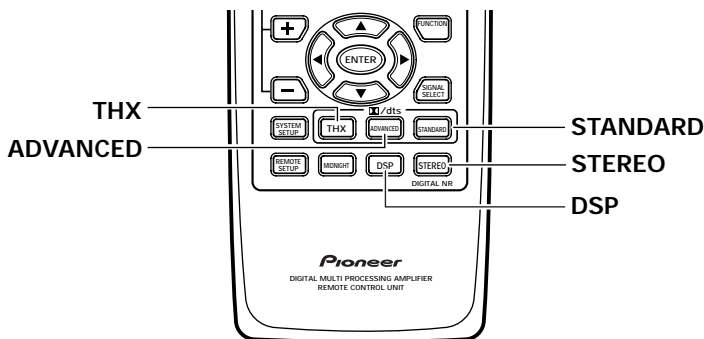

1 Select the sound mode.

- For HOME THX CINEMA ➔ Press THX
 - For ADVANCED THEATER ➔ Press ADVANCED THEATER
- Each press changes the ADVANCED THEATER mode as follows:

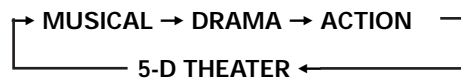

- For STANDARD ➔ Press STANDARD
 - For DSP modes ➔ Press DSP repeatedly
- Each press changes the DSP mode as follows:

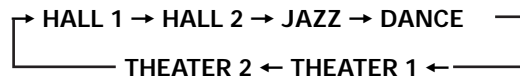

- For STEREO ➔ Press STEREO

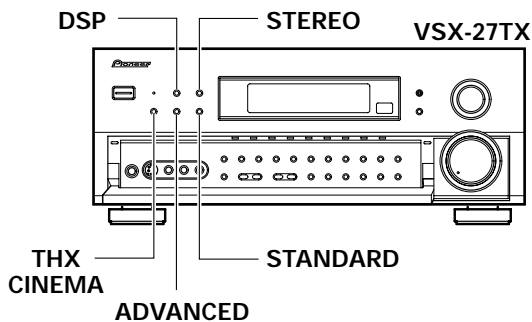

- The effects of ADVANCED THEATER mode can be adjusted in the range of 10 to 90 by pressing EFFECT +/- (The default setting is 70). Also, the effect level can be set in each ADVANCED THEATER mode by pressing the EFFECT(-/+) button. 5-D THEATER modes cannot be changed.
- The amount of effect of each DSP mode can be adjusted in the range of 10 to 90 (the default setting value is 70) by pressing EFFECT +/-.
- When a digital input is selected, using some discs with a huge amount of information may cause the overload indicator to light up. If the overload indicator is lit in the THX, ADVANCED THEATER and DSP mode, the signal may be distorting. To ensure there's no distortion you can switch to the STANDARD mode.

Playing Sources with Dolby Digital or DTS Sound

The following instructions show you how to play Dolby Digital or DTS sound sources with the VSX-27TX/26TX/24TX.

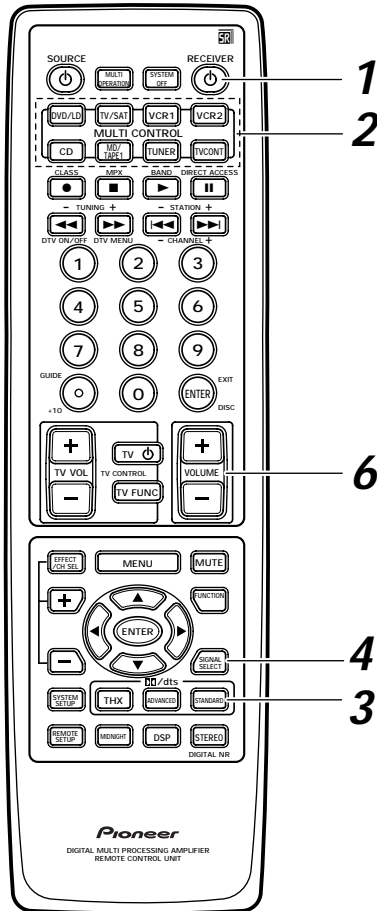

1 Turn on the receiver.

2 Press the function button of the component (DVD/LD etc.) you want to listen to/watch.

You can only use this remote to control the component if it's made by PIONEER. For all other makers you need to setup the remote specifically to control your component (See p. 48).

3 Choose a sound mode by pressing THX, ADVANCED THEATER or STANDARD.

The default setting is STEREO.

(For more see "Sound Modes" p. 36-37.)

4 Press SIGNAL SELECT on the remote control or SIGNAL SELECT on the front panel to select the input signal corresponding to the source component (VSX-27TX can be set to AUTO, while the VSX-26TX/24TX should be set to DIGITAL).

(See "Switching ANALOG/DIGITAL signal input" on p. 40.)

5 Play a source (for example, a DVD player).

6 Adjust the volume by using the volume buttons on the remote control or the MASTER VOLUME on the front panel.

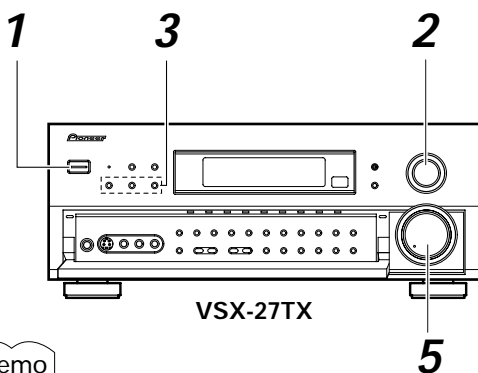

We recommend using different modes for different types of DTS material. For watching movies, the THX or ADVANCED THEATER setting should provide the best results. For listening to music, the STANDARD, DIRECT, STEREO, or DSP modes should serve the listener best.



VSX-26TX and VSX-24TX models :

When playing LD recorded in Dolby Digital

When connecting a DVD/LD player or LD player using the AC-3 RF output, a commercially available RF demodulator (RFD-1) is required. The RF demodulator changes the RF signal to a digital signal which is then processed by the receiver at the digital input jacks. For more details, refer to the instruction manual supplied with the RFD-1.

Refer to pages 72, 73 for explanations of Dolby Digital, Dolby Pro Logic, and DTS.

VSX-27TX model :

Make sure you connect your DVD/LD or LD players using the AC-3 RF jack. If your player has an AC-3 RF output this will ensure you can use all LDs. Refer to pages 10, 11 and 34.

Switching ANALOG/DIGITAL Signal Input

This switch moves the input fed to the receiver between analog, digital and AC-3RF (VSX-27TX only) sources. You need to take special care to switch to the appropriate input, when necessary. For example, the switch would have to be on digital to use DOLBY DIGITAL or DTS surround sound but it would have to be on analog to record to the analog out jacks on the receiver. On the VSX-27TX the default setting is AUTO (which chooses digital when all three are available but goes with whatever is available if it is the only choice). On the VSX-26/24TX the default setting is ANALOG.

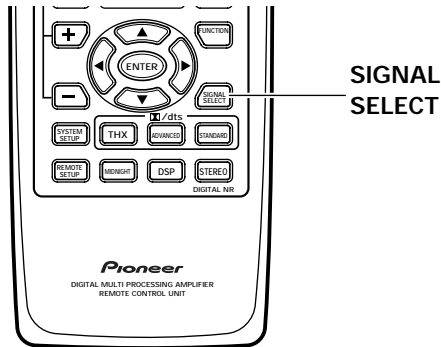

1 Press SIGNAL SELECT on the remote control or SIGNAL SELECT on the front panel to select the input signal corresponding to the source component.

Each press switches the signal in the order below:

VSX-27TX model

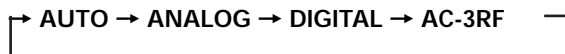

VSX-26TX/24TX models



2 When SIGNAL SELECT is set to DIGITAL, AC-3 lights when a Dolby Digital signal is input, and DTS lights when a DTS signal is input

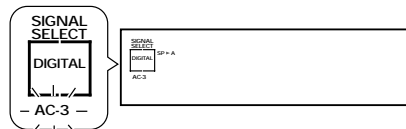

When a Dolby Digital signal is input.

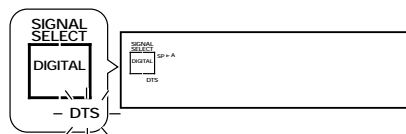

When a DTS signal is input.

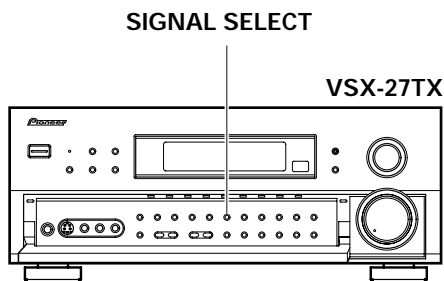

- In the AUTO setting (VSX-27TX only), SIGNAL SELECT chooses the signal in the following order: AC-3 RF, DIGITAL, ANALOG.
- If the Digital-In Select (see p.34) choices are set to OFF, the SIGNAL SELECT will default to ANALOG.
- Because the audio from a karaoke microphone and LD recorded with analog audio only is not output from the digital output, set SIGNAL SELECT to "ANALOG".
- This receiver can only play back Dolby Digital, PCM (32kHz, 44kHz, 48kHz, and 96kHz), and DTS digital signal formats. It cannot play back digital signals other than these so for those kinds of formats you'll have to play them back in an analog manner (making sure your equipment is hooked up with analog connections and setting the SIGNAL SELECT to "ANALOG").
- When an LD or CD with DTS is played back with the SIGNAL SELECT set in "ANALOG," digital noise caused by playing back the DTS directly (with no decoding) is output. To prevent noise, you need to make digital connections (See p. 10, 11) and set SIGNAL SELECT to "DIGITAL" (VSX-27TX could also be set to "AUTO").
- Some DVD players don't output DTS signals. For more details, refer to the instruction manual supplied with your DVD player.

Reducing noise during playback (DIGITAL NR function)

To reduce extraneous noise switch on DIGITAL NR. This noise reduction can only be used in the STEREO mode.

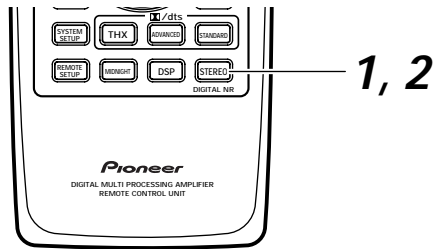

1 Press **STEREO** on the remote control or on the front panel.

2 Press **DIGITAL NR** on the remote control or on the front panel.

Each press switches DIGITAL NR on or off.



- When DIGITAL NR is on and Dolby Digital or DTS signals are input, DIGITAL NR is automatically switched off.
 - In cases described below, noises may not be reduced even if DIGITAL NR is on.
 - Sudden noise
 - Extremely loud noise
 - Signals that do not contain many high frequencies
 - For each source, DIGITAL NR is effective at and above levels shown below.
 - Cassette tape 20 dB
 - Video tape 15 dB
 - AM tuner 10 to 15 dB
 - FM tuner 15 to 16 dB
- * Depending on the condition of the source, there may not be a noticeable improvement in the quality of the sound.

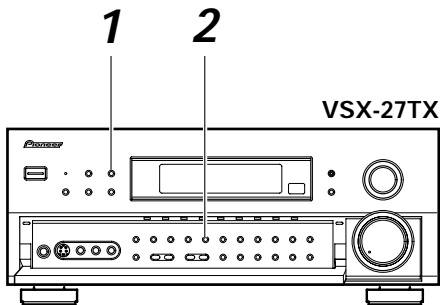

Listening in MIDNIGHT LISTENING Mode

This feature makes it possible to get excellent surround sound effects even when listening at low volumes. It can be used with a variety of surround sound sources and plays soundtracks so that the quieter sounds are audible while the noisier sounds don't become overly loud or distorted. It does this by bringing all the sounds in a given soundtrack closer together in volume. Compare this feature with the D-Range Control (only for Dolby Digital sources) on p. 33.

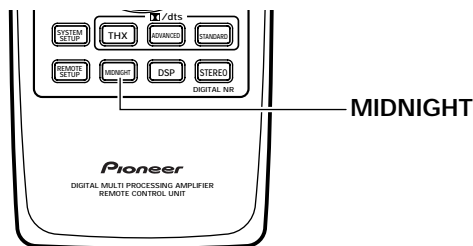

Press MIDNIGHT.

Each press switches MIDNIGHT LISTENING mode on or off.



- The effect adjusts itself automatically in accordance with the volume level.
- You can't use the MIDNIGHT LISTENING mode with the THX, DIRECT or EXTERNAL DECODER modes.

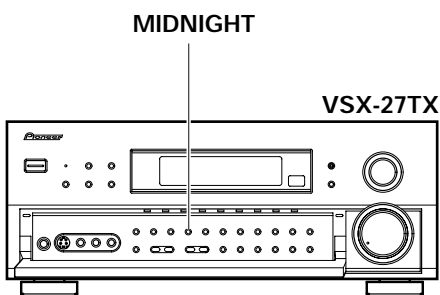

External decoder playback

This feature allows you to connect an external decoder to enjoy certain types of specialized sources.

Press EXTERNAL DECODER IN.

Each press switches the input between the previous mode and EXTERNAL DECODER.

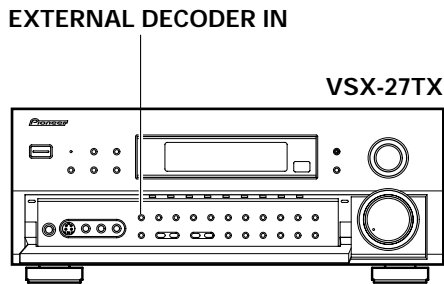

When EXTERNAL DECODER is selected only the volume level and channel levels can be set. All of this unit's other features (DSP modes, ADVANCED THEATER modes, DIRECT mode, TONE controls, etc.), as well as the TUNER and PHONO modes, cannot be used. Also, all speaker settings and other setup settings have no effect.

96kHz 24bit Performance

This receiver is capable of playing back advanced DVD discs which are recorded in 96kHz/24 bit format (these are all stereo discs). The receiver will automatically read the format of the disc and play accordingly (of course the SIGNAL SELECT will have to set to AUTO (VSX-27TX only) or DIGITAL to read the DVD soundtrack). When the receiver plays a 96 kHz/24 bit disc "96 kHz" appears in the display. If you try to use one of the functions or modes mentioned below "96kHz" will light on the display, as shown below, indicating the procedure is not possible.

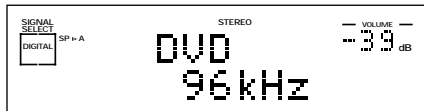

- When a 96kHz/24 bit disc is played back the volume may be louder than that of a normal disc.
- Some DVD players cannot play 96kHz/24 bit discs. Check the manual of your DVD player to make sure.
- During this playback you cannot use the tone controls, the DIRECT function, the LOUDNESS function, any of the sound modes, or any of the effect modes.
- With 96kHz/24 bit discs you are able to use 5.1 ch EXTERNAL DECODER playback and the TAPE 2 MONITOR.

Listening in LOUDNESS Mode

The LOUDNESS mode allows you to boost the bass in a signal. It is useful for listening to music at low volumes.

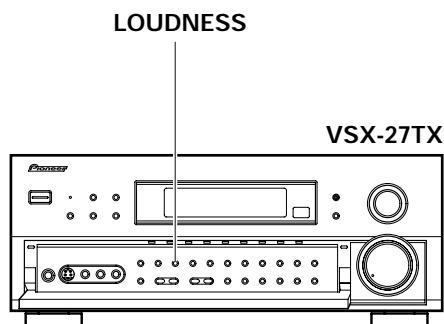

Press LOUDNESS.

Each press switches LOUDNESS mode on or off.



You can't use the LOUDNESS mode with the THX, DIRECT or EXTERNAL DECODER modes.

Adjusting bass and treble (tone control)

Use BASS (-/+) or TREBLE (-/+) to adjust the low and high frequencies (the receiver must be in STEREO mode).

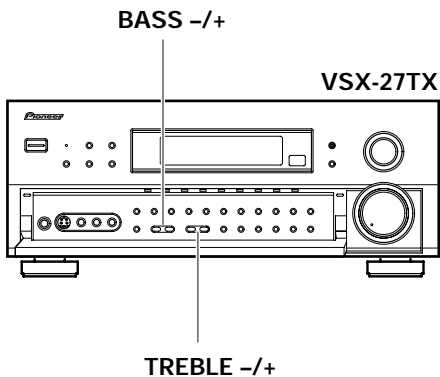

Press **BASS (-/+)** to adjust the low frequencies.



Press **TREBLE (-/+)** to adjust the high frequencies.



- The tone control can be adjusted in a range of ± 6 dB.
- The tone control cannot be adjusted in STANDARD, ADVANCED THEATER modes as well as DSP, THX, EXTERNAL DECODER, DIRECT, and 96kHz settings.

Direct playback

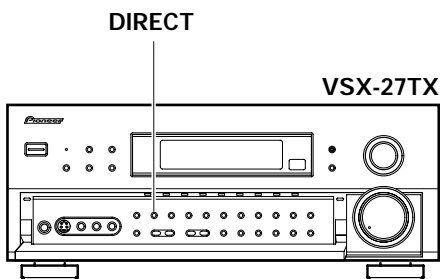

Press **DIRECT** to put the receiver in DIRECT mode.

This mode will give you the most accurate reproduction of two channels sources.



- None of the tone controls or other sound modes can be used.

Adjusting the brightness of the display (front panel only)

Use the FL DIMMER button to adjust the brightness of the fluorescent display (FL=fluorescent display).

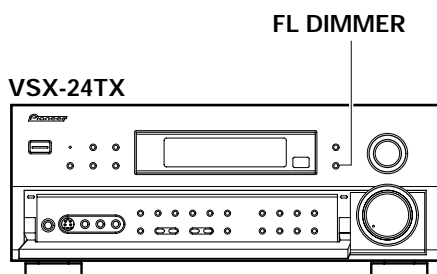
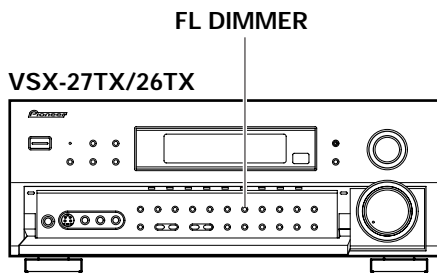

Press **FL DIMMER**.

Four levels of brightness ranging from very dim to very bright can be selected. Each press changes the brightness of the display. When rotating through the options, the default brightness can also be selected.



Please note: it is a feature of this unit that the fluorescent display will be brighter for a few seconds after you choose a function (like DVD/LD, CD, etc.) and then get softer. This will still happen when you adjust the brightness but the new setting will be the one the display softens to.

Automatic and Manual Tuning

The following steps show you how to tune in FM and AM radio broadcasts using the automatic (search) and manual (step) tuning functions. If you already know the exact frequency of the station you desire, see "Direct Access Tuning" on the following page.

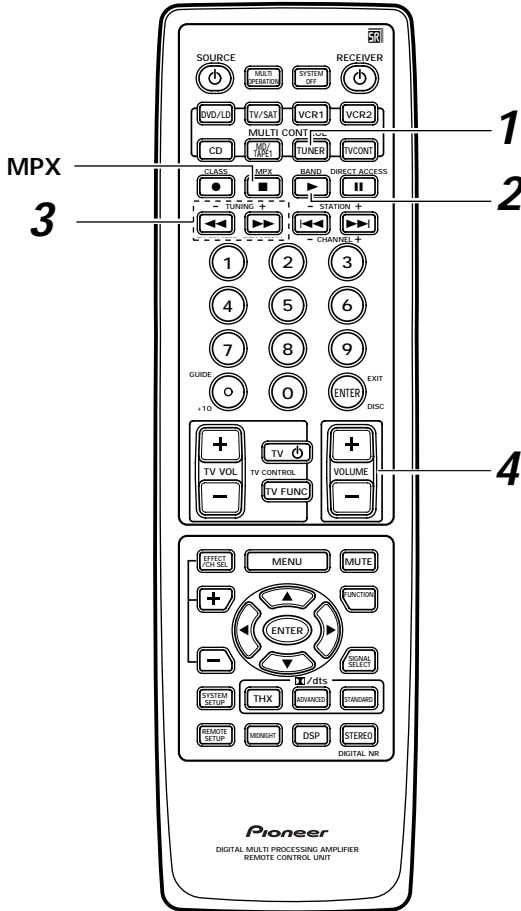

- 1 Press the TUNER button.**
On the remote, this selects the TUNER function on the receiver and sets the remote to the TUNER operation mode.

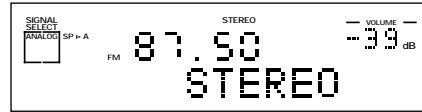

- 2 Press BAND button on the remote or the FM/AM button on the front panel to select the band (FM or AM).**

Each press switches the band: FM ↔ AM

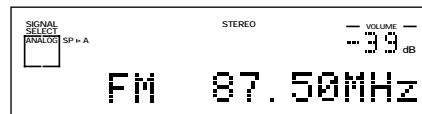

- 3 Tune in the station.**
For Automatic Tuning
 Press and hold TUNING +/- for about one second, then release.
 The tuner starts searching the selected band and stop automatically at the first station it locates. Repeat to locate other stations.
For Manual Tuning
 - To change frequencies one step at a time, press TUNING +/- repeatedly.
 - To change frequencies quickly, hold down TUNING +/- and release when you reach the frequency you desire.

- 4 Adjust the volume.**

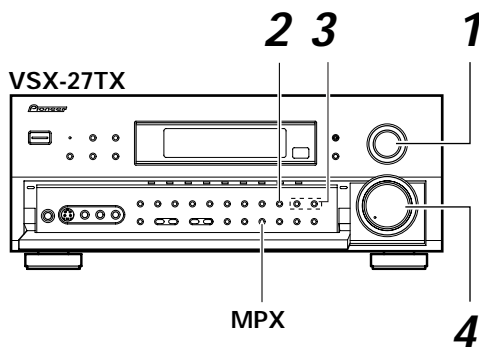

MPX Mode

If the TUNED or STEREO indicators do not light when tuning an FM station, because the station is too far away or the broadcast signal is weak, press MPX on the remote control or front panel to switch to MONO reception. This should improve reception enough for you to enjoy the broadcast.

Direct Access Tuning

The following steps show you how to tune directly to a specific frequency using the remote control.

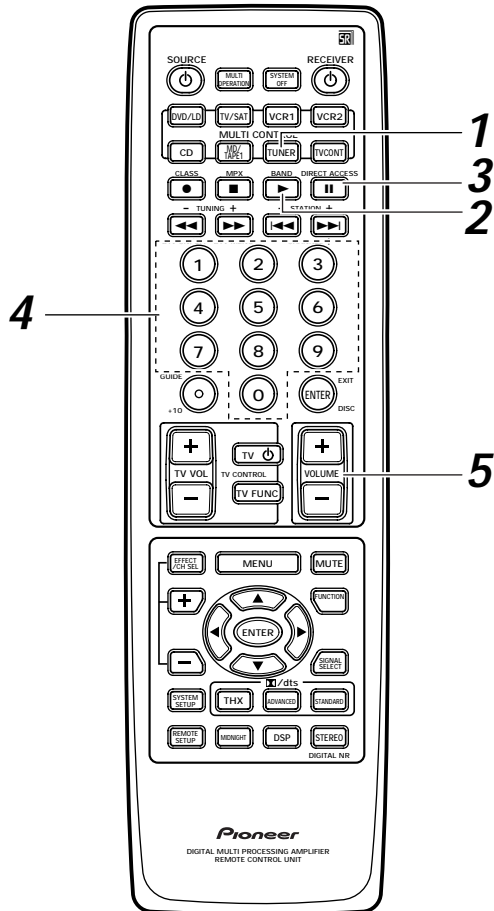

1 Press TUNER.

This selects the TUNER function on the receiver and sets the remote to the TUNER operation mode.

The previously tuned station is received automatically.

2 Press BAND button on the remote or the FM/AM button on the front panel to select the band (FM or AM).

Each press switches the band : FM ↔ AM

3 Press DIRECT ACCESS to activate the direct Access tuning mode.

The cursor blinks in the display on the front panel.

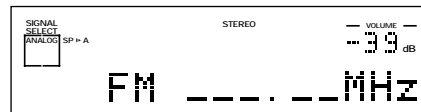

4 Use the number buttons to enter the frequency of the station you want.

Example:

To tune station 106.00 (FM), press:

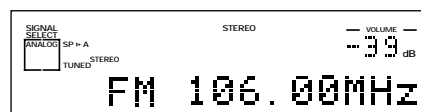

To cancel before inputting the frequency

Press DIRECT ACCESS, and enter the frequency again.

5 Adjust the volume.

Memorizing Frequently Used Stations

The following steps show you how to memorize up to 30 radio stations in 3 classes (each holding 10 channels). When memorizing FM frequencies, the receiver also memorizes the MPX mode (STEREO or MONO).

Using the front panel

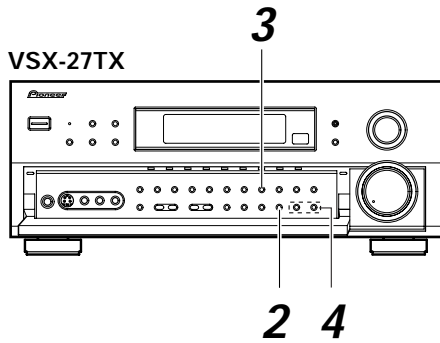

1 Tune in the desired station.

See "Automatic and Manual Tuning" or "Direct Access Tuning" on pages 44 and 45.

2 Press MEMORY to activate the memory function.



3 Press CLASS repeatedly to select a class number. Each press switches the display:

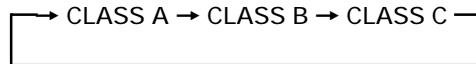

4 Press STATION +/- repeatedly to select a channel (0-9) within the respective class.

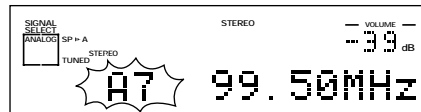

The station is memorized automatically after 5 seconds.

If you want to escape from MEMORY mode
Press the MEMORY button again.

Repeat steps 1 through 4 to memorize up to 30 stations.

Recalling Memorized Stations

Using the remote control

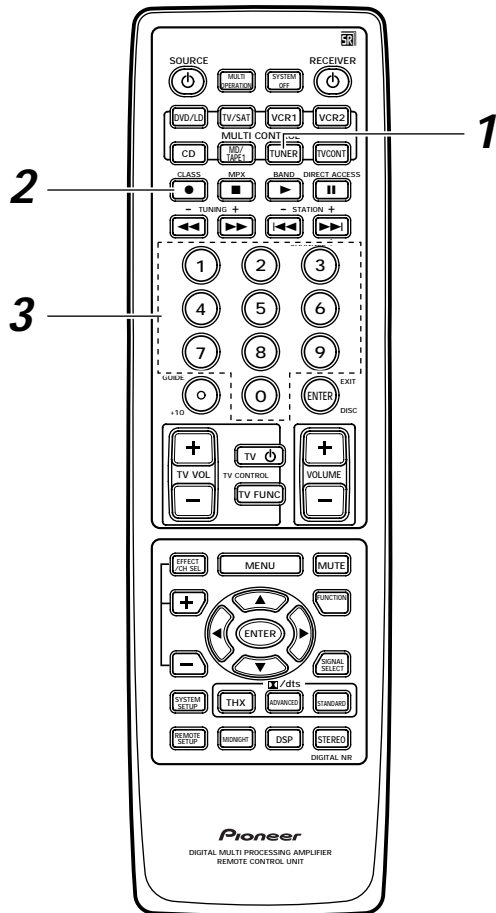

1 Press TUNER.

This selects the TUNER function on the receiver and sets the remote to the TUNER operation mode.

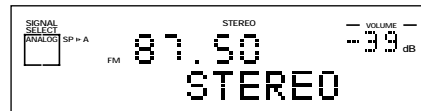

2 Press CLASS repeatedly to select a class number.

Each press switches the display:

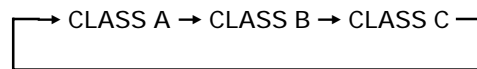

3 Use the number buttons to select the channel you want.

To select channel 7, press **7**.

To select channel 0, press **0**.

For example : If 99.50 MHz (FM) was memorized in class A at channel 7.

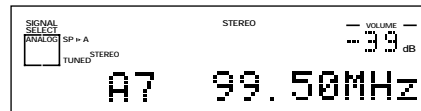

To skip through each channel in order

Press STATION -/+ repeatedly.

Using the front panel

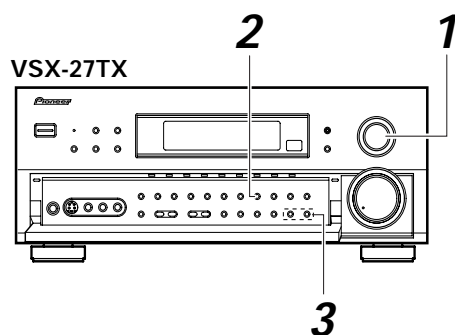

1 Select the TUNER function.

2 Press CLASS repeatedly to select a class number.

3 Press STATION -/+ repeatedly to select the channel you want.

Remote Control of Other components

Setting Up the Remote Control to Control Other Components

In addition to controlling the receiver, the supplied remote control can operate your other components (VCR, TV, LD, CD, etc.) after you program it to do so. In this way, instead of fumbling with many different controls and buttons, you only need to use one remote control. If your component(s) are listed in the remote control's memory, simply follow the steps below. If your component(s) are not listed, or if you want the remote to learn additional operations, you can use the learning mode to input the information from the remote controls supplied with your other components.

Recalling preset codes

The following steps show you how to recall preset codes stored in the remote control. Once a preset code is recalled and the component assigned, you can use this remote to easily operate the component.



See "Preset Code List" on p. 75 for the components and manufacturers available.

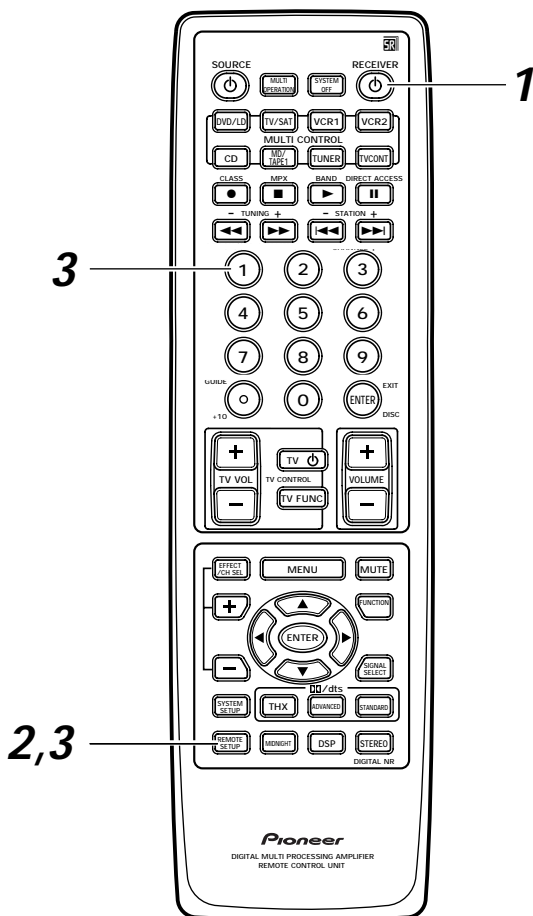

1 Turn on your TV and the receiver.
Make sure your TV is set to the appropriate video input (e.g. VIDEO 1).

2 Press REMOTE SETUP.
The REMOTE SET UP menu appears on your TV screen.

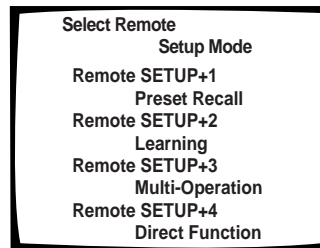

You have four set up options:

- ① PRESET RECALL
- ② LEARNING
- ③ MULTI OPERATION (See p.63)
- ④ DIRECT FUNCTION (See p.65)

PRESET RECALL and LEARNING are the two modes that teach the remote control to operate your other components. It's easiest to start with PRESET RECALL and, if set up isn't possible for certain components, move on to the LEARNING mode.

3 Press REMOTE SETUP and ① at the same time to select the PRESET RECALL SETUP mode.

All the MULTI CONTROL buttons (except the TUNER button) start to blink.

To cancel the PRESET RECALL SETUP mode
Press REMOTE SET UP.

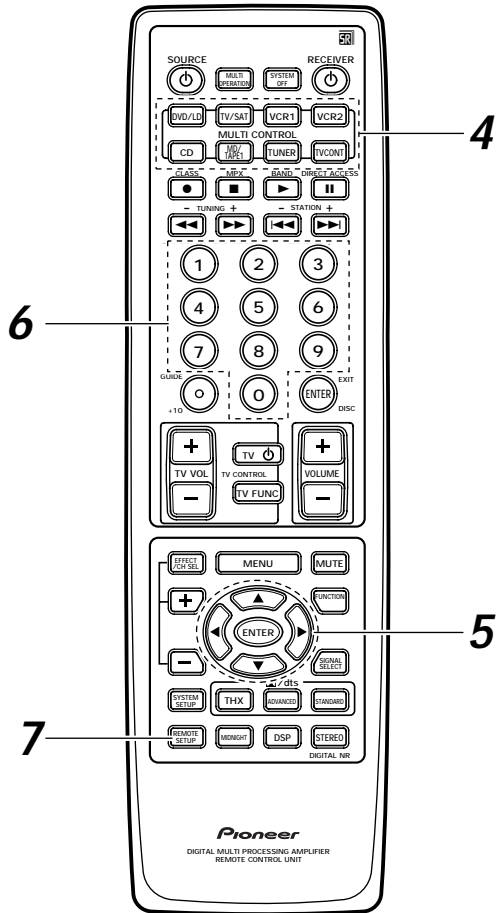

4 Press the MULTI CONTROL button for the component you want to control.

The selected button lights steadily and the first manufacturer (and preset code(s)) appear on your TV screen.

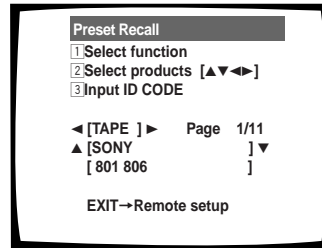

5 Press the ◀/▶ buttons to choose the function and then press the ▲/▼ buttons repeatedly to display the name of the component's manufacturer.

Most manufacturers have been programmed into the receiver, but if your component is made by a small or relatively unknown manufacturer you may not be able to find it.

6 Point the remote toward the component to be controlled, enter the 3 digit setup code.

When you enter the setup code, the remote emits a power ON/OFF signal. If the component turns ON or OFF, you have entered the proper code.

If the component does not turn ON or OFF and there is more than one setup code, try inputting another code (starting again from step 4). Some manufacturers use several sets of remote control signals and the first code may not correspond to your component.

Repeat steps 4 through 6 to assign preset codes for as many components as necessary.

If you can't get your component to respond to any of the codes you can still program the component into the remote control using the procedure in the next section.

7 Press REMOTE SETUP to exit the PRESET RECALL SETUP mode.

The remote control and TV return to their previous operation modes.

Learning mode: Programming signals from other remote controls

If preset codes are not available for your component(s), or the available preset codes do not operate correctly, you can use this function to program in signals from the remote control(s) of your other component(s). This operation can also be used after recalling a preset code to program additional operations not covered in the preset codes.

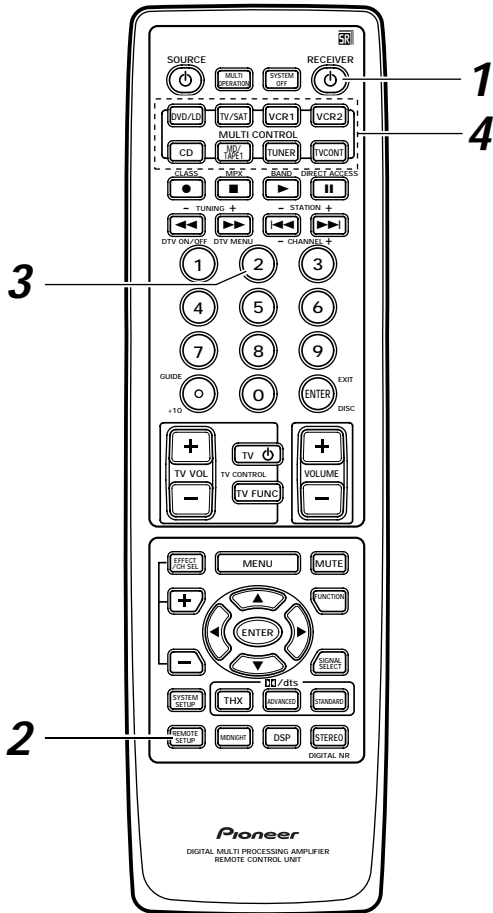

1 Turn on your TV and the receiver.
Make sure your TV is set to the appropriate video input (e.g. VIDEO 1).

2 Press REMOTE SETUP.
The REMOTE SET UP menu appears on your TV screen.

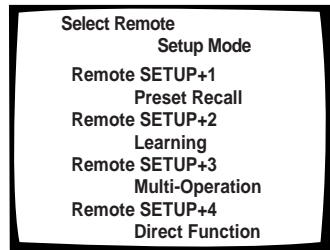

3 Press REMOTE SETUP and 2 at the same time to select the LEARNING SETUP mode.

All the MULTI CONTROL buttons (except the TUNER button) start to blink.

To cancel LEARNING SETUP mode
Press REMOTE SET UP.

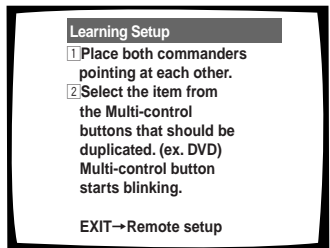

4 Press the MULTI CONTROL button for the component you want to control.
Each button can be set to control one of the following components
The selected button continues to blink.

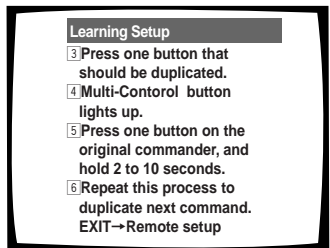

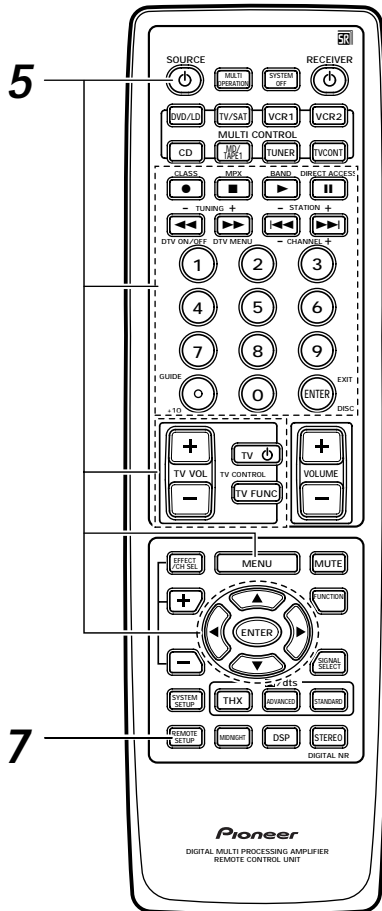

5 Press the button to be programmed.

The MULTI CONTROL button lights steadily.

- The TV POWER, TV FUNC and TV VOL +/- buttons are only available for learning when programming TV CONTROL operations.

6 Point the remote controls at each other and press the button on the other remote control for the operation you wish to program .

- ① Point the remote controls toward each other.

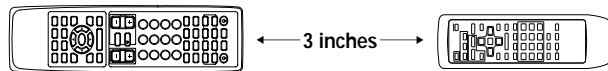

- ② Hold down the button on the other remote control corresponding to the operation you wish to program. Release when the MULTI CONTROL button on the receiver's remote control starts blinking. (The MULTI CONTROL button blinks to indicate that the operation has been learned.)

To program additional operations for the current component
Repeat steps 5 and 6.

To program operations for another component
Repeat steps 4 through 6.

7 Press REMOTE SETUP to exit the LEARNING SETUP mode.

The remote control and TV return to their previous operation modes.

Using Remote Control with Other Components

DVD or LD player operations



- The following operations are available from the receiver's remote control after you program your DVD or LD player's preset code, but some operations may need to be learned by the receiver (see "Setting Up the Remote Control to Control Other Components," p. 48-51).
- To perform these operations, press the DVD/LD button to set the remote to the DVD or LD operation mode.
- For more information on individual commands consult the manual that came with the component.

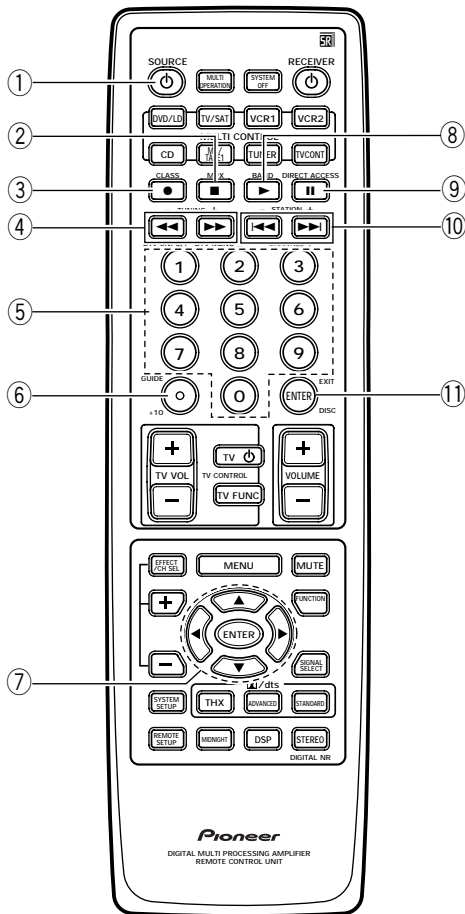

- ① **SOURCE**
Press to switch the DVD or LD player on or off.
- ② **■**
Press to stop playback.
- ③ **● (TOP MENU)**
Press to call up the menu programed on the DVD (for DVD only).
- ④ **◀◀/▶▶**
◀◀ : Hold down for fast reverse playback.
▶▶ : Hold down for fast forward playback.
- ⑤ **Number buttons**
Use to select chapters (tracks).
- ⑥ **+10**
Use when selecting chapter (track) numbers higher than 10.
- ⑦ **▲/▼/◀/▶/ENTER**
▲/▼/◀/▶ : Use to navigate through options on menu screens and to change settings.
ENTER : Use to implement settings selected with the cursor buttons or to set items highlighted in a menu (for DVD only).
- ⑧ **▶**
Press to start playback.
- ⑨ **||**
Press to pause playback.
- ⑩ **◀◀/▶▶**
◀◀ : Press to return to the beginning of the current chapter (track). Press repeatedly to return to the beginning of previous chapters (tracks).
▶▶ : Press to advance to the beginning of the next chapter (track). Press repeatedly to advance to the beginning of following chapters (tracks).
- ⑪ **ENTER (SIDE A/B)**
Use to change the LD between sides A and B (for LD only).

VCR & DVD video recorder operations



- The following operations are available from the receiver's remote control after you program your VCR or DVD video recorder's preset code, but some operations may need to be learned by the receiver (see "Setting Up the Remote Control to Control Other Components," p. 48-51).
- To perform these operations, press the VCR 1 or VCR 2 button to set the remote to the VCR, DVD video recorder operation mode.
- For more information on individual commands consult the manual that came with the component.

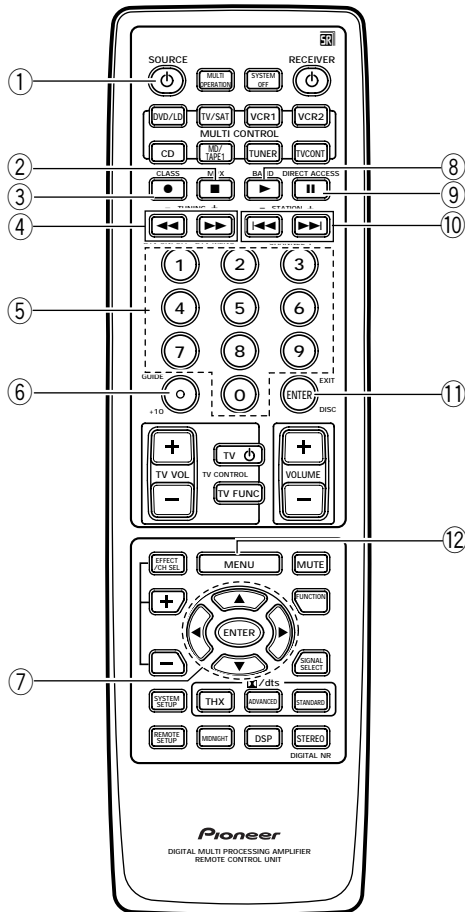

- ① **SOURCE**
Press to switch the VCR or DVD video recorder on or off.
- ② **■**
Press to stop playback.
- ③ **●**
Press to start recording.
- ④ **◀◀/▶▶**
◀◀ : Hold down for fast reverse playback.
▶▶ : Hold down for fast forward playback.
- ⑤ **Number buttons**
Use to select channels.
- ⑥ **+10**
Use when selecting chapter (track) numbers higher than 10 (for DVD video recorder only).
- ⑦ **▲/▼/◀/▶/ENTER**
▲/▼/◀/▶ : Use to navigate through options on menu screens and to change settings.
ENTER : Use to implement settings selected with the cursor buttons or to set items highlighted in a menu (for DVD video recorder only).
- ⑧ **▶**
Press to start playback.
- ⑨ **||**
Press to pause playback.
- ⑩ **CHANNEL -/+**
Use to change channels on the VCR's tuner.
- ⑪ **ENTER (TV/VCR)**
Use this button to switch the VCR between it's tuner (for watching videos) and the TV.
Press to stop recording (for DVD video recorder only).
- ⑫ **MENU**
Use to display or close the title menu screen (for DVD video recorder only).

CD player operations



- The following operations are available from the receiver's remote control after you program your CD player's preset code, but some operations may need to be learned by the receiver (see "Setting Up the Remote Control to Control Other Components," p. 48-51).
- To perform these operations, press the CD button to set the remote to the CD operation mode.
- For more information on individual commands consult the manual that came with the component.

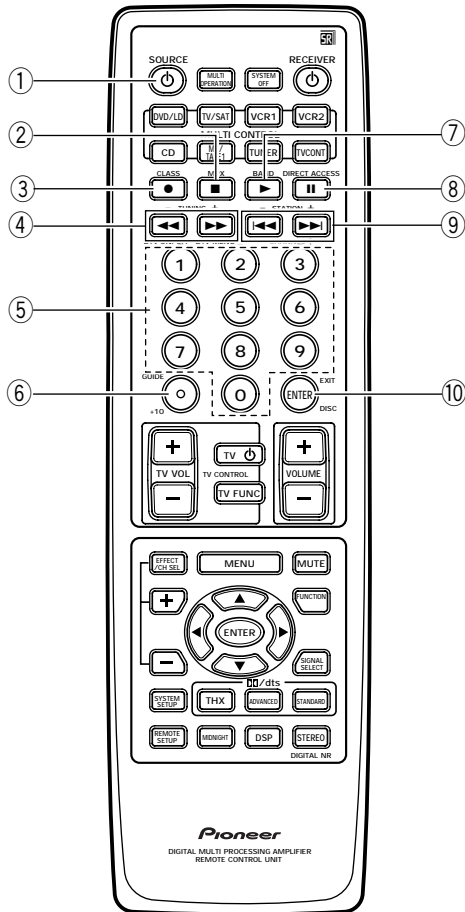

- ① **SOURCE**
Press to switch the CD player on or off.
- ② **■**
Press to stop playback.
- ③ **●**
Press to start recording (for CD-R only).
- ④ **◀◀/▶▶**
◀◀ : Hold down for fast reverse playback.
▶▶ : Hold down for fast forward playback.
- ⑤ **Number buttons**
Use to select tracks.
- ⑥ **+10**
You can also use this button when selecting track numbers higher than 10. It's especially use for track numbers 11-19.
- ⑦ **▶**
Press to start playback.
- ⑧ **||**
Press to pause playback.
- ⑨ **◀◀/▶▶**
◀◀ : Press to return to the beginning of the current track. Press repeatedly to return to the beginning of previous tracks.
▶▶ : Press to advance to the beginning of the next track. Press repeatedly to advance to the beginning of following tracks.
- ⑩ **DISC**
Use to switch between discs in file type disc play.

MD operations



- The following operations are available from the receiver's remote control after you program your MD recorder's preset code, but some operations may need to be learned by the receiver (see "Setting up the Remote Control to Control Other Components," p. 48-51).
- To perform these operations, press the MD/TAPE 1 button to set the remote to the MD operation mode.
- For more information on individual commands consult the manual that came with the component.

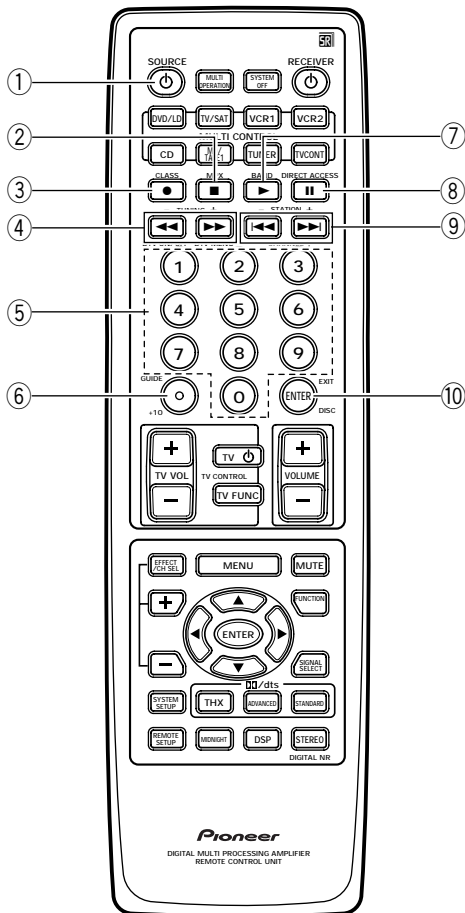

- 1 **SOURCE**
Press to switch the MD player on or off.
- 2 ■
Press to stop playback or recording.
- 3 ●
Press to start recording (may put some decks in REC PAUSE mode).
- 4 ◀▶ / ▶▶
◀▶ : Hold down for fast reverse playback.
▶▶ : Hold down for fast forward playback.
- 5 **Number buttons**
Use to select tracks.
- 6 **+10**
You can also use this button when selecting track numbers higher than 10. It's especially use for track numbers 11-19.
- 7 ▶
Press to start playback.
- 8 ||
Press to pause playback.
- 9 ◀◀ / ▶▶▶
◀◀ : Press to return to the beginning of the current track. Press repeatedly to return to the beginning of previous tracks.
▶▶▶ : Press to advance to the beginning of the next track. Press repeatedly to advance to the beginning of following tracks.
- 10 **DISC (DISP/CHARA)**
Allows you to change the display mode of the MD.

STB (satellite tuner) operations



- The following operations are available from the receiver's remote control after you program your satellite tuner's (or cable TV's) preset code, but some operations may need to be learned by the receiver (see "Setting Up the Remote Control to Control Other Components," p. 48-51).
- To perform these operations, press the TV/SAT button to set the remote to the SAT operation mode.
- For more information on individual commands consult the manual that came with the component.

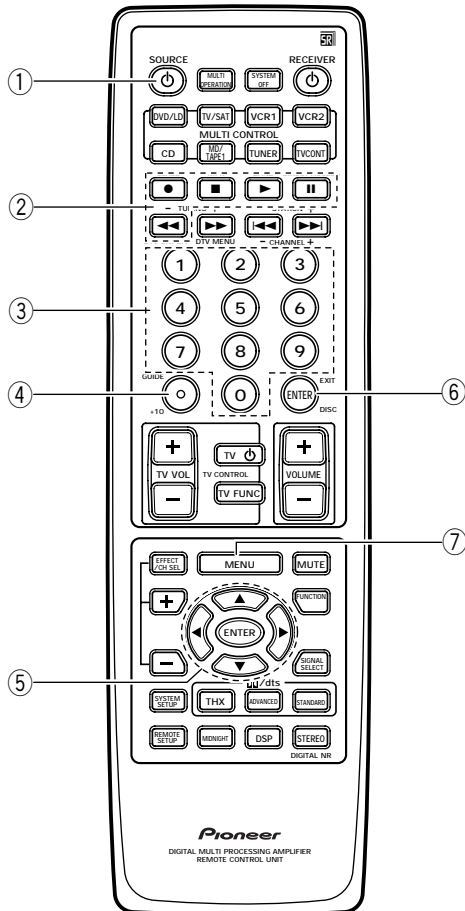

- ① **SOURCE**
Press to switch the satellite tuner on or off.
- ② **●/■/▶/∥/◀◀ (A/B/C/D/E)**
Use to make selections from Satellite functions.
- ③ **Number buttons**
Use to select satellite channels.
- ④ **GUIDE**
Use to turn the program information screen on or off.
- ⑤ **▲/▼/◀/▶/ENTER**
▲/▼/◀/▶ : Press the button to select items on the SAT GUIDE screen or SAT MENU screen.
ENTER : Press to activate the selected function.
- ⑥ **EXIT**
Press to exit the current setting of the SAT.
- ⑦ **MENU**
Use to turn the main menu on or off.

STB (DTV) operations



- The following operations are available from the receiver's remote control after you program your digital tuner's preset code, but some operations may need to be learned by the receiver (see "Setting Up the Remote Control to Control Other Components," p. 48-51).
- To perform these operations, press the TV/SAT button to set the remote to the DIGITAL TUNER operation mode.
- For more information on individual commands consult the manual that came with the component.

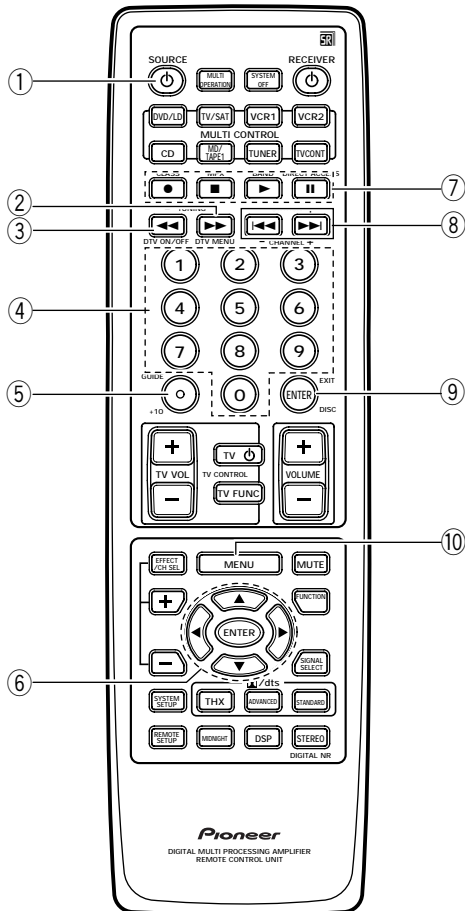

- ① **SOURCE**
Press to switch the digital tuner on or off.
- ② **DTV MENU**
Press to select the DTV menu.
- ③ **DTV ON/OFF**
Press to switch the DTV mode on or off.
- ④ **Number buttons**
Use to select a specific TV channel.
- ⑤ **●**
Use to select a specific TV channel.
- ⑥ **▲/▼/◀/▶/ENTER**
▲/▼/◀/▶ : Press to select or adjust items on the menu screen.
ENTER : Press to activate the selected function.
- ⑦ **●/■/▶/|| (BLUE/GREEN/RED/YELLOW)**
Use to make selections from the DTV menu.
- ⑧ **CHANNEL +/-**
Use to select a TV channel.
- ⑨ **ENTER**
Use to select the channel specified with the number buttons (not all models require this step).
- ⑩ **MENU**
Use to select different menus on a DTV screen.

TV operations



- The following operations are available from the receiver's remote control after you program your TV's preset code, but some operations may need to be learned by the receiver (see "Setting Up the Remote Control to Control Other Components," p. 48-51).
- To perform these operations, press the TV/SAT and TV CONT button to set the remote to the TV operation mode.
- For more information on individual commands consult the manual that came with your TV.

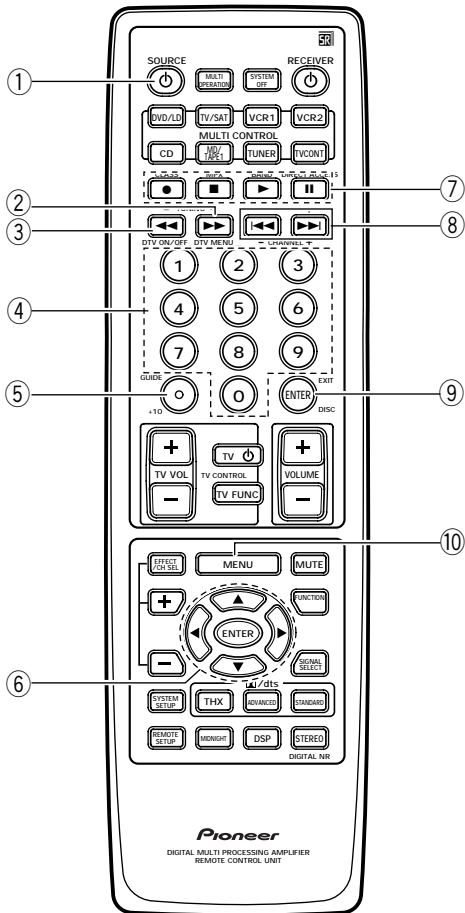

- ① **SOURCE**
Press to switch the TV on or off.
- ② **DTV MENU**
Press to select the DTV menu.
- ③ **DTV ON/OFF**
Press to switch the DTV mode on or off.
- ④ **Number buttons**
Use to select a specific TV channel.
- ⑤ ●
Use to select a specific TV channel.
- ⑥ ▲/▼/◀/▶/ENTER
▲/▼/◀/▶ : Press to select or adjust items on the menu screen.
ENTER : Press to activate the selected function.
- ⑦ ●/■/▶/|| (BLUE/GREEN/RED/YELLOW)
Use to make selections from the DTV menu.
- ⑧ **CHANNEL +/-**
Use to select a TV channel.
- ⑨ **ENTER**
Use to select the channel specified with the number buttons (not all models require this step).
- ⑩ **MENU**
Use to select different menus on a DTV screen.

Cassette deck operations

You can use this remote control to control most cassette decks, though with some models the functions may differ.



- The following operations are available from the receiver's remote control after you recall a cassette deck's preset code, but some operations may need to be learned by the receiver (see "Setting Up the Remote Control to Control Other Components," p. 48-51).
- To perform these operations, press the MD/TAPE 1 button to set the remote to the TAPE operation mode.
- For more information on individual commands consult the manual that came with the component.

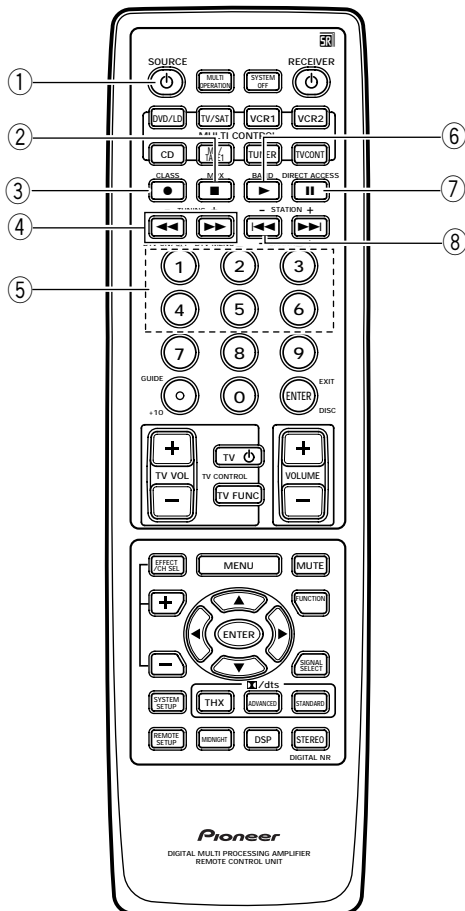

① SOURCE

Press to switch the cassette deck on or off (not possible with all models).

② ■

Press to stop playback or recording.

③ ●

Press to start recording.

④ ◀▶

◀▶ : Press to rewind the tape.

▶▶ : Press to fast forward the tape.

⑤ Number buttons (1~6)

1 : ■ (Press to stop playback or recording.)

2 : ▶ (Press to start playback of the side of the cassette which has been loaded as the front.)

3 : || (Press to pause playback or recording.)

4 : ◀◀ (Press to rewind the tape.)

5 : ◀ (Press to start reverse playback.)

6 : ▶▶ (Press to fast forward the tape.)

⑥ ▶

Press to start playback of the side of the cassette which has been loaded as the front.

⑦ ||

Press to pause playback or recording.

⑧ ◀◀

Press to start reverse playback (for auto reverse decks).

Recording from Audio Components

The following explanations show you how to record an analog audio signal with the component you connected to the MD/TAPE 1 or TAPE 2 MONITOR jacks. Note that you cannot record an component that is only connected digitally. If you want to record from a digital component it must be connected in an analog manner as well. If you want to record a digital signal see the next page.



The receiver's volume, channel level, tone (BASS, TREBLE, and LOUDNESS), and surround effects have no effect on the recorded signal and the EXTERNAL 5.1 CH input cannot be recorded.

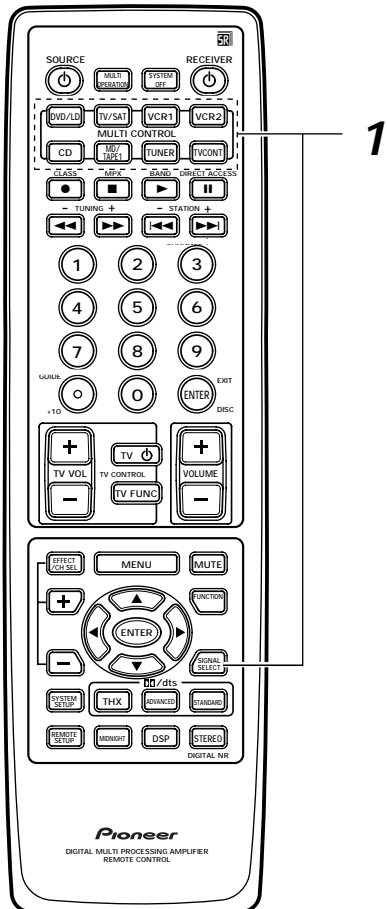

1 Select the source component and put the receiver in that function. Remember, **SIGNAL SELECT** must be set to analog.

Press the **SIGNAL SELECT** button on the remote control (or use the button on the front panel) and choose **ANALOG**. Recording **DIGITAL** or **AC-3 RF** (VSX-27TX only) signals is not possible.

2 Start recording with a **TAPE** or **MD** (etc.).

3 Playback the source to be recorded.

Record monitor (TAPE 2 MONITOR)

If you connect a cassette deck (etc.) with a record monitor function to the **TAPE 2 MONITOR** jacks, you can listen to the sound of the recording as it is recorded.

Press **TAPE 2 MONITOR** to switch between the sound of the recording (**TAPE 2** indicator on) and the sound of the source component (**TAPE 2** indicator off).

Recording from Digital Audio Components

The following explanations show you how to record digital audio. Using this method you can make exact digital copies of sources like CDs or MDs. The only drawback is that you can't switch between various recorders at the touch of a button like you can with analog recordings (see the previous page). If you look on the back of the VSX-27TX/26TX/24TX you'll find a digital out jack which is marked PCM/DIGITAL/DTS OUT (it's to the right of the digital in jacks in the upper left-hand corner). If you connect this to the optical input on a digital recorder (currently these include MD, DAT and CD-R) you can make direct digital recordings with this unit. Of course, the digital components you want to record all need to be connected to the VSX-27TX/26TX/24TX with digital inputs as well. See p.10 if you haven't made these connections.



The receiver's volume, channel level, tone (BASS, TREBLE, and LOUDNESS), and surround effects have no effect on the recorded signal.

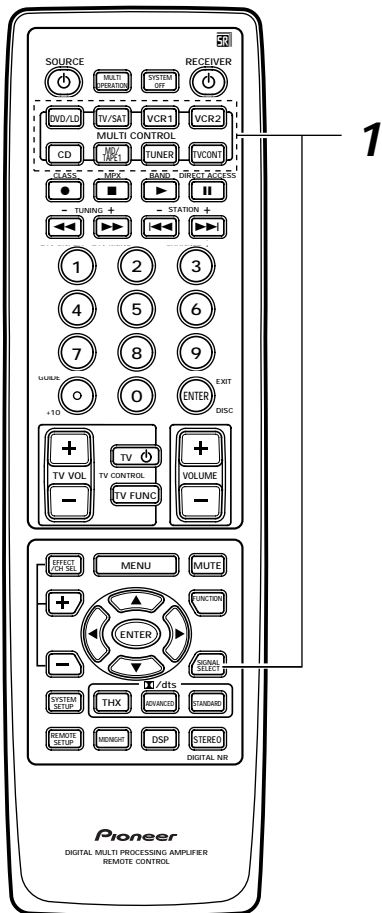

- 1 Prepare the source you want to record and put the receiver in that function. Set the SIGNAL SELECT to digital.**

Press the SIGNAL SELECT button on the remote control (or use the button on the front panel) and choose DIGITAL.

- 2 Start recording with a CD-R or MD (etc.).**

- 3 Playback the source to be recorded.**



In some cases digital recordings have copy guard protections on them and making a digital copy is not possible. It is still possible to copy these digital sources if you have hooked the components up with analog connections (in this case the copies will not be exact digital reproductions). Refer to the previous page in this case.

Recording from Video Components

The following operations show you how to record audio and video to the video tape recorder connected to the VCR 1 or VCR 2 jacks. Note that all signals coming out of these jacks will be analog and it is not possible to record DTS soundtracks.



The receiver's volume, channel level tone (BASS, TREBLE, and LOUDNESS), and surround effects have no effect on the recorded signal.

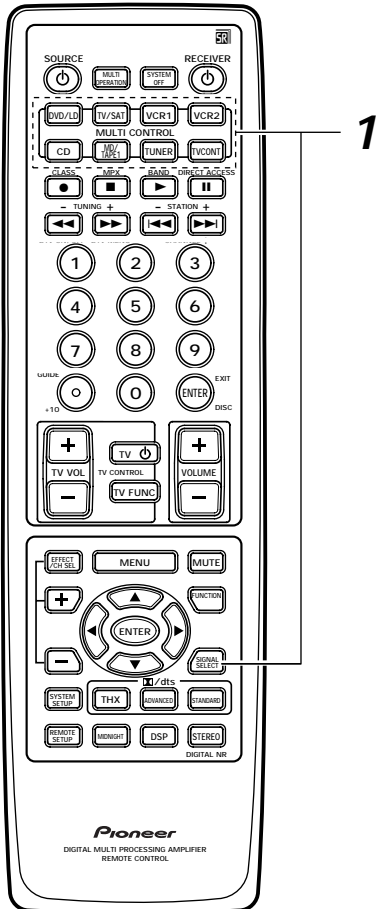

- 1 First, decide the component you'd like to record and put the receiver in that function. Set the SIGNAL SELECT to analog.**
 Press the SIGNAL SELECT button on the remote control (or use the button on the front panel) and choose analog. Recording DIGITAL or AC-3 RF (VSX-27TX only) signals is not possible.
- 2 Start recording with VCR 1 or VCR 2 (etc.).**
- 3 Playback the source to be recorded.**

Multi Operations

Multi operations allow you to tell the receiver and your other components to do a number of things with the push of just two buttons on the remote control. For example, you can program the unit to turn on your TV, turn on your DVD player, go into a specific sound mode and start playing the loaded DVD. This feature allows you to decide which operations you want performed as well as the order in which you want them performed.

The steps below show you how to program a string of up to 5 different operations based on eight possible components. You don't need to program the power of this unit, or any PIONEER product, to go on, it/they will do so automatically when the MULTI OPERATION function is used. Also, for some DVD players you won't need to program a play command. Most DVDs will start to play automatically if their power goes on and a DVD is loaded.



Be sure to recall or teach the remote control commands for each component before attempting MULTI OPERATIONS (see "Setting Up the Remote Control to Control Other Components," p. 48).

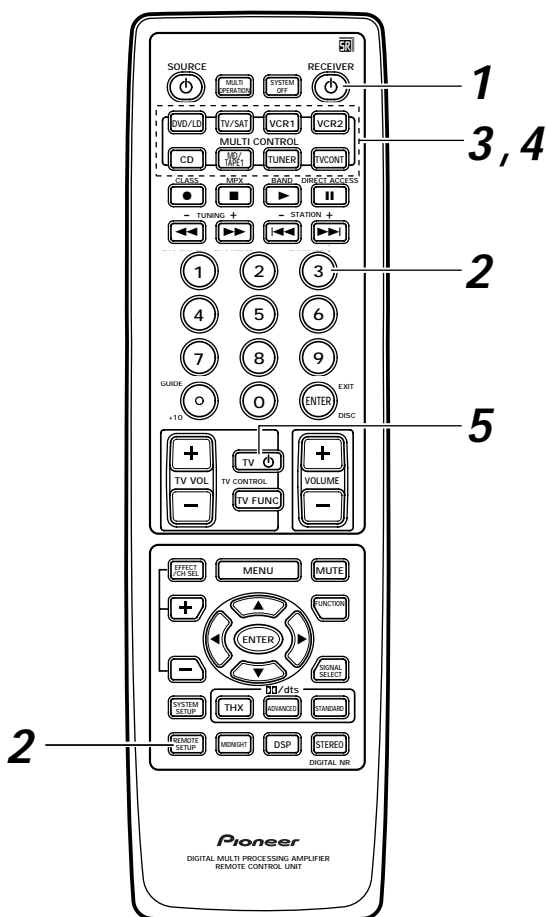

- 1 Turn on your TV and the receiver.**
Make sure your TV is set to the appropriate video input (for example, VIDEO 1).
- 2 Press REMOTE SETUP and ③ at the same time to select the MULTI OPERATION SETUP mode.**
The REMOTE SETUP menu appears on your TV screen. The MULTI CONTROL and the SYSTEM OFF buttons start to blink.
To cancel MULTI OPERATION SETUP mode
Press REMOTE SETUP.

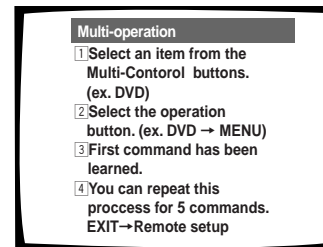

- 3 Press the MULTI CONTROL button that you want to use to start the MULTI OPERATION.**
You can use any MULTI CONTROL button for this procedure. It doesn't matter which one you choose but for example purposes we'll use the DVD/LD button.
This MULTI CONTROL button will be used when you want to recall the MULTI OPERATION commands for use (see the next page: "performing multi operations").
Also, the SYSTEM OFF button will blink but can't be used to recall MULTI OPERATION commands. See the next page for instructions how to use the SYSTEM OFF button.
- 4 Press the MULTI CONTROL button for the component whose operation you want to start MULTI OPERATIONS with (for example, TV CONT button).**
The selected button will light steadily.
 - Each button can perform various preset multi operations (see step five on the next page).

- 5 Press the operation, for example TV ⏻ (POWER), you want to input.**

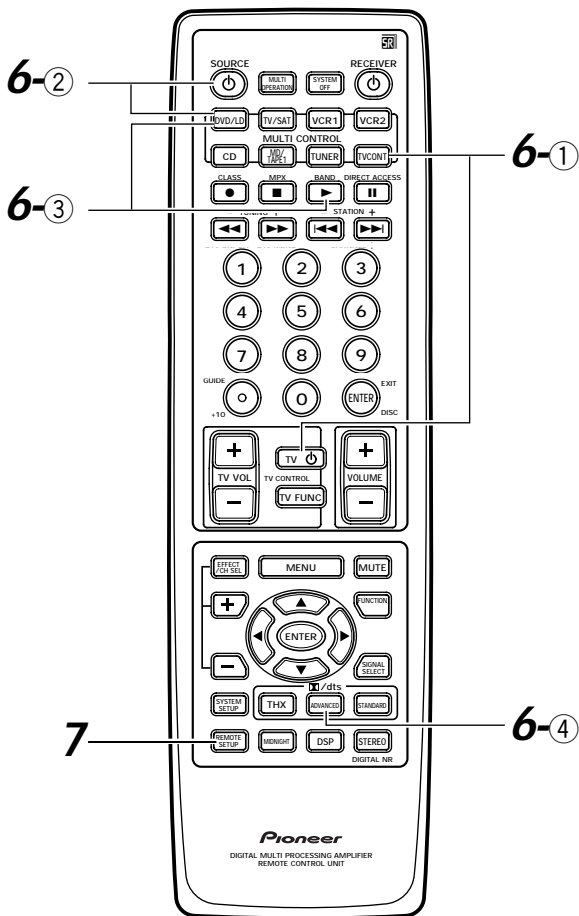

6 Repeat steps 4 and 5 to input **MULTI OPERATIONS** for the components and commands you want to input. You can also tell the receiver to go into a specific sound mode (THX, ADVANCED, STANDARD, MIDNIGHT, DSP or STEREO) by inputting that command (for example, see operation ④ below).

You can repeat this process for up to five commands.

For example : you could enter the following four operations using the preceding steps four and five.

- ① Press TV CONT button & TV ⏻ (POWER) to turn on your TV (as explained above).
 - ② Press DVD/LD then ⏻ (POWER) to turn on your DVD player (if it is not a PIONEER product).
 - ③ Press DVD/LD then ▶ (play) to start playing the DVD player.
 - ④ Press ADVANCED THEATER mode to put receiver in that sound mode.
- When you employ MULTI OPERATIONS (see below), these four tasks will be performed in the same order.

7 Press **REMOTE SETUP** to exit the **MULTI-OPERATION SETUP** mode. The remote control and TV return to their previous operation modes.

Performing multi operations

Follow the procedures below to perform multi operations which you programmed in the section before this.

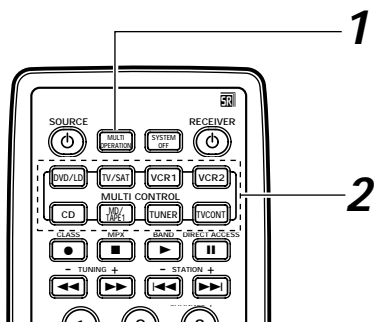

1 Press the **MULTI OPERATION** button on the remote control. The MULTI CONTROL buttons start to blink.

2 Press the **MULTI CONTROL** button that has been set up with multi operations. The power of the main unit goes on, it switches to the appropriate function, and the programmed multi operations are performed automatically.

Using the system off button

This button will turn off the receiver and any component that has programmed into the MULTI OPERATIONS settings (see p.63) as well as turn off all PIONEER components regardless of whether they have been programmed into MULTI OPERATIONS. If you use this feature when a DVD is playing, the player will stop the play mode before switching off.

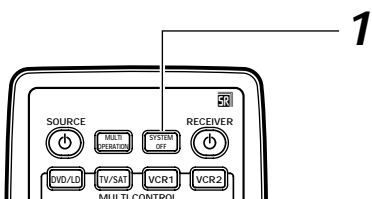

1 Press the **SYSTEM OFF** button on the remote control.

Setting up the direct function

The direct function is designed in case you have an external video source connected to your TV (a video source that is not going through the VSX-27TX/26TX/24TX). For this explanation we'll call this the "external video deck." You'd like to control the external video deck with this unit's remote control so you've assigned it a function button (for example purposes, the VCR 2 button). Yet, if you put the receiver in VCR 2 mode you'll get no picture on your TV because the external video deck signal is not going through the VSX-27TX/26TX/24TX. To get around this problem you set the DIRECT FUNCTION for VCR 2 to OFF. Now when you press VCR 2 function button you can control the external video deck with the remote but the receiver does not go into VCR 2 mode.

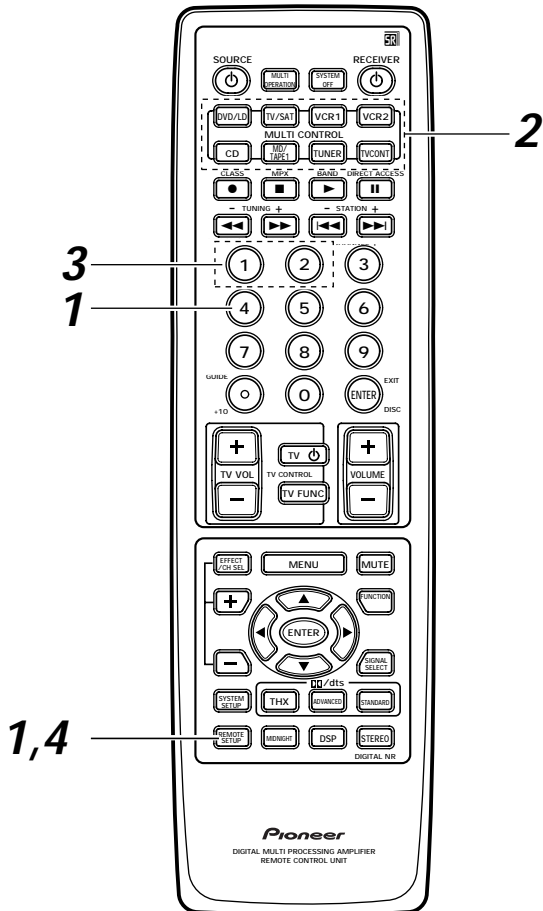

- 1 Press **REMOTE SETUP** and **4** at the same time to select the **DIRECT FUNCTION** mode.

The **MULTI CONTROL** buttons **DVD/LD**, **TV/SAT**, **VCR 1**, **VCR 2**, **CD**, and **MD/TAPE 1** start to blink.

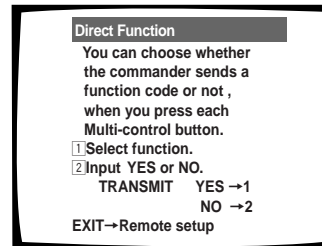

- 2 Select a component by pressing its **MULTI CONTROL** button.
- 3 Set the **DIRECT FUNCTION** of each external source to **NO** by pressing **2**.
- 4 Press **REMOTE SETUP** to exit the **DIRECT FUNCTION** mode.



The default setting is all YES. If you have turned a **DIRECT FUNCTION** to **NO** and want to turn it back to **YES**, follow the directions above and press **1** in step 3.

Remote Back Light

This function is useful for using the unit in a dark room.

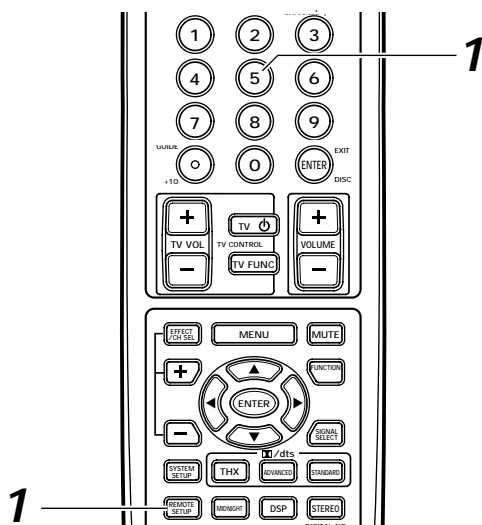

- 1 Press and hold both **REMOTE SETUP** and **5**. The remote back light strength cycles in the following order :



The default setting is **MAX**.

Resetting the Remote Control

The following operations allow you to erase the settings stored in the remote control.

Erasing the multi operations

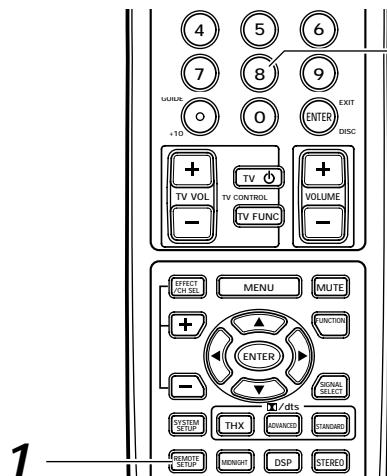

1 1 Press and hold both REMOTE SETUP and 8 for more than 3 seconds.

The MULTI CONTROL buttons will blink 3 times and all multi operation settings will be erased.

Erasing the learned remote control commands

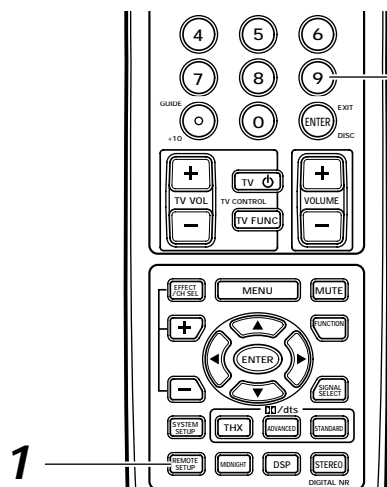

1 1 Press and hold both REMOTE SETUP and 9 for more than 3 seconds.

The MULTI CONTROL buttons will blink 3 times and all signals which have been learned from other remote controls will be erased.

Erasing all signals learned & preset codes

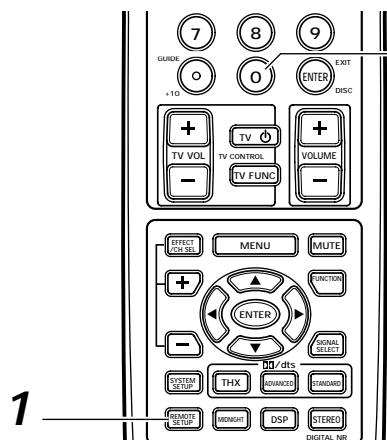

1 1 Press and hold both REMOTE SETUP and 0 for more than 3 seconds.

The MULTI CONTROL buttons will blink 3 times and all preset and learned codes will be erased.

Multi-Room

When used together with an IR receiver (a MULTI-ROOM System remote control sensor), this receiver is capable of outputting two different sources at the same time. One to the (main) VIDEO OUT jack and SPEAKERS terminals and another to the MULTI-ROOM AUDIO and VIDEO OUT jacks.

In addition, connecting the receiver's CONTROL jacks to PIONEER CD players, cassette decks, or other components with the  logo, allows you to control those components from the sub room using the remote control supplied with this receiver.

MULTI-ROOM connections

On the VSX-27TX/26TX, connect the IR receiver sensor to the MULTI-ROOM & SOURCE REMOTE IN jack, (on the VSX-24TX it's called simply MULTI-ROOM REMOTE IN jack), then connect a separate amplifier (and speakers) and TV monitor to the MULTI-ROOM AUDIO and VIDEO OUT jacks. All of this equipment should be placed in your sub-room as shown below.



- When connecting the IR receiver, be sure to connect it to the green MULTI-ROOM & SOURCE REMOTE IN jack, not the black CONTROL IN or OUT jacks.
- It is not possible to input digital signals into the SUB room, you must use analog signals.
- You can't use tone controls (etc.) and any surround modes in the SUB room.

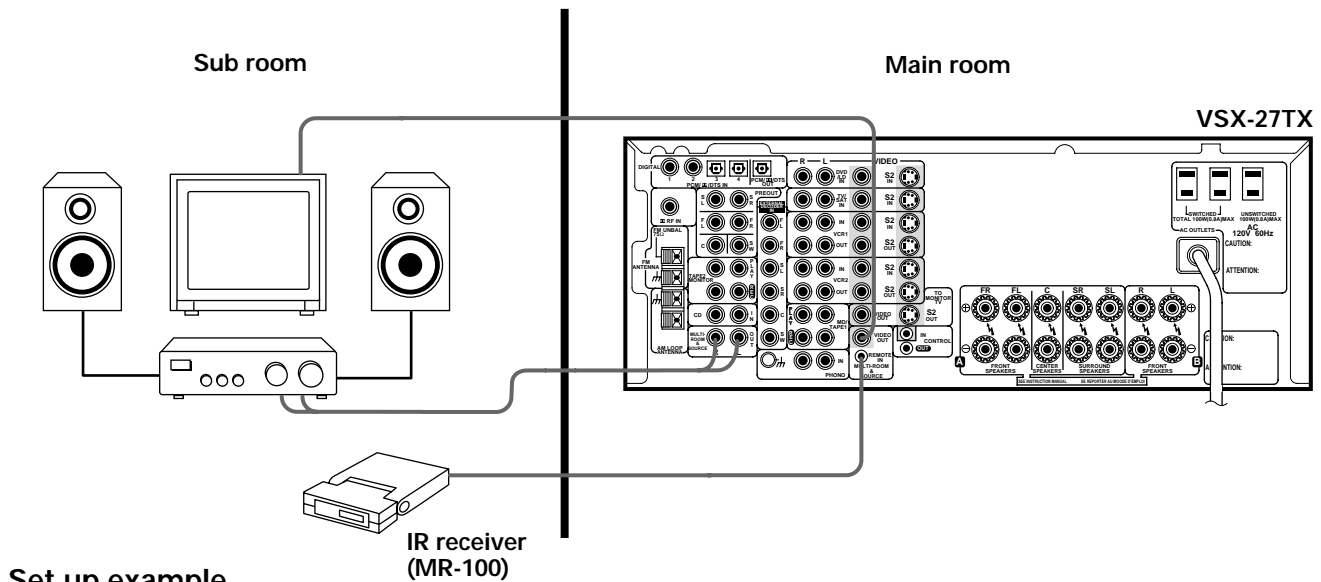

Set up example

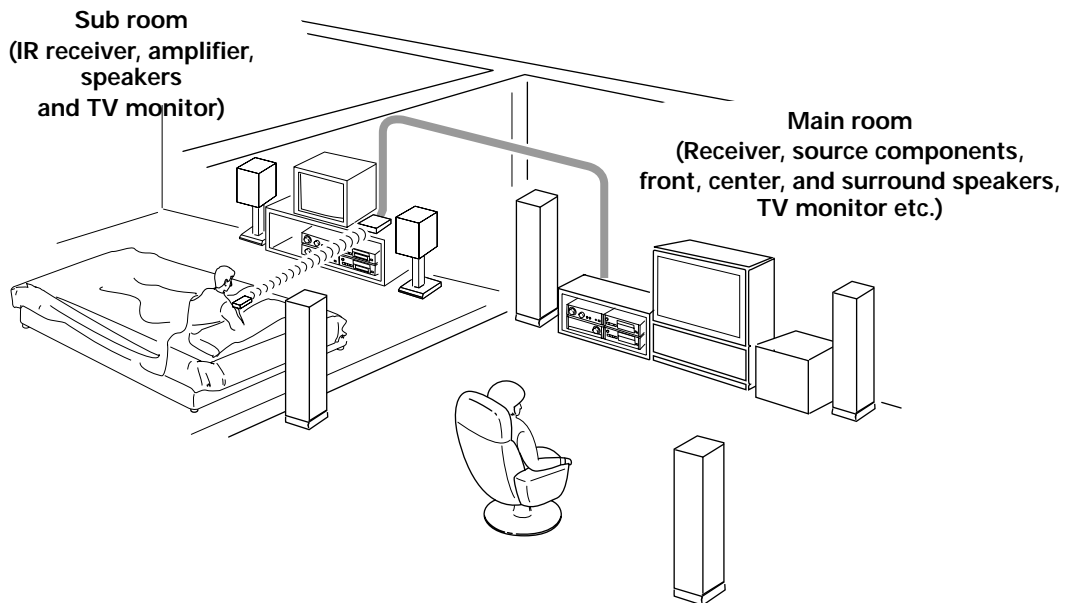

MULTI-ROOM set up (VSX-27TX/26TX only)

After you have completed the necessary connections for MULTI-ROOM operation you need to set up the receiver for such operation. Follow the instructions below. The page after this one explains how to use the MULTI-ROOM function once it's been set up.

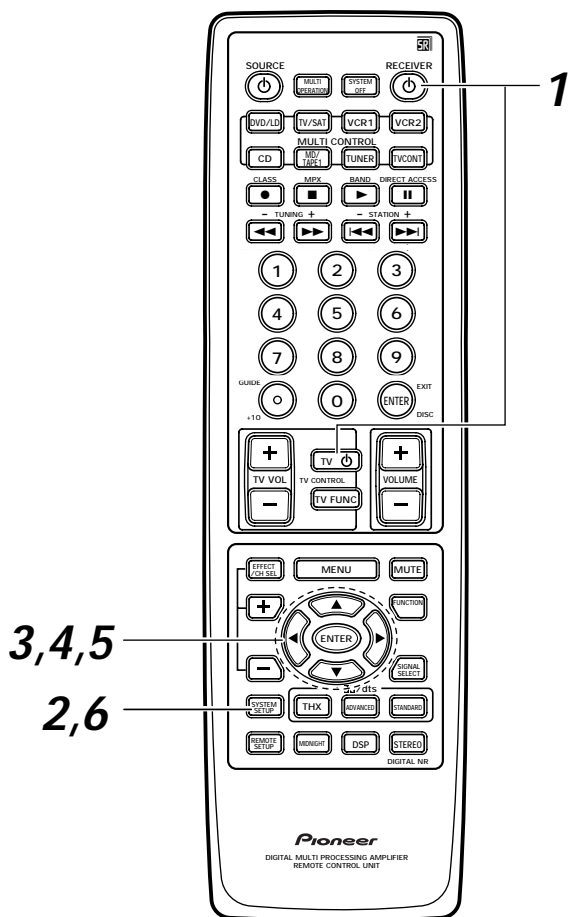

1 Turn on your TV and the receiver.

Make sure your TV is set to the receiver.

2 Press SYSTEM SETUP on the remote control.

The REMOTE SETUP MENU appears on your TV screen. You can escape from this screen at any time by pressing SYSTEM SETUP again.

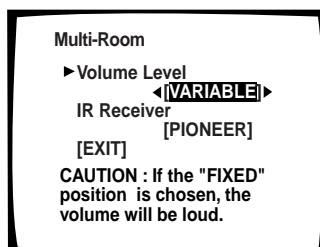

3 Use the ▲/▼ buttons to select the MULTI-ROOM set up mode and press ENTER.

4 Select the VOLUME LEVEL by using the ◀/▶ buttons.

If you hook up a just a power amplifier in the sub room the VSX-27TX/26TX will act as a pre-amp. In this case choose VARIABLE for the VOLUME LEVEL setting. If you hook up a full integrated amplifier in the sub room (such as another Pioneer VSX receiver) choose FIXED for the VOLUME LEVEL setting.

5 Select the IR RECEIVER type with the ▲/▼ buttons and select the type by using the ◀/▶ buttons.

If you have the Pioneer-made MR-100 select PIONEER. If you have an IR RECEIVER from a different company, select OTHER.

6 Move to the EXIT setting and press ENTER to exit MULTI-ROOM set up and return to the SYSTEM SETUP MENU operations.

You can leave the MULTI ROOM set up mode any time by pressing the SYSTEM SETUP button.

CAUTION!

If the MULTI ROOM is set to FIXED the volume on the main unit will be set to maximum. Thus, when output, it will be extremely loud. Please set the master volume controls of the integrated amplifier in the sub room very low at first and experiment to find a suitable volume.



- Some IR RECEIVERS may not work with this system, check with a PIONEER representative to be sure.
- For the VSX-24TX the VOLUME LEVEL is set to FIXED and the IR RECEIVER is set to PIONEER.

Using the front panel (27TX/26TX) with the MULTI-ROOM system

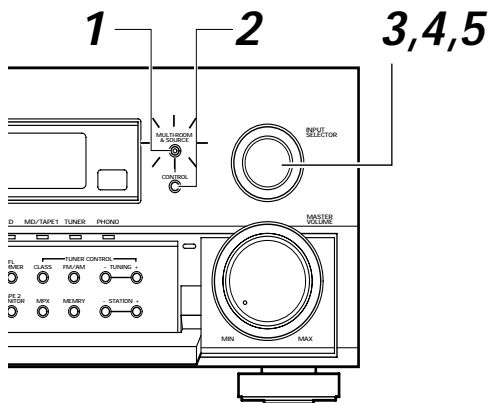
**1 Press the MULTI ROOM & SOURCE button.**

The display shown below will illuminate when the receiver is in STANDBY mode.

Also, the MR&S button will light.

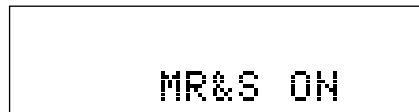
**2 Press the CONTROL button.**

The light will start to blink.

3 Within ten seconds of step 2, select the FUNCTION with the INPUT SELECTOR.

For this example we'll use the TUNER function. The display shown below will illuminate.

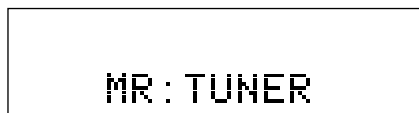

The INPUT SELECTOR steps through the functions in the following order:

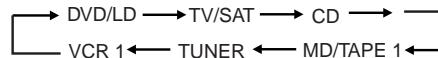
**4 Press the CONTROL button again and use the INPUT SELECTOR to adjust the VOLUME. The volume can be adjusted in a range of -82dB to 0dB.**

The display will appear as shown below.

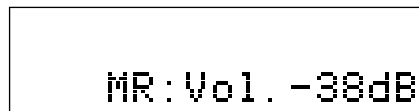
**5 When in TUNER function, press the CONTROL button and use the INPUT SELECTOR to tune in the station.**

The display will appear as shown below.

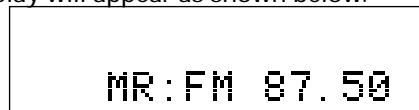

Turn the input selector until you get:

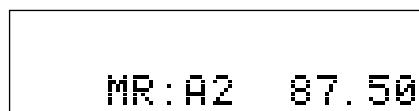

If you don't turn the multi room function off you won't be able to turn the entire system off.

Using the remote control (27TX/26TX) with the MULTI-ROOM system

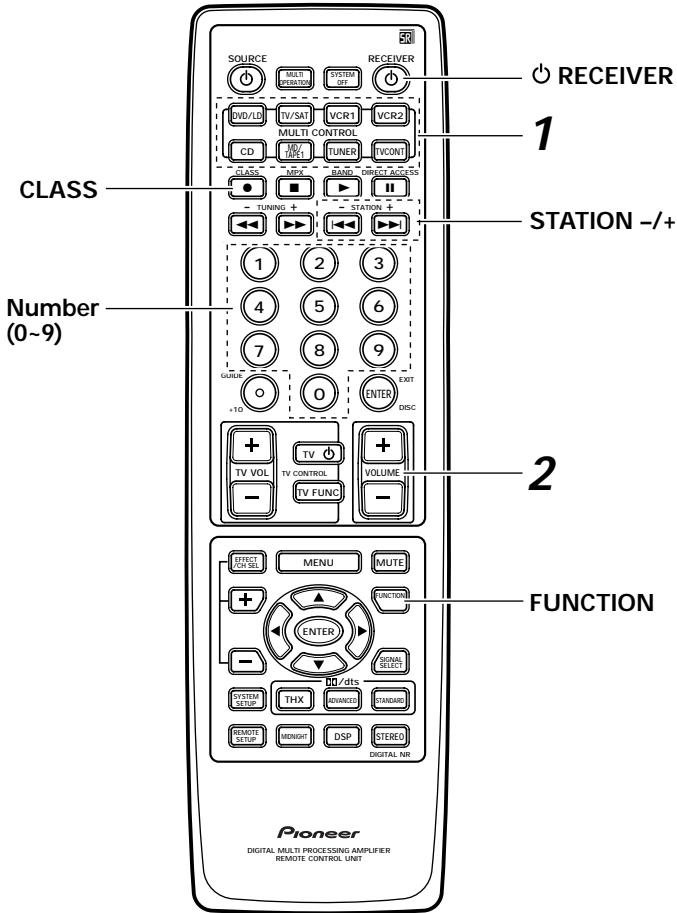

1 From the sub room, point the remote control at the MULTI ROOM sensor and press a MULTI CONTROL button to select the sub function.

For example, Press TUNER to listen to the tuner. The MULTI ROOM & SOURCE button will light on the front panel in the main room.

2 Press VOLUME +/- to adjust the volume. The following remote control buttons can be used to operate the receiver from the sub room.

- **RECEIVER** button
- **FUNCTION** button (will not select PHONO, VCR 2 or VIDEO)
- **VOLUME +/-** buttons (for adjusting the sub-room's volume level, but can't be used when set to FIXED).
- **CLASS** button (for selecting the desired class)
- **STATION +/-** button (for recalling memorized radio stations (the tuner is selected automatically))
- **Number** button (0-9)

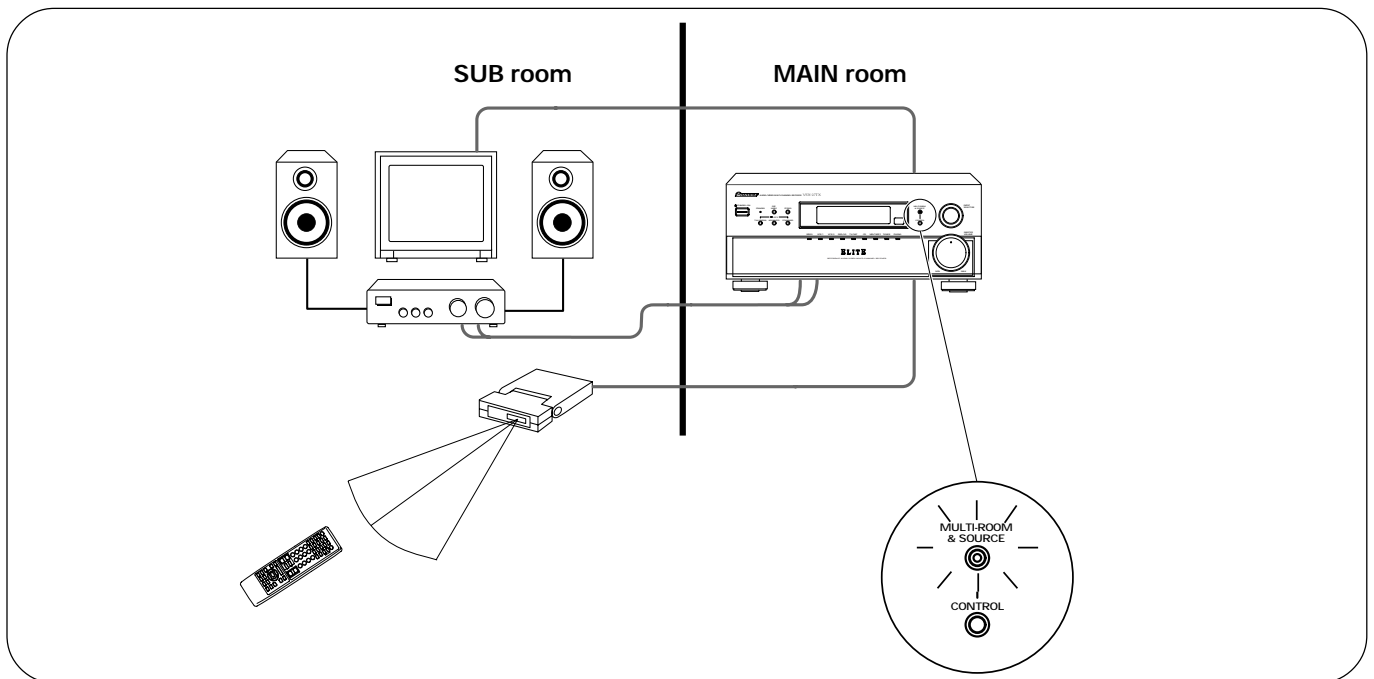



- Remote operation may not be possible if direct light from a strong fluorescent lamp is shining on the IR receiver remote sensor window.
- The tuner cannot be tuned to more than one station at a time. Therefore, changing the station in one room also changes the station in the other room. Please be careful not to change stations when recording a radio broadcast.
- The volume levels of the main and sub rooms are independent.
- When more than one remote control signal is transmitted at the same time, the receiver does not operate.
- When operating MULTI-ROOM & SOURCE with the MULTI-ROOM PRE OUT jacks connected to a SUB room amplifier which bears the PIONEER mark and has a remote sensor, both the IR receiver and the amplifier may receive remote control commands (making correct operation impossible). In this case, place the IR receiver and amplifier apart from each other, and point the remote control directly at the IR receiver during operation.
- If you plan to leave the MULTI ROOM feature off for a lengthy period please turn off the power in both the SUB and MAIN rooms. Make sure the STANDBY indicator turns red and the MR&S indicator goes off.
- If you send the SYSTEM OFF command from the SUB room by remote control, the power of both rooms will go off. Please be careful when making a recording in the MAIN room.

The PIONEER SR System: One-touch Operation of Multi-room PIONEER components

Connecting an optional control cord allows you to operate other PIONEER components simply by pointing the receiver's remote control at the remote sensor on the front panel of the receiver. The receiver then sends the remote control signals to the other devices via the CONTROL OUT terminal.

The CONTROL connections also allow you to operate the connected PIONEER components from a separate room (SUB room) when you connect an optional PIONEER MR-100 Multi-Room Remote Control sensor for multi-room operation (see p. 67).

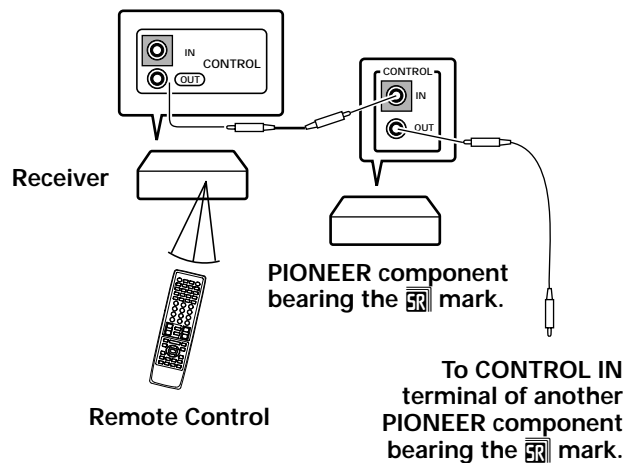

- You can also control PIONEER components (and those made by other manufacturers) by pointing the receiver's remote control directly at the respective component. This type of operation does not require control cords. All you have to do is recall the appropriate preset code (see p. 48).
- If you use a remote control hooked up via the CONTROL IN jack with a control cord, you won't be able to use this unit's remote control.

Dolby Digital

Dolby Digital is a compression format which records the sound of 6 channels of the theater surround system (Dolby Digital) on the movie film digital track. Of the 6 channels, the sub woofer channel is intended for bass only, and because the frequency range is smaller than the main channel, it is expressed as 5.1 channel.

Dolby Digital is the name of the Dolby surround multi-channel digital system that was developed after the Dolby Surround System and Dolby Pro Logic Surround System.

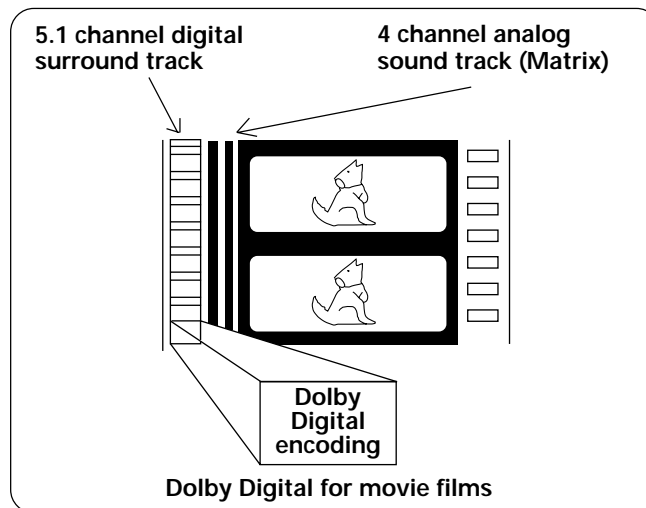

The number of movies made using Dolby Digital since 1992 has exceeded 300 and continues to increase. For compact disc players and laser disc digital sounds, 16 bits are used to sample the original analog audio waveform and sampling is carried out 44,100 times every second. However because an enormous amount of recording signal data is required for the multi channel system with this method, AC-3 is used to compress the data.

In reproducing audio signals, the smaller the bit number used, the lower the sound quality. With AC-3, drop in auditory sound quality is prevented by using masking technology and digital filtering technology based on the human auditory characteristics.

Laser disc format

Laser discs are now available on the market in large numbers. This means that the recording of different format audio signals on the laser disc raises the important question of compatibility with existing laser discs. Dolby Digital tracks on Laser discs record signals using the space of one analog audio channel so it will maintain compatibility with existing discs and players.

As shown in the following figure, the digital audio sounds of Dolby Digital discs can be played back as currently done. Analog sounds are played back by using the other channel without the Dolby Digital signals for mono audio signals.

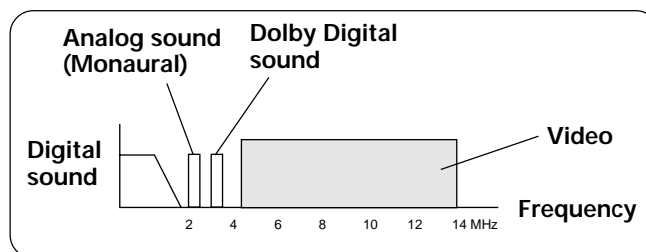

Comparison with Dolby Pro Logic Surround

Dolby Digital is also known as the 5.1 channel system. It is equipped with 5 channels (front left, front right, center, surround left, surround right) in the frequency range from 20 Hz to 20 kHz and an independent Low Frequency Effect (LFE) channel. The sub woofer channel is also called Low Frequency Effect (LFE).

The sub woofer channel can be used as desired to enjoy strong bass sounds.

The table on the next page shows the comparison with Dolby Pro Logic Surround effects.

DTS

DTS has been adopted as a sound recording format in the latest movie theaters since the release of "JURASSIC PARK" in 1993, and has a good reputation for high quality sound and dynamic surround effects.

In this system, 6 channels of digital sound are recorded on CD-ROM, rather than on the film. DTS adopts a simultaneous playback format. With a low rate of compression of sound signals and a high rate of transmittance, a higher sound quality format is produced. Also, unlike the process of recording digital sounds on film directly, the only components required are a CD-ROM player as might be used with a personal computer and a DTS processor, and therefore less investment is required than with other formats. For this reason, the format is being introduced in more and more movie theaters, and is being adopted in home movie software (DVD, LD) and music software (5.1 channel CD).

More than 11,000 movie theaters around the world have adopted the DTS format, which is now the most popular digital format for movie theaters, especially in U.S.A, Europe, and Asia.

	Dolby Digital	DTS	Dolby Pro Logic Surround
No. of recorded channels	5.1 channels (Max.)	6 channels (Max.)	2 channels
No. of playback channels	5.1 channels (Max.)	6 channels (Max.)	4 channels
Playback channel structure	Front Left, Front Right, Center, Surround Left, Surround Right, Sub Woofer	Front Left, Front Right, Center, Surround Left, Surround Right, Sub Woofer	Front Left, Front Right, Center, Surround
Sound processing	Digital discrete processing	Digital discrete processing	Analog matrix processing
Rear (Surround) high frequency playback limit	20,000 Hz	20,000 Hz	7,000 Hz
Other	<ul style="list-style-type: none"> • 5.1 completely independent channels • High dynamic range • Stable position, high phase characteristics, and advanced surround effects reproduction • High efficiency (Compression rate of about one-tenth) 	<ul style="list-style-type: none"> • 6 completely independent channels • High dynamic range • Stable position, high phase characteristics, and advanced surround effects reproduction • Low compression rate (about one-fourth), high quality sound 	/

THX

THX is a Lucasfilm, Ltd. program dedicated to maximum accuracy in movie presentation. Movie sound tracks are recorded in large movie dubbing stages using movie theater equipment. For a sound track to be presented accurately in your home, special technologies are required. In your home the room is much smaller and has a bright sound, the speakers are very different and there are only six of them, plus, you sit much closer to each one of those speakers. Because of these differences we often miss the power and emotion that thrills us in a good movie. Now Pioneer and THX have teamed up to bring the full glory of accurate cinema sound to the comfort and convenience of your home.

Re-Equalization™ : In a theater the room is very large and dead sounding, you sit a long way back from the speakers and the speakers themselves are very specialized. Because a sound track recorded in this dead sounding space when it is played at home it sounds overbright. THX Re-Equalization adjusts for this difference in a very precise way.

Dynamic Decorrelation™ : When a sound track sends mono sound to the surround speakers it often seems to be coming from one side instead of from all around you as it would in a theater. Dynamic Decorrelation helps to correct this inaccuracy.

Timbre Matching™ : When recording a sound track it is very important that the surround sounds move smoothly and seamlessly around the theater. It is very distracting when sounds seem to jump from speaker to speaker. Timbre Matching helps to smooth the movement of the surround sounds even though you are using only two speakers.

Bass Peak Level Manager™ : Some Dolby Digital and DTS soundtracks can produce bass peaks that are undesirable in a home theater environment. The Bass Peak Level Manager allows you to set the maximum peak levels appropriate to your system. (Set this function according to the bass peak level instructions on page 32.)

Loudspeaker Position Time Synchronization™ : This feature allows you to adjust for the difference in the distance from each individual loudspeaker to the listening position. Doing this ensures that all the speakers operate in precise synchronization improving the seamless nature of the soundfield. (Set this function according to the channel delay instructions on page 28.)

Preset Code List

Device	Manufacturer	Code	Device	Manufacturer	Code
DVD	TOSHIBA	001	TAPE	OPTIMUS	800
	SONY	002		PIONEER	800
	PANASONIC	003	CD	SONY	301,316,317,318
	JVC	004		TECHNICS	304,326
	SAMSUNG	005		KENWOOD	310,321,311
	SHARP	006		DENON	309
	AKAI	007		RCA	302,319,313
	RCA	009		PHILIPS	312,322
	PIONEER	000, 008		YAMAHA	315,314,328
LD	SONY	101	JVC	303	
	PANASONIC	105,106	TEAC	305,306,327,324,325	
	KENWOOD	103	ONKYO	320,308,307	
	PHILIPS	104	MARANTZ	323,312,324	
	MITSUBISHI	100	SANYO	313	
	RCA	107	OPTIMUS	300	
	PIONEER	100	PIONEER	300,329	
STB	RCA	201 (SAT),203 (SAT)	MD	SONY	901
	SONY	202 (SAT)		KENWOOD	903
	PIONEER	200 (SAT),204 (Digital Tuner)		SHARP	902
VCR	RCA	401,406,408,414,405,413,411 415		TEAC	904
	ZENITH	403,404,417		ONKYO	905
	MAGNAVOX	414,408,426,403		DENON	906
	FISHER	410,426,412,427,425,420	PIONEER	900,902 (CD-Recorder)	
	PANASONIC	408,432,433	TV	RCA	601,610,615,616,617,618
	TOSHIBA	405,409,426		ZENITH	603,620
	JVC	428,430,429,408,414,431,407		MAGNAVOX	607,610,603,612,629
	HITACHI	408,401,406,436,434		GE	601,608,607,610,617,602,628 618
	SONY	416,417,404,408		PANASONIC	608,622,607
	MITSUBISHI	409,420,421,422,423,424,408 407		SONY	604
	SANYO	410,412,425,435		TOSHIBA	605,602,626,621
	SHARP	402,418,419		MITSUBISHI	609,610,602,621
	GOLDSTAR	411,409		HITACHI	606,610,624,625,618
OPTIMUS	408,432,433,402,418,419	JVC		613,623	
GRANDIENTE	452	SHARP		602,619,627	
PIONEER	400,453 (DVD Video Recorder)	SANYO		621,614	
TAPE	SONY	801,806	PHILIPS	607	
	TECHNICS	803	GOLDSTAR	610,623,621,602	
	KENWOOD	804,807	RADIO	610,623,621,602	
	TEAC	805	SHACK		
	DENON	810	GRANDIENTE	635	
	ONKYO	809,808	PIONEER	600	
	YAMAHA	811,812	CATV	JERROLD	711,701,702,712,704,713,703 714,716,715
	JVC	802		S.ATLANTA	705,706,708,709
	FISHER	813		ZENITH	707,717,710
				PIONEER	700
				TUNER	PIONEER

Troubleshooting

Incorrect operations are often mistaken for trouble and malfunctions. If you think that there is something wrong with this component, check the points below. Sometimes the trouble may lie in another component. Investigate the other components and electrical appliances being used. If the trouble cannot be rectified even after exercising the checks listed below, ask your nearest PIONEER authorized service center or your dealer to carry out repair work.

Symptom	Cause	Remedy
The power does not turn ON.	<ul style="list-style-type: none"> The power plug is disconnected. The protection circuit may have been activated. 	<ul style="list-style-type: none"> Connect the power plug to the wall outlet. Disconnect the power plug from the outlet, and insert again.
The unit does not respond when the buttons are pressed.	<ul style="list-style-type: none"> Static electricity caused by dry air. 	<ul style="list-style-type: none"> Disconnect the power plug from the outlet, and insert again.
No sound is output when a function is selected.	<ul style="list-style-type: none"> Improper connections. Sound is muted. The volume is turned down. The TAPE 2 MONITOR is ON. Speakers are turned OFF. DIGITAL/ANALOG switch is set incorrectly. 	<ul style="list-style-type: none"> Make sure the component is connected correctly (see p. 8-16). Press MUTE on the remote control. Adjust MASTER VOLUME. Press the TAPE 2 MONITOR button. Press SPEAKERS (A/B) to select the speakers you connected. Set SIGNAL SELECT (see p. 40)
No image is output when a function is selected.	<ul style="list-style-type: none"> Improper connections. The input source is not properly selected. 	<ul style="list-style-type: none"> Make sure the component is connected correctly (see p. 8, 9). Press the correct function button.
Considerable noise in radio broadcasts.	<ul style="list-style-type: none"> Incorrect frequency. The antenna is not connected. AC-3 RF and/or digital cables are near the antenna terminals and wires. 	<ul style="list-style-type: none"> Tune in the correct frequency. Connect the antenna (see p.13). Route AC-3 RF and digital cables away from the antenna terminals and wires.
FM broadcasts		
	<ul style="list-style-type: none"> The FM antenna is not fully extended or is poorly positioned. Weak radio signals. 	<ul style="list-style-type: none"> Fully extend the FM wire antenna, position for best reception, and secure to a wall. Connect an outdoor FM antenna (see p.13).
AM broadcasts		
	<ul style="list-style-type: none"> The AM antenna is poorly positioned. Weak radio signals. Interference caused by other equipment (fluorescent lamp, motor, etc.). 	<ul style="list-style-type: none"> Adjust the direction and position for best reception. Connect an additional internal or external AM antenna (see p.13). Turn off the equipment causing the noise or move it away from the receiver. Place the antenna farther away from the equipment causing the noise.
Broadcast stations cannot be selected automatically.	<ul style="list-style-type: none"> Weak radio signals. 	<ul style="list-style-type: none"> Connect an outdoor antenna (see p.13).
Sub woofer output is very low	<ul style="list-style-type: none"> Settings route signal away from Sub woofer 	<ul style="list-style-type: none"> To get more signal to the sub woofer set it to PLUS or choose SMALL for the FRONT speakers.

Symptom	Cause	Remedy
No sound from surround or center speakers.	<ul style="list-style-type: none"> • Speaker settings are incorrect. • The surround and/or center levels are turned down. • The surround and/or center speakers are disconnected. 	<ul style="list-style-type: none"> • See "Speaker Setting" on p.26-27 to check the speaker settings. • See "Channel Level" p.29 to check the speaker levels. • Connect the speakers (see p.14).
Sound is produced from some components, but not from digital components.	<ul style="list-style-type: none"> • SIGNAL SELECT is set incorrectly. • The digital inputs are assigned incorrectly, or not at all. 	<ul style="list-style-type: none"> • Set SIGNAL SELECT to "DIGITAL" or "ANALOG" according to the type of connections made (see p. 40). • Set the digital input settings correctly (see p. 34).
No sound is output or a noise is output when software with DTS is played back.	<ul style="list-style-type: none"> • SIGNAL SELECT is set to "ANALOG". • A DVD player not compatible with DTS is being used, or the setting of the DVD player is incorrect. • The digital output level has been turned down on a CD player or other component equipped with digital output level adjustment capability. (The DTS signal has been altered by the player, and cannot be read.) 	<ul style="list-style-type: none"> • Make digital connections (see p.10, 11) and set SIGNAL SELECT to "DIGITAL" (see p.40). • Refer to the instruction manual supplied with the DVD player. • Set the digital volume level of the player to full, or to the neutral position.
The sound is output intermittently when software with DTS is played back. The overload indicator is lit.	<ul style="list-style-type: none"> • Disc being played back has a huge amount of information on it. 	<ul style="list-style-type: none"> • Use the STANDARD mode to get the best results (see memo, p.38).
When a search is performed by a DTS compatible CD player during playback, noise is output.	<ul style="list-style-type: none"> • The search function performed by the player interferes with the reading of digital information. 	<ul style="list-style-type: none"> • This is not a malfunction, but be sure to turn the volume down to prevent the output of loud noise from your speakers.
Cannot be remote controlled.	<ul style="list-style-type: none"> • The remote control batteries have worn out. • Too far away or bad angle of operation. • There is an obstacle between the receiver and the remote control. • Strong light such as fluorescent light is shining onto the unit's remote control signal light-receiving window. • A cord is connected to the CONTROL IN terminal on this unit. • The IR Receiver type is mismatched with the setting. 	<ul style="list-style-type: none"> • Replace the batteries (see p.6). • Operate within 23 feet (7 m) and 30° of the remote sensor on the front panel (see p.7). • Remove the obstacle or operate from another position. • Avoid exposing the remote sensor on the front panel to direct light. • Connect cord to the correct jack. • Disconnect the IR Receiver from the rear panel, and set to the other IR Receiver type.
The display is dark.	<ul style="list-style-type: none"> • The FL DIMMER button is pushed. 	<ul style="list-style-type: none"> • Press FL DIMMER on the front panel repeatedly to return to the default setting (see p.43).

If the unit does not operate normally due to external effects such as static electricity

Disconnect the power plug from the outlet and insert again to return to normal operating conditions.

Specifications

VSX-27TX : Amplifier Section

Continuous average power output of 120 watts* per channel, min., at 6 ohms, from 20 Hz to 20,000 Hz with no more than 0.09 %** total harmonic distortion (front).

VSX-26TX:
Continuous average power output of 100 watts* per channel, min., at 8 ohms, from 20 Hz to 20,000 Hz with no more than 0.09 %** total harmonic distortion (front).

VSX-24TX :
Continuous average power output of 90 watts* per channel, min., at 8 ohms, from 20 Hz to 20,000 Hz with no more than 0.09 %** total harmonic distortion (front).

VSX-27TX :

Continuous Power Output

Front 120 W + 120 W (20-20 kHz, 0.09 %, 6 Ω)
Center 120 W (20-20 kHz, 0.09 %, 6 Ω)
Rear 120 W + 120 W (20-20 kHz, 0.09 %, 6 Ω)

VSX-26TX :

Continuous Power Output

Front 100 W + 100 W (20-20 kHz, 0.09 %, 8 Ω)
Center 100 W (20-20 kHz, 0.09 %, 8 Ω)
Rear 100 W + 100 W (20-20 kHz, 0.09 %, 8 Ω)

VSX-24TX :

Continuous Power Output

Front 90 W + 90 W (20-20 kHz, 0.09 %, 8 Ω)
Center 90 W (20-20 kHz, 0.09 %, 8 Ω)
Rear 90 W + 90 W (20-20 kHz, 0.09 %, 8 Ω)

Input (Sensitivity/Impedance)

PHONO MM 4.7 mV/47 kΩ
VCR 1, VCR 2, DVD/LD, TV/SAT, VIDEO, CD, MD/TAPE 1, TAPE 2
..... 335 mV/47 kΩ

Phono Overload level (T.H.D.0.1 %, 1kHz)

PHONO MM 120 mV

Frequency Response

PHONO MM 20 Hz to 20,000 ± 0.3 dB
VCR 1, VCR 2, DVD/LD, TV/SAT, VIDEO, CD, MD/TAPE 1, TAPE 2
..... 5 Hz to 100,000 Hz $_{-3}^{+0}$ dB

Output (Level/Impedance)

VCR 1 REC, VCR 2 REC, MD/TAPE 1 REC, TAPE 2 REC 335 mV/2.2 kΩ

Tone Control

BASS ± 6 dB (100 Hz)
TREBLE ± 6 dB (10 kHz)
LOUDNESS +3 dB (100 Hz/10 kHz)

Signal-to-Noise Ratio (IHF, short circuited, A network)

PHONO MM 80 dB
VCR 1, VCR 2, DVD/LD, TV/SAT, VIDEO, CD, MD/TAPE 1, TAPE 2
..... 101 dB

Signal-to-Noise Ratio [EIA, at 1 W (1 kHz)]

PHONO MM 80 dB
VCR 1, VCR 2, DVD/LD, TV/SAT, VIDEO, CD, MD/TAPE 1, TAPE 2
..... 83 dB

* Measured pursuant to the Federal Trade Commission's Trade Regulation rule on Power Output Claims for Amplifiers.

** Measured by Audio Spectrum Analyzer.

VIDEO Section

Input (Sensitivity/Impedance)

VCR 1, VCR 2, DVD/LD, TV/SAT, VIDEO 1 Vp-p/75 Ω

Output (Level/Impedance)

VCR 1, VCR 2, MONITOR 1 Vp-p/75 Ω

Frequency Response

VCR 1, VCR 2, MONITOR 5 Hz to 10 MHz $_{-3}^{+0}$ dB

Signal-to-Noise Ratio 65 dB

FM Tuner Section

Frequency Range 87.5 MHz to 108 MHz

Usable Sensitivity Mono: 13.2 dBf, IHF (1.3 μV/75 Ω)

50 dB Quieting Sensitivity Mono: 20.2 dBf

Stereo: 38.6 dBf

Signal-to-Noise Ratio Mono: 73 dB (at 85 dBf)

Stereo: 70 dB (at 85 dBf)

Distortion Stereo: 0.5 % (1 kHz)

Alternate Channel Selectivity 60 dB (400 kHz)

Stereo Separation 40 dB (1 kHz)

Frequency Response 30 Hz to 15 kHz (± 1) dB

Antenna Input 75 Ω unbalanced

AM Tuner Section

Frequency Range 530 kHz to 1,700 kHz

Sensitivity (IHF, Loop antenna) 350 μV/m

Selectivity 25 dB

Signal-to-Noise Ratio 50 dB

Antenna Loop antenna

Miscellaneous

Power Requirements AC 120 V, 60 Hz

VSX-27TX :

Power Consumption 460 W, 630 VA

Power Consumption in Standby mode 1.0 W

AC Outlet SWITCHED (x2) Total 100 W (0.8 A) MAX

AC Outlet UNSWITCHED 100 W (0.8 A) MAX

Dimensions 420 (W) × 173 (H) × 470 (D) mm

16-9/16 (W) × 6-13/16 (H) × 18-1/2 (D) in

Weight (without package) 14.7 kg (32 lb 7 oz)

VSX-26TX/24TX :

Power Consumption 400 W, 550 VA

Power Consumption in Standby mode 1.0 W

AC Outlet SWITCHED (x2) Total 100 W (0.8 A) MAX

AC Outlet UNSWITCHED 100 W (0.8 A) MAX

Dimensions 420 (W) × 173 (H) × 470 (D) mm

16-9/16 (W) × 6-13/16 (H) × 18-1/2 (D) in

Weight (without package) 14.1 kg (31 lb 1 oz)

Furnished Parts

FM Antenna 1

AM Loop Antenna 1

Dry Cell Batteries (SIZE "AA" (IEC LR6)) 2

Remote Control Unit 1

Operating Instructions 1

NOTE:

Specifications and the design are subject to possible modifications without notice, due to improvements.

Should this product require service in the U.S.A. and you wish to locate the nearest Pioneer Authorized Independent Service Company, or if you wish to purchase replacement parts, operating instructions, service manuals, or accessories, please call the number shown below.

8 0 0 - 4 2 1 - 1 4 0 4

Please do not ship your product to Pioneer without first calling the Customer Service Department at the above listed number for assistance.

PIONEER ELECTRONICS SERVICE, INC.
CUSTOMER SERVICE DEPARTMENT
P.O. BOX 1760, LONG BEACH,
CA 90801-1760, U.S.A.

For warranty information please see the Limited Warranty sheet included with your product.

Should this product require service in Canada, please contact a Pioneer Canadian Authorized Dealer to locate the nearest Pioneer Authorized Service Company in Canada.
Alternatively, please contact the Customer Service Department at the following address:

Pioneer Electronics of Canada, Inc.
Customer Service Department
300 Allstate Parkway, Markham, Ontario L3R
OP2
(905) 479-4411
1-877-283-5901

For warranty information please see the Limited Warranty sheet included with your product.

Si ce produit doit être réparé au Canada, veuillez vous adresser à un distributeur autorisée Pioneer au Canada pour obtenir le nom de la Société de Service Autorisée Pioneer le plus près de chez vous. Ou encore, veuillez vous communiquer avec le Service de Clientèle de Pioneer:

Pioneer électroniques du Canada, Inc.
Département de service au consommateurs
300 Allstate Parkway, Markham, Ontario L3R
OP2
(905) 479-4411
1-877-283-5901

Pour obtenir des renseignements sur la garantie, veuillez vous reporter au feuillet sur la Garantie Limitée qui accompagne le produit.



Dear Customer:

Selecting fine audio equipment such as the unit you've just purchased is only the start of your musical enjoyment. Now it's time to consider how you can maximize the fun and excitement your equipment offers. This manufacturer and the Electronic Industries Association's Consumer Electronics Group want you to get the most out of your equipment by playing it at a safe level. One that lets the sound come through loud and clear without annoying blaring or distortion-and, most importantly, without affecting your sensitive hearing.

Sound can be deceiving. Over time your hearing "comfort level" adapts to higher volumes of sound. So what sounds "normal" can actually be loud and harmful to your hearing. Guard against this by setting your equipment at a safe level BEFORE your hearing adapts.

To establish a safe level:

- Start your volume control at a low setting.
- Slowly increase the sound until you can hear it comfortably and clearly, and without distortion.

Once you have established a comfortable sound level:

- Set the dial and leave it there.

Taking a minute to do this now will help to prevent hearing damage or loss in the future. After all, we want you listening for a lifetime.

Power cord CAUTION!

Handle the power cord by the plug. Do not pull out the plug by tugging the cord and never touch the power cord when your hands are wet as this could cause a short circuit or electric shock. Do not place the unit, a piece of furniture, etc., on the power cord, or pinch the cord. Never make a knot in the cord or tie it with other cords. The power cords should be routed such that they are not likely to be stepped on. A damaged power cord can cause a fire or give you an electrical shock. Check the power cord once in a while. When you find it damaged, ask your nearest PIONEER authorized service center or your dealer for a replacement.

We Want You Listening For A Lifetime

Used wisely, your new sound equipment will provide a lifetime of fun and enjoyment. Since hearing damage from loud noise is often undetectable until it is too late, this manufacturer and the Electronic Industries Association's Consumer Electronics Group recommend you avoid prolonged exposure to excessive noise. This list of sound levels is included for your protection.

Decibel

Level	Example
30	Quiet library, soft whispers
40	Living room, refrigerator, bedroom away from traffic
50	Light traffic, normal conversation, quiet office
60	Air conditioner at 20 feet, sewing machine
70	Vacuum cleaner, hair dryer, noisy restaurant
80	Average city traffic, garbage disposals, alarm clock at two feet.

THE FOLLOWING NOISES CAN BE DANGEROUS UNDER CONSTANT EXPOSURE

90	Subway, motorcycle, truck traffic, lawn mower
100	Garbage truck, chain saw, pneumatic drill
120	Rock band concert in front of speakers, thunderclap
140	Gunshot blast, jet plane
180	Rocket launching pad

Information courtesy of the Deafness Research Foundation.



Maintenance of External Surfaces

- Use a polishing cloth or dry cloth to wipe off dust and dirt.
- When the surfaces are dirty, wipe with a soft cloth dipped in some neutral cleanser diluted five or six times with water, and wrung out well, and then wipe again with a dry cloth. Do not use furniture wax or cleaners.
- Never use thinners, benzine, insecticide sprays or other chemicals on or near this unit, since these will corrode the surfaces.

Published by Pioneer Electronic Corporation.
Copyright © 1999 Pioneer Electronic Corporation.
All rights reserved.

PIONEER ELECTRONIC CORPORATION 4-1, Meguro 1-Chome, Meguro-ku, Tokyo 153-8654, Japan

PIONEER ELECTRONICS [USA] INC. P.O. BOX 1540, Long Beach, California 90801-1540, USA

PIONEER ELECTRONICS OF CANADA, INC. 300 Allstate Parkway, Markham, Ontario L3R 0P2, Canada

PIONEER ELECTRONIC [EUROPE] N.V. Haven 1087, Keetberglaan 1, 9120 Melsele, Belgium TEL: 03/570.05.11

PIONEER ELECTRONICS AUSTRALIA PTY. LTD. 178-184 Boundary Road, Braeside, Victoria 3195, Australia, TEL: 03-9586-6300

PIONEER ELECTRONICS DE MEXICO S.A. DE C.V. San Lorenzo Num 1009 3er piso Desp. 302 Col. Del Valle, Mexico D.F. C.P. 03100 TEL: 5-688-52-90

Free Manuals Download Website

<http://myh66.com>

<http://usermanuals.us>

<http://www.somanuals.com>

<http://www.4manuals.cc>

<http://www.manual-lib.com>

<http://www.404manual.com>

<http://www.luxmanual.com>

<http://aubethermostatmanual.com>

Golf course search by state

<http://golfingnear.com>

Email search by domain

<http://emailbydomain.com>

Auto manuals search

<http://auto.somanuals.com>

TV manuals search

<http://tv.somanuals.com>