



Pioneer *sound.vision.soul*

AUDIO/VIDEO MULTI-CHANNEL
RECEIVER

VSX-D711

VSX-D811S



Operating Instructions





WARNING: THE APPARATUS IS NOT WATERPROOFS, TO PREVENT FIRE OR SHOCK HAZARD, DO NOT EXPOSE THIS APPLIANCE TO RAIN OR MOISTURE AND DO NOT PUT ANY WATER SOURCE NEAR THIS APPARATUS, SUCH AS VASE, FLOWER POT, COSMETICS CONTAINER AND MEDICINE BOTTLE ETC.

H001AEn

[For Canadian model]

CAUTION: TO PREVENT ELECTRIC SHOCK, DO NOT USE THIS (POLARIZED) PLUG WITH AN EXTENSION CORD, RECEPTACLE OR OTHER OUTLET UNLESS THE BLADES CAN BE FULLY INSERTED TO PREVENT BLADE EXPOSURE.

ATTENTION: POUR PREVENIR LES CHOCS ELECTRIQUES NE PAS UTILISER CETTE FICHE POLARISEE AVEC UN PROLONGATEUR UNE PRISE DE COURANT OU UNE AUTRE SORTIE DE COURANT, SAUF SI LES LAMES PEUVENT ETRE INSEREES A FOND SANS EN LAISSER AUCUNE PARTIE A DECOUVERT.

H007A2L

[For Canadian model]

This Class B digital apparatus complies with Canadian ICES-003.

[Pour le modèle Canadien]

Cet appareil numérique de la classe B est conforme à la norme NMB-003 du Canada.

H009 2L

If the socket outlets on the associated equipment are not suitable for the plug supplied with the product, the plug must be removed and an appropriate one fitted. Replacement and mounting of an AC plug on the power supply cord of this unit should be performed only by qualified service personnel. The cut-off plug must be disposed of as an electrical shock hazard could exist if connected to a socket outlet.

H022AEn

[For U.S. model]



ENERGY STAR® and the ENERGY STAR certification mark are registered US marks.

K001A_En

CAUTION:

THE STANDBY/ON BUTTON IS SECONDARY CONNECTED AND THEREFORE DOES NOT SEPARATE THE UNIT FROM MAINS POWER IN STANDBY POSITION. THEREFORE INSTALL THE UNIT SUITABLE PLACES EASY TO DISCONNECT THE MAINS PLUG IN CASE OF THE ACCIDENT. THE MAINS PLUG OF UNIT SHOULD BE UNPLUGGED FROM THE WALL SOCKET WHEN LEFT UNUSED FOR A LONG PERIOD OF TIME.

H017BEn

Thank you for buying this Pioneer product. Please read through these operating instructions so you will know how to operate your model properly. After you have finished reading the instructions, put them away in a safe place for future reference.

IMPORTANT NOTICE

H006AEn

The serial number for this equipment is located in the rear panel. Please write this serial number on your enclosed warranty card and keep it in a secure area. This is for your security.

NOTE: This equipment has been tested and found to comply with the limits for a Class B digital device, pursuant to Part 15 of the FCC Rules. These limits are designed to provide reasonable protection against harmful interference in a residential installation. This equipment generates, uses, and can radiate radio frequency energy and, if not installed and used in accordance with the instructions, may cause harmful interference to radio communications. However, there is no guarantee that interference will not occur in a particular installation. If this equipment does cause harmful interference to radio or television reception, which can be determined by turning the equipment off and on, the user is encouraged to try to correct the interference by one or more of the following measures:

- Reorient or relocate the receiving antenna.
- Increase the separation between the equipment and receiver.
- Connect the equipment into an outlet on a circuit different from that to which the receiver is connected.
- Consult the dealer or an experienced radio/TV technician for help.

H010 En

Information to User

Alteration or modifications carried out without appropriate authorization may invalidate the user's right to operate the equipment.

H011 En

CAUTION:

This product satisfies FCC regulations when shielded cables and connectors are used to connect the unit to other equipment. To prevent electromagnetic interference with electric appliances such as radios and televisions, use shielded cables and connectors for connections.

H012 En





IMPORTANT



The lightning flash with arrowhead symbol, within an equilateral triangle, is intended to alert the user to the presence of uninsulated "dangerous voltage" within the product's enclosure that may be of sufficient magnitude to constitute a risk of electric shock to persons.

CAUTION

**RISK OF ELECTRIC SHOCK
DO NOT OPEN**

CAUTION:
TO PREVENT THE RISK OF ELECTRIC SHOCK, DO NOT REMOVE COVER (OR BACK). NO USER-SERVICEABLE PARTS INSIDE. REFER SERVICING TO QUALIFIED SERVICE PERSONNEL.



The exclamation point within an equilateral triangle is intended to alert the user to the presence of important operating and maintenance (servicing) instructions in the literature accompanying the appliance.

IMPORTANT SAFETY INSTRUCTIONS

H003 En

READ INSTRUCTIONS — All the safety and operating instructions should be read before the product is operated.

RETAIN INSTRUCTIONS — The safety and operating instructions should be retained for future reference.

HEED WARNINGS — All warnings on the product and in the operating instructions should be adhered to.

FOLLOW INSTRUCTIONS — All operating and use instructions should be followed.

CLEANING — Unplug this product from the wall outlet before cleaning. The product should be cleaned only with a polishing cloth or a soft dry cloth. Never clean with furniture wax, benzene, insecticides or other volatile liquids since they may corrode the cabinet.

ATTACHMENTS — Do not use attachments not recommended by the product manufacturer as they may cause hazards.

WATER AND MOISTURE — Do not use this product near water — for example, near a bathtub, wash bowl, kitchen sink, or laundry tub; in wet basements; or near a swimming pool, and the like.

ACCESSORIES — Do not place this product on an unstable cart, stand, tripod, bracket, or table. The product may fall, causing serious injury to a child or adult, and serious damage to the product. Use only with a cart, stand, tripod, bracket, or table recommended by the manufacturer, or sold with the product. Any mounting of the product should follow the manufacturer's instructions, and should use a mounting accessory recommended by the manufacturer.

CART — A product and cart combination should be moved with care. Quick stops, excessive force, and uneven surfaces may cause the product and cart combination to overturn.



VENTILATION — Slots and openings in the cabinet are provided for ventilation and to ensure reliable operation of the product and to protect it from overheating, and these openings must not be blocked or covered. The openings should never be blocked by placing the product on a bed, sofa, rug, or other similar surface. This product should not be placed in a built-in installation such as a bookcase or rack unless proper ventilation is provided or the manufacturer's instructions have been adhered to.

POWER SOURCES — This product should be operated only from the type of power source indicated on the marking label. If you are not sure of the type of power supply to your home, consult your product dealer or local power company.

LOCATION — The appliance should be installed in a stable location.

NONUSE PERIODS — The power cord of the appliance should be unplugged from the outlet when left unused for a long period of time.

GROUNDING OR POLARIZATION

- If this product is equipped with a polarized alternating current line plug (a plug having one blade wider than the other), it will fit into the outlet only one way. This is a safety feature. If you are unable to insert the plug fully into the outlet, try reversing the plug. If the plug should still fail to fit, contact your electrician to replace your obsolete outlet. Do not defeat the safety purpose of the polarized plug.
- If this product is equipped with a three-wire grounding type plug, a plug having a third (grounding) pin, it will only fit into a grounding type power outlet. This is a safety feature. If you are unable to insert the plug into the outlet, contact your electrician to replace your obsolete outlet. Do not defeat the safety purpose of the grounding type plug.

POWER-CORD PROTECTION — Power-supply cords should be routed so that they are not likely to be walked on or pinched by items placed upon or against them, paying particular attention to cords at plugs, convenience receptacles, and the point where they exit from the product.

OUTDOOR ANTENNA GROUNDING — If an outside antenna or cable system is connected to the product, be sure the antenna or cable system is grounded so as to provide some protection against voltage surges and built-up static charges. Article 810 of the National Electrical Code, ANSINFP A 70, provides information with regard to proper grounding of the mast and supporting structure, grounding of the lead-in wire to an antenna discharge unit, size of grounding conductors, location of antenna-discharge unit, connection to grounding electrodes, and requirements for the grounding electrode. See Figure A.

LIGHTNING — For added protection for this product during a lightning storm, or when it is left unattended and unused for long periods of time, unplug it from the wall outlet and disconnect the antenna or cable system. This will prevent damage to the product due to lightning and power-line surges.

POWER LINES — An outside antenna system should not be located in the vicinity of overhead power lines or other electric light or power circuits, or where it can fall into such power lines or circuits. When installing an outside antenna system, extreme care should be taken to keep from touching such power lines or circuits as contact with them might be fatal.

OVERLOADING — Do not overload wall outlets, extension cords, or integral convenience receptacles as this can result in a risk of fire or electric shock.

OBJECT AND LIQUID ENTRY — Never push objects of any kind into this product through openings as they may touch dangerous voltage points or short-out parts that could result in a fire or electric shock. Never spill liquid of any kind on the product.

SERVICING — Do not attempt to service this product yourself as opening or removing covers may expose you to dangerous voltage or other hazards. Refer all servicing to qualified service personnel.

DAMAGE REQUIRING SERVICE — Unplug this product from the wall outlet and refer servicing to qualified service personnel under the following conditions:

- When the power-supply cord or plug is damaged.
- If liquid has been spilled, or objects have fallen into the product.
- If the product has been exposed to rain or water.
- If the product does not operate normally by following the operating instructions. Adjust only those controls that are covered by the operating instructions as an improper adjustment of other controls may result in damage and will often require extensive work by a qualified technician to restore the product to its normal operation.
- If the product has been dropped or damaged in any way.
- When the product exhibits a distinct change in performance — this indicates a need for service.

REPLACEMENT PARTS — When replacement parts are required, be sure the service technician has used replacement parts specified by the manufacturer or have the same characteristics as the original part. Unauthorized substitutions may result in fire, electric shock, or other hazards.

SAFETY CHECK — Upon completion of any service or repairs to this product, ask the service technician to perform safety checks to determine that the product is in proper operating condition.

WALL OR CEILING MOUNTING — The product should not be mounted to a wall or ceiling.

HEAT — The product should be situated away from heat sources such as radiators, heat registers, stoves, or other products (including amplifiers) that produce heat.

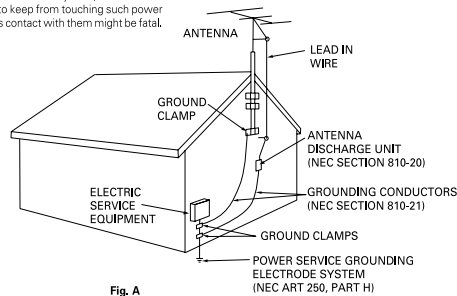



Fig. A

NEC — NATIONAL ELECTRICAL CODE

Manufactured under license from Dolby Laboratories. "Dolby", "Pro Logic II" and the double D symbol  are trademarks of Dolby Laboratories.

"DTS", "ES", and "DTS Digital Surround" are trademarks of Digital Theater Systems, Inc.





Contents

1 Before you start

Checking what's in the box	6
Installing the receiver	6
Making cable connections	6
Loading the batteries	6
Operating range of remote control unit	6

2 5 minute guide

Introduction to home theater	7
Listening to Surround Sound	8
Using the Quick Setup	12

3 Connecting up

Audio/Video cords	13
S-video cables	13
Component video cords	13
Digital audio coaxial cords/ Optical cables	13
Connecting digital components	14
Connecting audio components	16
Connecting DVD 5.1 channel components	17
Connecting video components	18
Connecting to the front panel video terminal	18
Connecting antennas	19
FM wire antenna	19
AM loop antenna	19
Antenna snap connectors	19
Using external antennas	19
To improve FM reception	19
To improve AM reception	19
Connecting the speakers (<i>VSX-D711</i>)	20
Connecting the speakers (<i>VSX-D811S</i>)	21
A and B speaker systems	22
Speaker terminals	22
Hints on speaker placement	22
Connecting additional amplifiers (<i>VSX-D811S</i> only)	24
AC outlet	25
Operating other Pioneer components	25

4 Controls and displays

Front panel	26
Display	27
Remote control	29

5 Playing sources

Introduction to Sound Modes	32
Stereo/Direct	32
Standard mode	32
Advanced Surround modes	33
Choosing the input signal	34
Listening to multi-channel playback	34
Using Stereo/Direct	35
Using Advanced Surround	35
Using Loudness and Midnight listening	36
Using the tone controls	36
Playing other sources	36
Selecting the multi-channel analog inputs	37

6 Setting up your receiver

Choosing your receiver setup	38
Speaker setting	39
Surround back speaker setting (<i>VSX-D811S</i> only)	40
6.1 channel setting (<i>VSX-D811S</i> only)	40
Subwoofer setting	40
Crossover frequency setting	40
LFE attenuator setting	41
Front speaker distance setting	41
Center speaker distance setting	41
Surround speaker distance setting	41
Surround back speaker distance setting (<i>VSX-D811S</i> only)	42
Dynamic range control setting	42
Dual mono setting	42
Component video input settings	42
Surround back channel input setting (<i>VSX-D811S</i> only)	43
Coaxial digital input settings	43
Optical digital input settings	43



Setting the relative volume level
of each channel 44

7 Using the tuner

Listening to the radio 45
 Improving FM stereo sound 45
 Tuning directly to a station 45
 Saving station presets 46
 Naming station presets 47
 Listening to station presets 47

8 Making a recording

Making an audio or a video recording 48
 Monitoring your recording 48

9 Controlling the rest of your system

Setting the remote to control
other components 49
 Selecting preset codes directly 49
 Searching for preset codes 50
 Programming signals from other
remote controls (*VSX-D811S only*) 50
 Erasing one of the remote control
button settings (*VSX-D811S only*) 51
 Clearing all the remote control settings 51
 Direct function 52
 Confirming preset codes 52
 Controls for TVs 53
 Controls for other components 54
 Preset Code List 56

10 Additional information

Troubleshooting 68
 Specifications 70





01

Before you start

Checking what's in the box

Please check that you've received the following supplied accessories:

- AM loop antenna
- FM wire antenna
- Dry cell batteries x 2 (AA size IEC R6P)
- Remote control
- These operating instructions

Installing the receiver

Please note the following points:

- Do not place objects directly on top of this unit. This prevents proper heat dispersal.
- When installing on a rack, shelf, etc., be sure to leave more than 8 inches (20 cm.) of space above the receiver.

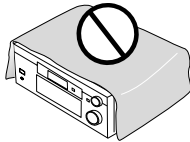

Caution

Incorrect use of batteries may result in such hazards as leakage and bursting. Observe the following precautions:

- Never use new and old batteries together.
- Insert the plus and minus sides of the batteries properly according to the marks in the battery case.
- Batteries with the same shape may have different voltages. Do not use different batteries together.
- When disposing of used batteries, please comply with governmental regulations or environmental public instruction's rules that apply in your country or area.

Operating range of remote control unit

The remote control may not work properly if:

- There are obstacles between the remote control and the receiver's remote sensor.
- Direct sunlight or fluorescent light is shining onto the remote sensor.
- The receiver is located near a device that is emitting infrared rays.
- The receiver is operated simultaneously with another infrared remote control unit.

Making cable connections

Make sure not to bend the cables over the top of this unit (as shown in the illustration). If this happens, the magnetic field produced by the transformers in this unit may cause a humming noise from the speakers.

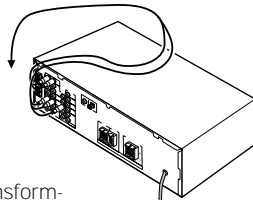

Loading the batteries

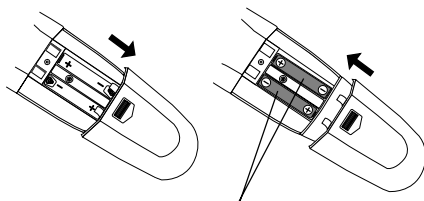

Dry cell batteries x 2 (AA size IEC R6P)

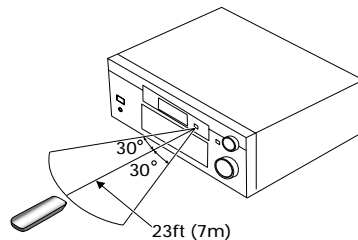



Introduction to home theater

You are probably used to using stereo equipment to listen to music, but may not be used to home theater systems that give you many more options (such as surround sound) when listening to soundtracks.

Home theater refers to the use of multiple audio tracks to create a surround sound effect, making you feel like you're in the middle of the action or concert. The surround sound you get from a home theater system depends not only on the speakers you have set up in your room, but also on the source and the sound settings of the receiver.

DVD-Video has become the basic source material for home theater due to its size, quality, and ease of use. Depending on the DVD, you can have up to seven different audio tracks coming from one disc, all of them being sent to different speakers in your system. This is what creates a surround sound effect and gives you the feeling of 'being there'.

This receiver will automatically decode Dolby Digital, DTS, or Dolby Surround DVD-Video discs, according to your speaker setup. In most cases, you won't have to make changes for realistic surround sound, but other possibilities (like listening to a CD with multi-channel surround sound) are explained in *Playing sources*, starting on page 32.

Listening to Surround Sound

This receiver was designed with the easiest possible setup in mind, so with the following quick setup guide, you should have your system hooked up for surround sound in no time at all. In most cases, you can simply leave the receiver in the default settings.

1 Hook up your DVD player.

For surround sound, you'll want to hook up using a digital connection from the DVD player to the receiver. You can do this with either a coaxial, or an optical connection (you don't need to do both). If you hook up using an optical cable, you should refer to *Optical digital input setting* on page 43 to assign the optical input to DVD.

Use a video cord to connect the video output on your DVD to the receiver using the jacks shown below.

2 Hook up your TV.

Use a video cord to connect your receiver to the TV using the jacks as shown below.

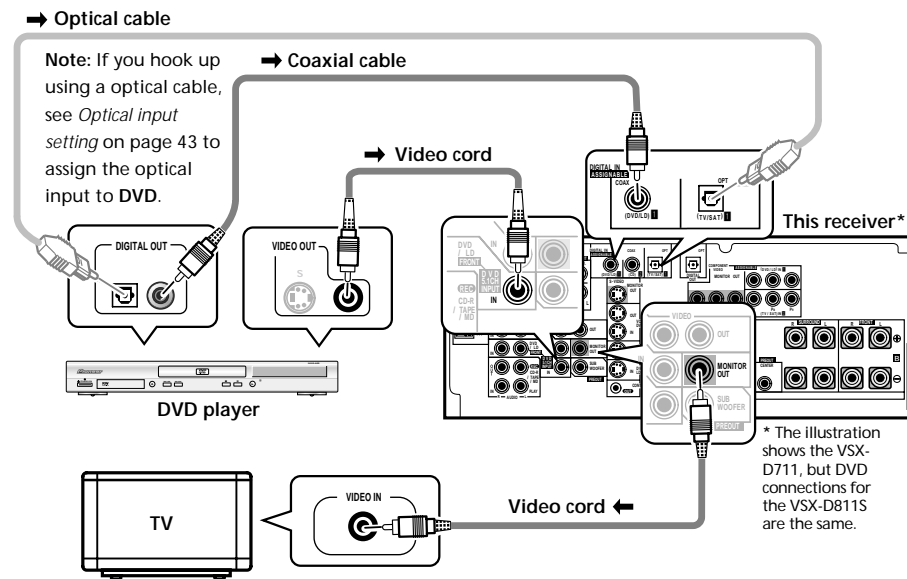



5 minute guide

02

3 Connect your speakers.

A complete setup of speakers is shown here (six speakers (including the subwoofer) for the VSX-D711, and eight (also including the subwoofer) for the VSX-D811S), but everyone's home setup will vary. Simply connect the speakers you have in the manner shown below. The receiver will work with just two stereo speakers (the front speakers in the diagram) but using at least three speakers is recommended, and a complete setup is best.

Make sure you connect the speaker on the right to the right terminal and the speaker on the left to the left terminal. Also make sure the positive and negative (+/-) terminals on the receiver match those on the speakers.

Note

- Use speakers with a nominal impedance of 8 Ω to 16 Ω.
- If you're not using a subwoofer, change the front speaker setting (see *Speaker setting* on page 39) to large
- When using the speaker on your TV as the center speaker (C), connect the **CENTER PREOUT** jack on this unit to the audio input jack on your TV. In this case the center speaker shown is unnecessary.

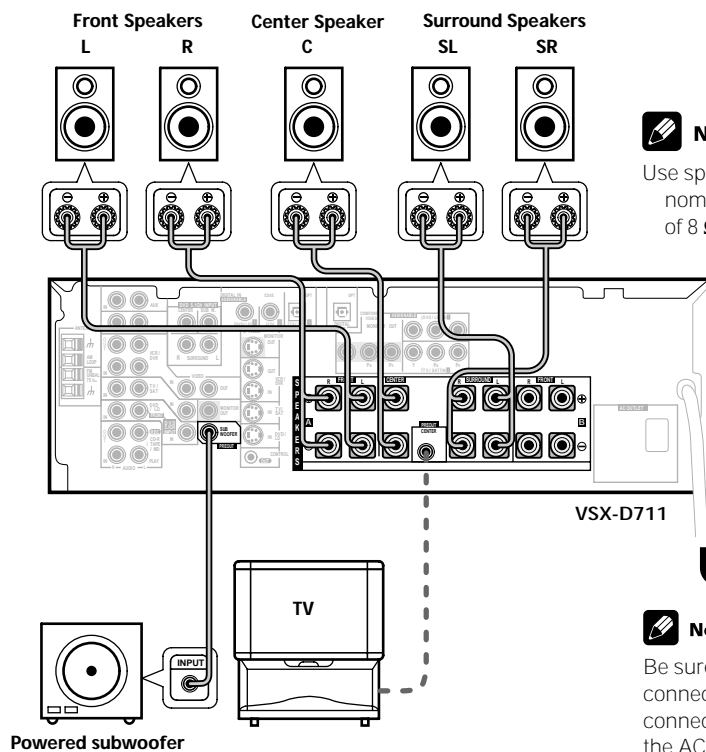

Note

Use speakers with a nominal impedance of 8 Ω to 16 Ω.

Note

Be sure to complete all connections before connecting this unit to the AC power source.

9
En



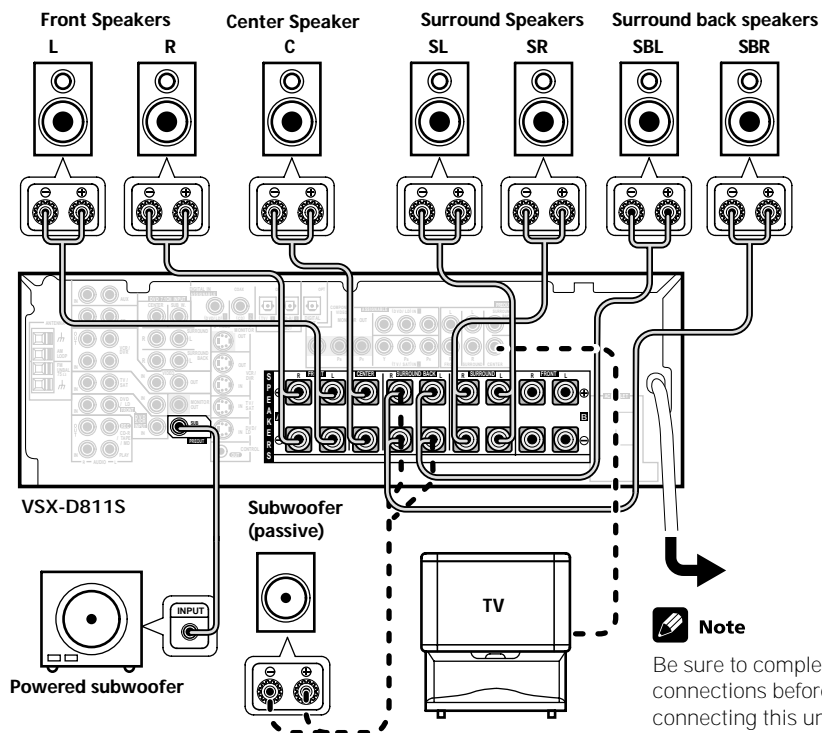

Note

VSX-D811S only

- If you are using only one surround back speaker, connect the positive wire to the right channel (+) terminal, and the negative wire to the left channel (-) terminal (shown at right).
- If you select subwoofer (**SB SUBWF**) in the *Surround back speaker setting* (see page 40) you can hook up a subwoofer instead of speakers to the surround back speaker terminals. Connect the wires just as above (and as shown at right), connecting the positive wire to the right channel (+) terminal, and the negative wire to the left channel (-) terminal.

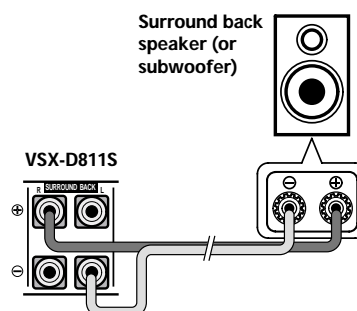



5 minute guide

02

4 Plug in the receiver and switch it on, followed by your DVD player, your subwoofer and the TV.

Make sure you've set the video input on your TV to this receiver. Check the manual that came with the TV if you don't know how to do this.

Also make sure that **DVD/LD** is showing in the receiver's display, indicating that the DVD input is selected. If it isn't, press **DVD/LD** on the remote control to set the receiver to the DVD input.

5 Press **QUICK SETUP** on the front panel to specify your speaker setup and your room size.

Use the **MULTI JOG/INPUT SELECTOR** dial to select and **ENTER** to confirm your selection. See *Using the Quick Setup* on the next page if you're unsure about the settings.

6 Play a DVD, and adjust the volume to your liking.

There are several other sound options you can select. See pages 32–33 for more on this. See also *Choosing your receiver setup* on page 38–43 for more setup options.





Note

Depending on your DVD player or source discs, you may only get digital 2 channel stereo and analog sound. In this case, the listening mode must be set to Standard (it should already be set—see page 34 if you need to do this) if you want multi-channel surround sound.

Using the Quick Setup

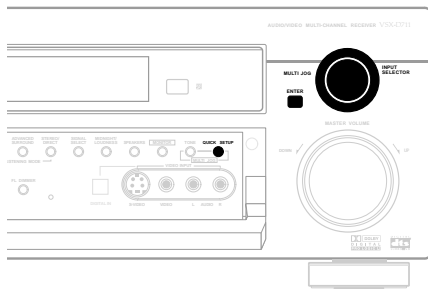
You can use the Quick Setup to get your system up and running with just a few button presses. The receiver automatically makes the necessary settings after you have selected your speaker setup and room size. If you want to make more specific settings, refer to *Choosing your receiver setup* on pages 38–43. Use the front panel controls for the steps below.



1 If the receiver is off, press  STANDBY/ON to turn the power on.

The **STANDBY** indicator goes out.

2 Press QUICK SETUP.

The display prompts you to select your speaker setup.

3 Use the MULTI JOG/INPUT SELECTOR dial to choose your speaker setup.

Cycle between the following choices:

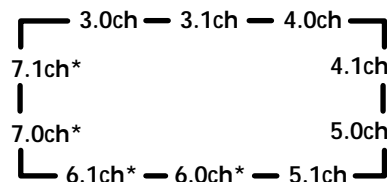

* *VSX-D811S only*

Note

Check the table below to find the speaker setup that corresponds with your system.

	Front Speakers	Center Speaker	Surround Speakers	Surround Back Sp.	Sub Woofer
3.0 ch	√	√			
3.1 ch	√	√			√
4.0 ch	√		√		
4.1 ch	√		√		√
5.0 ch	√	√	√		
5.1 ch	√	√	√		√
6.0 ch*	√	√	√	(1 speaker)	
6.1 ch*	√	√	√	(1 speaker)	√
7.0 ch*	√	√	√	(2 speakers)	
7.1 ch*	√	√	√	(2 speakers)	√

* *VSX-D811S only*

4 Press ENTER.

The display prompts you to select your room size.

5 Use the the MULTI JOG/INPUT SELECTOR dial to choose your room size.

Depending on the distance of your speakers from the listening position, choose between **Small**, **Medium**, or **Large** (see table below).

	S	M	L
Front	12 ft.	12 ft.	12 ft.
Center	10 ft.	10 ft.	10 ft.
Surround	6 ft.	7 ft.	9 ft.
Surround Back*	3 ft.	5 ft.	7 ft.

* *VSX-D811S only*

6 Press ENTER to confirm your setup.

The display shows the speaker setup and room size that you have selected.



Connecting up

03

Before making or changing any connections, switch off the power and disconnect the power cord from the AC outlet.

Audio/Video cords

Use audio/video cords (not supplied) to connect the audio/video components and a video cord to connect the monitor TV.

Connect red plugs to **R** (right), white plugs to **L** (left), and the yellow plugs to **VIDEO**.

Be sure to insert completely.

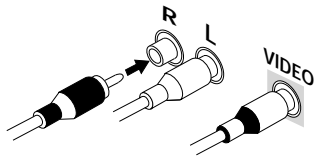

Component video cords

Use component video cords to get the best possible color reproduction of your video source. The color signal of the TV is divided into the luminance (Y) signal and the color (PB and PR) signals and then output. In this way, interference between the signals is avoided. Connect from the component video jacks on the rear of the receiver to the component video jacks on the video component you are hooking up.

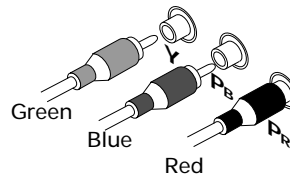

S-video cables

Use S-video cables (not supplied) to get clearer picture reproduction than regular video cords.

Connect from an S-video jack on the rear of the receiver to an S-video jack on the video component you are hooking up.

Be sure to insert completely.

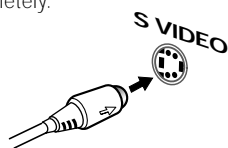

Digital audio coaxial cords/ Optical cables

Commercially available digital audio coaxial cords (standard video cords can also be used) or optical cables (not supplied) are used to connect digital components to this receiver. Be sure to insert completely.

Digital audio coaxial cord (or standard video cord)

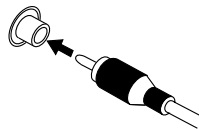

Optical cable

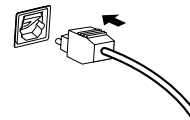

Connecting digital components

The easiest way to hook up this receiver for surround sound is to use a digital input. You can do this by either coaxial or optical connections (you do not need to do both). The quality of these two types of connections is the same but since some digital components only have one type of digital terminal, it is a matter of matching like with like (for example, the coaxial output from the component to coaxial input on the receiver). The VSX-D711 has three digital inputs on the rear panel (two coaxial inputs and a optical input) and the VSX-D811S has four (two coaxial inputs and two optical inputs). Connect your digital components to the rear panel as shown below. See page 18 to connect the front panel optical input on the VSX-D811S.

There is one digital output jack which is marked **DIGITAL OUT**. If you connect this to the optical input on a digital recorder (currently these include MD, DAT and CD-R) you can make direct digital recordings with this unit.

When connecting your equipment, always make sure the power is turned off and the power cord is disconnected from the AC outlet.



Note

The arrows indicate the direction of the audio signal.

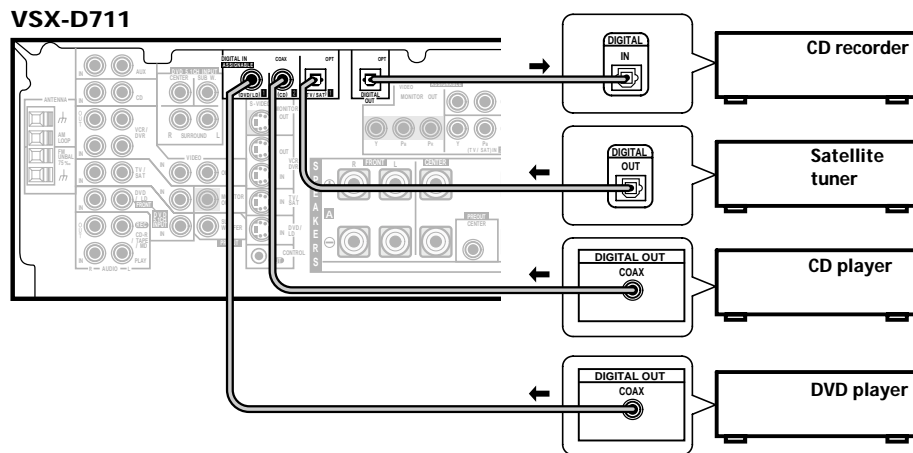



Connecting up

03

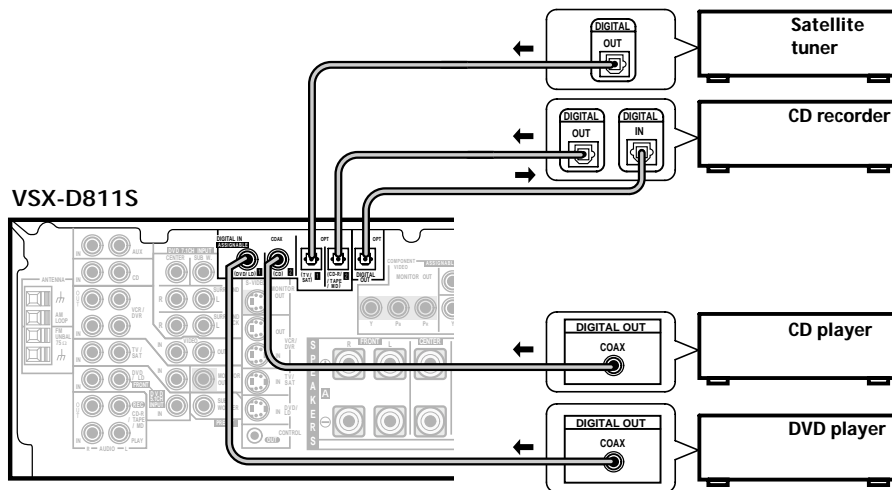

Note

If you have an LD player, you need to make special connections to ensure you can play **LD** RF format LDs on your system. If this is the case, hook up your DVD or LD player directly to an RF demodulator using both the **LD** RF output and either a coaxial or optical digital connection. We also recommend hooking up your digital components to analog audio jacks as well. Make sure the RF demodulator digital in switch is set correctly (optical or coaxial depending on the connection). See the component's instruction manual if you are unsure about its input and output jacks.

Connecting audio components

To begin set up, connect your analog audio components (such as a cassette deck) to the jacks. For components you want to record with, you need to hook up four plugs to the receiver (a set of stereo inputs and a set of stereo outputs), but for components that only play, you only need to hook up one set of stereo plugs. You must also hook up your digital components to analog audio jacks if you want to record to/from digital components (like an MD) to/from analog components. See page 14 for more on digital connections.

When connecting your equipment, always make sure the power is turned off and the power cord is disconnected from the AC outlet.



Note

The arrows indicate the direction of the audio signal.

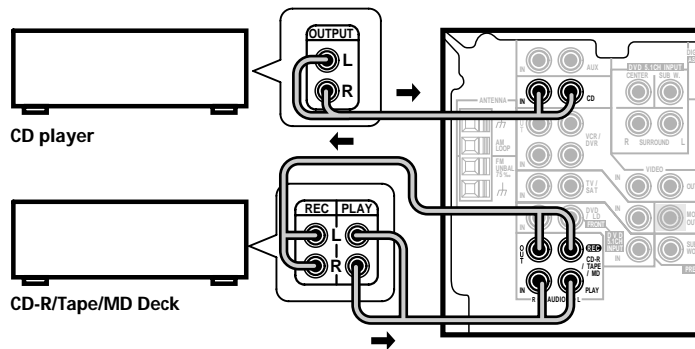



Connecting DVD 5.1 channel components

If you prefer to use a separate component for decoding DVDs, you can connect a decoder or a DVD player with multi-channel analog outputs to the multi-channel inputs of this receiver.

When connecting your equipment, always make sure the power is turned off and the power cord is disconnected from the AC outlet.

Note

The arrows indicate the direction of the signal.

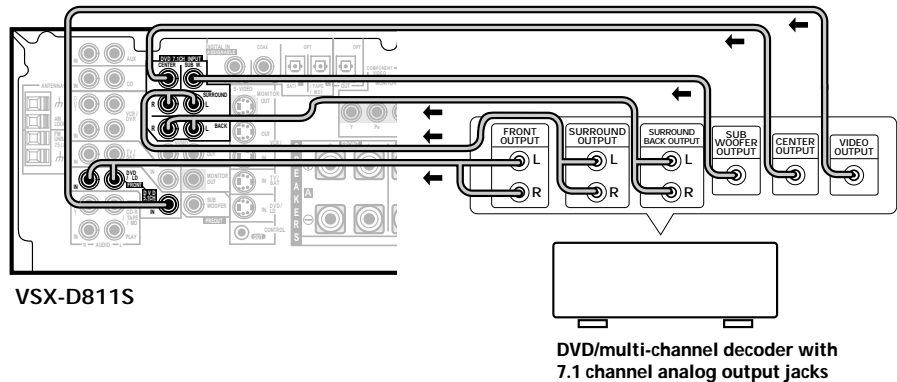
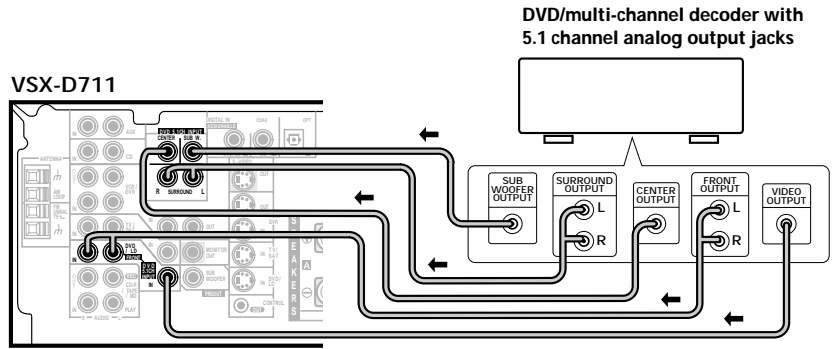

Note

- The multi-channel input can only be used when **DVD 5.1 CH** (or **DVD 7.1 CH**) is selected (see page 37).
- If the component you are connecting (to the VSX-D811S) only has one surround back channel output, change the *Surround back channel input setting* (page 43) to **SB 1ch IN**.



Connecting video components

Connect your video components to the jacks as shown below. With digital video components (like a DVD player), you must use the connections shown on this page for the video signal, but in order to hear a digital source (like a DVD) you should hook up the audio to a digital input (see page 14). It is also a good idea to hook up your digital components with analog audio connections (see page 16).

For better quality video, you can hook up using the component video jacks or the S-video jacks (quality descends in this order) on the rear of the receiver instead of the regular video jacks. Make sure they are connected to the video component using the same kind of connection.

When connecting your equipment, always make sure the power is turned off and the power cord is disconnected from the AC outlet.



Note

The arrows indicate the direction of the signal.

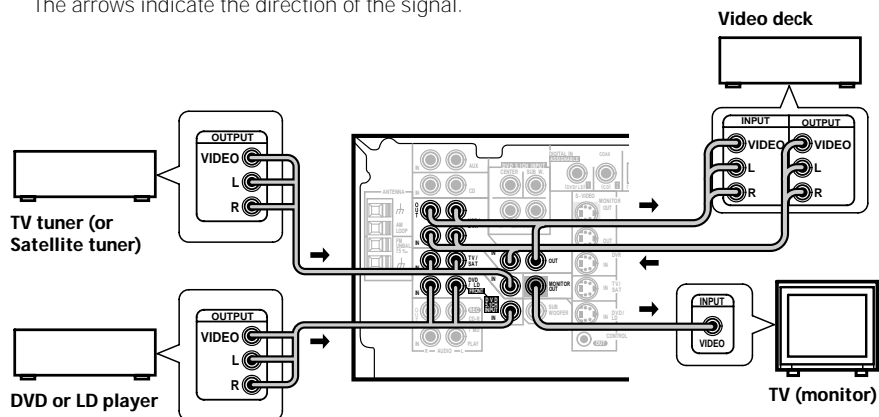

Connecting to the front panel video terminal

Front video connections are accessed via the front panel input selector as **VIDEO**. There are standard audio/video jacks as well as an S-video jack (the VSX-D811S also has an optical input jack). Hook them up the same way you made the rear panel connections.

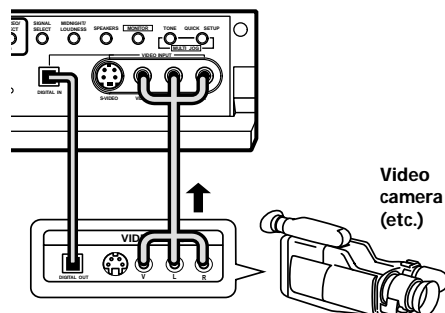



Connecting up

03

Connecting antennas

Connect the AM loop antenna and the FM wire antenna as shown below. To improve reception and sound quality, connect external antennas (see *Using external antennas* below). Always make sure that the receiver is switched off and unplugged from the wall outlet before making or changing any connections.

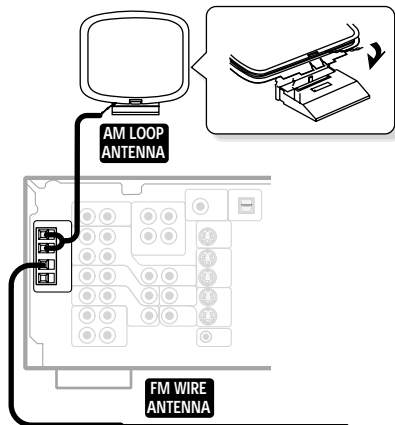

Antenna snap connectors

Twist the exposed wire strands together and insert into the hole, then snap the connector shut.

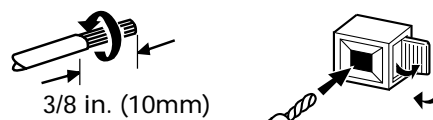

Using external antennas

To improve FM reception

Connect an external FM antenna.

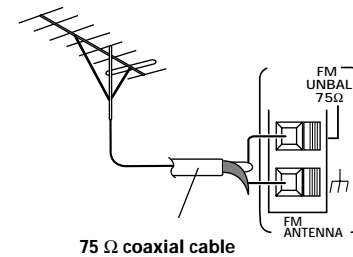

FM wire antenna

Connect the FM wire antenna and fully extend vertically along a window frame or other suitable area, etc.

AM loop antenna

Assemble the antenna and connect to the receiver. Attach to a wall, etc. (if desired) and face in the direction that gives the best reception.

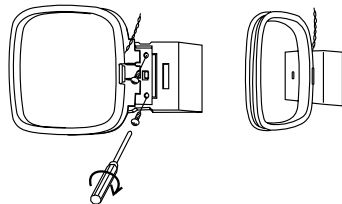

To improve AM reception

Connect a 15-18 feet length of vinyl-coated wire to the AM antenna terminal without disconnecting the supplied AM loop antenna.

For the best possible reception, suspend horizontally outdoors.

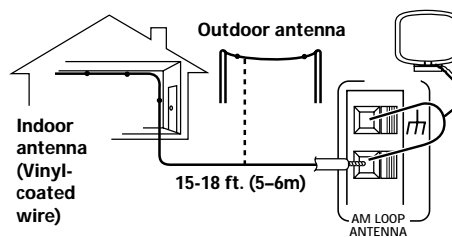

Connecting the speakers (VSX-D711)

A complete setup of six speakers (including the subwoofer) is shown below, but everyone's home setup will vary. Simply connect the speakers you have in the manner shown below. The receiver will work with just two stereo speakers (the front speakers in the diagram) but using at least three speakers is recommended, and a complete setup is best. If you're not using a subwoofer, change the front speaker setting (see *Speaker setting* on page 39) to large.

Make sure you connect the speaker on the right to the right terminal and the speaker on the left to the left terminal. Also make sure the positive and negative (+/-) terminals on the receiver match those on the speakers.

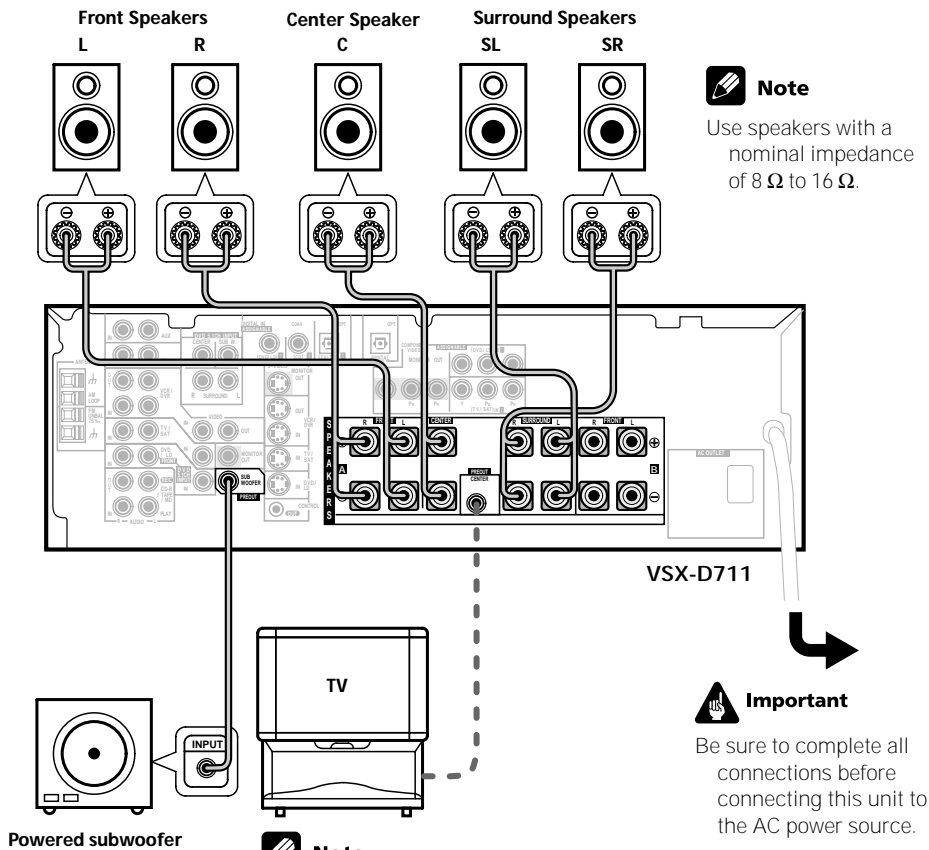

Note

When using the speaker on your TV as the center speaker (C), connect the **CENTER PREOUT** jack on this unit to the audio input jack on your TV. In this case the center speaker shown is unnecessary.



Connecting the speakers (VSX-D811S)

A complete setup of eight speakers (including the subwoofer) is shown below, but everyone's home setup will vary. Simply connect the speakers you have in the manner shown below. The receiver will work with just two stereo speakers (the front speakers in the diagram) but using at least three speakers is recommended, and a complete setup is best for surround sound. If you're not using a subwoofer, change the front speaker setting (see *Speaker setting* on page 39) to large.

Make sure you connect the speaker on the right to the right terminal and the speaker on the left to the left terminal. Also make sure the positive and negative (+/-) terminals on the receiver match those on the speakers.

Note

Use speakers with a nominal impedance of 8 Ω to 16 Ω.

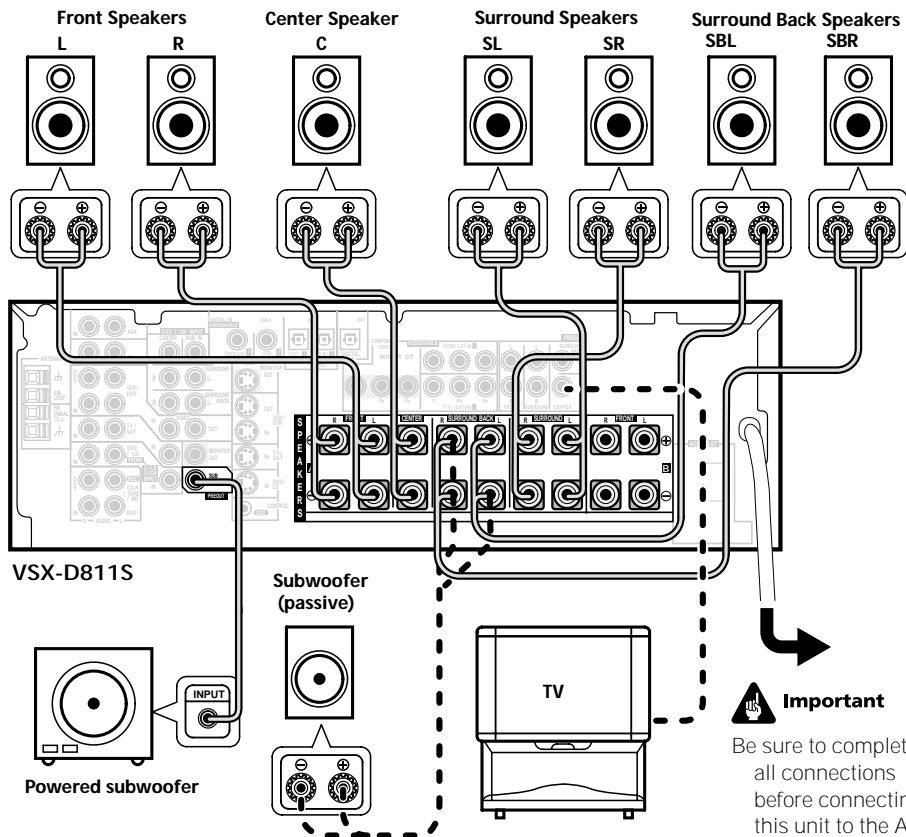

**Note**

- When using the speaker on your TV as the center speaker (**C**), connect the **CENTER PREOUT** jack on this unit to the audio input jack on your TV. In this case the center speaker shown is unnecessary.
- If you are using only one surround back speaker, connect the positive wire to the right channel (+) terminal, and the negative wire to the left channel (-) terminal (see illustration on page 11).
- If you select subwoofer (**SB SUBWF**) in the *Surround back speaker setting* (see page 39) you can hook up a subwoofer instead of speakers to the surround back speaker terminals. Connect the positive wire to the right channel (+) terminal, and the negative wire to the left channel (-) terminal (see illustration on page 11).

Speaker terminals

- 1 **Twist exposed wire strands together.**
- 2 **Loosen speaker terminal and insert exposed wire.**
- 3 **Tighten terminal.**

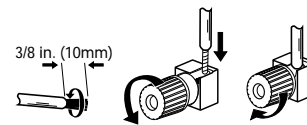

The speaker terminals also accept single banana plugs. (Refer to speaker manual for details.)

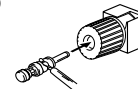
**Caution**

Make sure that all the bare speaker wire is twisted together and inserted fully into the speaker terminal. If any of the bare speaker wire touches the back panel it may cause the power to cut off as a safety measure. Use good quality speaker wire to connect the speakers to the receiver.

A and B speaker systems

The receiver has two speaker systems: A and B. A is the main system supporting the full speaker setup. If you switch on both A and B speaker systems, only the front speakers and the subwoofer will be audible. No sound will come from the center, surround, or surround back speakers, but multi-channel sources will be down-mixed to the active speakers so no sound will be lost. Similarly, if you choose just the B system you'll only hear the front speakers connected to the B system and multi channel sources will be down-mixed to these two speakers.

Hints on speaker placement

Speakers are usually designed with a particular placement in mind. Some are designed to be floorstanding, while others should be placed on stands to sound their best. Some should be placed near a wall; others should be placed away from walls. We have provided a few tips on getting the best sound from your speakers (below), but you should also follow the guidelines on placement that the speaker manufacturer provided with your particular speakers to get the most out of them.

- Place the front left and right speakers at equal distances from the TV.
- When placing speakers near the TV, we recommend using magnetically shielded speakers to prevent possible interference, such as discoloration of the picture when the TV is switched on. If you do not have magnetically shielded speakers and notice discoloration of the TV picture, move the speakers farther away from the TV.



Connecting up

03

- Place the center speaker above or below the TV so that the sound of the center channel is localized at the TV screen.



Caution

If you choose to install the center speaker on top of the TV, be sure to secure it with putty, or by other suitable means, to reduce the risk of damage or injury resulting from the speaker falling from the TV in the event of external shocks such as earthquakes.

- If possible, place the surround speakers slightly above ear level.
- Try not to place the surround speakers further away from the listening position than the front and center speakers. Doing so can weaken the surround sound effect.
- To achieve the best possible surround sound, install your speakers as shown below. Be sure all speakers are installed securely to prevent accidents and improve sound quality.

Overhead view of speaker set up (VSX-D711)

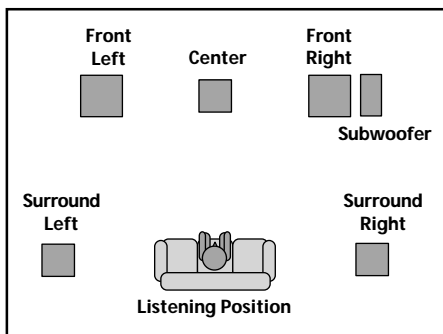

3-D view of speaker set up (VSX-D711)



Overhead view of speaker set up (VSX-D811S)

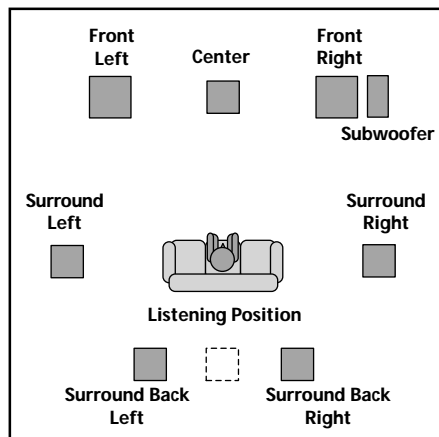

3-D view of speaker set up (VSX-D811S)



23

En

Connecting additional amplifiers (VSX-D811S only)

This receiver has more than sufficient power for any home use, however it is possible to add additional amplifiers to every channel. Make the connections shown below to add amplifiers to power your speakers. Always make sure that the receiver is switched off and unplugged from the wall outlet before making or changing any connections.



Note

The arrows indicate the direction of the audio signal.

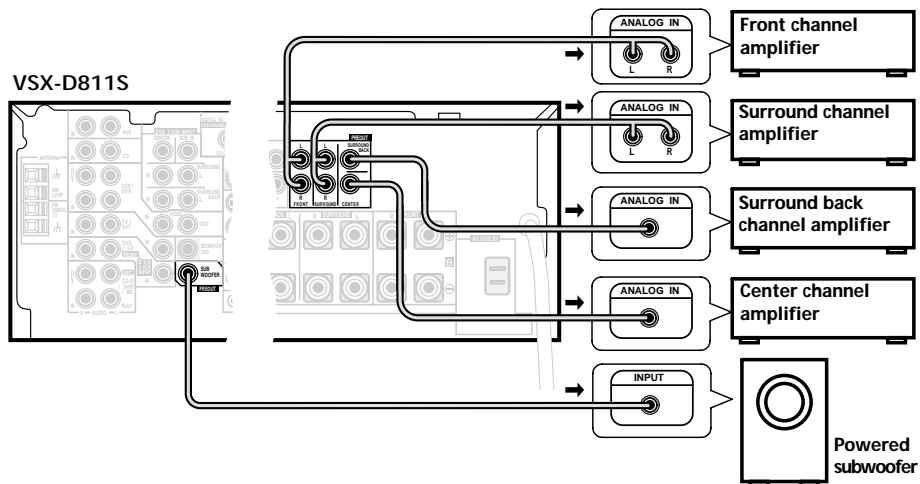

Note

- To hear sound only from the pre-outs, disconnect any speakers that are connected directly to the receiver.
- If you're not using a subwoofer, change the front speaker setting (see *Speaker setting* on page 39) to large.



Connecting up

03

AC outlet

[switched 100 W (0.8 A) max]

Power supplied through this outlet is turned on and off by the receiver's **POWER** switch. Total electrical power consumption of connected equipment should not exceed 100 W (0.8 A).



Caution

DO NOT CONNECT A MONITOR, TV SET, HEATER, OR SIMILAR APPLIANCE TO THIS UNIT'S AC OUTLET.

Do not connect appliances with high power consumption to the AC OUTLET in order to avoid overheating and fire risk. This can also cause the receiver to malfunction.

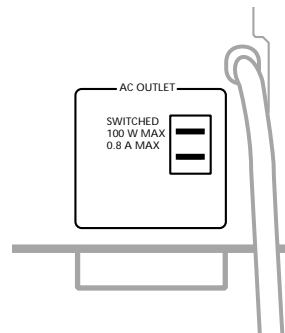

Note

- Make sure no exposed speaker wire is touching the rear panel, this may cause the receiver to turn off automatically.
- This unit should be disconnected by removing the power plug from the wall socket when not in regular use (ex. when on vacation).

POWER-CORD CAUTION

Handle the power cord by the plug. Do not pull out the plug by tugging the cord and never touch the power cord when your hands are wet as this could cause a short circuit or an electric shock. Do not place the unit, a piece of furniture, etc., on the power cord, or pinch the cord. Never make a knot in the cord or tie it with other cords. The power cords should be routed such that they are not likely to be stepped on. A damaged power cord can cause a fire or give you an electrical shock. Check the power cord once in a while. When you find it damaged, ask your nearest Pioneer authorized service center or your dealer for a replacement.

Operating other Pioneer components

By connecting a control cord (optional), you can point the remote controls of other Pioneer components at the receiver's remote sensor. The remote control signals are received by the remote sensor of this unit, and sent to the other devices via the **CONTROL OUT** terminal.

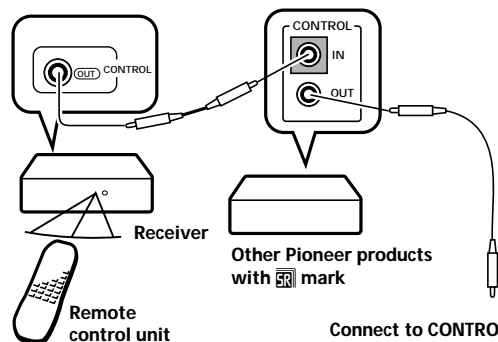

Connect to **CONTROL IN** terminal of other Pioneer products with mark.

25

En



Front panel

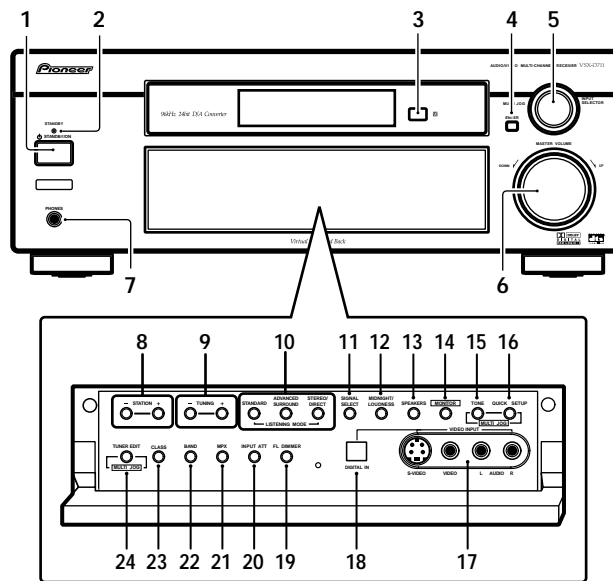

- 1** **STANDBY/ON**
Switches the receiver between on and standby.
- 2** **STANDBY indicator**
Lights when the receiver is in standby.
- 3** **Remote sensor**
Receives the signals from the remote control.
- 4** **ENTER**
- 5** **MULTI JOG/INPUT SELECTOR dial**
The **MULTI JOG/INPUT SELECTOR** dial performs a number of tasks. Use it to select options after pressing **TONE CONTROL**, **QUICK SETUP** or **TUNER EDIT**.
- 6** **MASTER VOLUME**
- 7** **PHONES jack**
Use to connect headphones. When the headphones are connected, there is no sound output from the speakers.
- 8** **STATION (+/-) buttons** (pages 46–47)
Selects station presets when using the tuner.
- 9** **TUNING buttons** (page 45)
Selects the frequency when using the tuner.
- 10** **LISTENING MODE buttons**
STANDARD (pages 32, 34)
Press for Standard decoding and to switch between the various Pro Logic II options.
ADVANCED SURROUND (pages 33, 35)
Use to switch between the various surround modes.
STEREO/DIRECT (pages 32, 35)
Switches direct playback on or off. Direct playback bypasses the tone controls and channel levels for the most accurate reproduction of a source.
- 11** **TUNER EDIT**
- 12** **CLEAR**
- 13** **BAND**
- 14** **MTR**
- 15** **INPUT ATT**
- 16** **FL DIMMER**
- 17** **DIGITAL IN**
- 18** **STEREO**
- 19** **VIDEO**
- 20** **L**
- 21** **AUDIO X**
- 22** **AUDIO X**
- 23** **AUDIO X**
- 24** **AUDIO X**



Controls and Displays

04

11 SIGNAL SELECT (pages 34, 37, 48)

Use to select an input signal.

12 MIDNIGHT/LOUDNESS (page 36)

Use Midnight when listening to movie soundtracks at low volume. Use Loudness to boost the bass and treble at low volume.

13 SPEAKERS

Use to cycle through the speaker system: **A → B → A+B**

14 MONITOR

Press to switch tape monitoring on/off.

15 TONE

Press this button to access the bass and treble controls, which you can then adjust with the **MULTI JOG/INPUT SELECTOR dial**.

16 QUICK SETUP

17 VIDEO INPUT (page 18)

18 DIGITAL IN (VSX-D811S only) (page 18)

19 FL DIMMER

Use this button to make the fluorescent display (FL) dimmer or brighter.

20 INPUT ATT

Use to attenuate (lower) the level of an analog input signal to prevent distortion.

21 MPX (page 45)

Press to receive a radio broadcast in mono.

22 BAND (page 45)

Switches between AM and FM radio bands.

23 CLASS (pages 46–47)

Switches between the three banks (classes) of station presets.

24 TUNER EDIT (pages 46–47)

Press to memorize and name a station for recall using the **STATION +/-** buttons.

Display

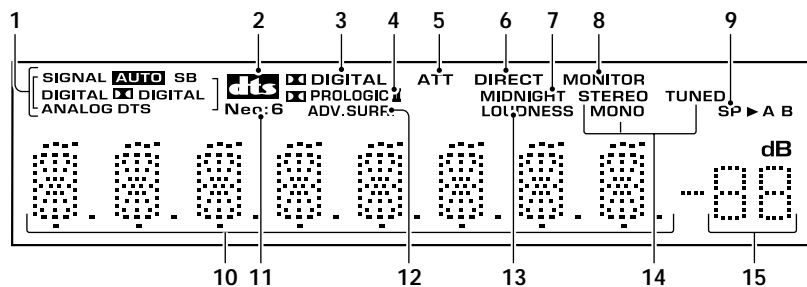

1 SIGNAL SELECT indicators

Lights to indicate the type of input signal assigned for the current component:

AUTO

Lights when AUTO signal select is on

SB (VSX-D811S only)

Depending on the source, this lights when a signal with surround back channel encoding is detected.

DIGITAL

Lights when a digital audio signal is detected.

27

En

DIGITAL

Lights when a Dolby Digital signal is detected.

ANALOG

Lights when an analog signal is detected.

DTS

Lights when a source with DTS audio signals is detected.

2 DTS

When the Standard mode of the receiver is on, this lights to indicate decoding of a DTS signal.

3 DIGITAL

When the Standard mode of the receiver is on, this lights to indicate decoding of a Dolby Digital signal.

4 PRO LOGIC II

When the Standard mode of the receiver is on, this lights to indicate Pro Logic II decoding.

5 ATT

Lights when INPUT ATT is used to attenuate (reduce) the level of the analog input signal.

6 DIRECT

Lights when source direct playback is in use. This function bypasses all tone, balance, Advanced surround, and Dolby Surround effects.

7 MIDNIGHT

Lights during Midnight listening.

8 MONITOR

Lights when **MONITOR** is selected (page 48).

9 Speaker indicator

Shows the speaker system currently in use.

10 Character display**11 Neo:6 (VSX-D811S)**

Lights during NEO:6 processing

12 ADV. SURR (Advanced Surround)

Lights when one of the Advanced Surround modes has been selected.

13 LOUDNESS

Lights when **LOUDNESS** has been selected.

14 TUNER indicators**STEREO:**

Lights when a stereo FM broadcast is being received in auto stereo mode.

MONO:

Lights when the mono mode is set using the **MPX** button.

TUNED:

Lights when a broadcast is being received.

15 Master volume level

Shows the overall volume level. **---dB** indicates the minimum level, and **-0 dB** indicates the maximum level.

Depending on your level settings for each channel, the maximum level can range between -10 dB and -0 dB.



Remote control

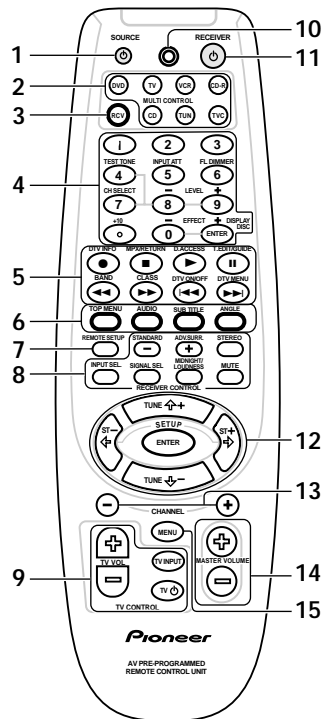

- 1** **SOURCE**
Press to turn on/off other components connected to the receiver.
- 2** **MULTI CONTROL buttons**
Press to select control of other components (see *Controlling the Rest of Your System* on pages 49–52).
- 3** **RCV**
Switches the remote to controls the receiver (used to select the features above the number buttons. (ex. **INPUT ATT**, **FL. DIMMER**). Also use this button to set up surround sound (pages 38, 44).

4 Number buttons/Receiver controls/ENTER

Use the number buttons to directly select a radio frequency (page 45) or the tracks on a CD, DVD, etc.

DISPLAY/DISC (ENTER)

The button's use depends on the component selected. It can be used to switch the display between the station preset name and the frequency for the tuner, enter commands for TV or DTV, and can also be used to select a disc in a multi-CD player.

Receiver Controls

Press the **RCV** button first to access the functions above the number buttons. The display flashes when it isn't possible to use a function.

TEST TONE (page 44)

Sounds the test tone when setting up the surround sound of the receiver.

INPUT ATT

Attenuates (lowers) the level of an analog input signal to prevent distortion (when the overload indicator lights).

FL DIMMER

Dims or brightens the display.

CH SELECT (page 44)

Selects a speaker when setting up the surround sound of the receiver.

LEVEL +/- (page 44)

Adjusts the levels of the surround sound of the receiver.

EFFECT +/- buttons (page 35)

Adds or subtracts the amount of effect with different advanced listening modes (except 5 or 6 Ch Stereo and Virtual SB).



5 Component/Tuner controls

The main buttons (▶, ■, etc.) are used to control a component after you have selected it using the **MULTI CONTROL** buttons. The tuner/DTV controls above these buttons can be accessed after you have selected the corresponding **MULTI CONTROL** button (**TUNER** or **DVD** (when connected to DTV)).

DTV INFO

Use to bring up information screens on a digital TV.

MPX/RETURN (page 45)

Switches between stereo and mono reception of FM broadcasts. If the signal is weak then switching to mono will improve the sound quality. Also acts as a stop button for CDs, tapes, or DVDs.

D. ACCESS (page 49)

After pressing, you can access a radio station directly using the number buttons.

T. EDIT/GUIDE (page 46–47)

Press to memorize and name a station for recall using the **STATION +/-** buttons. Also displays the guides on a digital TV.

BAND (page 45)

Switches between the tuner AM and FM bands.

CLASS (page 46–47)

Switches between the three banks (classes) of radio station presets.

DTV ON/OFF

Switches a digital TV on/off.

DTV MENU

Displays menus on a digital TV.

6 DVD controls (Press DVD first to access)

These controls will also function as DTV controls, depending on the component you've selected.

TOP MENU

Displays the disc 'top' menu of a DVD.

AUDIO

Changes the audio language or channel.

SUBTITLE

Displays/changes the subtitles included in multilingual DVD-Video discs.

ANGLE

Switches camera angles on discs with multi-angle scenes.

7 REMOTE SETUP (pages 49–52)

Press this button to set up the remote control to control other components.

8 RECEIVER CONTROL buttons

STANDARD (pages 32, 34)

Press to switch between the various Dolby/DTS modes

ADV. SURR. (pages 33, 35)

Use to switch between the various surround modes.

STEREO (pages 32, 35)

Switches direct playback on or off. Direct playback bypasses the tone controls and channel levels for the most accurate reproduction of a source.

INPUT SELECT

Use to select the input source.

SIGNAL SELECT (pages 34, 37, 48)

Use to select between an input signal.



Controls and Displays

04

MIDNIGHT/LOUDNESS (page 36)

Switches to Midnight or Loudness listening.

MUTE

Mutes the sound (or restores the sound if it has been muted).

9 TV control buttons

These buttons can only be used to control your TV.

TV VOLUME +/-

Use to adjust the volume on your TV.

TV INPUT

Use select the TV function.

TV

Use to turn on/off the power of the TV.

10 LED DISPLAY

This display flashes when a command is sent from the remote control.

11 RECEIVER

This switches between standby and on for this receiver.

12 **(TUNE/ST +/-) /ENTER**

Use the arrow buttons when setting up your surround sound system (see pages 38–43). Also used to control DVD menus/options and for deck 1 of a double cassette deck player. Use the **TUNE +/-** buttons to find radio frequencies and use **ST +/-** to find preset stations (page 45–47).

13 CHANNEL +/-

Select radio station presets. Also skip tracks backward or forward on CDs, DVDs, etc.

14 MASTER VOLUME +/-

Use to set the listening volume.

15 MENU button

Displays the disc menu of DVD-Video discs. It also displays TV and DTV menus.

31

En

Introduction to Sound Modes

There are three basic sound options: Stereo/Direct, Standard or Advanced Surround.

Stereo/Direct

When you select **STEREO** or **DIRECT**, you will hear the source through just the front left and right speakers (and possibly your subwoofer depending on your speaker settings). Dolby Digital and DTS multichannel sources are downmixed to stereo.

In **STEREO**, you'll hear the audio with your surround settings and you can still use the Midnight, Loudness, and Tone control functions.

With **DIRECT**, you will bypass all effects and surround settings so that the audio remains as close to the source audio signal as possible.





Note

If you switch on Midnight listening, Loudness, or the Tone controls when **DIRECT** is selected, the receiver automatically switches to **STEREO**.

Standard mode

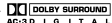
The standard mode can be used to decode Dolby Digital, DTS, or Dolby Surround sources. The other surround sound options (next column) can add multi-channel sound to regular stereo sources.

You can identify Dolby Digital software by the  or  marks. Most Dolby Surround software is marked , but unmarked software may also incorporate Dolby Surround. Depending on the source, the *6.1 channel setting* (page 40), and the sound mode you have selected, you may not get sound from the surround back speakers in your setup. For more on this, refer to the table on the next page.

Choose one of the following to add depth to a 2 channel source:

Pro Logic

This mode gives 4.1 channel surround sound. It is less sensitive to the quality of the source material, so may be useful when Pro Logic II Movie/ Music modes don't give good results.

Pro Logic II Movie

This mode gives 5.1 channel surround sound. It is suitable for movies, especially those recorded in Dolby Surround. The channel separation and movement of surround effects is comparable to Dolby Digital 5.1.

Pro Logic II Music

This mode gives 5.1 channel surround sound and is suitable for music. The surround effect is more enveloping than Pro Logic II Movie.

Neo:6 Cinema (VSX-D811S only)

This mode gives 6.1 channel surround sound and is suitable for movies. The Neo:6 Cinema mode delivers good channel separation for movie soundtracks.

Neo:6 Music (VSX-D811S only)

This mode gives 6.1 channel surround sound and is suitable for music. The Neo:6 Music mode plays the stereo source as is through the front left/right speakers, and generates a natural, ambient surround and center sound.



Advanced Surround modes

These are designed to be used with multi-channel surround sound audio/visual sources (like DVDs and LDs). Most Advanced Surround modes are designed to be used with film soundtracks, but some modes are also suited for music sources. Try different settings with various soundtracks to see which you like.



Note

Depending on the source, the *6.1 channel setting* (page 40), and the sound mode you have selected, you may not get sound from the surround back speakers in your setup. For more on this, refer to the table below.

Movie

Simulates the relaxed environment of a movie theater, and is suitable for watching movies.

Music

Simulates the acoustic environment of a large concert hall and is suitable for music or musical sources.

Virtual Surround Back (VIRTL SB)

The Virtual Surround Back effect simulates 7.1 surround channel listening, giving the impression that there are two surround back speakers in your system when listening to a 5.1 channel source.

Expanded

This mode is especially designed to give sound depth to stereo sources, and lets you hear two-channel (stereo) signals as simulated multi-channel surround sound. Use with Dolby Pro Logic for a stereo surround effect. You can also use with Dolby Digital sources for a wider stereo field than the Standard modes.

5-Channel Stereo (VSX-D711)

This can be selected to give multi-channel sound to a stereo source, using all of the speakers in your setup.

6-Channel Stereo (VSX-D811S)

This can be selected to give multi-channel sound to a stereo source, using all of the speakers in your setup.

Type of source	6.1 ch. setting	Standard	Advanced Movie/Music	Virtual SB	Expanded	6 Ch. Stereo
DTS-ES/Dolby Digital Matrix encoded multi-channel sources with 6.1 surround	Auto	√	√		√	√
	Fix	√	√		√	√
Dolby Digital/DTS encoded multi-channel sources with stereo surround	Auto					√
	Fix	√	√		√	√
Dolby Digital/DTS encoded multi-channel sources with mono surround, Stereo sources	Auto					√
	Fix		√			√
Analog 2-channel (stereo) source	Auto					√
	Fix		√			√



Note

- The checkmark (√) indicates when sound will be output from the surround back speaker(s).
- See the *6.1 channel setting* on page 40 to select between **AUTO** or **FIX**.

Choosing the input signal

You need to hook up a component to both analog and digital inputs on the rear of the receiver to select between input signals.

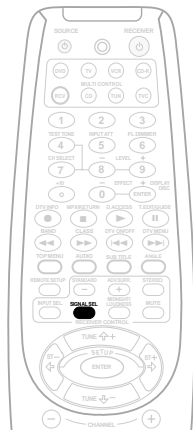

- Press **SIGNAL SEL (SIGNAL SELECT)** to select the input signal corresponding to the source component.

Each press switches between **AUTO**, **DVD 5.1 ch/DVD 7.1ch**, **ANALOG** and **DIGITAL**. The default is **AUTO**.

DVD 5.1ch (VSX-D711) and **DVD 7.1ch** (VSX-D811S) will only appear when **DVD/LD** is selected using the remote or the **MULTI JOG/INPUT SELECTOR** dial on the front panel.

When set to **DIGITAL**, **DIGITAL** lights when a Dolby Digital signal is input, and **DTS** lights when a DTS signal is input.

Note

- This receiver can only play back Dolby Digital, PCM (32kHz, 44kHz, 48kHz, and 96 kHz) and DTS digital signal formats. With other digital signal formats, set to **ANALOG**.

- You may get digital noise when a LD or CD player compatible with DTS is playing an analog signal. To prevent noise, make the proper digital connections (page 14) and set the signal input to **DIGITAL**.
- Some DVD players don't output DTS signals. For more details, refer to the instruction manual supplied with your DVD player.

Listening to multi-channel playback



- 1 Switch on the playback component.**
- 2 Select the source you want to playback.** Use the **MULTI CONTROL** buttons on the remote (or **MULTI JOG/INPUT SELECTOR** dial on the front panel).
- 3 Press STANDARD.** If the source is Dolby Digital, DTS, or Dolby Surround encoded, the proper decoding format will automatically be selected and shows in the display.



Playing sources

05

If you are listening to a two channel source, each press changes the display as follows:

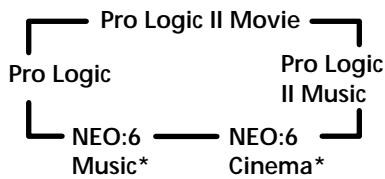

* VSX-D811S only

Refer to page 32 for more details about each mode.

- 4 Start playback of the component you selected in step 1.

Using Stereo/Direct

When you select **STEREO** or **DIRECT**, you will hear the source through just the front left and right speakers (and possibly your subwoofer depending on your speaker settings). Dolby Digital and DTS multichannel sources are downmixed to stereo. See page 32 for more on these modes.

- Press **STEREO (STEREO/DIRECT on the front panel)** repeatedly to switch between the two options.

Note

If you switch on Midnight listening, Loudness, or the Tone controls when **DIRECT** is selected, the receiver automatically switches to **STEREO**.

Using Advanced Surround

When you select one of the Advanced surround options, Dolby Pro Logic, Dolby Digital and DTS decoding is done automatically corresponding to the input signal. Use Advanced surround to add effects to the surround sound.

- Press **ADV.SURR. (ADVANCED SURROUND)** repeatedly to cycle the sound options.

Each press changes the display as follows:

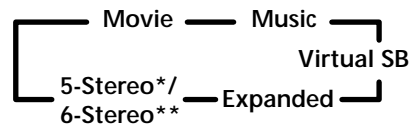

* VSX-D711

** VSX-D811S

Refer to page 33 for more details about each surround effect.

Note

The Advanced surround effects can be adjusted in the range of 10 to 90 (the default setting is 70) by pressing **RCV** then pressing **EFFECT +/-**. The effect level can be set for each Advanced surround mode. The Standard mode cannot be changed.

Using Loudness and Midnight listening

The Loudness listening feature can be used to get good bass and treble from music sources at low volume levels.

The Midnight listening feature allows you to hear effective surround sound of movies at low volume levels. The effect automatically adjusts according to the volume at which you're listening.

- Press **MIDNIGHT/LOUDNESS**. Each press cycles through the effects as follows:

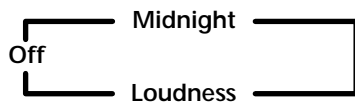

Using the tone controls

Depending on what you are listening to, you may want to adjust the bass or treble using the front panel tone control.

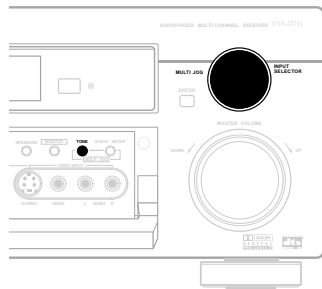

- 1 Press **TONE** to select the frequency you want to adjust. Each press switches between **BASS** and **TREBLE**.

- 2 Use the **MULTI JOG/INPUT SELECTOR** dial to change the amount of bass or treble as necessary.

Wait about five seconds for your changes to be input automatically.

Playing other sources

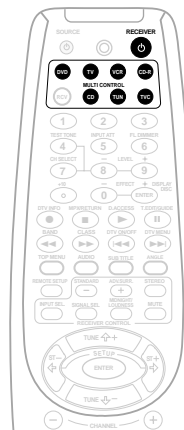

- 1 Turn on the power of the playback component.
- 2 Turn on the power of the receiver.
- 3 Select the source you want to playback. Use the **MULTI CONTROL** buttons on the remote (or **MULTI JOG/INPUT SELECTOR** dial on the front panel).
- 4 Start playback of the component you selected in step 1.



Selecting the multi-channel analog inputs

If you have connected a decoder or a DVD player with multi-channel analog outputs to this receiver (page 17), you must select the analog multi-channel inputs for surround sound playback.

- When playback from the multi-channel inputs is selected, only the volume and channel levels can be set.

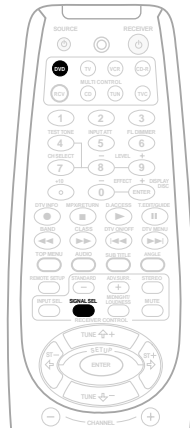

- 1 Press **DVD** or select it with the **MULTI JOG/INPUT SELECTOR** dial (front panel).
- 2 Press **SIGNAL SEL (SIGNAL SELECT)** repeatedly to select **DVD 5.1ch/DVD 7.1ch**. To cancel playback from the multi-channel inputs, use the **SIGNAL SEL (SIGNAL SELECT)** button to select a different input signal.

Note

- When playback from the multi-channel inputs is selected, you can't use the **INPUT ATT**, **TONE**, and **MIDNIGHT/LOUDNESS** buttons, as well as the Standard, Advanced Surround, and Stereo/Direct sound modes.

Choosing your receiver setup

To ensure the best possible surround sound, be sure to complete the following set up operations. This is particularly important when using Dolby surround. You only need to make these settings once (unless you change the placement of your current speaker system or add new speakers, etc.). Refer to the following pages for details on each of the settings.

Note

If you are using the Pioneer S-FCRW220 speaker system, you'll have to set the Crossover frequency to 200kHz. You can leave the Speaker setting and the Subwoofer setting in the default settings.



1 Press **RECEIVER** to turn the power on. The **STANDBY** indicator goes out.

2 Press **RCV**.

3 Use **←** or **⇒** to choose the option you want to adjust.

It will be easiest to adjust each of the settings in turn, following the order below (and on the following pages). The current setting is shown for each option as you cycle through the display.

Speaker setting (page 39)

Specify the number and type of speakers you have connected.

Surround back speaker setting (VSX-D811S only) (page 40)

Specify your surround back speaker/surround back subwoofer setup.

6.1 channel setting (VSX-D811S only) (page 40)

Set when 6.1 channel decoding is used.

Subwoofer setting (page 40)

Specify how the subwoofer is used.

Crossover frequency setting (page 40)

Determine which frequencies will be sent to the subwoofer (or large speakers).

LFE attenuator setting (page 41)

Specify the peak level for the LFE channel.

Front speaker distance setting (page 41)

Specify the distance from your listening position to your front speakers.

Center speaker distance setting (page 41)

Specifies the distance from your listening position to your center speaker.

Surround speaker distance setting (page 41)

Specify the distance from your listening position to your surround speakers.

Surround back speaker distance setting (VSX-D811S only) (page 42)

Specifies the distance from your listening position to your surround back speakers.



Setting up the receiver

06

Dynamic range control setting (page 42)

Compress the dynamic range of the sound track.

Dual mono setting (page 42)

Isolate one channel when listening to discs with dual mono encoding.

Component video input setting (page 42)

Specify the components to be assigned to the component video inputs (below).

- Component video 1 input setting
- Component video 2 input setting

Surround back channel input setting (VSX-D811S only) (page 43)

Specify the number of surround back inputs you have connected.

Digital input settings (page 43)

Specify the components to be assigned to the video and digital inputs (below).

- Coaxial digital input 1 setting
- Coaxial digital input 2 setting
- Optical digital input 1 setting
- Optical digital input 2 setting (VSX-D811S only)

4 Use \uparrow or \downarrow to adjust the setting.

The setting is entered automatically.

5 Repeat steps 3 and 4 to set other surround modes.

6 When you're done, press ENTER to exit.



Note

The setting display is automatically exited after 20 seconds of inactivity.

Speaker setting

- Default setting: **S** (all speakers)

You must let the receiver know how many speakers you have, and how big they are. The size you choose (large or small) determines how much bass is sent from the receiver to the speakers.

In the display, **F**, **C**, and **S** refer to front, center, and surround speakers respectively. Speaker size is denoted as **L** for large speakers, **S** for small speakers, and * (asterisk) if no speaker is connected.



Note

- If the cone size (diameter) of the speaker is larger than 5 inches, set the speaker size to **L**.
- If you're not using a subwoofer, we recommend setting the front speakers to **L**.

- Cycle through the available choices using \uparrow or \downarrow and choose a configuration that matches your speaker setup.

One of the following configurations should match your setup:

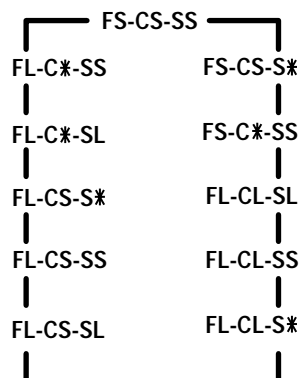

Surround back speaker setting

(VSX-D811S only)

- Default setting: **S**

You must let the receiver know if surround back speaker(s) have been connected, and how big they are. The size you choose (large or small) determines how much bass is sent from the receiver to the speakers. If you have connected a surround back subwoofer, you should select the surround back subwoofer setting (**SB SUBWF**) from the options. Choose ***** (asterisk) if no speaker is connected.

- Use **↑** or **↓** to select **SB L**, **SB S**, **SB*** or **SB SUBWF**.

6.1 channel setting

(VSX-D811S only)

- Default setting: **6.1 FIX**

You can have the receiver automatically switch to Dolby Digital or DTS-ES decoding for 6.1 encoded sources (**6.1 AUTO**), or you can choose to listen to other kinds of sources (for example, 5.1 encoded material) with 6.1 encoding (**6.1 FIX**). With 5.1 encoded sources, a surround back channel will be generated, but the material may sound better in the 5.1 format for which it was originally encoded.

- Use **↑** or **↓** to select **6.1 FIX** or **6.1 AUTO**.

Note

- If you chose **SB*** in Surround back speaker setting (above), you can't set the 6.1 channel setting and ******* shows in the display.
- Refer to the table on page 33 to see how the *6.1 channel setting* affects sound output from the surround back speakers.

Subwoofer setting

- Default setting: **ON**

You can choose whether the subwoofer is used or not. Use the plus (**PLS**) setting for extra bass.

- Use **↑** or **↓** to select subwoofer **ON**, **PLS** or **OFF**.

Note

- If you chose the small front speaker setting, **SUBWF ON** is automatically set and locked.
- When you select the plus setting, you will get the bass sounds from the subwoofer even if the front speakers are set to **L**.

Crossover frequency setting

- Default setting: **100 Hz**

Crossover frequency is the point where the receiver divides the high and low sounds (the frequencies) between the speakers. Since most smaller speakers can't handle deep bass tones, you can send these sounds to the subwoofer (or if you don't have a subwoofer, the large (**L**) speakers in your system) instead of the speakers set to small (**S**) in your setup. Choose the point at which you want the frequency routed to the subwoofer (or **L** speakers).

We recommend setting this to 200 Hz if your **S** speakers are smaller bookshelf-type speakers.

- Use **↑** or **↓** to specify the crossover frequency for your small speakers (**100 Hz**, **150 Hz** or **200 Hz**).

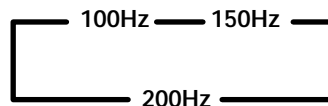

100 Hz

Sends bass frequencies below 100 Hz to the subwoofer (or **L** speakers).



Setting up the receiver

06

150 Hz

Sends bass frequencies below 150 Hz to the subwoofer (or **L** speakers).

200 Hz

Sends bass frequencies below 200 Hz to the subwoofer (or **L** speakers).



Note

If all speakers (front, center, and surround) are set to **L**, the crossover frequency can't be set because there are no **S** speakers (** appears in the display).

LFE attenuator setting

- Default setting: **0 dB**

Dolby Digital and DTS audio sources include ultra-low bass tones. Set the LFE attenuator as necessary to prevent the ultra-low bass tones from distorting the sound from the speakers.

- Use \uparrow or \downarrow to set the attenuation level (0 dB, 10 dB or ** dB(∞)).

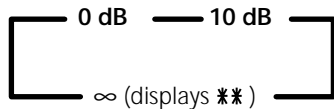

Note

When ∞ is selected (** appears in the display), LFE is not available.

Front speaker distance setting

- Default setting: **10 ft.**

Sets the distance from the front speakers to the listening position.

- Use \uparrow or \downarrow to set the distance of the front speakers from the main listening position (within a 30 foot range).

Center speaker distance setting

- Default setting: **10 ft.**

The center speaker is normally placed directly in the front of the listening room and closer to the listening position than the front speakers. This means that the sound from the center speaker will be heard before the front speakers. To prevent this, set the center speaker distance setting to delay the sound from the center speaker so that the sound from the front and center speakers will be heard at the same time.

- Use \uparrow or \downarrow to set the distance of the center speaker from the main listening position (within a 30 foot range).



Note

When **C*** is selected in the speaker setting, the center speaker distance can't be set.

Surround speaker distance setting

- Default setting: **10 ft.**

Like the center speaker, you should set the distance of the surround speakers accurately to hear sounds coming from both front and surround speakers at the same time.

- Use \uparrow or \downarrow to set the distance of the surround speakers from the main listening position (within a 30 foot range).



Note

When **S*** is selected in the speaker setting, the surround speaker distance can't be set.

41

En

Surround back speaker distance setting

(VSX-D811S only)

- Default setting: **10 ft.**

Like the center speaker, you should set the distance of the surround speakers accurately to hear sounds coming from both front and surround speakers at the same time.

- Use **↑** or **↓** to set the distance of the surround speakers from the main listening position (within a 30 foot range).



Note

When **SBX** is selected in the surround speaker setting, the surround back speaker distance can't be set.

Dynamic range control setting

- Default setting: **OFF**

Dynamic range is the difference between the loudest and softest sounds in any given signal. With this setting, you can compress the dynamic range, so that low level sounds can be heard more easily (sounding relatively louder) yet louder sounds won't be too overbearing.

- Press **↑** or **↓** to set the dynamic range control (**OFF**, **MAX**, or **MID**).



Note

- When the volume level is increased, set to **OFF**.
- When listening at low volumes, set to **MAX** for maximum dynamic range compression.
- Dynamic range control is effective only when a Dolby Digital signal is being played back.

Dual mono setting

- Default setting: **ch1**

The dual mono setting can only be used when listening to Dolby Digital discs with dual mono encoding. These discs are not widely used, but are sometimes used when it is necessary to have one language on one channel and a different language on the other. With this setting you can choose which channel in the dual mono setting you want to listen to.

If Dolby Digital mode is switched on, you will hear the channel you have selected (either **ch1** or **ch2**) through your center speaker. With Dolby Digital mode off, or if you don't have a center speaker, you will hear the channel you have selected through both front speakers. In the **L ch 1. R ch 2** setting, the left front speaker will play channel 1 and the right front speaker will play channel 2.

- Use **↑** or **↓** to cycle through the possible dual mono settings.

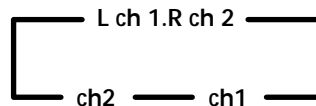

Component video input settings

Here you tell the receiver what components you have hooked up to the component video jacks on the back of the receiver.

Component video 1:

- Default settings: **DVD**

- 1 Use **↑** or **↓** to assign the component video 1 input (**DVD**, **TV**, **VCR** or **OFF**).

Component video 2:

- Default setting: **TV**

- 2 Use **↑** or **↓** to assign the component video 2 input (**DVD**, **TV**, **VCR** or **OFF**).



Setting up the receiver

06

Surround back channel input setting

(VSX-D811S only)

- Default setting: **SB 2ch IN**

You only have to make this setting if you are using a separate component for decoding DVDs, and the component has only one surround back channel output. If this is the case, select **SB 1ch IN**, otherwise leave it set to **SB 2ch IN**.

- Use **↑** or **↓** to select **SB 2ch IN** or **SB 1ch IN**.

Coaxial digital input settings

Here you tell the receiver what components you have hooked up to the coaxial **DIGITAL IN** jacks 1 and 2 on the back of the receiver.

Coaxial digital 1:

- Default settings: **DVD/LD**

1 Use **↑** or **↓** to assign the coaxial digital 1 input (**DVD, TV, CD, CD-R, VCR or OFF**).

Coaxial digital 2:

- Default setting: **CD**

2 Use **↑** or **↓** to assign the coaxial digital 2 input (**DVD, TV, CD, CD-R, VCR or OFF**).

After you assign a component to a digital jack, whenever you select that component, (for example, a DVD player) the receiver automatically changes to the digital input setting and **DIGITAL** shows in the display.

Optical digital input settings

Here you tell the receiver what components you have hooked up to the optical **DIGITAL IN** jack(s) on the back of the receiver.

Optical digital 1:

- Default settings: **TV/SAT**

1 Use **↑** or **↓** to assign the optical digital 1 input (**DVD, TV, CD, CD-R, VCR or OFF**).

Optical digital 2

(VSX-D811S only):

- Default setting: **CDR/TAPE/MD**

2 Use **↑** or **↓** to assign the optical digital 2 input (**DVD, TV, CD, CD-R, VCR or OFF**).

After you assign a component to a digital jack, whenever you select that component, (for example, a DVD player) the receiver automatically changes to the digital input setting and **DIGITAL** shows in the display.



Setting the relative volume level of each channel

- Default setting: **0db**

For best surround sound playback, you should set the relative channel levels from the main listening position. You can set separate levels for each surround mode.

- 1 Press **RCV**.
- 2 Press **TEST TONE** to output the test tone.

The test tone is output in the following order (depending on the speaker setting):

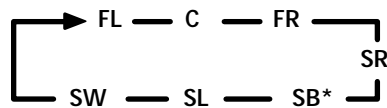

* *VSX-D811S only*



Note

If you don't hear a test tone from one of your speakers, please refer to *Speaker setting* on page 39 to make sure you have correctly specified your speaker setup.

- 3 Press **MASTER VOLUME +/-** to adjust the volume to an appropriate level.

- 4 Use **LEVEL +/-** to adjust the speaker levels in turn.

You should hear the test tone at the same volume from each speaker when seated in the main listening position. The channel level range is ± 10 dB.

- 5 When you're done, press **TEST TONE** to turn off the test tone.



Tip

The speaker volume can be adjusted without outputting the test tone by pressing **CH SELECT** and then using **LEVEL +/-**.

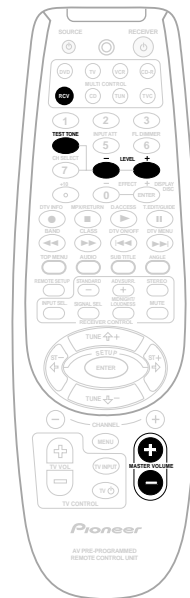

Note

- Test tone is only output in Standard modes.
- Since the subwoofer transmits an ultra-low frequency its sound may seem quieter than it actually is.



Using the tuner

07

Listening to the radio

The following steps show you how to tune in to FM and AM radio broadcasts using the automatic (search) and manual (step) tuning functions. If you already know the frequency of the station you want, see *Tuning directly to a station* below. Once you are tuned to a station you can memorize the frequency for recall later—see *Saving station presets* on the next page for more on how to do this.

for about a second. The receiver will start searching for the next station, stopping when it has found one. Repeat to search for other stations.

Manual tuning

To change the frequency one step at a time, press **TUNE +/-**.

High speed tuning

Press and hold **TUNE +/-** for high speed tuning. Release the button at the frequency you want.

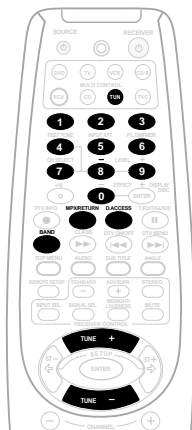

Improving FM stereo sound

If the **TUNED** or **STEREO** indicators don't light when tuning to an FM station because the signal is weak, press the **MPX/(RETURN)** button to switch the receiver into mono reception mode. This should improve the sound quality and allow you to enjoy the broadcast.

Tuning directly to a station

Sometimes, you'll already know the frequency of the station you want to listen to. In this case, you can simply enter the frequency directly using the number buttons on the remote control.

- 1 Press the **TUN** button on the remote control to select the tuner.

You can also use the **MULTI JOG/INPUT SELECTOR** dial on the front panel.

- 2 Use the **BAND** button to change the band (FM or AM), if necessary.

Each press switches the band between FM and AM.

- 3 Tune to a station.

There are three ways to do this:

Automatic tuning

To search for stations in the currently selected band, press and hold **TUNE +/-**

- 1 Press the **TUN** button on the remote control to select the tuner.

You can also use the **MULTI JOG/INPUT SELECTOR** dial on the front panel.

- 2 Use the **BAND** button to change the band (FM or AM), if necessary.

Each press switches the band between FM and AM.

- 3 Press **D.ACCESS** (Direct Access).

- 4 Use the number buttons to enter the frequency of the radio station.

For example, to tune to **106.00** (FM), press **1, 0, 6, 0, 0**.

45

En

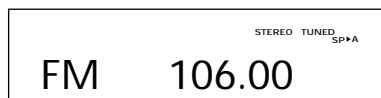

If you make a mistake halfway through, press **D.ACCESS** twice to cancel the frequency and start over.

Saving station presets

If you often listen to a particular radio station, it's convenient to have the receiver store the frequency for easy recall whenever you want to listen to that station. This saves the effort of manually tuning in each time. This unit can memorize up to 30 stations, stored in three banks, or classes, (A, B and C) of 10 stations each. When saving an FM frequency, the **MPX** setting (see previous page) is also stored. Use the front panel controls to store station presets.

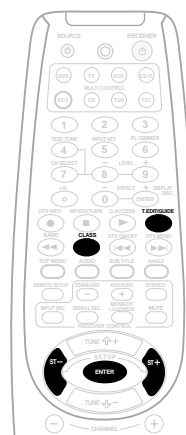
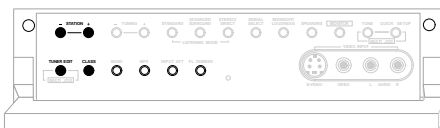
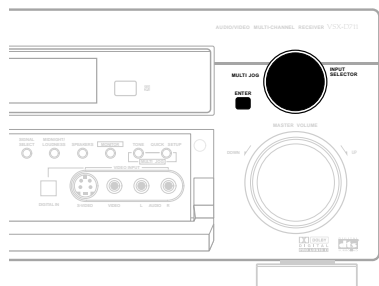

1 Tune to a station you want to memorize.

See *Listening to the radio* (previous page) for more on this.

2 Press T.EDIT (TUNER EDIT).

The display shows **ST. MEMORY**, then a blinking memory class.

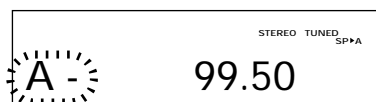

3 Press CLASS to select one of the three classes then press ST +/- (STATION +/-) to select the station preset you want.

You can also use the **MULTI JOG/INPUT SELECTOR** dial (front panel) to select a station preset.

4 Press ENTER.

After pressing **ENTER**, the preset class and number stop blinking and the receiver stores the station.



Using the tuner

07

Naming station presets

For easier identification, you can name your station presets.

1 Choose the station preset you want to name.

See *Listening to station presets* (this page) for how to do this.

2 Press T.EDIT (TUNER EDIT).

The display shows **ST. NAME**, then a blinking cursor at the first character position.

3 Input the name you want.

Names can be up to four characters long.

- Use the **MULTI JOG/INPUT SELECTOR** dial (front panel) or the **ST +/-** buttons (remote) to select characters.
- Press **ENTER** to confirm a character. If no character is input, a space is input.
- The name is stored when **ENTER** is pressed after choosing the fourth character.

 **Note**

To erase a station name, simply repeat steps 1-3 and input four spaces instead of a name.

 **Tip**

Once you have named a station preset, you can press **DISPLAY** when listening to a station to switch the display between the name and the frequency.

Listening to station presets

Having stored up to 30 stations (see previous page), preset stations can be easily recalled.

1 Press TUN (remote) or use the MULTI JOG/INPUT SELECTOR dial on the front panel to select the tuner.

2 Press CLASS to select the class in which the station is stored.

Press repeatedly to cycle through classes A, B and C.

3 Press ST +/- (STATION +/-) to select the station preset you want.

 **Note**

- If the receiver is left disconnected from the AC power outlet for an extended period, the station memories will be lost and will have to be reprogrammed.

Making an audio or a video recording

You can make an audio or a video recording from the built-in tuner, or from an audio or video source connected to the receiver (such as a CD player or TV).

Keep in mind you can't make a digital recording from an analog source or vice-versa, so make sure the components you are recording to/from are hooked up in the same way (see pages 13–19 for more on connections).

If you want to record a video source, you also need use the same type of connection for the source as for the recorder. For example, you can't record a component hooked up to S-video jacks with a recorder hooked up to the component video outputs (see page 18 for more on video connections).



Note

The receiver's volume, balance, tone (bass, treble, loudness), and surround effects have no effect on the recorded signal.

1 Select the source you want to record.

Use the **MULTI CONTROL** buttons on the remote (or **MULTI JOG/INPUT SELECTOR** dial on the front panel).

2 Select the input signal (if necessary).

Press **SIGNAL SEL (SIGNAL SELECT)** to select the input signal corresponding to the source component (see page 34 for more on this).

3 Prepare the source you want to record.

Tune to the radio station, load the CD, video, DVD etc.

4 Prepare the recorder.

Insert a blank tape, MD, video etc. into the recording device and set the recording levels.

Refer to the instructions that came with the recorder if you are unsure how to do this. Most video recorders set the audio recording level

automatically—check the component's instruction manual if you're unsure.

5 Start recording, then start playback of the source component.

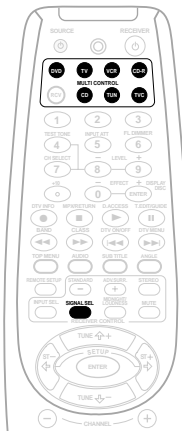

Monitoring your recording

You can listen to (monitor) the recording as it's being made using the **MONITOR** button on the front panel (a cassette deck would have to have a record monitor function).

- Press the **MONITOR** button to switch between the recorded signal and the original source signal.



Setting the remote to control other components

There are several ways to set your remote to control the other components in your system. The easiest way to do this is to assign the component's manufacturer preset code (listed on pages 56–67) to one of the **MULTI CONTROL** buttons on the remote control.

The buttons can be set to control the following components:

Button	Controllable Components
DVD:	DVD or LD player
TV:	TV or Satellite tuner
VCR:	VCR or Digital Video Recorder
CD:	CD player
CD-R:	CD Recorder, Tape deck or MD player
TVC:	TV or Cable TV tuner
TUN:	FM/AM tuner

You can do this directly, or by searching through different preset codes until you find the right one. If you can't find a preset code that matches the component you want to control, you can still teach the remote individual commands from another remote control (page 50).

Note

You can cancel or exit any of the steps by pressing and holding **MUTE** for three seconds.

Selecting preset codes directly

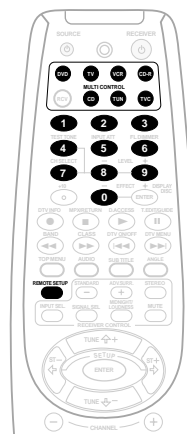

1 Press and hold REMOTE SETUP for three seconds.

The LED lights steadily for two seconds.

2 Press the MULTI CONTROL button for the component you want to control.

3 Use the number buttons to enter the 4 digit preset code (see pages 56–67)

The LED blinks for half a second after you input each digit and shows a long, two second blink once you have entered a valid code. If the LED blinks three times it means an invalid code has been input or an error has occurred.

Note

- If you assign a preset code for the **TUNER** button, you won't be able to control the built-in tuner of this receiver using the remote. Reset the remote to the built-in tuner by entering the preset code **7008**.

4 Repeat steps 1 through 3 for the other components you want to control.



Searching for preset codes

Another way of entering preset codes is to use the search feature. The remote transmits batches of 10 codes; when you see the component you want to control respond (by turning on or off), you just scan through the last 10 codes until you find the right one.

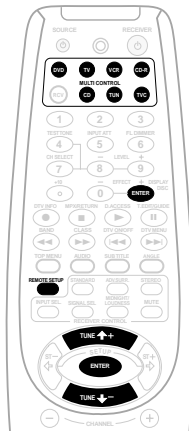

1 Switch on the component you want to control.

If the component is some kind of player (CD player, VCR, etc.), start it playing.

2 Press and hold REMOTE SETUP for three seconds.

The LED lights steadily for two seconds.

3 Press the MULTI CONTROL button for the component you want to control.

4 Press and hold REMOTE SETUP for three seconds.

A batch of 10 codes is transmitted and the LED blinks during transmission. If the component responds, by stopping or switching off, go to the next step, otherwise repeat this step.

5 Switch the component back on or restart playback.

6 Use \uparrow and \downarrow to scan through the last 10 codes transmitted to identify the correct code.

Stop when you see the component stop or switch off. The LCD display on the remote shows the I.D.

You can also verify you have the correct code by adjusting the volume, pressing \blacktriangleright , \blacksquare , etc.

7 Press and hold ENTER for three seconds to save the preset code.

Programming signals from other remote controls

(VSX-D811S only)

If the preset code for your component is not available, or the available preset codes do not operate correctly, you can program signals from the remote control of another component. This can also be used to program additional operations (buttons not covered in the presets) after assigning a preset code.

1 Press REMOTE SETUP and hold for three seconds.

The LED lights steadily for two seconds.

2 Press the MULTI CONTROL button for the component you want to control.

3 Prepare the remote to learn the remote control signal from the component.

Press and hold the RECEIVER \odot button for two seconds.

The LED lights steadily to indicate the remote is ready accept a signal.

Note

To exit or cancel press and hold the **REMOTE SETUP** key for three seconds.



Controlling the rest of your system

09

- 4 Point the two remote controls towards each other about 1-2 inches apart then press the button that will be doing the learning on this receiver's remote control (for example ►, ■, etc.).

The LED flashes rapidly.

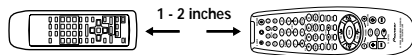

- 5 Press the corresponding button on the other remote control that is sending (teaching) the signal to this receiver's remote control (for example ►, ■, etc.).

If the operation has been learned successfully, the LED on this receiver's remote will go out and then light steadily.

If for some reason the operation hasn't been learned the LED will blink for three seconds and then light steadily. If this happens, keep pressing the (teaching) button as you vary the distance between the two remotes, until you see the the LED light steadily.

To program additional operations for the current component repeat steps 4 and 5.

To program operations for another component exit and repeat steps 1 through 5.

- 6 Press and hold the REMOTE SETUP button for three seconds to store the operation(s).

Note

- Some commands from other remote controls cannot be learned, but in most cases the remotes just need to be moved closer together or farther apart.
- Certain buttons represent operations that cannot be learned from other remote controls. These include: RECEIVER , REMOTE SETUP and the MULTI CONTROL, RECEIVER CONTROL and MASTER VOLUME buttons.

- TV CONTROL buttons (TV, TV VOL +/-, and TV INPUT) can only be learned after selecting TV or TVC.

Erasing one of the remote control button settings

(VSX-D811S only)

This erases one of the buttons you have programmed and restores the button to the factory default.

- 1 Press REMOTE SETUP and hold for three seconds.

The LED lights steadily for two seconds.

- 2 Press the MULTI CONTROL button relating to the button setting to be erased.

- 3 Prepare the remote to erase the button setting.

Press the RECEIVER  button twice quickly.

The LED blinks to indicate the remote is ready to erase the button setting.

- 4 Press and hold the button to be erased for three seconds.

The LED lights steadily for three seconds and then goes off.

- 5 Repeat step 4 to erase other buttons.

- 6 Press and hold the REMOTE SETUP button for two seconds to exit.

Clearing all the remote control settings

You can clear all presets and restore the factory default settings.

- 1 Press REMOTE SETUP and hold for three seconds.

The LED lights steadily for two seconds.

**2 Press any MULTI CONTROL button then use the number buttons to enter 0123.**

The LED lights for two seconds to indicate that the settings have been restored to the factory presets. (If the LED blinks three times, then you made a mistake with the code—try re-entering it.)

Direct function

- Default setting: **ON**

You can use the direct function feature to control one component using the remote control while at the same time, using your receiver to playback a different component. This could let you, for example, use the remote control to set up and listen to a CD on the receiver and then use the remote control to rewind a tape in your VCR while you continue to listen to your CD player.

When direct function is on, any component you select (using the **MULTI CONTROL** buttons) will be selected by both the receiver and the remote control. When you turn direct function off, you can operate the remote control without affecting the receiver.

1 Press REMOTE SETUP and hold for three seconds.

The LED lights steadily for two seconds.

2 Press the MULTI CONTROL button for the component you want to control.**3 Use the number buttons to enter either 9990 (direct on) or 9995 (direct off).**

The LED will light for two seconds to indicate that it's been correctly set. (If the LED blinks three times, then there was a mistake with the code—repeat steps 1-4.)

**Note**

You can't use direct function for **TV INPUT**.

Confirming preset codes

Use this feature to check which preset code is assigned to a **MULTI CONTROL** button.

1 Press REMOTE SETUP and hold for three seconds.

The LED lights steadily for two seconds.

2 Press the MULTI CONTROL button of the component for which you want to check the preset code.**3 Press and hold ENTER for two seconds.**

Each preset code consists of four digits, for example 1329. Each digit will be represented by a series of blinks on the remote's LED—3 blinks to represent the digit "3", etc. ("0" is represented by 10 blinks)



Controls for TVs

This remote control can control components after entering the proper codes or teaching the receiver the commands (see pages 56–67). Use the **MULTI CONTROL** buttons to select the component.

TV	Switches the DTV on or off.	DTV
	Switches the TV or CATV between standby and on.	Cable TV/Satellite TV/TV
TV INPUT	Switches the TV input. (Not possible with all models.)	TV
CHANNEL +/-	Selects channels.	Cable TV/Satellite TV/TV/DTV
TV VOL +/-	Adjust the TV volume.	Cable TV/Satellite TV/TV/DTV
SOURCE	Press to switch the component assigned to the TVC button on or off.	DTV
	Switches DTV on or off.	DTV
	Press to display the DTV menu.	DTV
	Use as the GUIDE button for navigating	DTV
	Press to get information on DTV programs.	DTV
TOP MENU	Use to choose the BLUE commands on a DTV menu.	DTV
AUDIO	Use to choose the GREEN commands on a DTV menu.	DTV
SUB TITLE	Use to choose the RED commands on a DTV menu.	DTV
ANGLE	Use to choose the YELLOW commands on a DTV menu.	DTV
	Selects between screen formats for widescreen TVs.	TV
	Use to clear a TV channel selected using the number buttons.	Cable TV/TV
	Use to switch DTV audio tracks	DTV
	Use to select closed captioning with DTV.	DTV
Number Buttons	Use to select a specific TV channel.	Cable TV/Satellite TV/TV/DTV
+10 button	Use to add a decimal point when selecting a specific TV channel.	DTV
ENTER/ DISPLAY/ DISC	Use to enter a channel.	Cable TV/Satellite TV/TV

Button (s)	Function	Components
MENU	Select different menus from the DTV functions. Select the menu screen.	DTV Cable TV/Satellite TV/TV
ENTER	Select or adjust and navigate items on the menu screen. ENTER brings up the DTV menus. Press to select or adjust and navigate items on the menu screen.	DTV Cable TV/Satellite TV/TV/ DTV
EFFECT +/-	For TV and cable TV use this button to immediately enter a new channel (CHANNEL ENTER function). For satellite TV use this button to exit the menu screen.	Cable TV/Satellite TV/TV/ DTV

**Note**

The four **TV CONTROL** buttons on the remote control are dedicated to control the TV assigned to the **TVC** button. Thus if you only have one TV to hook up to this system assign it to the **TVC MULTI CONTROL** button. If you have two TVs, assign the main TV to the **TVC** button.

Controls for other components

This remote control can control these components after entering the proper codes or teaching the receiver the commands (see pages 56–67). Use the **MULTI CONTROL** buttons to select the component.

Button (s)	Function	Components
SOURCE	Press to switch the component between standby and on.	CD/MD/CD-R/VCR/DVD/LD/ DVR player/Cassette deck
◀◀	Press to return to the start of the current track. Repeated presses skips to the start of previous tracks. Go back channels (channel -). Play the reverse side of the tape on a reversible deck.	CD/MD/CD-R/DVD/LD player VCR/DVR Cassette deck
▶▶	Press to advance to the start of the next track. Repeated presses skips to the start of following tracks. Go forward channels (channel +). Play the forward side of the tape on a reversible deck.	CD/MD/CD-R/LD player VCR Cassette deck
 	Pause playback or recording.	CD/MD/CD-R/VCR/DVD/LD/ DVR player/Cassette deck
▶	Start playback.	CD/MD/CD-R/VCR/DVD/LD/ DVR player/Cassette deck



Controlling the rest of your system

09

	Hold down for fast forward playback.	CD/MD/CD-R/VCR/DVD/LD/ DVR player/Cassette deck
	Hold down for fast reverse playback.	CD/MD/CD-R/VCR/DVD/LD/ DVR player/Cassette deck
	Stops playback (on some models, pressing this when the disc is already stopped will cause the disc tray to open).	CD/MD/CD-R/VCR/DVD/LD/ DVR player/Cassette deck
	Starts recording. To prevent accidental recording, this button must be pressed twice to take effect (the second press must be within 10 seconds of the first).	VCR/DVR player
Number buttons	Directly access tracks on a program source.	CD/MD/CD-R/VCR/LD player
	Use the number buttons to navigate the on-screen display.	DVD/DVR player
+10 button	Selects tracks higher than 10. (For example, press +10 then 3 to select track 13.)	CD/MD/CD-R/VCR/LD player
ENTER	Chooses the disc.	Multiple CD player
(DISPLAY/	Ejects the disc.	MD player
DISC)	Use as the ENTER button.	VCR
	Displays the setup screen for DVD/DVR players.	DVD/DVR player
	Changes sides of the LD.	LD player
MENU	Displays menus concerning the current DVD or DVR you are using.	DVD/DVR player
	Pauses the tape.	CD-R/Cassette deck
	Stops the tape.	CD-R/Cassette deck
ENTER	Starts playback.	CD-R/Cassette deck
	Fast rewinds/fast forwards the tape.	CD-R/Cassette deck
& ENTER	Navigates DVD menu/options.	DVD/DVR Player
CHANNEL	Selects channels.	VCR/DVD/DVR Player
+/-	Selects tracks.	CD/MD/CD-R/Cassette deck
TOP MENU	Displays the disc 'top' menu of a DVD.	DVD/DVR Player
AUDIO	Changes the audio language or channel.	DVD/DVR Player
SUBTITLE	Displays/changes the subtitles on multilingual DVDs.	DVD/DVR Player
ANGLE	Switches camera angles on discs with multi-angle scenes.	DVD/DVR Player

55

En



Preset Code List

You can only set these codes for the buttons that assigned to the respective components. So, for example, the TV codes can only be set to the TV or TVC button.

TV



Manufacturer

Code

PHILIPS	1008, 1017, 1020, 1025, 1104, 1115
SONY	1001, 1007, 1016
PANASONIC	1023, 1054, 1055, 1075, 1076, 1082, 1087, 1121, 1124
TOSHIBA	1015, 1016, 1027, 1031, 1050, 1051, 1085
TELEFUNKEN	1005, 1026, 1034, 1038, 1042, 1046, 1075, 1097
SHARP	1016, 1019, 1041, 1056, 1124
SAMSUNG	1006, 1011, 1013, 1017, 1026, 1027, 1039, 1062, 1079, 1089, 1092, 1102
FERGUSON	1005, 1017, 1033, 1046, 1065, 1084, 1091
MITSUBISHI	1011, 1016, 1041, 1045, 1049, 1062, 1114
GOLDSTAR	1002, 1011, 1013, 1017, 1019, 1026, 1046, 1062, 1079, 1092
BLAUPUNKT	1066, 1068, 1071, 1075, 1115
RADIOLA	1008, 1017
JVC	1016, 1024, 1030, 1053, 1065, 1067, 1103, 1122
DAEWOO	1006, 1011, 1017, 1019, 1028, 1040, 1050, 1104, 1110, 1118, 1119
ORION	1017, 1063, 1083, 1095, 1098, 1099, 1112
SIEMENS	1017, 1052, 1066, 1068, 1071, 1075, 1115
ADMIRAL	1041, 1055, 1075, 1112
ADYSON	1014, 1079
AIKO	1040
AKAI	1013, 1074
AKURA	1080, 1089
ACURA	1006
ALARON	1063, 1078
ALBA	1006, 1016, 1017, 1080, 1103
ALLORGAN	1095
ANAM	1004, 1006, 1029, 1054, 1064, 1087, 1108
ANAM NATIONAL	1054, 1087, 1108
AMBASSADOR	1061
AMERICA ACTION	1064

AMPLIVISION	1079
AMPRO	1126
AMSTRAD	1006, 1017, 1103, 1105
ANITECH	1006, 1029, 1036
AOC	1011, 1013
ARCAM	1078, 1079
ASBERG	1036
ASUKA	1080
ATLANTIC	1073
AUDIOSONIC	1017, 1046
AUDIOVOX	1040, 1064, 1110, 1118
AUTOVOX	1036, 1073
BANG & OLUFSEN	1116
BASIC LINE	1006, 1080
BAYSONIC	1064
BAUR	1007, 1017, 1114, 1115
BEKO	1102
BELCOR	1011
BELL & HOWELL	1009, 1050
BEON	1017
BINATONE	1079
BLUE SKY	1080
BLUE STAR	1090
BONDSTEC	1086
BOOTS	1079
BPL	1090
BSR	1095
BRADFORD	1064
BRANDT	1046, 1069, 1070, 1072
BRITANNIA	1078
BROCKWOOD	1011
BROKSONIC	1083, 1112
BTC	1080
BUSH	1006, 1016, 1017, 1080, 1090, 1095, 1103, 1104
CANDLE	1013, 1026
CARNIVALE	1013
CARREFOUR	1016
CARVER	1025, 1058
CASCADE	1006
CATHAY	1017
CENTURY	1075
CENTURION	1017
CELEBRITY	1001
CCE	1017
CGE	1034, 1036, 1038, 1086, 1097
CIMLINE	1006



Controlling the rest of your system

09

CINERAL 1040, 1110
 CITIZEN 1013, 1019, 1026, 1027, 1040
 CLARIVOX 1017
 CLATRONIC 1036, 1086, 1102
 CME 1007, 1015, 1114
 CONCERTO 1026
 CONDOR 1098, 1102
 CONTEC 1006, 1016, 1064, 1078
 CONTINENTAL EDISON 1069, 1070, 1072
 CRAIG 1054
 CROSLLEY 1025, 1034, 1036, 1038, 1075
 CROWN 1006, 1017, 1019, 1036, 1064,
 1102, 1106
 CRYSTAL 1109
 CS ELECTRONICS 1078
 CTC 1086
 CURTIS MATHES 1009, 1013, 1019, 1022, 1023,
 1025, 1026, 1027, 1041, 1047,
 1050, 1057, 1110, 1113, 1129,
 1131
 CYBERTRON 1080
 CXC 1064
 DAINICHI 1077, 1080
 DANSAI 1017
 DAYTRON 1006, 1011
 DECCA 1017, 1032
 DE GRAAF 1074
 DENON 1047
 DIXI 1006, 1017
 DUAL TEC 1079
 DUMONT 1010, 1011, 1031
 DWIN 1125, 1127
 ECE 1017
 ELBE 1088
 ELECTROBAND 1001
 ELIN 1017
 ELITE 1080, 1098
 ELTA 1006
 EMERSON 1011, 1018, 1019, 1050, 1061,
 1062, 1063, 1064, 1075, 1083,
 1090, 1112, 1118, 1119
 ENVISION 1013
 ERRES 1008, 1017
 ETRON 1006, 1120
 EXPERT 1073
 FIDELITY 1078
 FINLANDIA 1074
 FINLUX 1017, 1031, 1032, 1044
 FISHER 1050, 1074, 1079, 1096, 1102
 FLINT 1111
 FORMENTI 1017, 1075, 1098
 FORTRESS 1041

FRONTECH 1055, 1086, 1089, 1109
 FUJITSU 1032, 1063, 1073
 FUNAI 1059, 1063, 1064, 1089, 1095,
 1096
 FUTURETECH 1064
 GE 1012, 1022, 1023, 1041, 1062,
 1090, 1110, 1129, 1131
 GEC 1017, 1020, 1032, 1072, 1079
 GELOSO 1006, 1075
 GENEXXA 1055, 1080
 GIBRALTER 1010, 1011, 1013
 GOODMANS 1016, 1017, 1032, 1079, 1103,
 1104
 GORENJE 1102
 GPM 1080
 GRAETZ 1055
 GRANADA 1017, 1032, 1048, 1074, 1079,
 1100
 GRADIENTE 1024, 1026, 1058
 GRANDIN 1090
 GRUNDIG 1031, 1066, 1068, 1072, 1115
 GRUNPY 1063, 1064
 HALLMARK 1062
 HANSEATIC 1017, 1098
 HARLEY DAVIDSON 1063
 HARVARD 1029, 1064
 HARMAN/KARDON 1025
 HCM 1006, 1090, 1105
 HINARI 1006, 1016, 1017, 1080
 HISAWA 1090, 1111
 HITACHI 1014, 1016, 1018, 1020, 1021,
 1026, 1044, 1046, 1047, 1055,
 1069, 1070, 1079, 1081, 1097
 1078, 1104
 HUANYU 1017, 1089, 1090
 HYPSON 1079, 1089, 1103
 ICE 1080
 ICES 1080
 IMPERIAL 1034, 1036, 1038, 1086, 1102,
 1106
 INDIANA 1017
 INFINITY 1025
 INGELLEN 1055
 INNO HIT 1032
 INNOVA 1017
 INTEQ 1010
 INTERBUY 1029
 INTERFUNK 1017, 1055, 1086, 1114
 INTERVISION 1017, 1029, 1043
 1079, 1089
 ISUKAI 1080
 ITS 1103
 ITT 1055

57

En

**09****Controlling the rest of your system**

JBL	1025	NAD	1051, 1057, 1062
JCB	1001	NEC	1011, 1013, 1016, 1026, 1058
KAISUI	1006, 1078, 1079, 1080, 1090,	NECKERMANN	1017, 1066, 1075, 1115
KAMP	1078	NEI	1017, 1109
KAPSCH	1055, 1073	NETSAT	1017
KAWASHO	1078	NICAMAGIC	1078
KEC	1064	NIKKAI	1014, 1015, 1017, 1032, 1078, 1080, 1089
KENDO	1017	NIKKO	1013, 1040, 1062
KNEISSEL	1088	NOBLIKO	1036, 1043
KENWOOD	1011, 1013	NORDMENDE	1046, 1069, 1070, 1075, 1091
KINGSLEY	1078	NTC	1040
KONIG	1114	OCEANIC	1055, 1077
KORPEL	1017	ONWA	1064
KOYODA	1006	OPTIMUS	1050, 1057, 1087
KTV	1013, 1019, 1064	OPTONICA	1041, 1056
LEYCO	1017, 1032, 1089, 1095	OSAKI	1014, 1032, 1079, 1080, 1089, 1105
LG	1026	OSO	1080
LIESEN&TTER	1017	OSUME	1014, 1032, 1052
LLOYTRON	1014	OTTO	1007, 1114
LOEWE	1035, 1114	OTTO VERSAND	1007, 1016, 1017, 1066, 1075, 1079, 1098, 1115
LOGIK	1009	PALLADIUM	1102, 1106
LUMA	1073	PANAMA	1079, 1089
LUXMAN	1026	PATHE MARCONI	1069, 1070, 1072
LXI	1022, 1025, 1050, 1051, 1062	PATHE CINEMA	1075, 1078, 1084, 1098
M ELECTRONIC	1006, 1017, 1029, 1044, 1046, 1055, 1079, 1091, 1104	PAUSA	1006
MAGNAVOX	1013, 1016, 1025, 1063	PENNEY	1003, 1011, 1012, 1013, 1019, 1022, 1023, 1026, 1027, 1051, 1062, 1131
MAGNADYNE	1043, 1086	PERDIO	1098
MAGNAFON	1036, 1043, 1075	PHAPSODY	1078
MAJESTIC	1009	PHASE	1014
MANESTH	1079, 1089, 1098	PHILCO	1011, 1013, 1025, 1034, 1036, 1038, 1047, 1075, 1086, 1112
MARANTZ	1013, 1017, 1025	PHONOLA	1008, 1017
MARK	1017	PILOT	1011, 1013, 1019
MATSUI	1006, 1015, 1016, 1017, 1032, 1074, 1079, 1095, 1103	PORTLAND	1011, 1019, 1040
MATSUSHITA	1087	PRISM	1023
MCMICHAEL	1020	PROFEX	1006, 1037
MEDIATOR	1008, 1017	PROLINE	1099
MEGATRON	1047, 1062	PROSOCAN	1022
MEMOREX	1006, 1009, 1026, 1049, 1050, 1062, 1087, 1112	PROTECH	1006, 1017, 1043, 1079, 1086, 1089, 1106, 1109
METZ	1075	PROTON	1062, 1113
MGA	1011, 1013, 1049, 1062	PULSAR	1010, 1011
MIDLAND	1010, 1019, 1022, 1023	PYE	1008
MINERVA	1031, 1115	QUASAR	1023, 1056, 1087
MINOKA	1105	QUELLE	1007, 1017, 1031, 1034, 1038, 1071, 1075, 1097, 1114, 1115
MINUTZ	1012	QUESTA	1016
MIVAR	1078, 1092, 1093, 1094	R-LINE	1017
MOTION	1036		
MOTOROLA	1041		
MTC	1011, 1013, 1026, 1027, 1078, 1114		
MULTITECH	1006, 1036, 1043, 1064, 1078		



Controlling the rest of your system

09

RANK ARENA	1016	SOUNDWAVE	1017, 1106
RBM	1031	SQUAREVIEW	1059
RCA	1011, 1018, 1022, 1023, 1039, 1041, 1128, 1129, 1130, 1131, 1132	STANDARD	1006, 1079, 1080
REALISTIC	1011, 1013, 1019, 1026, 1050, 1056, 1062, 1064	STARLITE	1064
REX	1055, 1073, 1088, 1089	STERN	1055, 1073, 1088
REVOX	1017	SUNKAI	1095, 1099
ROADSTAR	1006, 1080, 1089, 1106	SUPERTECH	1078
RUNCO	1010, 1013, 1117	SUPREME	1001
SABA	1035, 1046, 1055, 1069, 1070, 1072, 1075, 1091	SUSUMU	1080
SACCS	1084	SYLVANIA	1013, 1025
SAISHO	1006, 1089, 1109	SYMPHONIC	1059
SALORA	1055	SYSLINE	1017
SAMBERS	1036, 1043, 1075	TANDY	1032, 1041, 1055, 1079, 1080
SAMPO	1013, 1019	TASHIKO	1016, 1020, 1079
SAMSUX	1019	TEC	1079, 1086
SANDRA	1078	TECHNEMA	1098
SANSEI	1110	TECHNICS	1023, 1087, 1121
SANSUI	1112	TECHNOL ACE	1063
SANYO	1016, 1032, 1048, 1050, 1052, 1074, 1075, 1100	TECHWOOD	1023, 1026
SBR	1008, 1017, 1020	TEKNIKA	1009, 1011, 1019, 1025, 1026, 1027, 1040, 1049, 1063, 1064
SCHNEIDER	1017, 1080, 1086, 1096, 1103	TELEAVIA	1072
SCIMITSU	1011	TELEMEISTER	1098
SCOTCH	1062	TELETECH	1006
SCOTT	1011, 1062, 1063, 1064, 1083	TELETON	1016, 1073, 1079
SEARS	1022, 1025, 1026, 1050, 1051, 1059, 1062, 1063	TENSAI	1080, 1095, 1098
SEG	1016, 1036, 1079, 1089	TEXET	1078, 1080
SEI	1043, 1075, 1095	THOMSON	1046, 1069, 1070, 1072, 1091
SEI-SINUDYNE	1007	THORN	1015, 1017, 1032, 1034, 1038, 1065, 1067, 1114
SELECO	1055, 1073, 1088	TMK	1026, 1061, 1062
SEMIVOX	1064	TOMASHI	1090
SEMP	1051	TOTEVISION	1019
SENTRA	1015	TRIUMPH	1085
SHOGUN	1011	TUTUNG	1017, 1032, 1079
SHORAI	1095	UHER	1073, 1096, 1098
SSS	1011, 1064	ULTRA	1067
SIAREM	1043, 1075	ULTRAVOX	1043
SINDYNE	1043, 1075, 1095	UNIVERSUM	1017, 1044, 1089, 1102
SIGNATURE	1009	VECTOR RESEARCH	1013
SILVER	1016	VESTEL	1017
SKY	1017	VICTOR	1016, 1024, 1053, 1087
SKY-WORTH	1017	VIDEOSAT	1086
SOLAVOX	1014, 1055	VIDEOTECHNIC	1079
SONITRON	1074	VIDIKRON	1025
SONOKO	1006, 1017	VIDTECH	1011, 1016, 1062
SONOLOR	1055, 1074, 1077	VISION	1098
SONTEC	1017	VOXSON	1055
SOUNDESIGN	1062, 1063, 1064	WALTHAM	1079
		WATSON	1017, 1098
		WATT RADIO	1043
		WARDS	1009, 1011, 1012, 1013, 1025, 1026, 1056, 1062, 1063
		WEGA	1016



WHITE WESTINGHOUSE	1017, 1078, 1098, 1112, 1118, 1119
YAMAHA	1011, 1013
YOKO	1017, 1079, 1101, 1109
ZANUSSI	1073
ZENITH	1009, 1010, 1040, 1112
PIONEER	1018, 1046, 1055, 1057, 1060, 1091, 1107, 1123, 1124

MD PLAYER

Manufacturer	Code
SONY	5401
KENWOOD	5402,5407
SHARP	5403
ONKYO	5404
ORION	5406
DENON	5405
PIONEER	5408

LD PLAYER

Manufacturer	Code
AKAI	5222
BBK	5224
CYRUS	5207
DENON	5202
DISCO VISION	5201
FUNAI	5217
HITACHI	5201
HONG DENG	5213
IDALL	5219
KEBAO	5215
MARANTZ	5203, 5205
MITSUBISHI	5202
NAD	5202
PANASONIC	5210
PHILIPS	5203, 5207, 5209
RADIOLA	5207
ROWA	5212
SALORA	5203
SEGA	5201
SHARP	5221
SHINCO	5211
SMC	5220
SONY	5204, 5206, 5216 5218
SUPER	5215
TELEFUNKEN	5202
TOSHIBA	5223
PIONEER	5201,5202, 5208 5214

CD PLAYER

Manufacturer	Code
AIWA	5016, 5021
AKAI	5014, 5020, 5032
ANAM	5041
ARCAM	5021
AUDIOLAB	5021
AUDIOMECA	5021
AUDIO TON	5021
BESTAR	5022
BURMESTER	5045
CALIFORNIA AUDIO LABS	5004
CARVER	5021, 5025, 5046
CONDOR	5018, 5022
CURTIS MATHES	5004
CYRUS	5021
DENON	5002, 5006, 5040, 5060
DKK	5001
DUAL	5031
DYNAMIC BASS	5025
EMERSON	5038
EROICA	5053, 5054
FANTASIA	5051
FISHER	5024, 5025
GARRARD	5044, 5045
GENEXXA	5005, 5038
GOLDSTAR	5043, 5051
GRUNDIG	5021
HARMAN/KARDON	5021, 5023
HITACHI	5005
INKEL	5015, 5026, 5046
JVC	5011
KENWOOD	5003, 5008, 5029, 5056, 5057, 5062
KRELL	5021
LINN	5021
LUXMAN	5036
LXI	5038
MAGNAVOX	5021, 5038
MARANTZ	5004, 5009, 5017, 5021, 5026
MATSUI	5021
MCS	5004
MEMOREX	5022
MERIDIAN	5021
MICROMEGA	5021
MISSION	5021
MITSUBISHI	5014, 5020
MTC	5045
NAD	5001
NAIM	5021
NIKKO	5024, 5041, 5051
NSM	5021



Controlling the rest of your system

09

ONKYO	5012, 5013, 5042, 5059
OPTIMUS	5001, 5005, 5008, 5019, 5025, 5038, 5045, 5046, 5048
ORION	5061
PANASONIC	5004, 5037
PARASOUND	5045
PHILIPS	5021, 5055
PMG	5022
POPPY	5022
PROTON	5021
QED	5021
QUAD	5021
QUASAR	5004,
RCA	5010, 5025, 5038
REALISTIC	5025, 5026, 5045
REVOX	5021
ROTEL	5021, 5045
SAE	5021
SANSUI	5021, 5033, 5038
SANYO	5025, 5039
SCHNEIDER	5018
SCOTT	5038
SEARS	5038
SHARP	5008, 5026, 5058
SHERWOOD	5015, 5026, 5031
SONY	5001, 5027, 5050
SOUDSIGN	5019
TASCAM	5045
TEAC	5024, 5026, 5044, 5045
TECHNICS	5004, 5034, 5037
THORENS	5021
TOSHIBA	5049
UNIVERSUM	5021
YAMAHA	5007, 5028
YORX	5047
VICTOR	5011
WARDS	5010, 5021
PIONEER	5005, 5030, 5035, 5038, 5048, 5052, 5063

DYNAMIC BASS	6028
EROICA	6041
FISHER	6028
GARRARD	6036
GOLDSTAR	6036
GRUNDIG	6002
HARMON/KARDON	6002, 6014
INKEL	6003
JVC	6027, 6030, 6031
KENWOOD	6003, 6004, 6019, 6024, 6025
KYOCERA	6013
LOTTE	6034
LUXMAN	6029
MAGNAVOX	6002
MARANTZ	6002
MEMOREX	6008, 6009
MITSUBISHI	6016
NAKAMICHI	6020
NIKKO	6035
OLYMPUS	6029
ONKYO	6010, 6011, 6032
OPTIMUS	6001, 6021
PANASONIC	6023
PHILIPS	6002
RCA	6028
RENAISSANCE	6040
REVOX	6002
SAMSUNG	6038
SANSUI	6002
SANYO	6028
SHARP	6019
SONIC	6036
SONY	6012, 6026, 6033
TEAC	6038
TECHNICS	6023
THORENS	6002
VICTOR	6027, 6030
WARDS	6001
YAMAHA	6006, 6007, 6019
PIONEER	6001, 6008, 6009 6021,

TAPE DECK



Manufacturer	Code
ADC	6013
AIWA	6002, 6022, 6017, 6018
AKAI	6015, 6016
ANAM	6035
ARCAM	6005
CARVER	6002, 6028
DENON	6005, 6039
DUAL	6037

DVD PLAYER



Manufacturer	Code
TOSHIBA	5302
SONY	5306
PANASONIC	5301, 5322
KENWOOD	5307
JVC	5311, 5318
SAMSUNG	5313
AKAI	5316
HARMAN/KARDON	5314

61

En



MAGNAVOX	5302
MITSUBISHI	5303
ONKYO	5302, 5317, 5319
PROSCAN	5304
RCA	5304
SHARP	5320
THETA DIGITAL	5312
TECHNICS	5301
THOMSON	5310
YAMAHA	5301, 5309
PHILIPS	5302, 5308
ZENITH	5302, 5315
PIONEER	5305, 5312, 5321 5322

AMPLIFIER

Manufacturer	Code
AUDIOLAB	8005
DENON	8002
GRUNDIG	8005
MARANTZ	8005
MICROMEGA	8005
PHILIPS	8005
PIONEER	8004
REVOX	8005
TANDBERG	8003
THORENS	8005
YAMAHA	8001, 8006

MISC AUDIO

Manufacturer	Code
JERROLD	8201, 8203
STARCOM	8201
SCIENTIFIC ATLANTA	8202

RECEIVERS

Manufacturer	Code
ADC	7042
AIWA	7012, 7023, 7031, 7055, 7064
AKAI	7011, 7027
ANAM	7010, 7046
ARCAM	7018, 7048
AUDIOLAB	7059
CAPETRONIC	7042
CARVER	7055, 7059
CURTIS	7008
DAEWOO	7032
DENON	7001, 7056, 7058
DUAL	7040

EROICA	7005
FANTASIA	7037
FERGUSON	7042
FINE ARTS	7059
FISHER	7028
GARRARD	7032, 7034, 7035
GOLDSTAR	7010
GOODMANS	7027
GP AUDIO	7033
GRUNDIG	7018, 7059
HARMAN/KARDON	7009, 7051
INKEL	7038, 7040
JBL	7009
JVC	7007, 7036, 7042
KENWOOD	7003, 7017, 7025, 7026, 7044, 7053, 7063, 7066 7037, 7039
LOTTE	7021
LUXMAN	7021
MAGNAVOX	7030, 7042, 7055, 7059
MARANTZ	7004, 7018, 7055, 7059
MCINTOSH	7020
MCS	7004
MCSILVER	7037
MICROMEGE	7018, 7059
NIKKO	7032, 7037, 7046
OPTIMUS	7017, 7034, 7042, 7049, 7052
ONKYO	7013, 7029
PALLADIUM	7050
PANASONIC	7004, 7024, 7041
PHILIPS	7018, 7030, 7045, 7048, 7051, 7055, 7059
PHONOTREND	7038
QUASAR	7004
RCA	7006, 7042
RENAISSANCE	7043
REVOX	7018
ROADSTAR	7027
SABA	7042
SAISHO	7027
SAMSUNG	7010
SANSUI	7027, 7055
SANYO	7028
SCHNEIDER	7042
SHARP	7017
SHERWOOD	7038
SOUNDESIGN	7049
SONY	7015, 7054, 7057, 7060
TAE KWANG	7034
TEAC	7010, 7035
TECHNICS	7004, 7062, 7065
TELEFUNKEN	7019, 7024, 7041, 7061, 7062, 7065
THORENS	7018, 7059



Controlling the rest of your system

09

UHER	7027, 7042, 7050
VICTOR	7007
WARDS	7002, 7006, 7008
YAMAHA	7016, 7017
PIONEER	7002, 7008, 7014, 7022, 7042, 7047, 7050, 7052

VCR

VCR

Manufacturer	Code
PHILIPS	2015, 2035, 2074, 2075
PANASONIC	2015, 2042, 2053, 2054, 2055, 2087
THOMSON	2021, 2064, 2074
SONY	2001, 2009, 2012, 2013, 2014, 2015
JVC	2008, 2021, 2033, 2049, 2050, 2074, 2080
GRUNDIG	2003, 2005, 2007, 2010, 2034, 2035, 2048, 2050, 2054, 2069, 2071, 2075
AKAI	2021, 2029, 2038, 2060, 2063
HITACHI	2001, 2004, 2021, 2022, 2043, 2056, 2057
TOSHIBA	2021, 2023, 2024, 2035, 2074
MITSUBISHI	2023, 2027, 2033, 2035, 2045
SHARP	2027, 2073
ORION	2002, 2004, 2016, 2036, 2046, 2052, 2070, 2072, 2078
SANYO	2025, 2026, 2037, 2057
FERGUSON	2021, 2039, 2064, 2065
BLAUPUNKT	2003, 2005, 2010, 2014, 2041, 2042, 2048, 2054, 2055, 2075
NOKIA	2025, 2037, 2038, 2057
ADMIRAL	2027, 2052
ADVENTURA	2001
AIKO	2059
AIWA	2001, 2017, 2062, 2070, 2072
AKIBA	2034
ALBA	2011, 2034, 2052, 2059, 2063, 2072
AMBASSADOR	2011
AMERICA ACTION	2059
AMERICAN HIGH	2015
AMSTRAD	2001, 2059, 2067, 2068
ANAM	2017, 2042, 2054, 2057, 2059, 2082, 2084
ANAM NATIONAL	2042, 2054, 2087
ANITECH	2034
ASA	2017, 2035
ASHA	2057
ASUKA	2017
AUDIOVOX	2017

BAIRD	2001, 2021, 2037, 2039
BASIC LINE	2011, 2034, 2059
BEAUMARK	2057
BELL & HOWELL	2037
BRANDT	2047, 2064, 2065
BRANDT ELECTRONIC	2021
BROKSONIC	2002, 2040, 2046, 2052, 2078
BUSH	2034, 2052, 2059, 2072
CALIX	2017
CANON	2015
CAPEHART	2011
CARVER	2035
CATRON	2011
CCE	2034, 2059
CGE	2001
CIMLINE	2034
CINERAL	2059
CITIZEN	2017, 2059
CLATRONIC	2011
COLT	2034
COMBITECH	2072
CONDOR	2011
CRAIG	2017, 2026, 2034, 2057, 2058
CROWN	2011, 2034, 2059
CURTIS MATHES	2015, 2021, 2032, 2042
CYBERNEX	2057
CYRUS	2035
DAEWOO	2011, 2024, 2025, 2059, 2083
DANSAI	2034
DAYTRON	2011
DECCA	2001, 2035
DE GRAAF	2022, 2043
DENON	2022
DUAL	2021
DUMONT	2001, 2035, 2037
DYNATECH	2001
ELBE	2018
ELCATECH	2034
ELECTROHOME	2017
ELECTROPHONIC	2017
EMEREX	2012
EMERSON	2001, 2002, 2017, 2023, 2040, 2046, 2051, 2052, 2059, 2078, 2083
ESC	2057, 2059
FIDELITY	2001
FINLANDIA	2035, 2037
FINLUX	2001, 2022, 2035, 2037
FIRSTLINE	2017, 2023, 2024, 2034, 2052
FISHER	2025, 2026, 2030, 2037
FRONTECH	2011
FUJI	2015





FUNAI	2001	MATSUI	2004, 2016, 2036, 2052, 2070, 2072
GARRARD	2001	MATSUSHITA	2015, 2042, 2055
GE	2015, 2027, 2032, 2057	MEI	2015
GEC	2035	MELECTRONIC	2018
GENERAL	2011, 2028	MEMOREX	2001, 2015, 2017, 2019, 2025, 2026, 2027, 2037, 2052, 2057, 2062, 2085, 2087, 2088
GOLDHAND	2034	MEMPHIS	2034
GOLDSTAR	2017, 2018, 2053, 2079	METZ	2003, 2005, 2017, 2042, 2048, 2055, 2069
GOODMANS	2001, 2017, 2034, 2059, 2075	MGA	2023, 2057
GO VIDEO	2077, 2081	MGN TECHNOLOGY	2057
GRAETZ	2005, 2021, 2037, 2057	MINCRVA	2048
GRANADA	2025, 2035, 2037	MINERVA	2005, 2010, 2048
GRADIENTE	2001, 2008	MINOLTA	2022
GRANDIN	2001, 2017, 2034	MOTOROLA	2015, 2027
HANSEATIC	2017	MTC	2001, 2057
HARMAN/KARDON	2018, 2035	MULTITECH	2001, 2034
HARLEY DAVIDSON	2001	MURPHY	2001
HARWOOD	2034	NAD	2031
HCM	2034	NATIONAL	2054
HEADQUARTER	2025	NEC	2018, 2020, 2021, 2033, 2037
HINARI	2004, 2034, 2057, 2072	NECKERMANN	2035
HI-Q	2026	NESCO	2034
HUGHES NETWORK SYSTEMS	2022	NIKKO	2017
HYPSON	2034	NIKON	2014
IMPERIAL	2001	NOBLEX	2057
INGERSOL	2004	NOKIA	2021, 2025, 2037, 2038, 2057
INTERFUNK	2035	NORDMENDE	2021, 2061, 2064, 2065, 2074
ITT	2005, 2021, 2025, 2037, 2038, 2057, 2074	OCEANIC	2001, 2021
ITV	2017, 2059	OKANO	2063, 2070
JENSEN	2021	OLYMPUS	2015, 2054
KAISUI	2034	OPTIMUS	2017, 2027, 2031, 2037, 2042, 2077, 2086, 2087, 2088
KEC	2017, 2059	OSAKI	2001, 2017, 2034
KENDO	2038, 2052	OTTO VERSAND	2035
KENWOOD	2018, 2021, 2033	PALLADIUM	2005, 2017, 2021, 2034
KLH	2034	PATHE MARCONI	2021
KODAK	2015, 2017	PATHE CINEMA	2016
KORPEL	2034	PENTAX	2022
LAYCO	2034	PENNY	2015, 2017, 2018, 2020, 2022, 2057
LENCO	2059	PERDIO	2001
LG	2079	PHILCO	2015, 2018, 2052, 2078
LLOYD'S	2001, 2051	PHONOLA	2035
LOEWE	2004, 2005, 2017, 2035	PILOT	2017
LOGIK	2004, 2034, 2057	PORTLAND	2011
LUXOR	2023, 2025, 2027, 2037, 2038	PROFEX	2066
LXI	2017	PROFITRONIC	2057
M ELECTRONIC	2001	PROLINE	2001
MAGNASONIC	2059	PROSCAN	2032
MAGNAVOX	2001, 2015, 2019, 2035		
MAGNIN	2057		
MANESTH	2024, 2034		
MARANTZ	2003, 2005, 2015, 2035		
MARTA	2017		



Controlling the rest of your system

09

PROTEC	2034
PULSAR	2019
PYE	2035
QUARTER	2025
QUARTZ	2025
QUASAR	2015, 2042, 2087
QUELLE	2035
RADIO SHACK	2001, 2085
RADIOLA	2035
RADIX	2017
RANDEX	2017
RCA	2015, 2022, 2027, 2032, 2038, 2057
REALISTIC	2001, 2015, 2017, 2025, 2026, 2027, 2037
REX	2021, 2074
RFT	2075
RICOH	2014
ROADSTAR	2017, 2034, 2057, 2059
RUNCO	2019
SABA	2021, 2049, 2050, 2061, 2064, 2065, 2074
SAISHO	2004, 2016, 2036, 2052
SALORA	2023, 2025, 2038
SANKY	2019, 2027
SANSUI	2001, 2021, 2033, 2052, 2058, 2078
SAMSUNG	2024, 2057, 2076, 2077
SAVILLE	2072
SBR	2035
SCHAUB LORENZ	2001, 2005, 2021, 2037
SCHNEIDER	2001, 2034, 2035
SCOTT	2023, 2024, 2040, 2046
SEARS	2001, 2015, 2017, 2022, 2025, 2026, 2037
SEG	2057, 2066
SEI	2004, 2035
SELECO	2021
SEMP	2024
SENTRA	2011
SHINTOM	2034, 2037
SHOGUN	2057
SHORAI	2004
SIEMENS	2003, 2005, 2010
2017, 2030, 2035	2037, 2048
SILVA	2017
SINGER	2024, 2034
SINUDYNE	2004, 2035
SOLAVOX	2011
SONOLOR	2025
SONTEC	2017
STS	2022
SUNKAI	2070

SUNSTAR	2001
SUNTRONIC	2001
SYLVANIA	2001, 2015, 2023, 2035
SYMHONIC	2001
TASHIKO	2001
TATUNG	2001, 2021, 2035
TEAC	2001, 2021
TEC	2011
TECHNICS	2015, 2042, 2054
TEKNIKA	2001, 2015, 2007, 2017, 2028
TELEAVIA	2021
TELEFUNKEN	2021, 2047, 2058, 2064, 2074
TENOSAL	2034
TENSAI	2001, 2066
THOMAS	2001
THORN	2016, 2021, 2037
TMK	2051, 2057
TOTEVISION	2017, 2057
TOWADA	2066
UHER	2057
UNITECH	2057
UNIVERSUM	2001, 2006, 2010, 2017, 2035, 2038, 2048, 2057, 2067
VECTOR	2024
VECTOR RESEARCH	2018, 2020
VICTOR	2008, 2021, 2033
VIDEO CONCEPTS	2020, 2024
VIDEOSONIC	2057
WARDS	2001, 2015, 2022, 2026, 2027, 2032, 2034, 2035, 2057
WHITE WESTINGHOUSE	2052, 2059
XR-1000	2001
XR-1001	2015
XR-1002	2034
YAMAHA	2018
YAMISHI	2034
YOKAN	2034
YOKO	2011, 2057
ZENITH	2001, 2014, 2019, 2052, 2078
PIONEER	2031, 2033, 2035, 2044, 2056

SATELLITE TUNER



Manufacturer	Code
ABSAT	4006
AST	4027
ALBA	4029, 4034, 4037, 4052
ALDES	4019
AMSTRAD	4003, 4016, 4025, 4038, 4039, 4042
ANKARO	4013, 4019, 4030, 4044
ANTTRON	4009, 4034

65

En

**09****Controlling the rest of your system**

ARMSTRONG 4015
 ASTRA 4005
 ASTRO 4008, 4039, 4045
 AVALON 4031
 AXIS 4030, 4046
 BT 4053
 BEKO 4010
 BEST 4030
 BLAUPUNKT 4008
 BOCA 4015, 4043
 BRAIN WAVE 4022
 BRITISH SKY BROADCASTING 4058
 BUSH 4002
 CNT 4045
 CAMBRIDGE 4024
 CANAL SATELLITE 4059
 CANAL+ 4059
 CHANNEL MASTER 4029
 COMLINK 4019
 CONNEXIONS 4031
 CROWN 4015
 CYRUS 4011
 D-BOX 4054
 DDC 4029
 DNT 4011, 4031
 ECHOSTAR 4031, 4036, 4061
 EMANON 4034
 FTE HUMAX 4060
 FERGUSON 4002, 4009, 4010, 4023
 FIDELITY 4016
 FINLUX 4005, 4024, 4032, 4037
 FRACARRO 4061
 FREECOM 4034
 FUBE 4030, 4031, 4034
 G-SAT 4009
 GALAXIS 4019, 4057, 4060
 GENERAL INSTRUMENT 4012
 GOLD BOX 4059
 GOODING 4048
 GOODMANS 4010
 GRUNDIG 4008, 4010, 4048
 HINARI 4009
 HIRSCHMANN 4008, 4032, 4039, 4040, 4049
 HITACHI 4037
 HOUSTON 4053
 HUTH 4013, 4015, 4019, 4026
 ITT 4005
 INVIDEO 4061
 INTERVISION 4050
 JVC 4048
 JOHANSSON 4022
 KATHREIN 4004, 4006, 4008, 4011, 4035, 4041

KREISELMEYER 4008
 KYOSTAR 4034
 LA SAT 4043, 4045
 LENCO 4034
 LENNOX 4050
 LUPUS 4030
 LUXOR 4005, 4049
 MANHATTAN 4037, 4045, 4050
 MARANTZ 4011
 MASPRO 4004, 4023
 MATSUI 4024, 4048
 MEDIASAT 4059
 MEDIAMARKT 4015
 MINERVA 4048
 MORGAN'S 4015, 4043
 NAVEX 4022
 NEUHAUS 4039
 NEUSAT 4057
 NEWHAUS 4013
 NIKKO 4028
 NOKIA 4005, 4032, 4037, 4049, 4054, 4063
 NORDMENDE 4029
 ORBITECH 4039
 OXFORD 4024
 PACE 4002, 4009, 4014, 4023, 4037, 4055, 4058
 PALLADIUM 4048
 PALSAT 4039
 PANDA 4037
 PHILIPS 4007, 4011, 4020, 4037, 4048, 4059
 PHONOTREND 4019, 4050
 PIONEER 4021, 4059
 PLANET 4061
 PROMAX 4037
 PROSAT 4019
 QUADRAL 4029, 4044
 RADIOLA 4011
 RADIX 4031, 4064
 RFT 4011, 4013, 4019
 SAT 4027, 4038
 SABA 4023, 4045
 SABRE 4037
 SAGEM 4056
 SALORA 4005
 SATCOM 4026, 4051
 SATEC 4009
 SATMASTER 4026
 SATPARTNER 4022, 4034, 4040, 4045
 SCHWAIGER 4009, 4041
 SEEMANN 4031, 4046



Controlling the rest of your system

09

SEG	4030, 4034
SIEMENS	4008
SKYMASTER	4019, 4044, 4051
SONY	4017, 4018
STRONG	4062
SUNSTAR	4043
TPS	4056
TANTEC	4023, 4037
TECHNISAT	4001, 4039
TECHNILAND	4026
TELEFUNKEN	4034
TELEKA	4015, 4052
TELESAT	4051
THOMSON	4037, 4059
TONNA	4026, 4053
TRIAD	4027
TRIASAT	4040
UNITOR	4022
UNIVERSUM	4008, 4049
VENTANA	4011
VORTEC	4034
VTECH	4027
WINERSAT	4022
WISI	4008, 4027, 4031, 4037
XSAT	4006, 4065
XCOM MULTIMEDIA	4065
ZEHNDER	4033, 4045, 4047

JASCO	3007
JERROLD	3002, 3004, 3005, 3006, 3007, 3020, 3031, 3046
LG ALPS	3044
MEMOREX	3001
MNET	3009, 3028
NOW	3041
OAK	3009
PACIFIC	3039
PANASONIC	3001, 3013
PARAGON	3001
PULSAR	3001
PVP STEREO VISUAL	
MATRIX	3002
PIONEER	3010, 3014, 3018, 3036
QUASAR	3001
RADIO SHACK	3007
REMBRANDT	3004
RUNCO	3001
SAMSUNG	3014, 3040
SATBOX	3024
SIGNAL	3007
SIGNATURE	3004
STS	3015
SALORA	3026
SCIENTIFIC	3003, 3032, 3049
SCIENTIFIC ATLANTA	3003, 3008, 3021
SEAWOO	3045
STARCOM	3002, 3007
STARGATE	3007
STARQUEST	3007
TAIHAN	3043
TELESERVICE	3022
TELE+1	3028
TUDI	3023
TUSA	3007
TOCOM	3005
TONGKOOK	3042, 3048
TOSHIBA	3001
UNITED CABLE	3002
VIDEOWAY	3017
VISICABLE+	3033
WESTMINSTER	3012
WOLSEY GENE	3037
ZENITH	3001, 3034

CABLE TV



Manufacturer	Code
ABC	3002, 3003, 3004, 3006, 3008
ANDOVER	3037
BELL & HOWELL	3006
BIRGMINGHAM CABLE COMMUNICATION	3020
BRITISH TELECOM	3002, 3012
CABLETIME	3016, 3019, 3025, 3029
CONTEC	3009
CLYDE	3011
CRYPTOVISION	3038
DAEHAN	3043
DAERYUNG	3003
DECSAT	3027
EVERQUESST	3007
FILMNET	3028
FRANCE TELECOM	3030
GEC	3011
GEMINI	3007
GENERAL INSTRUMENT	3004, 3020, 3031, 3046
GOLDSTAR	3014, 3047
GRUNDIG	3035
HITACHI	3004

67

En

Troubleshooting

Incorrect operations are often mistaken for trouble and malfunctions. If you think that there is something wrong with this component, check the points below. Sometimes the trouble may lie in another component. Investigate the other components and electrical appliances being used. If the trouble cannot be rectified even after exercising the checks listed below, ask your nearest Pioneer authorized service center or your dealer to carry out repair work.

Problem	Remedy
The power does not turn on.	<ul style="list-style-type: none"> • Connect the power plug to the wall outlet. • Disconnect the power plug from the outlet, and insert again. • Make sure there are no loose strands of speaker wire touching the rear panel. This could cause the receiver to shut off automatically.
No sound is output when a function is selected.	<ul style="list-style-type: none"> • Make sure the component is connected correctly (refer to pages 14–19). • Press MUTE on the remote control to turn muting off. • Adjust the MASTER VOLUME. • Press the MONITOR button to turn monitoring off.
No image is output when a function is selected.	<ul style="list-style-type: none"> • Make sure the component is connected correctly (refer to pages pages 14–19). • Select the correct component (use the MULTI JOG/INPUT SELECTOR dial or the MULTI CONTROL buttons on the remote).
Considerable noise in radio broadcasts.	<ul style="list-style-type: none"> • Tune in the correct frequency. • Connect the antenna (refer to page 19). • Route RF and digital cables away from the antenna terminals and wires. • Fully extend the FM wire antenna, position for best reception, and secure to a wall. • Connect an outdoor FM antenna (refer to page 19). • Adjust the direction and position for best reception. • Connect an additional internal or external AM antenna (refer to page 19). • Turn off the equipment causing the noise or move it away from the receiver. • Place the antenna farther away from the equipment causing the noise.
Broadcast stations cannot be selected automatically.	<ul style="list-style-type: none"> • Connect an outdoor antenna (refer to page 19).



Additional information

10

Problem	Remedy
No sound from surround or center speakers.	<ul style="list-style-type: none">Refer to <i>Speaker setting</i> on page 39 to check the speaker settings.Refer to <i>Setting the relative volume level of each channel</i> on page 44 to check the speaker levels.Connect the speakers properly (refer to page 19–21).
No sound from surround back speakers.	<ul style="list-style-type: none">Refer to <i>Surround back speaker setting</i> on page 40 to check the surround back speaker settings.Refer to the table on page 33 to make sure the 6.1 channel setting and the sound mode are set for surround back sound.
Noise during playback of a cassette deck.	<ul style="list-style-type: none">Move the cassette deck further from your receiver, until the noise disappears.
Sound is produced from other components, but not from LD or DVD player.	<ul style="list-style-type: none">Set the SIGNAL SELECT to AUTO, DIGITAL or ANALOG according to the type of connections made. (refer to page 34).Set the digital input settings correctly (refer to page 43).Make digital connections (refer to page 14) and set the SIGNAL SELECT to DIGITAL (refer to page 34).Refer to the instruction manual supplied with the DVD player.
No sound is output or a noise is output when software with DTS is played back.	<ul style="list-style-type: none">Set the digital volume level of the player to full, or to the neutral position.
When a search is performed by a DTS compatible CD player during playback, noise is output.	<ul style="list-style-type: none">This is not a malfunction, but be sure to turn the volume down to prevent the output of loud noise from your speakers.
Can't operate the remote control.	<ul style="list-style-type: none">Replace the batteries (refer to page 6).Operate within 23 feet (7 m), 30° of the remote sensor on the front panel (refer to page 6).Remove the obstacle or operate from another position.Avoid exposing the remote sensor on the front panel to direct light.
The display is dark or off.	<ul style="list-style-type: none">Press FL DIMMER on the remote control repeatedly to return to the default.

Note

If the unit does not operate normally due to external effects such as static electricity disconnect the power plug from the outlet and insert again to return to normal operating conditions.

69

En

Specifications

Amplifier Section

Continuous average power output of 100 watts* per channel, min., at 8 ohms, from 20 Hz to 20,000 Hz with no more than 0.2 %** total harmonic distortion (front).

Continuous Power Output

Front 100 W per channel
(1kHz, 1.0 %, 8 Ω)
Center 100 W (1kHz, 1.0 %, 8 Ω)
Surround 100 W per channel
(1kHz, 1.0 %, 8 Ω)
Surround Back* 100 W per channel
(1kHz, 1.0 %, 8 Ω)

* VSX-D811S only

Input (Sensitivity/Impedance)

CD, VCR/DVR, CD-R/TAPE/MD,
DVD/LD, TV/SAT 200 mV/47 kΩ

Frequency Response

CD, VCR/DVR, CD-R/TAPE/MD, DVD/LD,
TV/SAT 5 Hz to 100,000 Hz ± 0.5 dB

Output (Level/Impedance)

VCR/DVR REC, CD-R/TAPE/
MD REC 200 mV/2.2 kΩ

Tone Control

BASS ± 6 dB (100 Hz)
TREBLE ± 6 dB (10 kHz)
LOUDNESS +9 dB/+9 dB
(100 Hz/10 kHz)

Signal-to-Noise Ratio (IHF, short circuited, A network)

CD, VCR/DVR, CD-R/TAPE/MD,
DVD/LD, TV/SAT 96 dB

Signal-to Noise Ratio [EIA, at 1 W (1 kHz)]

CD, VCR/DVR, CD-R/TAPE/MD,
DVD/LD, TV/SAT 79 dB

Video Section

Input (Sensitivity/Impedance)

VCR/DVR, DVD/LD, TV/SAT 1 Vp-p/75 Ω

Output (Level/Impedance)

VCR/DVR 1 Vp-p/75 Ω

Frequency Response

VCR/DVR, DVD/LD,
TV/SAT \Rightarrow MONITOR 5 Hz to 7 MHz ± 0.5 dB
Signal-to-Noise Ratio 55 dB
Cross Talk 55 dB

FM Tuner Section

Frequency Range 87.5 MHz to 108 MHz
Usable Sensitivity Mono: 13.2 dBf, IHF
(1.3 μ V/ 75 Ω)
50 dB Quieting Sensitivity Mono: 20.2 dB
Stereo: 38.6 dBf
Signal-to-Noise Ratio Mono: 73 dB
(at 85 dBf)
Stereo: 70 dB (at 85 dBf)
Distortion Stereo: 0.5 % (1 kHz)
Alternate Channel Selectivity 60 dB
(400 kHz)
Stereo Separation 40 dB (1 kHz)
Frequency Response 30 Hz to 15 kHz
(± 1 dB)
Antenna Input (DIN) 75 Ω unbalanced

AM Tuner Section

Frequency Range 530 kHz to 1,700 kHz
Sensitivity (IHF, Loop antenna) 350 μ V/m
Selectivity 25 dB
Signal-to-Noise Ratio 50 dB
Antenna Loop antenna



Additional information

10

Miscellaneous

Power Requirements	AC 120 V, 60Hz
Power Consumption	
VSX-D711	260W, 340 VA
VSX-D811S	300W, 420 VA
In Standby	1 W
AC Outlet	100 W MAX. (SWITCHED)
Dimensions	420 (W) x 158 (H) x 401 (D) mm
	(16-9/16 (W) x 6-4/16 (H) x 15-6/16 (D) in.)
Weight (without package)	
VSX-D711	9.0 kg
	(19.8 lb)
VSX-D811S	10.5 kg
	(23.2 lb)

Furnished Parts

AM loop antenna	1
FM wire antenna	1
Dry cell batteries (AA size IEC R6P)	2
Remote control	1
Operating instructions	1

Note

Specifications and the design are subject to possible modifications without notice, due to improvements.

* Measured pursuant to the Federal Trade Commission's Trade Regulation rule on Power Output Claims for Amplifiers.

** Measured by Audio Spectrum Analyzer.

71

En



Dear Customer:

Selecting fine audio equipment such as the unit you've just purchased is only the start of your musical enjoyment. Now it's time to consider how you can maximize the fun and excitement your equipment offers. This manufacturer and the Electronic Industries Association's Consumer Electronics Group want you to get the most out of your equipment by playing it at a safe level. One that lets the sound come through loud and clear without annoying blaring or distortion-and, most importantly, without affecting your sensitive hearing.

Sound can be deceiving. Over time your hearing "comfort level" adapts to higher volumes of sound. So what sounds "normal" can actually be loud and harmful to your hearing. Guard against this by setting your equipment at a safe level BEFORE your hearing adapts.

To establish a safe level:

- Start your volume control at a low setting.
- Slowly increase the sound until you can hear it comfortably and clearly, and without distortion.

Once you have established a comfortable sound level:

- Set the dial and leave it there.

Taking a minute to do this now will help to prevent hearing damage or loss in the future. After all, we want you listening for a lifetime.

We Want You Listening For A Lifetime

Used wisely, your new sound equipment will provide a lifetime of fun and enjoyment. Since hearing damage from loud noise is often undetectable until it is too late, this manufacturer and the Electronic Industries Association's Consumer Electronics Group recommend you avoid prolonged exposure to excessive noise. This list of sound levels is included for your protection.

Decibel

Level	Example
30	Quiet library, soft whispers
40	Living room, refrigerator, bedroom away from traffic
50	Light traffic, normal conversation, quiet office
60	Air conditioner at 20 feet, sewing machine
70	Vacuum cleaner, hair dryer, noisy restaurant
80	Average city traffic, garbage disposals, alarm clock at two feet.

THE FOLLOWING NOISES CAN BE DANGEROUS UNDER CONSTANT EXPOSURE

90	Subway, motorcycle, truck traffic, lawn mower
100	Garbage truck, chain saw, pneumatic drill
120	Rock band concert in front of speakers, thunderclap
140	Gunshot blast, jet plane
180	Rocket launching pad

Information courtesy of the Deafness Research Foundation.





Additional information



10





10

Additional information



74
En



XRB3013A.68.74

74



01.12.12, 5:13 PM





Additional information



10





Should this product require service in the U.S.A. and you wish to locate the nearest Pioneer Authorized Independent Service Company, or if you wish to purchase replacement parts, operating instructions, service manuals, or accessories, please call the number shown below.

8 0 0 - 4 2 1 - 1 4 0 4

Please do not ship your product to Pioneer without first calling the Customer Service Department at the above listed number for assistance.

PIONEER ELECTRONICS (USA) INC.
CUSTOMER SERVICE DEPARTMENT
P.O. BOX 1760, LONG BEACH,
CA 90801-1760, U.S.A.

For warranty information please see the Limited Warranty sheet included with your product.

Should this product require service in Canada, please contact a Pioneer Canadian Authorized Dealer to locate the nearest Pioneer Authorized Service Company in Canada.
Alternatively, please contact the Customer Service Department at the following address:

Pioneer Electronics of Canada, Inc.
Customer Service Department
300 Allstate Parkway, Markham, Ontario L3R OP2
(905) 479-4411
1-877-283-5901

For warranty information please see the Limited Warranty sheet included with your product.

Si ce produit doit être réparé au Canada, veuillez vous adresser à un distributeur autorisée Pioneer au Canada pour obtenir le nom de la Société de Service Autorisée Pioneer le plus près de chez vous. Ou encore, veuillez vous communiquer avec le Service de Clientèle de Pioneer:

Pioneer électroniques du Canada, Inc.
Département de service au consommateurs
300 Allstate Parkway, Markham, Ontario L3R OP2
(905) 479-4411
1-877-283-5901

Pour obtenir des renseignements sur la garantie, veuillez vous reporter au feuillet sur la Garantie Limitée qui accompagne le produit.

Published by Pioneer Corporation.
Copyright © 2001 Pioneer Corporation.
All rights reserved.

PIONEER CORPORATION

4-1, Meguro 1-Chome, Meguro-ku, Tokyo 153-8654, Japan

PIONEER ELECTRONICS [USA] INC.

P.O. BOX 1540, Long Beach, California 90801-1540, U.S.A.

PIONEER ELECTRONICS OF CANADA, INC.

300 Allstate Parkway, Markham, Ontario L3R OP2, Canada

PIONEER EUROPE NV

Haven 1087, Keetberglaan 1, B-9120 Melsele, Belgium TEL: 03/570.05.11

PIONEER ELECTRONICS AUSTRALIA PTY. LTD.

178-184 Boundary Road, Braeside, Victoria 3195, Australia, TEL: [03] 9586-6300

PIONEER ELECTRONICS DE MEXICO S.A. DE C.V.

San Lorenzo 1009 3er Piso Desp. 302 Col. Del Valle Mexico D.F. C.P. 03100
TEL: 55-5688-5290

<TNGZF/01L00001>

Printed in

<XRB3013-A>



Free Manuals Download Website

<http://myh66.com>

<http://usermanuals.us>

<http://www.somanuals.com>

<http://www.4manuals.cc>

<http://www.manual-lib.com>

<http://www.404manual.com>

<http://www.luxmanual.com>

<http://aubethermostatmanual.com>

Golf course search by state

<http://golfingnear.com>

Email search by domain

<http://emailbydomain.com>

Auto manuals search

<http://auto.somanuals.com>

TV manuals search

<http://tv.somanuals.com>