



Optional Firmware Update (Version 1.03) for 2013 Navigation Models: AVIC-Z150BH and AVIC-X950BH

In this manual, iPhone® 5 and iPod® touch fifth generation will be referred to as “iPhone with Lightning connector.”

The following preparatory steps must first be undertaken in order to connect an iPhone with Lightning connector to your AVIC-Z150BH or AVIC-X950BH and use AppRadio Mode.

- A. Download the firmware update files**
- B. Update the firmware on your AVIC-Z150BH or AVIC-X950BH**
- C. Verify System Application Version**
- D. Pair your iPhone with Lightning connector with your AVIC-Z150BH or AVIC-X950BH and establish a connection between your iPhone with Lightning connector and the AVIC-Z150BH or AVIC-X950BH via Bluetooth wireless technology**
- E. Connect your iPhone with Lightning connector to your AVIC-Z150BH or AVIC-X950BH using Pioneer CD-IH202 AppRadio Mode HDMI Interface Cable Kit for iPod/iPhone (sold separately)**

Once Steps A through D have been completed, the [**Apps**] key on the Home screen will become active, allowing you to utilize AppRadio Mode.

IMPORTANT

- “iPod source” will no longer be available when using AppRadio Mode with an iPhone with Lightning connector. To play music and/or video files from your iPhone with Lightning connector, please first install the free of charge CarMediaPlayer app on your iPhone with Lightning connector and then launch CarMediaPlayer while in AppRadio Mode.
- If you have previously paired your iPhone with Lightning connector with the AVIC-Z150BH or AVIC-X950BH, you will have to re-register and connect your device after the firmware update has been completed.



A. Downloading the firmware update files

IMPORTANT

Please download and print these AVIC-Z150BH and AVIC-X950BH Firmware Update instructions before downloading and installing the firmware update. It is very important that you complete all steps correctly and in the order described below.

WARNING! This firmware update applies only to AVIC-Z150BH or AVIC-X950BH units sold in the United States and Canada. Installing the update on other products could seriously damage the unit.

NOTE: *If you have any difficulty carrying out these instructions, or wish to have this optional update performed by Pioneer, please contact the Pioneer Customer Support Center toll free at (800) 421-1404 during regular business hours (M-F 10:30AM- 7:00PM Eastern Time, excluding holidays) for assistance. If this optional firmware update is performed by Pioneer, there is a charge of \$60.00 (this charge includes return shipping of the updated unit within the U.S.). Charges for removal/reinstallation of the unit and shipment to Pioneer are the customer's responsibility.*

Procedure

1. Download the **AVIC-Z150BH** firmware update files [here](#).

Download the **AVIC-X950BH** firmware update files [here](#).

2. **Locate and decompress the downloaded file.**

The downloaded file will produce the following two items when decompressed: an "AVICX850" folder and "TESTMODE.KEY":

Name	Date modified	Type
 AVICX850	4/26/2013 9:35 AM	File folder
 TESTMODE.KEY	3/6/2013 4:27 PM	KEY File

NOTE: Although the folder is named "AVICX850", it does indeed contain the correct firmware files for your AVIC-Z150BH or AVIC-X950BH. **Do not rename the folder or attempt to install these files on anything other than the AVIC-Z150BH or AVIC-X950BH.** If you do not have a file decompression utility installed on your computer, you may download WinZip at <http://www.winzip.com> (purchase may be required).



B. Updating the firmware on your AVIC-Z150BH or AVIC-X950BH

IMPORTANT

- Please DO NOT perform any further steps of this firmware update if the model number is anything other than AVIC-Z150BH or AVIC-X950BH
- For the AVIC-Z150BH, the model number is located to the left of the volume buttons.
- For the AVIC-X950BH, the model number is located centrally, just below the touchscreen.

SD Card or microSD Card Device Requirements:

- AVIC-Z150BH, SD or SDHC card, formatted to FAT16 or FAT32, 250MB or larger
- AVIC-X950BH, microSD or microSDHC card, formatted to FAT16 or FAT32, 250MB or larger
- Ensure that the update folder and file are located within the root (top) folder of your SD or microSD card. There should be no other files on the SD or microSD card.
- **While your AVIC-Z150BH or AVIC-X950BH is being updated, DO NOT turn off the system's power. Failure to heed this warning may result in serious damage to your Pioneer GPS Navigation system.**
- **DO NOT remove the SD card or microSD card during the firmware update process.**
- **Performing the firmware update will restore all settings to their default values.**
- **Disconnect any mobile devices including USB flash drives that are currently connected to your AVIC-Z150BH or AVIC-X950BH.**

Procedure

1. **Connect a blank and formatted SD card or microSD card to your computer, and then locate and copy the "AVICX850" folder and "TESTMODE.KEY" file onto the SD card or microSD card.**
2. **Turn your vehicle's key to the ON position and power up your AVIC-Z150BH or AVIC-X950BH.**
3. **Turn the AV source to [OFF].**
 - If the display is currently showing the map screen, press the 'MODE' button on the Pioneer GPS navigation system to view the AV source screen, then select [OFF].



4. Insert the SD Card or microSD Card into your AVIC-Z150BH or AVIC-X950BH.

- The system will automatically recognize the firmware update file, reboot, and start the update process within a minute.

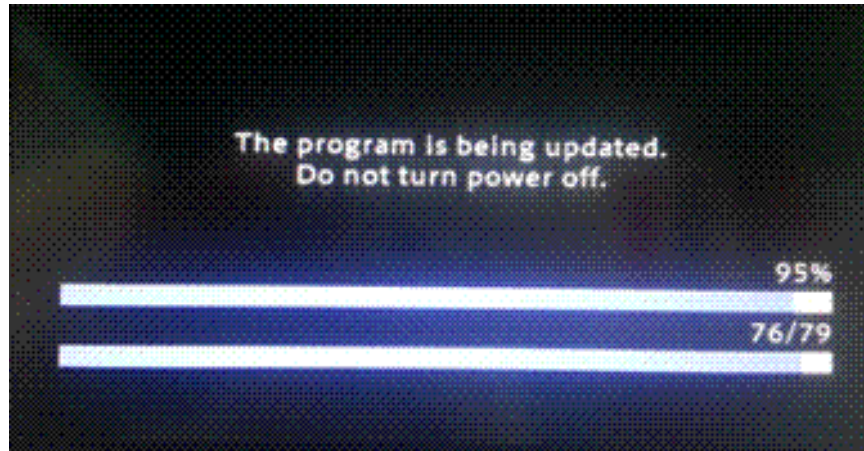

- **If the AV Source screen was not set to [OFF] prior to inserting the SD card or microSD card, you will only see a black screen and the above update screen will not be visible. If this is the case, do not turn off power or eject the SD Card or microSD Card for at least 5 minutes as the update process may be in process. Failure to heed this warning may result in serious damage to your Pioneer GPS Navigation system.**
- The initial update process will take approximately 2 to 3 minutes to complete. The AVIC-Z150BH or AVIC-X950BH will automatically reboot and the “*Program forced write*” screen will appear:





5. With the “Program forced write” screen displayed, press the ‘HOME’  button on your AVIC-X950BH or AVIC-Z150BT.

- The “Program forced write [System uCom Write]” screen will appear:

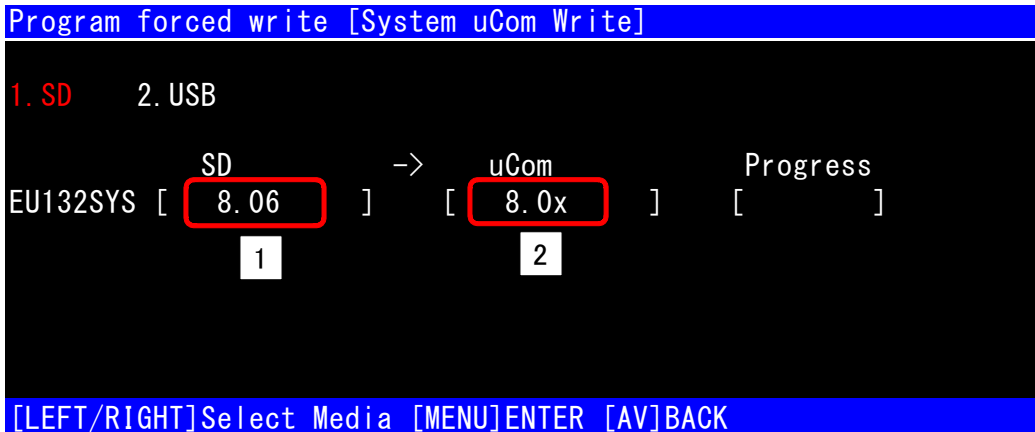

- Confirm that 1) The SD Version shows 8.06 and 2) the uCom version is lower than 8.06.
- If the SD version is displayed as “-----” the data on the SD Card or microSD Card may be corrupted. Please repeat the firmware download and installation process.

6. If the SD version is correct, and the uCom version is lower than 8.06, press the ‘HOME’  button on your AVIC-X950BH or AVIC-Z150BT to begin the uCom update.

- **Do not turn off power or eject the SD card or microSD card while the update is in progress. Failure to heed this warning may result in serious damage to your Pioneer GPS Navigation system.**

7. Once the uCom update is complete, the AVIC-Z150BH and AVIC-X950BH will automatically reboot and the “Program forced write” screen will reappear:





8. Press the 'HOME'  button on your AVIC-Z150BH and AVIC-X950BH to view the "Program forced write [System uCom Write]" screen.

9. Confirm that the uCom version shows 8.06:

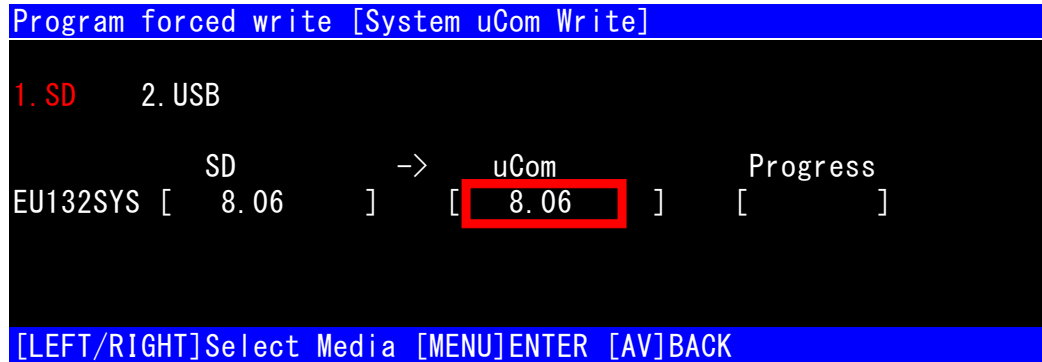

10. Eject the SD card or microSD card and turn the vehicle's key to the OFF position to power off your AVIC-Z150BH or AVIC-X950BH.

- To eject the SD card from the AVIC-Z150BH, press and hold the Eject button until the faceplate motorizes down to reveal the SD card slot.

C. Verifying System Application Version

1. Turn your vehicle's key to the ON position and power up your AVIC-Z150BH or AVIC-X950BH.
2. Press the 'HOME'  button on your AVIC-X950BH or AVIC-Z150BT to view the main home screen menu:

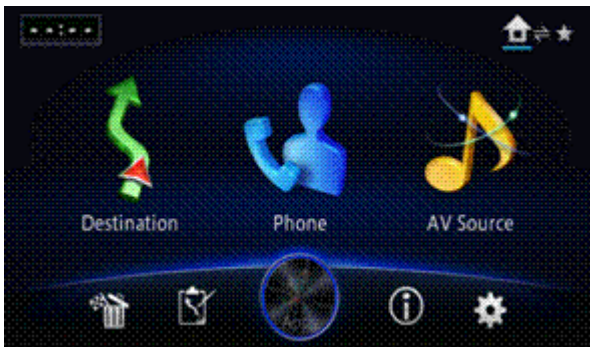

3. Press the 'INFORMATION'  icon to display the system information screen:



4. Touch and hold the letters 'INFO' in the word Information at the upper left corner of the screen to access the service information screen:



5. Confirm that the Application Version shows **1.030000**



D. Pairing and Connecting Your iPhone with Lightning Connector via Bluetooth Wireless Technology

IMPORTANT

- If you have previously paired your iPhone with Lightning connector to the AVIC-Z150BH or AVIC-X950BH, you will have to re-register and connect your device after the firmware update has been completed. Please refer to the “Registering and connecting a Bluetooth device” in your owner’s manual for additional details.

1. Once you have initially paired your iPhone with Lightning connector to the AVIC-Z150BH or AVIC-X9550BH, some pop-up notifications will appear on the Pioneer touchscreen display. The unit will first ask *“Would you like to transfer all contacts?”*:

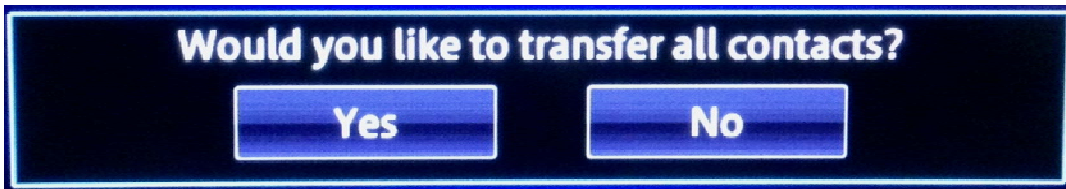

- Select “Yes” or “No”, either selection has no impact on AppMode compatibility for an iPhone with Lightning connector.
 - If you select “Yes” the display will show “Transferring contacts from cellular phone device.” followed by “___ contacts data transferred successfully.” before proceeding to step 2.
 - If you select “No” the display will proceed to step 2.

2. The display will show *“This device has Bluetooth Audio capability. Would you like to use it?”*:

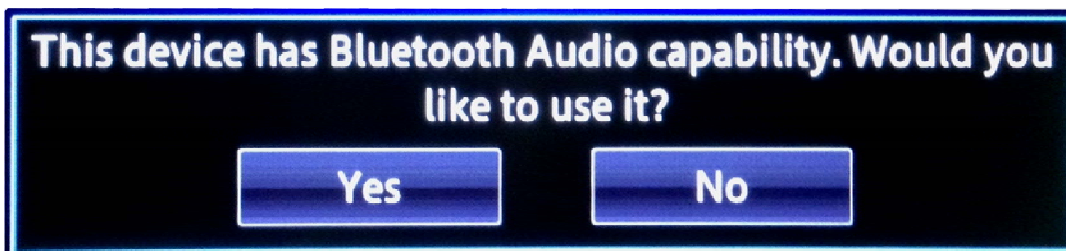

- Select “Yes”

3. The next screen will ask *“Is this Android?”*

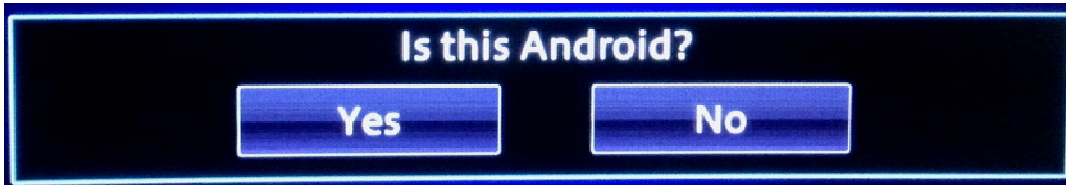

- Select "No"

4. *“Is this device equipped with a Digital AV/VGA Connector?”*

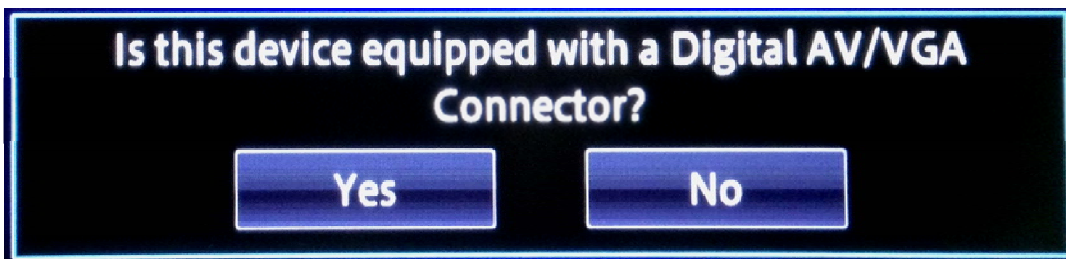

- Select "Yes"

5. The screen will then display *“Do you want to set this device for the AppRadio Mode?”*:

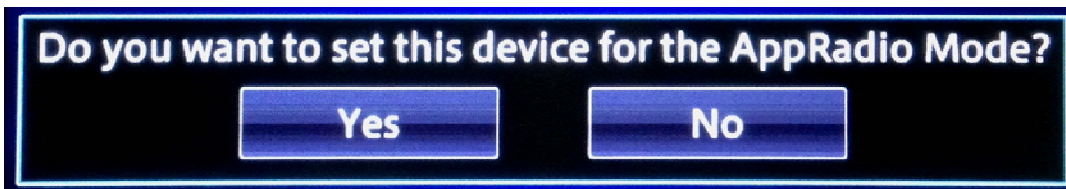

- Select "Yes"

6. The screen will then confirm your AppRadio Mode selection :



- Press "OK"



7. Lastly, the display will notify you that “Bluetooth device setting completed.”

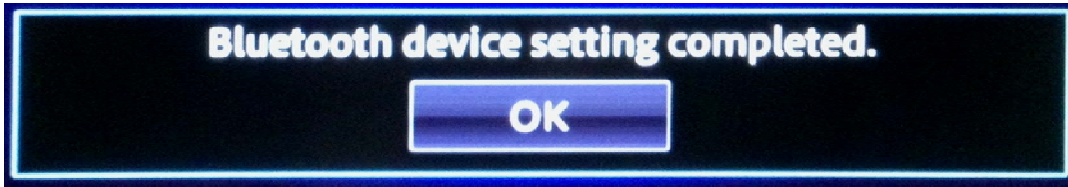

- Press “OK”

8. Your iPhone with Lightning connector is now connected via Bluetooth and ready for AppRadio Mode.

E. Connecting Your iPhone with Lightning Connector

IMPORTANT

- The Pioneer CD-IH202 AppRadio Mode HDMI Interface Cable Kit for iPod/iPhone is required (sold separately).
- A Lightning to USB Cable (Apple Inc. product- supplied with iPhone or sold separately) **and** a Lightning Digital AV Adapter (Apple Inc. product, sold separately) are also required.
- AppRadio Mode should only be used in the connection configuration shown. Do not use any other configuration when connecting your device.

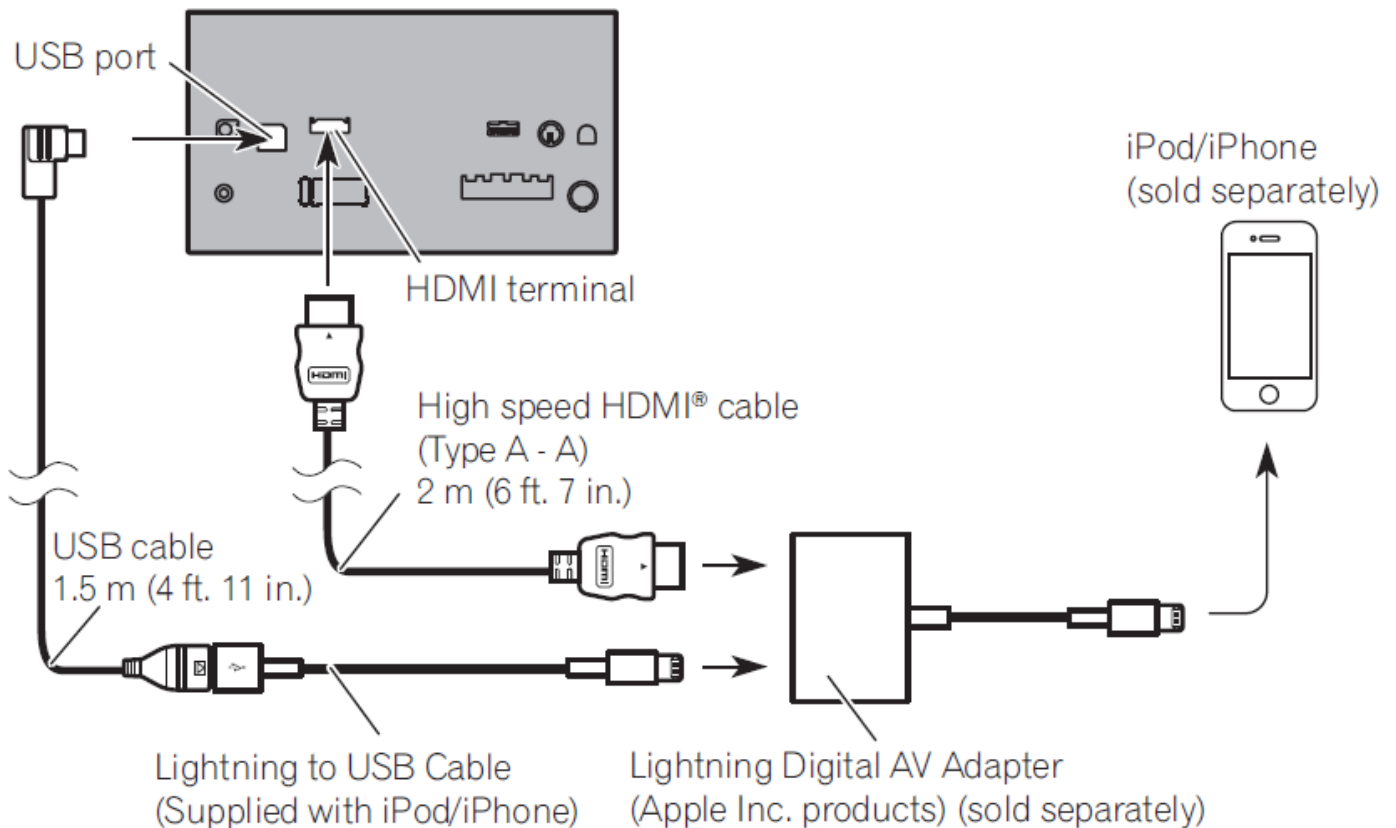

Free Manuals Download Website

<http://myh66.com>

<http://usermanuals.us>

<http://www.somanuals.com>

<http://www.4manuals.cc>

<http://www.manual-lib.com>

<http://www.404manual.com>

<http://www.luxmanual.com>

<http://aubethermostatmanual.com>

Golf course search by state

<http://golfingnear.com>

Email search by domain

<http://emailbydomain.com>

Auto manuals search

<http://auto.somanuals.com>

TV manuals search

<http://tv.somanuals.com>