



# CID-947 79-Memory Caller ID Module

with Backlight



**Owner's Manual**  
Please read before using this equipment.



---

---

## Contents

<b>Features .....</b>	<b>4</b>
FCC Information .....	6
<b>Preparation .....</b>	<b>8</b>
Installing Batteries .....	8
Connecting the AC Adapter .....	10
Connecting the Module .....	11
Mounting the Module .....	13
Adjusting the Display Contrast .....	15
Choosing a Language .....	16
Setting Your Local Area Code .....	16
<b>Operation .....</b>	<b>17</b>
Receiving and Storing Calls .....	17
Reviewing Call Records .....	17
Redialing From Call Record Memory .....	21
Deleting Calls .....	21
VIP Call List .....	22
<b>Troubleshooting .....</b>	<b>24</b>
<b>Care and Maintenance .....</b>	<b>25</b>
The FCC Wants You to Know .....	26
Lightning .....	26

**WARNING:** To reduce the risk of fire or shock hazard, do not expose this product to rain or moisture.

	<b>CAUTION</b> RISK OF ELECTRIC SHOCK. DO NOT OPEN.	
<b>CAUTION:</b> TO REDUCE THE RISK OF ELECTRIC SHOCK, DO NOT REMOVE COVER OR BACK. NO USER-SERVICE-ABLE PARTS INSIDE. REFER SERVICING TO QUALIFIED PERSONNEL.		



This symbol is intended to alert you to the presence of uninsulated dangerous voltage within the product's enclosure that might be of sufficient magnitude to constitute a risk of electric shock. Do not open the product's case.



This symbol is intended to inform you that important operating and maintenance instructions are included in the literature accompanying this product.

The graphical symbols with supplemental markings are located on the bottom of the module.

---

---

## **Features**

Your RadioShack 79-Memory Caller ID Module with Backlight is the latest in telephone technology. The module displays the caller's telephone number (and name, if available in your area) and the current date and time, as provided by your local phone company to Caller ID service subscribers. (The date and time are set with your first incoming Caller ID call.) Your module includes these features:

**Caller ID Memory** — the module stores and displays up to 79 multiple (name and number) Caller ID records.

**Bright Illuminator Backlight** — the display lights when you press any button, making it easy to view and change information even in a dimly-lit area.

**Dial Back** — lets you redial a telephone number stored in the Caller ID call memory and VIP record memory.

**New Call Indicator** — flashes when you have at least one new call you have not reviewed.

**VIP Call List** — lets you save up to 20 important call records so they will not be deleted when you delete other calls from the module's memory.

**Call Summary** — displays the number of new calls you received.

**Easy Installation** — the module easily connects to your telephone line so you can quickly begin using it.

**Record Scrolling** — lets you easily look through all call records in Caller ID memory.

**Trilingual Operation** — lets you set the module to display messages in English, French, or Spanish.

**Large Liquid Crystal Display** — makes it easy to see caller information and the current time and date.

**Contrast Control** — lets you adjust the display contrast for the best readability.

**Time and Date Display** — displays the current time and date as provided to Caller ID service subscribers by your local telephone company.

**Mounting Options** — you can place the module on a desk, shelf, or table, or mount it on a wall.

**Note:** Your module requires four AAA batteries (not supplied) to protect its memory during a power outage.

This module has been tested and found to comply with all applicable FCC standards and is ETL listed.

To use this module, you must be in an area where Caller ID service is available and you must subscribe to the service.

Where Caller ID is offered, one or more of the following options are generally available:

- caller's number only
- caller's name only
- caller's name and number

Your module displays the caller's name only if that option is available in your area.



The actual number of Caller ID records your module will store depends on the amount of Caller ID information sent by the phone company.

## FCC INFORMATION

This module has been tested and found to comply with all applicable FCC standards.

We have designed your module to conform to federal regulations, and you can connect it to most telephone lines. However, each module (and each device, such as a telephone or answering machine) that you connect to the telephone line draws power from the telephone line. We refer to this power draw as the device's ringer equivalence number, or REN. The REN is on the bottom of your module.

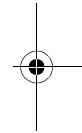
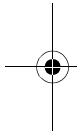

If you use more than one phone or other device on the line, add up all of the RENs. If the total is more than five (or three in rural areas), your telephones might not ring. If ringer operation is impaired, remove a device from the line.

Your module complies with Part 68 of *FCC Rules*. You must, upon request, provide the FCC registration number and the REN to your telephone company. Both numbers are on the bottom of the module.

**Note:** You must not connect your module to:

- coin-operated systems
- party-line systems
- most electronic key telephone systems

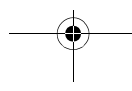



This equipment complies with the limits for a Class B digital device as specified in Part 15 of *FCC Rules*. These limits provide reasonable protection against radio and TV interference in a residential area. However, your equipment might cause TV or radio interference even when it is operating properly. To eliminate interference, you can try one or more of the following corrective measures:

- reorient or relocate the receiving antenna
- increase the distance between the equipment and the radio or TV
- use outlets on different electrical circuits for the equipment and the radio or TV

Consult your local RadioShack store if the problem still exists.

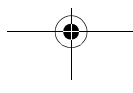
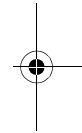
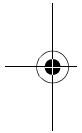

## **Preparation**

Your module's display is protected by a piece of plastic film during shipment. Peel off this film before you use the module.

### **INSTALLING BATTERIES**

Your module requires four AAA batteries (not supplied) to protect its memory during a power failure. For the best performance and longest life, we recommend RadioShack alkaline batteries.

#### **Cautions:**

- Use only fresh batteries of the required size and recommended type.
- Do not mix old and new batteries or different types of batteries (standard, alkaline, or rechargeable), or rechargeable batteries of different capacities.
- When you replace the batteries, do not press any buttons on the module after you remove the old batteries. Doing so could erase all stored information.
- When replacing the batteries, have fresh ones on hand before you begin. If you do not install the new batteries within about 2 minutes after removing the old ones, you will lose all the information stored in the module.

Follow these steps to install batteries.

1. If you are replacing batteries, unplug the module from the telephone line, the telephone, and AC power. Unplug both modular line cords from the back of the module.



2. Use a Phillips screwdriver to remove the screw from the battery compartment cover.
3. Slide the battery compartment cover in the direction of the arrow until it stops, then lift up the cover.

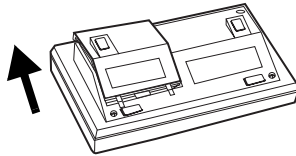

**Caution:** The battery compartment cover is attached to the module. Do not try to remove it completely.

4. Place the batteries in the compartment, as indicated by the polarity symbols (+ and -) marked inside.

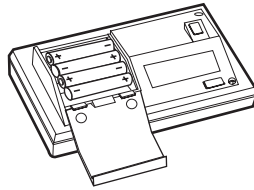

5. Close the cover and secure it with the screw. If you are replacing the batteries, reconnect the phone line, AC adapter, and the phone.

When **BATT** (battery) appears or the display dims, replace the batteries.

**Warning:** Dispose of old batteries promptly and properly. Do not burn or bury them.

**Caution:** If you do not plan to use the module for a month or more, remove the batteries. Batteries can leak chemicals that can destroy electronic parts.

## CONNECTING THE AC ADAPTER

The module uses the supplied 9V, 200-mA AC adapter for power.

### Cautions:



You must use a Class 2 power source that supplies 9V DC and delivers at least 200 mA. Its plug must fit the module's **9V DC 200mA** jack. The supplied adapter meets these specifications. Using an adapter that does not meet these specifications could damage the module or the adapter.

- Always connect the AC adapter to the module before you connect it to AC power. When you finish, disconnect the adapter from AC power before you disconnect it from the module.
- The supplied adapter was designed specifically for your module. Use only the supplied adapter.

To power the module, plug the adapter's barrel plug into **9V DC 200mA** on the back of the module. Then connect the other end of the adapter to a standard AC outlet.

## CONNECTING THE MODULE

Your module connects to any modular phone jack and your phone. You can also connect it to an answering machine.

**Note:** The module might not work with older phones, such as Western Electric phones.

### Connecting to a Single-Line Phone

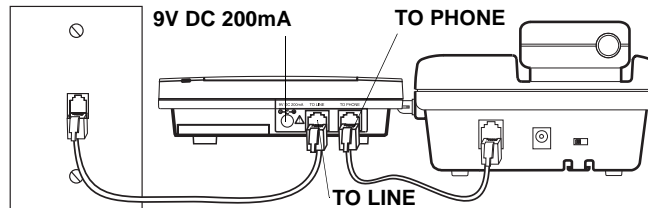

1. Disconnect the telephone line cord from the phone and plug it into the module's **TO LINE** jack.
2. Plug one end of the supplied line cord into the module's **TO PHONE** jack.
3. Plug the other end of the cord into the phone's jack.

### Connecting to a Two-Line Phone

To record information about calls received on a two-line phone, you can connect two CID-947 modules using a triplex adapter. Each module only records information about calls received on the line to which it is connected.

Follow these steps to connect two CID-947 modules to a two-line phone.

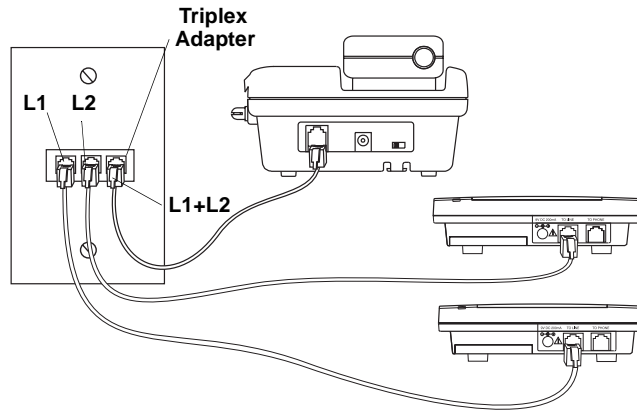

1. Disconnect the telephone line cord from the modular phone jack (on the wall) and plug it into L1+L2 on the triplex adapter.
2. Plug the triplex adapter into the modular phone jack.
3. Plug one end of the supplied line cord into the **TO LINE** jack on one of the modules.
4. Plug the other end of the cord into either L1 or L2 on the triplex adapter.
5. Repeat Steps 3 and 4 to connect another module to the remaining open jack (L1 or L2) on the triplex adapter.

## Connecting to an Answering Machine

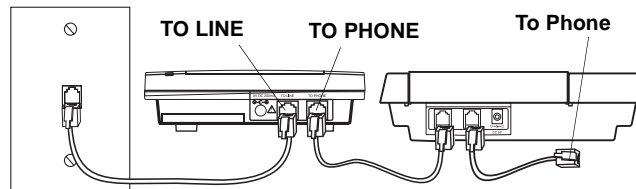

1. Disconnect the phone line cord that connects your answering machine to the phone line from the answering machine's jack. Then plug it into the module's **TO LINE** jack.
2. Plug one end of the supplied line cord into the module's **TO PHONE** jack.
3. Plug the cord's other end into the answering machine's jack.
4. Set your answering machine to answer after two or more rings. This gives the module time to record the call information that the phone company sends between the first and second rings.

## MOUNTING THE MODULE

You can place the module directly on a desk, shelf, or table by itself or using the stand on the supplied mounting bracket. Or, you can use the bracket to mount the module on a wall.

## Attaching the Mounting Bracket

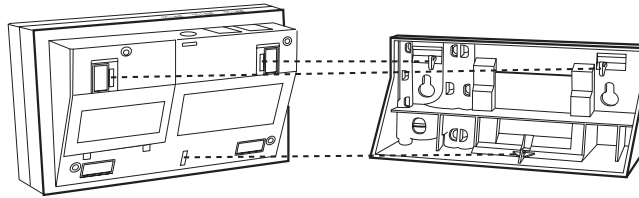

1. Align the slots on the bottom of the module with the hooks on the mounting bracket.
2. Gently push the module down on the bracket to secure it.

If you are placing the module on a desk, shelf, or table, pull out the stand on the back of the bracket until it clicks.

To remove the module from the bracket, press up from the bottom of the module until it snaps off the bracket.

## Mounting on a Wall

To mount the module on the wall, you need two screws (not supplied) with heads larger than the keyhole slots on the back of the mounting bracket.

1. Using the keyhole slots in the supplied mounting bracket as a template, mark the mounting screw locations on the wall.
2. Drill a hole in the wall at each marked location.
3. Thread a screw through each hole, letting the head extend  $\frac{1}{8}$ -inch (3.5-mm) from the wall.

4. Attach the mounting bracket to the module (see "Attaching the Mounting Bracket" on Page 14).
5. Route the phone line cords and AC adapter cord through the slots on the back of the bracket.

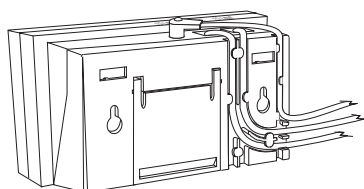

6. Align the keyhole slots on the bracket with the screws in the wall, then slide the module down onto the screws until it is secure.

## ADJUSTING THE DISPLAY CONTRAST

To lighten or darken the display, hold down **ERASE** and **REVIEW** ◀ until **CONTRAST ADJUST** appears. Repeatedly press **REVIEW** ▶ to increase the contrast.

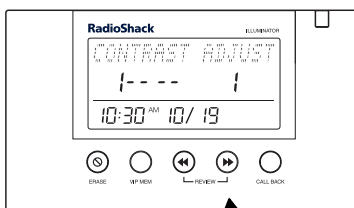



## CHOOSING A LANGUAGE

Your module is programmed to display messages in English, but you can change it to display in French or Spanish.

1. Hold down **REVIEW** ◀◀ and **CALL BACK** for about 3 seconds until the current language (**ENGLISH**, **ESPAÑOL** for Spanish, or **FRANCAIS** for French) appears.
2. Repeatedly press **REVIEW** ▶▶ until the language you want appears, then press **REVIEW** ◀◀ to set the language you selected.

**Note:** If you do not press any button within about 10 seconds, the time (if set) appears.



## SETTING YOUR LOCAL AREA CODE

1. Hold down **REVIEW** ◀◀ and **REVIEW** ▶▶ together until **LOCAL AREA CODE** appears.
2. To change the area code's first digit, repeatedly press **REVIEW** ▶▶ until the desired digit appears, then press **ERASE** to confirm.
3. Repeat Step 2 to set the area code's second and third digit.
4. To set the area code, do not press any button. Or, press **REVIEW** ◀◀ to set the module to its idle mode.

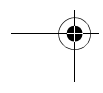
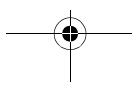
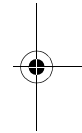



## **Operation**

### **RECEIVING AND STORING CALLS**

Caller ID is a service provided by your telephone company. When you subscribe to this service, the telephone company sends the caller's telephone number (and name, if available) and the call's date and time between the first and second rings. The module receives and displays this information for each call and updates the display with the current date and time. Your module saves up to 79 call records, then replaces the oldest call record with each new one.

During an incoming call, the new call indicator on the right side of the module flashes, the display lights, and **NEW** and the total number of calls appear. During an incoming VIP call, the new call indicator flashes continuously.



### **REVIEWING CALL RECORDS**

Each time you receive a call, the module saves a call record in memory that you can see while you are on the phone or review later.

Each call record includes the time and date of the call, the call number (the order in which the call is received), the caller's telephone number, and the caller's name (if available).

To scroll through the call records, repeatedly press (or hold down) **REVIEW**  or **REVIEW**  .

#### **Notes:**

- If no call information is stored, **NO CALL** appears when you press **REVIEW**  or **REVIEW**  .

- If you do not press a button within about 10 seconds, the module automatically returns to the time and date display.
- After you review all calls, **END OF LIST** appears. Simply press **REVIEW ◀◀** or **REVIEW ▶▶** to view again.

### Displayed Call Information

The module can display the following information.

Display (English, French, Spanish)	Description
<b>REPT</b>	Appears with a number if you have received a call from the same phone number more than once (between 2 and 9 times).
<b>LONG DISTANCE</b> <b>LONGUE DISTANCE</b> <b>LARGA DISTANCIA</b>	Appears along with <b>LDC</b> (long distance call) if your phone company sends information indicating that the incoming call is long distance.
<b>-UNKNOWN NAME-</b> <b>-NOM INCONNU-</b> <b>NOM DESCONOCIDO</b>	The incoming call is from an area that does not send Caller ID name information.
<b>UNKNOWN NUMBER</b> <b>NUMERO INCONNU</b> <b>NUM DESCONOCIDO</b>	The incoming call is from an area that does not send Caller ID number information.
<b>UNKNOWN CALLER</b> <b>APPELER INCONNU</b> <b>DESCONOCIDO</b>	The incoming call is from an area that does not send any Caller ID information.

<b>Display (English, French, Spanish)</b>	<b>Description</b>
<b>CALL 1</b>	Appears when you received a call for the first time.
<b>-BLOCKED NAME- -NOM BLOQUE- NOMBRE PRIVADO</b>	The caller has blocked the Caller ID name information from being sent.
<b>BLOCKED NUMBER -NUMERO BLOQUE- NUMERO PRIVADO</b>	The caller has blocked the Caller ID number information from being sent.
<b>BLOCKED CALL APPEL BLOQUE LLAMADA PRIVADA</b>	The caller has blocked any Caller ID information from being sent.
<b>-SERVICE ERROR- ERREUR DE LIGNE ERROR EN LINEA</b>	Call information was distorted before reaching the module. Normal static on the telephone can cause this message. If it happens often, contact your phone company.
<b>BATT</b>	Appears when battery level is low.
<b>-NO CALL- -PAS D APPEL- -NO LLAMADA-</b>	No call information is stored in the module.
<b>NEW NOUV NUEVO</b>	The module has received incoming calls that have not been reviewed.
<b>#NEW</b>	The total number of received calls which have not been reviewed.

<b>Display (English, French, Spanish)</b>	<b>Description</b>
<b>TOTAL TOT. TOTAL</b>	The total number of incoming calls (not including VIP calls).
<b>-RECORD STORED- -MEMORISE- -MEMORIZADO-</b>	The caller ID record is stored in VIP memory.
<b>VIP</b>	VIP memory is active.
<b>-VIP MEMO FULL- -VIP PLEIN- -VIP LLENO-</b>	Appears when the VIP number memory is full.
<b>DELETE ALL? EFFACER TOUT? BORRAR TODO?</b>	Delete all Caller ID records from memory except VIP records.
<b>-NO DATA SENT- PAS DE DONNEES -NO ENVIADO-</b>	Call information was not sent by the phone company.
<b>M or MESSAGE WAITING M or MESSAGE M or MENSAJE</b>	Appears when you have message waiting.
<b>-END OF LIST- -FIN DE LISTE- -FIN DE LISTA-</b>	End of the list of stored Caller ID records.

Display (English, French, Spanish)	Description
DIALING COMPOSER MARCAR	The module is dialing a stored Caller ID record.
LOCAL AREA CODE INDICATIF PREFIXO	Appears when you set the area code.

## REDIALING FROM CALL RECORD MEMORY

You can redial a telephone number stored in the Caller ID's memory.

1. Press **REVIEW** ◀ or **REVIEW** ▶ to view the desired call record.
2. Lift your phone's handset and check for a dial tone.
3. Press **CALL BACK** to redial the telephone number. If the number to be redialed is out of your area code, dial 1 on your phone before pressing **CALL BACK**.

## DELETING CALLS

### Deleting a Single Call

1. Repeatedly press (or hold down) **REVIEW** ◀ or **REVIEW** ▶ until you see the call record you want to delete.
2. Press **ERASE**. The module deletes that record and automatically renumbers the remaining call records. After 10 seconds, the time and date reappear.

## Deleting All Calls

1. While the module displays the time and date, press **REVIEW** ◀◀ or **REVIEW** ▶▶ .
2. Hold down **ERASE** until **DELETE ALL?** appears.

While **DELETE ALL?** appears, press **ERASE** again. **NO CALL** appears. Or, to cancel the deletion, do not press any button. After about 5 seconds, **DELETE ALL?** disappears.

## VIP CALL LIST

Your system lets you save up to 20 call records in its VIP call list so they will not be deleted if you delete all calls from the system's memory. This lets you save a list of important callers.

Follow these steps to store call records in the VIP call list.

1. Repeatedly press **REVIEW** ◀◀ or **REVIEW** ▶▶ until you see the call record you want to store as a VIP call.
2. Hold down **VIP MEM** until **VIP** flashes and **RECORD STORED** appears. The system stores the call record as a VIP call record.

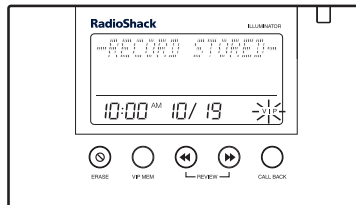

**Notes:**

- If the system's memory is full (20 VIP call records are already stored), **VIP MEMO FULL** appears when you press **VIP MEM**. To store another VIP call record, you must first delete an existing one.
- If you save a call record as a VIP call record, the total number of call records decreases by 1.

To review VIP call records, press **VIP MEM**, then repeatedly press **REVIEW ◀** or **REVIEW ▶** .

To delete a VIP call record, press **VIP MEM**, select the call record you want to delete, then press **ERASE**.

To delete all entries from the VIP call list, press **VIP MEM**, then hold down **ERASE**. **DELETE ALL?** appears. Press **ERASE** again to confirm. Or, to cancel deletion, do not press any button. After about 5 seconds, **DELETE ALL?** disappears.

## **Troubleshooting**

If your system is not working as it should, these suggestions might help you eliminate the problem.

<b>Problem</b>	<b>Solution</b>
Blank screen	The module is not receiving power. Make sure the batteries are installed and the AC adapter is plugged in.
	Adjust the contrast as described in "Adjusting the Display Contrast" on Page 15.
You have an incoming call, but do not receive any Caller ID information.	You answered the call before the module received the call information. Wait until your phone rings at least 2 times before answering a call.
No dial tone on the phone attached to the module.	Check all wires and cables to make sure that all connections are secure.
	Check your phone line by disconnecting the module then reconnecting the phone and checking for a dial tone.

If you see a message that you do not understand, see "Displayed Call Information" on Page 18.



## **Care and Maintenance**

Your RadioShack 79-Memory Caller ID Module with Backlight is an example of superior design and craftsmanship. The following suggestions will help you care for your module so you can enjoy it for years.



Keep the module dry. If it gets wet, wipe it dry immediately. Liquids might contain minerals that can corrode the electronic circuits.



Use and store the module only in normal temperature environments. Temperature extremes can shorten the life of electronic devices, damage batteries, and distort or melt plastic parts.



Keep the module away from dust and dirt, which can cause premature wear of parts.



Handle the module gently and carefully. Dropping it can damage circuit boards and cases and can cause the module to work improperly.



Use only fresh batteries of the required size and recommended type. Batteries can leak chemicals that damage your module's electronic parts.



Wipe the module with a damp cloth occasionally to keep it looking new. Do not use harsh chemicals, cleaning solvents, or strong detergents to clean the module.

Modifying or tampering with the module's internal components can cause a malfunction and might invalidate its warranty and void your FCC authorization to operate it. If your module is not performing as it should, take it to your local RadioShack store for assistance. If the trouble is affecting the telephone lines, the phone company can ask you to disconnect your module until you have resolved the problem.

### **THE FCC WANTS YOU TO KNOW**

In the unlikely event that your module causes problems on the phone line, the phone company can temporarily discontinue your service. If this happens, the phone company attempts to notify you in advance. If advance notice is not practical, the phone company notifies you as soon as possible and advises you of your right to file a complaint with the FCC.

Also, the phone company can make changes to its lines, equipment, operations, or procedures that could affect the operation of this module. The telephone company notifies you of these changes in advance, so you can take the necessary steps to prevent interruption of your telephone service.

### **LIGHTNING**

Your module has built-in protection circuits to reduce the risk of damage from surges in telephone line and power line current. These protection circuits meet or exceed the FCC requirements. However, lightning striking the telephone or power lines can damage your module.

Lightning damage is not common. Nevertheless, if you live in an area that has severe electrical storms, we suggest that you unplug your module when storms approach to reduce the possibility of damage.



 **Notes**

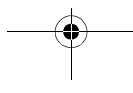
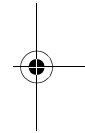

### Limited One-Year Warranty

This product is warranted by RadioShack against manufacturing defects in material and workmanship under normal use for one (1) year from the date of purchase from RadioShack company-owned stores and authorized RadioShack franchisees and dealers. EXCEPT AS PROVIDED HEREIN, RadioShack MAKES NO EXPRESS WARRANTIES AND ANY IMPLIED WARRANTIES, INCLUDING THOSE OF MERCHANTABILITY AND FITNESS FOR A PARTICULAR PURPOSE, ARE LIMITED IN DURATION TO THE DURATION OF THE WRITTEN LIMITED WARRANTIES CONTAINED HEREIN. EXCEPT AS PROVIDED HEREIN, RadioShack SHALL HAVE NO LIABILITY OR RESPONSIBILITY TO CUSTOMER OR ANY OTHER PERSON OR ENTITY WITH RESPECT TO ANY LIABILITY, LOSS OR DAMAGE CAUSED DIRECTLY OR INDIRECTLY BY USE OR PERFORMANCE OF THE PRODUCT OR ARISING OUT OF ANY BREACH OF THIS WARRANTY, INCLUDING, BUT NOT LIMITED TO, ANY DAMAGES RESULTING FROM INCONVENIENCE, LOSS OF TIME, DATA, PROPERTY, REVENUE, OR PROFIT OR ANY INDIRECT, SPECIAL, INCIDENTAL, OR CONSEQUENTIAL DAMAGES, EVEN IF RadioShack HAS BEEN ADVISED OF THE POSSIBILITY OF SUCH DAMAGES. Some states do not allow limitations on how long an implied warranty lasts or the exclusion or limitation of incidental or consequential damages, so the above limitations or exclusions may not apply to you.

In the event of a product defect during the warranty period, take the product and the RadioShack sales receipt as proof of purchase date to any RadioShack store. RadioShack will, at its option, unless otherwise provided by law: (a) correct the defect by product repair without charge for parts and labor; (b) replace the product with one of the same or similar design; or (c) refund the purchase price. All replaced parts and products, and products on which a refund is made, become the property of RadioShack. New or reconditioned parts and products may be used in the performance of warranty service. Repaired or replaced parts and products are warranted for the remainder of the original warranty period. You will be charged for repair or replacement of the product made after the expiration of the warranty period.

This warranty does not cover: (a) damage or failure caused by or attributable to acts of God, abuse, accident, misuse, improper or abnormal usage, failure to follow instructions, improper installation or maintenance, alteration, lightning or other incidence of excess voltage or current; (b) any repairs other than those provided by a RadioShack Authorized Service Facility; (c) consumables such as fuses or batteries; (d) cosmetic damage; (e) transportation, shipping or insurance costs; or (f) costs of product removal, installation, set-up service adjustment or reinstallation. This warranty gives you specific legal rights, and you may also have other rights which vary from state to state.

RadioShack Customer Relations, 200 Taylor Street, 6th Floor,  
Fort Worth, TX 76102

*We Service What We Sell*

12/99

RadioShack — A Division of  
Tandy Corporation  
Fort Worth, Texas 76102

43-947  
04A00  
Printed in China

## Free Manuals Download Website

<http://myh66.com>

<http://usermanuals.us>

<http://www.somanuals.com>

<http://www.4manuals.cc>

<http://www.manual-lib.com>

<http://www.404manual.com>

<http://www.luxmanual.com>

<http://aubethermostatmanual.com>

Golf course search by state

<http://golfingnear.com>

Email search by domain

<http://emailbydomain.com>

Auto manuals search

<http://auto.somanuals.com>

TV manuals search

<http://tv.somanuals.com>