



Owner's Manual

Cat. No. 17-1111

CT-502 Flip-Style Handheld Cellular Telephone with Silent Vibrating Alert

Please read before using this equipment.



RadioShack®

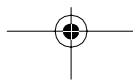
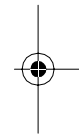
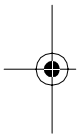

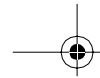

FEATURES



Your RadioShack CT-502 Flip-Style Handheld Cellular Telephone with Silent Vibrating Alert is a state-of-the-art personal cellular telephone. It has all of these features:

Special Messaging Service Features — the phone is pre-programmed to work with special (subscription-only) messaging services offered by many cellular carriers, including calling line ID, voice mail notification, and short (alphanumeric) messages.

Vibration and Silent Alert Modes — let you set the phone to vibrate gently (instead of ring) when it receives a call, or make no sound or movement at all, to avoid disturbing others.

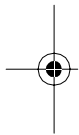

Nine Different Ringer Styles — let you set the phone's ringer to help you distinguish your phone's ring from that of another phone.

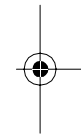

Easy-to-Read Seven-Character Display — bright red LED characters let you see essential call information in almost any lighting condition.

Call Timers — let you keep track of the individual and cumulative call time (air-time), and includes a timer that you can reset as you wish (so you can track monthly airtime, for example).

Speed/Memory Dialing — lets you store up to 50 phone numbers (of up to 32 digits each) and names (of up to 14 characters each) in memory and dial any of them by pressing one or two buttons.

Memory Scrolling — lets you rapidly search the memory locations for a number you stored.



© 1997 Tandy Corporation.
All Rights Reserved.

RadioShack is a registered trademark used by Tandy Corporation.

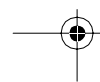
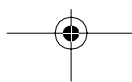

Last Number Redial — lets you quickly review and redial any of the last 10 numbers that you called.

Scratchpad Memory — lets you temporarily store a number (even during a call), then easily dial it.

Security Features — to prevent unauthorized phone use, you can lock the phone (so it cannot be used at all) or set up to five different levels of service restrictions (so only local calls can be made, for example).

Multiple Key Answer — lets you set the phone so pressing one of several keys answers a call.

Ample Talk and Standby Time — the supplied battery provides about 85 minutes of talk time or 24 hours of standby time, when fully charged.

Battery and Cellular Signal Strength Meters — easy-to-read graduated bar graphs let you quickly check the battery power remaining or the current cellular signal strength.

Automatic Answer — lets you set the phone to answer automatically after two rings (if you are using optional handsfree equipment, for example).

Two Phone Number Capability — lets you use this one phone with two different cellular services, with a different phone number from each.

Handsfree Feature — the phone is preprogrammed to work with most optional handsfree equipment.

We recommend you record your phone's Electronic Serial Number (ESN) here. The number is on the back of the handset under the battery.

TABLE OF CONTENTS

A Look at Your Phone	6
Reading the Status Indicators	7
Reading the Display	8
Using the Battery	9
Installing the Battery	9
Charging the Battery	10
Checking Battery Power	11
Replacing a Battery During a Call	12
Important Battery Tips	13
Basic Operation	14
Turning the Phone On/Off	14
Signal Strength/Service Area	14
Making a Call	15
Answering a Call	16
Adjusting the Volume	18
Making Emergency Calls	19
Redialing Numbers	20
Displaying Numbers	21
Menu Functions	22
Overview	22
Using the Menu Functions	26
Using Memory	36
Storing Speed Dial Numbers	36
One-Touch Dialing	39
Speed Recall/Dialing	39
Memory Scrolling/Dialing	40
Changing Information in a Memory Location	42
Clearing a Memory	43
Using Scratchpad Memory	44
Memory Dialing Tips	44
Security Features	45
Locking Your Phone	45
Using Service Restrictions	48



Other Features	50
Using the Messaging Functions	50
Using the Phone with Handsfree Equipment	52
Using the Call Timers	53
Selecting the Active Phone Number	55
Setting the Cellular System Type	56
Roaming	59
Using Cellular System PIN Dialing	59
Using Touch-Tone Services	61
Calling Card Dialing	62
Resetting the Phone	64
Using Master Reset	64
Using Master Clear	65
Troubleshooting	66
Safety Information	67
Traffic Safety	67
Operating Environment	67
Emergency Calls	68
FCC Regulations	69
Care and Maintenance	70
Specifications	71
Patent Information	71
Display Message Glossary	73

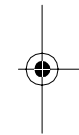
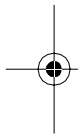

A LOOK AT YOUR PHONE



1. **Retractable Antenna**
Extend during a call for optimum performance.
2. **Earpiece**
3. **Status Indicators**
(See "Reading the Status Indicators" on Page 7.)
4. **Alphanumeric Display (Seven-Character LED)**
Displays the phone number, name, memory location number, or message.
5. **Alphanumeric Keypad**
Enters call information or programs functions.

6. Function Keys

- RCL** — Recalls numbers stored in memory.
- CLR** — Removes characters or clears functions.
- END** — Ends a call or exits the functions menu.
- SND** — Places or answers calls.
- NAME MENU** — Accesses the memory or functions menu.
- FCN** — Selects functions.
- STO** — Stores to memory; turns on functions.
- PWR** — Turns the phone on and off.

7. Flip Cover

8. Volume Controls

Press to increase or decrease the ringer or earpiece (during a call) volume levels.

READING THE STATUS INDICATORS

Power/Lock Indicator

- *Flashes slowly* when the phone is on and in service.
- *Lights steadily* when the phone is locked.

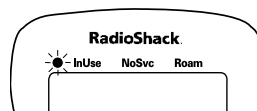

InUse Indicator

Flashes when a call is in progress.

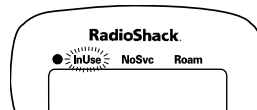

NoSvc (No Service) Indicator

Flashes or lights steadily if the phone is beyond the range of the cellular service area, meaning calls cannot be made or received. See "Signal Strength/Service Area" on Page 14.

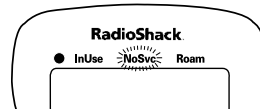

Roam Indicator

Flashes or lights steadily if the phone is accessing a service area outside of your home system (roaming). See "Roaming" on Page 59.



READING THE DISPLAY

Your phone's display provides a full range of messages and indicators to assist you with the phone's operation. Since many of these messages contain more characters than your phone can display at one time, the phone displays most messages across more than one display. For example, the phone displays **signal** then (within about 1 second) **Mtr On** to indicate that the signal meter display feature is turned on.

Note: When referring to a displayed message, this manual includes the entire message (such as **Signal Mtr On**).

For a complete listing of display messages and indicators, see "Display Message Glossary" on Page 73.

USING THE BATTERY

Warning: A detached battery could cause property damage, injury, or burns if a metal object (such as a pen spring, beaded chain, or piece of jewelry) contacts the battery's terminals and causes a short circuit. Be careful when placing a charged battery inside a coat pocket, purse, or other container that might contain metal objects.

Caution: Nickel metal-hydride (NiMH) batteries must be recycled or disposed of properly. They must not be disposed of in municipal waste.

INSTALLING THE BATTERY

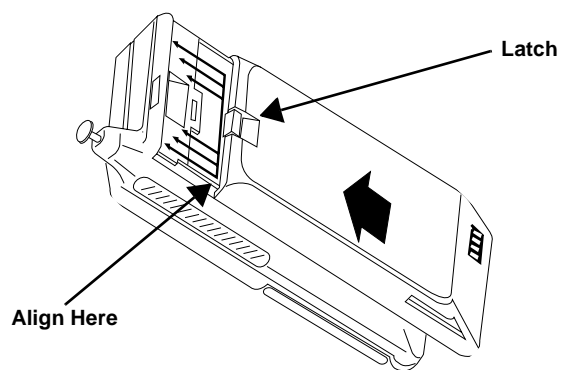

1. Place the battery flat against the back of the phone and align the top of the battery below the raised arrows.
2. Slide the battery toward the top of the phone until it snaps into place.



To remove the battery, be sure the phone is turned off, then press the latch at the top of the battery and slide the battery toward the bottom of the phone until it stops. Then lift the battery off the phone.

Note: If you have an extra charged battery and the currently installed battery becomes low during a call, you can change the battery without ending the call or losing the connection. See "Replacing a Battery During a Call" on Page 12.

CHARGING THE BATTERY

The nickel metal-hydride (NiMH) battery supplied with your telephone is shipped in a discharged state to extend the battery's life. It must be fully charged before you can use your phone.

We recommend that you charge a new battery overnight, but no longer than 24 hours, using the AC charger supplied with your phone. Recharging time for the supplied battery is about 3 hours, although the time varies based on the amount of charge left in the battery. For the recharging time of any other battery type, see the instructions provided with that battery.

Follow these steps to charge the supplied (or any approved) battery using the charger supplied with your phone.

1. Install the battery on the phone.
2. Insert the charger's flat plug into the charging jack on the bottom of the phone.

Note: The plug fits into the jack only one way. If you have difficulty inserting the plug, turn it over and try again. Do not force it!

3. Plug the charger's power cord into a standard AC outlet.

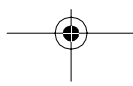

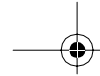

Notes:

- You can use the phone while it is charging, but charging takes longer.
 - For the fastest charging, be sure the phone is turned off during charging, if you are not expecting a call.
 - If the phone is on when you connect the charger, the phone beeps once and the keypad backlight remains on until you disconnect the charger.
4. When the battery is fully charged, disconnect the charger from the AC outlet. Then press in the clips on the sides of the plug and pull it away from the phone to disconnect the charger.

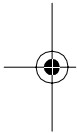

CHECKING BATTERY POWER

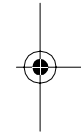

When battery power becomes low, the phone displays **Low Bat** and sounds a warning tone every few seconds. When power becomes too low for the phone to operate, it automatically turns off. Recharge the battery as soon as possible.

To check the battery's charge level at any time, press **(FCN)** **(GHI 4)**. The battery strength meter appears on the display for about 5 seconds. The more bars that appear on the meter, the higher the battery's current charge level. If few or no bars appear, the battery's power is low.

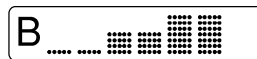
**Notes:**

- If you press **(FCN)** **(GHI 4)** while the phone is charging, the phone flashes **Charging Battery** for about 5 seconds instead of the battery strength meter.

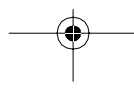



Note: Rechargeable batteries last longer and perform better if occasionally allowed to fully discharge. You can do this by leaving the phone on until it automatically turns off or you can use the battery discharge feature of any approved accessory available for your phone. Do not try to discharge the battery by any other means.

REPLACING A BATTERY DURING A CALL

If you have an extra charged battery and the currently installed battery becomes low during a call, follow these steps to change the battery without ending the call or losing the connection.

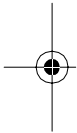

1. Tell the other party on the line what you plan to do (tell them, for example, that they will hear some noise as you remove the battery and you will call back if for any reason you lose the connection).
2. Remove the battery, and within 3 seconds, install the fresh battery. Your call is still on the line.

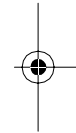

Note: If you do not complete Step 2 within 3 seconds, the call disconnects.

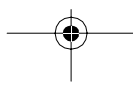



IMPORTANT BATTERY TIPS

- Use only the supplied charger and use only batteries designed for this phone.
- You can purchase additional standard or extended capacity batteries through your local RadioShack store.
- When you are not using the charger, disconnect it from power. Do not leave the battery connected to the charger for more than 24 hours, since overcharging could shorten the battery's life.
- When the battery is not in use, store it uncharged in a cool and dark place.
- The battery is a sealed unit with no serviceable parts. Do not try to open the case.
- For the best results, be sure the battery is at or near room temperature when you charge it.
- A battery can be charged and discharged hundreds of times, but it eventually wears out. When the operating time (talk time and standby time) is noticeably shorter than normal, get a new battery and recycle or properly dispose of the old one.
- Do not dispose of batteries in a fire.
- Never use any charger or battery that is damaged or worn out.

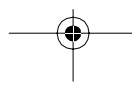
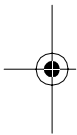

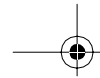

BASIC OPERATION



TURNING THE PHONE ON/OFF

To turn on the phone, flip down the cover then press **(PWR)**. The phone performs a short self test and sounds a tone or vibrates (see "Changing the Alert Type" on Page 29), then the signal strength meter appears (see "Signal Strength/Service Area") and the keypad backlight turns on for about 16 seconds. The phone is ready to use when the green power/lock indicator begins to flash.

Notes: The keypad backlight turns on for about 16 seconds every time you press a key, then it turns off and the display goes blank to conserve battery power.

To turn off the phone, press **(PWR)** again. The display goes blank and the green on/lock indicator turns off.

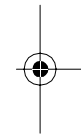
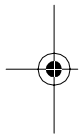

SIGNAL STRENGTH/SERVICE AREA

Each time you turn on the phone, clear the display, or make a call, the signal strength meter appears on the display to indicate the strength of the cellular signal currently being received. The more bars that appear on the meter, the stronger the signal.

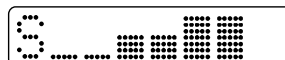

Notes:

- If few or no bars appear (meaning the signal strength is weak) and you want to make or receive a call, move the phone to a different location so the signal strength increases.

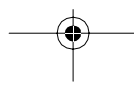

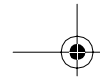

-
- You can disable the signal strength meter so it does not appear. See “Turning the Signal Strength Meter Off/On” on Page 26.

If the NoSvc indicator (above the display) turns on, the phone is outside the cellular service area and you cannot make or receive calls until you reach an area with service your phone can use.

MAKING A CALL

1. Extend the antenna, flip open the cover, and be sure the phone is on (the green power/lock indicator is flashing).
2. Press the number keys to enter the phone number you want to dial (including the area code, if necessary). The numbers appear on the display as you press them.

Notes:

- If you make a mistake, repeatedly press **(CLR)** to delete one digit at a time, or hold down **(CLR)** to delete all digits.
 - The phone can display up to 7 characters at once. If you enter (or display a message containing) more than 7 characters, the characters automatically scroll off the left side of the display. Press **(RCL)** at any time to recall the overflow characters. See “A Number Longer than Seven Digits” on Page 21.
3. Press **(SND)** to dial the phone number. The InUse indicator flashes and the phone briefly displays **Dialing** then the number called, then the signal strength meter.
 4. To end the call, press **(END)**.

Note: Closing the cover does *not* end or disconnect a call.

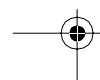

System Busy Message

In addition to the normal busy signal you hear when a number you call is busy, your phone sounds tones and displays a message to indicate other situations when it cannot complete a call.

Tone	Display Shows	Description
Fast Busy	SND to Redial	The cellular system is busy.
High/low	SND to Redial	The cellular system could not complete the call.

When either of these conditions occur, you can press **SND** again to redial the number immediately (see “Using Automatic Redial” on Page 20), or press **END** then dial the number again.

ANSWERING A CALL

When the phone receives an incoming call, it rings or vibrates (depending on the alert setting — see “Changing the Alert Type” on Page 29) and **Ca11** flashes on the display. To answer the call, press **SND**. To end the call, press **END**.

Notes:

- Your phone can receive calls even if the antenna is not extended. For optimum performance or if the signal strength becomes weak, however, extend the antenna.

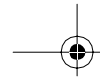

-
- To set your phone so you can answer a call by pressing keys other than just **END**, see “Using Multiple Key Answer” on Page 32.
 - If you subscribe to calling line ID service through your cellular carrier, you can view the calling party’s phone number on the phone’s display. See “Viewing/Recalling Messages” on Page 51.
 - If your phone receives a call but the signal strength is too weak to support it, **Call** appears as usual, but you hear the phone sound a series of beeps (rather than ringing or vibrating). The caller hears the standard “not in service” message. If this happens, press **(CLR)** to clear **Call** from the display.

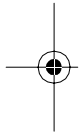

Missed Call Message

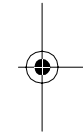

If your phone is on and receives a call, but you do not answer it, **Call** appears on the display for about 15 seconds after the calling party hangs up. The next time you press any key (except **(CLR)**, **END**, or **(FWR)**), **Call** reappears for about 15 seconds to notify you that you missed a call.

To clear **Call** from the display, press **(CLR)** or **END**.

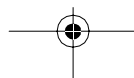



ADJUSTING THE VOLUME

Adjusting the Earpiece Volume

To increase or decrease the earpiece volume during a call, repeatedly press the top (increase) or bottom (decrease) volume button on the side of the phone. Each time you press the button, the volume meter appears on the display for about 8 seconds. The more bars that appear on the meter, the higher the earpiece volume.

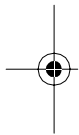
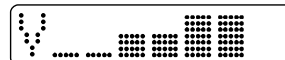

Adjusting the Ringer Volume

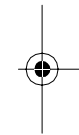

To increase or decrease the phone's ringer volume, when the phone is not in use, press **(FCN)** then repeatedly press the top (increase) or bottom (decrease) volume button on the side of the phone. Each time you press the button, the phone rings once and displays the volume meter for about 8 seconds. The more bars that appear on the meter, the higher the ringer volume sounds.

Using Mute

To turn off the phone's microphone during a call so the other party on the phone cannot hear you (so you can talk privately with someone else in the room, for example), press **(FCN)** **(MNC6)**. **Mute** appears.

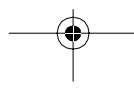

To turn the microphone on again, press **FCN** **MNC6** again so **Mute** disappears.

Hint: To help you remember which key to use, note that "M" (for mute) appears on the **MNC6** key.

Note: Pressing **END** to end a call also turns the microphone back on.

MAKING EMERGENCY CALLS

Your phone is preprogrammed to let you dial your local emergency number (such as 911) at the press of a single button, even if the phone is locked (see "Locking Your Phone" on Page 45). Before you can use this feature, however, you must first program the emergency number you want to use in memory location 01 of your phone. See "Storing Speed Dial Numbers" on Page 36.

To place an emergency call once you have stored the emergency number, simply hold down **1** for about 1 second. **Emergency** appears and the phone dials the emergency number.

Important Notes:

- If one-touch dialing is turned off (see "Turning One-Touch Dialing Off/On" on Page 32), you *cannot* make emergency calls using the **1** key.
- When you make an emergency call, give your name and cellular phone number, as well as the location of the incident. Remember that your phone might be the only means of communication at the accident scene. Do not end the call until you are advised you may do so.

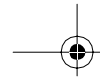

- **Emergency** does not appear if the emergency display function is turned off (see "Turning the Emergency Display Off/On" on Page 33).

REDIALING NUMBERS

Using Last Ten Number Redial

Your phone constantly stores the last 10 phone numbers you called. To recall and redial one of those 10 numbers, follow these steps.

1. Press **RCL** **OPER 0** **OPER 0**. **L0'** (location 0) and the most recent number called flash on the display.
2. To scroll through the last 10 numbers called (**L0'**, **L1'**, and so on), repeatedly press **# >** to scroll forward or **< *** to scroll backward.
3. To redial a displayed number, press **SND**.

To exit without redialing a number and clear the display, hold down **CLR** for about 1 second.

Using Automatic Redial

To automatically redial a number when you get the cellular system busy signal (when **Snd to Redial** appears), press **SND** so **Redial** appears. The phone automatically redials the number at regular intervals for up to 4 minutes or until the call goes through.

If the call goes through, the phone rings once (or vibrates, depending on the alert setting) to alert you. Simply begin your conversation as usual when the other party answers.

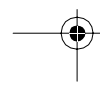
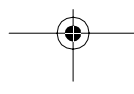
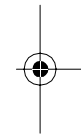
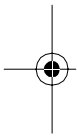

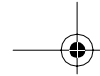

If the call cannot be completed within 4 minutes (and **Snd to Redial** appears again), you can press **SND** again to repeat the redial cycle or **END** to end the call.

DISPLAYING NUMBERS

Your Phone Number

To display your phone number at any time (even while a call is in progress), simply press **(RCL) (# ▶)**.

Notes:

- If you have two phone numbers programmed into your phone (see “Selecting the Active Phone Number” on Page 55), pressing **(RCL) (# ▶)** displays the currently active phone number.
- Unless you selected the silent scratchpad function (see “Using Silent Scratchpad” on Page 27), the other party on the line hears tones if you press these or any other keys on your phone during a call.

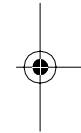
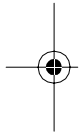

A Number Longer than Seven Digits

You can enter and dial phone numbers of up to 32 digits; however, the phone can display only 7 digits at once.

To review the overflow digits of a number 8–10 digits long, press **(RCL)** once. Or, if the number is longer than 10 digits, press **(RCL)** twice. The phone displays the overflow digits (first to last), up to 7 digits at a time.

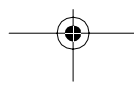

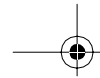

MENU FUNCTIONS



OVERVIEW

Turning a Function On/Off

Follow these steps to turn any of your phone's special functions on or off. For a complete description of any function, see the section that describes that function. The page numbers of each of the sections are listed in "Menu Functions List" on Page 24.

1. Press **FCN** **NAME MENU** to access the functions menu. The first function's name and its current status (**On** or **Off**) flash on the display.
2. To select a different function, repeatedly press **# >** to scroll forward or **< *** to scroll backward through the menu until that function appears.
3. Press **STO** to turn the function on or **CLR** to turn the function off.

Note: A few seconds after you display the function name and status, the phone alternately displays **STO-On** then **CLR-Off** as a prompt to remind you what key to press.

4. To select and turn another function on/off, repeat Steps 2 and 3.

To exit the functions menu, press **END**.

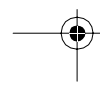
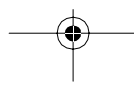
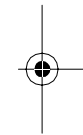
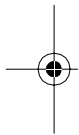



Function Status Quick-Review

Several commonly used functions on your phone (such as the message reminder tone and emergency dialing) are pre-set to “on” so you can begin using them immediately; however, you can turn any function on or off. Follow these steps to quickly review the names of those functions for which the pre-set (default) status has been changed.

Notes:

- You can set all functions back to their default setting at one time. See “Using Master Reset” on Page 64.
- If all functions are set to their default setting, only the current cellular system type setting (such as **Home** or **Scan AB**) appears.
- If your phone is set to use the home cellular system type (see “Setting the Cellular System Type” on Page 56), **Home** always appears as one of the settings during a quick-review.

1. Press **FCN** **OPER 0** **WXYZ9** **RCL**. The abbreviation for the first changed function (such as **Signal Mtr Off** for “signal meter off”) appears on the display.

Note: For a complete list of all functions and their default settings, see “Menu Functions List” on Page 24.

2. Repeatedly press **← *** or **# →** to scroll forward or backward through the abbreviations for all other changed functions (if any).
3. The phone automatically exits the quick-review about 8 seconds after you last press a key. To exit sooner, press **END**.

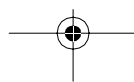
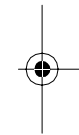
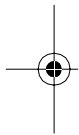

Menu Functions List

Display Shows	Function Description and Default Setting	See Page
Signal Mtr	Turns off/on the signal strength meter On	26
One Min Timr	Sets the phone to sound a tone once each minute during a call Off	26
Indiv Timr	Sets the call timer to display automatically during a call Off	53
Scrpad Tone	Turns off/on the keypad tones (heard by the other party) On	27
Ringer Style	Sets the phone to use one of nine different ringer styles 1	28
Ring Or Vib Sel	Sets the phone to vibrate or ring only, both vibrate and ring, or only display Call (instead of ring or vibrate) to alert you of a call Ring Only	29
Keypad Tone	Turns off/on the keypad tones (that you hear) On	30
Auto Ansr	Sets the phone to automatically answer after two rings Off	31
MultKey Ansr	Sets the phone to answer a call when you press one of several keys Off	32

Display Shows	Function Description and Default Setting	See Page
Auto Lock	Sets the phone to automatically lock when you turn power on	Off 46
Turbo Dial	Turns off/on one-touch dialing	On 32
Emergency Call	Turns off/on the emergency dialing display	On 33
Number Pref	Can be turned off so the phone displays the speed dial name (instead of the number) first	On 33
Call Rcv	Sets the phone to alert you of a call using a unique tone (compatible with optional call-forwarding service)	Off 34
Remind Msg	Sets the phone to alert you of messages received (with optional messaging services)	On 35
Select Languag	(Function not available on this phone)	N/A N/A
PIN InActiv or Activ	Sets the phone to automatically send a cellular system PIN with every call	Inactive 59

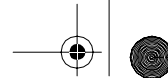

USING THE MENU FUNCTIONS

Turning the Signal Strength Meter Off/On

Your phone is preset to display the signal strength meter each time you turn on the phone, clear the display, or make a call; however, you can set the phone so it does not display the meter. Follow these steps to turn the signal strength meter off or on.

1. Press **FCN** **NAME MENU**. **Signal Mtr On** or **Off** flashes
2. Press **CLR** so **Off** appears or **STO** so **On** appears.
3. Press **END** to exit the functions menu. If you turned off the signal strength meter, **on** appears on the display instead of the signal strength meter.

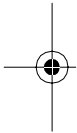

Turning the Call-Time Reminder Tone Off/On

The call-time reminder function lets you set the phone to sound a subtle tone 40 seconds after you place or answer a call, then once every minute after that, to remind you of how long you have been on the phone. Follow these steps to turn the call-time reminder tone off or on.

1. Press **FCN** **NAME MENU**.
2. Press **# >** once so **One Min Timr Off** or **On** flashes.
3. Press **STO** so **On** appears or **CLR** so **Off** appears.
4. Press **END** to exit the functions menu.

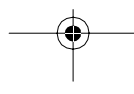

Turning the Automatic Call Timer On/Off

To track how long you are on the phone, you can set your phone to automatically display the time (minutes and seconds) you spend on each call. Follow these steps to turn the automatic call timer on or off.

Note: If you turn on the automatic call timer, the phone displays the timer at all times during a call. This uses more battery power than usual.

1. Press **FCN** **NAME MENU**.
2. Repeatedly press **← *** or **# →** until **Indiv Timr Off** or **On** flashes.
3. Press **STO** so **On** appears or **CLR** so **Off** appears.
4. Press **END** to exit the functions menu.

Note: Your phone also has a resettable call timer and a cumulative call timer. See "Using the Call Timers" on Page 53.

Using Silent Scratchpad

Your phone is preset to sound dual-tone multi-frequency (DTMF) tones when you press the number keys during a call; however, you can set the phone so it does not sound those tones. This is handy if you plan to use the scratchpad memory during a call, but you do not want the other party on the line to hear tones when you press the keys.

Follow these steps to turn the silent scratchpad on or off.

1. Press **FCN** **NAME MENU**.
2. Repeatedly press **← *** or **# →** until **Scrpad Tone On** or **Off** flashes.



3. Press **(CLR)** so **Off** appears or **(STO)** so **On** appears.
4. Press **(END)** to exit the functions menu.

Notes:

- In order to send DTMF tones when you use special phone services (such as bank by phone), you must disable the silent scratchpad function before you place the call, or (if silent scratchpad is on) press **(RCL)** **(SND)** after you enter the commands or codes, so your phone sends those entries as DTMF tones. See “Using Touch-Tone Services” on Page 61.
- If silent scratchpad is on, you might hear tones when you press the phone’s number keys, but the other party on the line does not hear them.

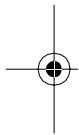

Changing the Ringer Style

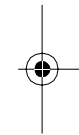

Your phone has 9 different ringer styles for you to choose from (to help you distinguish your phone’s ring from that of another phone, for example). Follow these steps to change the ringer style.

1. Press **(FCN)** **(NAME MENU)**.
2. Repeatedly press **(←*)** or **(#→)** until the phone displays **Ringer Style** and a number from **1–9** (the last selected ringer style).
3. Press **(STO)**. The phone sounds the currently selected ringer style, then it displays the prompt **Select 1–9**.

Note: If your phone is set to vibrate or make no sound/movement at all when it receives an incoming call (see “Changing the Alert Type” on Page 29), your phone does not sound the ringer tones during this procedure.

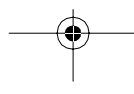

4. Press the number keys (**1**–**9**) on the phone's keypad to hear the various ringer styles (or repeatedly press ***** or **#** to scroll backward or forward and hear each of them).
5. When you hear the ringer style you want to use, press **0** to select it. The phone displays **Ringer n Set** (where **n** is the number of the ringer style you selected).
6. Press **END** to exit the functions menu.

Changing the Alert Type

Your phone is preset to ring when it receives an incoming call. To avoid disturbing others with a ringing sound, however, you can set your phone to vibrate gently or only flash **CALL** to alert you of an incoming call.

Here is a quick chart to help you understand how your phone works using the different incoming call alert settings.

Display Shows	Description
Ring Only	Phone rings as usual and Call flashes
Vibrate Only	Phone vibrates three times and Call flashes.
Ring On and Vib On	Phone vibrates three times then rings and Call flashes.
Ring Off and Vib Off	Silent alert — phone makes no sound or movement, but Call flashes.

Notes:

- If the battery is being charged, the phone *only* rings, regardless of the alert setting. That way, you can hear the phone ring (since you are not carrying/wearing it during charging).

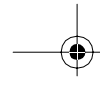

- If the call screening function is turned on, your phone sounds a different alert tone or number of vibrations. See "Using Call Screening" on Page 34.

Follow these steps to change the alert type.

1. Press **FCN** **NAME MENU**.
2. Repeatedly press **← *** or **# ▶** until **Ring Or Vib Sel** flashes, then press **STO** to enter the change mode. The current setting (such as **Ring Only**) appears.
3. Repeatedly press **← *** or **# ▶** until you see the setting you want to use, then press **STO** to select that setting.
4. Press **END** to exit the functions menu.

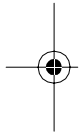

Using the Quick-Set Method — To quickly set your phone to ring or vibrate to alert you of an incoming call, press **FCN** **TUV 8**. The phone displays **Ring Only** (for ring as usual) or **Vibrate Only** (for vibration alert).

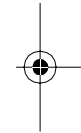

Note: Using the quick-set method to set your phone to ring (**Ring Only**) automatically disables the silent alert if it is set.

Turning the Keypad Tones Off/On

Your phone is preset to sound a tone each time you press a key; however, you can turn off the keypad tones. Follow these steps to turn the keypad tones off or on.

1. Press **FCN** **NAME MENU**.
2. Repeatedly press **← *** or **# ▶** until **Keypad Tone On** or **Off** flashes.

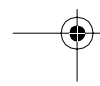
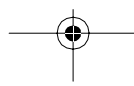

3. Press **CLR** so **Off** appears or **STO** so **On** appears.
4. Press **END** to exit the functions menu.

Note: Regardless of the silent keypad setting, unless you turn on the silent scratchpad function (see “Using Silent Scratchpad” on Page 27), the other party on the line hears tones if you press the keys during a call.

Using Automatic Answer

The automatic answer function lets you set the phone to automatically answer incoming calls without you having to press a key. When automatic answer is turned on and the phone receives a call, it rings (and/or vibrates), then it automatically answers the call and the InUse indicator begins to flash. Begin your conversation as usual.

Note: To prevent your phone from answering incoming calls without any easily noticeable indication (such as a ring or vibration), we recommend you not use the silent alert and automatic answer functions at the same time.

Follow these steps to turn the automatic answer function on or off.

1. Press **FCN** **NAME MENU**.
2. Repeatedly press **← *** or **# →** until **Auto Ansr Off** or **On** flashes.
3. Press **STO** so **On** appears or **CLR** so **Off** appears.
4. Press **END** to exit the functions menu.

Using Multiple Key Answer

Your phone is preset to answer an incoming call only when you press **END**; however, you can set the phone to answer a call when you press any of these keys after the first ring (or vibration): **END**, any number key (**1** – **9**), or either volume button.

Follow these steps to turn multiple key answer on or off.

1. Press **FCN** **NAME MENU**.
2. Repeatedly press **← *** or **# ►** until **MultiKey On** or **Off** flashes.
3. Press **STO** so **On** appears or **CLR** so **Off** appears.
4. Press **END** to exit the functions menu.

Turning One-Touch Dialing Off/On

Your phone is preset to automatically dial a number stored in memory locations 01–09 when you hold down that number key for about 1 second; however, you can disable one-touch dialing. Follow these steps to turn one-touch dialing off or on.

Important: Disabling one-touch dialing also prevents you from making emergency calls using the **1** key (see “Making Emergency Calls” on Page 19).

1. Press **FCN** **NAME MENU**.
2. Repeatedly press **← *** or **# ►** until **Turbo Dial On** or **Off** flashes.
3. Press **CLR** so **Off** appears or **STO** so **On** appears.
4. Press **END** to exit the functions menu.

Turning the Emergency Display Off/On

Your phone is preset to display **Emergency** when you hold down **1** to make an emergency call; however, you can set the phone so **Emergency** does not appear (if you did not store an emergency number in memory 01, for example).

Follow these steps to turn the emergency display feature off or on.

1. Press **FCN** **NAME MENU**.
2. Repeatedly press **< * >** or **# >** until **Emergency Call On** or **Off** flashes.
3. Press **CLR** so **Off** appears or **STO** so **On** appears.
4. Press **END** to exit the functions menu.

Turning the Number Display Preference Off/On

When you recall a speed dial memory (see “Speed Recall/Dialing” on Page 39), your phone is preset to display the number stored in memory before it displays the name (if any); however, you can set it to display the name first.

Follow these steps to turn the number preference off or on.

1. Press **FCN** **NAME MENU**.
2. Repeatedly press **< * >** or **# >** until **Number Pref On** or **Off** flashes.
3. Press **CLR** so **Off** appears or **STO** so **On** appears.
4. Press **END** to exit the functions menu.



Using Call Screening

The call screening function lets you set your phone so **Call** appears and the phone sounds several unique beeps (or vibrates) when it receives a call, but you cannot answer the call. The caller receives the standard “not in service” message that they would normally hear when you have the phone turned off. This function is handy if you want to use your phone only for outgoing calls.

Note: If your carrier offers no-answer transfer service (like call forwarding) and you subscribe to that service, turning on your phone’s call screening function so means **Call** appears and the phone sounds several unique beeps (or vibrates) when a call is received and is being transferred.

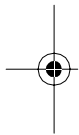

Follow these steps to turn call screening on or off.

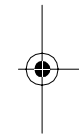

1. Press **FCN** **NAME MENU**.
2. Repeatedly press **← * →** or **# →** until **Call Rcv On** or **Off** flashes.
3. Press **CLR** so **Off** appears or **STO** so **On** appears.
4. Press **END** to exit the functions menu.

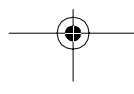

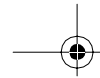

Turning the Message Reminder Tones Off/On

If your cellular carrier offers a special messaging service, and you subscribe to that service, your phone is preset to beep every 2 minutes until you read all new messages, but you can turn off the tones.

Note: If you do not subscribe to a messaging service, the reminder tone function has no effect on your phone.

Follow these steps to turn the message reminder tones off or on.

1. Press **FCN** **NAME MENU**.
2. Repeatedly press **← * →** or **# →** until **Remind Msg On** or **Off** flashes.
3. Press **CLR** so **Off** appears or **STO** so **On** appears.
4. To exit the functions menu, press **END**.

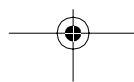
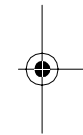
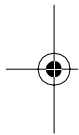



USING MEMORY



Your phone has 50 speed-dial memory locations that can each hold a phone number (up to 32 digits) and a name (up to 14 characters, including spaces).

STORING SPEED DIAL NUMBERS

Note: If you are unable to complete Steps 1 and 2 within 8 seconds, the display goes blank to conserve battery power. Press **END** to recall the display, then try the steps again.

1. Clear the display (if necessary), enter the phone number you want to store, then press **STO**. The phone displays **Locatn** (location) then _ _.
2. Within 8 seconds, enter the 2-digit memory location number (01–50) where you want to store the phone number, or press **← *** to automatically select the first unused memory location. **Alpha or STO** appears to prompt you for the next step.

Notes:

- Remember that your phone uses memory location 01 for one-touch emergency dialing. Store only your local emergency number (such as 911) in that location.
 - If you enter an invalid location number (such as 51), the phone displays **Invalid Locatn** followed by the location prompt. Enter a valid location number.
3. To enter the phone number *without* entering a name, skip to Step 4.

Or, for each letter of the speed-dial name you want to enter, repeatedly press the key (**ABC 2**), (**DEF 3**), and so on) that contains that letter, then press **# →** to move the cursor to the next position.

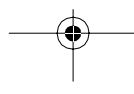
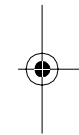
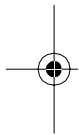

For example, to enter the letter Y, press **WXY9** three times (since the letter Y is third in the series of letters on that key).

Notes:

- To store a space, press **# >** twice (without entering a letter).
 - To enter the letter Q (even though it is not printed on the key), press **PRS 7** twice. The other letters (P, R, and S) appear in sequence before/after Q as they do in the alphabet.
 - If you make a mistake, repeatedly press **CLR** or **← ✕** to erase each incorrect character, then enter the correct character(s).
4. When you finish, press **STO** to store the information in memory. The selected memory location number appears on the display to confirm the entry.

Note: If you previously stored information in the selected memory location, or if the phone's memory is full, the selected memory location number and **Full** appear briefly, then the currently stored information and **Change?** flash on the display.

*To select a different memory location, press **END** then **STO**, enter the new memory location number (or press **← ✕** to automatically select the first unused location), then press **STO**.*

*To use the selected memory location and replace the information currently stored there, press **STO**.*

Storing Speed Dial Numbers in Blocks

To help you organize and easily recall information, you can store speed dial numbers in “blocks,” so numbers with similar characteristics (such as family, friends, services, and so on) are stored together.

The memory blocks in your phone are divided this way:

Block Number	Includes Memory Locations
0	01 – 09
1	10 – 19
2	20 – 29
3	30 – 39
4	40 – 49
5	50

To store a number in a memory block, follow Steps 1–4 in “Storing Speed Dial Numbers,” but in Step 2, enter the *block* number then press $\leftarrow \star$. The phone automatically selects the first unused memory location in the selected block.

Note: If the block you select is full, **Full** and the last memory location number in that block appear briefly, then the currently stored information and **Change?** flash on the display.

To select a different memory block, press **END** then **(STO)**, enter the new block number, then press $\leftarrow \star$.

To store the number in the last available memory location of the current block and replace the information currently stored there, press **(STO)**.

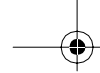

ONE-TOUCH DIALING

To quickly place a call to any number stored in memory locations 02–09 (without pressing **SND**), simply hold down that number key for about 1 second. The InUse indicator flashes and the phone briefly displays **Dialing** then the number called, then the signal strength meter.

SPEED RECALL/DIALING

If you know the memory number you want to use, simply enter that number (such as 06), then press **SND** to place the call.

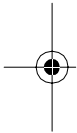

If you know the memory number you want to use, but you want to review the stored information (just to be sure!) before you place the call, press **RCL** then enter the memory location number. The memory number and phone number flash on the display. To place the call, press **SND**.

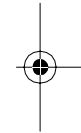

The InUse indicator flashes and the phone briefly displays **Dialing**, then the number called, then the signal strength meter.

Notes:

- To view the name stored in a memory location when the phone and memory numbers appear, press **RCL**. To view the numbers again, press **RCL**.
- You can set the phone so it displays the name (instead of the phone number) first when you select a specific memory location number. See “Turning the Number Display Preference Off/On” on Page 33.

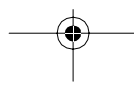

MEMORY SCROLLING/DIALING

Scrolling by Name (Alphabetical Order)

Your phone stores names in alphabetical order, based on the first few characters of the name. Follow these steps to scroll through memory by name.

1. Press **(NAME MENU)**. The phone displays the first name in memory.

Notes:

- If no names are stored in memory, **NoNames Stored** appears.
- If you press **(NAME MENU)** immediately after recalling/dialing another memory name/number, that memory name appears first.

2. To scroll forward through all names in memory, repeatedly press **(# >)**.

To start scrolling forward from a specific letter of the alphabet, enter the letter (press **(ABC 2)** three times to enter C, for example). The first name that starts with that letter appears.

Notes:

- When you reach the last name in memory (or any time after you first press **(# >)**), you can press **(← ✕)** to scroll backward through the names.
- If there are no names stored under the selected letter (C, for example), the phone displays **No C's** followed by the next name in memory.
- To view the memory number and phone number of a selected name, simply press **(RCL)**. To view the name again, press **(NAME MENU)**.

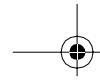

3. When you see the name you want to use, press **SND** to place the call.

Scrolling by Memory Location Number

1. Press **RCL**.
2. Press **OPER 0** **1** to start scrolling from the first memory location, or enter a specific memory number (such as 11) that you want to start from. The memory number followed by ' (to indicate scrolling is active) and the stored phone number flash on the display.

Note: If the memory number you selected is unused, the memory number (03', for example) appears steadily.

3. Repeatedly press **# >** or **< *** to scroll forward or backward through the numbers.

Notes: To view the name stored in the selected memory, simply press **RCL**. The phone number automatically reappears after a few seconds.

4. When you see the name or number you want to use, press **SND** to place the call.

Scrolling While a Call is in Progress

For convenience (so you can see if you have a caller's phone number, for example), your phone lets you scroll through memory while a call is in progress. Simply follow the steps to scroll by name or memory location number, but press **END** instead of **SND** when you finish.

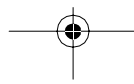
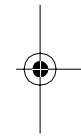
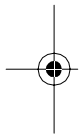

CHANGING INFORMATION IN A MEMORY LOCATION

1. Recall the memory location information.
2. Press **RCL** (if necessary) to display the phone number.
3. Repeatedly press **CLR** to backspace and erase digits, then enter the correct numbers; or, to simply add digits to the existing number, enter the additional numbers. Then press **STO** and enter the two-digit memory number. **Alpha or STO** appears to prompt you for the next step.

Note: If you enter an invalid location number (such as 51), the phone displays **Invalid Locatn** followed by the location prompt. Enter a valid location number.

Or, if you want to edit only the name, press **STO**, enter the two-digit memory location number, then skip to the next step.

4. Repeatedly press **CLR** or **← ✕** to erase each character you want to change, then enter the correct character(s). Or, to simply add characters to the existing name, enter the additional characters.

Or, if you do not want to edit the name, skip to the next step.

5. Press **STO**. The selected memory number and **Full** appear briefly, then the phone number and **Change?** flash. Press **STO** again to store the edited memory. The memory location number appears briefly to confirm the entry.

CLEARING A MEMORY

With a name *and* number — Follow these steps to clear a memory that has a name and phone number (or only a name) stored in it.

1. Press **(NAME)** to display the first name stored in memory, then repeatedly press **(# >)** until the name you want to clear appears.
2. Press **(CLR)**. **Clear?** appears.
3. To clear the selected memory, press **(STO)**. The selected memory location number appears, confirming the entry.
To exit without clearing the selected memory, press **(END)**.

Only a Number — Follow these steps to clear a memory that has only a phone number stored in it.

1. Press **(CLR)** **(STO)**, then enter the 2-digit memory location number you want to clear. **Alpha or STO** appears to prompt you for the next step.
2. Press **(STO)**. The memory location number, phone number, then **Full** briefly flash. Then the phone number and **Change?** flash.
3. To clear the selected memory, press **(STO)**. The selected memory location number appears, confirming the entry.
To exit without clearing the selected memory, press **(END)**.



USING SCRATCHPAD MEMORY

Your phone's scratchpad memory lets you temporarily store a telephone number on the display during a call. This is handy, for example, when someone gives you a number during a call and you don't have a place to write it down.

To store a number in the scratchpad memory during a call, simply press the keys to enter that number. After you press **END** to end the call, you can press **SND** to immediately dial the scratchpad memory number.

Note: Unless you previously selected the silent scratchpad feature (see "Using Silent Scratchpad" on Page 27), be sure to tell the other party on the call that they will hear tones as you press the keys to enter the number.

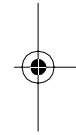
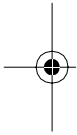

MEMORY DIALING TIPS

Frequently Dialed Area Codes/Prefixes

To reduce the number of keystrokes you use to dial frequently called area codes or prefixes, store that area code or prefix (including the 1, if necessary) in memory. To dial a number using that memory, simply recall that memory, enter the remaining digits of the telephone number you are calling, then press **SND** to place the call.

Banking or Other Phone Services

For convenience, you can store in your phone's memory the touch-tone command sequences you use when calling your bank or other phone services. See "Using Touch-Tone Services" on Page 61.

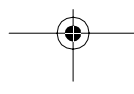

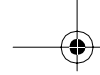

SECURITY FEATURES



LOCKING YOUR PHONE

To prevent unauthorized use of your phone, you can enter a 3-digit code to lock your phone at any time (see “Using Manual Lock”). For added convenience, you can also set the phone to automatically lock every time you turn it on (see “Using Automatic Lock” on Page 46).

When the phone is locked, **Locked** appears when you press any key (except **PWR**). When the phone is locked and receives a call, it rings or vibrates as usual. To answer the call, you must enter the lock code and then press **END**.

Your phone’s preset lock code is 123. For added security, you can change the code to one that you can easily remember. See “Changing the Lock Code” on Page 46.

Note: If you lock your phone then forget the *lock* code, you can enter a 6-digit *security* code to display the lock code. See “Displaying the Lock Code” on Page 47.

Using Manual Lock

Follow these steps to lock or unlock your phone at any time.

1. Press **FCN**, then hold down **JKL 5** until the phone displays **Lock?**.
2. To lock your phone, press **STO** within 8 seconds. **Locked** appears and the green power/lock indicator lights steadily.

To exit without locking the phone, press **END**.

Note: If you do not press **STO** within 8 seconds, your phone automatically exits the lock program without locking the phone.

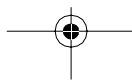

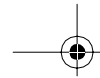

The phone remains locked until you unlock it. To unlock your phone, simply enter the 3-digit lock code so **Locked** disappears. If you make a mistake, press (CLR) then try again.

Using Automatic Lock

The automatic lock feature lets you set your phone to automatically lock each time you turn it on. When automatic lock is turned on, **Locked** appears after the self test when you turn on the phone. To use the phone, you must unlock it.

Follow these steps to turn automatic lock on or off.

1. Press (FCN) (NAME MENU).
2. Repeatedly press (←) (✖) or (#) (→) until **Auto Lock Off** or **On** flashes.
3. Press (STO) so **On** appears or (CLR) so **OFF** appears.
4. To exit the functions menu, press (END).

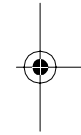
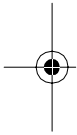

Changing the Lock Code

For added security, you can change the lock code, but you must enter a preset 6-digit security code first. **Your phone's preset security code is 000000** (you cannot change this code).

Follow these steps to change your phone's lock code.

Note: The phone's display does not change (no characters appear when you press the keys) until you press (STO) in Step 4.

1. Press (FCN) (OPER 0).

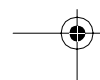

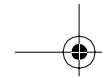

-
2. Enter the 6-digit security code.
 3. Enter the new 3-digit lock code you want to use.
 4. Press **(STO)**. The phone displays **Changed To** and the new lock code.
 5. Press **(CLR)** to clear the lock code message from the display.

Displaying the Lock Code

If you change your lock code then forget it, you can use your phone's preset security code (**000000**) to display the current lock code.

Follow these steps to display the current lock code.

Note: The phone's display does not change (no characters appear when you press the keys) until you press **(RCL)** in Step 3.

1. Press **(FCN)** **(OPER 0)**.
2. Enter the 6-digit security code.
3. Press **(RCL)**. The phone displays **LocCode** and the currently set 3-digit lock code.
4. Press **(CLR)** to clear the lock code message from the display.

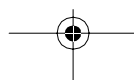
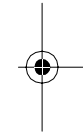
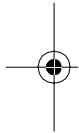

USING SERVICE RESTRICTIONS

Your phone is preset to let you (or anyone else) dial any type of number (local or long distance) and freely access any information stored in its memory. To prevent unauthorized use of your phone, however, you can enter your phone's preset security code (**000000**) and set any of these varying levels of service restrictions.

Service Level	Description
1	Calls can be placed only to numbers stored in memory locations 01–10 using speed dialing. Otherwise, the keypad is locked. The memory cannot be accessed or changed.
2	Calls can be placed only to numbers stored in memory. Otherwise, the keypad is locked. The memory cannot be changed.
3	Calls can be placed only by direct dialing using the keypad. The memory cannot be accessed or changed.
4	No restrictions (default setting).
5	7-digit (local) dialing only.
6	Calls can be placed to numbers stored in memory or using direct dialing on the keypad. The memory cannot be changed.

Note: Your phone is preset to service level 4.

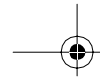

Follow these steps to change the service restriction level on your phone.

Note: The phone's display does not change (no characters appear when you press the keys) until you press **(STO)** in Step 4.

1. Press **(FCN)** **(OPER 0)**.
2. Enter the 6-digit security code.
3. Enter the service level (1–6) you want to use.
4. Press **(STO)**. The phone displays **Service Level** and the service level number you entered (such as **Service Level 5**).
5. Press **(CLR)** to clear the service level message from the display.

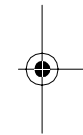
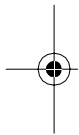

If you selected a service levels other than level 4, the phone sounds a “no service” fast busy signal when someone tries to use a restricted feature on the phone. To cancel that busy signal, press **(END)**.

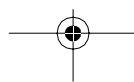

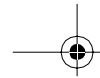

OTHER FEATURES



USING THE MESSAGING FUNCTIONS

Some cellular systems provide services that can send up to three different types of messages to your phone, including calling line ID, voice mail notification, and short (alphanumeric) messages. Your phone is preprogrammed to work with these services.

Note: In order to use these functions on your phone, your cellular carrier must provide, and you must subscribe to, these services. Otherwise, selecting or setting them will have no effect. For more information about these services, call your cellular carrier.

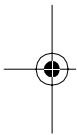

Overview/Receiving Messages

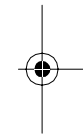

When your phone is turned on and receives calling line ID, voice mail notification, or short message data from your cellular carrier, it alternately displays:

You See	Meaning
xx New	Number (xx) of new messages received
YY Total	Total number (YY) of messages currently stored in the message stack

Your phone stores each message in a special memory area called the "message stack." The message stack can hold up to 20 messages at once, with messages stored in order from newest (memory position 1) to oldest (memory position 20).

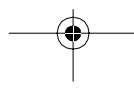



Notes:

- If the message stack is full (20 messages are currently stored) and the phone receives a new message, it automatically stores the new message and deletes the oldest message in the stack.
- Your phone does not receive messages while it is turned off. Contact your cellular carrier to find out how the carrier handles undeliverable/queued messages.

Viewing/Recalling Messages

1. Press and release **(RCL)**, then hold it down for about 1 second. The phone displays the first (newest) message in the stack.

*If the message is a calling line ID message, the phone briefly displays **CID yy** (where yy is the message number) then the number of the party that called (up to 14 digits).*

*If the message is a short (text) message, the phone briefly displays **yy New** (where yy is the message number of a new message) then the message (up to 14 characters).*

If the message is voice mail notification, the phone displays the message data (such as a message number and number of total/new messages waiting) sent by your cellular carrier. The type and format of the message waiting information sent varies by carrier — contact your cellular carrier for more information.

Note: If there are no messages in the stack, the phone displays **No Msgs** for about 8 seconds then exits the message display. To exit sooner, press **(CLR)**.

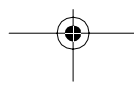
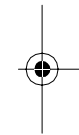
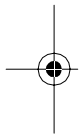



-
2. To view another message, repeatedly press (to scroll backwards) or (to scroll forwards) until that message appears.
 3. When you finish, press **END** to exit the message function.

Deleting Messages

To delete an individual message, recall that message, then hold down until the phone displays **Deleted**.

To delete all messages in the stack, while viewing any message, hold down until the phone displays **Deleted** (briefly) then **Erase All**. Then press again to confirm the deletion.

When you finish, press **END** to exit the message function.

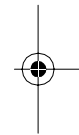
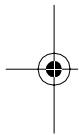

USING THE PHONE WITH HANDSFREE EQUIPMENT

Your phone is preprogrammed to work with most optional handsfree equipment that lets you automatically switch from handset to handsfree mode in your vehicle when you place the phone in the handsfree holder.

Some handsfree equipment might require you to turn off (mute) the phone's microphone when switching to handsfree, using the procedure described in "Using Mute" on Page 18. See the owner's manual provided with your handsfree equipment for more information, or contact your local RadioShack store for assistance.

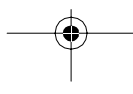

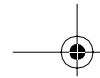

USING THE CALL TIMERS

Your phone has three call timers that let you check the length of your calls (“air time”):

- *Individual call timer* — times each call you make or answer in minutes and seconds, and automatically resets each time you make or answer a call or turn off the phone. See “Displaying the Individual Call Timer.”
- *Resettable call timer* — times the calls you make or answer in minutes, and it can be reset at any time. See “Using the Resettable Call Timer” on Page 54.
- *Cumulative call timer* — times all the calls you make or answer in minutes, and it cannot be reset. See “Displaying the Cumulative Call Timer” on Page 54.

Notes:

- Each call timer begins counting when you hear the first ring (during an outgoing call) or when your phone rings (or vibrates) to signal an incoming call.
- If your phone receives a call but you do not answer it, each timer resets to the time it had before it received that incoming call.

Displaying the Individual Call Timer

The individual call timer tracks each call you make in minutes and seconds, and automatically resets each time you make or answer a call or when you turn off the phone.

To display the individual call timer for the last call, press **(RCL)** **(# >)** **(# >)**. The air time of your last call (such as **00 45** to show 45 seconds) appears for about 15 seconds. Press any key to clear the display sooner.

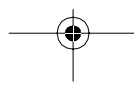
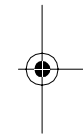
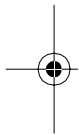

If you press **RCL** **#** **#** during a call, the air time of the call flashes on the display until you clear the display or end the call.

Note: To set your phone so it displays the individual call timer automatically, see "Turning the Automatic Call Timer On/Off" on Page 27.

Using the Resettable Call Timer

The resettable call timer tracks the calls you make or answer in minutes, and it can be reset at any time. You can reset this timer to coincide with your cellular billing statement date, for example, then track your monthly air time.

To display the resettable call timer, press **RCL** **#** **#** **#**. The phone displays **Resetbl** and the number of air time minutes (such as **00215**) accumulated since you last reset the timer. Press any key to clear the timer from the display.

To reset the timer, with the display clear, press **FCN** **OPER 0** **PRS 7** **CLR**.

Displaying the Cumulative Call Timer

The cumulative call timer tracks all the calls you make or answer in minutes. It *cannot* be reset.

To display the cumulative call timer, press **RCL**, **#**, **#**, **#**, **#**. The phone displays **Cumul** and the number of air time minutes (such as **00846**) accumulated since the first call was made or answered on your phone. Press any key to clear the timer from the display.

SELECTING THE ACTIVE PHONE NUMBER

If you subscribe to two cellular services (for example, competitive cellular systems in your area or cellular systems in different cities), your dealer programs your phone with two different phone numbers.

If you have two phone numbers programmed into your phone, the phone displays one of the following messages each time you turn it on, to indicate which cellular system type and phone number are currently active.

Phone Number	Cellular System Type	Display Shows
1	Non-wireline (type A)	A1
2	Non-wireline (type A)	A2
1	Wireline (type B)	B1
2	Wireline (type B)	B2

Note: To set the cellular system type, see “Setting the Cellular System Type” on Page 56.

To deactivate the phone number currently selected and activate the other phone number, press **RCL** **#** **▶** **STO**. The display briefly blanks, then the currently active number appears to confirm your selection. To clear the display when you finish, press **CLR**.

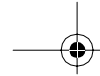

Notes:

- Calls can be made on your phone from only one phone number at a time, and you cannot activate the other phone number while a call is in progress.
- To receive calls on both numbers at the same time (if you subscribe to no-answer transfer or call forwarding service through your cellular carrier), you can set both numbers to forward to the other number if not answered. Otherwise, a caller who calls the inactive number receives the standard “not in service” message.

SETTING THE CELLULAR SYSTEM TYPE

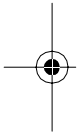

Each cellular market area has two cellular service providers. One of the providers is designated *Provider A* and the other *Provider B*. When your phone is activated for service, find out from your dealer whether your cellular provider is type A or B.

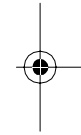
**Notes:**

- Usually, it is less expensive to use the same company for cellular service when you are in your home city and when you roam (see “Roaming” on Page 59). To do this, you need to know whether your cellular service provider is type A or B in your home city and in each city where you plan to travel.
- It is possible for a cellular service provider to be (or have agreements with) Provider A in some cities and Provider B in others.

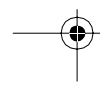
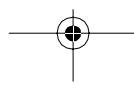

Your phone's selectable system registration function lets you select one of six possible roaming modes:

Roaming Mode Description	Display
<p><i>Standard Mode</i> — the phone first seeks a home type system, then it seeks a non-home type.</p> <p>If you are using a type A (non-wireline) home system</p> <p>If you are using a type B (wireline) home system</p>	<p>Std AB</p> <p>Std BA</p>
<p><i>Invert Preference Mode</i> — the phone first seeks a non-home type system, then it seeks a home type. (Select this setting while on the fringe of your home area or in certain roaming situations.)</p> <p>If your home system is non-wireline (type A):</p> <ul style="list-style-type: none"> • Roam flashes rapidly — call on system B • Roam flashes slowly — call on home type system • InUse flashes slowly — call on home system <p>If your home system is wireline (type B):</p> <ul style="list-style-type: none"> • Roam flashes rapidly — call on system A • Roam flashes slowly — call on home type system • InUse flashes slowly — call on home system 	<p>ScanBA</p> <p>ScanAB</p>
<p><i>Home Only Mode</i> — the phone will not operate outside your home system.</p>	Home
<p><i>Scan A Mode</i> — the phone will operate only within non-wireline (A) systems.</p>	Scan A
<p><i>Scan B Mode</i> — the phone will operate only within wireline (B) systems.</p>	Scan B
<p><i>SID Mode</i> — the phone automatically scans for one or more preferred systems to use <i>and</i> one or more systems <i>not</i> to use. System IDs must be preprogrammed by the dealer; preferred system (SID) feature requires special service (contact your cellular carrier).</p>	P Scan

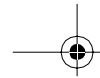

Displaying the Currently Selected System Type

To display the system type currently selected on your phone, press **RCL** **← *** . The currently selected system type (such as **Std BA**) appears for about 8 seconds. To clear the display sooner, press **END**.

Selecting the Cellular System Type

Note: If you are unable to complete Steps 2 and 3 within 8 seconds, the display clears without changing the system type. Start at Step 1 and try again.

1. Press **RCL** **← *** . The currently selected system type appears.
2. Repeatedly press **← *** or **# >** until you see the system type you want to use.
3. To store the displayed system type, press **STO**. The phone briefly displays **Set** to confirm your selection.
To exit without changing the system type, press **END**.

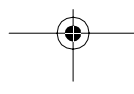
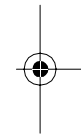
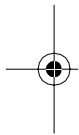

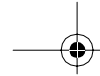

ROAMING

In some areas, the cellular system's computer automatically recognizes roaming telephones. In other areas, you must contact the service provider before it can recognize your phone. The operator needs to know your telephone number, your phone's ESN (Electronic Serial Number), and how you plan to pay for your calls. There is normally an additional charge for roaming calls.

Note: Your phone's ESN is under the phone's battery; however, the roaming cellular service provider can usually automatically determine your phone's ESN when you call.

When you roam, the Roam indicator on your phone flashes slowly when the phone is using a home-type cellular system. The indicator flashes rapidly when the phone is using a cellular system that is different from your home system.

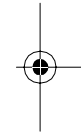
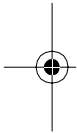

USING CELLULAR SYSTEM PIN DIALING

Your cellular carrier might require that you use a personal identification number (PIN) when you make calls. This number assures the cellular system that the person placing the call is an authorized user.

Contact your cellular service provider to determine if a PIN is required and obtain the PIN (7 digits or less) to place calls through the cellular system you subscribe to. If a PIN is required, follow the steps in "Storing Speed Dial Numbers" on Page 36 to store your PIN in memory 07, then follow the steps in "Enabling/Disabling PIN Dialing" on Page 60 to enable PIN dialing on your phone.

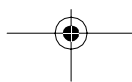



Notes:

- Enable PIN dialing on your phone only if it is required by your cellular provider.
- You must store your PIN in memory 07, otherwise your phone cannot properly make calls through your cellular system.
- If you enter a service area that does not require PIN dialing, disable PIN dialing on your phone.

Enabling/Disabling PIN Dialing

1. Press **FCN** **NAME MENU** to access the functions menu.
2. Repeatedly press **← *** or **# ►** until **PIN InActive** or **Active** flashes.
3. Press **STO** so **Active** appears or **CLR** so **InActiv** appears.
4. Press **END** to exit the functions menu.

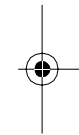
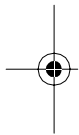

Making a Call Using Your PIN

1. Dial or speed dial the number you want to call, as usual, then press **SND**.
2. When you hear the tones (2 beeps), press **SND** again. The phone automatically sends your PIN code to finish dialing the call.

Note: If you did not store your PIN in memory 07, or you stored an incorrect PIN, **Invalid PIN** appears. Be sure your PIN is correct, then try again.

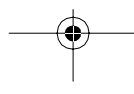

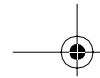

USING TOUCH-TONE SERVICES

To use your cellular phone to control answering machines and special telephone services (such as bank-by-phone or voicemail), simply enter touch-tone commands using your phone's keypad after the service answers (and when prompted).

Note: If the silent scratchpad function is turned on, you must press **(RCL) SND** to send the tones after entering each set of touch-tone commands.

Or, you can store the service's command sequence in a memory location. After the service answers (for each sequence you want to send), simply recall the memory location that contains the command sequence and press **(RCL) SND**.

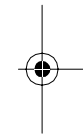
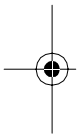

Adding a Pause

Some services, such as voicemail, require you to enter an access code then wait before entering additional digits. To include one or more pauses in a sequence when storing it in memory, press **(FCN) SND** so **Insert Pause** \circ flashes, then press **(STO)**. The phone displays \circ wherever you insert a pause.

Note: If you do not press **(STO)** within 8 seconds, the display clears. Simply press the key for the next digit you want to enter or store. The characters you previously entered appear along with the pause you just entered.

When you send a sequence with pauses stored in it, the phone stops at each place in the sequence where you entered a pause. To send the next group of numbers in the sequence, press **SND** again.

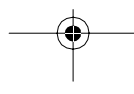

CALLING CARD DIALING

To use your cellular phone to dial long distance numbers with a calling card number, you can simply dial as you usually would (for example, dial 0 and the telephone number then press **SND**, then enter your calling card number when you hear the prompt).

For convenience, your phone lets you store a calling card sequence in memory with your long distance carrier's calling card PIN. When you use this stored sequence to make a call, the phone automatically sends the required calling card information and prompts you to enter the telephone number you want to call.

Storing a Calling Card Sequence

1. If you dial a regular phone number (such as a 1-800 number) to start a calling card call, enter that number, then enter a pause (press **FCN** **SND** **STO**).

Or, if you dial 0 before the telephone number to start a calling card call, press **OPER 0** so 0 appears.

2. Press **FCN** **SND** **#** **▶** so **Insert Num 'N** flashes.
3. Within 8 seconds, press **STO** so **'N** appears after the numbers you previously entered. (**'N** represents the place where the phone will prompt you to enter the area code and number you want to call.)

Note: If you are unable to press **STO** within 8 seconds, the display clears. Press any key to recall the display.

4. Enter another pause.
5. Enter your calling card PIN number.

6. Within 8 seconds, press **STO** then enter the 2-digit memory location number (01–50) where you want to store the card sequence, or press **↵** to automatically select the first unused memory location. **Alpha or STO** appears to prompt you for the next step.

Note: If you are unable to complete this step within 8 seconds, the display goes blank. Press **END** **STO** to recall the display and try again.

7. Enter the name to describe this calling card sequence (**XYZ LONG DIST**, for example), then press **STO**. To proceed without storing a name, simply press **STO**. The phone displays the memory location number you selected to confirm the entry.

Placing a Call Using a Stored Calling Card Sequence

1. Recall the calling card sequence from memory, then press **SND** to dial the call. (Or, if you stored the sequence in any memory from 02–09, simply hold down that number for one-touch dialing.) **Enter Number** appears. This prompts you to enter the area code and phone number you want to call.
2. Enter the area code and phone number you want to call, or recall that number from memory, then press **SND**. The phone begins dialing the call.

Note: When you press the keys, the phone sounds different tones than the ones it normally makes.

3. When you hear the prompt, press **SND** to dial the calling card PIN (or other information you stored in the calling card sequence).

Note: Repeat this step for each sequence you stored.



RESETTING THE PHONE



USING MASTER RESET

Master reset lets you enter the phone's preset security code (**000000**) and reset all of the phone's special functions to their default settings (see "Menu Functions List" on Page 24), but it does *not* clear any information you stored in memory.

Follow these steps to perform master reset.

1. Press **FCN** **OPER 0**.
2. Enter the 6-digit security code *twice*.
3. To reset the phone, press **1** **STO**. The phone displays **Std Setting** (standard setting) and begins to reset.

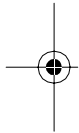

When the phone finishes resetting (when **Std Setting** disappears), you can use it as usual.

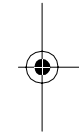

Note: Depending on your phone's settings, the phone might take several minutes to reset.

To exit without performing master reset, press **END**.

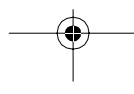

USING MASTER CLEAR

Master clear lets you enter the preset security code (**000000**) to do the following:

- Reset all of the phone's special functions to their default settings (see "Menu Functions List" on Page 24)
- Delete all information stored in memory
- Clear the resettable call timer

Follow these steps to perform master clear.

Caution: *Performing master clear deletes all information stored in memory.*

1. Press **FCN** **OPER 0**.
2. Enter the 6-digit security code *twice*.
3. To clear the phone, press **WXYZ9** **STO**.

When the phone finishes resetting (when **Busy** disappears, for example), you can use it as usual.

Note: Depending on your phone's settings and the amount of information stored in memory, **Busy** might appear, the phone might sound a continuous beep, and it might take several minutes to finish clearing.

To exit without performing master clear, press **END**.



TROUBLESHOOTING



If the phone's power does not come on or stay on:

- Make sure the battery is properly installed and charged.
- Be sure that the contacts on the battery are clean. If they are not, clean them with a soft cloth or pencil eraser.
- The battery charge might be too low for operation. Check the display and listen for the low battery warning tones.

If the power comes on, but the phone does not work:

- Make sure that the antenna is fully extended.
- Be sure you selected the correct cellular system type (see "Setting the Cellular System Type" on Page 56).
- Make sure that functions you might have previously selected (but forgotten) are not causing the phone to operate differently than you expect it to (see "Function Status Quick-Review" on Page 23).
- Check the display for error messages.

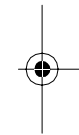
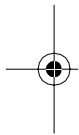

If you see an error message that is not covered in any section in this Owner's Manual, or if your phone does not seem to be operating properly, contact your local RadioShack store for assistance.

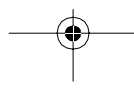

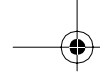

SAFETY INFORMATION



TRAFFIC SAFETY

- Do not use a handheld phone while driving a vehicle. If using a handheld phone, park the vehicle before taking or making a call.
- Always secure the phone in its holder; do not place the phone on the passenger seat or where it can break loose in a collision or sudden stop.
- Never install a phone alert device that operates your vehicle's lights or horn. This is illegal in most areas.

Remember, always put road safety first!

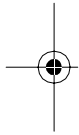

OPERATING ENVIRONMENT

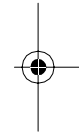

- Remember to follow all special regulations and always turn off your phone whenever you are required to do so, or when it might cause interference or be dangerous.
- Any radio transmitting equipment, including cellular phones, might interfere with inadequately protected medical devices. Consult a physician or the manufacturer of the medical device if you have any questions. Other electronic equipment might also be subject to interference.
- As with other mobile radio transmitting equipment, for your safety, only use your phone in the normal operating position (held to your ear with the antenna pointing over your shoulder).
- Turn off the phone while getting gasoline (at a filling station). Observe restrictions on the use of radio equipment in fuel depots (fuel storage and distribution areas), chemical plants, or around blasting operations.

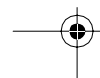



-
- Do not store or carry flammable liquids, gases, or explosive materials in the same compartment as a cellular phone or any of its parts or accessories.
 - Only qualified personnel should install or service the phone in a vehicle. Faulty installation or service might be dangerous and could invalidate the phone's warranty.
 - Electronic fuel injection systems, electronic anti-lock braking systems, electronic cruise control systems, and other electronic systems can malfunction due to the lack of protection from radio signals. Check regularly that all cellular phone equipment in your vehicle is mounted and operating properly.
 - Turn off your cellular phone when in an aircraft. The use of cellular phones in an aircraft might be dangerous to the operation of the aircraft, disrupt cellular networks, and is illegal.

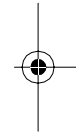
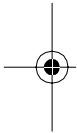

Failure to observe these instructions could lead to suspension or denial of cellular telephone services, legal action, or both.

EMERGENCY CALLS

IMPORTANT! This phone, like any cellular phone, operates using radio signals, cellular, and land-line networks, as well as user-programmed functions. These factors make it impossible to guarantee connection in all conditions. Therefore, you should never rely solely upon any cellular phone for essential communications (such as medical emergencies).

Remember, to make or receive any calls, the phone must be turned on and in a service area with adequate cellular signal strength.

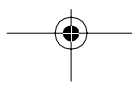

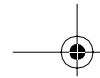

You might not be able to make emergency calls on all cellular phone networks or when certain network services or phone features are set. Check with your local service providers.

FCC REGULATIONS

A cellular phone might cause TV or radio interference, even when it is operating properly. The FCC can require you to stop using your cellular phone if you cannot eliminate the interference. If you need assistance, contact your local RadioShack store.

This device complies with Part 15 of the *FCC Rules*. Operation is subject to the condition that this device does not cause harmful interference.

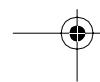
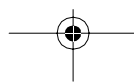
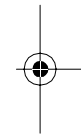
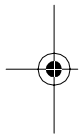



CARE AND MAINTENANCE



Your RadioShack CT-502 Flip-Style Handheld Cellular Telephone with Silent Vibrating Alert is an example of superior design and craftsmanship. The following suggestions will help you care for your phone so you can enjoy it for years.

- Keep the phone and all of its parts and accessories out of the reach of children.
- Keep the phone dry. Liquids might contain minerals that corrode electronic circuits.
- Do not use or store the phone in dusty, dirty areas. Its moving parts can be damaged.
- Do not store the phone in hot areas. Temperature extremes can shorten the life of electronic devices, damage batteries, and warp or melt plastic parts.
- Do not store the phone in cold areas. When the phone warms up (to its normal operating temperature), moisture can form inside the phone, which could damage the phone's electronic circuits.
- Do not drop, knock, or shake the phone. Rough handling can break internal circuit boards.
- Wipe the phone with a damp cloth occasionally to keep it looking new. Do not use harsh chemicals, cleaning solvents, or strong detergents to clean your phone.

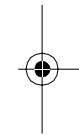
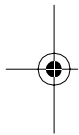

Modifying or tampering with the phone's internal components can cause a malfunction and invalidate your phone's warranty and void your FCC authorization to operate it. If your phone is not performing as it should, take it to your local RadioShack store for assistance.

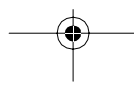

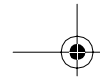

SPECIFICATIONS



Dimensions: 5⁵/₈ × 2³/₈ × 1³/₈ Inches
 Weight (with Supplied Battery): 7.7 oz
 (218 g)
 Transmitting Power: 0.6W + 2dB – 4dB
 Operating Voltage: μ5.2–7.5 DC
 Internal battery:..... 6.0V DC
 Input to AC charger: 110V AC
 Frequency Band: 824–849 MHz (TX)
 869–894 MHz (RX)

Specifications are typical; individual units might vary. Specifications are subject to change and improvement without notice.

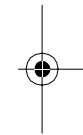
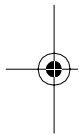

PATENT INFORMATION

This phone is manufactured under one or more of the following U.S. patents.

4121218	4617520	D295975	4965537	D327061	5261119
4124879	D286778	4751737	4972355	5128834	5262710
4127824	4626309	D296187	4972432	D328302	5263052
4128740	4628529	4761621	4972455	5142551	5276707
4138681	4629829	4764737	4975808	5142696	5278994
4193036	4630304	D297734	4984290	5146620	D343173
4254382	4630305	D297735	D314173	5148471	5280637
4302845	4633141	4777564	D315330	5148473	D344087
4312074	4636593	Re32768	D315346	5148961	5287553
4327319	4636741	D299136	D315543	5150359	5287555
4329666	D288432	4797929	D315559	5150384	5287556
4369516	4648125	4798975	D315565	5152006	D344511
4369522	4649543	4800348	5004992	5157693	5301365
4378603	D288683	4802236	D315907	5163159	5321847
4390963	4654655	4809356	5008925	5164652	D348880
D269873	D289156	4811377	D316417	5166596	5349588
4389265	4662691	4811404	D316859	5175759	5359696
4400584	4667333	4827226	5017856	5175874	5361400

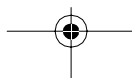



4400585	4668917	4827507	5018188	D332261	5363071
D270835	4670747	4829274	5020091	5182749	5365549
D271491	4672502	4837534	5020092	D332785	D352497
Re31470	4680787	D301476	5020093	5185566	5366826
4431977	4681476	4843621	5028083	5187809	5375143
4434461	4683585	4845772	5028859	5193223	5375258
4455534	4692726	D302015	5029044	5195106	5379324
4462098	4704588	4851966	5029233	5195108	D354055
D275951	D292578	4868576	5031028	5201069	D354062
4484153	4706036	4870686	5036532	5204977	5384825
4485486	D292920	D303656	5053924	5210793	D356084
4486624	4710724	4876552	5057762	5214675	5402447
D276809	4711361	4879533	D320780	5222104	5406146
4491972	4715063	D305427	5059885	5222251	5406562
D277667	4716319	4896124	5060294	D337332	D357224
4504834	4716391	4897873	D322783	5230007	D357457
D278708	4723305	D305717	D322955	5230093	5410741
4523155	D294257	4904549	5081674	5233633	D357680
4546329	4727306	4905288	5083304	5235492	D357681
4550426	4727583	4905301	D324024	5237257	5428836
4551696	4730195	D306293	D324388	5239127	D359734
4564821	4734635	D306441	5095503	5241545	D359735
D282169	4736277	D306594	D325028	5241548	D359959
4571595	4737976	4912602	D325583	5241650	5432017
4573017	4740794	4918732	5109536	5241693	D360632
4574243	4741018	4922178	D325915	5242767	5438684
4585957	4741034	4945570	5113436	D339582	
4602218	4742562	4954796	5117450	5249302	
D284759	D295627	4959851	5121047	5251331	
D285439	4746242	4963812	5122480	D340710	
4616314	D295973	4963843	5122722	5260988	

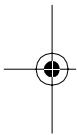

DISPLAY MESSAGE GLOSSARY

Message	Description	See Page(s)
NN'	Memory scrolling is active (where NN is the memory number)	40
o	Shows a pause stored in memory	61
Alpha or STO	Prompts you to press the "alpha" keys or (STO)	36
Auto Ansr	Automatic answer	31
Auto Lock	Automatic lock	46
A1	Two-system operation; non-wire-line system is active, using phone number 1	55
A2	Two-system operation; non-wire-line system is active, using phone number 2	55
B1	Two-system operation; wireline system is active, using phone number 1	55
B2	Two-system operation; wireline system is active, using phone number 2	55
One Min Timr	Call-time reminder tone	26
Busy	Master clear in progress	65
Call	Call now being, or was previously, received	16, 17
Change?	Memory prompt to caution before overwriting previously stored information	36, 42
Clear?	Memory prompt to caution before clearing a memory entry	43
Emergcy	Emergency call in progress (using (1))	19, 33

Message	Description	See Page(s)
NoNames Stored	No names are stored in memory	40
Emergency Call	Emergency dialing display setting (appears with On or Off)	33
Full	Memory is full or the requested memory block is unavailable	36, 42
Home	Home system-type selected	56
Indiv Timer	Automatic timer function	53
Keypad Tone	Keypad tone setting	30
Level (1-6)	Service restriction level	48
LocCode	Appears before lock code	45
Lock?	Appears during manual lock procedure	45
Locked	Phone is locked	45
Low Bat	Battery power is low	11
MultKey Ansr	Multiple key answer	32
Mute	Microphone is turned off	18
Number Pref	Number display preference function	33
on	Appears when display is clear (if signal strength meter is off)	26
PIN Active or Inactiv	PIN dialing function is on or off	60
Redial	Automatic redial in progress	20
Ring Off	Ringer alert off (appears with Vib Off)	29
Ring On	Ringer alert on (appears with Vib On)	29

Message	Description	See Page(s)
Ring Only	Ring only alert type	29
Scan A	Non-wireline A system-type selected	56
Scan AB	A then B scan system-type selected	56
Scan B	Wireline B scan system-type selected	56
Scan BA	B then A scan system-type selected	56
Call Rcv	Call screening function	34
Pref'd SIDs	(System ID) Specific cellular ID required (system-type selected)	56
Signal Mtr	Signal strength meter	14, 26
Std Setting	Appears during master reset procedure	56
Std AB	Standard non-wireline system-type selected	56
Std BA	Standard wireline system-type selected	56
Turbo Dial	One-touch dialing	32
Scrapad Tone	Scratchpad tone	27
Vib Off	Vibration alert off (appears with Ring Off)	29
Vib On	Vibration alert on (appears with Ring On)	29
Vibrate Only	Vibration only alert type	29



Limited One-Year Warranty

This product is warranted by RadioShack against manufacturing defects in material and workmanship under normal use for one (1) year from the date of purchase from RadioShack company-owned stores and authorized RadioShack franchisees and dealers. EXCEPT AS PROVIDED HEREIN, RadioShack MAKES NO EXPRESS WARRANTIES AND ANY IMPLIED WARRANTIES, INCLUDING THOSE OF MERCHANTABILITY AND FITNESS FOR A PARTICULAR PURPOSE, ARE LIMITED IN DURATION TO THE DURATION OF THE WRITTEN LIMITED WARRANTIES CONTAINED HEREIN. EXCEPT AS PROVIDED HEREIN, RadioShack SHALL HAVE NO LIABILITY OR RESPONSIBILITY TO CUSTOMER OR ANY OTHER PERSON OR ENTITY WITH RESPECT TO ANY LIABILITY, LOSS OR DAMAGE CAUSED DIRECTLY OR INDIRECTLY BY USE OR PERFORMANCE OF THE PRODUCT OR ARISING OUT OF ANY BREACH OF THIS WARRANTY, INCLUDING, BUT NOT LIMITED TO, ANY DAMAGES RESULTING FROM INCONVENIENCE, LOSS OF TIME, DATA, PROPERTY, REVENUE, OR PROFIT OR ANY INDIRECT, SPECIAL, INCIDENTAL, OR CONSEQUENTIAL DAMAGES, EVEN IF RadioShack HAS BEEN ADVISED OF THE POSSIBILITY OF SUCH DAMAGES.

Some states do not allow the limitations on how long an implied warranty lasts or the exclusion of incidental or consequential damages, so the above limitations or exclusions may not apply to you.

In the event of a product defect during the warranty period, take the product and the RadioShack sales receipt as proof of purchase date to any RadioShack store. RadioShack will, at its option, unless otherwise provided by law: (a) correct the defect by product repair without charge for parts and labor; (b) replace the product with one of the same or similar design; or (c) refund the purchase price. All replaced parts and products, and products on which a refund is made, become the property of RadioShack. New or reconditioned parts and products may be used in the performance of warranty service. Repaired or replaced parts and products are warranted for the remainder of the original warranty period. You will be charged for repair or replacement of the product made after the expiration of the warranty period.

This warranty does not cover: (a) damage or failure caused by or attributable to acts of God, abuse, accident, misuse, improper or abnormal usage, failure to follow instructions, improper installation or maintenance, alteration, lightning or other incidence of excess voltage or current; (b) any repairs other than those provided by a RadioShack Authorized Service Facility; (c) consumables such as fuses or batteries; (d) cosmetic damage; (e) transportation, shipping or insurance costs; or (f) costs of product removal, installation, set-up service adjustment or reinstallation.

This warranty gives you specific legal rights, and you may also have other rights which vary from state to state.

RadioShack Customer Relations, Dept. W, 100 Throckmorton St., Suite 600,
Fort Worth, TX 76102

We Service What We Sell

3/97

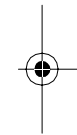
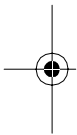

RadioShack
A Division of Tandy Corporation
Fort Worth, Texas 76102

68P09398A53-A
7/28/97 - RGC
Printed in the USA

10/97

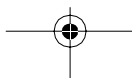

Free Manuals Download Website

<http://myh66.com>

<http://usermanuals.us>

<http://www.somanuals.com>

<http://www.4manuals.cc>

<http://www.manual-lib.com>

<http://www.404manual.com>

<http://www.luxmanual.com>

<http://aubethermostatmanual.com>

Golf course search by state

<http://golfingnear.com>

Email search by domain

<http://emailbydomain.com>

Auto manuals search

<http://auto.somanuals.com>

TV manuals search

<http://tv.somanuals.com>